

# OWNER'S MANUAL

## EDGER

### Model Numbers

**242-595A**  
**24596-A**

**Important:**  
**Read Safety Rules and**  
**Instructions Carefully**

Thank you for purchasing an  
American built product.

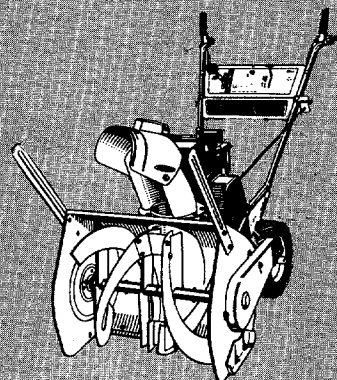
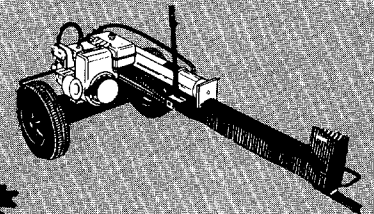
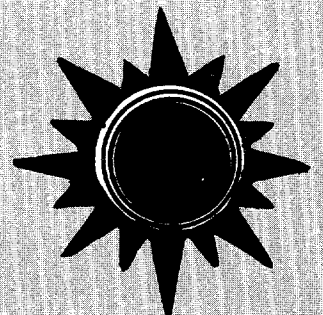
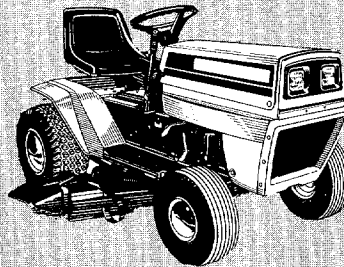
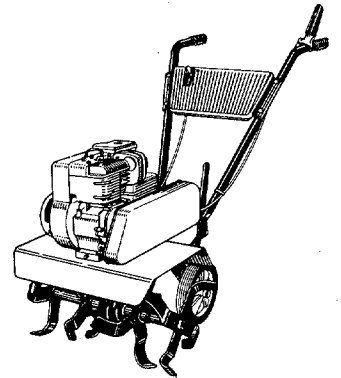

# INDEX

Safe Operation Practices .....	3	Maintenance.....	8
Assembly Instructions .....	4	Off-Season Storage .....	9
Operation.....	7	Illustrated Parts .....	10
Adjustments .....	7	Parts List .....	11
Lubrication .....	8		

## LIMITED WARRANTY

For one year from the date of original retail purchase, MTD PRODUCTS INC will either repair or replace, at its option, free of charge, F.O.B. factory or authorized service firm, any part or parts found to be defective in material or workmanship. Transportation charges for the movement of any power equipment unit or attachment are the responsibility of the purchaser. Transportation charges for any parts submitted for replacement under this warranty must be paid by the purchaser unless such return is requested by MTD PRODUCTS INC.

This warranty will not apply to any part which has become inoperative due to misuse, excessive use, accident, neglect, improper maintenance, alterations, or unless the unit has been operated and maintained in accordance with the instructions furnished. This warranty does not apply to the engine, motor, battery, battery charger or component parts thereof. Please refer to the applicable manufacturer's warranty on these items.

This warranty will not apply where the unit has been used commercially.

Warranty service is available through your local authorized service dealer or distributor. If you do not know the dealer or distributor in your area, please write to the Customer Service Department of MTD.

The return of a complete unit will not be accepted by the factory unless prior written permission has been extended by MTD.

This warranty gives you specific legal rights. You may also have other rights which vary from state to state.



WARNING

### TO PURCHASERS OF INTERNAL COMBUSTION ENGINE EQUIPPED MACHINERY OR DEVICES IN THE STATE OF CALIFORNIA

The equipment which you have just purchased does not have a spark arrester. If this equipment is used on any forest covered land, brush covered land, or grass covered unimproved land in the State of California, before using on such land, the California law requires that a spark arrester be provided. In addition, spark arrester is required by law to be in effective working order. The spark arrester must be attached to the exhaust system and comply with Section 4442 of the California Public Resources Code.

# **IMPORTANT**

It is suggested that this manual be read in its entirety before attempting to assemble or operate. Keep this manual in a safe place for future reference and for ordering replacement parts.

This unit is shipped WITHOUT GASOLINE or OIL. After assembly, see operating section of this manual for proper fuel and engine oil recommendations.

## **SAFE OPERATION PRACTICES FOR EDGERS**

### **TRAINING**

1. Read this Operating and Service Instruction Manual carefully. Be thoroughly familiar with the controls and the proper use of the equipment.
2. Never allow children to operate a power edger.
3. Keep the area of operation clear of all persons, particularly small children and pets.

### **PREPARATION**

Thoroughly inspect the area where the equipment is to be used and remove all stones, sticks, wire, bones and other foreign objects.

2. Do not operate equipment when barefoot or wearing open sandals. Always wear substantial footwear.
3. Check the fuel before starting the engine. Do not fill the gasoline tank indoors, when the engine is running, or while the engine is still hot. Wipe off any spilled gasoline before starting the engine.
4. Disengage the blade clutch on units so equipped before starting the engine.
5. Never attempt to make a wheel adjustment while the engine is running.
6. Never operate the equipment in wet grass. Always be sure of your footing; keep a firm hold on the handle and walk, never run.

### **OPERATION**

Do not change the engine governor settings or overspeed the engine.

2. Do not put hands or feet near or under rotating parts. Keep clear of the discharge opening at all times.

3. Stop the blades(s) when crossing gravel drive, walks or roads.
4. After striking a foreign object, stop the engine, remove the wire from the spark plug, thoroughly inspect the edger for any damage, and repair the damage before restarting and operating the edger.
5. If the equipment should start to vibrate abnormally, stop the engine and check immediately for the cause. Vibration is generally a warning of trouble.
6. Stop the engine whenever you leave the equipment, before cleaning the guard assembly, and when making any repairs or inspections.
7. When cleaning, repairing or inspecting, make certain the blade and all moving parts have stopped. Disconnect the spark plug wire, and keep the wire away from the plug to prevent accidental starting.
8. Do not run the engine indoors.
9. Shut the engine off and wait until the blade comes to a complete stop before unclogging guard assembly.

### **MAINTENANCE AND STORAGE**

1. Check the blade and engine mounting bolts at frequent intervals for proper tightness.
2. Keep all nuts, bolts, and screws tight to be sure the equipment is in safe working condition.
3. Never store the equipment with gasoline in the tank inside of a building where fumes may reach an open flame or spark. Allow the engine to cool before storing in any enclosure.
4. To reduce fire hazard, keep the engine free of grass, leaves, or excessive grease.

# ASSEMBLY

## TOOLS REQUIRED

- (1) Adjustable wrench or 3/4" open end or box wrench
- (2) 7/16" open end or box wrench
- (1) 9/16" open end or box wrench

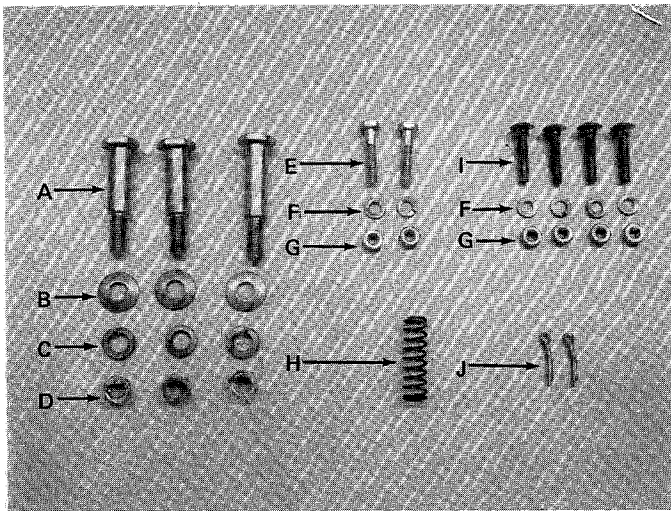

FIGURE 1

## CONTENTS OF HARDWARE PACK (See figure 1)

- A (3) Shoulder Bolts 3/8-16 Thread
- B (3) Belleville Washers
- C (3) Lock Washers
- D (3) Hex Nuts 3/8-16 Thread
- E (2) Hex Bolts 1/4-20 x 1 1/4" Long
- F (6) Lock Washers 1/4" I.D.
- G (6) Hex Nuts 1/4-20 Thread
- H (1) Compression Spring
- I (4) Carriage Bolts 1/4-20 x 1 1/4" Long
- J (2) Cotter Pins

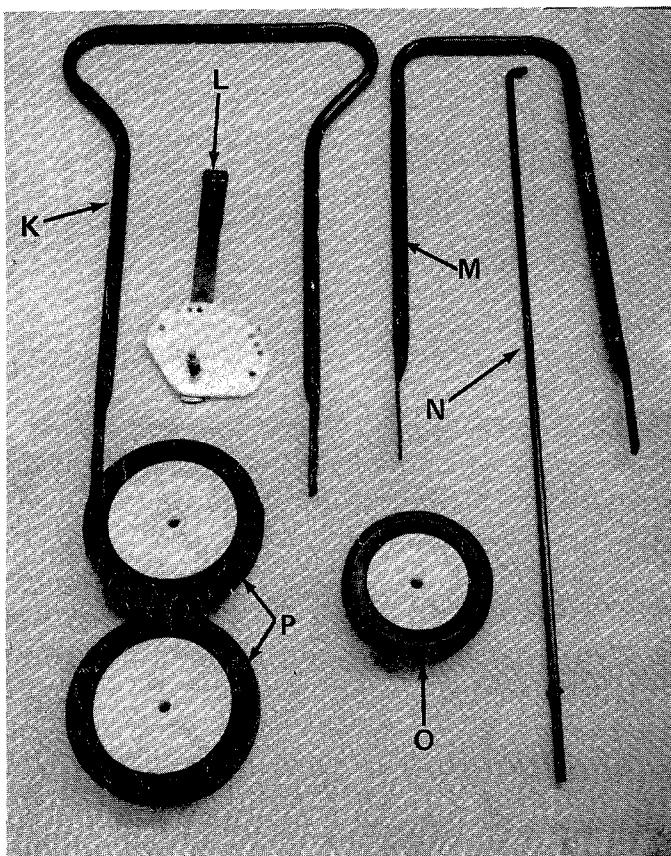

FIGURE 2

## LOOSE PARTS IN CARTON (See figure 2)

- K (1) Upper Handle
- L (1) Preassembled Clutch Plate Assembly
- M (1) Lower Handle
- N (1) Clutch Rod
- O (1) Front Wheel 6" Dia.
- P (2) Rear Wheels 7" Dia.

Your new edger is shipped preassembled with the exception of the handle, rear wheels and front whr

1. Remove the edger and all parts from the carton. Make certain that all loose parts and literature are removed from carton before carton is discarded.

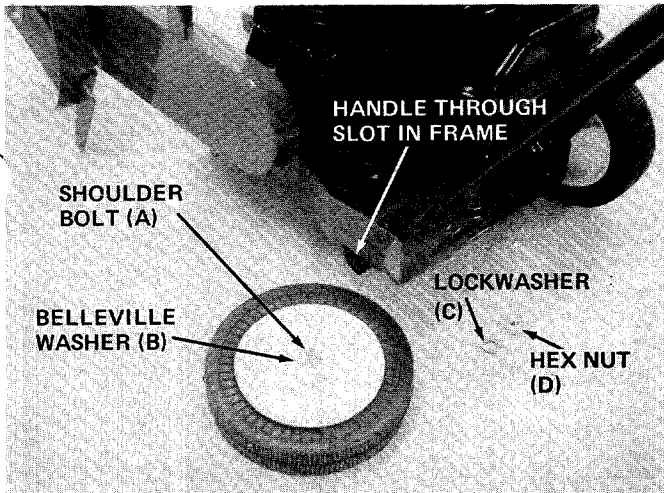

FIGURE 3.

2. Place lower handle into the slots in the rear frame. See figure 3.
3. Line up holes in handle with holes in frame. See figure 3.
4. Secure rear wheels (P) and lower handle (M) to frame with shoulder bolts (A), belleville washers (B), lock washers (C) and hex nuts (D). See figure 3.

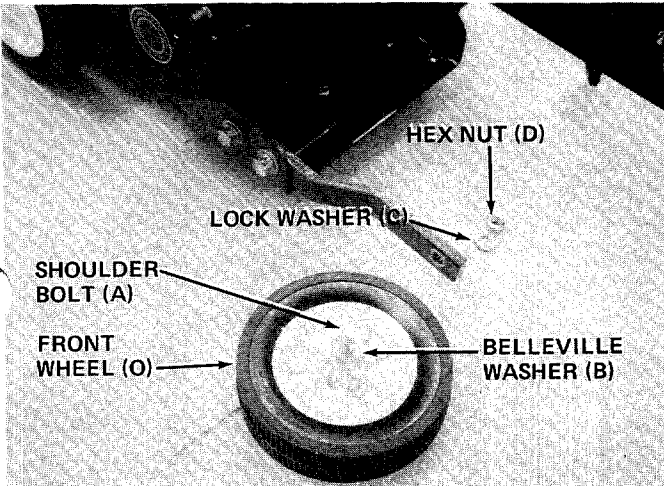

FIGURE 4.

5. Assemble the front wheel (O) as shown in figure 4. Place shoulder bolt (A) through wheel, then belleville washer (B) (between wheel and frame). Secure with lock washer (C) and hex nut (D). See figure 4.

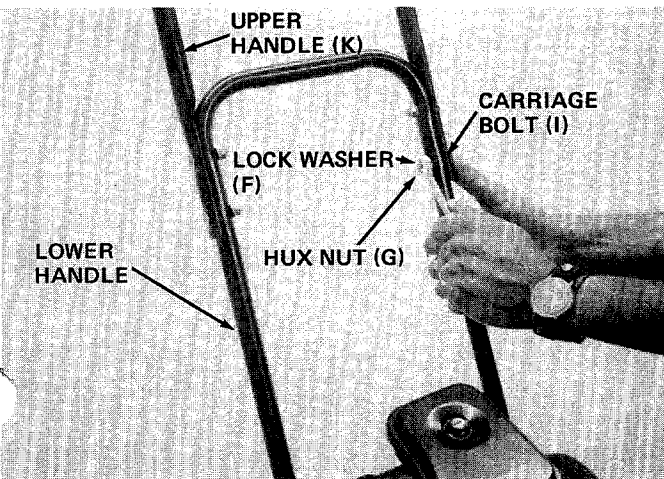

FIGURE 5.

6. Assemble the upper handle (K) to lower handle. Place the head of carriage bolts (I) to the outside of handle. Secure with lock washers (F) and hex nuts (G). See figure 5.

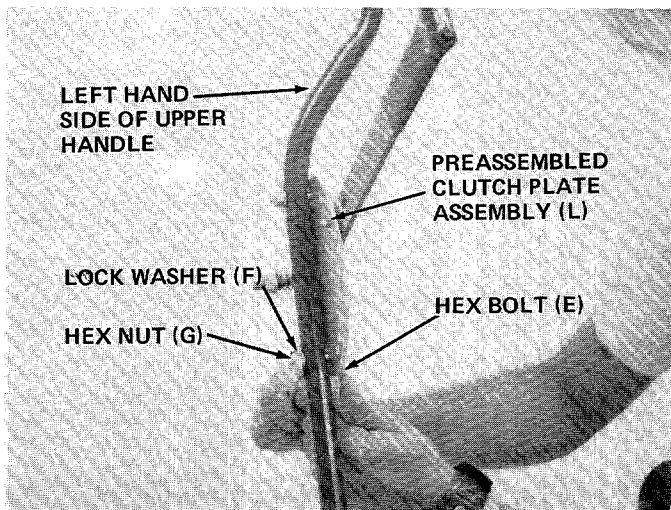

FIGURE 6.



Right and left hand side is determined from behind the edger, in the operator's position.

- Place preassembled clutch plate assembly (L) on the left hand side of upper handle. Secure in place with hex bolts (E), lock washers (F) and hex nuts (G). See figure 6.

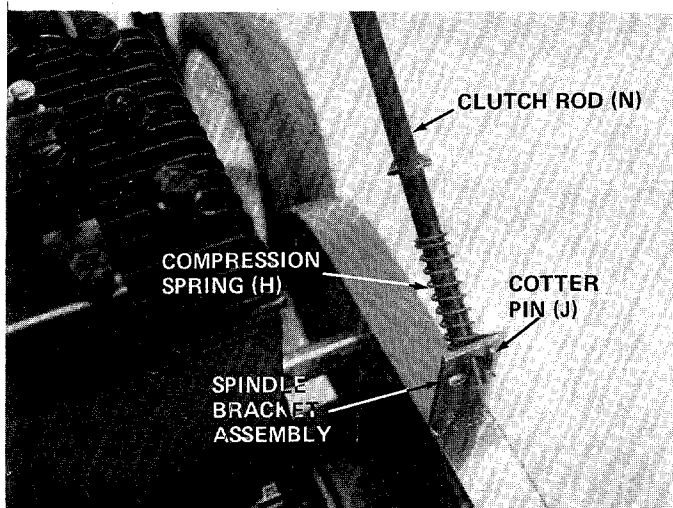

FIGURE 7.

- Place compression spring (H) over straight end of clutch rod (N). Place end of rod in spindle bracket assembly and secure with cotter pin (J). See figure 7.

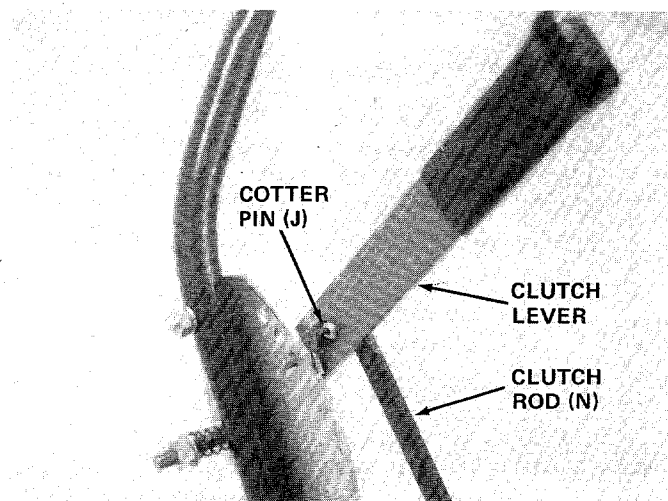

FIGURE 8.

- Place hook end of clutch rod (N) in clutch lever. Secure with cotter pin (J). See figure 8.

## OPERATION

1. Fill the crankcase with oil using a high quality detergent oil classified "For Service MS". Use SAE 30 oil. Nothing should be added to the recommended oil.

Place the engine level. Remove oil fill cap. FILL THE OIL SUMP TO POINT OF OVERFLOW. Pour slowly. See figure 9.

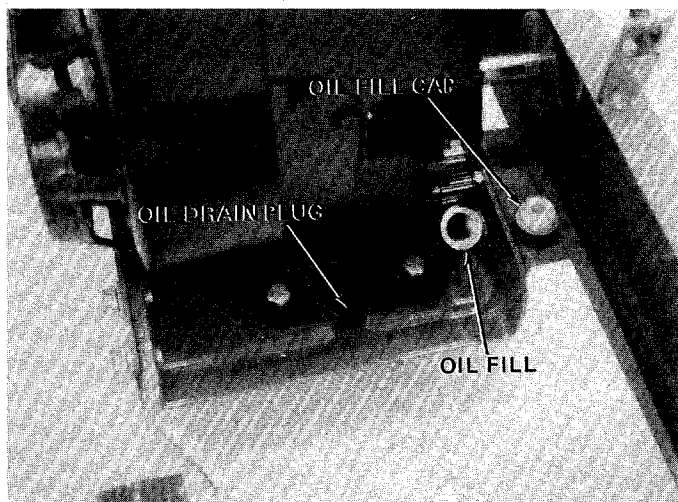

FIGURE 9.

2. Fill the gasoline tank with "regular" gasoline.
3. Pull the choke control out to "choke" position if necessary. See figure 10.

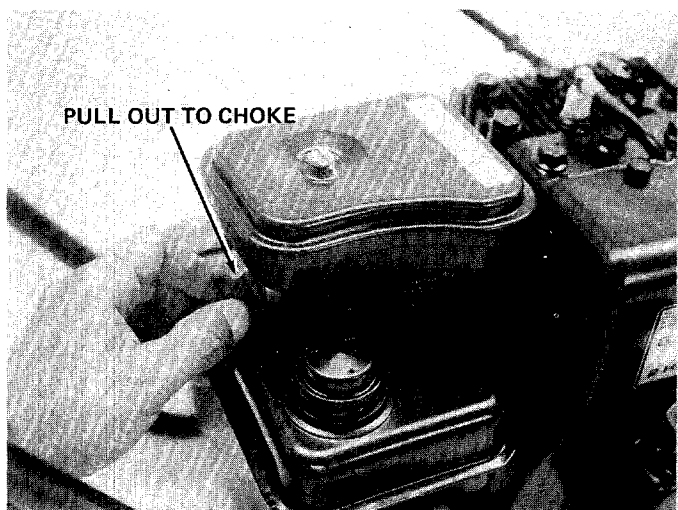

FIGURE 10.

4. Grasp the starter handle and pull out the cord rapidly. Return it slowly to the engine.
5. After engine starts, push choke control in gradually.



## CAUTION

The manufacturer recommends that the operator wear safety glasses or some other suitable eye protection.

To stop the edger engine, push the grounding clip against the spark plug. See figure 11.



FIGURE 11.

**Depth Control Adjustment** - The clutching and declutching of the belt is accomplished by moving the clutch lever. To declutch, pull the clutch lever towards you as you operate the edger. The farther you push the clutch lever forward, the deeper the cut.

## ADJUSTMENTS



## WARNING

Disconnect the spark plug wire and ground against the engine before performing any adjustments, repairs or maintenance.

### Front Wheel Adjustment

The front wheel may be raised or lowered to give added cutting depth.

Loosen the second bolt on the front wheel support bracket. Pivot the bracket up or down to desired height. Retighten bolt. See figure 12.

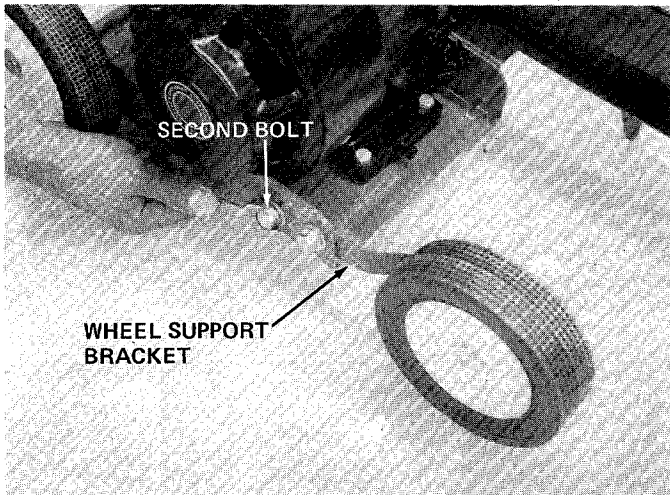

FIGURE 12.

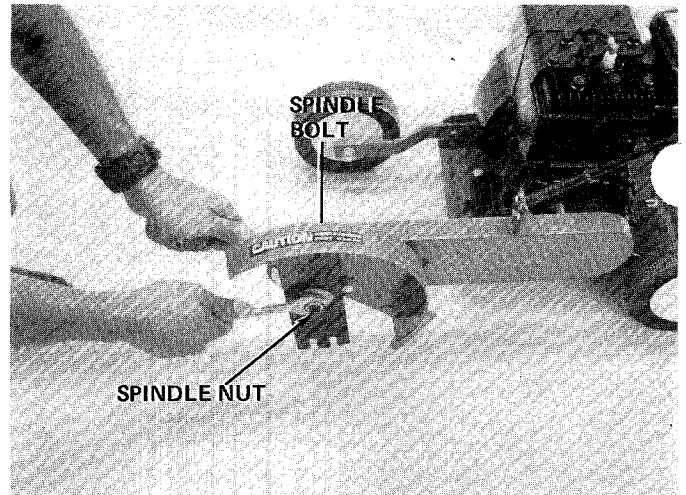

FIGURE 13.

## LUBRICATION

**Engine** - Refer to separate engine manual for lubrication instructions.

**Wheels** - The wheels require no lubrication.

**Spindle Bearing** - The ball bearing in the spindle is lubricated and sealed at the factory and requires no lubrication. Lubricate all other moving parts with engine oil.

## MAINTENANCE



Disconnect the spark plug wire and ground against the engine before performing any adjustments, repairs or maintenance.

**Blade Removal** - Hold head of spindle bolt with a 3/4" or adjustable wrench and remove spindle nut. See figure 13.

**Engine Oil** - Check oil level before starting engine and after every 5 hours of operation. Add oil as necessary to keep level full to point of overflowing. Before removing plug, clean area around plug to prevent dirt from entering oil fill opening.

Change oil after first 5 hours of operation. Thereafter, change every 25 hours. Change oil while engine is warm. Oil may be drained thru oil drain plug. See figure 9. Crankcase capacity - 1 1/4 pints.

**Belt Removal** - Remove the spark plug wire and ground. Remove the gasoline.

1. Tip the edger back so that it rests on the handle.
2. Remove the cotter pin securing the castle nut on the bottom of belt cover. See figure 14.

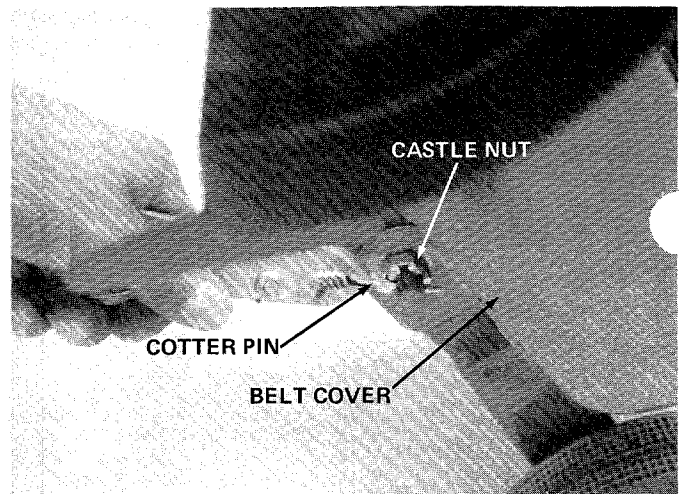

FIGURE 14.

3. Lift off the hex castle nut, belleville washer and belt cover. See figure 15.
4. Remove the old belt and replace with new belt.



While the belt cover is removed, it is a good idea to apply a little grease to the pivot point on belt cover. See figure 15.

5. Reassemble the belt cover, making sure the new belt is over the engine pulley.
6. When tightening the castle nut, only tighten enough to line up hole in bolt for cotter pin. **DO NOT OVER TIGHTEN.** Belt cover must pivot freely. See figure 15.



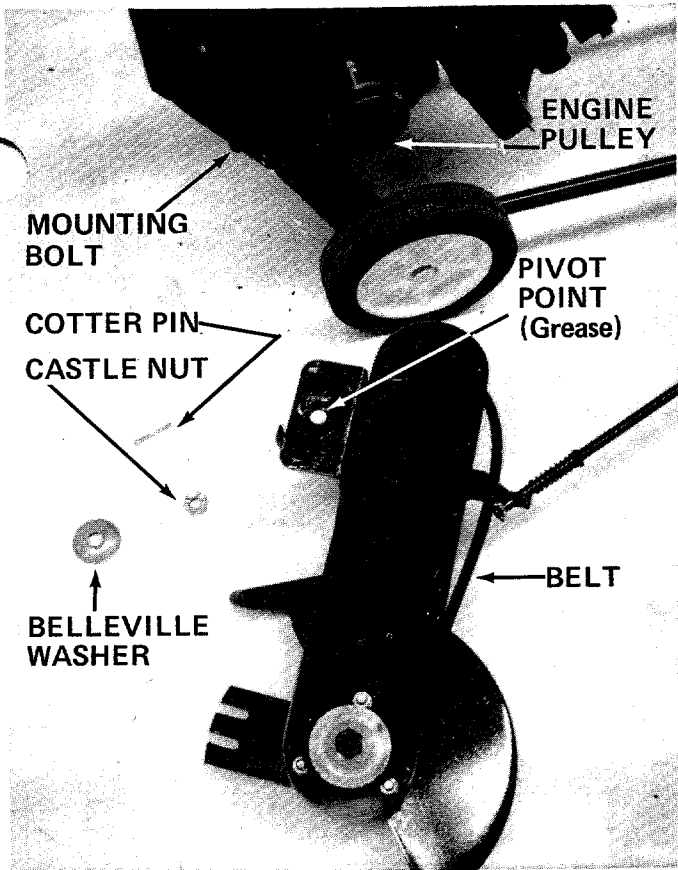

**FIGURE 15.**

Set edger back on its wheels. Replace spark plug wire.

## OFF-SEASON STORAGE

The following steps should be taken to prepare unit for storage.

1. Clean and lubricate unit thoroughly.
2. Refer to engine manual for correct engine storage instructions.
3. Coat unit's cutting blade with chassis grease to prevent rusting.
4. Store unit in a dry, clean area.

# Models 595 and 596

IF YOU WRITE TO US ABOUT THIS ARTICLE  
OR IF YOU ORDER REPLACEMENT PARTS AL-  
WAYS MENTION THIS MODEL & SERIAL NO  
MODEL

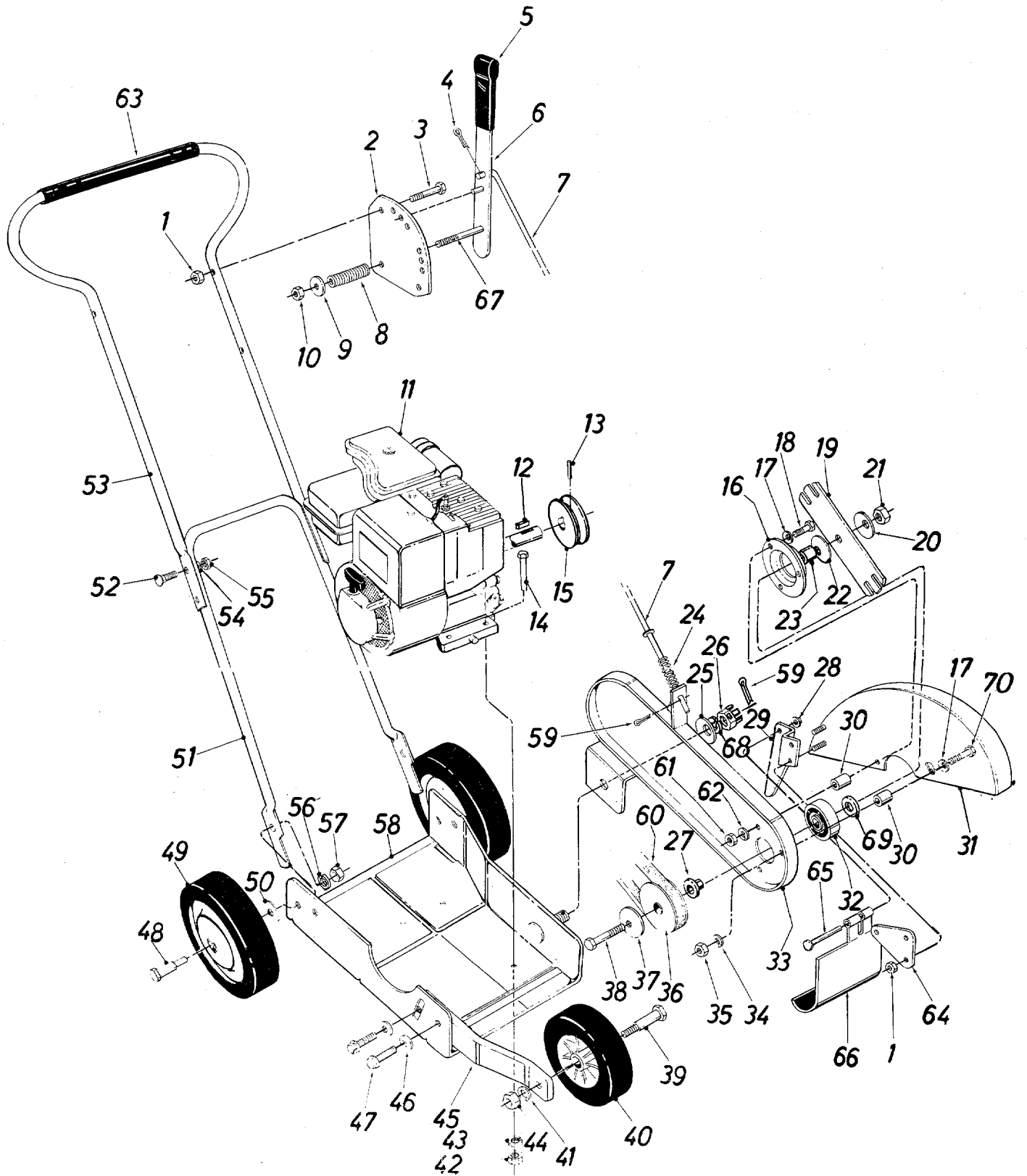

# Models 595 and 596

## PARTS LIST FOR MODELS 595 and 596 EDGERS

Ref. No.	Part No.	Color Code	DESCRIPTION	New Part	Ref. No.	Part No.	Color Code	DESCRIPTION	New Part
1	712-0107		Hex Cent. L.-Nut 1/4-20 Thd.		37	736-0112		Bell.-Wash. .535" I.D. x 1.50"	
2	09950		Clutch Plate					O.D. x .052	
3	710-0106		Hex Bolt 1/4-20 x 1.25" Lg.*		38	710-0515		Hex Bolt 1/2-20 x 3.50" Lg.*	
4	714-0115		Cotter Pin 1/8" Dia. x 1.0" Lg.*		39	738-0213		Shoulder Bolt .498" Dia. x 1.450	
5	720-0142		Grip		40	734-0481		Wheel Ass'y. Comp. 6" Dia. x 1.50	
6	09948		Clutch Handle Ass'y.					L.-Wash. 3/8" I.D.*	
7	747-0358		Clutch Rod		41	736-0169		Hex Nut 5/16-18 Thd.*	
8	732-0171		Compression Spring .50" O.D. x 1.40" Lg.		42	712-0267		L.-Wash. 5/16" I.D.*	
9	736-0264		Fl.-Wash. .33" I.D. x .63" O.D. x .063		43	736-0119		Hex Nut 3/8-16 Thd.*	
10	712-0158		Hex Cent. L.-Nut 5/16-18 Thd.		44	712-0798		Front Wheel Support	
11	-----		Engine		45	13332		Bell.-Wash. .400" I.D. x 88" O.D.	
12	714-0105		Sq.Key 3/16 x 3/16 x 1.0" Lg.*		46	736-0105		Hex Wash. Hd. Self Tap Scr. 3/8-16 x .75" Lg.	
13	710-0938		Set Scr. 1/4-28 x 1/4" Lg.		47	710-0623		Shoulder Bolt .498" Dia. x 1.450	
14	710-0442		Hex Bolt 5/16-18 x 1.50" Lg.*		48	738-0213		Wheel Ass'y. Comp. 7" Dia. x 1.50	
15	711-0421		Engine Pulley		49	734-0480		Bell.-Wash. .400" I.D. x 88" O.D.	
16	08253		Bearing Housing		50	736-0105		Lower Handle	
17	736-0242		Bell.-Wash. .34" I.D. x 88" O.D. x .060		51	749-0452	453	Carriage Bolt 1/4-20 x 1.25" Lg.*	
18	710-0528		Hex Bolt 5/16-18 x 1.25" Lg.*		52	710-0111		Upper Handle	
19	09954		Blade		53	749-0453	452	L.-Wash. 1/4" I.D.*	
20	736-0112		Bell.-Wash. .535" I.D. x 1.50" O.D. x .052		54	736-0329		Hex Nut 1/4-20 Thd.*	
21	712-0239		Hex Cent. L.-Nut 1/2-20 Thd.		55	712-0287		L.-Wash. 3/8" I.D.*	
22	736-0112		Bell.-Wash. .535" I.D. x 1.50" O.D. x .052		56	736-0169		Hex Nut 3/8-16 Thd.*	
23	748-0190		Spacer .513" I.D. x .703" O.D. x .69" Lg.		57	712-0798		Base Ass'y.	
24	732-0330		Compression Spring .57" O.D. x 1.92" Lg.		58	13330 --- 497		Cotter Pin 1/8" Dia. x 1.0" Lg.*	
25	736-0112		Bell.-Wash. .535" I.D. x 1.50" O.D. x .052		59	714-0115		3V-Belt 31.2" Lg.	
26	712-0114		Hex Castle Nut 1/2-20 Thd.		60	754-0142		Hex Nut 5/16-18 Thd.*	
27	711-0716		Shoulder Spacer		61	712-0267		L.-Wash. 5/16" I.D.*	
28	726-0111		Push Cap		62	736-0119		Grip (Optional)	
29	09952		Guide		63	718-0144		Flap Bracket	
30	748-0298		Spacer .354" I.D. x .635" O.D. x .510" Lg.		64	14427		Hinge Pin	
31	14341 --- 497		Blade Guard		65	711-0720		Debris Deflector	
32	741-0919		Ball Bearing .787" I.D. x 4.85" O.D. x .551		66	731-0532		Hex Bolt 5/16-18 x 1.75" Lg.*	
33	13333 --- 497		Spindle Bracket Ass'y.		67	710-0380		Fl.-Wash. .53 I.D. x .93 O.D. x .090	
34	736-0119		L.-Wash. 5/16" I.D.*		68	736-0192		Fl.-Wash. .51 I.D. x 1.00 O.D. x .060	
35	712-0267		Hex Nut 5/16-18 Thd.		69	736-0272		Hex Bolt 5/16-18 x 2.00" Lg.*	
36	756-0361		Pulley		70	710-0116			

\*For faster service obtain standard nuts, bolts and washers locally. If these items cannot be obtained locally, order by part number and size as shown or parts list.

The engine is not under warranty by the edger manufacturer. If repairs or service is needed on the engine, please contact your nearest authorized engine service outlet. Check the "Yellow Pages" of your telephone book under "Engines — Gasoline."



**MTD PRODUCTS INC ..... YARD-MAN COMPANY**

**P.O. BOX 36900 • CLEVELAND OHIO 44136**

## Free Manuals Download Website

<http://myh66.com>

<http://usermanuals.us>

<http://www.somanuals.com>

<http://www.4manuals.cc>

<http://www.manual-lib.com>

<http://www.404manual.com>

<http://www.luxmanual.com>

<http://aubethermostatmanual.com>

Golf course search by state

<http://golfingnear.com>

Email search by domain

<http://emailbydomain.com>

Auto manuals search

<http://auto.somanuals.com>

TV manuals search

<http://tv.somanuals.com>