

.50

# OWNER'S GUIDE

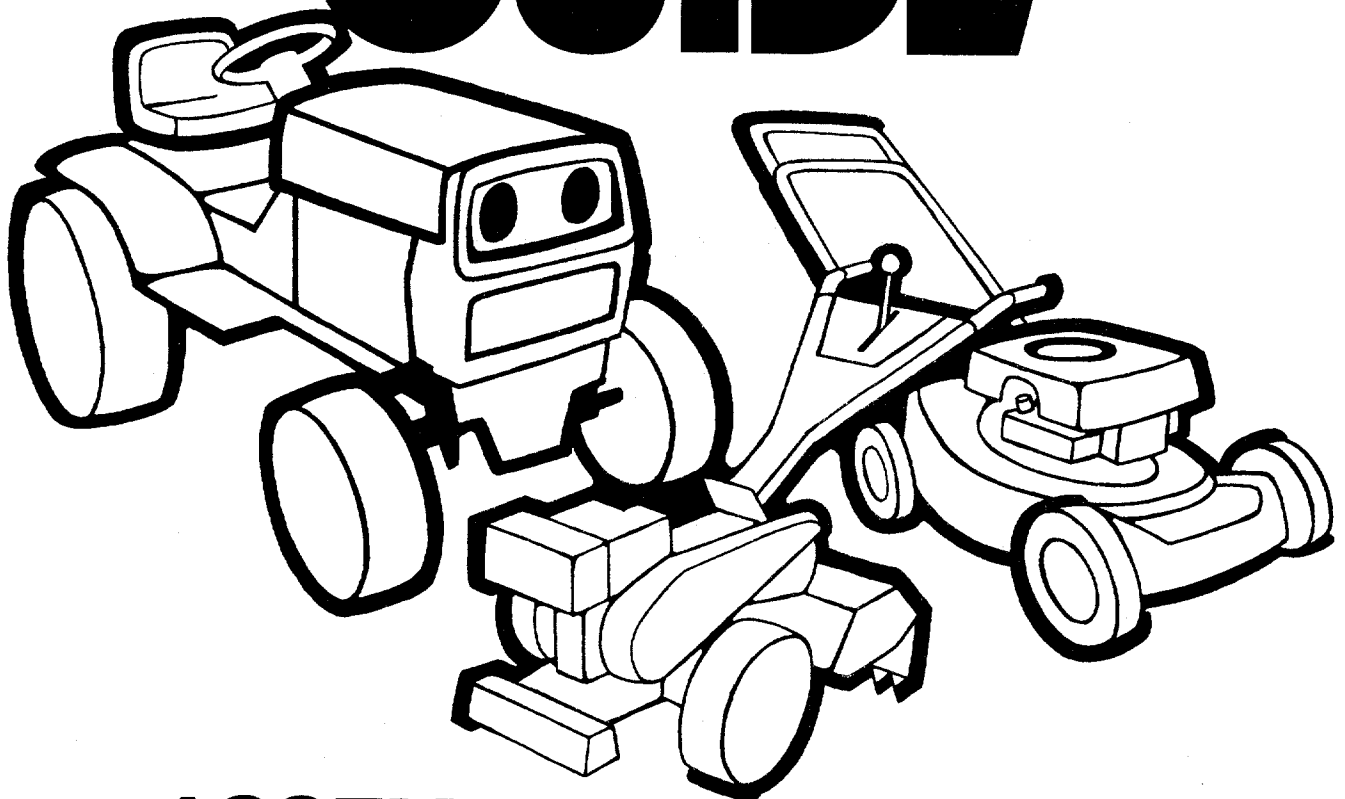

**ASSEMBLY  
OPERATION  
MAINTENANCE  
PARTS LIST**

**IMPORTANT:  
Read Safety Rules  
and Instructions**

**MODEL NUMBERS**

**110-152A**

**110-162A**

**20" & 22"  
ROTARY  
MOWERS**

# INDEX

Safe Operation Practices.....	3	Using Your Rotary Mower.....	9
Assembly Instructions.....	4	Off-Season Storage.....	9
Operation Instructions.....	6	Exploded Parts View.....	12
Adjustments.....	6	Repair Parts List.....	13
Lubrication.....	7	Parts Information.....	Back Cover
Maintenance.....	8		

## LIMITED WARRANTY

For one year from the date of original retail purchase, MTD PRODUCTS INC will either repair or replace, at its option, free of charge, F.O.B. factory or authorized service firm, any part or parts found to be defective in material or workmanship. Transportation charges for any parts submitted for replacement under this warranty must be paid by the purchaser unless such return is requested by MTD PRODUCTS INC.

This warranty will not apply to any part which has become inoperative due to misuse, excessive use, accident, neglect, improper maintenance, alterations, or unless the unit has been operated and maintained in accordance with the instructions furnished. This warranty does not apply to the engine, motor, battery, battery charger or component parts thereof. Please refer to the applicable manufacturer's warranty on these items.

This warranty will not apply where the unit has been used commercially.

Warranty service is available through your local authorized service dealer or distributor. If you do not know the dealer or distributor in your area, please write to the Customer Service Department of MTD.

The return of a complete unit will not be accepted by the factory unless prior written permission has been extended by MTD.

This warranty gives you specific legal rights. You may also have other rights which vary from state to state.

### WARNING TO PURCHASERS OF INTERNAL COMBUSTION ENGINE EQUIPPED MACHINERY OR DEVICES IN THE STATE OF CALIFORNIA

The equipment which you have just purchased does not have a spark arrester. If this equipment is used on any forest covered land, brush covered land, or grass covered unimproved land in the State of California, before using on such land, the California law requires that a spark arrester be provided. In addition, spark arrester is required by law to be in effective working order. The spark arrester must be attached to the exhaust system and comply with Section 4442 of the California Public Resources Code.

# IMPORTANT

It is suggested that this manual be read in its entirety before attempting to assemble or operate. Keep this manual in a safe place for future reference and for ordering replacement parts.

This unit is shipped WITHOUT GASOLINE or OIL. After assembly, see operating section of this manual for proper fuel and amount.

Your rotary mower is a precision piece of power equipment, not a plaything. Therefore exercise extreme caution at all times.

## SAFE OPERATION PRACTICES FOR WALK-BEHIND MOWERS

### TRAINING

1. Read the Operating and Service Owner's Manual carefully. Be thoroughly familiar with the controls and the proper use of the equipment.
2. Never allow children to operate a power mower. Only persons well acquainted with these rules of safe operation should be allowed to use your mower.
3. Keep the area of operation clear of all persons, particularly small children and pets. Stop engine when they are in the vicinity of your mower. Although the area of operation should be completely cleared of foreign objects, a small object may have been overlooked and could be accidentally thrown by the mower in any direction.

### PREPARATION

1. Thoroughly inspect the area where the equipment is to be used and remove all stones, sticks, wire, bones and other foreign objects which could be picked up and thrown by the mower in any direction.
2. Do not operate equipment when barefoot or wearing open sandals. Always wear substantial footwear.
3. Do not wear loose fitting clothing that could get caught on the mower.
4. Check the fuel before starting the engine. Do not fill the gasoline tank indoors, when the engine is running, or while the engine is still hot. Wipe off any spilled gasoline before starting the engine.
5. Disengage the self-propelled mechanism or drive clutch on units so equipped before starting the engine.
6. Never attempt to make a wheel or cutting height adjustment while the engine is running.
7. Mow only in daylight or in good artificial light.
8. Never operate the equipment in wet grass. Always be sure of your footing; keep a firm hold on the handle and walk, never run.

### OPERATION

1. Do not change the engine governor settings or overspeed the engine. Excessive engine speeds are dangerous.
2. Do not put hands or feet near or under rotating parts. Keep clear of the discharge opening at all times.
3. Stop the blade(s) when crossing gravel drive, walks or roads.
4. After striking a foreign object, stop the engine, remove the wire from the spark plug,

thoroughly inspect the mower for any damage, and repair the damage before restarting and operating the mower.

5. If the equipment should start to vibrate abnormally, stop the engine and check immediately for the cause. Vibration is generally a warning of trouble.
6. Stop the engine whenever you leave the mower, before cleaning the mower housing, and when making any repairs or inspections.
7. When cleaning, repairing or inspecting, make certain the blade and all moving parts have stopped. Disconnect the spark plug wire, and keep the wire away from the plug to prevent accidental starting.
8. Before attempting to unclog the mower or discharge chute, stop the engine and be sure the blade(s) have stopped completely. Disconnect the spark plug wire and keep the wire away from the plug to prevent accidental starting.
9. Do not run the engine indoors.
10. Shut the engine off and wait until the blade comes to a complete stop before removing the grass catcher or unclogging chute.
11. Mow across the face of slopes, never up-and-down. Exercise extreme caution when changing direction on slopes. Do not mow excessively steep slopes.
12. Always disconnect electric mowers (line operated) before cleaning, repairing or adjusting.
13. Never operate mower without proper guards, plates or other safety protective devices in place.
14. Keep washout ports and other mower-housing service openings closed when mowing.

### MAINTENANCE AND STORAGE

1. Check the blade and engine mounting bolts at frequent intervals for proper tightness.
2. Keep all nuts, bolts, and screws tight to be sure the equipment is in safe working condition.
3. Never store the equipment with gasoline in the tank inside of a building where fumes may reach an open flame or spark. Allow the engine to cool before storing in any enclosure.
4. To reduce fire hazard, keep the engine free of grass, leaves, or excessive grease.
5. Check the grass catcher bag frequently for wear or deterioration. For safety protection replace only with new bag meeting original equipment specifications.

# ASSEMBLY INSTRUCTIONS

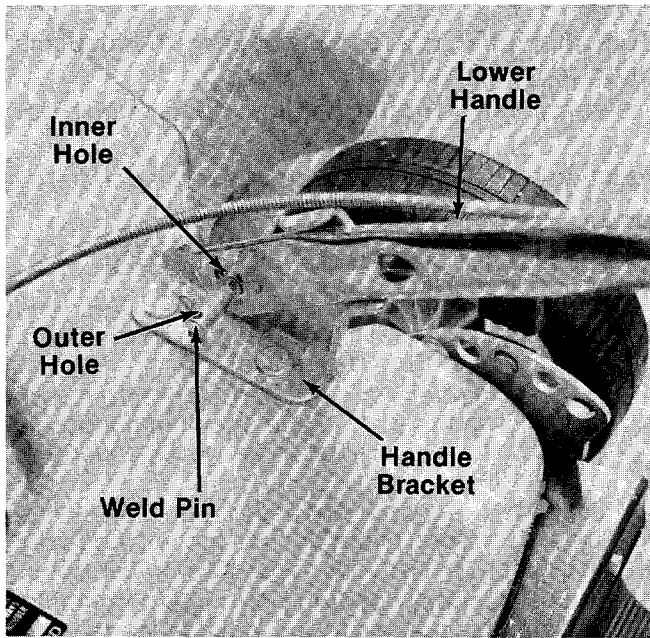

FIGURE 1.

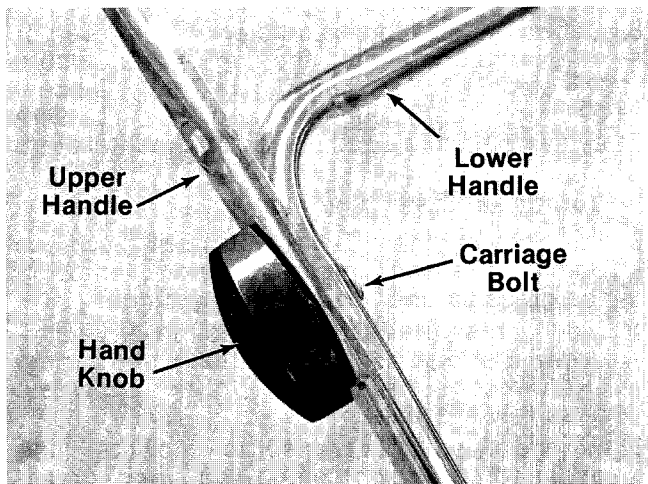

FIGURE 2.

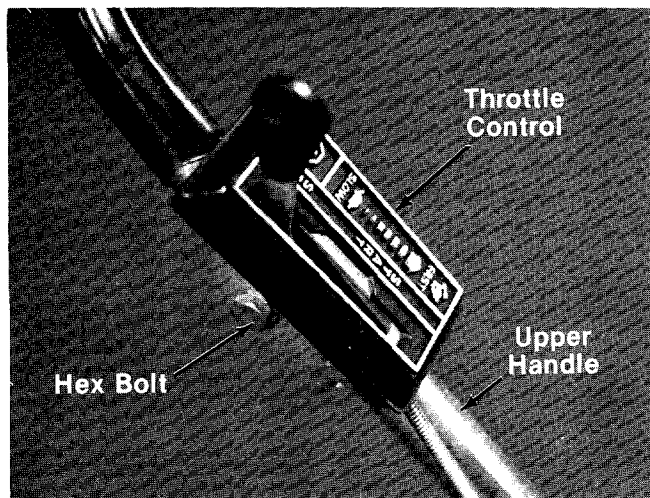

FIGURE 3.

1. Extend throttle control which is attached to the engine at the rear of the mower and place on the floor. Be careful not to bend or kink control wire.
2. Fasten lower handle in position over weld pins in handle mount brackets on deck. ← Secure with hairpin cotters in inner hole on weld pin. See figure 1.

**NOTE**

There are two (2) holes in the handle mount brackets. Place the lower handle against the brackets and secure with hairpin cotter in the inner hole. Inner hole is for operation. Outer hole is for storage.

**NOTE**

It may be necessary to pull open the ends of the lower handle. This will insure a tight fit when assembled into handle mount brackets.

3. Assemble upper handle to lower handle. ← Secure with two carriage bolts and hand knobs as shown in figure 2. The knobs may be assembled either to the inside or the outside of the handle.

**NOTE**

There are two height positions for the handle. See adjustment section.

4. Place the throttle control in position on right side of upper handle. ← Secure with hex bolt and lock nut. See figure 3.

**NOTE**

Reference to right and left hand sides of the unit is observed from the operating position.

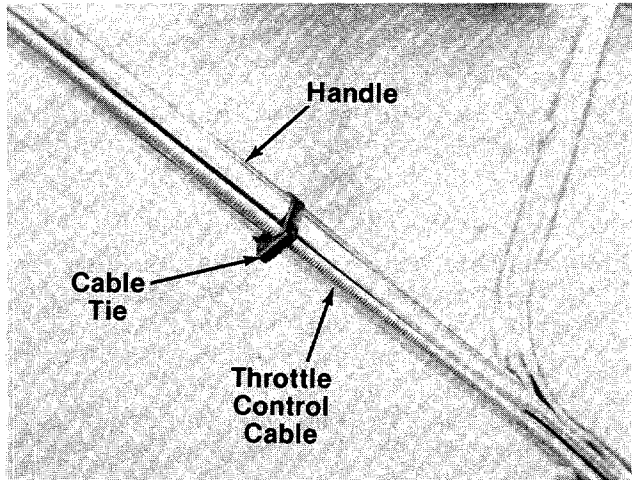

**FIGURE 4.**

- ← 5. Secure throttle control cable to handle with ties provided. See figure 4.
6. Check ALL nuts and bolts for correct tightness.

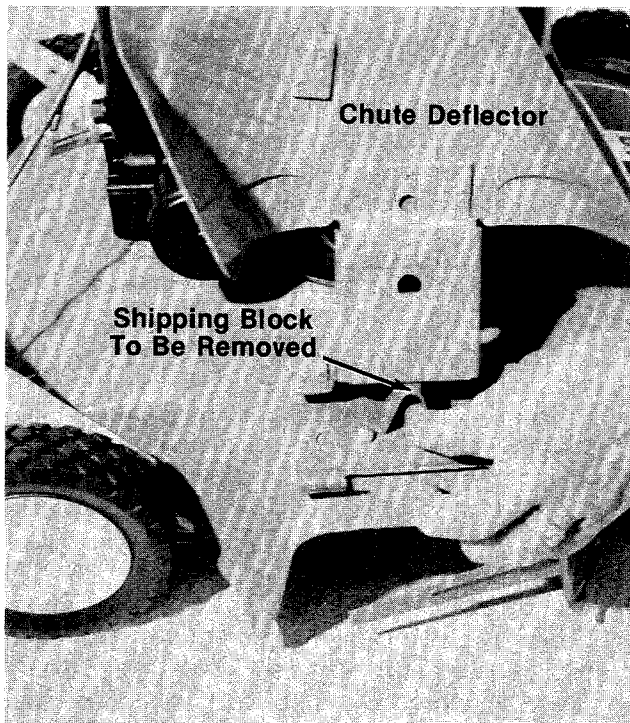

**FIGURE 5.**



**CAUTION**

← Please note that the chute deflector on your mower is in an upright position. It is held in that position by a shipping block. This block is used for shipping purposes only. It must be removed and discarded before your mower is put into operation. See figure 5.

## OPERATION



**CAUTION**  
**DO NOT OPERATE  
MOWER UNLESS  
GUARD OR ENTIRE  
GRASS CATCHER IS  
IN ITS PROPER PLACE.**



FIGURE 6.

Keep hands and feet away from the chute area on cutting deck. See figure 6.



### NOTE

For shipping purposes your mower is set with the wheels in a low cutting height position. For best results raise the cutting position until it is determined which height is best for your lawn. See adjustment section.

1. **FILL SUMP WITH OIL**—Use a high quality detergent oil classified “For Service SC, SD, SE or MS”. Nothing should be added to the recommended oil.

**SUMMER**  
(Above 40° F.)  
Use SAE 30  
If not available,  
Use SAE 10W-30  
or  
SAE 10W-40

**WINTER**  
(Under 40° F.)  
Use SAE 5W-20 or SAE 5W-30  
If not available,  
Use SAE 10W or SAE 10W-30

**DIRECTIONS:** Place the engine level. Remove oil filler plug. FILL THE OIL SUMP TO POINT OF OVERFLOW. Pour slowly. Capacity 1¼ pints.

2. **FILL FUEL TANK**—Use clean, fresh, lead-free or leaded “regular” grade automotive gasoline. Fill tank completely!

DO NOT MIX OIL WITH GASOLINE.

3. When ready to start engine, place throttle control lever on handle in “START” position and start engine in accordance with instructions in engine manual. After engine starts, move throttle control lever on handle to desired engine speed. The engine is stopped by placing control lever on handle in the “STOP” position.
4. Be sure that lawn is clear of stones, sticks, wire, or other objects which could damage lawn mower or engine. For best results and to insure more even grass distribution, do not mow when lawn is excessively wet.



### IMPORTANT

After striking a foreign object, stop the engine. Remove wire from spark plug, thoroughly inspect the mower for any damage, and repair the damage before restarting and operating the mower.

## ADJUSTMENTS



### CAUTION

Do not at any time make any adjustment to lawn mower without first stopping engine and disconnecting spark plug wire.

### EASY CUTTING HEIGHT

An adjusting plate and thumb lever at each wheel position provides cutting height adjustment. Each adjusting plate has five holes. Height of cut will be changed when the thumb lever is moved from one hole to another. Simply depress thumb lever towards wheel and move wheel and lever assembly to desired position. All wheels must be positioned in relative height of cut positions.

### HANDLE POSITION

The upper handle can be adjusted to a high or low position. The operator of the lawn mower can easily adjust the handle position by unscrewing the two knobs, removing the two bolts and reassembling in the other position. No tools are necessary to make this adjustment. See figure 7.

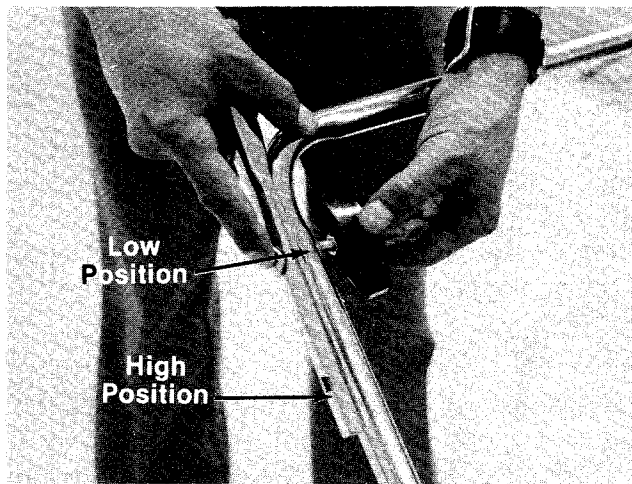

**FIGURE 7.**  
**THROTTLE**

If adjustment becomes necessary, the throttle control wire assembly can be reset as follows:

1. Loosen, but do not remove, screw securing throttle control wire assembly at engine. See figure 8.
2. Move throttle control lever on handle to "FAST" position.
3. Move lever, to which control wire is fastened at engine, to full open position and retighten screw to secure throttle control wire assembly.

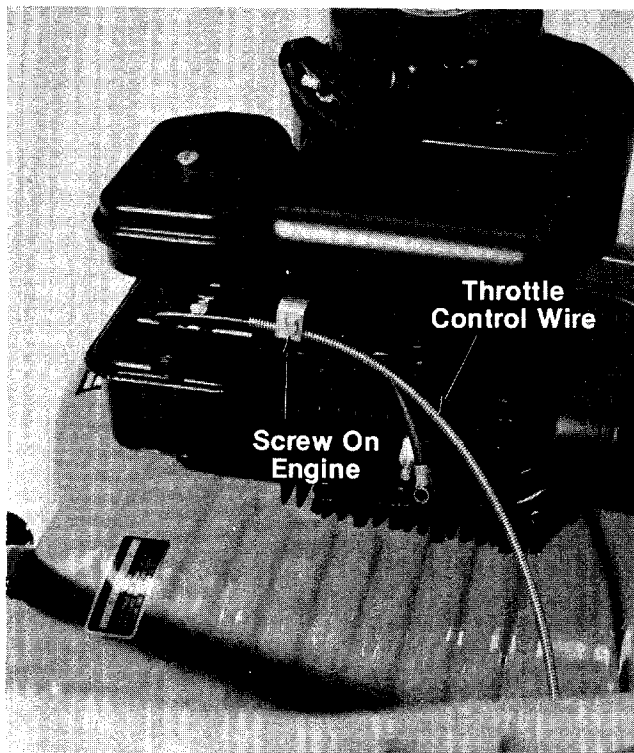

**FIGURE 8.**



If any adjustments are made to the engine while the engine is running (e.g. carburetor), disengage all clutches and blades. Keep clear of all moving parts. Be careful of heated surfaces and muffler.

### **CARBURETOR ADJUSTMENTS (See figure 9.)**

Minor carburetor adjustment may be required to compensate for differences in fuel, temperature, altitude and load.

All carburetor adjustments should be made with the air cleaner on engine. Air cleaner mounting screw must be in carburetor when engine is run. Best adjustment is made with a fuel tank half full of gasoline.

To Adjust Carburetor:

1. Start engine and run long enough to warm it to operating temperature. If engine is out of adjustment so that it will not start, close the needle valve by turning it clockwise. Then open needle valve 1½ turns counterclockwise.
2. Move engine control to run engine at normal operating speed.
  - a. Turn needle valve in clockwise until engine starts to lose speed (lean mixture).
  - b. Then slowly turn needle valve out counterclockwise past the point of smoothest operation until engine just begins to run unevenly (rich mixture).
  - c. Turn needle valve back in clockwise very slowly till engine runs evenly.
  - d. Final adjustment of the needle valve should be slightly to the rich side (turn counterclockwise) of the mid-point.
3. Move engine control to "SLOW." Turn idle adjusting screw until a fast idle is obtained—1750 R.P.M.).
4. To check adjustment move engine control from "SLOW" to "FAST" speed. Engine should accelerate smoothly. If engine tends to stall or die out increase idle speed or re-adjust carburetor, usually to a slightly richer mixture.



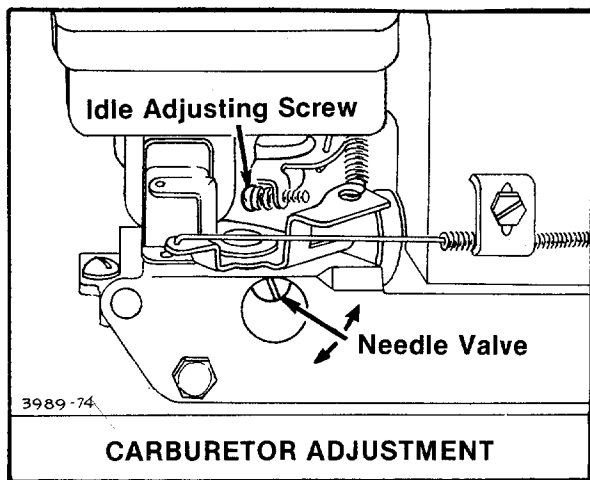

FIGURE 9.

## LUBRICATION



Always stop engine and disconnect spark plug wire before cleaning, lubricating or doing any kind of work on lawn mower.

**Wheels**—Wheel bearings are of self-lubricating Fortiflex. They require no lubrication. If your unit is provided with optional ball bearing wheels, lubricate at least once a season with light oil.

**Protective Shield**—The pivot points on the protective shield should be lubricated periodically with light oil to prevent any rust or binding.

**Chute Deflector**—The torsion spring and pivot point should be lubricated periodically with light oil to prevent any rust or binding. Deflector must work freely.

**Engine**—Follow engine manual for lubrication instructions.

**Throttle**—Periodically lubricate throttle control lever and throttle wire assembly with a few drops of light oil (SAE No. 10 or 20) for ease of operation.

## MAINTENANCE

### CUTTING BLADE

The blade may easily be removed for grinding or replacement as follows:

1. Remove bolt and lock washer holding blade and blade adapter to engine crankshaft.
2. Remove blade and blade adapter from engine crankshaft.
3. Remove two bolts, lock washers and nuts holding blade to blade adapter (if necessary).

When sharpening blade, follow the original angle of grind as a guide. It is extremely important that each cutting edge receives an equal amount of grinding to prevent an unbalanced blade. An unbalanced blade will cause excessive vibration when rotating at high speeds and may cause damage to the mower.

To insure safe operation of your unit, ALL nuts and bolts must be checked periodically for correct tightness.

### DECK

The underside of mower deck should be cleaned after each period of use as grass clippings, leaves, dirt and other matter will accumulate. This accumulation of grass clippings, etc., is undesirable as it will invite rust and corrosion and may cause an uneven discharge of grass clippings at the next cutting.

The deck may be cleaned by tilting the mower forward or on its side and scraping clean with a suitable tool or by washing with a stream of water from a garden hose.



### CAUTION

Do not direct the stream of water at a hot engine as damage to the engine may result.

### ENGINE OIL

**CHECK OIL LEVEL** before starting engine and after every 5 hours of operation.

ADD oil as necessary to keep level FULL TO POINT OF OVERFLOWING.

Before removing oil fill plug, clean area around plug to prevent dirt from entering oil fill hole.

Engine should be in a level position when checking oil.

**CHANGE OIL** after first 5 hours of operation. Thereafter change every 25 hours. Change oil while engine is warm. Oil may be drained thru drain on bottom of engine. To drain completely, always place engine level when draining thru the bottom. Oil capacity 1-1/4 pints. See figure 10.



FIGURE 10.



## AIR CLEANER

**CLEAN AIR CLEANER** and re-oil element every 25 hours under normal conditions. Clean every few hours under extremely dusty conditions. Poor engine performance and flooding usually indicates that the air cleaner should be serviced. See figure 11.

1. Remove screw.
2. Remove air cleaner carefully to prevent dirt from entering carburetor.
3. Take air cleaner apart and clean.
  - a. WASH foam element in kerosene or a liquid detergent and water to remove dirt.
  - b. DRY foam completely by wrapping and squeezing in a cloth.
  - c. SOAK foam with engine oil. Squeeze to distribute and remove excess oil.
4. Reassemble parts and fasten to carburetor.

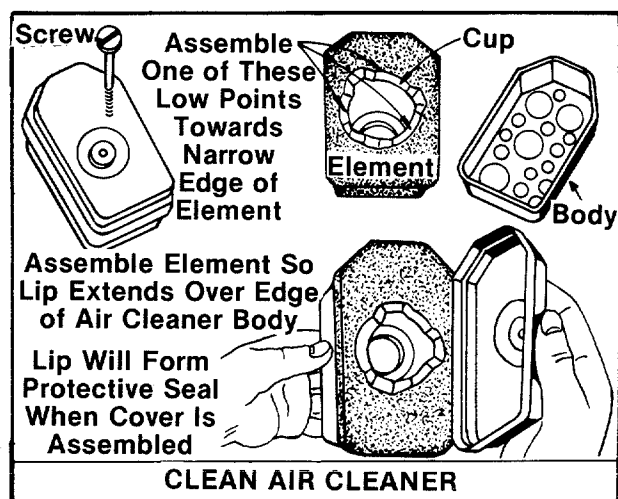

FIGURE 11.

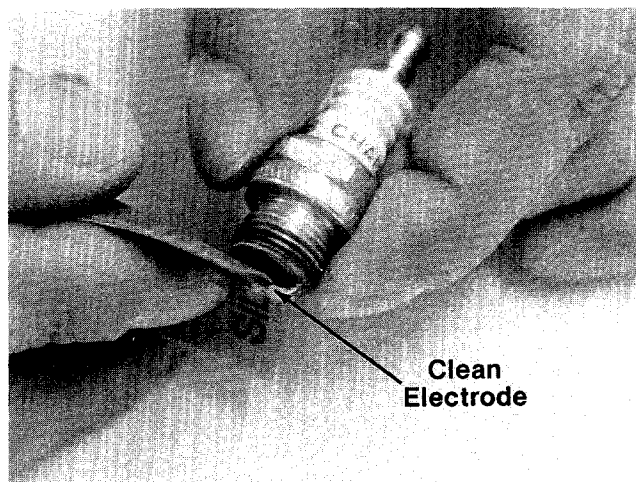

FIGURE 12.

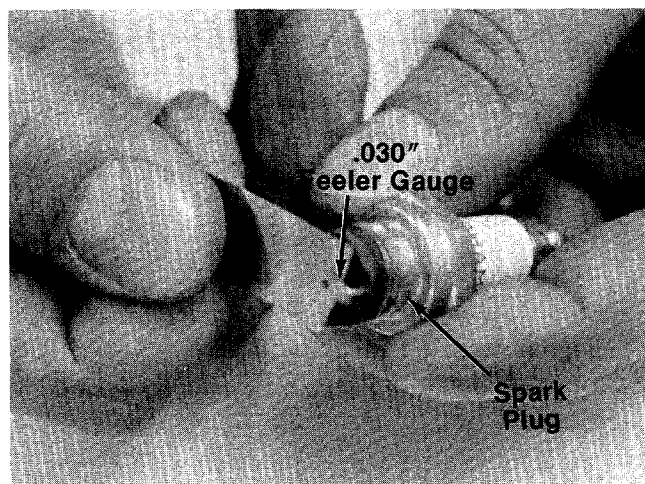

FIGURE 13.

## SPARK PLUG

The spark plug gap should be cleaned (see figure 12) and reset to a 0.030-inch clearance once a season (see figure 13). Spark plug replacement is recommended at the start of each mowing season; check engine parts list for correct plug type.



## NOTE

Whenever the spark plug is removed for cleaning, it is advisable to replace the spark plug gasket with a new gasket.

## USING YOUR ROTARY MOWER

For the best results do not cut wet grass because it tends to stick to the underside of the mower, thus preventing proper discharge of grass clippings. If wet grass must be cut, reduce walking speed to help distribute the clippings more effectively.

New grass should be treated as wet grass, otherwise a normal walking speed is about the right pace for efficient mowing.

The best mowing pattern is one that allows the clippings to discharge towards the uncut part of the lawn. This permits recutting of the clippings to further pulverize them. When cutting high weeds, discharge towards cut portion, then recut at right angles to first direction.

Lawn should be cut in the fall as long as there is growth.

## OFF-SEASON STORAGE

The following steps should be taken to prepare lawn mower for storage.

1. Clean and lubricate mower thoroughly as described in the lubrication instructions.
2. Refer to Engine Manual for correct engine storage instructions.
3. Coat mower's cutting blade with chassis grease to prevent rusting.
4. Place blocks under deck to raise tires clear of floor.
5. Store mower in a dry, clean area.

## HANDLE STORAGE

The handle may be placed in an upright position for storage.

Move the hairpin cotters to the outer hole on weld pins. See figure 1. Press inward on the bottom of the lower handle and push forward. The handle will lock in this position.

Reverse the above procedure to place the handle in the operating position.

The handle may also be folded away completely for storage.

1. Remove hairpin cotters from inner hole on weld pins on handle mount brackets. Place in outer hole.
2. Loosen the two hand knobs on each side of the handle.

3. Pull inward on the bottom of each side of the lower handle and push forward.
4. Fold the upper handle back and down as shown.

### To Take the Handle out of Storage Position.

1. Lift the upper handle up and towards the rear as shown.
2. Pull the handle back until it **locks** into the operator's position.
3. Tighten the two hand knobs securely.
4. Move the hairpin cotters to the inner hole on the weld pins.

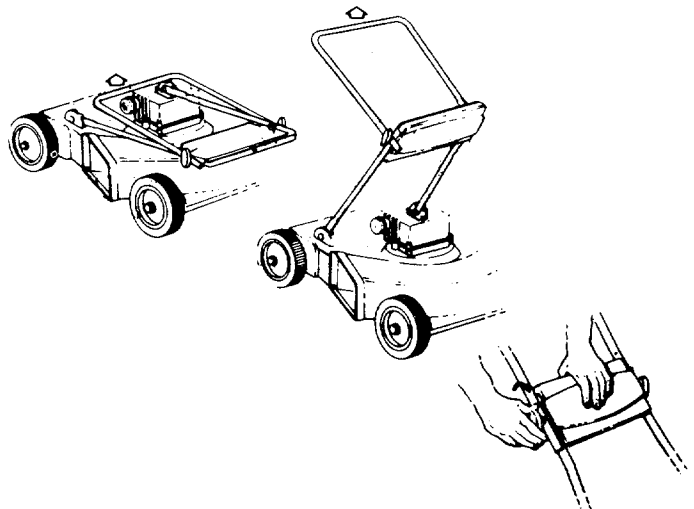

 **NOTE**

The manufacturer DOES NOT recommend the use of any accessory on this Rotary Mower other than those manufactured by the mower manufacturer.

GRASS CATCHER Model No. 190-003A is available as optional equipment for the mowers shown in this manual.



**WARNING**

1. The mower should not be operated without the entire grass catcher or chute deflector in place.
2. The mower should not be operated without the protective shield on the rear of the deck in place.

 **NOTE:**

Under normal usage bag material is subject to wear and should be checked periodically. Be sure any replacement bag complies with the mower manufacturer's recommendations.

For replacement bags, use only factory authorized replacement bag No. 764-0176.

# 110-152A 110-162A

IF YOU WRITE TO US ABOUT THIS ARTICLE  
OR IF YOU ORDER REPLACEMENT PARTS AL-  
WAYS MENTION THIS MODEL & SERIAL NO  
MODE!

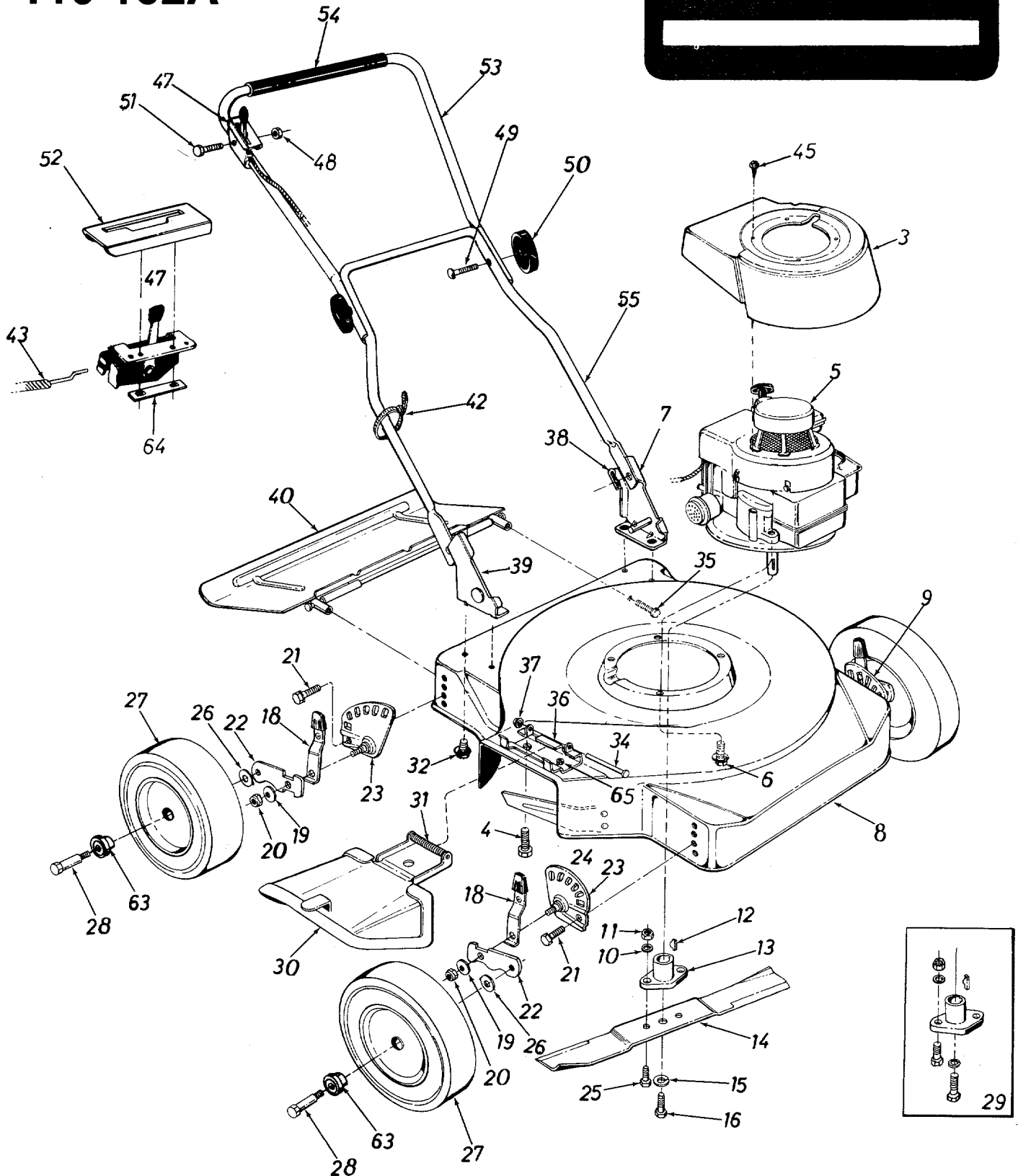

**PARTS LIST FOR MOWER MODELS 110-152A AND 110-162A**

REF. NO.	PART NO. 110-152A	COLOR CODE	PART NO. 110-162A	COLOR CODE	DESCRIPTION	NEW PART
3	731-0275		731-0275		Shroud	
4	710-0289		710-0289		Hex Bolt. 1/4-20 x .50" Lg.	
5	—		—		Engine	
6	710-0654		710-0654		Hex Wash. Hd. Self-Tap Scr. 3/8-16 x 1.25" Lg.	N
7	12935		12935		Handle Mtg. Brkt. Ass'y.	
8	12428	—462	12421	—462	Deck Assembly—Complete	
9	10938		10938		Height Adj. Ass'y.—Complete—L.H.	
10	736-0119		736-0119		L-Wash. 5/16 Scr.*	
11	712-0123		712-0123		Hex Nut 5/16-24 Thd.*	
12	714-0365		714-0365		#6 Hi-Pro-Key 5/32 x 5/8" Dia.	
13	10769		10769		Blade Adapter Kit	
14	742-0123		742-0125		Blade	
15	736-0217		736-0217		L-Wash. 3/8" Scr.—H.D.	
16	710-0459		710-0459		Hex Bolt 3/8-24 x 1.50" Lg.—H.T.	
18	10949		10949		Spring Lever Ass'y. with Knob	
19	736-0219		736-0219		Belleville Washer	
20	712-0116		712-0116		Elastic L-Nut 3/8-24 Thd.	
21	710-0209		710-0209		Sems Hex Bolt 3/8-16 x .62" Lg.	
22	10937		10937		Pivot Bar	
23	10935		10935		Index Plate Ass'y.—L.H.	
	10934		10934		Index Plate Ass'y.—R.H.	
24	10941		10941		Height Adj. Ass'y.—Complete R.H.	
25	710-0117		710-0117		Hex Bolt 5/16-24 x 1.00" Lg.—H.T.	
26	736-0105		736-0105		Belleville Washer	
27	734-0876		734-0661		Wheel Ass'y.—Complete	
28	738-0102		738-0102		Axle Bolt	
29	10769		10769		Blade Adapter Kit	
30	11679	—462	11679	—462	Chute Deflector Ass'y.	
31	732-0253		732-0253		Torsion Spring	
32	710-0600		712-0600		Hex Wash. Hd. Self-Tap Scr. 5/16-24 x .50" Lg.	
34	711-0555		711-0555		Pivot Pin	
35	710-0567		710-0567		Hex Bolt 1/4-28 x .62" Lg.	
36	11130	—462	11130	—462	Adapter Plate	
37	726-0106		726-0106		Push-on Flange Palnut	
38	714-0104		714-0104		Hairpin Cotter	
39	12936		12936		Handle Mtg. Brkt. Ass'y.	
40	12251	—462	14084	—462	Rear Protective Shield Ass'y.—Comp.	N
42	726-0188		726-0188		Cable Tie	
43	746-0381		746-0381		Conduit and Wire	N
45	710-0227		710-0227		Hex Wash. Hd. AB-Tap. Scr. #8 x .38" Lg.	
47	746-0380		746-0380		Throttle Control Comp.	N
48	712-0107		712-0107		Hex Cent. L-Nut 1/4-20 Thd.	
49	710-0405		710-0405		Curved Hd. Bolt 5/16-18 x 1.75" Lg.	
50	09966		09966		Hand Knob	
51	710-0606		710-0606		Hex Bolt 1/4-20 x 1.50" Lg.*	
52	731-0344		731-0344		Plastic Cover	
53	749-0384				Upper Handle	
54	718-0145		718-0145		Grip	N
55	749-0373				Lower Handle	N
63	741-0262		741-0262		Fortiflex Bearing (2 per wheel)	
64	726-0134		726-0134		Speed Nut #8-32—Twin Type	
65	712-0107		712-0107		Hex Cent. L-Nut 1/4-20 Thd.	

(462—Red Flake)

\*For faster service obtain standard nuts, bolts and washers locally. If these items cannot be obtained locally, order by part number and size as shown on parts list.

When ordering parts, if color or finish is important use the appropriate color code shown above (e.g. Red Flake Finish—12609 (462).)

NOTE: The engine is not under warranty by the mower manufacturer . . . If repairs or service is needed on the engine, please contact your nearest authorized engine service outlet. Check the "Yellow Pages" of your telephone book under "Engines—Gasoline."



This instruction manual covers various models and all specifications shown do not necessarily apply to your model. Specifications subject to change without notice or obligation.

# PARTS INFORMATION

## POWER EQUIPMENT PARTS AND SERVICE

Parts and service for all MTD manufactured power equipment are available through the authorized service firms listed below. All orders should specify the model number of your unit, parts number, description of parts and the quantity of each part required.

<b>ALABAMA</b>	<b>BIRMINGHAM</b>	
Auto Electric & Carburetor Co. ....	2625 4th Ave. S. ....	35233
<b>ARKANSAS</b>	<b>FORT SMITH</b>	
Mity Mite Motors, Inc. ....	4515 South 16th Street	72901
	<b>NORTH LITTLE ROCK</b>	
Sutton's Lawn Mower Shop ....	Rt. 4 Box 368. ....	72117
<b>CALIFORNIA</b>	<b>PORTERVILLE</b>	
Billious ....	75 North D Street ....	93257
	<b>SAN BERNARDINO</b>	
Lawn Mower Supply Co. ....	25608 E. Baseline ....	92410
	<b>SAN FRANCISCO</b>	
J.W. Jewett Co. ....	981 Folsom St. ....	94107
<b>COLORADO</b>	<b>DENVER</b>	
South Denver Lawn Equip. ....	527 West Evans ....	80223
<b>FLORIDA</b>	<b>JACKSONVILLE</b>	
Radco Distributors ....	2403 Market St. ....	32206
	<b>OPA LOCKA</b>	
Small Eng. Dist. ....	2351 N.W. 147th St. ....	33054
<b>GEORGIA</b>	<b>EAST POINT</b>	
East Point Cycle & Key. ....	2834 Church St. ....	30344
<b>ILLINOIS</b>	<b>LYONS</b>	
Keen Edge Co. ....	8615 Ogden Ave. ....	60534
<b>INDIANA</b>	<b>ELKHART</b>	
Parts & Sales Inc. ....	2101 Industrial Pkwy. ....	46514
<b>IOWA</b>	<b>DUBUQUE</b>	
Power Lawn & Garden Equip. ....	2551 J.F. Kennedy. ....	52001
<b>LOUISIANA</b>	<b>NEW ORLEANS</b>	
Suhren Engine Co. ....	8330 Earhart Blvd. ....	70118
<b>MARYLAND</b>	<b>TAKOMA PARK</b>	
Center Supply Co. ....	6867 New Hampshire Ave. ....	20012
<b>MASSACHUSETTS</b>	<b>SPRINGFIELD</b>	
Morton B. Collins Co. ....	300 Birnie Ave. ....	01107
<b>MICHIGAN</b>	<b>LANSING</b>	
Lorenz Service Co. ....	2500 S. Pennsylvania. ....	48910
	<b>MOUNT CLEMENS</b>	
Power Equipment Dist. ....	36463 South Gratiot. ....	48043
<b>MINNESOTA</b>	<b>HOPKINS</b>	
Hance Distributing Inc. ....	420 Excelsior Ave. W. ....	55343
	<b>ST. PAUL</b>	
Power Tools Inc. ....	3771 Sibley Memorial Hwy. ....	55122
<b>MISSISSIPPI</b>	<b>BILOXI</b>	
Biloxi Sales & Service, Inc. ....	506 Caillavet St. ....	39533
<b>MISSOURI</b>	<b>KANSAS CITY</b>	
Automotive Equip. Service ....	3117 Holmes St. ....	64109
	<b>ST. JOSEPH</b>	
Ross-Frazier Supply Co. ....	8th and Monteray ....	64503
	<b>ST. LOUIS</b>	
Henzler, Inc. ....	2015 Lemay Ferry Rd. ....	63125
<b>NEW JERSEY</b>	<b>BELLMAWR</b>	
Lawnmower Parts Inc. ....	717 Creek Rd. ....	08030
	<b>RUTHERFORD</b>	
Feld Distributor ....	28 Glen Rd. ....	07070
<b>NEW YORK</b>	<b>CARTHAGE</b>	
Gamble Dist., Inc. ....	West End Ave. ....	13619

## BRIGGS AND STRATTON, TECUMSEH AND PEERLESS PARTS AND SERVICE

Briggs & Stratton, Tecumseh and Peerless parts and service should be handled by your nearest authorized engine service firm. Check yellow pages of your telephone directory under the list. **Engines—Gasoline**, Briggs & Stratton or Tecumseh Lauson.

	<b>SYRACUSE</b>	
GTP Leisure Products Inc. ....	420 Marcellus St. ....	13204
<b>NORTH CAROLINA</b>	<b>GOLDSBORO</b>	
Smith Hardware Co. ....	515 N. George St. ....	27530
	<b>GREENSBORO</b>	
Dixie Sales Company ....	327 Battleground Ave. ....	27402
<b>OHIO</b>	<b>CARROLL</b>	
Stebe's Mid-State Mower Supply ...	Box 366-71 High St. ...	43112
	<b>CLEVELAND</b>	
Bleckrie, Inc. ....	7900 Lorain Ave. ....	44102
	<b>WADSWORTH</b>	
National Central. ....	687 Seville Rd. ....	44281
	<b>YOUNGSTOWN</b>	
Burton Supply Co. ....	1301 Logan Ave. Box 929 ...	44501
<b>OKLAHOMA</b>	<b>ADA</b>	
Ada Auto Supply ....	301 E. 12th St. ....	74820
	<b>MUSKOGEE</b>	
Victory Motors, Inc. ....	605 S. Cherokee. ....	74401
	<b>OKLAHOMA CITY</b>	
Forest Sales Inc. ....	1039 NW 63rd St. ....	73116
<b>OREGON</b>	<b>PORTLAND</b>	
Kenton Supply Co. ....	8216 N. Denver Ave. ....	97217
<b>PENNSYLVANIA</b>	<b>CHESTER</b>	
Stull Equipment Corp. ....	742 W. Front St. ....	19013
	<b>HARRISBURG</b>	
EECO Inc. ....	4021 N. 6th St. ....	17110
	<b>PHILADELPHIA</b>	
Thompson Rubber Co. ....	5222-24 N. Fifth St. ....	19120
	<b>PITTSBURGH</b>	
Bluemont Co. ....	11125 Frankstown Rd. ....	15235
<b>TENNESSEE</b>	<b>KNOXVILLE</b>	
Master Repair Service. ....	2000 Western Ave. ....	375
	<b>MEMPHIS</b>	
Memphis Cycle & Supply Co. ....	421 Monroe Ave. ....	38103
American Sales & Service, Inc. ....	1922 Lynnbrook. ....	38116
<b>TEXAS</b>	<b>DALLAS</b>	
Marr Brothers, Inc. ....	423 E. Jefferson. ....	75203
	<b>FORT WORTH</b>	
Woodson Sales Corp. ....	1702 N. Sylvania ....	76111
	<b>HOUSTON</b>	
Bullard Supply Co. ....	2409 Commerce St. ....	77003
	<b>SAN ANTONIO</b>	
Catto & Putty, Inc. ....	414 Live Oak ....	78298
<b>UTAH</b>	<b>SALT LAKE CITY</b>	
A-1 Engine & Mower Co. ....	437 E. 9th St. ....	84111
<b>VERMONT</b>	<b>BURLINGTON</b>	
Vermont Hdwe. Co. Inc. ....	180 Flynn Ave. ....	05401
<b>VIRGINIA</b>	<b>RICHMOND</b>	
RBI Corp. ....	963 Myers St. ....	23260
<b>WASHINGTON</b>	<b>SEATTLE</b>	
Bailey's Inc. ....	1414 14th Ave. ....	98102
<b>WEST VIRGINIA</b>	<b>CHARLESTON</b>	
Young's, Inc. ....	233 Virginia St., E. ....	25301
<b>WISCONSIN</b>	<b>APPLETON</b>	
Automotive Supply Co. ....	123 S. Linwood Ave. ....	54911

## WARRANTY PARTS AND SERVICE POLICY

The purpose of warranty is to protect the customer from defects in workmanship and materials, defects which are NOT detected at the time of manufacture. It does not provide for the unlimited and unrestricted replacement of parts. Use and maintenance are the responsibility of the customer. The manufacturer cannot assume responsibility for conditions which it has no control. Simply put, if it's the manufacturer's fault, it's the manufacturer's responsibility; if it's the customer's fault, it's the customer's responsibility.

### CLAIMS AGAINST THE MANUFACTURER'S WARRANTY INCLUDES

1. **Replacement of Missing Parts** on new equipment.
2. **Replacement of Defective Parts** within the warranty period.
3. **Repair of Defects** within the warranty period.

All claims MUST be substantiated with the following information:

1. **Model Number** of unit involved.
2. **Date** unit was purchased or first put into service.
3. **Date of failure.**
4. **Nature of failure.**

## Free Manuals Download Website

<http://myh66.com>

<http://usermanuals.us>

<http://www.somanuals.com>

<http://www.4manuals.cc>

<http://www.manual-lib.com>

<http://www.404manual.com>

<http://www.luxmanual.com>

<http://aubethermostatmanual.com>

Golf course search by state

<http://golfingnear.com>

Email search by domain

<http://emailbydomain.com>

Auto manuals search

<http://auto.somanuals.com>

TV manuals search

<http://tv.somanuals.com>