

# OWNER'S GUIDE

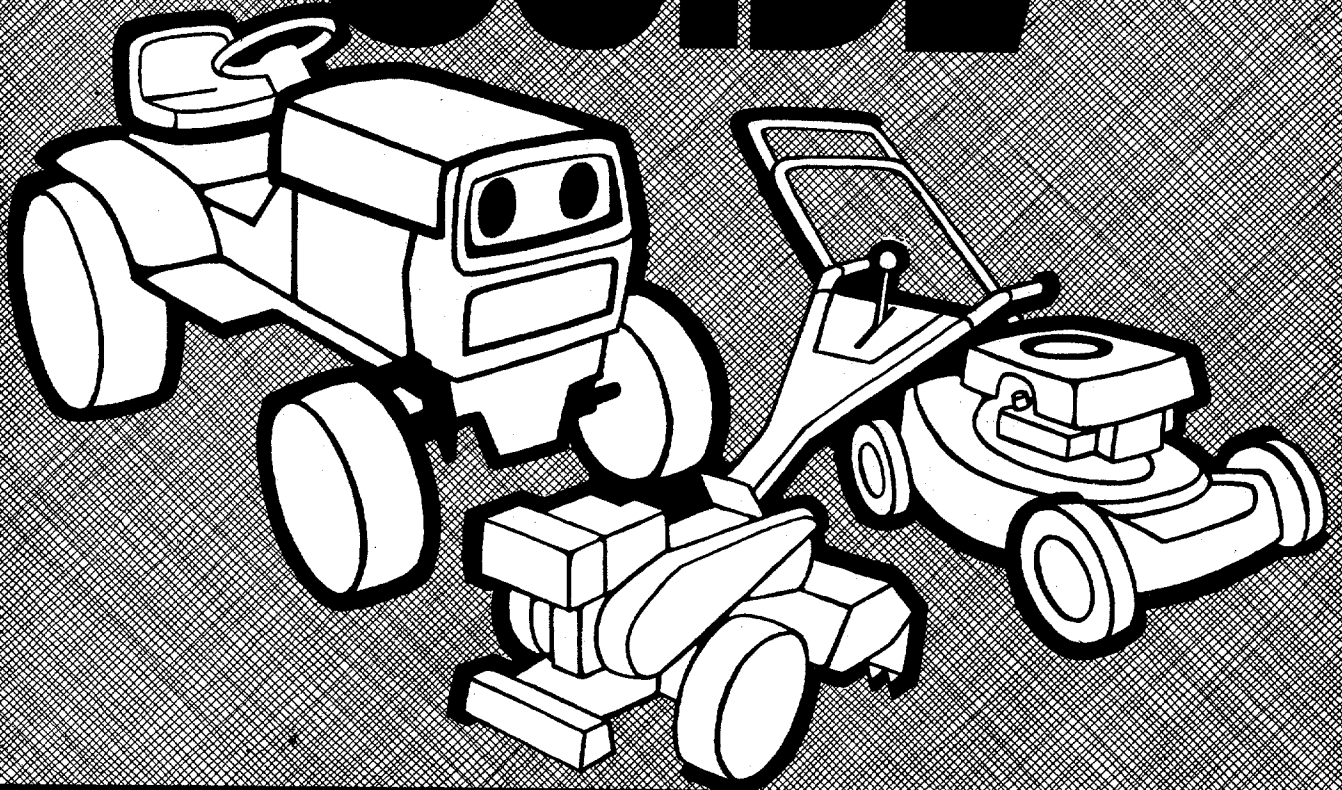

ASSEMBLY • OPERATION • MAINTENANCE • PARTS

## 18" ROTARY MOWERS

**Important:**

**Read Safety Rules and  
Instructions Carefully**

Thank you for purchasing an  
American built product.

**Model Numbers**

**111-020A**

**111-021A**

**111-020-300**

**111-021-300**

# INDEX

Safe Operation Practices.....	3	Using Your Rotary Mower.....	10
Assembly.....	4	Off-Season Storage.....	10
Operation.....	6	Exploded Parts View.....	12
Adjustments.....	7	Repair Parts List.....	13
Lubrication.....	8	Parts Information.....	Back Cover
Maintenance.....	8		

## LIMITED WARRANTY

For one year from the date of original retail purchase, MTD PRODUCTS INC will either repair or replace, at its option, free of charge, F.O.B. factory or authorized service firm, any part or parts found to be defective in material or workmanship. Transportation charges for any parts submitted for replacement under this warranty must be paid by the purchaser unless such return is requested by MTD PRODUCTS INC.

This warranty will not apply to any part which has become inoperative due to misuse, excessive use, accident, neglect, improper maintenance, alterations, or unless the unit has been operated and maintained in accordance with the instructions furnished. This warranty does not apply to the engine, motor, battery, battery charger or component parts thereof. Please refer to the applicable manufacturer's warranty on these items.

This warranty will not apply where the unit has been used commercially.

Warranty service is available through your local authorized service dealer or distributor. If you do not know the dealer or distributor in your area, please write to the Customer Service Department of MTD.

The return of a complete unit will not be accepted by the factory unless prior written permission has been extended by MTD.

This warranty gives you specific legal rights. You may also have other rights which vary from state to state.



**WARNING**

### TO PURCHASERS OF INTERNAL COMBUSTION ENGINE EQUIPPED MACHINERY OR DEVICES IN THE STATE OF CALIFORNIA

The equipment which you have just purchased does not have a spark arrester. If this equipment is used on any forest covered land, brush covered land, or grass covered unimproved land in the State of California, before using on such land, the California law requires that a spark arrester be provided. In addition, spark arrester is required by law to be in effective working order. The spark arrester must be attached to the exhaust system and comply with Section 4442 of the California Public Resources Code.



**WARNING**

To reduce the potential for any injury, comply with the following safety instructions. Failure to comply with the instructions may result in personal injury.

## **SAFE OPERATION PRACTICES FOR WALK-BEHIND MOWERS**

### **TRAINING**

1. It is suggested that this manual be read in its entirety before attempting to assemble or operate this unit. Keep this manual in a safe place for future reference and for ordering replacement parts.
2. Your rotary mower is a precision piece of power equipment, not a plaything. Therefore, exercise extreme caution at all times.
3. Read this Owner's Manual carefully. Be thoroughly familiar with the controls and the proper use of the equipment.
4. Never allow children to operate a power mower. Only persons well acquainted with these rules of safe operation should be allowed to use your mower.
5. Keep the area of operation clear of all persons, particularly small children and pets. Stop engine when they are in the vicinity of your mower. Although the area of operation should be completely cleared of foreign objects, a small object may have been overlooked and could be accidentally thrown by the mower in any direction and cause injury.
6. After striking a foreign object, stop the engine, remove the wire from the spark plug, and thoroughly inspect the mower for any damage. Repair the damage before restarting and operating the mower.
7. When cleaning, repairing or inspecting, make certain the blade and all moving parts have stopped. Disconnect the spark plug wire, and keep the wire away from the plug to prevent accidental starting.
8. Before attempting to unclog the mower or discharge chute, stop the engine and be sure the blade has stopped completely. The cutting blade continues to rotate for a few seconds after the engine is shut off. Never place any part of the body in the blade area until you are sure the blade has stopped rotating. Disconnect the spark plug wire and keep the wire away from the plug to prevent accidental starting.
9. Do not run the engine indoors.
10. Shut the engine off and wait until the blade comes to a complete stop before removing the grass catcher or unclogging chute.
11. Mow across the face of slopes, never up-and-down. Exercise extreme caution when changing direction on slopes. Do not mow excessively steep slopes.
12. Always disconnect electric mowers (line operated) before cleaning, repairing or adjusting.
13. Never operate mower without proper guards, plates or other safety protective devices in place.
14. Keep washout ports and other mower-housing service openings closed when mowing.

### **PREPARATION**

1. Thoroughly inspect the area where the equipment is to be used. Remove all stones, sticks, wire, bones and other foreign objects which could be picked up and thrown by the mower in any direction and cause injury.
2. Do not operate equipment when barefoot or wearing open sandals. Always wear substantial footwear.
3. Do not wear loose fitting clothing that could get caught on the mower.
4. Check the fuel before starting the engine. Gasoline is an extremely flammable fuel. Do not fill the gasoline tank indoors, while the engine is running, or while the engine is still hot. Wipe off any spilled gasoline before starting the engine as it may cause a fire or explosion.
5. Disengage the self-propelled mechanism or drive clutch on units so equipped before starting the engine.
6. Never attempt to make a wheel or cutting height adjustment while the engine is running.
7. Mow only in daylight or in good artificial light.
8. Never operate the equipment in wet grass. Always be sure of your footing. Keep a firm hold on the handle and walk, never run.

### **OPERATION**

1. Do not change the engine governor settings or overspeed the engine. Excessive engine speeds are dangerous.
2. Do not put hands or feet near or under rotating parts. Keep clear of the discharge opening at all times as the rotating blade can cause injury.
3. Stop the blade when crossing gravel drives, walks or roads.
4. To reduce fire hazard, keep the engine free of grass, leaves, or excessive grease.
5. Check the grass catcher bag frequently for wear or deterioration. For safety protection, replace only with new bag meeting original equipment specifications.

# ASSEMBLY INSTRUCTIONS



This unit is shipped WITHOUT GASOLINE or OIL. After assembly, see operating section of this manual for proper fuel and engine oil recommendations.

## Tools Required for Assembly:

- (1) Adjustable Wrench
- (1) 7/16" Open End or Box Wrench
- (1) 3/4" Open End or Box Wrench

## ← Contents of Hardware Pack: (See Figure 1)

- A (5) Hex Bolts 1/4-20 x 1 1/2" Long
- B (6) Hex Lock Nuts 1/4-20 Thread
- C (1) Hex Bolt 1/4-20 x 1 3/4" Long
- D (2) Cable Ties
- E (4) Shoulder Bolts (Axles)
- F (4) Belleville Washers
- G (2) Hairpin Cotter
- H (2) Hand Grips (Not Shown)

## Loose Parts in Carton: (See Figure 2)

- I (4) Wheels
- J (2) Upper Handles
- K (1) Lower Handle

- ← 1. Remove lawn mower and all parts from the carton. Make certain that all loose parts and literature have been removed before the carton is discarded.
2. Extend throttle control assembly which is attached to engine at the rear of the mower and place on floor.



Do not bend or kink control wires.

3. Your mower has four height settings. Use the same hole for all four wheels when assembling. See figure 3.
4. Place shoulder bolt (E) through wheel (I). See figure 3.
- ← 5. Place crown side of belleville washer (F) towards the wheel (away from deck). See figure 3.
6. Secure wheel to deck, using a 3/4" wrench.

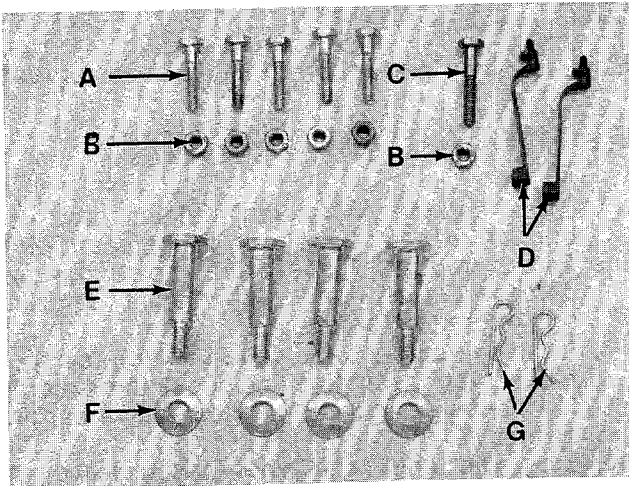

FIGURE 1.

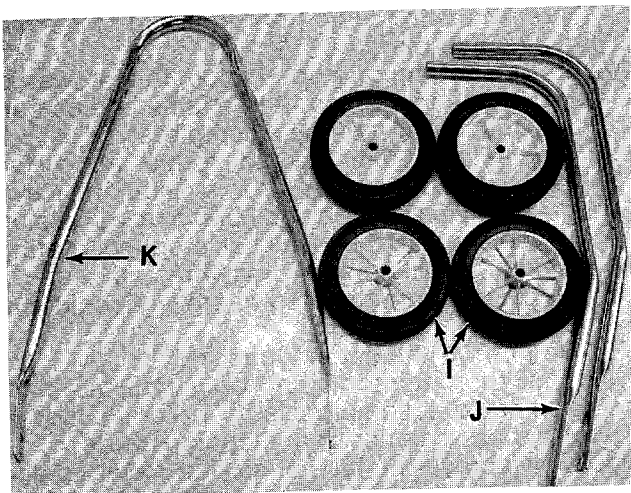

FIGURE 2.

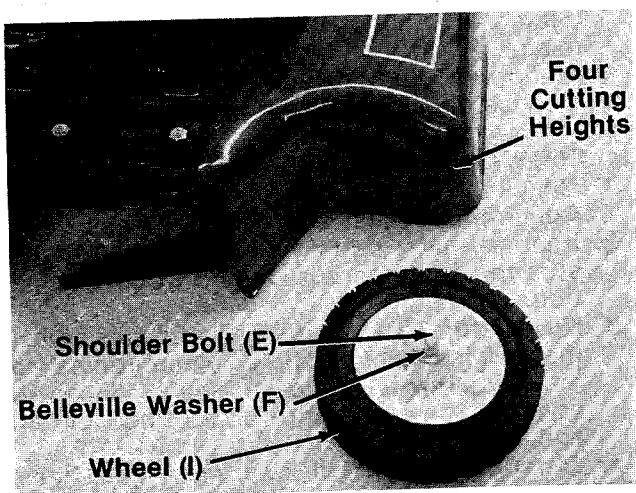

FIGURE 3.

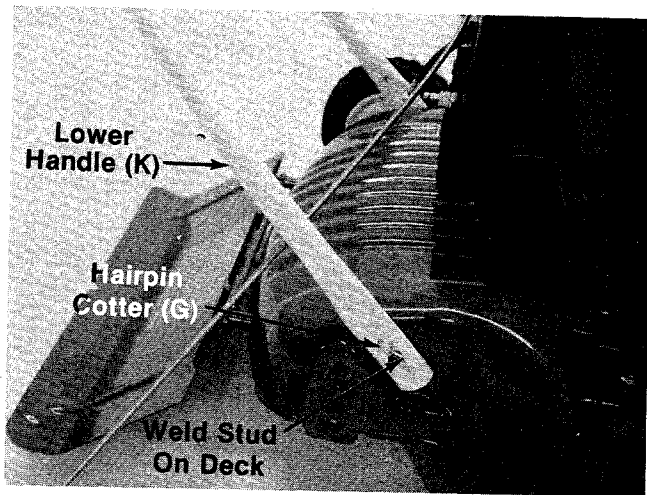

FIGURE 4.

7. Place the **upper slotted hole** in lower handle (K) over studs located in front of each rear wheel. Secure with hairpin cotter (G) provided in hardware pack. See figure 4.

**NOTE**

It may be necessary to bend the ends of the lower handle inward slightly to assure a snug fit against the deck mounting area.

**NOTE**

Figure 4 was photographed with the rear wheel removed for clarity. It is not necessary to remove wheel for handle assembly.

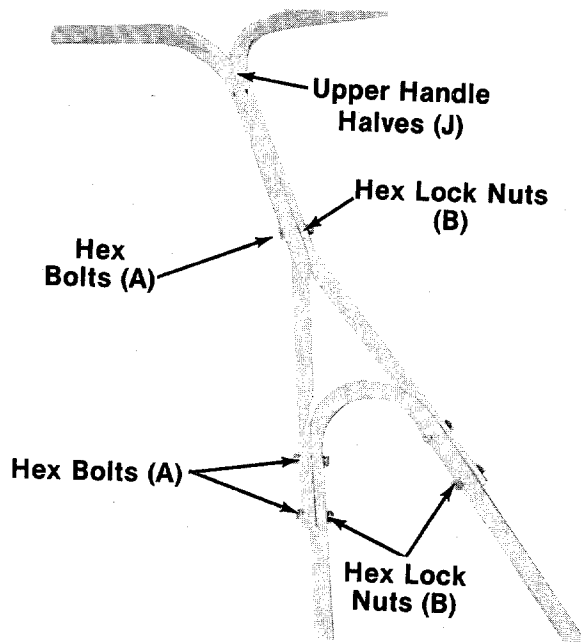

FIGURE 5.

8. Assemble the upper handle halves (J) to lower handle using five hex bolts (A) and lock nuts (B). Only tighten finger tight. See figure 5.

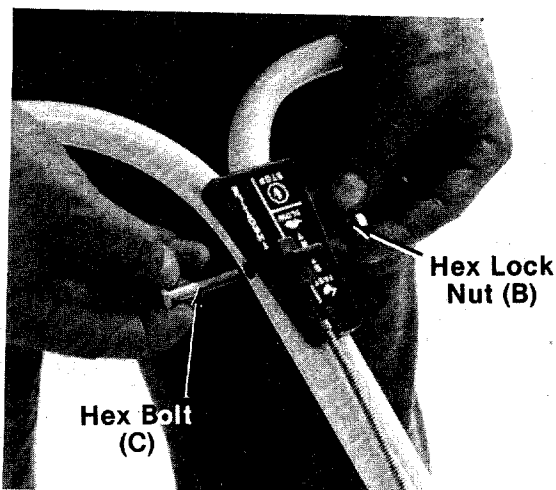

FIGURE 6.

9. Place the tab on throttle control between the upper handle halves at top hole. Secure with hex bolt (C) and hex lock nut (B) provided in hardware pack. See figure 6.

10. Tighten securely all six hex bolts and hex lock nuts with 7/16" wrench.

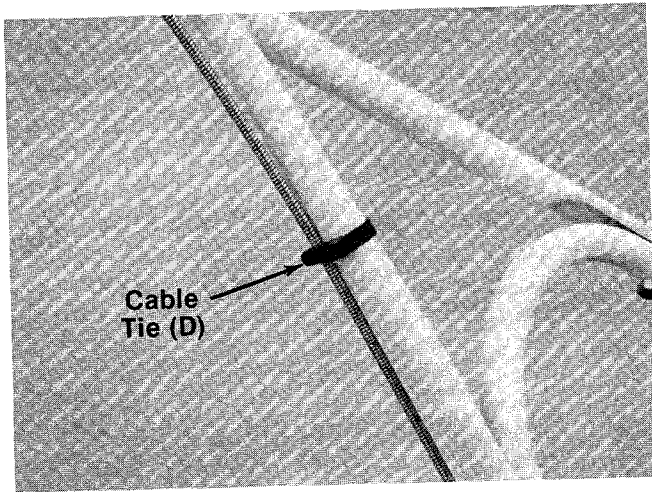

FIGURE 7.

11. Secure throttle control wire to handle with two cable ties (D) provided in hardware pack. See figure 7.
12. Slip hand grips (H) on the upper end of each handle. They will slip on more easily if you first soak them in warm, soapy water.
13. Check all nuts and bolts for correct tightness.

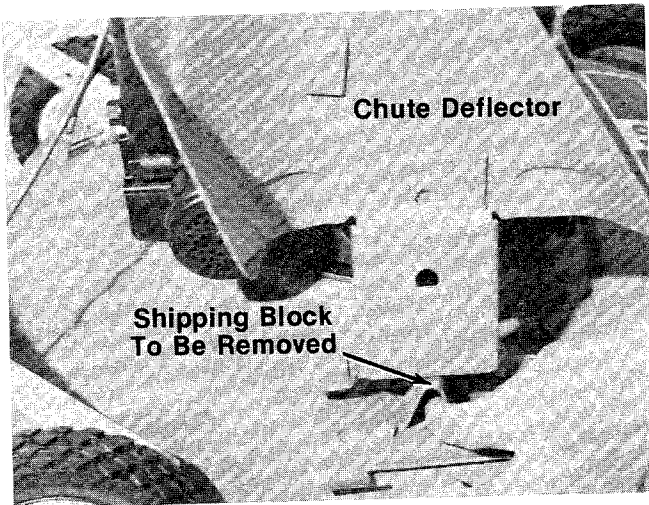

FIGURE 8.

**CAUTION**

Please note that the chute deflector on your mower is in an upright position. It is held in that position by a shipping block. This block is used for shipping purposes only. It must be removed and discarded before your mower is put into operation. See figure 8.

## OPERATION

Keep hands and feet away from the chute area on cutting deck. See figure 9.

**CAUTION**  
**DO NOT OPERATE**  
**MOWER UNLESS**  
**GUARD OR ENTIRE**  
**GRASS CATCHER IS**  
**IN ITS PROPER PLACE.**



FIGURE 9.



1. **FILL SUMP WITH OIL** using a high quality detergent oil classified "For Service SC, SD, SE or MS." Nothing should be added to the recommended oil.

Use SAE 30 oil. If not available, use SAE 10W-30 or 10W-40 oil.

Place the engine level. Remove oil filler plug. **FILL THE OIL SUMP TO POINT OF OVERFLOWING.** Pour slowly. Capacity 1-1/4 pints.

2. **FILL FUEL TANK** using clean, fresh, **regular** grade automotive gasoline. Fill tank completely!

**DO NOT MIX OIL WITH GASOLINE.**

3. When ready to start engine, place throttle control lever on handle in "START" position and start engine in accordance with instructions in engine manual. After engine starts, move throttle control lever on handle to desired engine speed. The engine is stopped by placing control lever on handle in the "STOP" position.

4. Be sure that lawn is clear of stones, sticks, wire, or other objects which could damage lawn mower or engine. For best results and to insure more even grass distribution, do not mow when lawn is excessively wet.

**➔ IMPORTANT**

After striking a foreign object, stop the engine. Remove wire from spark plug and thoroughly inspect the mower for any damage. Repair the damage before restarting and operating the mower.

## ADJUSTMENTS



**CAUTION**

Do not at any time make any adjustment to lawn mower without first stopping engine and disconnecting spark plug wire.

### CUTTING HEIGHT

Adjustment is made by removing and moving axle bolts to desired position. Cutting heights will be raised as axle bolts are moved to a lower hole and lowered as axle bolts are moved to a higher hole in the deck. All axle bolts must be mounted in the same relative position to the deck. See figure 3.

## THROTTLE

If adjustment becomes necessary, the throttle control wire assembly can be reset as follows:

1. Loosen, but do not remove, screw securing throttle control wire assembly at engine. See figure 10.
2. Move throttle control lever on handle to "FAST" position.
3. Move lever, to which control wire is fastened at engine, to full open position and retighten screw to secure throttle control wire assembly.

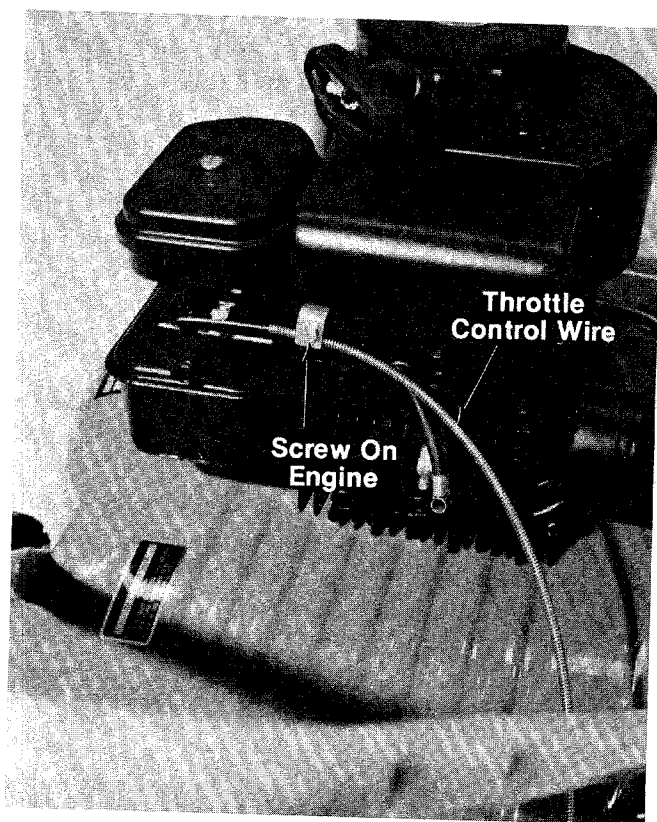

**FIGURE 10.**



**WARNING**

If any adjustments are made to the engine while the engine is running (e.g. carburetor), disengage all clutches and blades. Keep clear of all moving parts. Be careful of heated surfaces and muffler.

## CARBURETOR ADJUSTMENTS (See Figure 11)

Minor carburetor adjustment may be required to compensate for differences in fuel, temperature, altitude and load.

All carburetor adjustments should be made with the air cleaner on engine. Air cleaner mounting screw must be in carburetor when engine is run. Best adjustment is made with a fuel tank half full of gasoline.

### To Adjust Carburetor:

1. Start engine and run long enough to warm it to operating temperature. If engine is out of adjustment so that it will not start, close the needle valve by turning it clockwise. Then open needle valve 1-1/2 turns counterclockwise.
2. Move engine control to run engine at normal operating speed.
  - a. Turn needle valve in clockwise until engine starts to lose speed (lean mixture).
  - b. Then slowly turn needle valve out counterclockwise past the point of smoothest operation until engine just begins to run unevenly (rich mixture).
  - c. Turn needle valve back in clockwise very slowly till engine runs evenly.
  - d. Final adjustment of the needle valve should be slightly to the rich side (turn counterclockwise) of the mid-point.
3. Move engine control to SLOW. Turn idle adjusting screw until a fast idle is obtained—(1750 R.P.M.).
4. To check adjustment, move engine control from SLOW to FAST speed. Engine should accelerate smoothly. If engine tends to stall or die out, increase idle speed or readjust carburetor, usually to a slightly richer mixture.

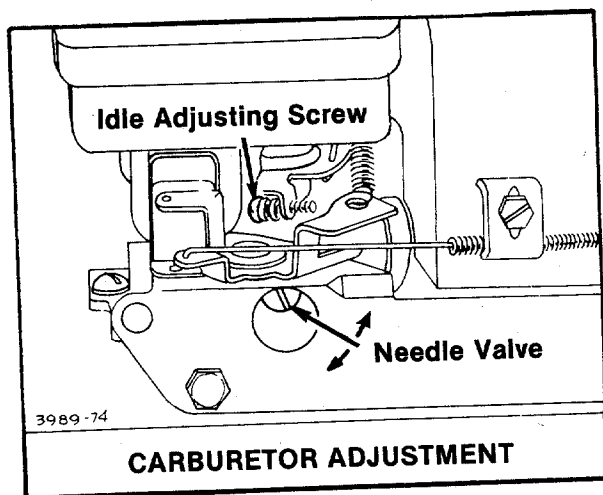

FIGURE 11.

## LUBRICATION



Always stop engine and disconnect spark plug wire before cleaning, lubricating or doing any kind of work on lawn mower.

**Wheels**—The wheels require no lubrication. However, if the wheels are removed for any reason, lubricate the surface of the axle bolt and the inner surface of the wheel with light oil. A 4 oz. plastic bottle of light oil lubricant is available. Order part number 737-0170. Engine oil may also be used.

**Protective Shield**—The pivot points on the protective shield should be lubricated periodically with light oil to prevent any rust or binding.

**Chute Deflector**—The torsion spring and pivot point should be lubricated periodically with light oil to prevent any rust or binding. Deflector must work freely.

**Engine**—Follow engine manual for lubrication instructions.

**Throttle**—Periodically lubricate throttle control lever and throttle wire assembly with a few drops of light oil for ease of operation.

## MAINTENANCE



**WARNING**

Disconnect spark plug wire and ground it against the engine before performing any repairs or maintenance.

### CUTTING BLADE

#### A. Removal for Sharpening or Replacement



**WARNING**

Be sure to disconnect and ground the spark plug wire before working on the cutting blade to prevent accidental engine starting.

1. Remove the large bolt and lock washer which holds the blade and adapter to the engine crankshaft.
2. Remove the blade and adapter from the crankshaft. Be careful not to lose the key on the crankshaft.



3. If the blade or blade adapter needs replacing, remove the two small bolts, lock washers and nuts which hold the blade to the adapter.

### B. Sharpening

Remove the cutting blade by following the directions of the preceding section.

When sharpening the blade, follow the original angle of grind as a guide. It is **extremely important** that each cutting edge receives an equal amount of grinding to prevent an unbalanced blade. An unbalanced blade will cause excessive vibration when rotating at high speeds and may cause damage to the mower.

The blade can be tested for balance by balancing it on a round shaft screwdriver. Remove metal from the heavy side until it balances evenly.



It is recommended that the blade always be removed from the adapter for the best test of balance.

### C. Reassembly

Before reassembling the blade and the blade adapter to the unit, lubricate the engine crankshaft and the inner surface of the blade adapter with light oil. Lubricating the bolt holes, bolts and inner surface of the nuts with light oil is also recommended. A 4 oz. plastic bottle of light oil lubricant is available. Order part number 737-0170. Engine oil may also be used.

When replacing the blade, be sure to install the blade with the side of the blade marked "Bottom" (or with part number) facing the ground when the mower is in the operating position. Make certain key is in place on the crankshaft.

#### Blade Mounting Torque

3/8" Dia. Bolt 375 in. lb. min., 450 in. lb. max.

5/16" Dia. Bolt 150 in. lb. min., 250 in. lb. max.

To insure safe operation of your unit, **ALL** nuts and bolts must be checked periodically for correct tightness.

### DECK

The underside of mower deck should be cleaned after each period of use as grass clippings, leaves, dirt and other matter will accumulate. This accumulation of grass clippings, etc., is undesirable as it will invite rust and corrosion and may cause an uneven discharge of grass clippings at the next cutting.

The deck may be cleaned by tilting the mower forward or on its side and scraping clean with a suitable tool or by washing with a stream of water from a garden hose.



### CAUTION

Do not direct the stream of water at a hot engine as damage to the engine may result.

### ENGINE OIL

**CHECK OIL LEVEL** before starting engine and after every 5 hours of operation.

**ADD** oil as necessary to keep level **FULL TO POINT OF OVERFLOWING**.

Before removing oil fill plug, clean area around plug to prevent dirt from entering oil fill hole.

Engine should be in a level position when checking oil.

**CHANGE OIL** after first 5 hours of operation. Thereafter change every 25 hours. Change oil while engine is warm. Oil may be drained through drain on bottom of engine. To drain completely, always place engine level when draining through the bottom. Oil capacity 1-1/4 pints. See figure 12.

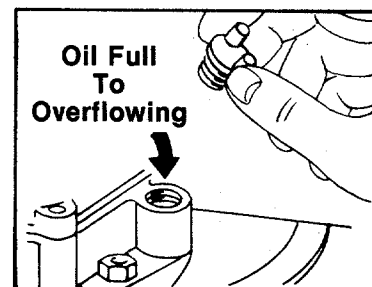

FIGURE 12.

### AIR CLEANER

**CLEAN AIR CLEANER** and re-oil element every 25 hours under normal conditions. Clean every few hours under extremely dusty conditions. Poor engine performance and flooding usually indicates that the air cleaner should be serviced. See figure 13.

1. Remove screw.
2. Remove air cleaner carefully to prevent dirt from entering carburetor.
3. Take air cleaner apart and clean.
  - a. **WASH** foam element in kerosene or a liquid detergent and water to remove dirt.
  - b. **DRY** foam completely by wrapping and squeezing in a cloth.
  - c. **SOAK** foam with engine oil. Squeeze to distribute and remove excess oil.
4. Reassemble parts and fasten to carburetor.

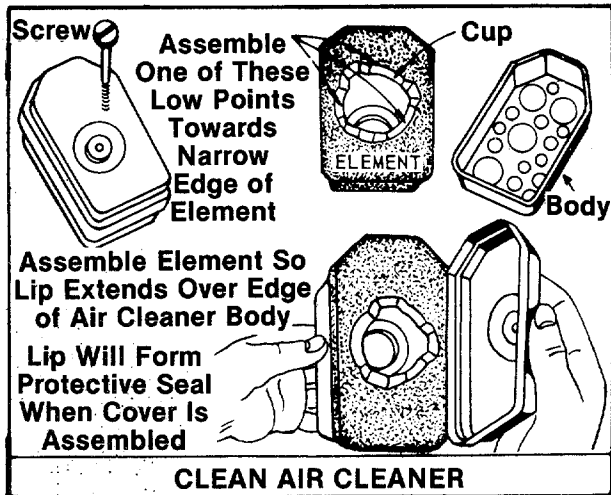

FIGURE 13.

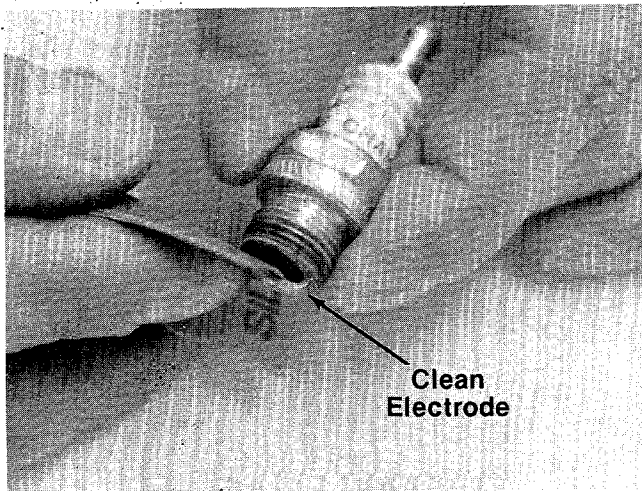

FIGURE 14.

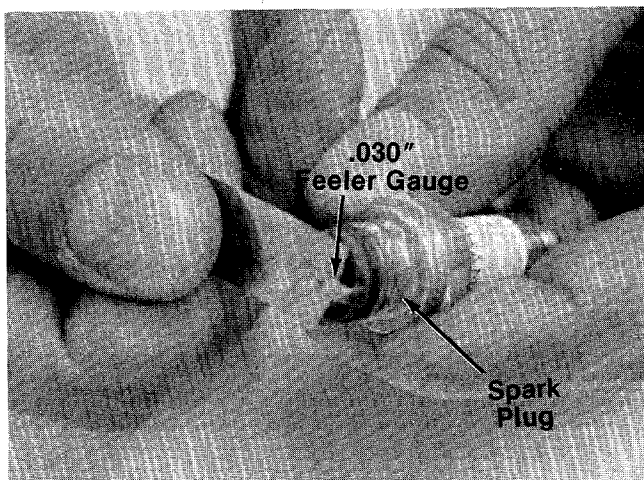

FIGURE 15.

## SPARK PLUG

The spark plug should be cleaned (see figure 14) and the gap reset to a 0.030-inch clearance once a season (see figure 15). Spark plug replacement is recommended at the start of each mowing season; check engine manual for correct plug type.



Whenever the spark plug is removed for cleaning, it is advisable to replace the spark plug gasket with a new gasket.

## USING YOUR ROTARY MOWER

For the best results, do not cut wet grass because it tends to stick to the underside of the mower, thus preventing proper discharge of grass clippings. If wet grass must be cut, reduce walking speed to help distribute the clippings more effectively.

New grass should be treated as wet grass, otherwise a normal walking speed is about the right pace for efficient mowing.

The best mowing pattern is one that allows the clippings to discharge towards the uncut part of the lawn. This permits recutting of the clippings to further pulverize them. When cutting high weeds, discharge towards cut portion then recut at right angles to first direction.

Lawn should be cut in the fall as long as there is growth.

## OFF-SEASON STORAGE

The following steps should be taken to prepare lawn mower for storage.

1. Clean and lubricate mower thoroughly as described in the preceding instructions.
2. Refer to Engine Manual for correct engine storage instructions.
3. Coat mower's cutting blade with chassis grease to prevent rusting.
4. Place blocks under deck to raise tires clear of floor.
5. Store mower in a dry, clean area.

 **NOTE**

The use of any accessory on this Rotary Mower other than those manufactured by the mower manufacturer is **not** recommended.

GRASS CATCHER Model No. 191-003A is available as optional equipment for the mowers shown in this manual.



1. The mower should not be operated without the entire grass catcher or chute deflector in place.
2. The mower should not be operated without the protective shield on the rear of the deck in place.

 **NOTE**

Under normal usage bag material is subject to wear and should be checked periodically. Be sure any replacement bag complies with the mower manufacturer's recommendations.

For replacement bags, use only factory authorized replacement bag No. 764-0176.

111-020A  
111-021A  
111-020-300  
111-021-300

IF YOU WRITE TO US ABOUT THIS ARTICLE  
OR IF YOU ORDER REPLACEMENT PARTS AL-  
WAYS MENTION THIS MODEL & SERIAL NO  
MODEL

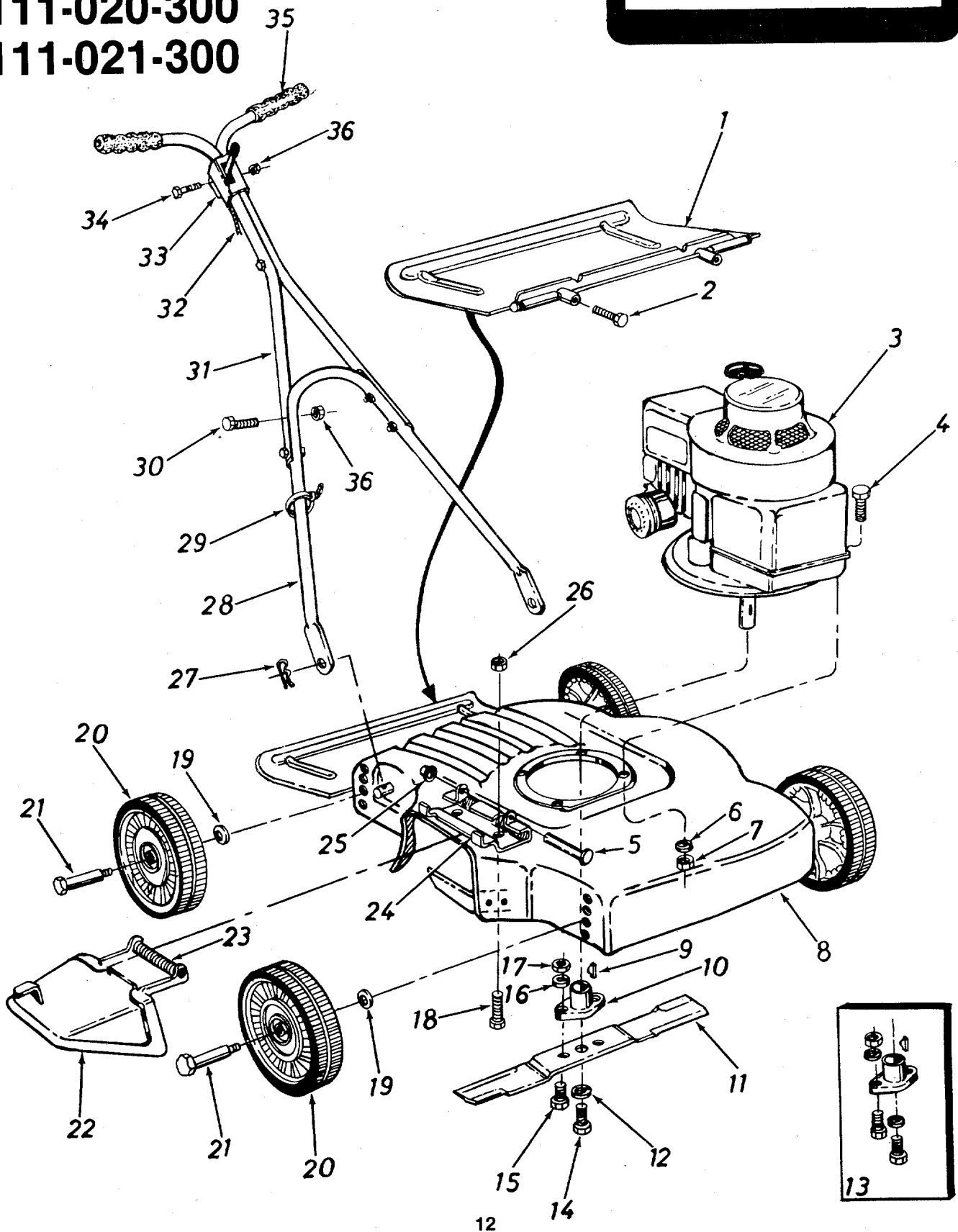

# 111-020A

# 111-021A

# 111-020-300

# 111-021-300

## PARTS LIST FOR MODELS 111-020A AND 111-021A

REF. NO.	PART NO.	COLOR CODE	DESCRIPTION	NEW PART
1	11190	—456	Protective Shield Ass'y. Comp.	
2	710-0567		Hex Scr. ¼-28 x .62" Lg.	
3	4 Cycle		Engine	
4	710-0158		Hex Scr. 5/16-24 x 1¼" Lg.*	
5	711-0555		Pivot Pin	
6	736-0119		L-Wash. 5/16" Scr.*	
7	712-0123		Hex Nut 5/16-24 Thd.*	
8	11402	—456	Deck Ass'y.—Complete	
9	714-0365		#6 Hi-Pro Key 5/32 x 5/8" Dia.	
10	10769		Blade Adapter Kit	
11	742-0121		18 Inch Blade	
12	736-0217		L-Wash. 3/8" Scr. H.D.	
13	10769		Blade Adapter Kit	
14	710-0459		Hex Scr. 3/8-24 x 1½" Lg.	
15	710-0117		Hex Scr. 5/16-24 x 1" Lg.	
16	736-0119		L-Wash. 5/16" Scr.	
17	712-0123		Hex Nut 5/16-24 Thd.*	
18	710-0289		Hex Scr. ¼-20 x .50" Lg.*	
19	736-0105		Bell. Wash. 3/8" Scr.	
20	734-0839		Wheel Ass'y.—Complete	
21	738-0213		Axle Bolt	
22	11681	—456	Chute Deflector Ass'y.	
23	732-0253		Torsion Spring	
24	11130	—456	Adapter Plate	
25	726-0106		Push-On Flange Palnut	
26	712-0107		Hex Cent. L-Nut ¼-20 Thd.	
27	714-0104		Hairpin Cotter	
28	749-0386		Lower Handle	
29	726-0188		Cable Tie	
30	710-0606		Hex Scr. ¼-20 x 1.50" Lg.*	
31	749-0111		Upper Handle (2 Req'd.)	
32	746-0228		Conduit and Wire	
33	746-0200		Throttle Control Ass'y. Comp.	
34	710-0136		Hex Scr. ¼-20 x 1.75" Lg.*	
35	720-0157		Grip	
36	712-0107		Hex Cent. L-Nut ¼-20 Thd.	

\*For faster service obtain standard nuts, bolts and washers locally. If these items cannot be obtained locally, order by part number and size as shown on parts list.

(456—Radiant Tangerine) When ordering parts if color or finish is important, use the appropriate color code shown at left. (e.g. Radiant Tangerine Finish—11402 (456).)



### NOTE

This instruction manual covers various models and all specifications shown do not necessarily apply to your model. Specifications subject to change without notice or obligation.

NOTE: The engine is not under warranty by the mower manufacturer . . . If repairs or service is needed on the engine, please contact your nearest authorized engine service outlet. Check the "Yellow Pages" of your telephone book under "Engines—Gasoline."

**Find It Fast  
In The  
Yellow Pages**

# PARTS INFORMATION

## POWER EQUIPMENT PARTS AND SERVICE

Parts and service for all MTD manufactured power equipment are available through the authorized service firms listed below. All orders should specify the model number of your unit, part numbers, description of parts and the quantity of each part required.

**NOTE:** If any parts are found to be missing or defective upon assembly of this unit, write to advise the factory so that immediate replacement can be made.

<b>ALABAMA</b>	<b>BIRMINGHAM</b>	
Auto Electric & Carburetor Co. . . . .	2625 4th Ave. S. . . . .	35233
<b>ARKANSAS</b>	<b>FORT SMITH</b>	
Mity Mite Motors, Inc. . . . .	4515 S. 16th St. . . . .	72901
	<b>NORTH LITTLE ROCK</b>	
Sutton's Lawn Mower Shop . . . . .	Rt. 4, Box 368 . . . . .	72117
<b>CALIFORNIA</b>	<b>PORTERVILLE</b>	
Billious . . . . .	75 North D Street . . . . .	93257
	<b>SAN FRANCISCO</b>	
J.W. Jewett Co. . . . .	981 Folsom St. . . . .	94107
<b>COLORADO</b>	<b>DENVER</b>	
Colorado Outdoor Power Equip. . . . .	527 West Evans . . . . .	80223
<b>FLORIDA</b>	<b>JACKSONVILLE</b>	
Radco Distributors . . . . .	4909 Victor St. Box 5459 . . . . .	32207
	<b>OPA LOCKA</b>	
Small Eng. Dist. . . . .	2351 N.W. 147th St. . . . .	33054
<b>GEORGIA</b>	<b>EAST POINT</b>	
East Point Cycle & Key . . . . .	2834 Church St. . . . .	30344
<b>ILLINOIS</b>	<b>LYONS</b>	
Keen Edge Co. . . . .	8615 Ogden Ave. . . . .	60534
<b>INDIANA</b>	<b>ELKHART</b>	
Parts & Sales Inc. . . . .	2101 Industrial Pkwy. . . . .	46514
<b>IOWA</b>	<b>DUBUQUE</b>	
Power Lawn & Garden Equip. . . . .	2551 J.F. Kennedy . . . . .	52001
<b>LOUISIANA</b>	<b>NEW ORLEANS</b>	
Suhren Engine Co. . . . .	8330 Earhart Blvd. . . . .	70118
<b>MARYLAND</b>	<b>TAKOMA PARK</b>	
Center Supply Co. . . . .	6867 New Hampshire Ave. . . . .	20012
<b>MASSACHUSETTS</b>	<b>SPRINGFIELD</b>	
Morton B. Collins Co. . . . .	300 Birnie Ave. . . . .	01107
<b>MICHIGAN</b>	<b>LANSING</b>	
Lorenz Service Co. . . . .	2500 S. Pennsylvania . . . . .	48910
	<b>MOUNT CLEMENS</b>	
Power Equipment Dist. . . . .	36463 South Gratiot . . . . .	48043
<b>MINNESOTA</b>	<b>HOPKINS</b>	
Hance Distributing Inc. . . . .	420 Excelsior Ave. W. . . . .	55343
<b>MISSISSIPPI</b>	<b>BILOXI</b>	
Biloxi Sales & Service, Inc. . . . .	506 Caillavet St. . . . .	39533
<b>MISSOURI</b>	<b>KANSAS CITY</b>	
Automotive Equip. Service . . . . .	3117 Holmes St. . . . .	64109
	<b>ST. JOSEPH</b>	
Ross-Frazier Supply Co. . . . .	8th and Monterey . . . . .	64503
	<b>ST. LOUIS</b>	
Henzler, Inc. . . . .	2015 Lemay Ferry Road . . . . .	63125
<b>NEW JERSEY</b>	<b>BELLMAWR</b>	
Lawnmower Parts Inc. . . . .	717 Creek Rd. . . . .	08030
	<b>RUTHERFORD</b>	
Feld Distributor . . . . .	28 Glen Rd. . . . .	07070
<b>NEW YORK</b>	<b>CARTHAGE</b>	
Gamble Dist., Inc. . . . .	West End Ave. . . . .	13619

## BRIGGS AND STRATTON, TECUMSEH AND PEERLESS PARTS AND SERVICE

Briggs & Stratton, Tecumseh and Peerless parts and service should be handled by your nearest authorized engine service firm. Check the yellow pages of your telephone directory under the listing **Engines—Gasoline**, Briggs & Stratton or Tecumseh Lauson.

<b>NORTH CAROLINA</b>	<b>GOLDSBORO</b>	
Smith Hardware Co. . . . .	515 N. George St. . . . .	27530
	<b>GREENSBORO</b>	
Dixie Sales Company . . . . .	335 N. Green . . . . .	27402
<b>OHIO</b>	<b>CARROLL</b>	
Stebe's Mid-State Mower Supply . . . . .	Box 366, 71 High St. . . . .	43112
	<b>CLEVELAND</b>	
Bleckrie, Inc. . . . .	7900 Lorain Ave. . . . .	44102
	<b>WADSWORTH</b>	
National Central . . . . .	687 Seville Rd. . . . .	44281
	<b>YOUNGSTOWN</b>	
Burton Supply Co. . . . .	1301 Logan Ave. Box 929 . . . . .	44501
<b>OKLAHOMA</b>	<b>MUSKOGEE</b>	
Victory Motors, Inc. . . . .	605 S. Cherokee . . . . .	74401
	<b>OKLAHOMA CITY</b>	
Forest Sales Inc. . . . .	6415 N. Olie . . . . .	73116
<b>OREGON</b>	<b>PORTLAND</b>	
Kenton Supply Co. . . . .	8216 N. Denver Ave. . . . .	97217
<b>PENNSYLVANIA</b>	<b>CHESTER</b>	
Stull Equipment Corp. . . . .	742 W. Front St. . . . .	19013
	<b>HARRISBURG</b>	
EECO Inc. . . . .	4021 N. 6th St. . . . .	17110
	<b>PHILADELPHIA</b>	
Thompson Rubber Co. . . . .	5222-24 N. Fifth St. . . . .	19120
	<b>PITTSBURGH</b>	
Bluemont Co. . . . .	11125 Frankstown Rd. . . . .	15235
	<b>PUNXSUTAWNEY</b>	
Frank Roberts & Sons . . . . .	R.D. 2 . . . . .	15767
<b>TENNESSEE</b>	<b>KNOXVILLE</b>	
Master Repair Service . . . . .	2000 Western Ave. . . . .	37921
	<b>MEMPHIS</b>	
American Sales & Service, Inc. . . . .	1922 Lynnbrook . . . . .	38116
<b>TEXAS</b>	<b>DALLAS</b>	
Marr Brothers, Inc. . . . .	423 E. Jefferson . . . . .	75203
	<b>FORT WORTH</b>	
Woodson Sales Corp. . . . .	1702 N. Sylvania . . . . .	76111
	<b>HOUSTON</b>	
Bullard Supply Co. . . . .	2409 Commerce St. . . . .	77003
	<b>SAN ANTONIO</b>	
Catto & Putty, Inc. . . . .	414 Live Oak . . . . .	78298
<b>UTAH</b>	<b>SALT LAKE CITY</b>	
A-1 Engine & Mower Co. . . . .	437 E. 9th St. . . . .	84111
<b>VERMONT</b>	<b>BURLINGTON</b>	
Vermont Hdwe. Co. Inc. . . . .	180 Flynn Ave. . . . .	05401
<b>VIRGINIA</b>	<b>RICHMOND</b>	
RBI Corp. . . . .	963 Myers St. . . . .	23260
<b>WASHINGTON</b>	<b>SEATTLE</b>	
Bailey's Inc. . . . .	1414 14th Ave. . . . .	98102
<b>WEST VIRGINIA</b>	<b>CHARLESTON</b>	
Young's, Inc. . . . .	233 Virginia St., E. . . . .	25301
<b>WISCONSIN</b>	<b>MARSHFIELD</b>	
Power Pac . . . . .	301 E. 29th St. . . . .	54449

## WARRANTY PARTS AND SERVICE POLICY

The purpose of warranty is to protect the customer from defects in workmanship and materials, defects which are NOT detected at the time of manufacture. It does not provide for the unlimited and unrestricted replacement of parts. Use and maintenance are the responsibility of the customer. The manufacturer cannot assume responsibility for conditions over which it has no control. Simply put, if it's the manufacturer's fault, it's the manufacturer's responsibility; if it's the customer's fault, it's the customer's responsibility.

### CLAIMS AGAINST THE MANUFACTURER'S WARRANTY INCLUDES:

1. Replacement of Missing Parts on new equipment.
2. Replacement of Defective Parts within the warranty period.
3. Repair of Defects within the warranty period.

All claims MUST be substantiated with the following information:

1. Model Number of unit involved.
2. Date unit was purchased or first put into service.
3. Date of failure.
4. Nature of failure.

**MTD PRODUCTS • 5965 GRAFTON ROAD • P.O. BOX 36900 • CLEVELAND, OHIO 44136**



## Free Manuals Download Website

<http://myh66.com>

<http://usermanuals.us>

<http://www.somanuals.com>

<http://www.4manuals.cc>

<http://www.manual-lib.com>

<http://www.404manual.com>

<http://www.luxmanual.com>

<http://aubethermostatmanual.com>

Golf course search by state

<http://golfingnear.com>

Email search by domain

<http://emailbydomain.com>

Auto manuals search

<http://auto.somanuals.com>

TV manuals search

<http://tv.somanuals.com>