

OWNER'S MANUAL

21" ELECTRIC START SELF- PROPELLED ROTARY MOWER

Model Number
123-296A
82-0632

Important:
Read Safety Rules and
Instructions Carefully

Thank you for purchasing an
American built product.

INDEX

Safe Operation Practices	3	Maintenance	13
Assembly	4	Off-Season Storage	16
Controls	9	Illustrated Parts	18, 21
Operation	9	Repair Parts Lists	19, 20, 21
Adjustments	11	Electrical Diagram	22
Lubrication	12	Parts Information	Back Cover

LIMITED WARRANTY

For one year from the date of original retail purchase, MTD PRODUCTS INC will either repair or replace, at its option, free of charge, F.O.B. factory or authorized service firm, any part or parts found to be defective in material or workmanship. Transportation charges for the movement of any power equipment unit or attachment are the responsibility of the purchaser. Transportation charges for any parts submitted for replacement under this warranty must be paid by the purchaser unless such return is requested by MTD PRODUCTS INC.

This warranty will not apply to any part which has become inoperative due to misuse, excessive use, accident, neglect, improper maintenance, alterations, or unless the unit has been operated and maintained in accordance with the instructions furnished. This warranty does not apply to the engine, motor, battery, battery charger or component parts thereof. Please refer to the applicable manufacturer's warranty on these items.

This warranty will not apply where the unit has been used commercially.

Warranty service is available through your local authorized service dealer or distributor. If you do not know the dealer or distributor in your area, please write to the Customer Service Department of MTD.

The return of a complete unit will not be accepted by the factory unless prior written permission has been extended by MTD.

This warranty gives you specific legal rights. You may also have other rights which vary from state to state.



WARNING

This unit is equipped with an internal combustion engine and should not be used on or near any unimproved forest-covered, brush-covered or grass-covered land unless the engine's exhaust system is equipped with a spark arrester meeting applicable local or state laws (if any). If a spark arrester is used, it should be maintained in effective working order by the operator.

In the State of California the above is required by law (Section 4442 of the California Public Resources Code). Other states may have similar laws. Federal laws apply on federal lands. A spark arrester muffler is available at your nearest engine authorized service center.



To reduce the potential for any injury, comply with the following safety instructions. Failure to comply with the instructions may result in personal injury.

SAFE OPERATION PRACTICES FOR WALK-BEHIND MOWERS

TRAINING

1. Read this owner's manual carefully in its entirety before attempting to assemble or operate this machine. Be completely familiar with the controls and the proper use of this machine before operating it. Keep this manual in a safe place for future and regular reference and for ordering replacement parts.
2. Your rotary mower is a precision piece of power equipment, not a plaything. Therefore, exercise extreme caution at all times.
3. Never allow children to operate a power mower. Only persons well acquainted with these rules of safe operation should be allowed to use your mower.
4. Keep the area of operation clear of all persons, particularly small children and pets. Stop engine when they are in the vicinity of your mower. Although the area of operation should be completely cleared of foreign objects, an object may have been overlooked and could be accidentally thrown by the mower in any direction and cause serious personal injury to the operator or any others allowed in the area.

PREPARATION

1. Thoroughly inspect the area where the equipment is to be used. Remove all stones, sticks, wire, bones and other foreign objects which could be picked up and thrown by the mower in any direction and cause serious personal injury to the operator or any others allowed in the area.
2. Do not operate equipment when barefoot or wearing open sandals. Always wear substantial footwear.
3. Do not wear loose fitting clothing that could get caught on the mower.
4. Check the fuel before starting the engine. Gasoline is an extremely flammable fuel. Do not fill the gasoline tank indoors, while the engine is running, or while the engine is still hot. Wipe off any spilled gasoline before starting the engine as it may cause a fire or explosion.
5. Disengage the self-propelled mechanism or drive clutch on units so equipped before starting the engine.
6. The blade control handle is a safety device. Never attempt to bypass its operation. Doing so makes the safety device inoperative and may result in personal injury through contact with the rotating blade. The blade control handle must operate easily in both directions.
7. Never attempt to make a wheel or cutting height adjustment while the engine is running.
8. Mow only in daylight or in good artificial light.
9. Never operate the equipment in wet grass. Always be sure of your footing. A slip and fall can cause serious personal injury. Keep a firm hold on the handle and walk, never run.

OPERATION

1. Do not change the engine governor settings or overspeed the engine. Excessive engine speeds are dangerous.
2. Do not put hands or feet near or under rotating parts. Keep clear of the discharge opening at all times as the rotating blade can cause injury.
3. Stop the blade when crossing gravel drives, walks or roads.
4. After striking a foreign object, stop the engine, remove the wire from the spark plug, and thoroughly inspect the mower for any damage. Repair the damage before restarting and operating the mower.
5. If the equipment should start to vibrate abnormally, stop the engine and check immediately for the cause. Vibration is generally a warning of trouble.
6. Shut the engine off and wait until the blade comes to a complete stop before removing the grass catcher or unclogging the chute. The cutting blade continues to rotate for a few seconds after the engine is shut off. Never place any part of the body in the blade area until you are sure the blade has stopped rotating.
7. Before cleaning, repairing or inspecting, make certain the blade and all moving parts have stopped. Disconnect the spark plug wire, and keep the wire away from the spark plug to prevent accidental starting.
8. Do not run the engine indoors.
9. Mow across the face of slopes, never up-and-down. Exercise extreme caution when changing direction on slopes. Do not mow excessively steep slopes. Always be sure of your footing. A slip and fall can cause serious personal injury.
10. Always disconnect electric mowers (line operated) before cleaning, repairing or adjusting.
11. Never operate mower without proper guards, plates or other safety protective devices in place.

MAINTENANCE AND STORAGE

1. Check the blade and engine mounting bolts at frequent intervals for proper tightness.
2. Keep all nuts, bolts, and screws tight to be sure the equipment is in safe working condition.
3. Never store the equipment with gasoline in the tank inside of a building where fumes may reach an open flame or spark. Allow the engine to cool before storing in any enclosure.
4. To reduce fire hazard, keep the engine free of grass, leaves, or excessive grease.
5. Check the grass catcher bag frequently for wear or deterioration. For safety protection, replace only with new bag meeting original equipment specifications.

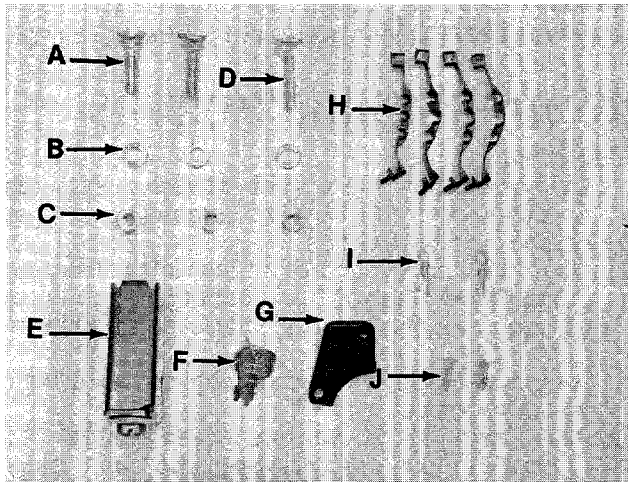

FIGURE 1.

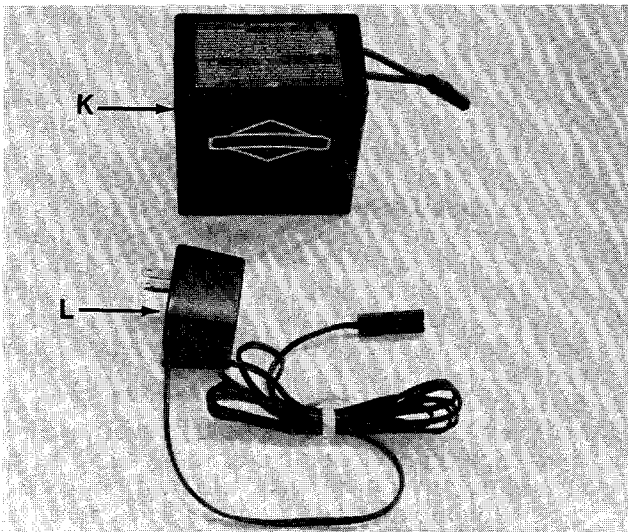

FIGURE 2.

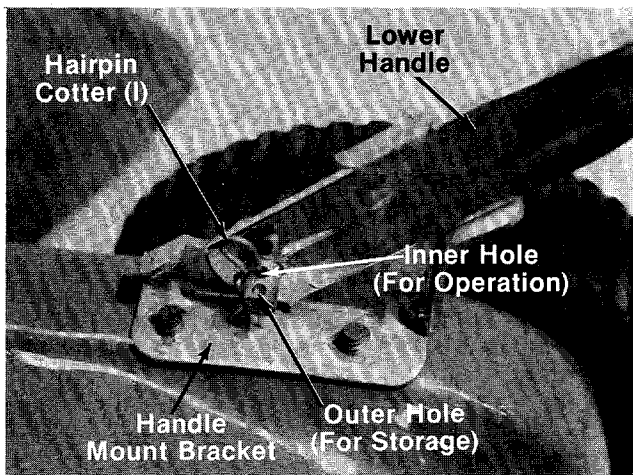

FIGURE 3.

ASSEMBLY



This unit is shipped WITHOUT GASOLINE or OIL. After assembly, see separate engine manual for proper fuel and engine oil recommendations.

← Contents of Hardware Pack: (See Figure 1)

- A (2) Curved Head Carriage Bolts 1.38" Long
- B (3) Lock Washers 5/16" I.D.
- C (3) Hex Nuts 5/16-18 Thread
- D (1) Carriage Bolt 1.25" Long
- E (1) Ignition Switch Bracket
- F (2) Ignition Keys
- G (1) Plastic Cap
- H (4) Cable Ties
- I (2) Hairpin Cotters
- J (2) Phillips Head Screws

← Loose Parts in Carton: (See Figure 2)

- K (1) Battery
- L (1) Battery Charger
- M (1) Upper Handle (Not Shown)
- N (1) Lower Handle (Not Shown)

1. Remove the lawn mower, loose parts, hardware pack and literature from the carton. Make certain all parts and literature have been removed before the carton is discarded.
2. Extend all control cables and place on the floor. Be careful not to bend or kink control cables.
3. Place lower handle in position over weld pins in handle mount brackets on deck. Make certain the instruction label on the lower handle can be read from the operating position. Secure by placing two hairpin cotters (I) in inner hole on weld pins. See figure 3.



It may be necessary to bend the ends of the lower handle outward slightly to obtain a snug fit against the bracket.



There are two (2) holes in the handle mount brackets. Place hairpin cotter in the inner hole for operation. The outer hole is for storage.

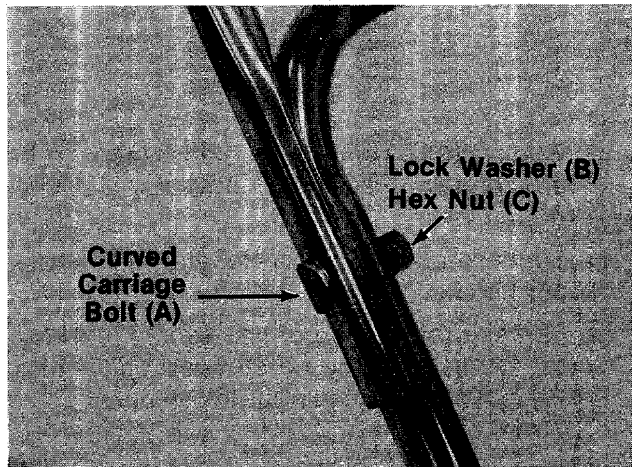

FIGURE 4.

4. Place upper handle in position over lower handle. Control housing should be on the **right** side of the handle. Secure upper handle with two curved head carriage bolts (A), lock washers (B) and hex nuts (C). See figure 4.



Reference to left or right side of machine is determined from operator's position at the handle facing forward.

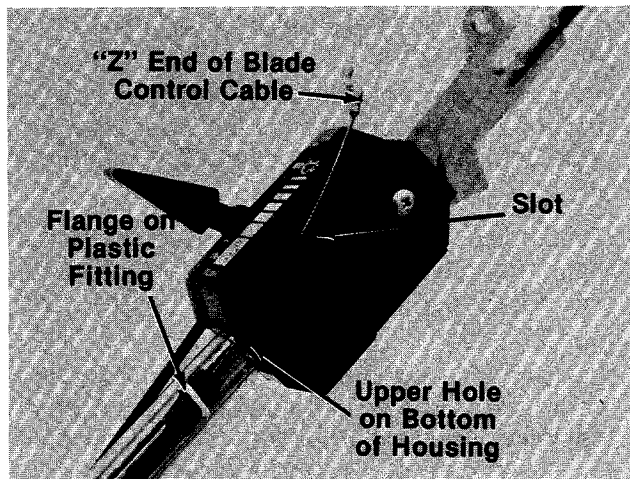

FIGURE 5.

5. The blade control cable is the cable which has a "Z" fitting on the loose end, and is attached to the engine.

Route the control cables under the lower handle. Place the end of the blade control cable into the upper hole on the bottom of the control housing, and through the slot as shown in figure 5. The angle of the flange on the plastic fitting must be positioned as shown. Be careful not to bend or kink the cable.

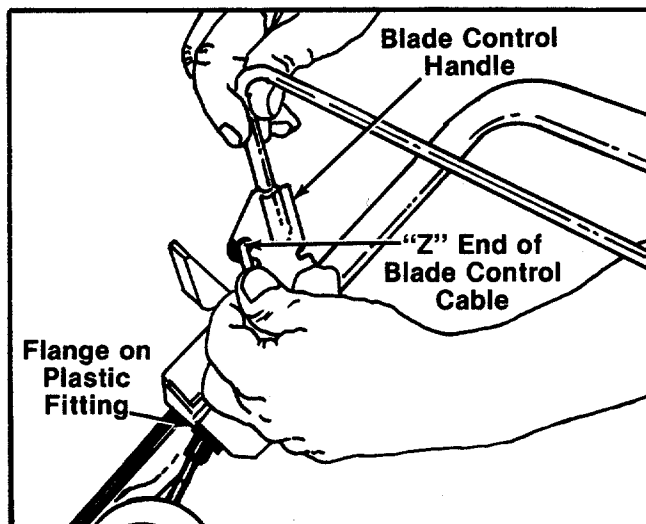

FIGURE 6.

6. Snap the plastic fitting on the end of the cable into the control housing.

7. Hook the "Z" end of the blade control cable into blade control handle. See figure 6. If additional slack is needed in order to hook the cable into the handle proceed as follows:

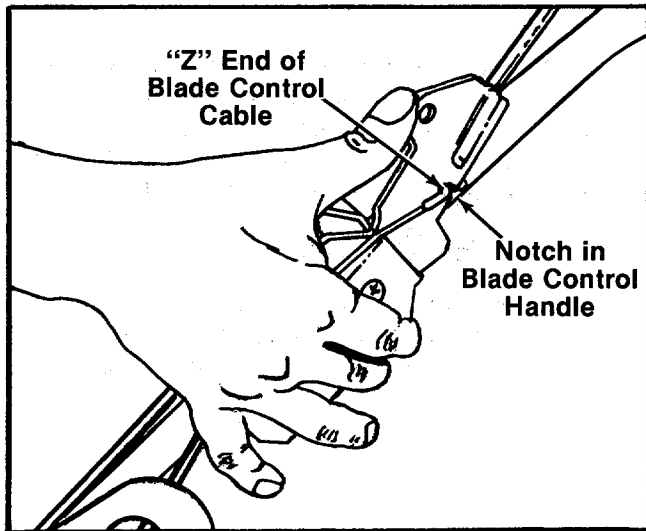

FIGURE 7.

- a. Hook the "Z" end of the cable into notch provided in the blade control handle. See figure 7.
- b. Squeeze blade control handle against upper handle.
- c. Release the blade control handle, unhook the cable from the notch and hook it into the hole in the blade control handle.

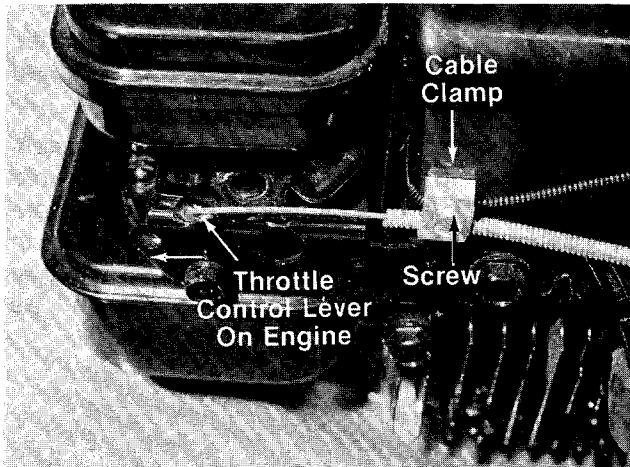

FIGURE 8.

8. If unit is so equipped, remove the dipstick, unsnap the shroud, then replace the dipstick.
9. Place the throttle control lever on the handle in "Fast" position.
10. Push the throttle control lever on the engine to the full open position (as far toward the outside of the unit as it will go) as shown in figure 8.
11. The throttle control cable is attached to the upper handle. Hook the "Z" end of the throttle control cable into the hole in the control lever on the engine.
12. Loosen (do not remove) the screw on the cable clamp shown in figure 8. Slip the control casing under the clamp. With the throttle lever on the engine still in the full open position, tighten the screw to secure the throttle control cable.

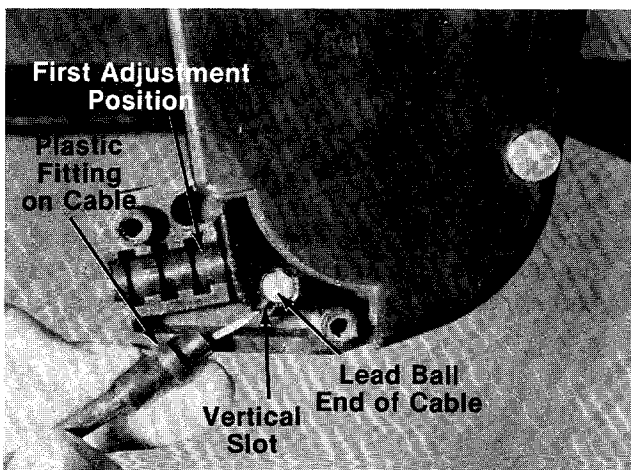
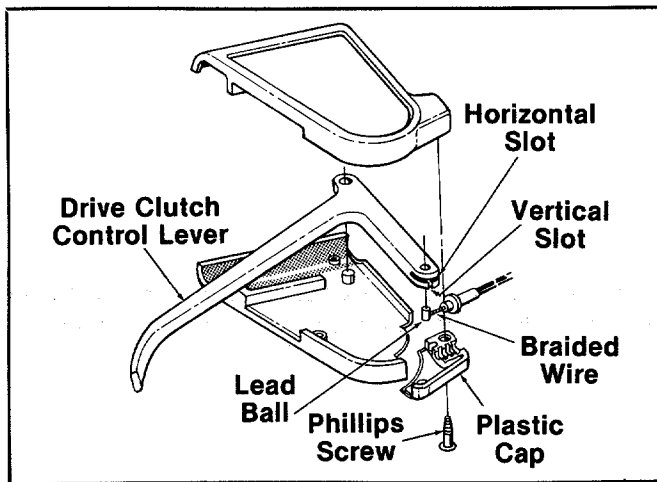

FIGURE 9.

13. The drive clutch control cable is attached to the deck. Attach the other end of the drive clutch control cable to the clutch control housing on the upper handle as follows. Place the lead ball end of the cable into the fitting provided in the end of the clutch control lever. Slip the braided wire into the vertical slot as shown in figure 9.
14. Slide the braided wire around in the horizontal slot. See figure 10.
15. Place the plastic fitting on the control cable into the first adjustment position on the clutch control housing. See figure 9.



16. Place the plastic cap (G) in position beneath the clutch control housing. Secure with the two Phillips head screws. See figure 10.



Drive clutch adjustment must be checked before the unit is operated, as described in the operation section.

FIGURE 10.

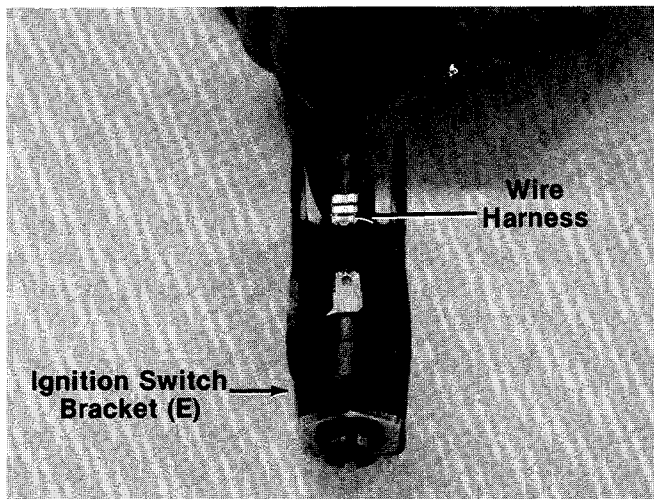

17. Plug the two ends on the wire harness (already attached to the engine) into the terminals on the ignition switch bracket (E). See figure 11.

FIGURE 11.

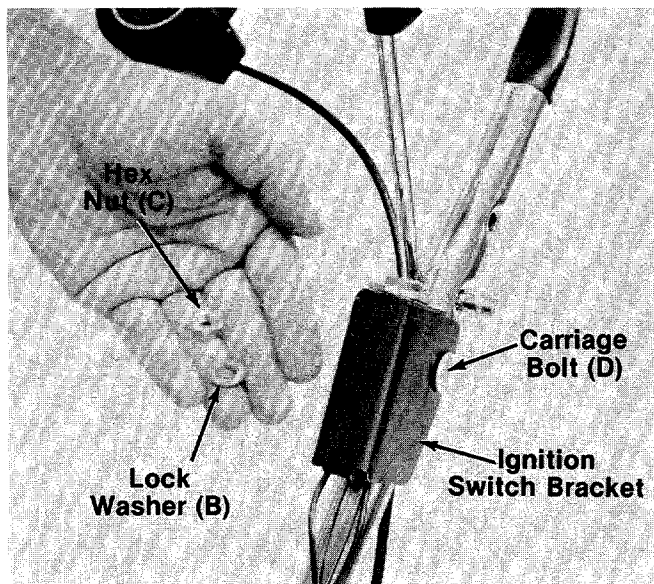

18. Place ignition switch bracket in position on left side of upper handle as shown in figure 12. Secure with carriage bolt (D), lock washer (B) and hex nut (C).

FIGURE 12.

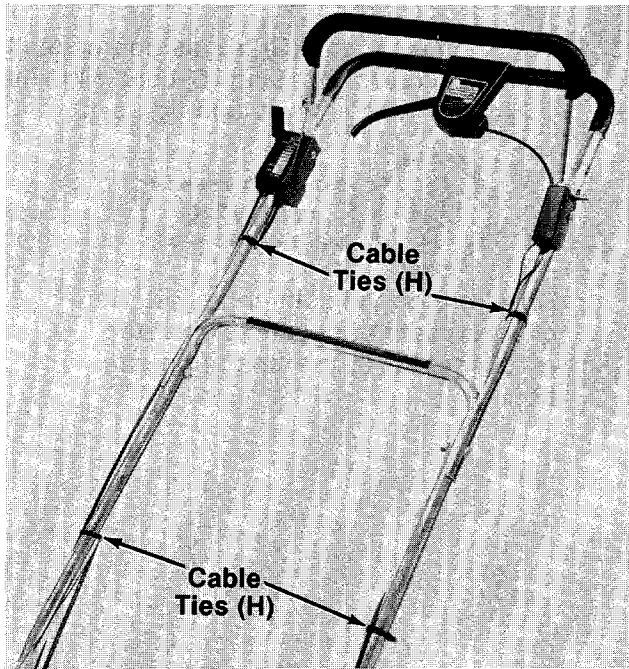

FIGURE 13.

19. Secure all control cables to upper and lower handles with cable ties (H). See figure 13.

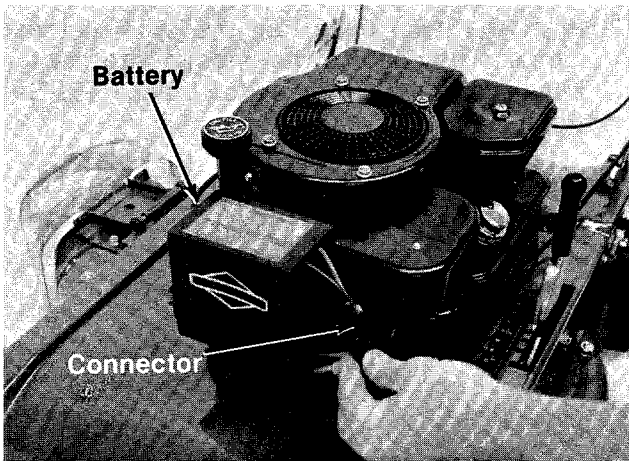

FIGURE 14.

20. The battery is shipped in a partially charged state and must be charged at least 48 hours prior to initial use. Follow charging instructions on page 10.
21. Place the charged battery in position on the battery bracket as shown in figure 14.
22. Plug the connector on the battery into the connector on the wire harness on the mower. See figure 14.
23. If unit is so equipped, remove the dipstick, snap on the shroud and replace the dipstick.

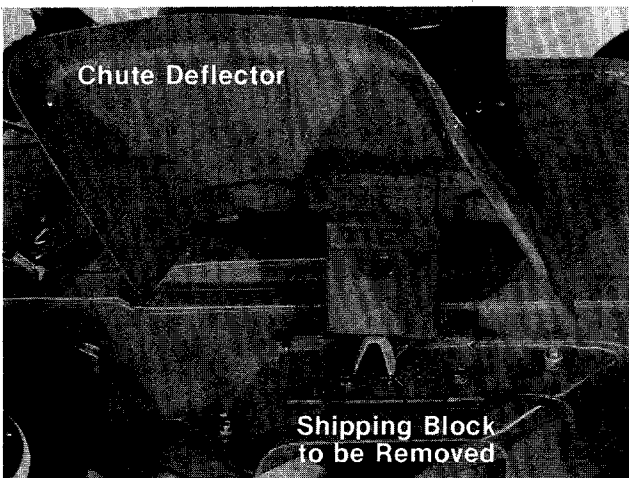

FIGURE 15.



Please note that the chute deflector on your mower is in an upright position. It is held in that position by a shipping block. This block is used for shipping purposes only. It must be removed and discarded before your mower is put into operation. See figure 15.

CONTROLS

THROTTLE CONTROL

The throttle is located on the right side of handle. It controls engine speed. See figure 16.



The throttle control cannot be used to stop the engine.

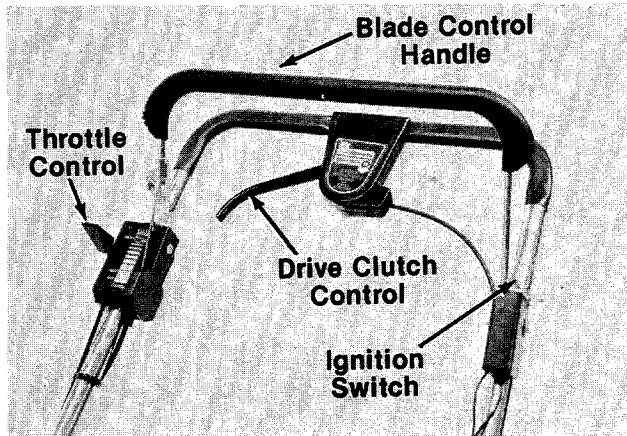

FIGURE 16.

DRIVE CLUTCH CONTROL

Squeezing the drive clutch control engages the drive mechanism to the rear wheels. Releasing the clutch control stops the rear wheels from driving. Release the drive clutch control to slow down when negotiating an obstacle, making a turn or stopping. See figure 16.

BLADE CONTROL HANDLE

WARNING
THIS CONTROL MECHANISM IS A SAFETY DEVICE NEVER ATTEMPT TO BYPASS ITS OPERATIONS

The blade control handle is located on the upper handle of the mower. See figure 16. The blade control handle must be depressed in order to operate the unit. Release the blade control handle to stop the engine and blade.



The blade will be rotating whenever the engine is running.

IGNITION SWITCH

The ignition switch is located on the left side of the handle. It is used for **starting only**. See figure 16.

OPERATION

Caution

Do Not Operate Mower Unless Guard Or Grass Catcher Is In Its Proper Place.



FIGURE 17.

Keep hands and feet away from the chute area on cutting deck. See figure 17.



For shipping purposes your mower is set with the wheels in a low cutting height position. For best results, raise the cutting position until it is determined which height is best for your lawn. See cutting height adjustment.

BEFORE STARTING



The battery contains corrosive fluid and toxic material. **HANDLE WITH CARE.** Keep away from children. Do not puncture, disassemble, mutilate or incinerate. Explosive gases could be vented during charging or discharging. Use in a well-ventilated area, away from sources of ignition.

FIRST AID—If battery liquid comes in contact with skin or clothing, follow these instructions. External Contact: Immediately flush skin or eyes with water for at least 15 minutes. Internal: Drink tap water, milk or milk of magnesia. Take egg whites. In case of internal or external contact, call a physician immediately.

1. Charge battery for 48 hours before initial use. Thereafter, charge battery for a minimum of 24 hours and a maximum of 72 hours whenever necessary. For best results, charge the battery within the temperature limits of 40°F to 105°F.



CAUTION

This is a **6 volt** electrical system. Use only the battery charger supplied with this unit.

To charge the battery, proceed as follows. See figure 18.

Always plug charger lead into battery before inserting battery charger plug into 120 volt standard household outlet.

After charging, disconnect battery charger plug from household outlet first, then disconnect charger lead from battery.

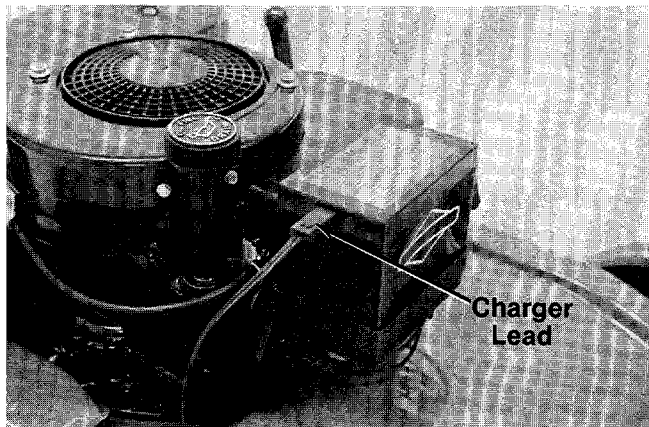

FIGURE 18.

2. Fill sump with oil as instructed in the separate engine manual packed with your unit.
3. Fill fuel tank, using clean, fresh, lead-free, low-lead or regular grade leaded gasoline. Fill tank completely!
DO NOT MIX OIL WITH GASOLINE.
4. Attach spark plug wire to spark plug.
5. Before each use, check for proper drive clutch operation by performing the following before starting the engine:

With the drive clutch control released, push mower forward. It should move freely. Pull mower backward. It should move freely.

With the drive clutch control engaged (lever squeezed against upper handle), push mower forward. It should move freely. Pull mower backward. The rear wheels should lock up. If they do not, adjust the clutch control as specified under Drive Clutch Control Adjustment on page 11.

TO START ENGINE AND ENGAGE BLADE



WARNING

When starting the unit for the first time, face the mower against a solid object such as a wall, fence, etc. Start the unit, and if it shows any signs of motion with the drive clutch control disengaged, shut the engine off immediately. Check the position of the drive clutch control cable. The plastic fitting must be assembled in the first adjustment position inside the housing, all the way to the right, as shown in figure 9.

1. Move the throttle control lever to FAST or START position.
2. Standing behind the unit, depress the blade control handle and hold it against the upper handle as shown in figure 19.
3. Turn the ignition key to the right to start the engine. Release the key after engine starts.
4. After engine starts, move throttle control to desired engine speed.

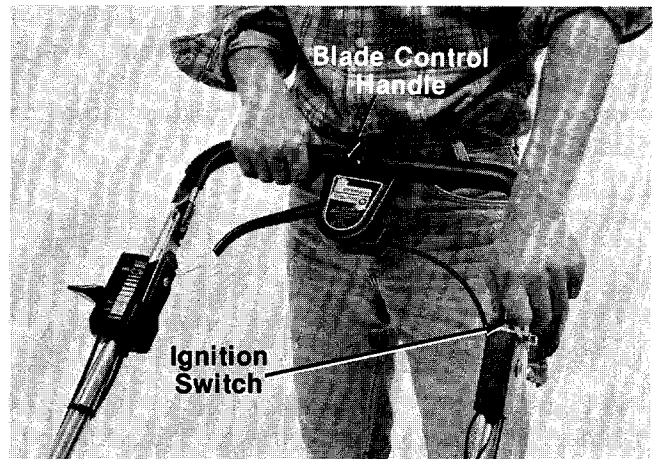

FIGURE 19.

TO STOP ENGINE AND BLADE

1. Release the blade control handle to stop the engine and blade.



WARNING

The blade continues to rotate for a few seconds after the engine is shut off.

2. Disconnect the spark plug wire and ground it against the engine to prevent accidental starting while equipment is unattended.

USING YOUR ROTARY MOWER

Be sure that lawn is clear of stones, sticks, wire, or other objects which could damage lawn mower or engine. Such objects could be accidently thrown by the mower in any direction and cause serious personal injury to the operator and others.

Operate a new engine at intermediate speeds and light load for the first few hours as you would a new automotive engine.

For best results, do not cut wet grass because it tends to stick to the underside of the mower, preventing proper discharge of grass clippings, and could cause you to slip and fall. New grass, thick grass or wet grass may require a narrower cut. Blade speed should be adjusted to the condition of the lawn.

The best mowing pattern is one that allows the clippings to discharge towards the uncut part of the lawn. This permits recutting of the clippings to further pulverize them. When cutting high weeds, discharge towards cut portion, then recut at right angles to first direction.

For best results, cut off one-third or less of the total length of the grass. Lawn should be cut in the fall as long as there is growth.

This mower is designed to be operated at full throttle to give you the best cut and do the most effective job of bagging the cut grass.

➔ IMPORTANT

If you strike a foreign object, stop the engine. Remove wire from spark plug, thoroughly inspect the mower for any damage, and repair the damage before restarting and operating the mower. Extensive vibration of the mower during operation is an indication of damage. The unit should be promptly inspected and repaired.

ADJUSTMENTS



CAUTION

Do not at any time make any adjustment to lawn mower without first stopping engine and disconnecting spark plug wire.

DRIVE CLUTCH CONTROL ADJUSTMENT

If the unit does not self-propel with the drive clutch control engaged, remove the plastic cap from beneath the drive clutch control housing. Move the plastic fitting on the control cable to the next adjustment position on the left. Reassemble the plastic cap and retest. See figure 20.

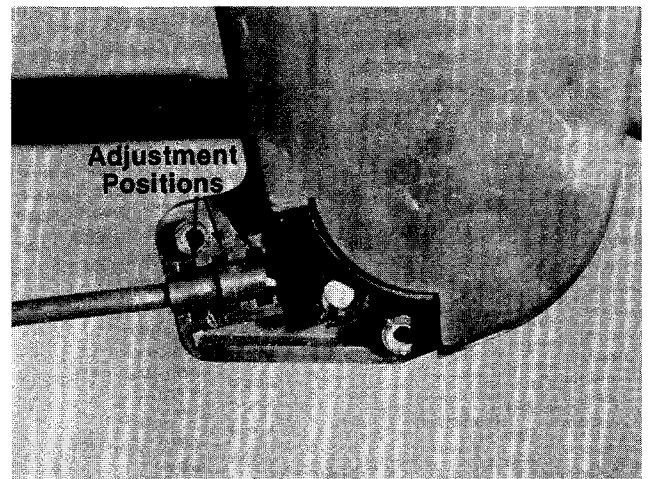

FIGURE 20.

CUTTING HEIGHT ADJUSTMENT

A single lever adjusts all four wheels at one time. Cutting height adjustment is made by moving the height adjustment lever away from the engine and then forward or backward. The lever will lock in one of seven cutting heights, from 1" to 3". See figure 21.

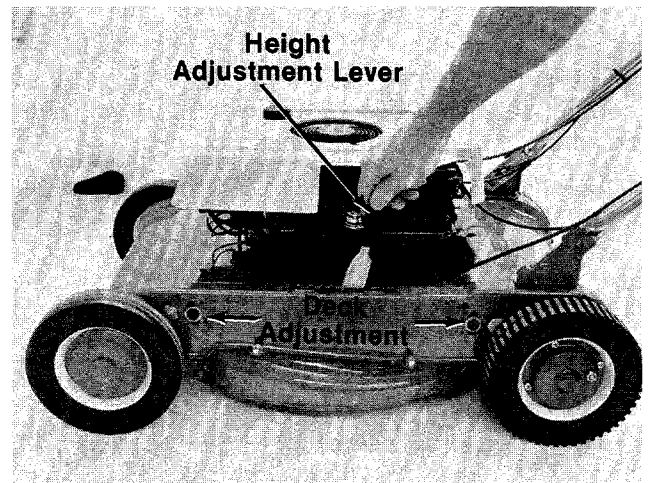

FIGURE 21.

CUTTING DECK ADJUSTMENT

An adjustment is provided on the left side of the upper deck, next to the front and rear wheels, so that an even cut may be obtained. This adjustment compensates for wear or use of the grass catcher. See figure 21.

To level the deck, loosen (do not remove) the self-tapping screw. Depress the pivot bracket so that the tab comes out of the adjustment hole. Pivot the bracket up or down as necessary, selecting one of the five adjustment holes. Release the bracket, and tighten the self-tapping screw securely. Both front and rear brackets should be in the same relative position.

THROTTLE

If adjustment becomes necessary, the throttle control wire assembly can be reset as follows:

1. Loosen, but do not remove, the screw securing throttle control wire assembly at engine. See figure 8.
2. Move throttle control lever on handle to "FAST" position.
3. Move control lever on engine to full open position. Retighten screw to secure throttle control wire assembly.

CARBURETOR ADJUSTMENTS



If any adjustments are made to the engine while the engine is running (e.g. carburetor), disengage all clutches and blades. Keep clear of all moving parts. Be careful of heated surfaces and muffler.

Minor carburetor adjustments may be required to compensate for differences in fuel, temperature, altitude and load.

To adjust carburetor, refer to the separate engine manual packed with your mower.

LUBRICATION



Always stop engine and disconnect spark plug wire before cleaning, lubricating or doing any kind of work on lawn mower.

Blade Control—Lubricate the pivot points on the blade control handle and the cable at least once a season with light oil. The blade control must operate freely in both directions.

Chute Deflector—The torsion spring and pivot point should be lubricated periodically with light oil to prevent any rust or binding. Deflector must work freely.

Wheels—Mower may be provided with ball bearing wheels. Lubricate at least once a season with light oil. Also, if the wheels are removed for any reason, lubricate the surface of the axle bolt and the inner surface of the wheel with light oil. A 4 oz. plastic bottle of light oil lubricant is available. Order part number 737-0170. Engine oil may also be used.

Engine—Follow engine manual for lubrication instructions.

Throttle—Periodically lubricate throttle control lever and throttle wire assembly with a few drops of light oil for ease of operation.

Chain—Periodically lubricate the chain with appropriate chain lubricant. A stiff or rusted chain can be restored by removing the master link, soaking the chain in kerosene or a solvent, letting it air dry and wiping the chain with a rag saturated with lubricant.

If the rotary mower is operated in a sandy area, the chain should not be lubricated with oil. Excessive oil on a chain will collect dirt and cause excessive wear on the chain and sprockets.

Rear Wheel Drive—Both rear wheels are driven by a pawl and ratchet drive. Lubricate the pawl and ratchet once a season with a silicone type lubricant.

Figure 22 shows the right rear hub cap. To take off the rear hub caps, remove the four screws around the edge of the hub cap. A cotter pin holds the ratchet in place. The pawl must pivot freely. Clean with a solvent, replace any broken or worn parts and lubricate.

The pawl and ratchet on the left rear hub cap are assembled facing the opposite way.

After reassembling, test the operation of the drive without the engine running. Engage the clutch and pull the mower backwards. Both wheels should lock. Push the mower forward and both wheels should rotate.



The wheels will "click" when the mower is pushed forward.

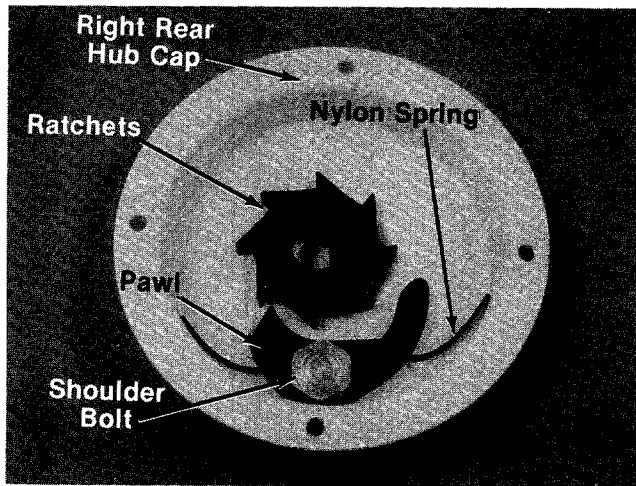

FIGURE 22.

MAINTENANCE



CAUTION
When tipping the unit, empty the fuel tank and keep engine spark plug side up.

CUTTING BLADE

A. Removal for Sharpening or Replacement



Be sure to disconnect and ground the spark plug wire before working on the cutting blade to prevent accidental engine starting.

Remove the large bolt and lock washer which holds the blade and adapter to the engine crankshaft. Remove the blade and adapter from the crankshaft.

If the blade or blade adapter needs replacing, remove the two small bolts, lock washers and nuts which hold the blade to the adapter.



CAUTION
Periodically inspect the blade adapter for cracks, especially if you strike a foreign object. Replace when necessary.

B. Sharpening

Remove the cutting blade by following the directions of the preceding section.

When sharpening the blade, follow the original angle of grind as a guide. It is **extremely important** that each cutting edge receives an equal amount of grinding to prevent an unbalanced blade. An unbalanced blade will cause excessive vibration when rotating at high speeds, may cause damage to the mower and could break, causing personal injury.

It is recommended that the blade always be removed from the adapter for the best test of balance. The blade can be tested by balancing it on a round shaft screwdriver. Remove metal from the heavy side until it balances evenly.

C. Reassembly

Before reassembling the blade and the blade adapter to the unit, lubricate the engine crankshaft and the inner surface of the blade adapter with light oil. Lubricating the bolt holes, bolts and inner surface of the nuts with light oil is also recommended. A 4 oz. plastic bottle of light oil lubricant is available. Order part number 737-0170. Engine oil may also be used.

When replacing the blade, be sure to install the blade with the side of the blade marked "Bottom" (or with part number) facing the ground when the mower is in the operating position.

Blade Mounting Torque

3/8" Dia. Bolt 375 in. lb. min., 450 in. lb. max.
5/16" Dia. Bolt 150 in. lb. min., 250 in. lb. max.

To insure safe operation of your unit, **all** nuts and bolts must be checked periodically for correct tightness.

DECK

The underside of mower deck should be cleaned after each period of use as grass clippings, leaves, dirt and other matter will accumulate. This accumulation of grass clippings, etc., is undesirable as it will invite rust and corrosion and may cause an uneven discharge of grass clippings at the next cutting.

The deck may be cleaned by tilting the mower forward or on its side and scraping clean with a suitable tool or by washing with a stream of water from a garden hose.



CAUTION
Do not direct the stream of water at a hot engine as damage to the engine may result.

ENGINE OIL

Check oil level before starting engine and after every 5 hours of operation. ADD oil as necessary to keep level to full mark on dipstick. Before removing dipstick, clean area around dipstick to prevent dirt from entering oil fill tube. Engine should be in a level position when checking oil.

Change oil after first 5 hours of operation. Thereafter change every 25 hours. Change oil while engine is warm. Oil may be drained thru oil drain on bottom of the engine. Oil capacity 1-1/4 pints.

AIR CLEANER

Service air cleaner every 25 hours under normal conditions. Clean every few hours under extremely dusty conditions. Poor engine performance and flooding usually indicates that the air cleaner should be serviced.

To service the air cleaner, refer to the separate engine manual packed with your unit.

SPARK PLUG

The spark plug should be cleaned and the gap reset once a season. Spark plug replacement is recommended at the start of each mowing season; check engine manual for correct plug type and gap specifications.

STORAGE OF THE BATTERY

The battery must be stored with a full charge. A discharged battery will freeze.



CAUTION

All batteries discharge during storage.

Recharge battery every two months and before returning to service. Refer to charging instructions on page 10.

BELT REPLACEMENT



IMPORTANT

Always stop engine and disconnect spark plug wire before performing any repairs or maintenance on the mower.

1. Place a piece of plastic film under the gasoline cap and tighten it. The plastic prevents gasoline from draining from the air vent in the cap.
2. Tip the mower forward. Place the handle of the mower against a bench so that the bottom of the deck can be reached.
3. Remove the center bolt on the blade and slide off the blade and adapter. See figure 23.

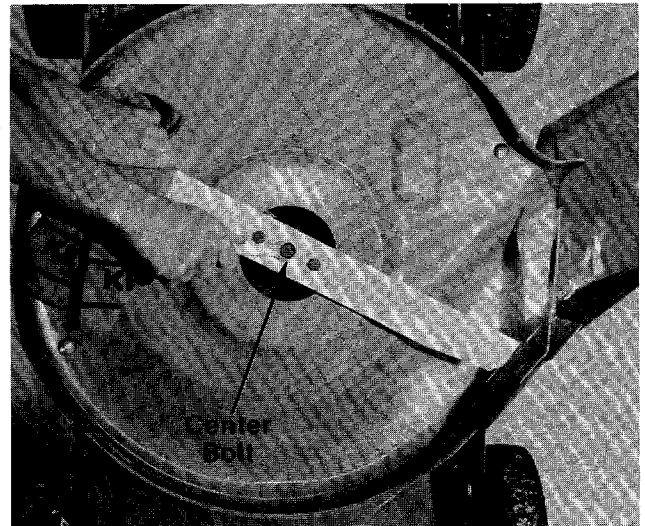

FIGURE 23.

4. Remove the four carriage bolts holding the lower deck to the frame. See figure 24.

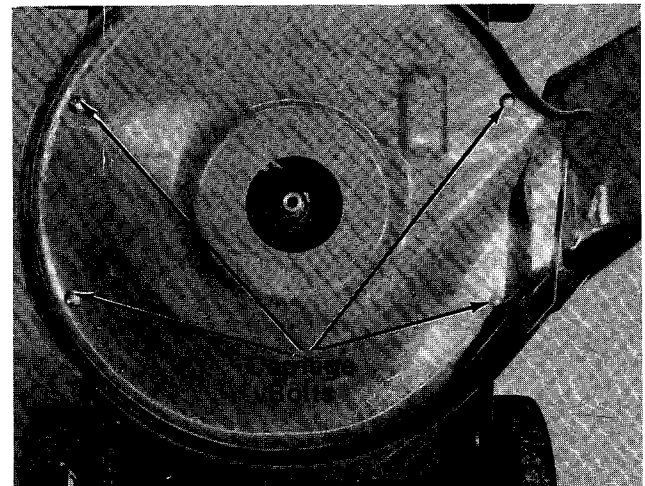

FIGURE 24.

5. Remove the two screws holding the belt guard cover on top of the deck. See figure 25.

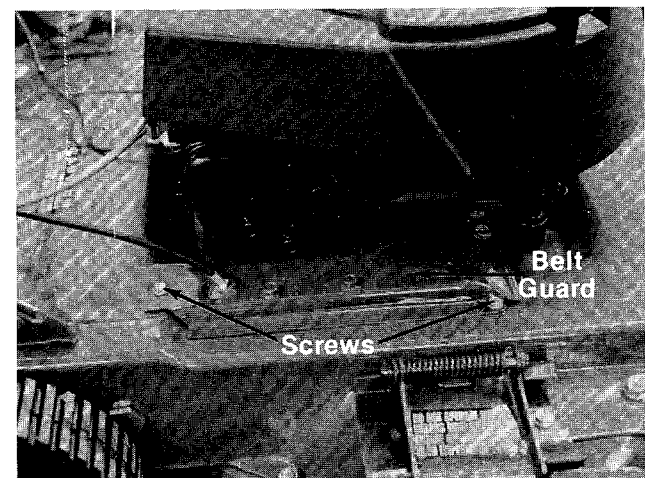

FIGURE 25.

6. Unhook the belt from the idler pulley. See figure 26.

NOTE

When reassembling the idler pulley and belt guard cover, place a wire hook under the belt. Pull up on the hook, and slip the idler pulley under belt. See figure 26.

7. Remove the belt from the engine pulley.

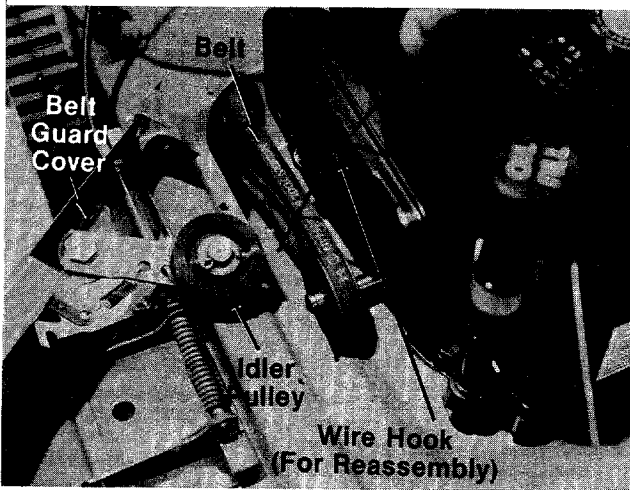

FIGURE 26.

8. Remove both rear wheel hub caps by removing the four screws on each one. See figure 27.

NOTE

Mark the hub caps right and left. They are not interchangeable.

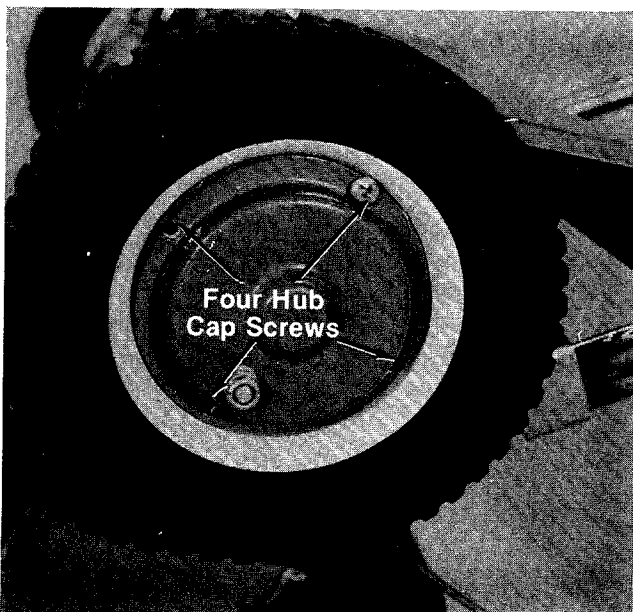

FIGURE 27.

9. Remove the cotter pin on the RIGHT WHEEL ONLY and remove the ratchet. See figure 28.

NOTE

Mark the outside of the ratchet so it is not assembled backwards or refer to figure 28 for reassembly.

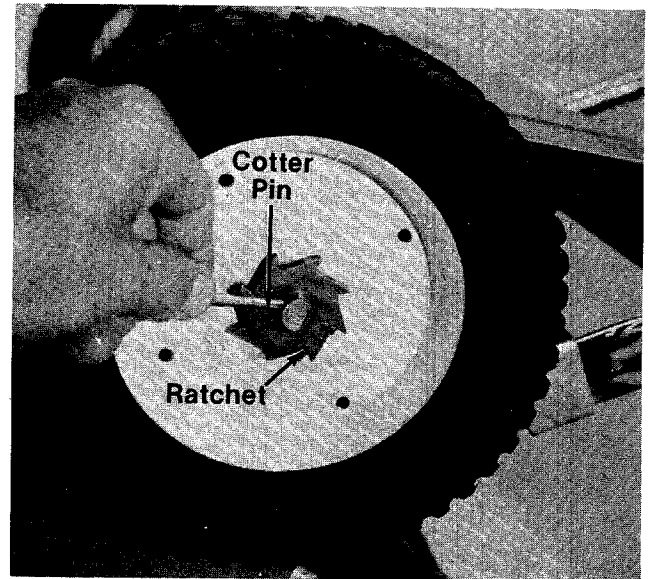

FIGURE 28.

10. Remove the large shoulder bolt and chain master link. See figure 29.

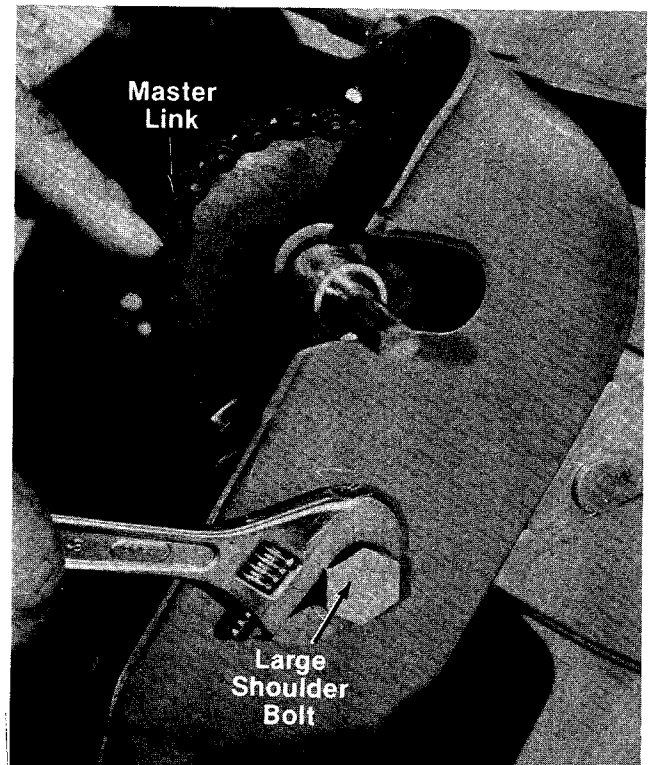

FIGURE 29.

11. Remove the cotter pin next to the bearing by the left wheel and slide the axle to the left. The belt can be removed. See figure 30.

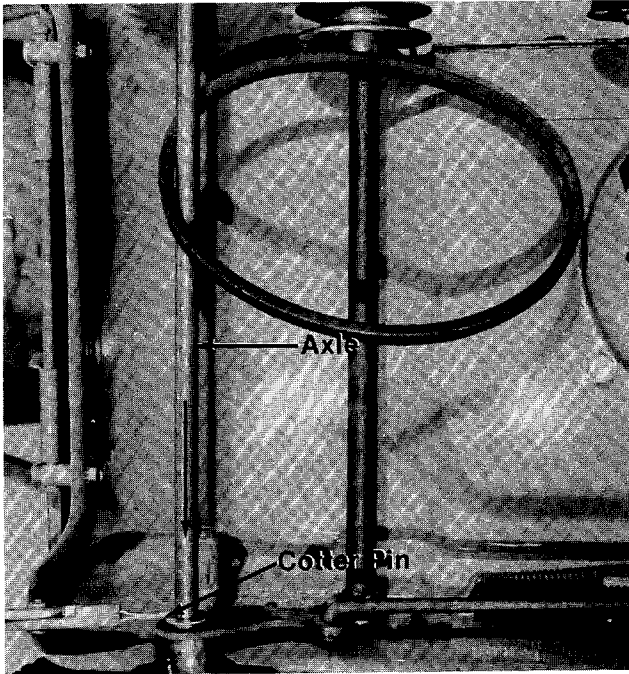

FIGURE 30.

12. Reassemble in reverse order with new belt.

13. Remove plastic film from gas tank cap.

OFF-SEASON STORAGE

The following steps should be taken to prepare lawn mower for storage.

1. Clean and lubricate mower thoroughly as described in the lubrication instructions.
2. Refer to engine manual for correct engine storage instructions.
3. Coat mower's cutting blade with chassis grease to prevent rusting.
4. Store mower in a dry, clean area.
5. Refer to battery storage instructions on page 14.

HANDLE STORAGE

The handle can be stored in an upright position to take less space. Move hairpin cotters to outer hole on weld pins (see figure 3). Grasp the lower handle at the bottom and push inward slightly. Tip the handle forward. It will lock in this position. Reverse this procedure to place the handle in the operating position.

 **NOTE**

The use of any accessory on this Rotary Mower other than those manufactured by the mower manufacturer is **not** recommended.

GRASS CATCHER Model 003 is available as optional equipment for the mower shown in this manual.



WARNING

1. DO NOT operate the mower without the entire grass catcher or chute deflector in place.
2. DO NOT operate the mower without the protective shield on the rear of the deck in place.

 **NOTE**

Under normal usage bag material is subject to wear and should be checked periodically. Be sure any replacement bag complies with the mower manufacturer's recommendations.

For replacement bags, use only factory authorized replacement bag No. 764-0176.

Model 296

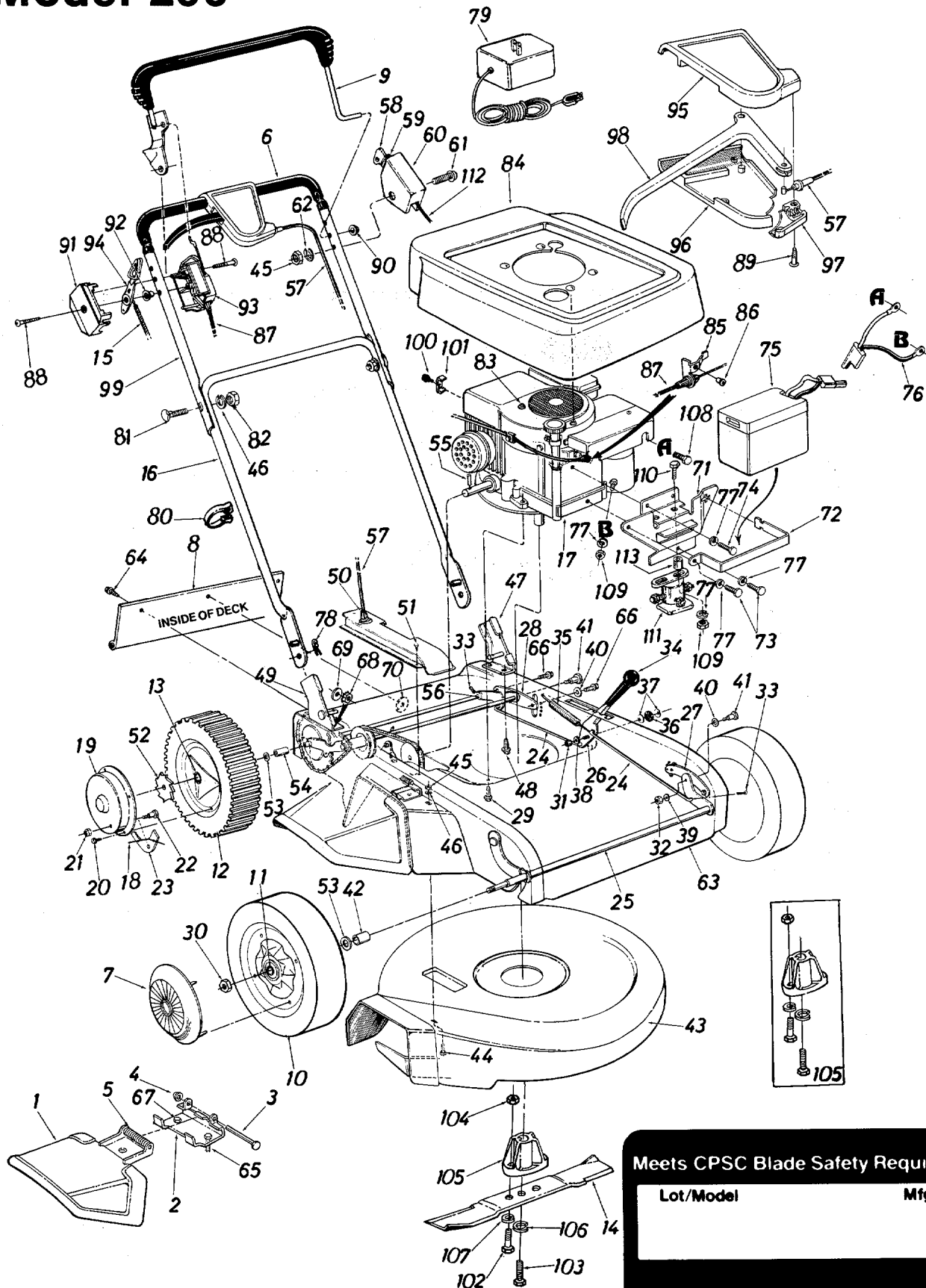

296

Model 269

PARTS LIST FOR MODEL 296 ROTARY MOWER

REF. NO.	PART NO.	COLOR CODE	DESCRIPTION	NEW PART	REF. NO.	PART NO.	COLOR CODE	DESCRIPTION	NEW PART
1	11679		Chute Deflector Ass'y. Comp.		49	12936		Handle Mount Brkt. Ass'y.	
2	11130		Adapter Plate		50	14186		Belt Guard	
3	711-0555		Pivot Pin		51	710-0224		Hex Hd. Self-Tap Scr. #10 x .50 Lg.	
4	726-0106		Push Nut 1/4" Rod		52	748-0187		Ratchet—Rear Wheel	
5	732-0253		Torsion Spring		53	736-0160		Fl-Wash. .531" I.D. x .930" O.D. x .050	
6	718-0145		Black Grip		54	750-0190		Spacer .765" I.D. x .89" O.D. x .960" Lg.	
7	**		Hub Cap (Front)					Spring Pin Spir. 3/16" Dia. x 1.50" Lg.	
8	731-0586		Rear Flap Ass'y.					Hex Flange Brg. x .506" I.D. Plastic	
9	731-0610		Control Handle—R.H.	N	55	715-0144		Clutch Cable—59.0" Green	
10	734-0874		Wheel Ass'y. Comp.—(Front)		56	741-0324		Ignition Key	
11	741-0180		Flanged Ball Brg. .500" I.D. (Front)		57	746-0464		Ignition Switch w/Nut	N
12	734-0880		Wheel Ass'y. Comp.—(Rear)		58	725-0201		Ignition Switch Bracket	N
13	741-0262		Flange Brg.—Plastic 1/2" I.D. (Rear)		59	725-0873		Carriage Bolt 5/16-18 x 1.25" Lg.*	
14	742-0124		21" Blade	N	60	15392		L-Wash. 5/16" I.D.*	
15	746-0417		Throttle Wire—43.0" Yellow	N	61	710-0161		Upper Deck Ass'y.	
16	749-0373		Lower Handle		62	736-0119		Hex Bolt 1/4-20 x .75" Lg.*	
17	—		Engine		63	14939		Hex B-Tap Scr. 1/4 x .38	
18	10622		Spring—Nylon		64	710-0252		Hex Wash. Hd. TT-Tap Scr. 3/8-16 x 1.00" Lg.	
19	10647		Hub Cap—(Rear)		65	710-0352		Hex Wash. Hd. AB-Tap Scr. 1/4 x .62" Lg.	
20	710-0748		Pan Hd. Tap Scr. #12 x .50" Lg.		66	710-0654		Sems Nut 1/4-20 Thd.*	
21	712-0324		Hex Ins. L-Nut 1/4-20 Thd.		67	710-0776		Fl-Wash. .281" I.D. x .73" O.D. x .063	
22	738-0137		Shld. Bolt .342 Dia. x .268		70	736-0211		Fl-Wash. .285" I.D. x 1.25" O.D. x .060	
23	748-0188		Pawl		71	14851		Battery Brkt.	N
24	10080		Height Adjustment Rod		72	14852		Battery Strap	N
25	10662		Front Axle Ass'y.		73	710-0642		Hex TT-Tap Scr. 1/4-20 x .75" Lg.	
26	10666		Height Adjustment Lever		74	710-0776		Hex Wash. Hd. AB-Tap Scr. 1/4 x .62" Lg.	
27	14189		Front Pivot Brkt.		75	†		Battery—6V	
28	14190		Rear Pivot Brkt.		76	†		Wire Harness	
29	710-0654		Hex Wash. Hd. TT-Tap Scr. 3/8-16 x 1.00" Lg.		77	736-0329		L-Wash. 1/4" I.D.*	
30	712-0200		Hex Ins. L-Nut 1/2-20 Thd.		78	714-0104		Intern. Cotter Pin 5/16" Dia.	
31	712-0711		Hex Jam Nut 3/8-24 Thd.		79	†		Battery Charger—6V x 120V	
32	712-0798		Hex Nut 3/8-16 Thd.*		80	726-0192		Cable Tie	
33	714-0507		Cotter Pin 3/32 x 3/4" Lg.*		81	710-0671		Curved Hd. Carr. Bolt 5/16-18 x 1.38" Lg.	
34	720-0143		Grip Black		82	712-0267		Hex Nut 5/16-18 Thd.*	
35	732-0121		Extension Spring .73" O.D. x 4.31" Lg.		83	726-0219		Snap-On Scr. #8 x .38" Lg.	
36	735-0127		Rubber Wash. .33" I.D. x .87" O.D.		84	731-0635		Engine Shroud Ass'y.	N
37	736-0105		Bell-Wash. .400" I.D. x .88" O.D.		85	14924		Cable Bracket	N
38	736-0160		Fl-Wash. .531" I.D. x .930" O.D.		86	728-0171		Pop Rivet .156" Dia. x .379 Lg.	
39	736-0169		L-Wash. 3/8" I.D.*		87	746-0478		Control Cable—49.0" Blue	N
40	736-0221		L-Wash. 3/8" x .56" O.D.		88	710-0796		Truss Mach. Hi-B Tap Scr. #12 x 1.50" Lg.	
41	738-0149		Shld. Bolt .625" Dia. x .425" Lg.		89	710-0841		Flat C-Sunk AB-Tap Scr. #10 x .75" Lg.	
42	748-0190		Spacer .513" I.D. x .703" O.D. x .69" Lg.		90	726-0135		Cap Speed Nut 5/16" Rod	
43	11425		21" Lower Deck Ass'y.		91	731-0523		Control Panel Half	
44	710-0260		Carriage Bolt 5/16-18 x .62" Lg.*		92	731-0524		Control Disc Pin	
45	712-0267		Hex Nut 5/16-18 Thd.*		93	731-0526		Clutch Panel Half	
46	736-0119		L-Wash. 5/16" I.D.*						
47	12935		Handle Mount Brkt. Ass'y.						
48	710-0603		Hex Wash. Hd. B-Tap Scr. 5/16-18 x .50" Lg.						

Order From Briggs and Stratton Authorized
Service Dealer.

296

Model 269

PARTS LIST FOR MODEL 296 ROTARY MOWER (CONTINUED)

REF. NO.	PART NO.	COLOR CODE	DESCRIPTION	NEW PART
94	731-0528		Throttle Control Lever	
95	731-0617		Control Cover Half—Upper	N
96	731-0618		Control Cover Half—Lower	N
97	731-0619		Cable Mtg. Cap	N
98	731-0620		Control Lever	N
99	749-0537		Upper Handle	N
100	710-0436		Hex B-Tap Scr. #10 x .62" Lg.	
101	751-0333		Casing Clamp	
102	710-0888		Hex Bolt 5/16-24 x 1.00" Lg. (Grade 5)	
103	710-0331		Hex Bolt 3/8-24 x 2.25" Lg. (Grade 5)	
104	712-0123		Hex Nut 5/16-24 Thd.*	
105	753-0348		Blade Adapter Kit	N
106	736-0217		L-Wash. 3/8" I.D. Heavy Duty	
107	736-0119		L-Wash. 5/16" I.D.*	
108	710-0871		Hex Sems Bolt #10-32 x .38" Lg.	N
109	712-0287		Hex Nut 1/4-20 Thd.*	
110	710-0597		Hex Bolt 1/4-20 x 1.0" Lg.*	
111	725-0874		Solenoid—6V	N
112	725-0872		Wire Harness	N
113	750-0287		Spacer	
114	15735		Rear Flap Stop Brkt. (Not Shown)	N

*For faster service obtain standard nuts, bolts and washers locally. If these items cannot be obtained locally, order by part number and size as shown on parts list.

(462—Red Flake)

When ordering parts, if color or finish is important use the appropriate color code shown above. (e.g. Red Flake Finish—11428 (462).)

**Optional Front Hub Caps

Color	Part No.
Red	731-0124
Orange	731-0254
Black	731-0354
Gray	731-0355

NOTE: The engine is not under warranty by the mower manufacturer...If repairs or service is needed on the engine, please contact your nearest authorized engine service outlet. Check the "Yellow Pages" of your telephone book under "Engines—Gasoline."



NOTE

This instruction manual covers various models and all specifications shown do not necessarily apply to your model. Specifications subject to change without notice or obligation.

Model 296

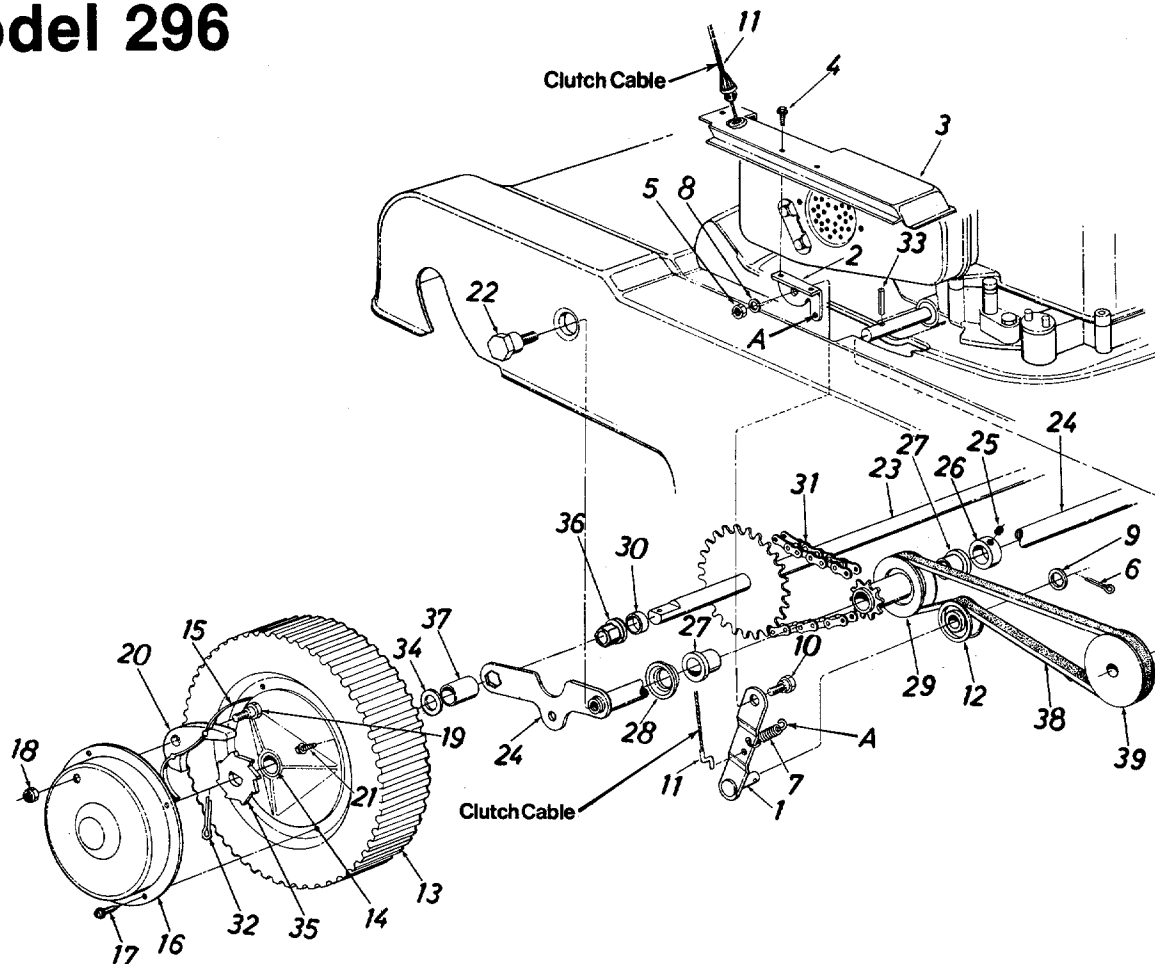

PARTS LIST FOR MODEL 296 ROTARY MOWER

REF. NO.	PART NO.	COLOR CODE	DESCRIPTION	NEW PART	REF. NO.	PART NO.	COLOR CODE	DESCRIPTION	NEW PART
1	14181		Idler Brkt. Ass'y.		23	11866		Rear Shaft Ass'y.	
2	14245		Idler Mounting Brkt.		24	14937		Rear Axle Ass'y.	N
3	14186		Belt Guard		25	710-0421		Set Scr. 5/16-18 x .25" Lg. Cup Point	
4	710-0776		Hex Wash. Hd. AB-Tap Scr. 1/4" x .62" Lg.		26	711-0169		Collar 5/8" I.D.	
5	712-0267		Hex Nut 5/16-18 Thd.*		27	741-0249		Flange Brg. .634" I.D. Plastic	
6	714-0115		Cotter Pin 1/8" Dia. x 1.00"		28	10665		Spacer	
7	732-0357		Extension Spring .33" O.D. x 1.12" Lg.		29	756-0191		Pulley w/9 Tooth Sprocket Ass'y.	
8	736-0119		L-Wash. 5/16" I.D.*		30	711-0494		Spacer .53" I.D. x .75" O.D. x .38" Lg.	
9	736-0160		Fl-Wash. .531" I.D. x .930" O.D. x .050		31	713-0256		#48 Chain 1/2" Pitch x 32 Links	
10	738-0255		Shld. Bolt .375" Dia. x 1.89		32	714-0115		Cotter Pin 1/8" Dia. x 1.00" Lg.*	
11	746-0464		Clutch Cable—59"		33	715-0144		Spring Pin Spir. 3/16" Dia. x 1.50" Lg.	
12	756-0360		Flat Idler 1.62" Dia.		34	736-0160		Fl-Wash. .531" I.D. x .930" O.D. x .050	
13	734-0880		Wheel Ass'y. Comp. (Rear)		35	748-0187		Ratchet—Rear Wheel	
14	741-0262		Flange Brg. 1/2" I.D. (Rear)		36	741-0324		Hex Flange Brg. .506" I.D.	
15	10622		Spring—Nylon		37	750-0190		Spacer .756" I.D. x .89" O.D. x .960" Lg.	
16	10647		Rear Hub Cap		38	754-0114		"V"-Belt 1/2" x 24" Lg.	
17	710-0748		Pan Hd. Tap Scr. #12 x .50"		39	756-0384		1/2" "V"-Pulley .50" I.D. x 2.52" O.D.	
18	712-0324		Hex Ins. L-Nut 1/4-20 Thd.						
19	738-0137		Shld. Bolt .342" Dia. x .268						
20	748-0188		Pawl						
1	710-0200		Hex Wash. Hd. Tap Scr. #8 x .50" Lg.						
22	738-0149		Shld. Bolt .625" Dia. x .425"						

296
Model 289

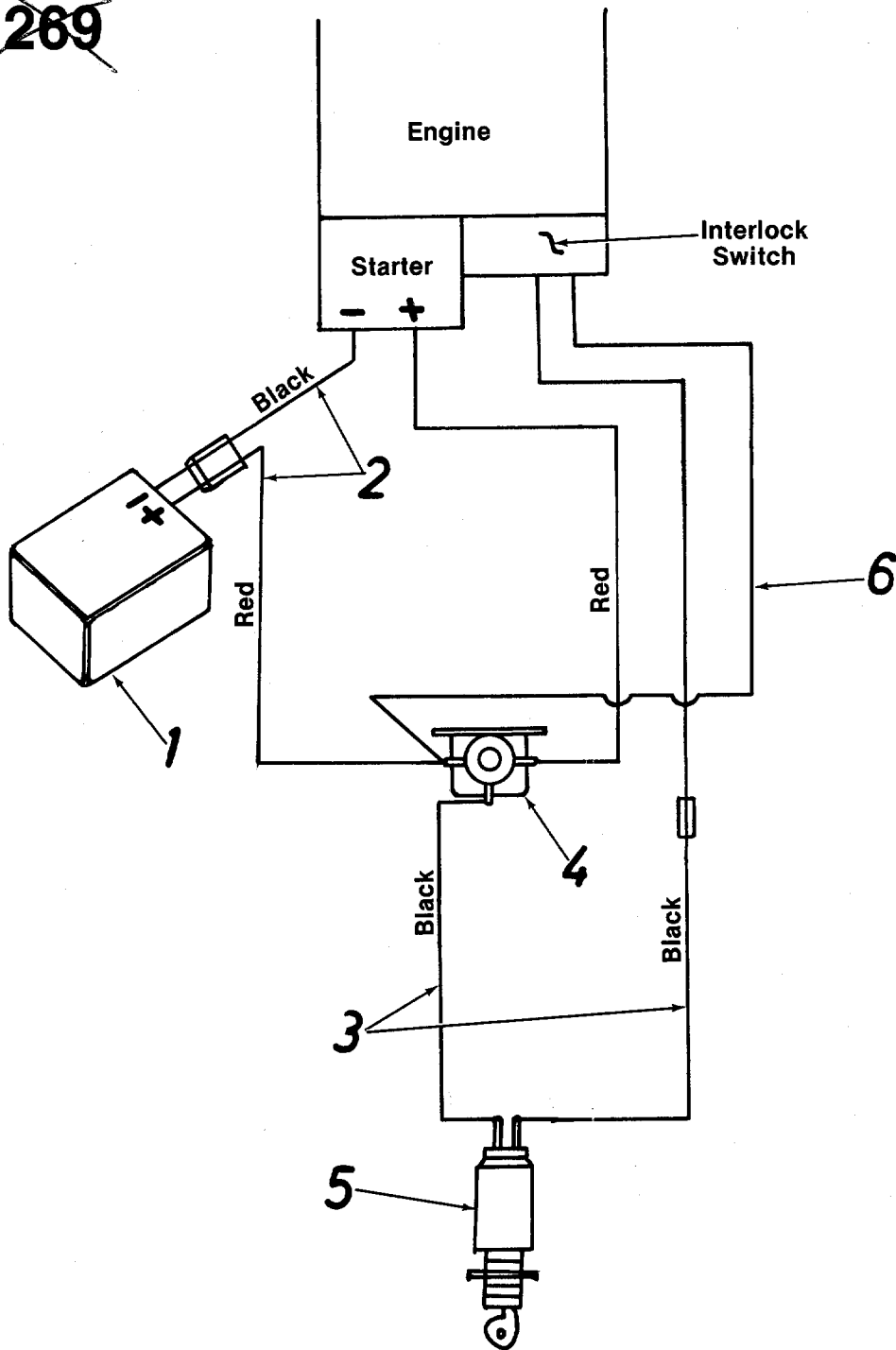

**PARTS LIST FOR MODEL 296
 ELECTRICAL DIAGRAM**

REF. NO.	PART NO.	DESCRIPTION	NEW PART
1	†	Battery—6V	
2	†	Wiring Harness	
3	725-0872	Wiring Harness	
4	725-0874	Solenoid 6V	N
5	725-0873	Key Switch w/Nut	N
6	725-0905	Jumper Lead	N

†Order From Briggs and Stratton Authorized Service Dealer.

PARTS INFORMATION

POWER EQUIPMENT PARTS AND SERVICE

Parts and service for all MTD manufactured power equipment are available through the authorized service firms listed below. All orders should specify the model number of your unit, part numbers, description of parts and the quantity of each part required.

BRIGGS AND STRATTON, TECUMSEH AND PEERLESS PARTS AND SERVICE

Briggs & Stratton, Tecumseh and Peerless parts and service should be handled by your nearest authorized engine service firm. Check the yellow pages of your telephone directory under the listing **Engines—Gasoline**, Briggs & Stratton or Tecumseh Lauson.

NOTE: If any parts are found to be missing or defective upon assembly of this unit, write to advise the factory so that immediate replacement can be made.

ALABAMA Auto Electric & Carburetor Co. 2625 4th Ave. S. 35233	BIRMINGHAM 2625 4th Ave. S. 35233	NORTH CAROLINA Smith Hardware Co.	GOLDSBORO 515 N. George St. 27530
ARKANSAS Sutton's Lawn Mower Shop 5301 Roundtop Drive Box 368, Rt. 4 72117	NORTH LITTLE ROCK 5301 Roundtop Drive Box 368, Rt. 4 72117	Dixie Sales Company	GREENSBORO 335 N. Green 27402
CALIFORNIA Billious 75 North D Street 93257	PORTERVILLE 75 North D Street 93257	OHIO Stebe's Mid-State Mower Supply	CARROLL Box 366, 71 High St. 43112
COLORADO Spitzer Industrial Products Co. Box 29114, 6601 N. Washington St. 80229	DENVER Box 29114, 6601 N. Washington St. 80229	Bleckrie, Inc.	CLEVELAND 7900 Lorain Ave. 44102
FLORIDA Radco Distributors 4909 Victor St. Box 5459 32207	JACKSONVILLE 4909 Victor St. Box 5459 32207	National Central	WADSWORTH 687 Seville Rd. 44281
Small Eng. Dist. 2351 N.W. 147th St. 33054	OPA LOCKA 2351 N.W. 147th St. 33054	Burton Supply Co.	YOUNGSTOWN 1301 Logan Ave. Box 929 44501
GEORGIA East Point Cycle & Key 2834 Church St. 30344	EAST POINT 2834 Church St. 30344	OKLAHOMA Victory Motors, Inc.	MUSKOGEE 605 S. Cherokee 74401
ILLINOIS Keen Edge Co. 8615 Ogden Ave. 60534	LYONS 8615 Ogden Ave. 60534	OREGON Kenton Supply Co.	PORTLAND 8216 N. Denver Ave. 97217
INDIANA Parts & Sales Inc. 2101 Industrial Pkwy. 46514	ELKHART 2101 Industrial Pkwy. 46514	PENNSYLVANIA EECO Inc.	HARRISBURG 4021 N. 6th St. 17110
IOWA Power Lawn & Garden Equip. 2551 J.F. Kennedy 52001	DUBUQUE 2551 J.F. Kennedy 52001	Thompson Rubber Co.	PHILADELPHIA 5222-24 N. Fifth St. 19120
LOUISIANA Mid-South Power 700 Pine St. 71201	MONROE 700 Pine St. 71201	Bluemont Co.	PITTSBURGH 11125 Frankstown Rd. 15235
Suhren Engine Co. 8330 Earhart Blvd. 70118	NEW ORLEANS 8330 Earhart Blvd. 70118	Frank Roberts & Sons	PUNXSUTAWNEY R.D. 2 15767
MARYLAND Center Supply Co. 6867 New Hampshire Ave. 20912	TAKOMA PARK 6867 New Hampshire Ave. 20912	TENNESSEE Master Repair Service	KNOXVILLE 2000 Western Ave. 37921
MASSACHUSETTS Morton B. Collins Co. 300 Birnie Ave. 01107	SPRINGFIELD 300 Birnie Ave. 01107	American Sales & Service, Inc.	MEMPHIS 3035-43 Bellbrook 381
MICHIGAN Lorenz Service Co. 2500 S. Pennsylvania 48910	LANSING 2500 S. Pennsylvania 48910	TEXAS Marr Brothers, Inc.	DALLAS 423 E. Jefferson 75203
Power Equipment Dist. 340 Hubbard 48043	MOUNT CLEMENS 340 Hubbard 48043	Woodson Sales Corp.	FORT WORTH 1702 N. Sylvania 76111
MINNESOTA Hance Distributing Inc. 420 Excelsior Ave. W. 55343	HOPKINS 420 Excelsior Ave. W. 55343	Bullard Supply Co.	HOUSTON 2409 Commerce St. 77003
MISSISSIPPI Biloxi Sales & Service, Inc. 506 Caillavet St. 39533	BILOXI 506 Caillavet St. 39533	Engine House Inc.	SAN ANTONIO 8610 Botts Lane P.O. Box 17867 78217
MISSOURI Automotive Equip. Service 3117 Holmes St. 64109	KANSAS CITY 3117 Holmes St. 64109	UTAH A-1 Engine & Mower Co.	SALT LAKE CITY 439 E. 900 So. 84111
Ross-Frazier Supply Co. 8th and Monterey 64503	ST. JOSEPH 8th and Monterey 64503	VIRGINIA RBI Corp.	ASHLAND Lake Ridge Rd. 101 Cedar Run Dr. 23005
Henzler, Inc. 2015 Lemay Ferry Road 63125	ST. LOUIS 2015 Lemay Ferry Road 63125	WASHINGTON Bailey's Inc.	SEATTLE 1414 14th Ave. 98122
NEW JERSEY Lawnmower Parts Inc. 717 Creek Rd. 08030	BELLMAWR 717 Creek Rd. 08030	WISCONSIN Power Pac	MARSHFIELD 301 E. 29th St. 54449
NEW MEXICO Spitzer Eng. & Parts 1023 Third Ave. N.W. 87103	ALBUQUERQUE 1023 Third Ave. N.W. 87103	Appleton Automotive Supply Co.	APPLETON 123 S. Linwood Ave. P.O. Box 798 54911
NEW YORK Gamble Dist., Inc. West End Ave. 13619	CARTHAGE West End Ave. 13619	E-K on Small Engine Spec.	TWIN LAKES 122 Lance Dr. 53181

WARRANTY PARTS AND SERVICE POLICY

(0782)

The purpose of warranty is to protect the customer from defects in workmanship and materials, defects which are NOT detected at the time of manufacture. It does not provide for the unlimited and unrestricted replacement of parts. Use and maintenance are the responsibility of the customer. The manufacturer cannot assume responsibility for conditions over which it has no control. Simply put, if it's the manufacturer's fault, it's the manufacturer's responsibility; if it's the customer's fault, it's the customer's responsibility.

CLAIMS AGAINST THE MANUFACTURER'S WARRANTY INCLUDES:

1. Replacement of Missing Parts on new equipment.
2. Replacement of Defective Parts within the warranty period.
3. Repair of Defects within the warranty period.

All claims MUST be substantiated with the following information:

1. Model Number of unit involved.
2. Date unit was purchased or first put into service.
3. Date of failure.
4. Nature of failure.

Free Manuals Download Website

<http://myh66.com>

<http://usermanuals.us>

<http://www.somanuals.com>

<http://www.4manuals.cc>

<http://www.manual-lib.com>

<http://www.404manual.com>

<http://www.luxmanual.com>

<http://aubethermostatmanual.com>

Golf course search by state

<http://golfingnear.com>

Email search by domain

<http://emailbydomain.com>

Auto manuals search

<http://auto.somanuals.com>

TV manuals search

<http://tv.somanuals.com>