

.50

OWNER'S GUIDE

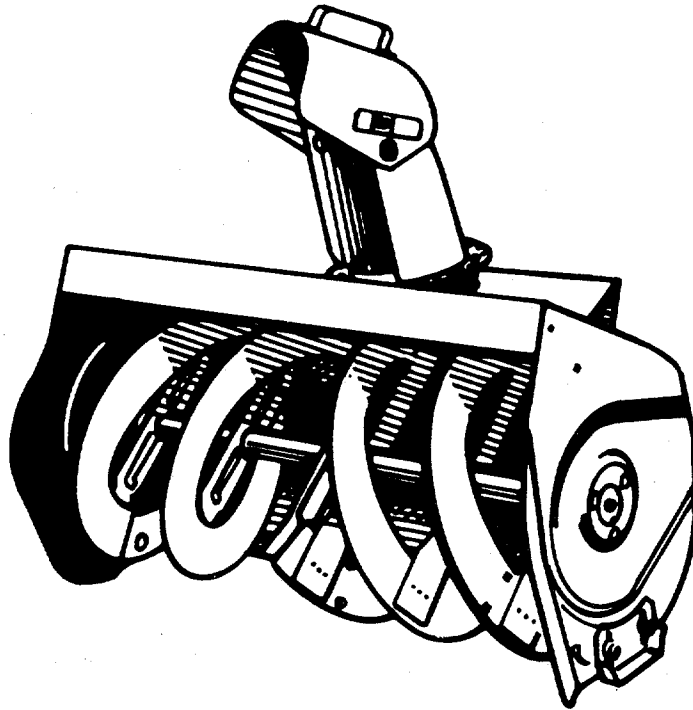

**ASSEMBLY
OPERATION
MAINTENANCE
PARTS LIST**

**IMPORTANT:
Read Safety Rules
and Instructions**

MODEL NUMBERS

190-469A

TMO-33849A

36"

**SNOW THROWER
ATTACHMENT**

LIMITED WARRANTY

For one year from the date of original retail purchase, MTD PRODUCTS INC will either repair or replace, at its option, free of charge, F.O.B. factory or authorized service firm, any part or parts found to be defective in material or workmanship. Transportation charges under this warranty must be paid by the purchaser unless return is requested by MTD PRODUCTS INC.

This warranty will not apply to any part which has become inoperative due to misuse, excessive use, accident, neglect, improper maintenance, alterations, or unless the unit has been operated and maintained in accordance with the instructions furnished. This warranty does not apply to the engine, motor, battery, battery charger or component parts thereof. Please refer to the applicable manufacturer's warranty on these items.

This warranty will not apply where the unit has been used commercially.

Warranty service is available through your local authorized service dealer or distributor. If you do not know the dealer or distributor in your area, please write to the Customer Service Department of MTD.

The return of a complete unit will not be accepted by the factory unless prior written permission has been extended by MTD.

This warranty gives you specific legal rights. You may also have other rights which vary from state to state.

IMPORTANT

Safe Operation Practices for Snow Throwers

TRAINING

1. Read the owner's guide instruction manual carefully. Be thoroughly familiar with the controls and proper use of the equipment. Know how to stop the unit and disengage the controls quickly.
2. Never allow children to operate equipment. Never allow adults to operate equipment without proper instruction.
3. Keep the area of operation clear of all persons, especially small children and pets.
4. Exercise caution to avoid slipping or falling, especially when operating in reverse.

PREPARATION

1. Thoroughly inspect the area where the equipment is to be used and remove all door mats, sleds, boards, wires and other foreign objects.
2. Disengage all clutches and shift into neutral before starting engine or motor.
3. Do not operate equipment without wearing adequate winter outer garments. Wear footwear which will improve footing on slippery surfaces.
4. Handle fuel with care, it is highly flammable.
 - (A) Use approved fuel container.
 - (B) Never add fuel to a running engine or hot engine.
 - (C) Fill fuel tank outdoors with extreme care. Never fill fuel tank indoors.
 - (D) Replace gasoline cap securely and wipe up spilled fuel.
 - (E) Open doors if engine is run in the garage—exhaust fumes are dangerous.
5. Adjust collector housing height to clear gravel or crushed rock surface.
6. Never attempt to make any adjustments while engine or motor is running (except where specifically recommended by manufacturer).
7. Never operate the snow thrower without good visibility or light.
8. Let engine and machine adjust to outdoor temperatures before starting to clear snow.
3. After striking a foreign object, stop the engine (motor), remove wire from spark plug, thoroughly inspect the snow thrower for any damage, and repair the damage before restarting and operating the snow thrower.
4. If the unit should start to vibrate abnormally, stop the engine (motor) and check immediately for the cause. Vibration is generally a warning of trouble.
5. Stop engine (motor) whenever you leave the operating position, before unclogging the collector/impeller housing or discharge guide, and making any repairs, adjustments, or inspections.
6. Take all possible precaution when leaving the vehicle unattended, disengage the power take-off, lower the attachment, shift into neutral, set the parking brake, stop the engine, remove the key.
7. When cleaning, repairing, or inspecting make certain collector/impeller, and all moving parts have stopped. Disconnect spark plug wire and keep wire away from plug to prevent accidental starting. Disconnect cord on electric motors.
8. Do not run engine indoors, exhaust fumes are dangerous.
9. Do not clear snow across the face of slopes. Exercise extreme caution when changing direction on slopes. Do not attempt to clear steep slopes.
10. Never operate snow thrower without guards, plates, or other safety protective devices in place.
11. Never operate snow thrower near glass enclosure, automobiles, window wells, drop-offs, etc., without proper adjustment of snow discharge angle. Keep children and pets away.
12. Do not overload machine capacity by attempting to clear snow at too fast a rate.
13. Never operate machine at high transport speeds on slippery surfaces. Use care when backing.
14. Never direct discharge at bystanders or allow anyone in front of unit.
15. Disengage power to collector/impeller when transporting or not in use.
16. Only use attachments and accessories approved by manufacturer of snow thrower (such as wheel weights, counter weights, cabs, etc.).

MAINTENANCE AND STORAGE

OPERATION

1. Do not put hands or feet near rotating parts. Keep clear of discharge opening at all times.
2. Exercise extreme caution when operating on or crossing a gravel drive, walks, or roads. Stay alert for hidden hazards and traffic. Do not carry passengers.
1. Check shear bolts, engine mounting bolts, etc. at frequent intervals for proper tightness to be sure equipment is in safe working condition.
2. Never store machine with fuel in the fuel tank inside a building where open flame or spark are present. Allow engine to cool before storing in any enclosure.
3. Always refer to owner's guide instructions for important details if snow thrower is to be stored for an extended period.
4. Run machine a few minutes after throwing snow to prevent freeze up of collector/impeller.

**LIST OF CONTENTS IN HARDWARE PACK
SEE FIGURE 1**

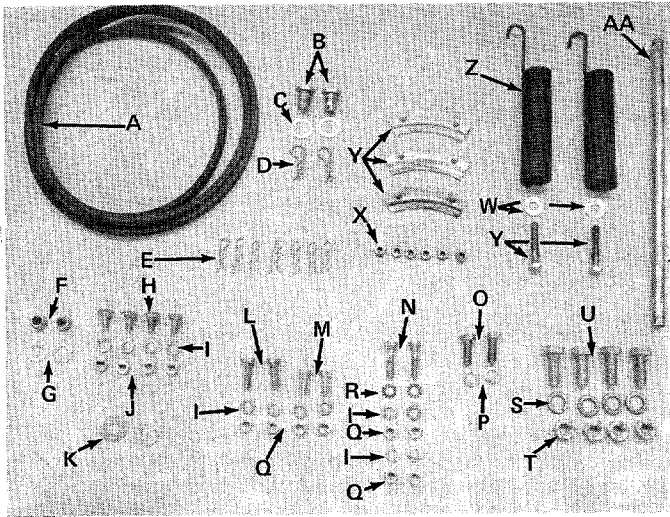

FIGURE 1

- A (1) "V"-Belt 1/2" x 85" long
- B (2) Clevis Pins
- C (2) Flat Washers
- D (2) Hair Pin Cotter
- E (7) Hair Pin Cotter
- F (2) Hex Top Lock Nut 5/16-18 Thread
- G (2) Flat Washers
- H (4) Carriage Bolts 5/16-18 x 5/8" long
- I (8) Lock Washers 5/16" I.D.
- J (4) Hex Nuts 5/16-18 Thread
- K (2) Flat Washers
- L (2) Hex Bolts 5/16-18 x 1.00" long
- M (2) Hex Bolts 5/16-18 x .75" long
- N (2) Hex Bolts 5/16-18 x 1.25" long
- O (2) Hex Bolts 3/8-16 x 1.00" long
- P (2) Lock Washers 3/8" I.D.
- Q (8) Hex Nuts 5/16-18 Thread
- R (2) External Lock Washers 5/16" I.D.
- S (4) Lock Washers 1/2" I.D.
- T (4) Hex Nuts 1/2-13 Thread
- U (4) Hex Bolts 1/2-13 x 1.25" long
- V (2) Hex Bolts 5/16-18 x 2.00" long
- W (2) Flat Washers
- X (6) Hex Center Lock Nuts 1/4-20 Thread
- Y (3) Chute Flange Keeper Ass'y.
- Z (2) Helper Springs
- AA (1) Lift Handle Shaft

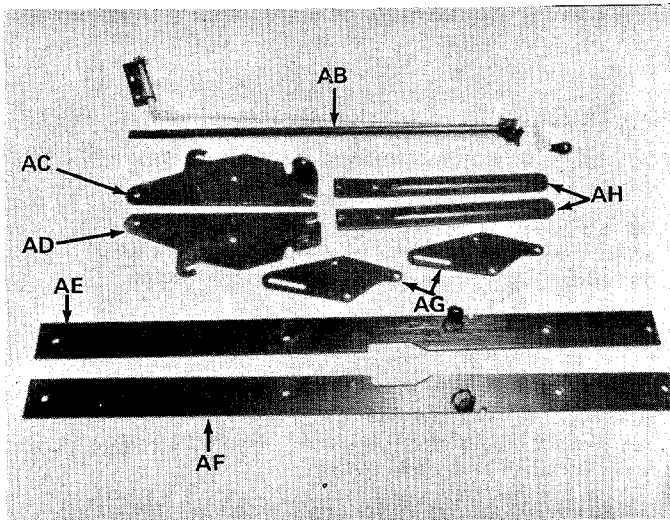

FIGURE 2

**LIST OF LOOSE PARTS IN CARTON
SEE FIGURES 2 and 3.**

- AB (1) Preassembled Chute Crank & Support
- AC (1) Channel Supporting Bracket - L.H.
- AD (1) Channel Supporting Bracket - R.H.
- AE (1) Linkage Arm Assembly - L.H.
- AF (1) Linkage Arm Assembly - R.H.
- AG (2) Linkage Brackets
- AH (2) Drift Cutters

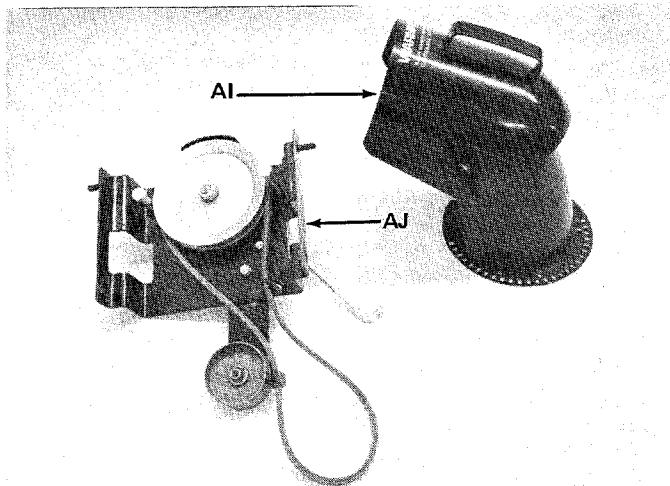

FIGURE 3

- AI (1) Preassembled Chute Assembly
- AJ (1) Preassembled Idler Assembly

TOOLS REQUIRED

1. Adjustable Wrench
2. A strong piece of wire
3. A screwdriver
4. A pair of pliers
5. A 7/16" Open End Wrench
6. A 1/2" Open End Wrench
7. A 9/16" Open End Wrench
8. A 3/4" Open End Wrench

ASSEMBLY INSTRUCTIONS

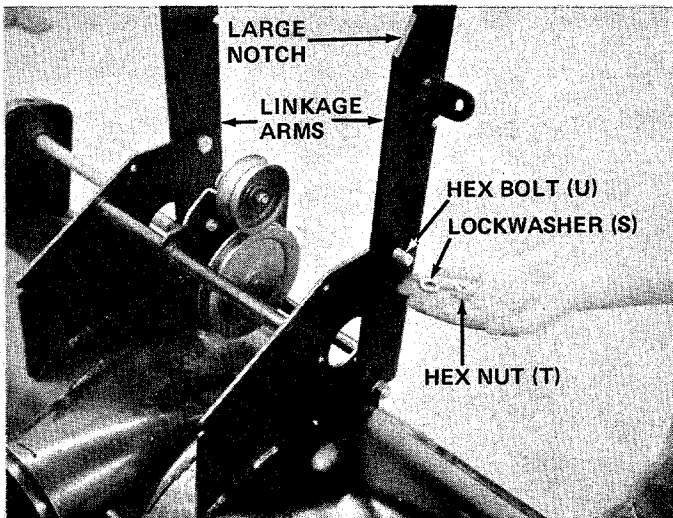

FIGURE 4

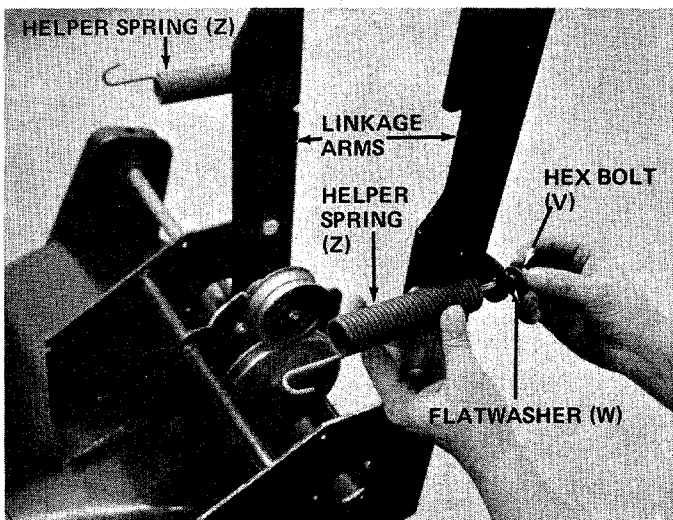

FIGURE 5

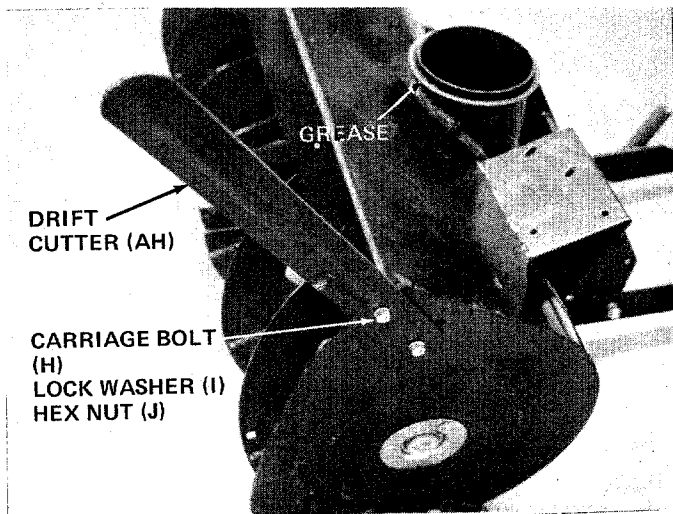

FIGURE 6

1. Remove the snow thrower, all loose parts and hardware package from the carton.
2. Tip the snow thrower forward, so that the augers are face down.
3. Assemble the linkage arms (Ref. AE & AF) to the housing assembly as shown in figure 4. Be sure the linkage arms have the large notch up. Secure with four hex bolts (U) 1/2-13 x 1.25" Lg., four hex nuts (T) and lockwashers (S) provided.

4. Place helper spring (Z) in position on linkage arm assemblies. Secure with flat washers (W) and hex bolts (V) provided in hardware pack. See figure 5. Thread bolt approximately one inch into the spring insert. Adjustment is made in step number 26.
5. Tip the snow thrower back in normal position so that it rests on linkage arms.

6. Assemble the drift cutters (AH) to the snow thrower housing with four carriage bolts (H), lock washers (I) and hex nuts (J). See figure 6. Heads of carriage bolts assemble from the inside of housing.

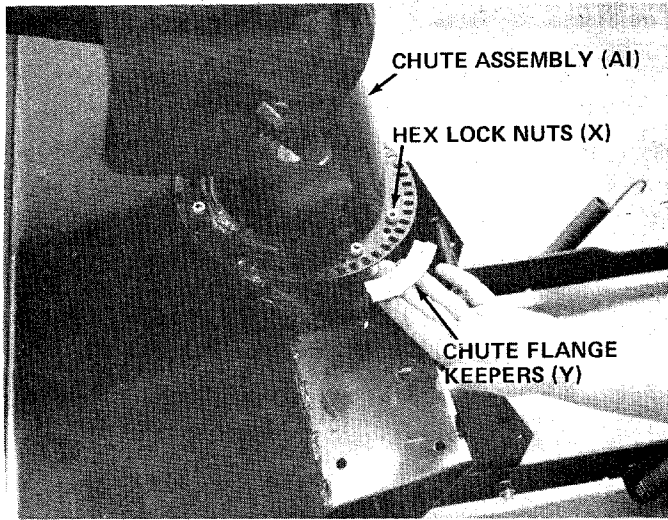

FIGURE 7

NOTE

Before setting the chute assembly on the spiral housing assembly, grease the housing for ease of operation. See figure 7.

7. Assemble the chute assembly (A1) to the housing using three chute flange keepers (Y) and six hex lock nuts (X). See figure 7.

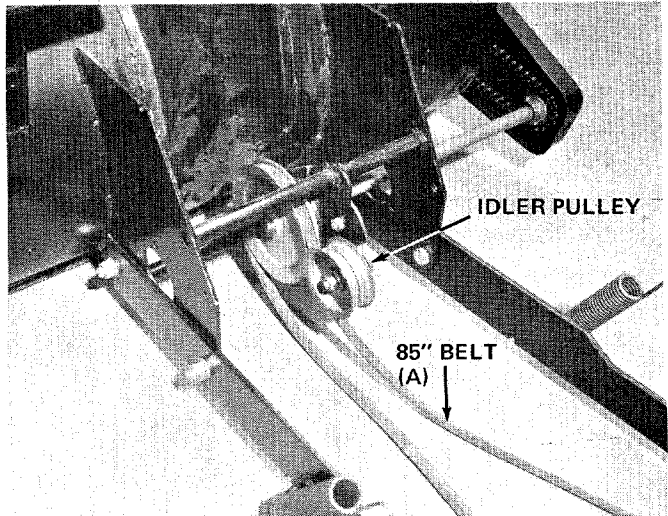

FIGURE 8

8. Place the 85" belt (A) in position on the idler of the snow thrower as shown in figure 8.

NOTE

The idler bracket has three holes for belt tension adjustment. Normally, the idler pulley is assembled in the center hole. If the belt is too tight to assemble, the idler pulley may be moved to the top hole.

PREPARING THE LAWN TRACTOR FOR ASSEMBLY OF SNOW THROWER

1. Remove the gas cap and place a piece of plastic film on the gas cap to prevent gas from leaking out of the tank.

NOTE

If unit is electric start remove the battery.

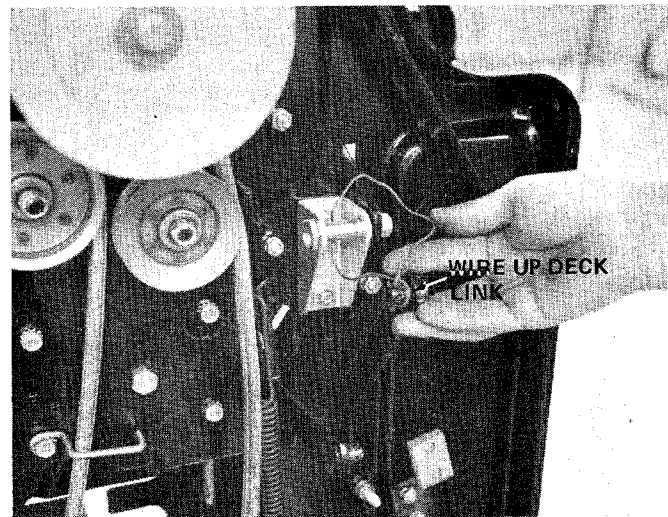
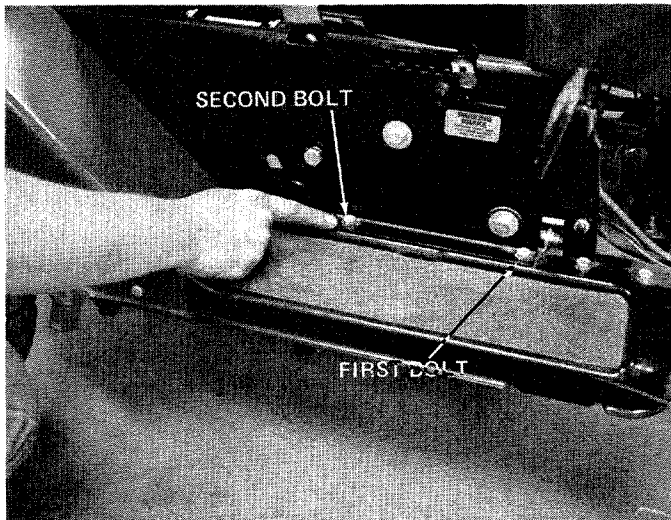

FIGURE 9

2. Remove the spark plug wire from spark plug and ground.
3. Remove the mowing deck.
4. With a piece of wire hold the front left hand deck hanger out of the way. See figure 9.

NOTE

This hanger bracket is straight.



NOTE

After removing the deck, check the deck links. The weld pins should be outboard. If not, change them. It is easier to change deck links by removing the transmission cover and knob. After changing deck links, reassemble the transmission cover and knob.

5. Remove the second bolt on the running boards as shown in figure 10. (Right and left hand sides).

FIGURE 10

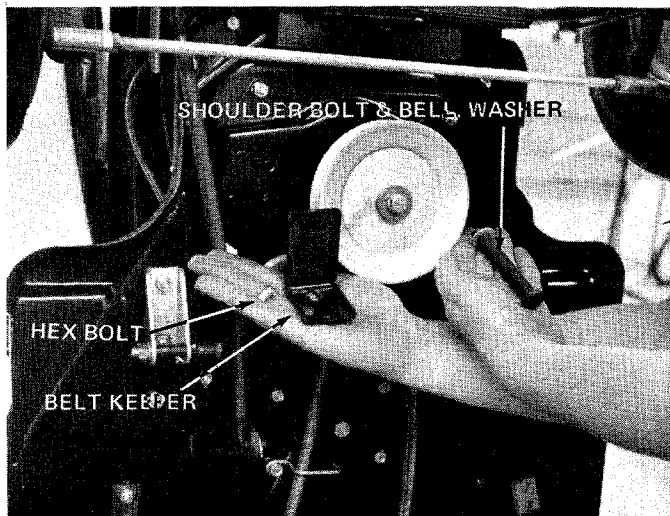

6. Replace the bolts with hex bolts (N) 5/16-18 x 1.25" Lg. provided with snow thrower. Fasten with 5/16-18" nut (Q) and lock washer (I). Tighten with wrench.
7. Tip the lawn tractor up on its rear wheels so that the unit rests on the back on the seat.
8. Remove the belt keeper and shoulder bolt at engine pulley (if these were replaced when deck was removed).
9. Assemble the channel supporting brackets right and left hand to lawn tractor. See figures 12 and 13.

FIGURE 11

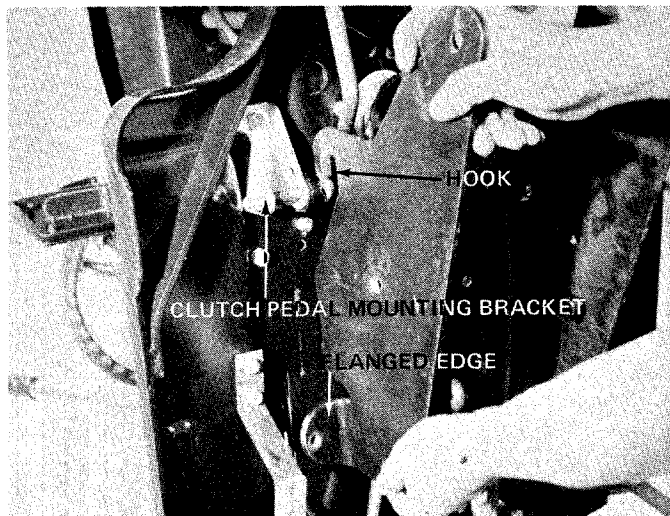

10. Hook the top of channel supporting bracket right hand (AD) ~~side~~ ^{next to brake pedal towards inside} of clutch pedal mounting bracket. See figure 12. ^{Brake}
11. Place flanged edge of channel support bracket over hex bolt (N) (which you assembled in step 6). Secure with lock washer (I) and hex nut (Q). See figure 13.

FIGURE 12

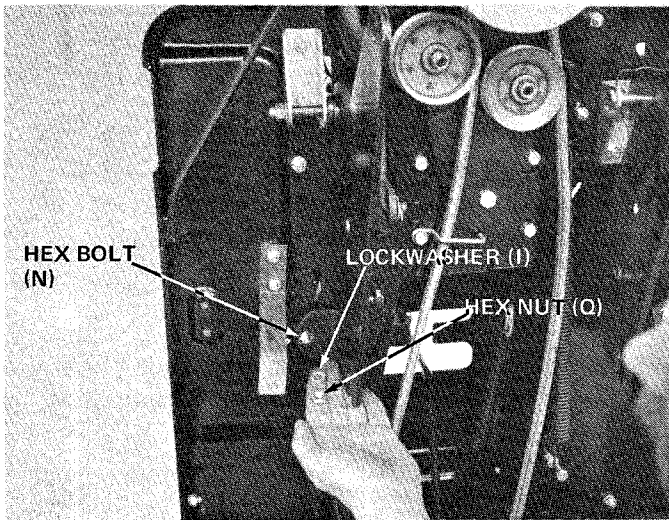

FIGURE 13

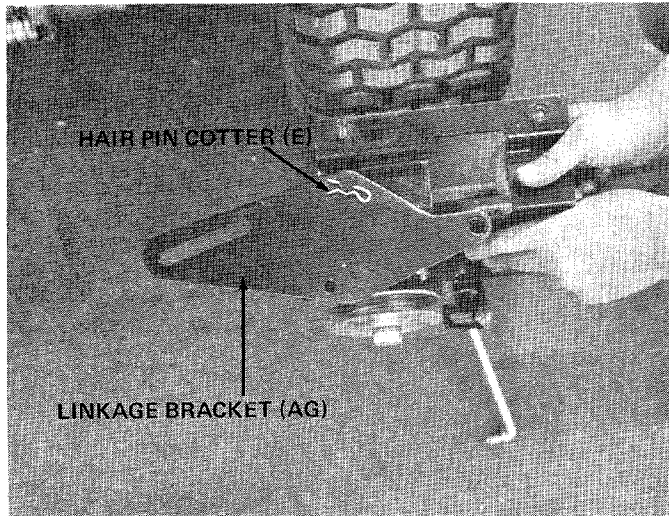

FIGURE 14

12. Pre-assemble the linkage bracket (AG) to the idler assembly (AJ), as shown in figure 14. Secure with hair pin cotter (E). **NOTE:** Slot in linkage bracket goes to the rear.

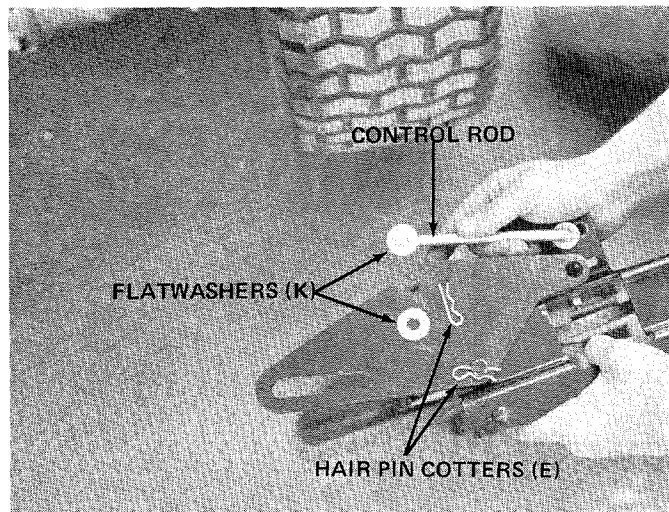

FIGURE 15

13. Assemble the other linkage bracket (AG) to the other side of idler assembly (AJ). Secure with hair pin cotter (E). Place flat washer (K) over control rod. Next, place control rod up through linkage bracket. Secure with another flat washer (K) and hair pin cotter (E). See figure 15.

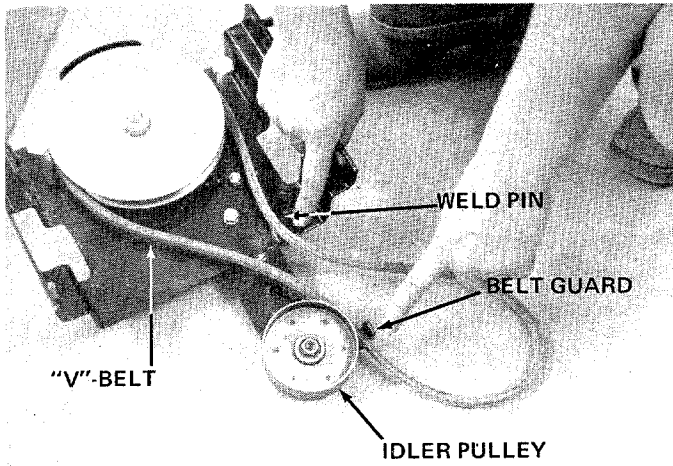

FIGURE 16

14. Be sure belt on idler assembly is in position on idler pulley between belt guard and weld pin as shown in figure 16.

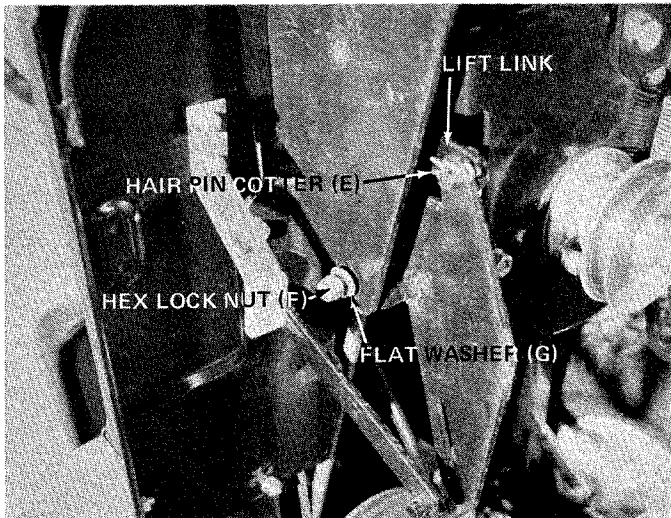

FIGURE 17

15. Place the idler assembly in position between channel supporting brackets and start hex lock nuts (F) and flat washers (G) over weld studs as shown in figure 17.

16. Place lift handle links down through idler assembly and secure to linkage brackets with hair pin cotters (E). See figure 17.

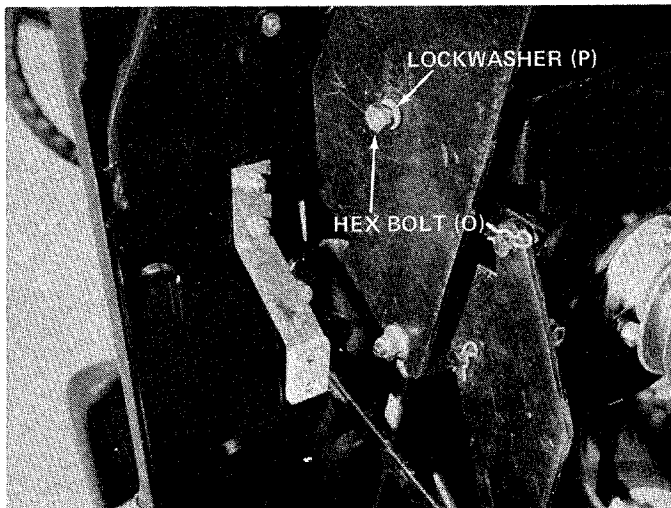

FIGURE 18

17. Start hex bolts (O) and lock washers (P) through center of channel support and idler assembly. See figure 18.

18. Tighten nuts and bolts in steps 15 and 16 securely with wrenches.

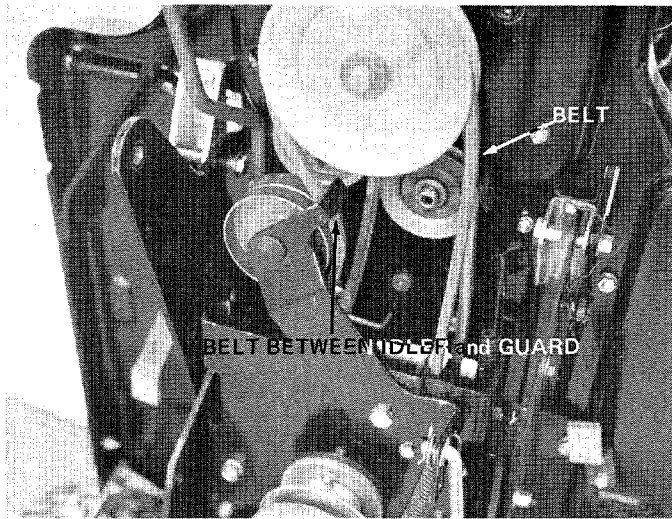

FIGURE 19

19. Slip the idler assembly belt over the engine pulley as shown in figure 19.



Be sure the belt runs between idler pulley and guard as shown in figure 19.

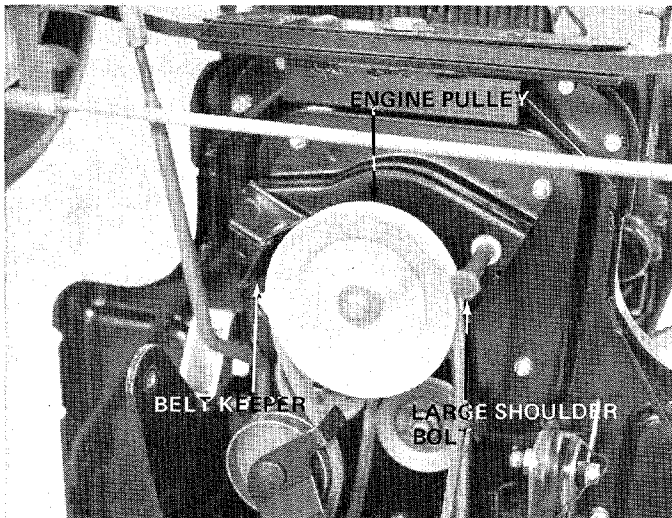

FIGURE 20

20. Replace the engine pulley belt keeper and large shoulder bolt. See figure 20.

21. Set the lawn tractor back down on all four wheels.

22. Roll the lawn tractor over the snow thrower and attach the free end of the 85" belt to the pulley on the idler assembly. Be sure to twist the belt so that the top of belt coming off the idler goes toward the left side of unit. See figure 8.

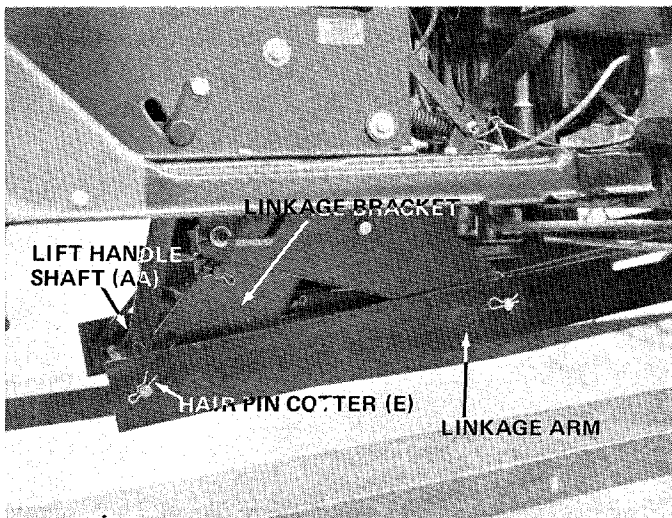

FIGURE 21

23. Place the holes in the end of the linkage arms in line with slot in the linkage brackets and secure with lift handle shaft (AA) and hair pin cotters (E). See figure 21. Lower the lift handle on the lawn tractor to its lowest position.



If belt is installed incorrectly spirals will run in reverse. Twist belt in other direction to correct. Refer to step 22.



Linkage arms must be mounted on the outside of linkage brackets. Refer to figure 21.

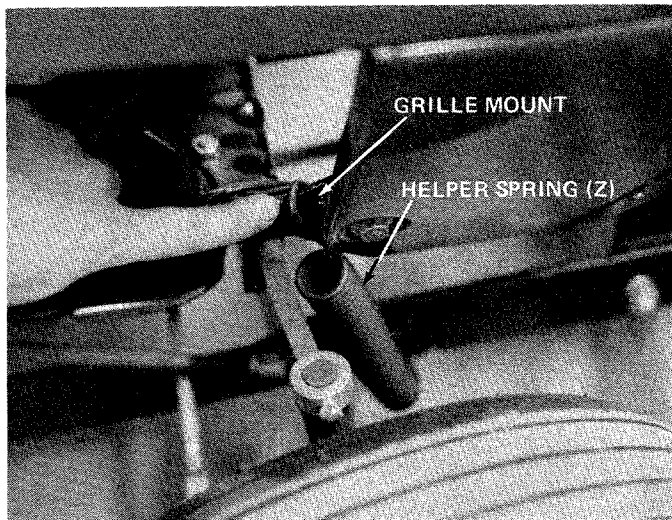

FIGURE 22

24. With a piece of strong wire hook the end of helper springs (Z) up into grille mount on lawn tractor. See figure 22.
25. After springs are installed raise and lower the lift handle on lawn tractor to be sure snow thrower is properly hooked up.
26. Using a 1/2" wrench, tighten securely hex bolts (V) which are threaded into the spring inserts. Refer to step number 4.

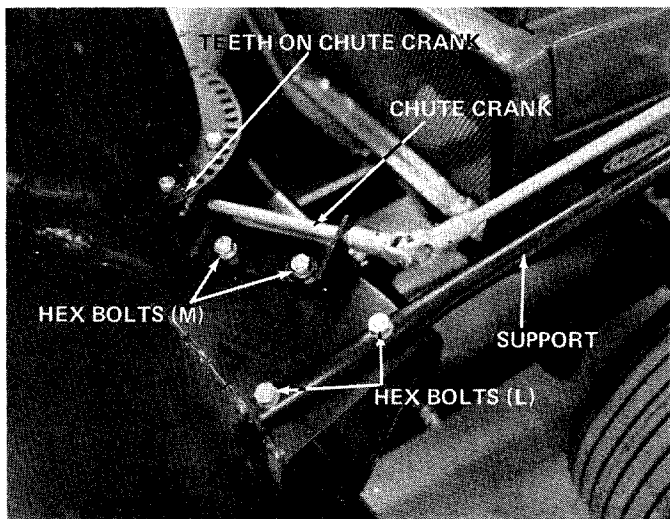

FIGURE 23

27. Attach the pre-assembled chute crank and support (AB) to the snow thrower housing. Secure the support with two hex bolts (L), lock washers (I) and hex nuts (Q). Secure the chute crank with two hex bolts (M), lock washers (I) and hex nuts (Q). See figure 23. Be sure teeth on chute crank link up with holes in chute flange before tightening bolts.
28. Remove the piece of plastic film from the gas cap. Reinstall the battery and replace the spark plug wire.
29. Check tire pressure. It may be necessary to put more air into the front tires due to the weight of the snow thrower.

OPERATING INSTRUCTIONS

This snow thrower is capable of handling heavy snow conditions. If given the opportunity to function within reasonable requirements it should give many years of service. Become fully familiar with all aspects of both the lawn tractor and snow thrower prior to its usage.

BEFORE PLACING SNOW THROWER INTO OPERATION

1. Check all nuts and bolts for correct tightness and be sure that all parts are properly assembled.
2. Test all controls for smooth operation.
 - A. Lift lever
 - B. Discharge chute control crank
 - C. Discharge chute and deflector
3. Starting and stopping snow thrower.

The snow thrower is driven by a V-belt driven from the lawn tractor engine. It is operated through the lift disengagement handle. Start lawn tractor engine and run at full throttle. Slowly engage (push forward) the lift handle.

To stop snow thrower operation, pull the lift handle towards you and lock handle.

DISCHARGE CHUTE CONTROL CRANK

The discharge chute control crank is located on left hand side of lawn tractor. Turn crank to the right to direct snow to the right hand side. Turn it to the left to direct snow to left hand side.

PREPARATION

1. Check the lawn tractor and thrower to make certain both are in good operating condition.
2. Fill gas tank out of doors and avoid spilling gasoline over engine. Do not fill tank while engine is running. Wipe up any spilled gas.
3. Do not remove any guards or covers while operating lawn tractor and thrower.

Snow thrower chute has a discharge radius of 180 degrees. Adjust discharge by turning the chute crank.

TO RAISE AND LOWER SNOW THROWER

Lift lever to raise and lower snow thrower is located on the right hand side of lawn tractor. To raise snow thrower pull back on lift lever until it reaches over center stop. To lower snow thrower, push lift lever forward slowly until snow thrower reaches ground level.



When snow thrower and lawn tractor are not in use, lower snow thrower to ground level. This will prevent excess weight on the front tires.

OPERATING ADJUSTMENTS



When making skid shoe or chute deflector adjustment, turn rider engine off.

Upper Chute Deflector: The upper chute deflector mounted on the top of the chute determines the distance snow is thrown. Moving top of deflector down decreases distance of throw and raising deflector increases distance of throw. Operator must get off lawn tractor to make this adjustment. Disengage spirals (by raising snow thrower) before making this adjustment.

SKID SHOE ADJUSTMENT (See Figure 24)

The skid shoes are mounted on each side of spiral housing. These regulate the distance the shave plate is raised above the plowing surface. When removing snow from a gravel driveway or an uneven surface, it is advisable to keep shave plate as high above the surface as possible to prevent possible damage to spiral.

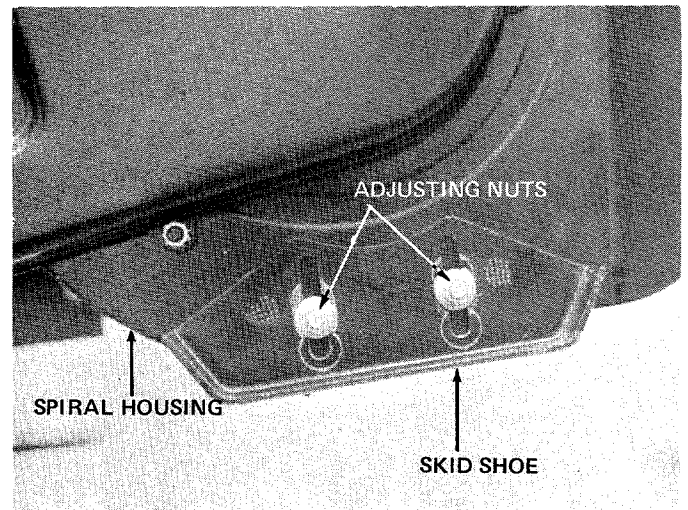

12 FIGURE 24

On blacktop or concrete surface, keep shave plate as close to the surface as possible. Skid shoes can be adjusted so that shave plate will rest directly on the surface. Turning skid shoes around will allow even wear on skid shoes.

Raise snow thrower off the ground and place a block at each end of shave plate. Loosen 4 nuts securing skid shoes to spiral housing (2 nuts on each side). Move skid shoes up or down to desired position and tighten nuts securely. Adjust both skid shoes to the same height to keep spiral level. See figure 24.

OPERATION

The thrower controls are conveniently located at the operator's position on the lawn tractor. By engaging the lift handle to the spiral, snow is thrown through chute by the motion of the spiral. Turning chute crank directs snow discharge and deflector controls distance snow is thrown.



If snow thrower becomes plugged with snow, or jammed due to hitting a foreign object, disengage snow thrower immediately and stop lawn tractor engine. Clear snow from chute if plugged, before resuming operation.



If spiral is jammed or bent from hitting a foreign object, stop lawn tractor engine. Remove spark plug wire from spark plug and then remove foreign object from spiral. If spiral damage is noted, repair prior to continuing operation. Then replace spark plug wire and resume operation.

SNOW CONDITIONS

Snow removal conditions vary greatly from light fluffy snowfall to the wet heavy snow. Therefore, operating instructions must be flexible to fit conditions encountered. The operator must adapt the lawn tractor and snow thrower to depth of snow, wind direction, temperature, and surface conditions.

OPERATING SPEED

The spiral speed is directly related to engine speed. For maximum snow removal and discharge, maintain high engine R.P.M. (full throttle). The lawn tractor's forward speed is controlled by selecting one of the forward speeds. It is advisable to operate the lawn tractor at a slow ground speed (1st gear) for safe and efficient snow removal.

DEEP OR DRIFTED SNOW

In deep, drifted, or banked snow, it will be necessary to use full throttle and first speed. Drive the spiral into the snow, disengage clutch and allow spiral to clear the snow. Repeat this method until a path is cleared. On the second pass, overlap the first enough to allow the spiral to handle the snow without repeated clutching and declutching of the lawn tractor.

In extremely deep snow, raise thrower from the ground, drive lawn tractor ahead in the deep snow to remove top layers first. Do not drive lawn tractor into snow bank where snow has not been removed to ground level. Disengage lawn tractor clutch and allow thrower to clear the snow. Reverse lawn tractor and lower thrower to the ground. Drive lawn tractor ahead and repeat process to remove balance of snow. Working with repeated passes into and out of drifts will eventually move even the deepest of snow piles.

OPERATING TIPS

1. Whenever possible discharge snow down wind.
2. Do not attempt to remove ice or hard packed frozen snow.
3. Always overlap each pass slightly to assure complete snow removal.
4. A frozen or stuck spiral or chute must be broken loose or thawed with care. When attempting to loosen frozen or jammed spiral, shut off rider engine and remove spark plug wire. Never attempt to clear snow thrower at any time with lawn tractor engine running.

USE OF TIRE CHAINS

Tire chains should always be used when extra traction is needed. They add maneuverability in handling snow removal jobs.

LUBRICATION

1. Spiral drive chain: Lubricate chain every 40 operating hours with No. 30 oil. It is important that oil reaches inside each roller. Wipe off excess oil from chain.
2. Pivot and friction points: To maintain smooth and free operation, apply a few drops of No. 30 oil as required to all pivot and friction points.

The spiral and idler pulley bearings are self-lubricating. However, periodic lubrication with No. 30 oil will lengthen service life.

SPIRAL DRIVE CHAIN ADJUSTMENT

Periodically check spiral drive belt to insure that it is properly adjusted. It is important to maintain proper belt adjustment to obtain maximum belt life.

If belt is stretched beyond idler take up, replace with a new belt of the type specified in parts list.

Excessive slack in spiral drive chain due to normal chain stretch can be removed by adjusting spiral housing nuts.

TO ADJUST SPIRAL CHAIN:

1. Disengage snow thrower and loosen the mounting nuts 2 or 3 complete turns.
2. Tighten the adjustment mounting nuts to tighten chain.



Do not over tighten chain. A correctly adjusted chain will have a slight amount of slack. An over tightened chain will result in early failure of chain.

3. Tighten mounting nuts to secure chain adjustment. Check chain clearance. It must clear chain guard assembly. Test chain and repeat adjustment if necessary until all excess slack is removed.

SHAVE PLATE AND SKID SHOES

Both the shave plate and skid shoes are subject to wear and are designed to be easily replaced. Replace before wear is excessive. Failure to do so will result in damage to the spiral housing.

BELT TENSION ADJUSTMENT

The idler bracket has three holes for belt tension adjustment. As the belt stretches from normal wear, more belt tension may be required. Check the idler spring for wear against the drive shaft at least once a season. If the idler spring is rubbing against the drive shaft, the belt has stretched and must be adjusted. Remove the idler pulley from the bracket, and reassemble in next lower hole on the bracket.

STORAGE

At the end of the snow season the following steps are recommended:

1. Remove snow thrower assembly from lawn tractor tractor.
2. Wash off any salt deposit which may have dried on the thrower and housing. Paint or cover exposed metal with a light coat of oil.
3. Lubricate thrower following lubricating instructions for recommended lubricant. Thrower drive chain must be oiled thoroughly to prevent rust from forming. The preferred method is to remove the chain and soak in oil for several hours before reinstalling.
4. Store thrower in a dry place.

NOTES

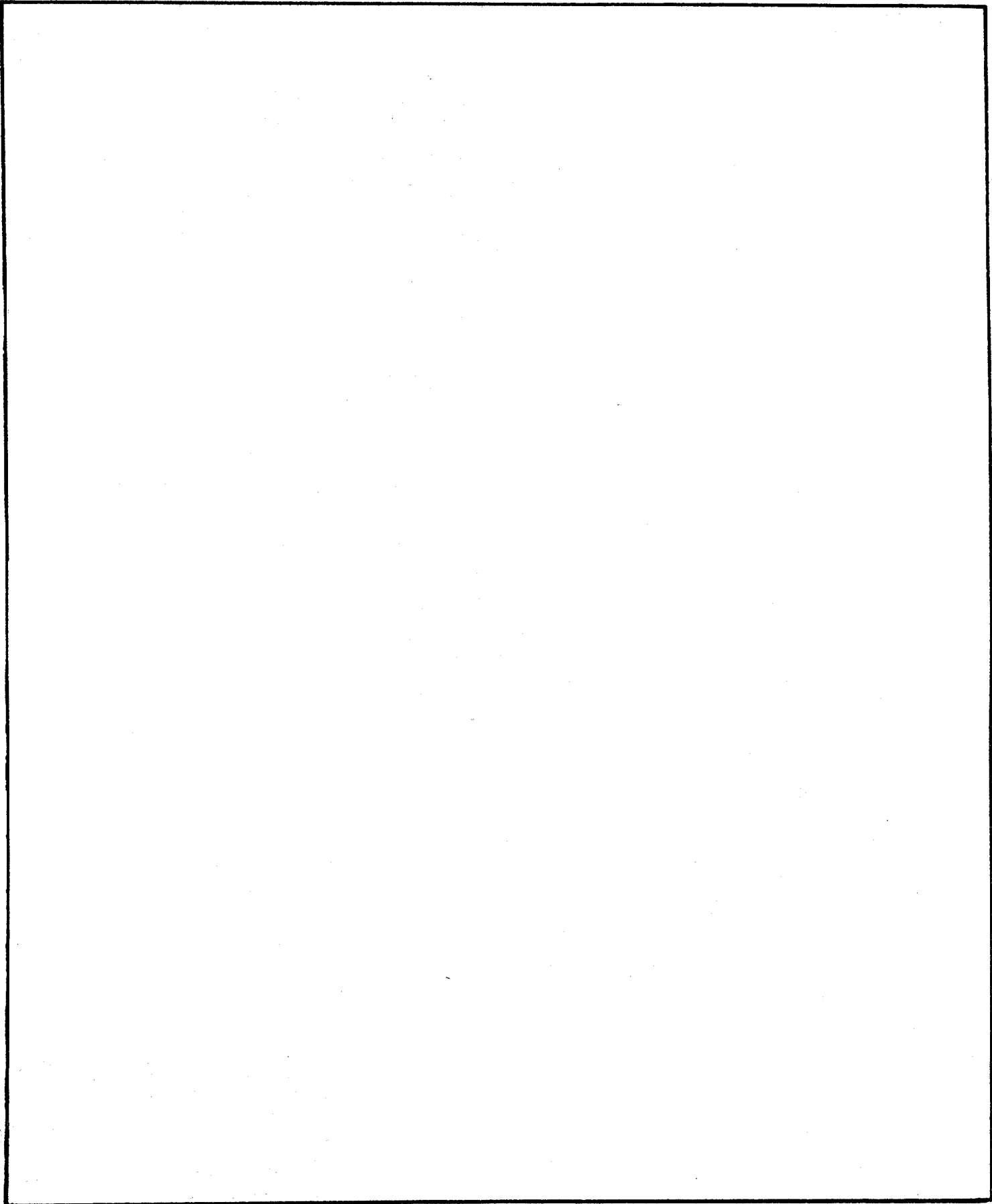

190-469A

TMO-33849A

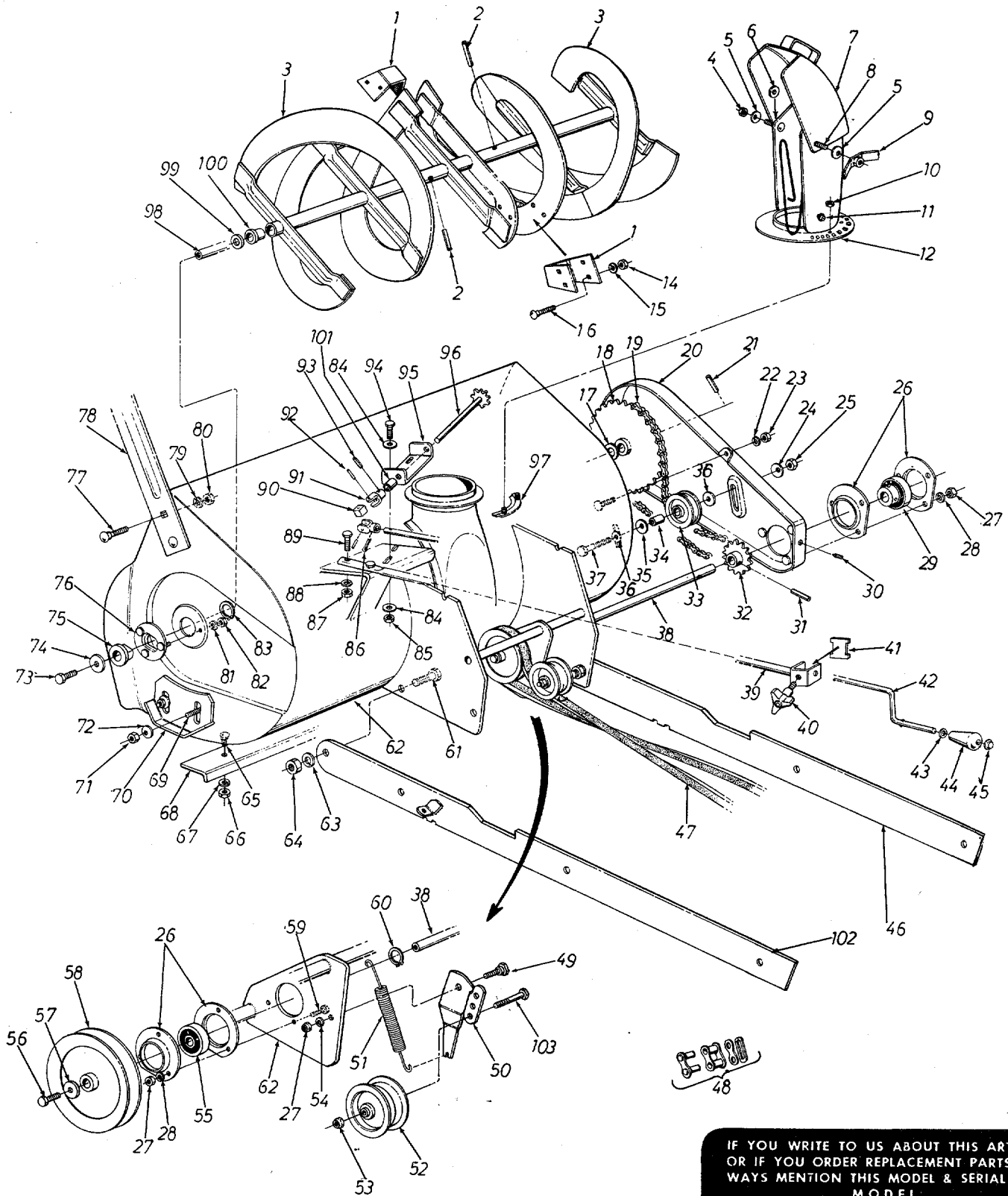

IF YOU WRITE TO US ABOUT THIS ARTICLE
OR IF YOU ORDER REPLACEMENT PARTS AL-
WAYS MENTION THIS MODEL & SERIAL NO
MODEL

PARTS LIST FOR 190-469A and TMO-33849A 36" SNOW THROWER ATTACHMENT

REF. NO.	PART NO.	COLOR CODE	DESCRIPTION	NEW PART	REF. NO.	PART NO.	COLOR CODE	DESCRIPTION	NEW PART
1	05023		Spiral Plate		52	756-0217		Fl. Idler with Flange	
2	715-0118		Spring Pin Spir. 5/16 x 1.75" Lg.		53	712-0130		Hex Ins. Jam Nut 3/8-16 Thd.	
3	05375		Spiral Ass'y.		54	736-0119		L-Wash. 5/16" Scr.*	
4	712-0158		Hex Cent. L-Nut 5/16-18 Thd.*		55	741-0174		Self Aligning Brg.	
5	736-0105		Bell. Wash.		56	710-0538		Hex Scr. 5/16-18 x .62" Lg.	
6	736-0179		FI-Wash.		57	736-0231		FI-Wash.	
7	05225		Top Chute Ass'y.		58	756-0215		5.50 O.D. x 5/8 Pulley	
8	710-0260		Car. Bolt 5/16-18 x .62" Lg.*		59	710-0198		Hex Sems Scr. 5/16-18 x .75"	
9	05140		Chute Wing Ass'y.		60	716-0119		Snap Ring for .75 Dia. Shaft	
10	712-0107		Hex Cent. L-Nut 1/4-20 Thd.		61	710-0474		Hex Scr. 1/2-13 x 1.25" Lg.*	
11	726-0111		Push Cap .188" Dia. Rod		62	05432		Spiral Housing Ass'y.	
12	05404		Chute Ass'y.		63	736-0921		L-Wash. 1/2" Scr.*	
14	712-0267		Hex Nut 5/16-18 Thd.*		64	712-0206		Hex Nut 1/2-13 Thd.*	
15	736-0119		L-Wash. 5/16" Scr.*		65	710-0260		Car. Bolt 5/16-18 x .62" Lg.*	
16	710-0260		Car. Bolt 5/16-18 x .62" Lg.*		66	712-0267		Hex Nut 5/16-18 Thd.*	
17	736-0163		FI-Wash.		67	736-0119		L-Wash. 5/16" Scr.*	
18	713-0177		Sprocket Hub Ass'y.—40 Teeth		68	05378		Shave Plate	
19	713-0189		#420 Chain x 1/2" Pitch—77 Links		69	710-0389		Car. Bolt 3/8-16 x .75" Lg.*	
20	05379		Chain Guard Ass'y.		70	05002		Slide Shoe	
21	715-0118		Spring Pin Spir.—5/16		71	712-0798		Hex Nut 3/8-16	
22	736-0119		L-Wash. 5/16" Scr.*		72	736-0105		Bell. Wash.	
23	712-0267		Hex Nut 5/16-18" Thd.*		73	710-0538		Hex Scr. 5/16-18 x .62" Lg.	
24	736-0105		Bell. Wash.		74	736-0227		FI-Wash.	
25	712-0130		Hex Ins. L-Nut 3/8-16" Thd.		75	741-0170		Flange Brg. with Flats	
26	05244		Bearing Housing		76	05360		Brg. Housing Ass'y.	
27	712-0267		Hex Nut 5/16-18" Thd.*		77	710-0260		Car. Bolt 5/16-18 x .62" Lg.*	
28	736-0119		L-Wash. 5/16" Scr.*		78	05139		Guide Blade	
29	741-0162		Self Aligning Brg. w/Set Scr.		79	736-0119		L-Wash. 5/16" Scr.*	
30	—		Comes with Ref. No. 29		80	712-0267		Hex Nut 5/16-18 Thd.*	
31	715-0118		Spring Pin Spir.—5/16 x 1.75		81	736-0119		L-Wash. 5/16" Scr.*	
32	713-0188		14 Teeth Sprocket Ass'y.		82	712-0267		Hex Nut 5/16-18 Thd.*	
33	756-0192		1.875" Dia. Flat Idler		83	716-0121		Snap Ring for 1.50" Dia. Shaft	
34	750-0252		Idler Spacer		84	736-0242		Bell. Wash.	
35	736-0235		FI-Wash.		85	712-0267		Hex Nut 5/16-18 Thd.*	
36	736-0300		FI-Wash.		86	714-0111		Cotter Pin 3/32 x 1.00" Lg.*	
37	710-0427		Hex Scr. 3/8-16 x 2.00" Lg.*		87	712-0267		Hex Nut 5/16-18 Thd.*	
38	738-0244		Drive Shaft		88	736-0119		L-Wash. 5/16" Scr.*	
39	05401		Crank Support Tubing Ass'y.		89	710-0376		Hex Scr. 5/16-18 x 1.00" Lg.*	
40	720-0170		Hand Knob 5/16-18 Thd.		90	711-0584		Joint Block	
41	05403		Chute Crank Brkt.		91	05066		Joint Brkt. Ass'y.	
42	05120		Chute Crank		92	715-0139		Spring Pin Roll 3/16" x .81" Lg.*	
43	736-0117		FI-Wash.		93	715-0103		Spring Pin Roll 1/8 x .75" Lg.*	
44	720-0171		Knob—Black 3/8" Dia. Hole		94	710-0118		Hex Scr. 5/16-18 x .75" Lg.*	
45	726-0100		Push Nut 3/8" Rod		95	05402		Chute Brkt.	
46	05837		Linkage Arm Ass'y.	N	96	05118		Sprocket Shaft Ass'y.	
47	754-0236		"V"-Belt 1/2" x 85" Lg.(Kevlar)		97	05031		Chute Flange Keeper Ass'y.	
48	713-0154		Master Link for #420 Chain		98	738-0229		Spiral Axle	
49	738-0140		Shoulder Scr.		99	736-0250		FI-Wash.	
50	05724		Idler Brkt. Ass'y.	N	100	05136		Plastic Bushing	
51	732-0383		Extension Spring		101	748-0193		Spacer .380 I.D. x .630 O.D. x .565	
					102	05838		Linkage Arm Ass'y.—R.H.	N
					103	710-0347		Hex Bolt 3/8-16 x 1.75" Lg.*	

*For faster service obtain standard nuts, bolts and washers locally. If these items cannot be obtained locally, order by part number and size as shown on parts list.

190-469A TMO-33849A

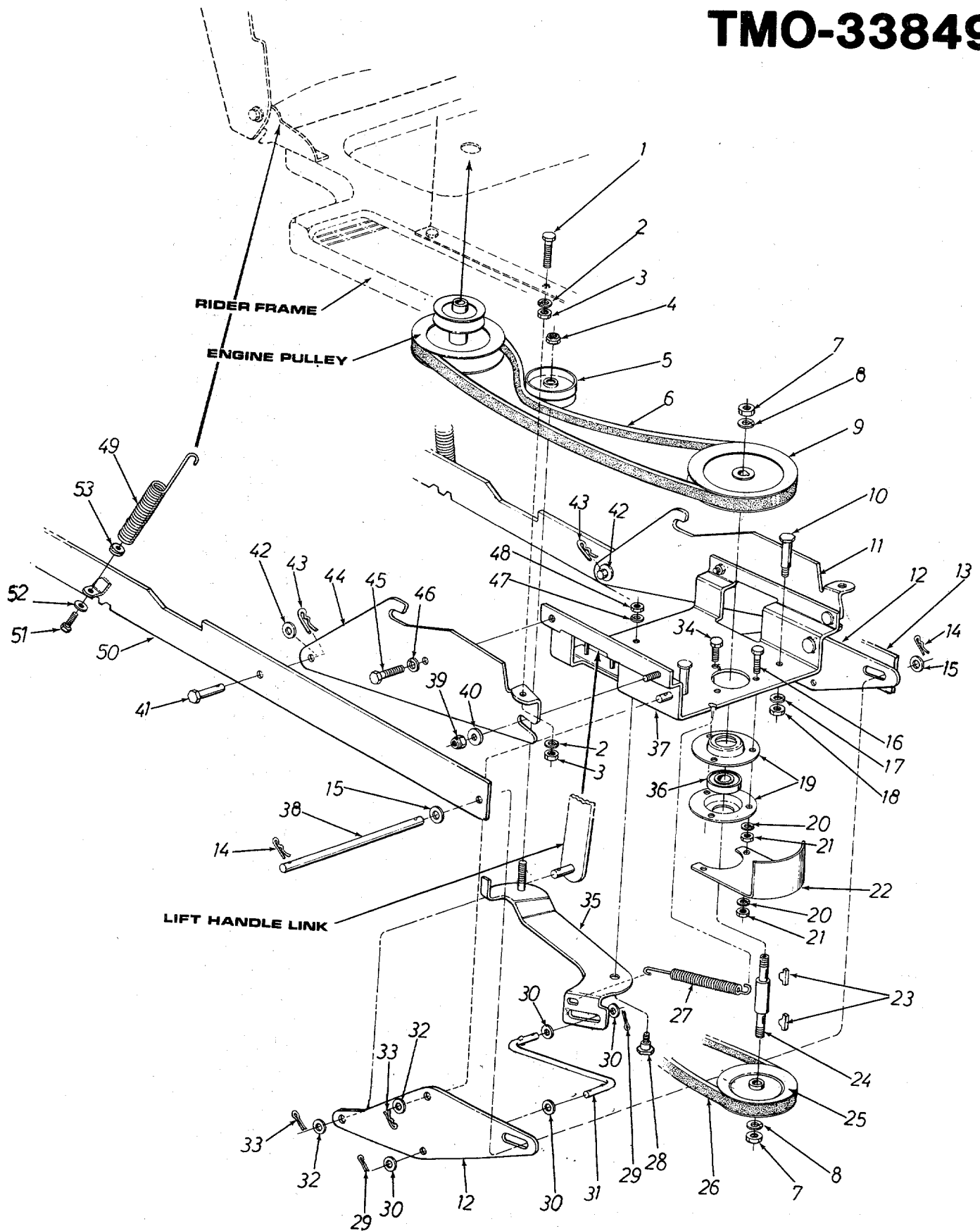

EXPLODED VIEW

PARTS LIST FOR 190-469A and TMO-33849A 36" SNOW THROWER ATTACHMENT

REF. NO.	PART NO.	COLOR CODE	DESCRIPTION	NEW PART
1	710-0528		Hex Scr. 5/16-18 x 1.25" Lg. *	
2	736-0119		L-Wash. 5/16" Scr. *	
3	712-0267		Hex Nut 5/16-18 Thd. *	
4	712-0116		Hex Ins. Jam Nut 3/8-24 Thd.	
5	756-0218		Flat Idler 3.25" O.D.	
6	754-0185		"V"-Belt 1/2 x 49" Lg.	
7	712-0242		Hex Jam Nut 5/8-11 Thd.	
8	736-0158		L-Wash.	
9	756-0216		6.50" O.D. x 5/8 Pulley	
10	738-0129		Shoulder Screw	
11	05644		Channel Supporting Brkt.-R.H.	
12	05835		Linkage Brkt.	N
13	05838		Linkage Arm Ass'y.—R.H.	N
14	714-0101		Intern. Cotter Pin .500" Dia. *	
15	736-0192		FI-Wash.	
16	710-0528		Hex Scr. 5/16-18 x 1.25" Lg. *	
17	736-0169		L-Wash. 3/8" Scr. *	
18	712-0798		Hex Nut 3/8-16 Thd. *	
19	08253		Bearing Housing	
20	736-0119		L-Wash. 5/16" Scr. *	
21	712-0267		Hex Nut 5/16-18" Thd. *	
22	05406		Belt Guard	
23	714-0388		#61 Hi-Pro-Key 3/16 x 5/8" Dia.	
24	738-0246		Pulley Spindle	
25	756-0213		4.00 O.D. x 5/8 Pulley	
26	754-0202		"V"-Belt 1/2 x 85" Lg.	
27	732-0146		Extension Spring	
28	738-0140		Shoulder Screw	
29	714-0111		Cotter Pin 3/32" Dia. x 1.00"*	
30	736-0300		FI-Wash.	
31	747-0131		Control Rod	
32	736-0192		FI-Wash.	
33	714-0101		Intern. Cotter Pin .500" Dia. *	
34	710-0198		Hex Sems Scr. 5/16-18 x .75"*	
35	05409		Clutch Idler Brkt. Ass'y.	
36	741-0919		Ball Bearing	
37	05411		Channel Ass'y.	
38	738-0242		Lift Handle Shaft	
39	712-0130		Hex Ins. L-Nut 3/8-16" Thd.	
40	736-0300		FI-Wash.	
41	711-0310		Lift Brkt. Pin 1/2 x 1-3/16" Lg.	
42	736-0192		FI-Wash.	
43	714-0101		Intern. Cotter Pin .500" Dia. *	
44	05645		Channel Supporting Brkt.-R.H.	
45	710-0253		Hex Scr. 3/8-16 x 1.00" Lg. *	
46	736-0169		L-Wash. 3/8" Scr. *	
47	736-0119		L-Wash. 5/16" Scr.	
48	712-0267		Hex Nut 5/16-18" Thd. *	
49	732-0323		Helper Spring	
50	05837		Linkage Arm Ass'y.—L.H.	N
51	710-0646		Hex Scr. 5/16-18 x 2.0" Lg. Special	
52	736-0159		FI-Wash. 5/16" Scr. *	
53	711-0509		Spring Insert	

PARTS INFORMATION

POWER EQUIPMENT PARTS AND SERVICE

Parts and service for all MTD manufactured power equipment are available through the authorized service firms listed below. All orders should specify the model number of your unit, parts number description of parts and the quantity of each part required.

ALABAMA	BIRMINGHAM	
Auto Electric & Carburetor Co.	2625 4th Ave. S.	35233
ARKANSAS	FORT SMITH	
Mity Mite Motors, Inc.	4515 South 16th Street 72901	
	NORTH LITTLE ROCK	
Sutton's Lawn Mower Shop	Rt. 4 Box 368.	72117
CALIFORNIA	PORTERVILLE	
Billious	75 North D Street	93257
	SAN BERNARDINO	
Lawn Mower Supply Co.	25608 E. Baseline	92410
	SAN FRANCISCO	
J.W. Jewett Co.	981 Folsom St.	94107
COLORADO	DENVER	
South Denver Lawn Equip.	527 West Evans	80223
FLORIDA	JACKSONVILLE	
Radco Distributors	2403 Market St.	32206
	OPA LOCKA	
Small Eng. Dist.	2351 N.W. 147th St.	33054
GEORGIA	EAST POINT	
East Point Cycle & Key	2834 Church St.	30344
ILLINOIS	LYONS	
Keen Edge Co.	8615 Ogden Ave.	60534
INDIANA	ELKHART	
Parts & Sales Inc.	2101 Industrial Pkwy.	46514
IOWA	DUBUQUE	
Power Lawn & Garden Equip.	2551 J.F. Kennedy	52001
LOUISIANA	NEW ORLEANS	
Suhren Engine Co.	8330 Earhart Blvd.	70118
MARYLAND	TAKOMA PARK	
Center Supply Co.	6867 New Hampshire Ave.	20012
MASSACHUSETTS	SPRINGFIELD	
Morton B. Collins Co.	300 Birnie Ave.	01107
MICHIGAN	LANSING	
Lorenz Service Co.	2500 S. Pennsylvania	48910
	MOUNT CLEMENS	
Power Equipment Dist.	36463 South Gratiot . . .	48043
MINNESOTA	HOPKINS	
Hance Distributing Inc.	420 Excelsior Ave. W.	55343
	ST. PAUL	
Power Tools Inc.	3771 Sibley Memorial Hwy. .	55122
MISSISSIPPI	BILOXI	
Biloxi Sales & Service, Inc.	506 Caillavet St.	39533
MISSOURI	KANSAS CITY	
Automotive Equip. Service	3117 Holmes St.	64109
	ST. JOSEPH	
Ross-Frazier Supply Co.	8th and Monteray	64503
	ST. LOUIS	
Henzler, Inc.	2015 Lemay Ferry Rd.	63125
NEW JERSEY	BELLMAWR	
Lawnmower Parts Inc.	717 Creek Rd.	08030
	RUTHERFORD	
Feld Distributor	28 Glen Rd.	07070
NEW YORK	CARTHAGE	
Gamble Dist., Inc.	West End Ave.	13619

BRIGGS AND STRATTON, TECUMSEH AND PEERLESS PARTS AND SERVICE

Briggs & Stratton, Tecumseh and Peerless parts and service should be handled by your nearest authorized engine service firm. Check the yellow pages of your telephone directory under the listing **Engines—Gasoline, Briggs & Stratton or Tecumseh Lauson.**

	SYRACUSE	
GTP Leisure Products Inc.	420 Marcellus St.	1321
NORTH CAROLINA	GOLDSBORO	
Smith Hardware Co.	515 N. George St.	27530
	GREENSBORO	
Dixie Sales Company	327 Battleground Ave.	27402
OHIO	CARROLL	
Stebe's Mid-State Mower Supply ...	Box 366-71 High St. ...	43112
	CLEVELAND	
Bleckrie, Inc.	7900 Lorain Ave.	44102
	WADSWORTH	
National Central	687 Seville Rd.	44281
	YOUNGSTOWN	
Burton Supply Co.	1301 Logan Ave. Box 929 . .	44501
OKLAHOMA	ADA	
Ada Auto Supply	301 E. 12th St.	74820
	MUSKOGEE	
Victory Motors, Inc.	605 S. Cherokee.	74401
	OKLAHOMA CITY	
Forest Sales Inc.	1039 NW 63rd St.	73116
OREGON	PORTLAND	
Kenton Supply Co.	8216 N. Denver Ave. ...	97217
PENNSYLVANIA	CHESTER	
Stull Equipment Corp.	742 W. Front St.	19013
	HARRISBURG	
EECO Inc.	4021 N. 6th St.	17110
	PHILADELPHIA	
Thompson Rubber Co.	5222-24 N. Fifth St. ...	19120
	PITTSBURGH	
Bluemont Co.	11125 Frankstown Rd.	15235
TENNESSEE	KNOXVILLE	
Master Repair Service.	2000 Western Ave. ...	37921
	MEMPHIS	
Memphis Cycle & Supply Co.	421 Monroe Ave.	38101
American Sales & Service, Inc.	1922 Lynnbrook	38116
TEXAS	DALLAS	
Marr Brothers, Inc.	423 E. Jefferson.	75203
	FORT WORTH	
Woodson Sales Corp.	1702 N. Sylvania	76111
	HOUSTON	
Bullard Supply Co.	2409 Commerce St.	77003
	SAN ANTONIO	
Catto & Putty, Inc.	414 Live Oak	78298
UTAH	SALT LAKE CITY	
A-1 Engine & Mower Co.	437 E. 9th St.	84111
VERMONT	BURLINGTON	
Vermont Hdwe. Co. Inc.	180 Flynn Ave.	05401
VIRGINIA	RICHMOND	
RBI Corp.	963 Myers St.	23260
WASHINGTON	SEATTLE	
Bailey's Inc.	1414 14th Ave.	98102
WEST VIRGINIA	CHARLESTON	
Young's, Inc.	233 Virginia St., E.	25301
WISCONSIN	APPLETON	
Automotive Supply Co.	123 S. Linwood Ave. ...	54911

WARRANTY PARTS AND SERVICE POLICY

The purpose of warranty is to protect the customer from defects in workmanship and materials, defects which are NOT detected at the time of manufacture. It does not provide for the unlimited and unrestricted replacement of parts. Use and maintenance are the responsibility of the customer. The manufacturer cannot assume responsibility for conditions which it has no control. Simply put, if it's the manufacturer's fault, it's the manufacturer's responsibility; if it's the customer's fault, it's the customer's responsibility.

CLAIMS AGAINST THE MANUFACTURER'S WARRANTY INCLUDES

1. Replacement of Missing Parts on new equipment.
2. Replacement of Defective Parts within the warranty period.
3. Repair of Defects within the warranty period.

All claims MUST be substantiated with the following information:

1. Model Number of unit involved.
2. Date unit was purchased or first put into service.
3. Date of failure.
4. Nature of failure.

MTD PRODUCTS INC • 5965 GRAFTON ROAD • P.O. BOX 36900 • CLEVELAND OHIO 44136

Free Manuals Download Website

<http://myh66.com>

<http://usermanuals.us>

<http://www.somanuals.com>

<http://www.4manuals.cc>

<http://www.manual-lib.com>

<http://www.404manual.com>

<http://www.luxmanual.com>

<http://aubethermostatmanual.com>

Golf course search by state

<http://golfingnear.com>

Email search by domain

<http://emailbydomain.com>

Auto manuals search

<http://auto.somanuals.com>

TV manuals search

<http://tv.somanuals.com>