

FIFTY CENTS

**Model No.  
310-430A**



**21"  
SNOW  
THROWER**

# **OWNER'S MANUAL**

**ASSEMBLY  
OPERATION  
MAINTENANCE  
PARTS LIST**

**Important:**

**Read Safety Rules and  
Instructions Carefully**



**NOTE**

**This snow thrower has provisions  
for optional 110V starter (390-986).**

# INDEX

Limited Warranty .....	2	Lubrication .....	16
Safe Operation Practices .....	3	Maintenance .....	17
Assembly Instructions .....	4	Illustrated Parts .....	20, 22, 24
Operation .....	11	Parts List .....	21, 23, 25, 26
Adjustments .....	14	Parts Information .....	Back Cover

## LIMITED WARRANTY

For one year from the date of original retail purchase, MTD PRODUCTS INC. will either repair or replace, at its option, free of charge, F.O.B. factory or authorized service firm, any part or parts found to be defective in material or workmanship. Transportation charges for any parts submitted for replacement under this warranty must be paid by the purchaser unless such return is requested by MTD PRODUCTS INC.

This warranty will not apply to any part which has become inoperative due to misuse, excessive use, accident, neglect, improper maintenance, alterations, or unless the unit has been operated and maintained in accordance with the instructions furnished. This warranty does not apply to the engine, motor, battery, battery charger or component parts thereof. Please refer to the applicable manufacturer's warranty on these items.

This warranty will not apply where the unit has been used commercially.

Warranty service is available through your local authorized service dealer or distributor. If you do not know the dealer or distributor in your area, please write to the Customer Service Department of MTD.

The return of a complete unit will not be accepted by the factory unless prior written permission has been extended by MTD.

This warranty gives you specific legal rights. You may also have other rights which vary from state to state.

# SAFE OPERATION PRACTICES FOR SNOW THROWERS

## TRAINING

1. Read the Owner's guide instruction manual carefully. Be thoroughly familiar with the controls and proper use of the equipment. Know how to stop the unit and disengage the controls quickly.
2. Never allow children to operate equipment. Never allow adults to operate equipment without proper instructions.
3. Keep the area of operation clear of all persons, especially small children and pets.
4. Exercise caution to avoid slipping or falling, especially when operating in reverse.

## PREPARATION

1. Thoroughly inspect the area where the equipment is to be used and remove all door mats, sleds, boards, wires and other foreign objects.
2. Disengage all clutches and shift into neutral before starting engine.
3. Do not operate equipment without wearing adequate winter outer garments. Wear footwear which will improve footing on slippery surfaces.
4. Handle fuel with care. It is highly flammable.
  - (A) Use approved fuel container.
  - (B) Never add fuel to a running engine or hot engine.
  - (C) Fill fuel tank outdoors with extreme care. Never fill fuel tank indoors.
  - (D) Replace gasoline cap securely and wipe up spilled fuel.
5. Use a grounded three wire plug-in for all units with electric drive motors or electric starting motors.
6. Adjust collector housing height to clear gravel or crushed rock surface.
7. Never attempt to make any adjustments while engine is running (except where specifically recommended by manufacturer).
8. Let engine and machine adjust to outdoor temperature before starting to clear snow.

## OPERATION

1. Do not put hands or feet near rotating parts. Keep clear of discharge opening at all times.
2. Exercise extreme caution when operating on or crossing a gravel drive, walks, or roads. Stay alert for hidden hazards or traffic. Do not carry passengers.
3. After striking a foreign object, stop the engine, remove wire from spark plug, thoroughly inspect the snow thrower for any damage, and repair the damage before restarting and operating the snow thrower.
4. If the snow thrower should start to vibrate abnormally, stop the engine and check immediately for the cause. Vibration is generally a warning of trouble.
5. Stop engine whenever you leave the operating position, before unclogging the collector/

impeller housing or discharge guide, and making any repairs, adjustments, or inspections.

6. Take all possible precautions when leaving the vehicle unattended. Disengage the power take-off, lower the attachment, shift into neutral, set the parking brake, stop the engine, and remove the key.
7. When cleaning, repairing, or inspecting make certain collector/impeller, and all moving parts have stopped. Disconnect spark plug wire and keep away from plug to prevent accidental starting.
8. Do not run engine indoors, except when starting engine and for transporting snow thrower in or out of building. Open doors. Exhaust fumes are dangerous.
9. Do not clear snow across the face of slopes. Exercise extreme caution when changing direction on slopes. Do not attempt to clear steep slopes.
10. Never operate snow thrower without guards, plates, or other safety protection devices in place.
11. Never operate snow thrower near glass enclosure, automobiles, window wells, drop-off, etc. without proper adjustments of snow thrower discharge angle. Keep children and pets away.
12. Do not overload machine capacity by attempting to clear snow at too fast a rate.
13. Never operate machine at high transport speeds on slippery surfaces. Use care when backing.
14. Never direct discharge at bystanders or allow anyone in front of unit.
15. Disengage power to collector/impeller when transporting or not in use.
16. Use only attachments and accessories approved by the manufacturer of snow thrower (such as wheel weights, counter weights, cabs, etc.).
17. Never operate the snow thrower without good visibility or light. Always be sure of your footing and keep a firm hold on the handles. Walk, never run.

## MAINTENANCE AND STORAGE

1. Check shear bolts, engine mounting bolts, etc. at frequent intervals for proper tightness to be sure equipment is in safe working condition.
2. Never store machine with fuel in the fuel tank inside a building where open flame or spark are present. Allow engine to cool before storing in any enclosure.
3. Always refer to owner's guide instructions for important details if snow thrower is to be stored for an extended period.
4. Run machine a few minutes after throwing snow to prevent freeze up of collector/impeller.



**CAUTION**

The snow thrower is shipped without gas or oil. See operating section of this manual after assembly.



**NOTE**

Reference to right hand or left hand side of machine are observed from the operating position.

## ASSEMBLY INSTRUCTIONS

### Tools Required for Assembly

- 9/16" Wrench
- 1/2" Wrench
- 7/16" Wrench or
- or One Adjustable Wrench
- Screwdriver
- Hammer
- Block of Wood

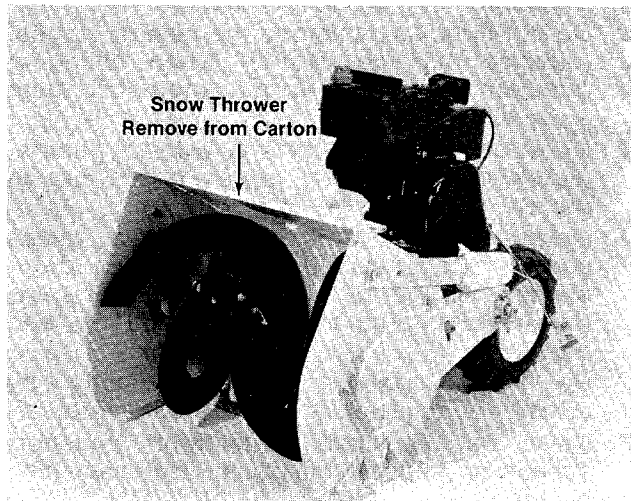

**FIGURE 1.**

1. Remove snow thrower and all parts from the carton. Make certain that all loose parts and literature have been removed before the carton is discarded.

2. Extend throttle control assembly which is attached to engine at rear of the snow thrower and place on floor.



**CAUTION**

Do not bend or kink control wire.

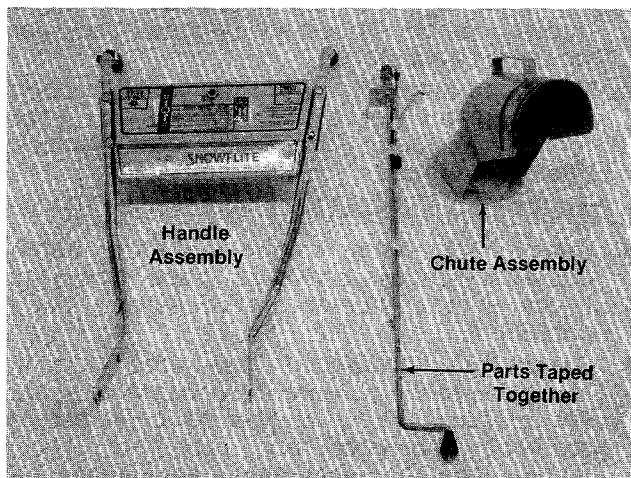

**FIGURE 2.**

### Loose Parts in Carton

- (1) Handle Assembly
- (1) Parts Taped Together which Includes:
  - (1) Chute Crank Assembly
  - (1) Shifting Rod
  - (1) Clutch Rod Assembly
- (1) Chute Assembly

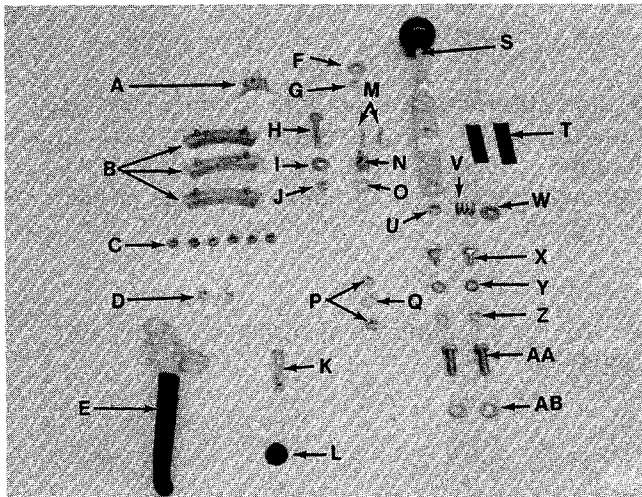

FIGURE 3.

### Contents of Hardware Pack

- A (2) Ignition Keys
- B (3) Chute Flange Keepers
- C (6) Hex Cent. Lock Nut 1/4-20 Thd.
- D (2) Self-Tapping Screws #8 x .50" Lg.
- E (1) Auger Clutch Grip Assembly—L.H.
- F (1) Belleville Washer .34 I.D. x .88 O.D.
- G (1) Hex Nut 5/16-18 Thd.
- H (1) Carriage Bolt 5/16-18 x 1.75" Lg.
- I (1) Belleville Washer
- J (1) Hex Nut 5/16-18 Thd.
- K (1) Clevis Pin
- L (1) Push Cap
- M (2) Cotter Pins 3/32" Dia. x 1.00" Lg.
- N (1) Ferrule
- O (1) Flat Washer .344 I.D. x .88 O.D.
- P (2) Hex Jam Nut 5/16-24 Thd.
- Q (1) Lock Washer 5/16" Scr.
- S (1) Shift Lever
- T (2) Vinyl Tape
- U (1) Elastic Lock Nut 3/8-24 Thd.
- V (1) Compression Spring
- W (1) Belleville Washer .40 I.D. x .88 O.D.
- X (2) Carriage Bolts 5/16-18 x .62" Lg.
- Y (2) Lock Washers 5/16" Scr.
- Z (2) Hex Nuts 5/16-18 Thd.
- AA (2) Hex Screws 3/8-16 x .88" Lg.
- AB (2) Lock Washer 3/8" Scr.

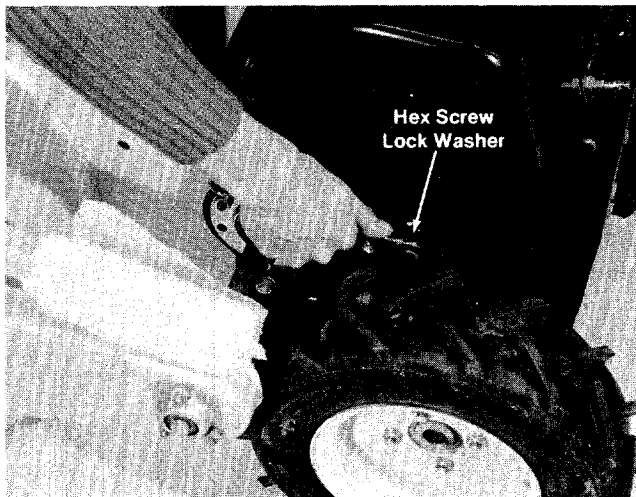

FIGURE 4.

3. To attach handle assembly to the snow thrower, first remove the hex screw and lock washer from each side of snow thrower housing. A 9/16" wrench is required. See figure 4.

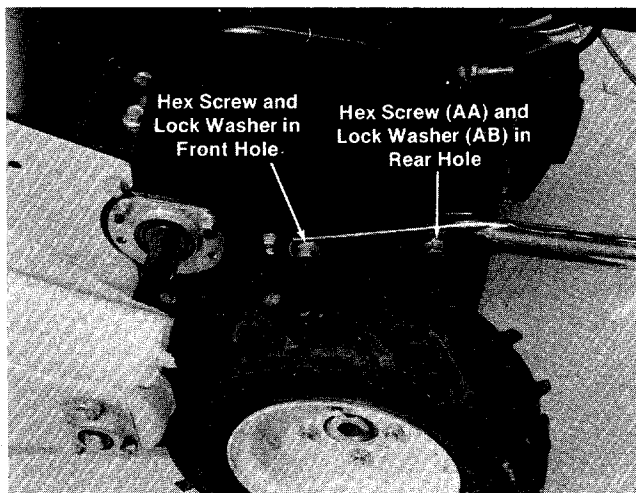
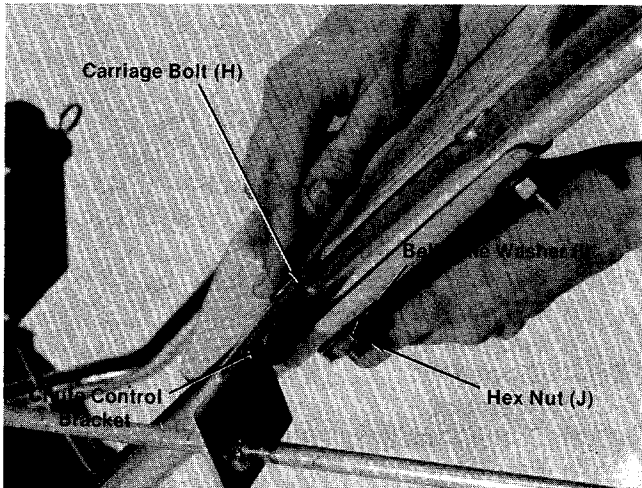

FIGURE 5.

4. Fasten handle assembly to snow thrower housing. Place lock washer (AB) on hex screw (AA). Line up holes in handle with holes in sides of snow thrower housing. Start hex screws into rear holes by hand. Replace hex screw and lock washer in front hole. See figure 5. **Do not** tighten at this time.

### NOTE

Loosen the three hex nuts which hold the handle panel to the handle. This will permit handle to move freely so it can be assembled to the housing with greater ease. Leave hex nuts loose.



**FIGURE 6.**

5. Attach chute crank assembly to unit. Line up hole in chute control bracket with hole in handle. Secure with carriage bolt (H), belleville washer (I) and hex nut (J) as shown in figure 6.

6. At this point, tighten securely all nuts and bolts.

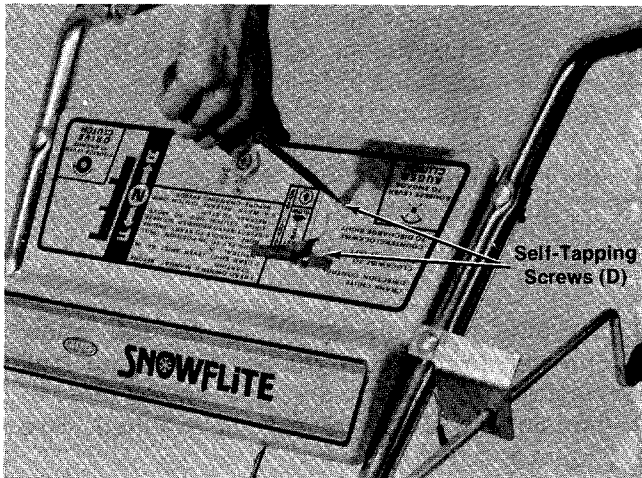

**FIGURE 7.**

7. Hold throttle control underneath handle panel. Bring throttle control knob through the slot in handle panel. Line up the two holes in the throttle control with the two holes in handle panel. Secure with self-tapping screws (D). A screwdriver is required. See figure 7.

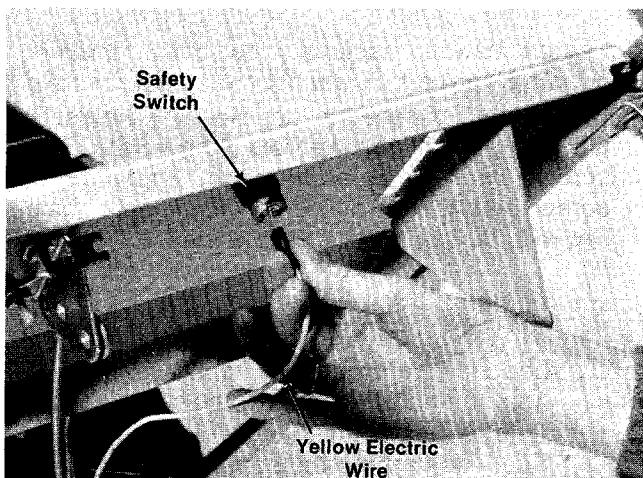

**FIGURE 8.**

8. Plug yellow electric wire into safety switch beneath handle panel. See figure 8.

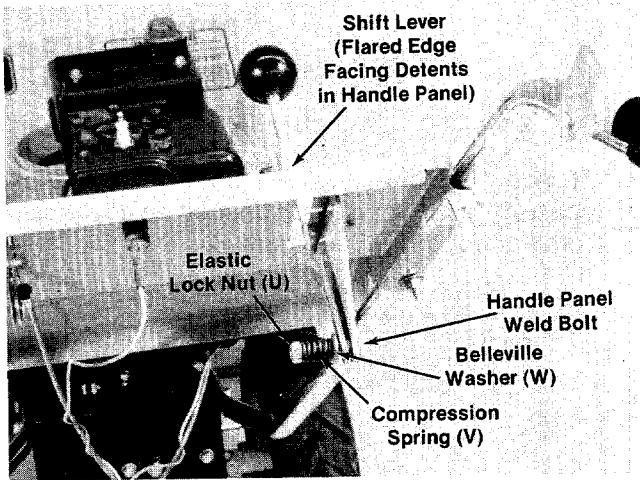

9. Place shift lever (S) through slot in handle panel, making sure flared edge of shift lever faces the detents on handle panel. See figure 9.

10. Place shift lever on handle panel weld bolt. Secure with Belleville washer (W) (cupped side goes against shift lever), compression spring (V) and elastic lock nut (U). See figure 9. Tighten lock nut until compression spring holds the shift lever into detent slots on handle panel.

FIGURE 9.

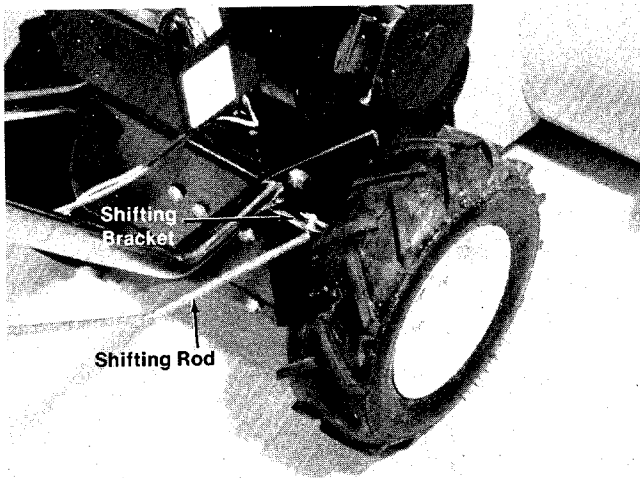

11. Place bent end of shifting rod up through shifting bracket located on right side of unit (see figure 10). Secure with flat washer (O) and cotter pin (M).

12. Move shifting bracket to middle (neutral) position. Roll the unit back and forth. It should move freely.

FIGURE 10.

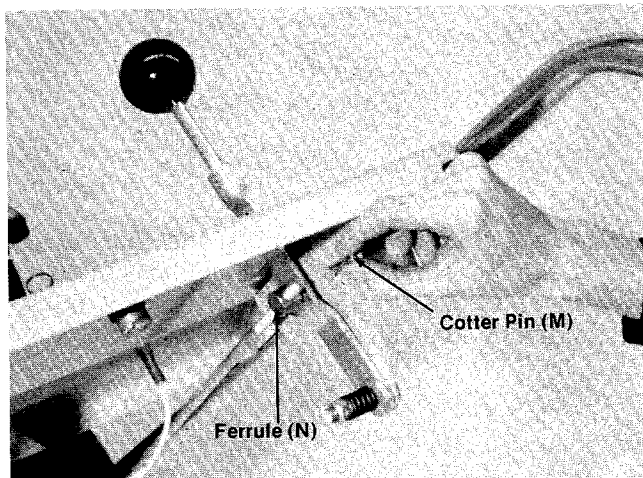

13. Place shift lever in **neutral** position. Thread ferrule (N) onto shifting rod and place into shift lever. Roll unit back and forth, checking to be sure it is in neutral gear. If it does not move freely, remove the ferrule and thread in or out as necessary. Replace the ferrule and move the unit again. Repeat procedure as needed until neutral position is reached.

14. After unit is set in neutral, secure ferrule to shift lever with cotter pin (M) as shown in figure 11.

FIGURE 11.



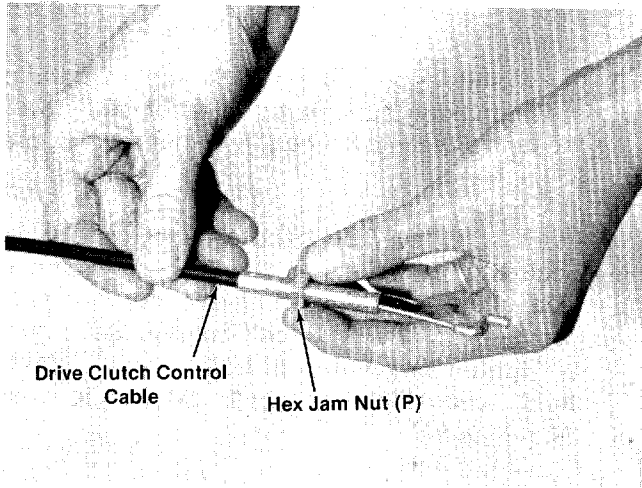

FIGURE 12.

15. Thread hex jam nut (P) onto drive clutch control cable which is attached to the snow thrower housing. See figure 12.

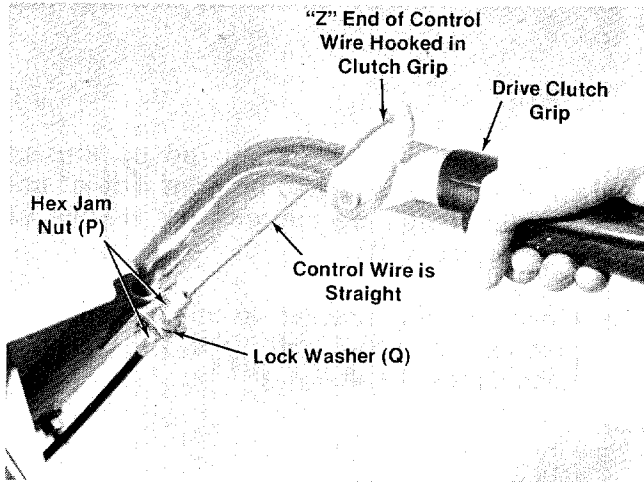

FIGURE 13.

16. Thread end of clutch control cable through cable support bracket on right handle. Place lock washer (Q) and hex jam nut (P) over clutch control cable. Start nut on cable housing by hand.

17. Hook "Z" end of control wire through hole in drive clutch grip assembly. See figure 13.

18. Hold clutch grip so that the grip is against the handle as shown in figure 13. Adjust the clutch control cable so that the slack is taken out of the control wire. Tighten the two hex nuts at the cable support bracket. Control wire should now be straight.



Do not overtighten control wire. Too much tension may cause it to break.

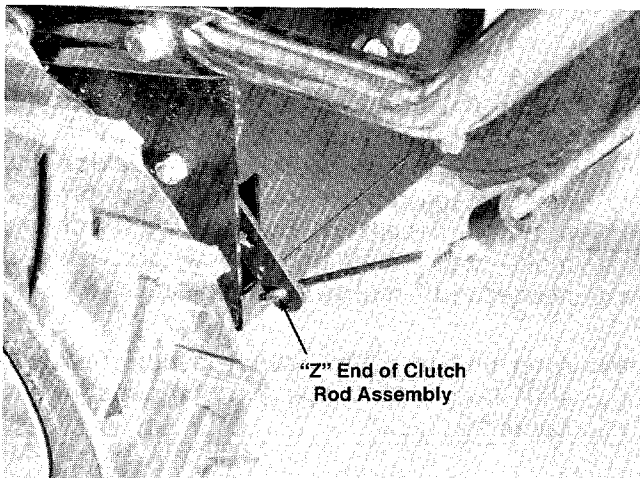

FIGURE 14.

19. Auger clutch rod assembly and lockout rod are preassembled. Place "Z" end of clutch rod assembly into hole in clutch bracket on left side of unit as shown in figure 14.



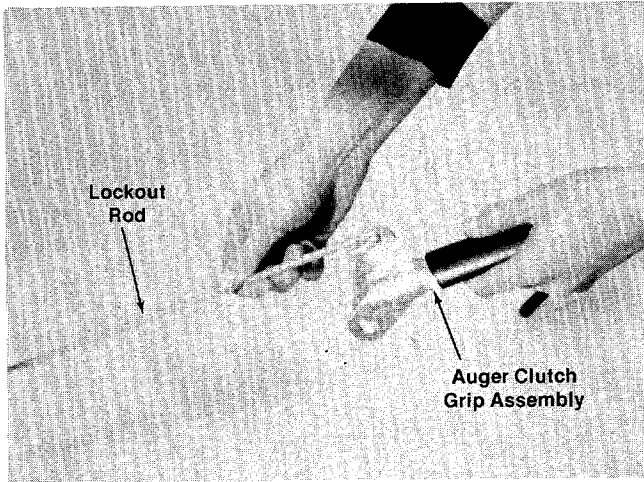

FIGURE 15.

20. Hook lockout rod into auger clutch grip assembly (E) as shown in figure 15.

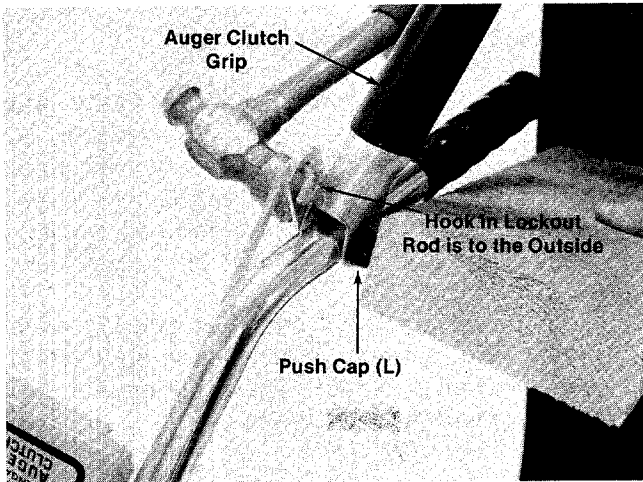

FIGURE 16.

21. Place auger clutch grip on left handle (hook in lockout rod is to the outside). Secure with clevis pin (K) and push cap (L), using a hammer and a block of wood as shown in figure 16.

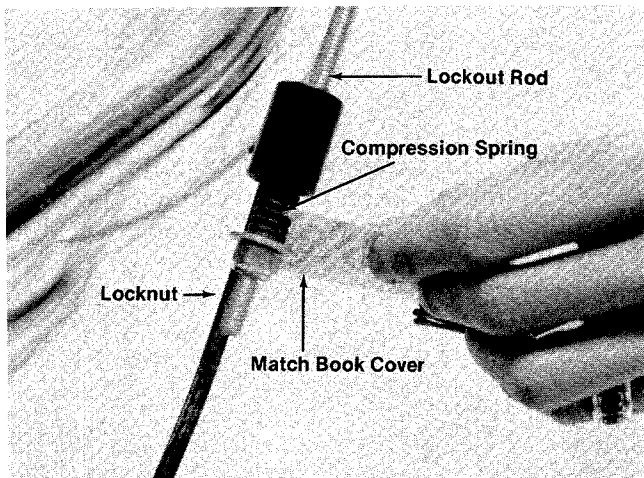

FIGURE 17.

22. Squeeze the auger clutch grip to engage lockout rod so you can check for correct adjustment. With the lockout rod engaged, you should be able to get a match book cover between the coils of the compression spring (spring should not be compressed tightly). If there is not space between spring coils, adjust the locknut using a 7/16" wrench until correct adjustment is reached. See figure 17.

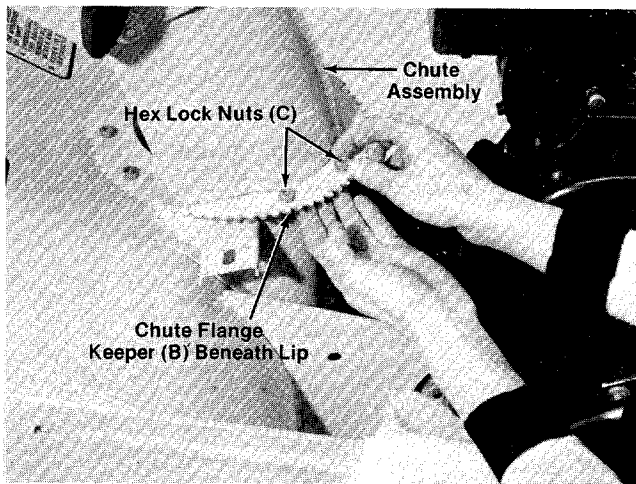

FIGURE 18.

23. Grease the chute opening.
24. Place chute assembly over chute opening. Place chute flange keepers (B) beneath lip of chute assembly. Secure with hex lock nuts (C) as shown in figure 18. Tighten with a 7/16" wrench, then back off 1/4 turn to allow easier movement.

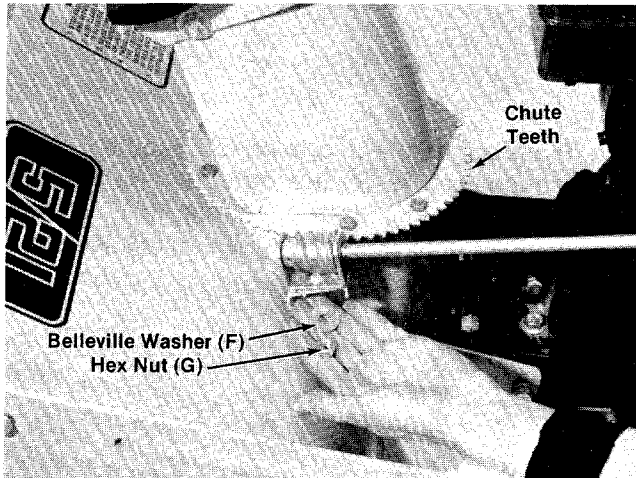

FIGURE 19.

25. Grease the teeth on the chute assembly.
26. Place the end of chute crank assembly into slot provided. Slide worm and bracket on chute crank assembly into teeth on chute assembly. Fasten in position with belleville washer (F) (cupped side up) and hex nut (G). See figure 19. Tighten finger tight.
27. Turn chute crank to see that chute moves freely. If adjustment is necessary, slide worm and bracket in or out. Then tighten hex nut securely with a  $\frac{1}{2}$ " wrench.

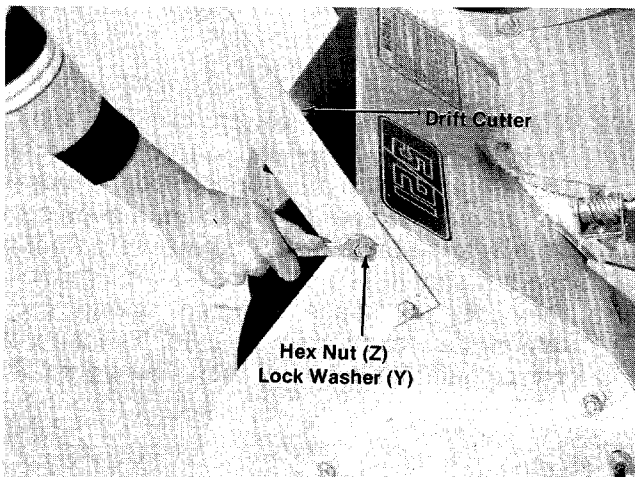
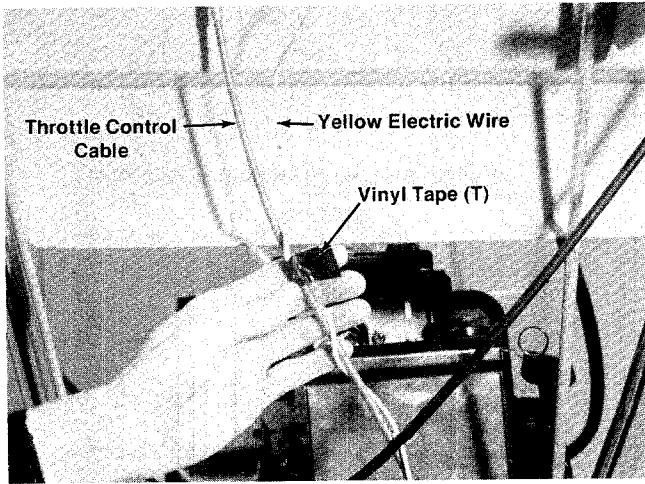

FIGURE 20.

28. Loosen hex nut holding drift cutter to unit. Pivot into position. Insert carriage bolt (X) through snow thrower housing and drift cutter with head to the **inside** of housing. Secure with lock washer (Y) and hex nut (Z). Tighten securely. See figure 20.



29. Secure yellow electric wire to throttle control cable with the vinyl tape (T) provided. See figure 21.

FIGURE 21.

## OPERATION

### CONTROLS

#### Shift Lever (See Figures 22 and 23)

The shift lever is located on the right hand side of the handle panel. The shift lever may be moved into forward, neutral or reverse position.

- A. Center Position (N) is Neutral.
- B. Forward Position (F) is Forward.
- C. Rear Position (R) is Reverse.

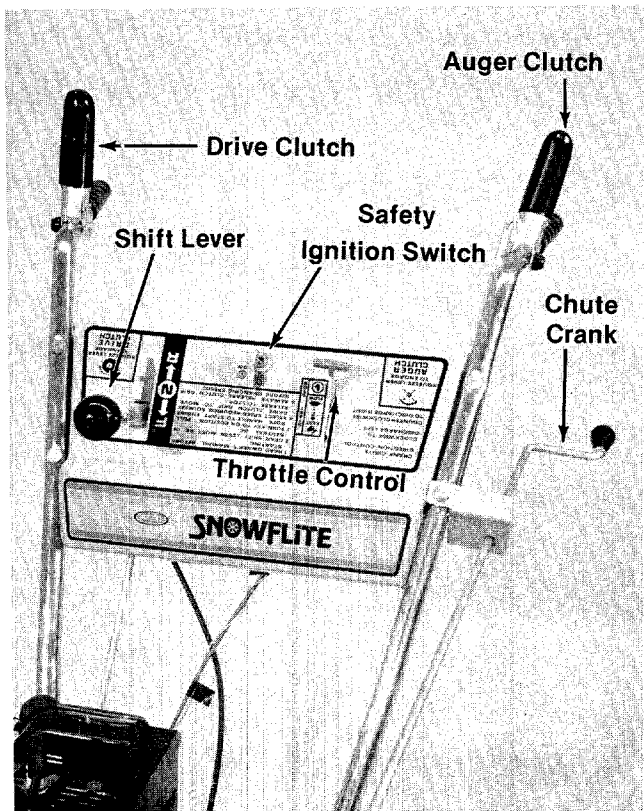

FIGURE 22.



FIGURE 23.

### Safety Ignition Switch (See figures 22 and 24)

The ignition key must be in the switch and turned to the on position before the unit will start.

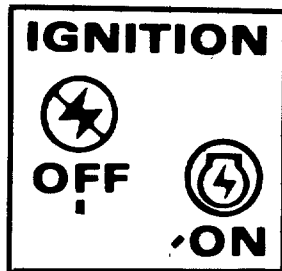

FIGURE 24.

### Throttle Control (See figures 22 and 25)

The throttle control is located on the left hand side of handle panel. It regulates the speed of the engine.

### THROTTLE

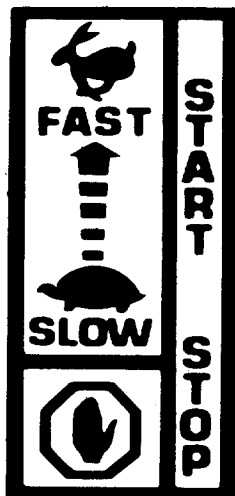

FIGURE 25.

### Drive Clutch (See figures 22 and 26)

The drive clutch is located on the **right** handle. Squeeze the clutch grip to engage drive. Release to stop.

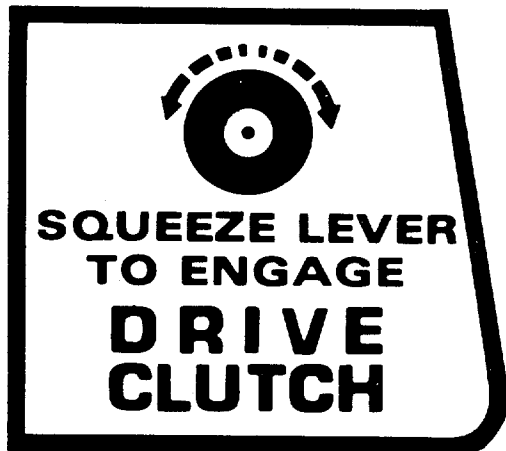

FIGURE 26.

### Auger Clutch (See figures 22 and 27)

The auger clutch is located on the **left** handle. Squeeze the clutch grip to engage the augers. Release to stop the snow throwing action.

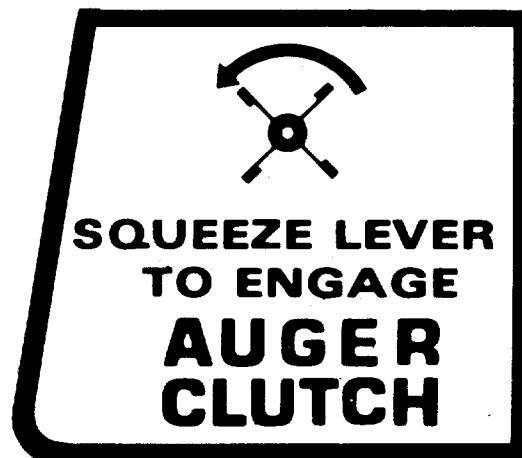

FIGURE 27.

### Chute Crank (See Figure 22)

The chute crank is located on left hand side of the snow thrower.

To change the direction in which snow is thrown, turn chute crank as follows:

1. Crank clockwise to discharge to the left.
2. Crank counterclockwise to discharge to the right.

### STARTING INSTRUCTIONS

1. Remove oil fill cap. Add oil until reaching point of overflowing. See figure 28.

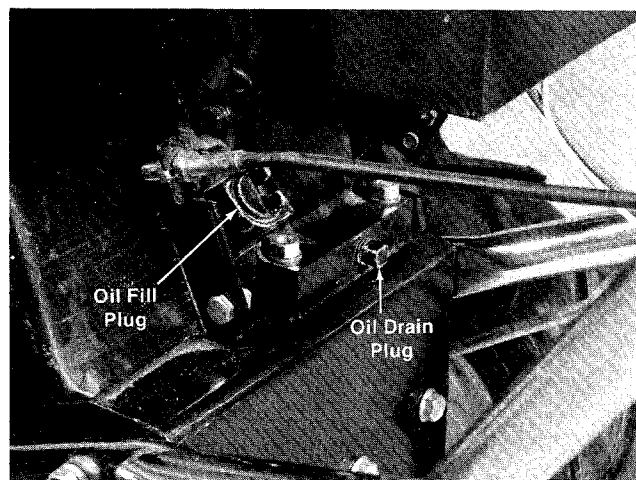

FIGURE 28.

**Above Freezing Temperatures:** Use oil with viscosity grade SAE 30 or SAE 10W-30 or SAE 10W-40.

**Below Freezing Temperatures:** Use oil with viscosity grade SAE 5W-30 or SAE 10W.

2. Fill fuel tank with fresh, clean unleaded or regular gasoline.



Never fill fuel tank indoors, with engine running or while engine is hot.

3. Attach spark plug wire to spark plug.
4. Insert ignition key and turn to "ON" position.
5. Place shift lever in "NEUTRAL" (N) position.
6. Place throttle control in "START" (fast) position.



Never run engine indoors or in enclosed poorly vented area. Engine exhaust gases contain carbon monoxide: an odorless and deadly gas.

7. Start engine, following appropriate instructions:
  - A. Cold engine start (engine has not been run recently)
    1. Pull choke wire out to "ON" position. See figure 29.

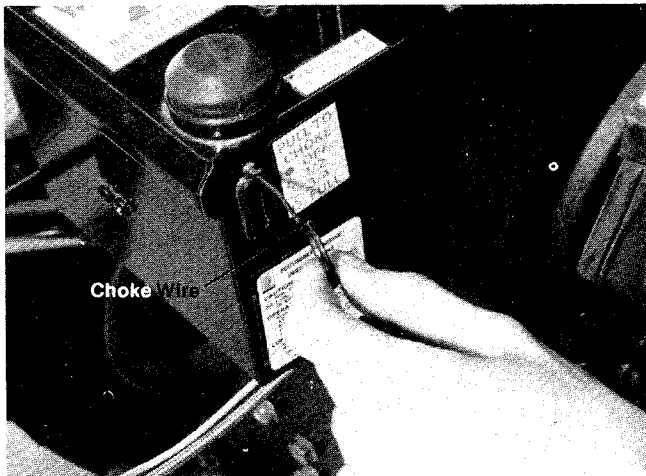

FIGURE 29.

2. Push primer two (2) or three (3) times. See figure 30.



Additional priming may be required (for initial start only) if temperature is below 15°F.

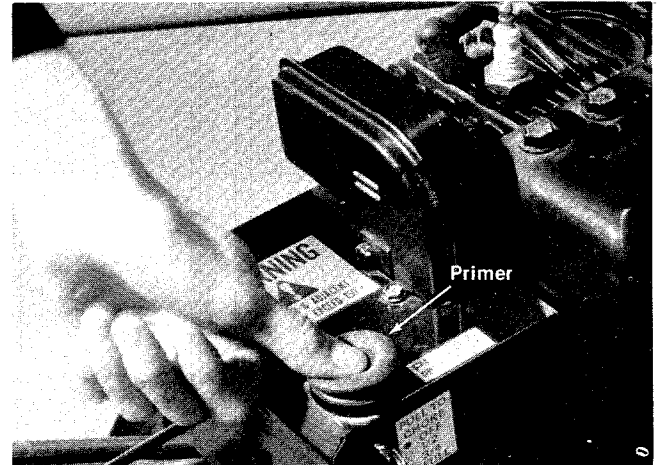

FIGURE 30.

3. Grasp the starter rope handle and pull out rapidly. Return rope handle slowly. Repeat until engine starts. If engine fails to start, repeat steps 2 and 3 as necessary until engine starts.
4. After engine starts, push choke wire in gradually (to "OFF" position).
- B. Warm engine start (engine still warm from recent running)
  1. Grasp the starter rope handle and pull out rapidly. Return rope handle slowly. Repeat until engine starts.
  2. If engine fails to start after a number of attempts, pull choke wire out. Repeat step one until engine starts. After engine starts, push choke wire in gradually.



Once the snow blower has been in operation, caution should be exercised in the area of the muffler and surrounding surfaces. See figure 31.

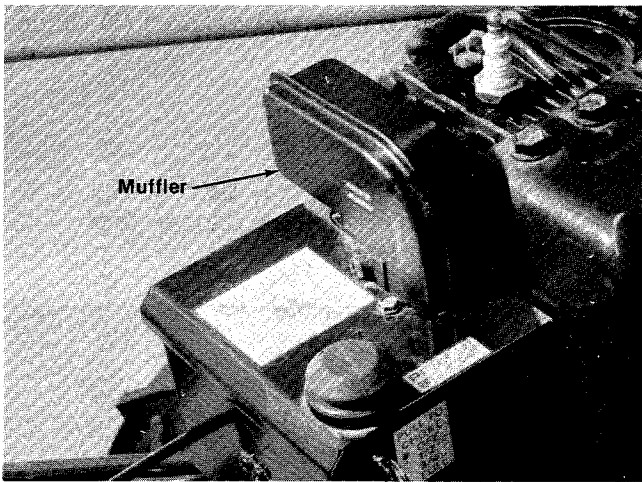

FIGURE 31.

#### TO STOP ENGINE



Run engine for a few minutes before stopping to help dry off any moisture which may have accumulated on the recoil starter.

1. Move throttle control lever to "STOP" position.
2. Turn ignition key to "OFF" position.
3. **Remove ignition key** to prevent accidental starting.



Disconnect spark plug wire from spark plug and secure it so that it cannot accidentally contact spark plug. This will reduce the possibility of unauthorized starting of engine while equipment is unattended.

#### TO ENGAGE DRIVE

1. With the engine running near top speed, move shift lever into forward (F) or reverse (R) position. (If the lever does not shift easily, move the unit back and forth to align gears as you shift the lever.)
2. Squeeze the drive clutch grip (located on the right handle) and the snow thrower will move. Release it and the drive motion will stop.



NEVER move shift lever without first releasing the drive clutch.

## ADJUSTMENTS



NEVER attempt to clean chute or make any adjustments while engine is running.

#### CHUTE ASSEMBLY ADJUSTMENT

The distance snow is thrown can be adjusted by adjusting the angle of the chute assembly. The sharper the angle, the shorter the distance snow is thrown.

To adjust chute assembly, loosen the hand knob. Pivot the top of the chute assembly to position desired. Retighten the hand knob.

#### SKID SHOE ADJUSTMENT

The space between the shave plate and the ground can be adjusted. For close snow removal, place skid shoes in the low position. Use middle or high position when area to be cleared is uneven. See figure 32.

To adjust skid shoes, loosen the four hex nuts and carriage bolts. Move skid shoes to desired position. Retighten nuts and bolts securely.

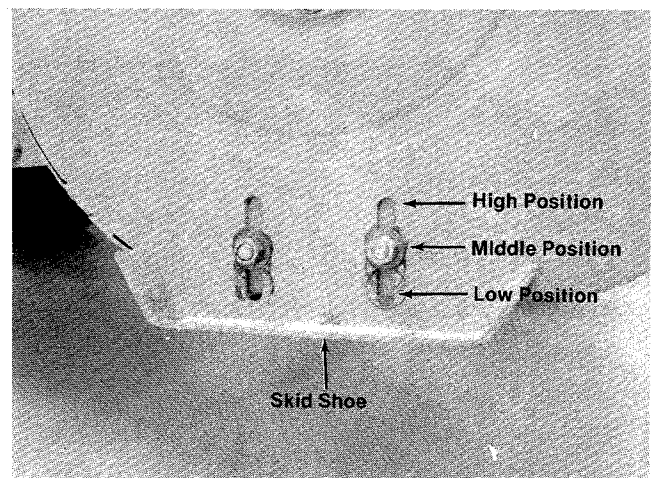
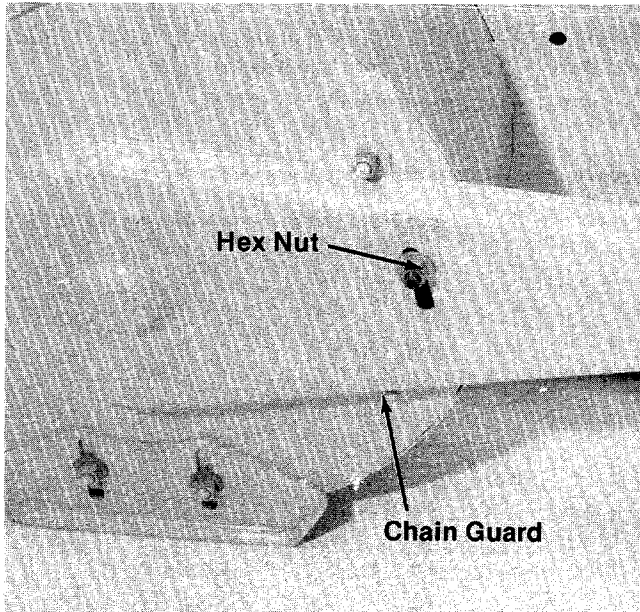

FIGURE 32.



## AUGER CHAIN ADJUSTMENT

If the drive chain to the auger is loose, it may be adjusted using a 9/16" wrench. Loosen the hex nut on the outside of the chain guard on the left hand side of the unit. Slide the bolt down as necessary. Tighten the hex nut securely. See figure 33.



**FIGURE 33.**  
**REAR AXLE CHAIN ADJUSTMENT**

To adjust the rear axle chain, first tip the snow thrower forward so it rests on the auger housing and drift cutters.

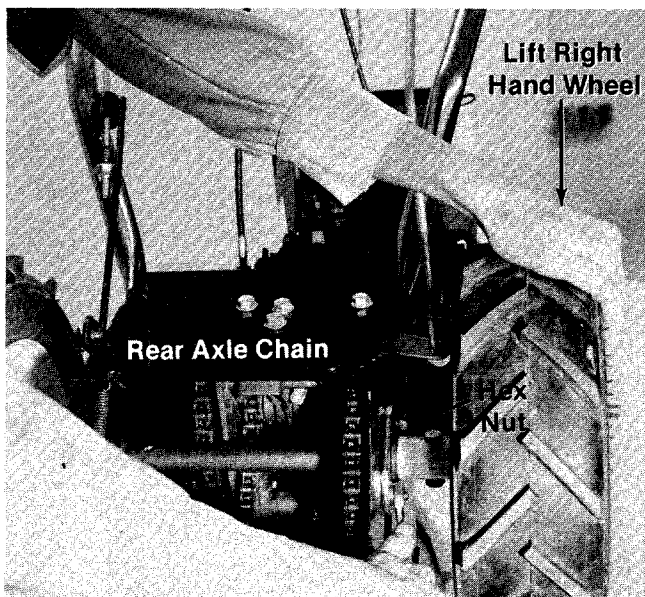

**FIGURE 34.**

Loosen the two hex nuts at the wheel axle on the right hand side of snow thrower housing. Lift up on the right wheel to take the slack out of the chain as you retighten the nuts. See figure 34.

## SHIFTING ROD ADJUSTMENT

To adjust the shifting rod, refer to step number 13 under assembly instructions.

## DRIVE CLUTCH CONTROL ADJUSTMENT

To adjust the drive clutch control, refer to step number 18 under assembly instructions.

## AUGER CLUTCH CONTROL ADJUSTMENT

To adjust the auger clutch control, refer to step number 22 under assembly instructions.



# LUBRICATION

## SPECIFICATIONS:

Lubricate once a season or after every 25 hours of operation.

Oil—Use SAE 30 or equivalent.

Grease—Use automotive multi-purpose grease.

Lubricate chain once a season with engine oil.

**Engine**—Remove oil fill plug and add oil until it reaches point of overflowing.

**Change Oil**—After first two (2) hours of operation and every twenty-five (25) hours thereafter. Drain oil from oil drain plug.

**Above Freezing Temperature:** Use oil with viscosity grade SAE 30, or SAE 10W-30, or SAE 10W-40.

**Below Freezing Temperature:** Use oil with viscosity grade SAE 5W-30 or SAE 10W.

**Capacity**—Approximately 1¼ pints.

Grease Worm On Chute  
Crank Once a Season

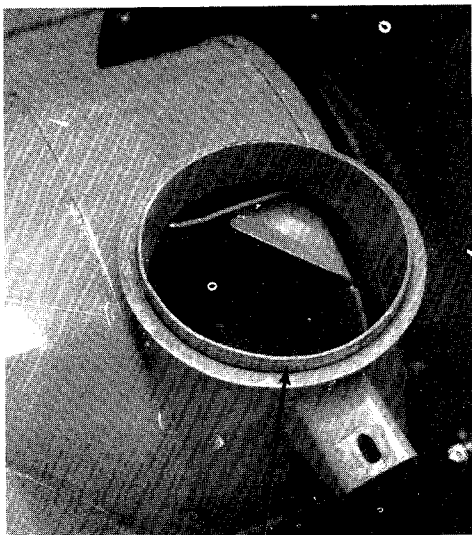
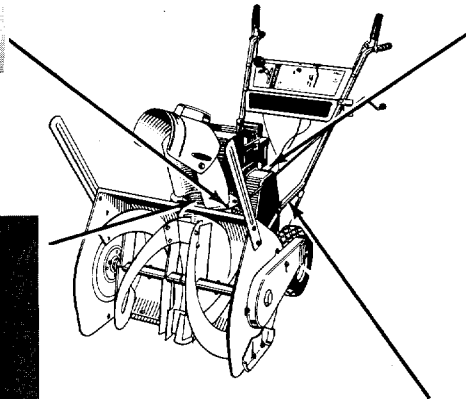
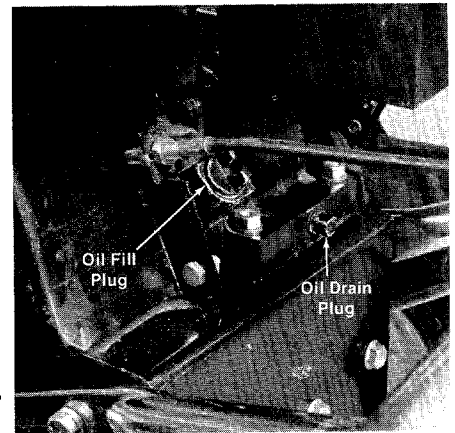
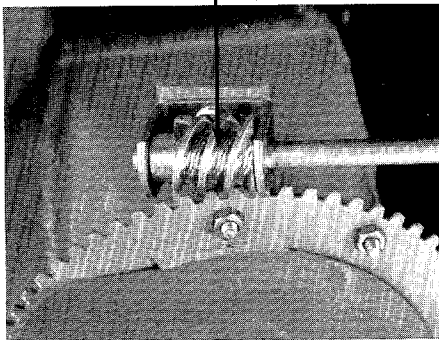

Grease Chute Opening Once  
A Season

Oil all chains, bearings, gears and the shifting mechanism at least once a season. Use engine oil. Avoid getting oil on V-belts and pulleys. →

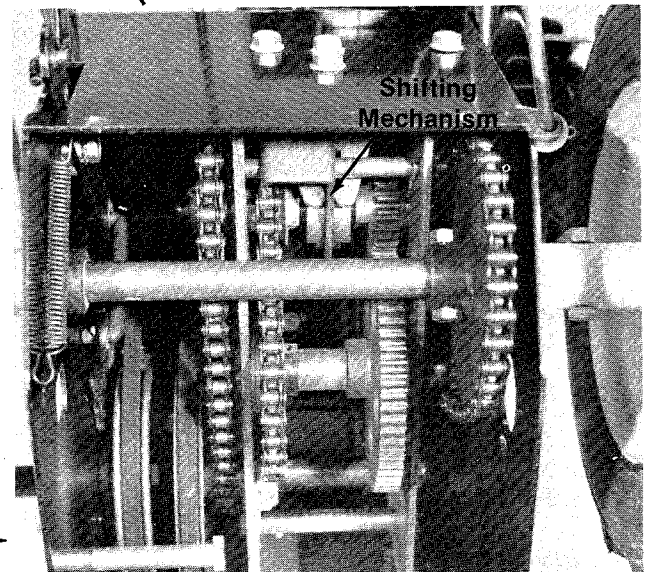

# MAINTENANCE

## SHAVE PLATE AND SKID SHOES

The shave plate and skid shoes on the bottom of the snow thrower are subject to wear. They should be checked periodically and replaced when necessary.

To remove shave plate, remove the carriage bolts, lock washers and hex nuts which attach it to the snow thrower housing. Reassemble new shave plate, making sure heads of the carriage bolts are to the inside of the housing. Tighten securely.

To remove skid shoes, remove the four carriage bolts, belleville washers and hex nuts which attach them to the snow thrower. Reassemble new skid shoes with the four carriage bolts, belleville washers (cupped side goes against skid shoes) and hex nuts.

## BELT REMOVAL AND REPLACEMENT



**WARNING**

Remove the spark plug wire from the spark plug and ground. Drain gasoline from the fuel tank, or place a piece of plastic film underneath the gas cap to prevent gasoline from leaking.

To remove and replace either the auger drive belt or the drive belt, proceed with the following instructions.

1. Remove the three self-tapping screws from the belt cover using a 7/16" wrench. See figure 35.

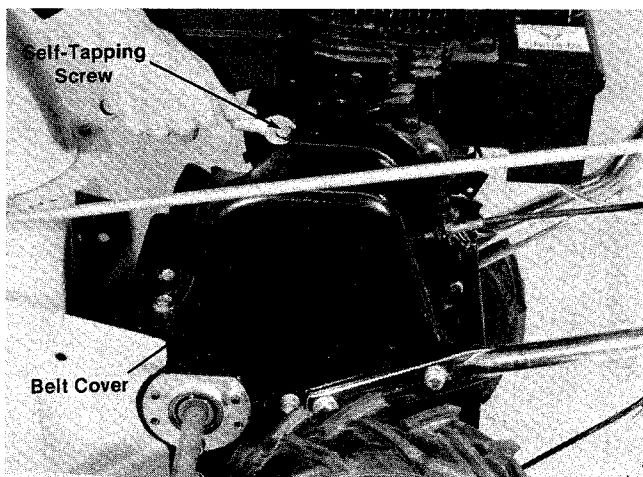

FIGURE 35.

2. Remove the belt keeper by removing the self-tapping screw shown in figure 36. A 9/16" wrench is required.

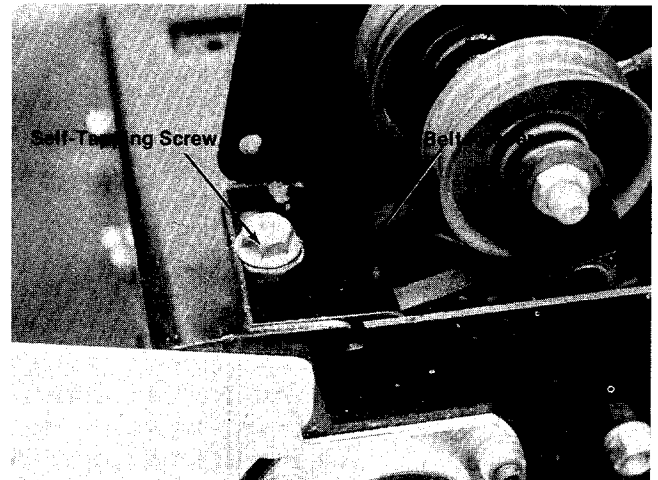

FIGURE 36.

3. Tip the snow thrower forward so that it rests on the auger housing and drift cutters.
4. Remove bottom cover. First remove the two self-tapping screws shown in figure 36 with a 1/2" wrench. Then lift cover out from the slots in the frame. See figure 37.

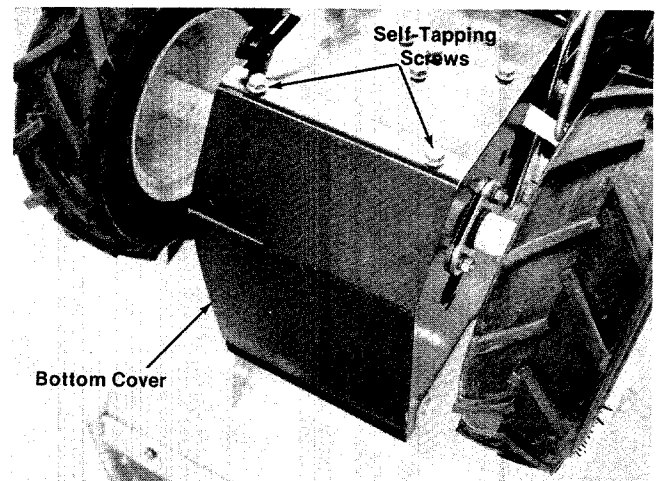
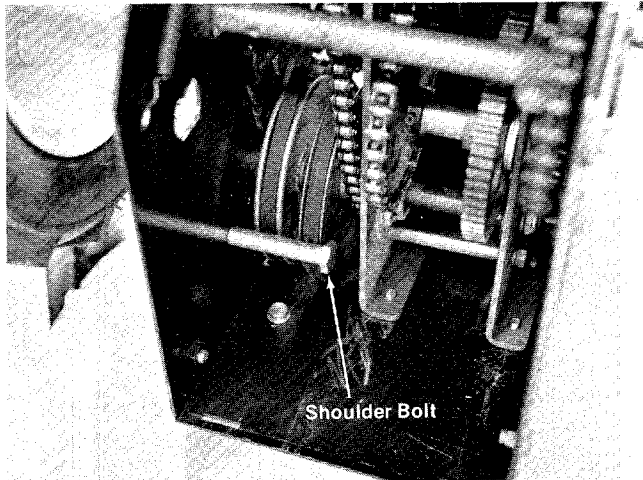

FIGURE 37.

5. Remove the large shoulder bolt which acts as a belt keeper by removing the hex nut and lock washer on the outside of the frame assembly. A 9/16" wrench is required. See figure 38.



**FIGURE 38.**

6. Remove the belt guard plate by removing the self-tapping screw shown in figure 38. Hold one hand underneath the frame to catch the plate so it does not fall. A 1/2" wrench is required. See figure 39.

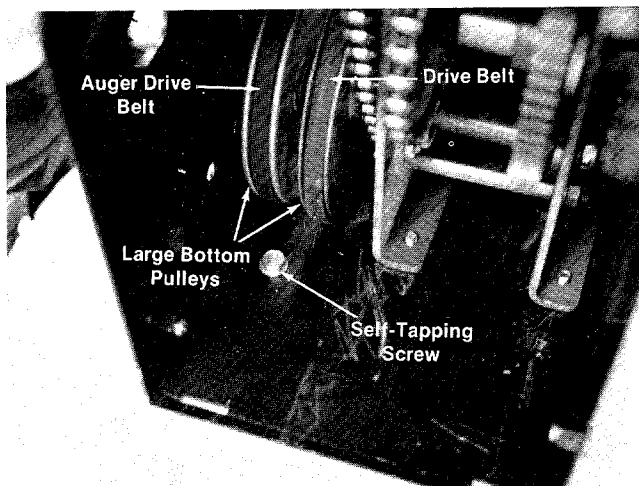

**FIGURE 39.**

7. To Remove Auger Drive Belt:
  - a. Slip auger drive belt off engine pulley. See figure 40.
  - b. Lift belt out of the sheave of the bottom pulley.
  - c. Slide belt out the bottom of the chain case.
8. To Remove Drive Belt:
  - a. First slip the auger drive belt off the engine pulley as shown in figure 40.
  - b. Slip the drive belt over the double engine pulley.

- c. Slide the belt off the bottom pulley and out the bottom of the chain case.

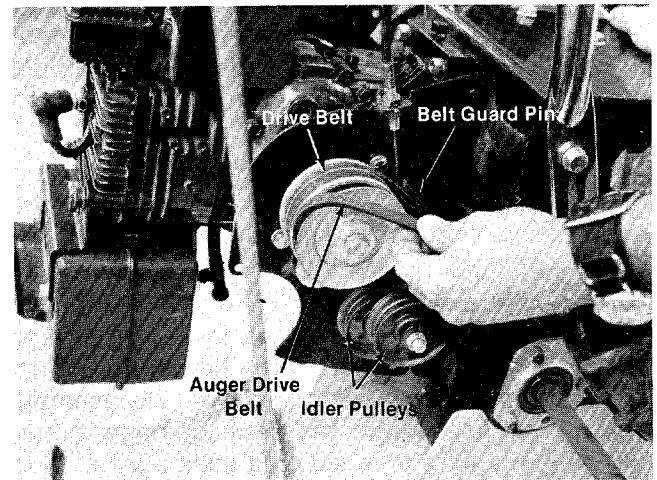

**FIGURE 40.**

9. To Reinstall Drive Belt:
  - a. Slip belt over engine pulley.
  - b. Place belt between belt guard pin and idler pulley. See figure 40.
  - c. Feed belt over large bottom pulley.
10. To Reinstall Auger Belt:
  - a. Slide belt in from bottom.
  - b. Slip belt over engine pulley.
  - c. Place between belt guard pin and idler pulley. See figure 40.
  - d. Feed belt over large bottom pulley.
11. Reinstall belt guard plate. Hold it in place beneath frame in one hand. Secure with self-tapping screw, using a 1/2" wrench. See figure 41.

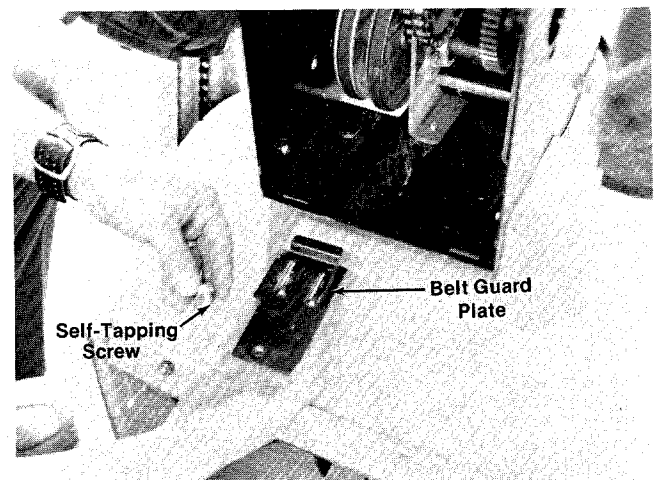

**FIGURE 41.**

12. Reinstall shoulder bolt (which acts as a belt keeper) at the base of the two large pulleys. A 9/16" wrench is required. Tighten securely.
13. Reinstall bottom cover by slipping it into the two slots in frame provided. Secure with two self-tapping screws, using a 1/2" wrench.
14. Tip unit into operating position.
15. Reinstall belt guard and belt cover.
16. Remove plastic film from gas cap.



**CAUTION**

Check engine and snow thrower frequently for loose nuts, bolts, etc., and keep these items tightened.

## OFF-SEASON STORAGE



**WARNING**

**NEVER STORE ENGINE WITH FUEL IN TANK INDOORS OR IN ENCLOSED, POORLY VENTILATED, ENCLOSURES, WHERE FUEL FUMES MAY REACH AN OPEN FLAME, SPARK OR PILOT LIGHT AS ON A FURNACE, WATER HEATER, CLOTHES DRYER, ETC.**

If unit is to be stored over 30 days, prepare for storage as follows:

1. Remove all gasoline from fuel tank to prevent gum deposits from forming on these parts and causing possible malfunction of engine.



**WARNING**

**DRAIN FUEL INTO APPROVED CONTAINER OUTDOORS, AWAY FROM OPEN FLAME.**

Run engine until engine starts to falter, then use choke to continue engine operation until all fuel in tank and carburetor is exhausted. Remove fuel line at tank or carburetor and drain any remaining gasoline from system.



**CAUTION**

**FUEL LEFT IN ENGINE DURING WARM WEATHER DETERIORATES AND WILL CAUSE SERIOUS STARTING PROBLEMS.**

2. Remove spark plug and pour one (1) ounce of engine oil through spark plug hole into cylinder. Crank engine several times to distribute oil. Replace spark plug.
3. Clean unit by removing any dirt from exterior of engine and equipment.
4. Follow lubrication recommendations on page 16.

# 310-430A

IF YOU WRITE TO US ABOUT THIS ARTICLE  
OR IF YOU ORDER REPLACEMENT PARTS AL-  
WAYS MENTION THIS MODEL & SERIAL NO  
MODEL

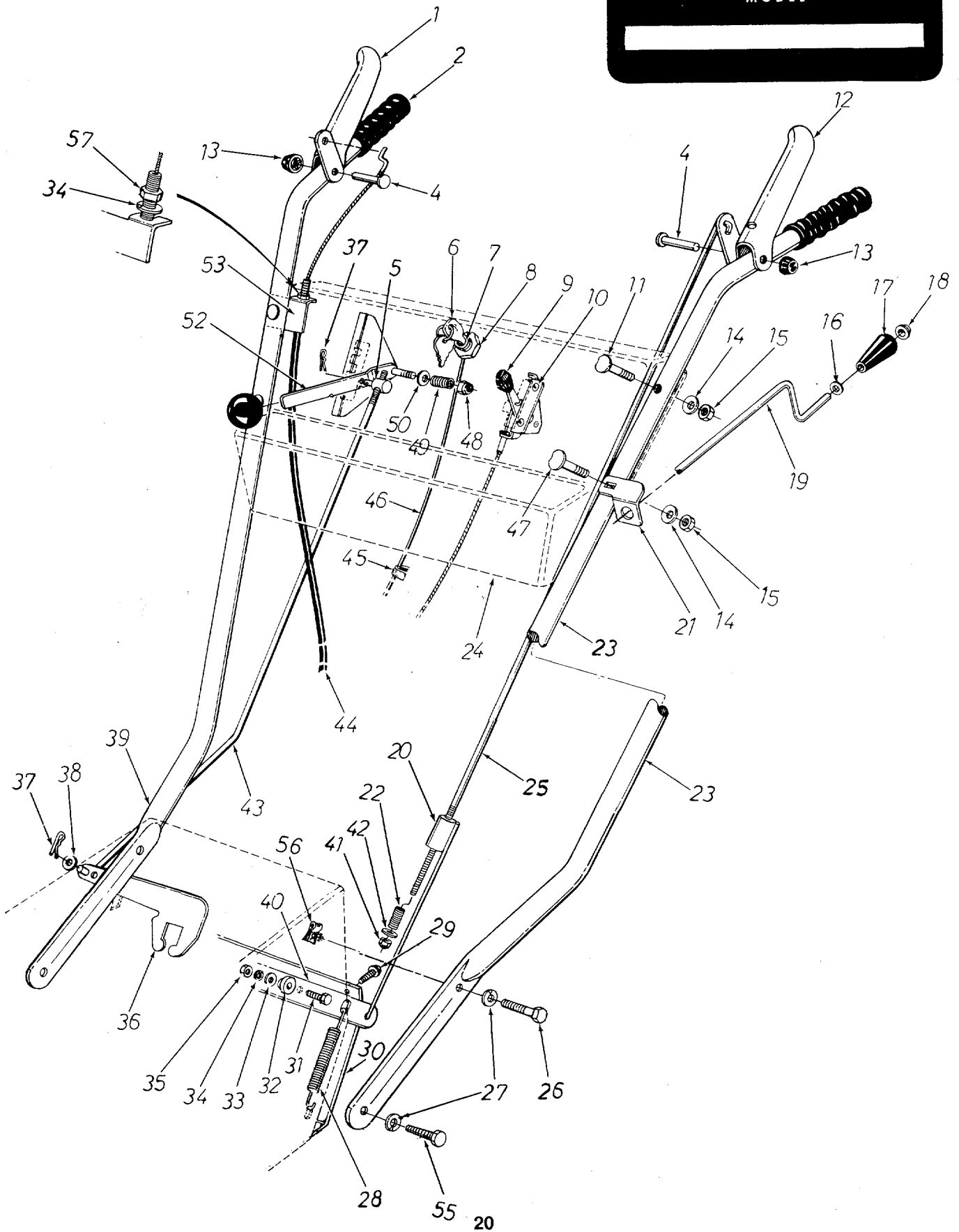

**PARTS LIST FOR MODEL 310-430A**

REF. NO.	PART NO.	COLOR CODE	DESCRIPTION	NEW PART	REF. NO.	PART NO.	COLOR CODE	DESCRIPTION	NEW PART
1	05506		Drive Clutch Grip Ass'y.		32	748-0233		Shoulder Spacer	
2	01166		Grip		33	736-0231		FI-Wash. .34 I.D. x 1.12 O.D. x .125	
4	711-0415		Clevis Pin .375 Dia. x 1.62 Lg.		34	736-0119		L-Wash. 5/16" Scr. *	
5	711-0677		Adjustment Ferrule		35	712-0158		Hex Cent. L-Nut 5/16-18 Thd.	
6	725-0201		Ignition Key		36	05811		Shifting Bracket	N
7	725-0464		Ignition Switch		37	714-0111		Cotter Pin 3/32" Dia. x 1.00 Lg.	
8	736-0225		Internal L-Wash. 5/8" Scr. *		38	736-0159		FI-Wash. .344 I.D. x .88 O.D. x .063	
9	746-0312		Throttle Control Ass'y.		39	749-0204		Handle—R.H.	
10	710-0227		Self Tap. Scr. #8 x .50" Lg.		40	05559		Thrower Clutch Bracket	
11	<del>710-0465</del>		Curved Carriage Bolt 5/16-18 x <del>1.75</del> Lg.		41	712-0324		Hex Ins. L-Nut 1/4-20 Thd.	
12	05507		Auger Clutch Grip Ass'y.		42	736-0173		FI-Wash. .28 I.D. x .75 O.D.	
13	726-0110		Push Cap .375" Rod—Black		43	747-0175		Shifting Rod	
14	736-0242		Belleville Wash.		44	746-0374		Drive Clutch Control Cable	N
15	712-0267		Hex Nut 5/16-18 Thd. *		45	725-0480		Vinyl Sealing Tape	
16	736-0140		FI-Wash. .385 I.D. x .62 O.D. x .060		46	725-0476		Electric Wire	
17	720-0171		Black Knob—3/8" Dia. Hole		47	710-0458		Carriage Bolt 5/16-18 x 1.75" Lg. *	
18	726-0100		Push Nut 3/8" Rod		48	712-0116		Hex Ins. Jam L-Nut 3/8-24 Thd. *	
19	747-0153-113		Chute Crank		49	732-0193		Compression Spring .60 O.D. x .75" Lg.	
20	05567		Auger Clutch Rod Ass'y.		50	736-0105		Belleville Wash. .40 I.D. x .88 O.D.	
21	05516		Chute Control Bracket						
22	732-0337		Compression Spring .39 O.D. x .75" Lg.						
23	749-0203		Handle—L.H.	N					
24	05816		Handle Panel Ass'y.						
25	747-0154		Lockout Rod .214 Dia. x 32.0" Lg.						
26	<del>710-0342</del>		Pilot Scr. 3/8-16 x <del>1.25</del> Lg.		52	05694		Shift Handle Ass'y.	
27	736-0169		L-Wash. 3/8" Scr. *		53	05554		Cable Support Bracket	
28	732-0320		Extension Spring .38 O.D. x 3.25 Lg.						
29	710-0600		Hex Wash. Hd. Self Tap Scr. 5/16-24 x .50" Lg.		55	710-0623		Hex Self Tap Scr. 3/8-16 x .75" Lg.	
30	05790		Frame Cover	N	56	726-0195		"U"-Nut 3/8-16 Thd.	N
31	710-0322		Hex Sems Scr. 5/16-18 x 1.00" Lg. *		57	<del>712-0256</del>		Hex Jam Nut 5/16-24 Thd.	

\*For faster service obtain standard nuts, bolts and washers locally. If these items cannot be obtained locally, order by part number and size as shown on parts list.

(488—Mack Truck Yellow) When ordering parts if color or finish is important, use color code shown at left. (e.g. Mack Truck Yellow Finish—05546 (488).)

The engine is not under warranty by the Snow Thrower manufacturer. If repairs or service is needed on the engine, please contact your nearest authorized engine service outlet. Check the "Yellow Pages" of your telephone book under "Engines—Gasoline."



This instruction manual covers various models and all specifications shown do not necessarily apply to your model. Specifications subject to change without notice or obligation.

# 310-430A

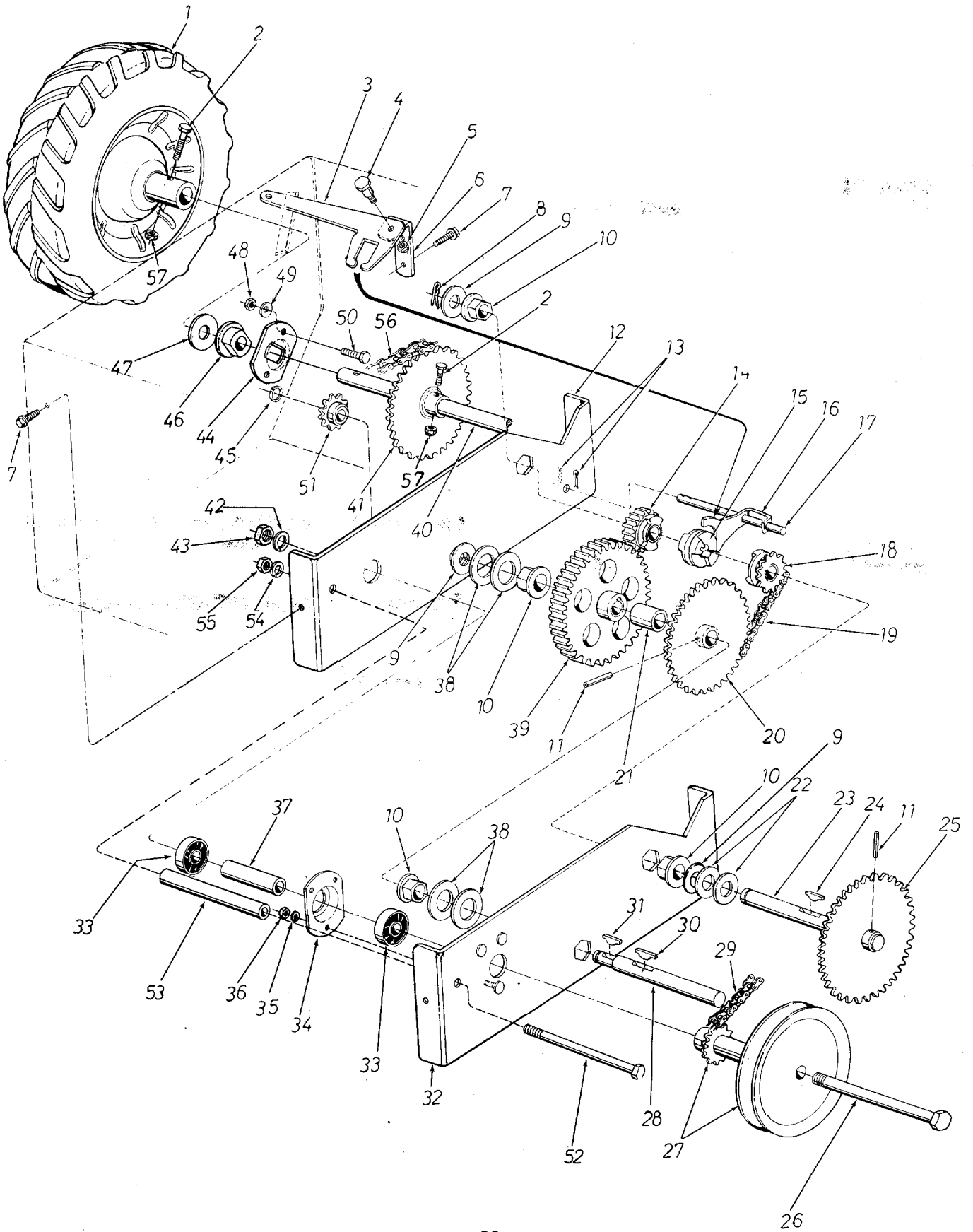



**PARTS LIST FOR MODEL 310-430A**

REF. NO.	PART NO.	COLOR CODE	DESCRIPTION	NEW PART	REF. NO.	PART NO.	COLOR CODE	DESCRIPTION	NEW PART
1	734-0988		Wheel Ass'y. — Comp. 12.50 x 3.50—R.H.		29	713-0265		#41 Chain ½ Pitch x 47 Links	N
	734-0987		Wheel Ass'y. — Comp. 12.50 x 3.50—L.H. (Not Shown)			713-0723		Master Link	
2	710-0409		Hex Scr. 5/16-24 x 1.75" Lg. H.T.		30	714-0126		Hi-Pro Key—3/16 x 3/4" Dia.	
3	05811		Shifting Bracket		31	714-0129		Hi-Pro Key—3/32 x 5/8" Dia.	
4	738-0140		Shld. Scr. .438" Dia. x .180 Lg.		32	05789		Drive Housing Bracket Ass'y.—L.H.	N
5	712-0158		Hex Cent. L-Nut 5/16-18		33	741-0133		Ball Bearing .500 I.D. x 1.38 O.D. x .438	
6	<del>5808</del>		Shifting Bracket Support		34	05034		Bearing Housing	
7	710-0600		Hex Wash. Hd. Self-Tap Scr. 5/16-24 x .50		35	736-0329		L-Wash. ¼ Scr.*	
8	714-0111		Cotter Pin 3/32" Dia. x 1.00" Lg.		36	712-0287		Hex Nut ¼-20 Thd.*	
9	736-0187		FI-Wash. .64 I.D. x 1.25 O.D. x .060		37	750-0295		Spacer—.52 I.D. x .62 O.D. x 2.69	
10	748-0229		Hex Flange Brg. .63 I.D.		38	736-0250		FI-Wash. 1.06 I.D. x 1.75 O.D. x .100	
11	715-0114		H-Spring Pin Sprl. ¼" Dia. x 1.50 Lg.		39	748-0162		Spur Gear—62 Teeth	
12	05792		Drive Housing Bracket—R.H.	N	40	738-0460		Wheel Axle	N
13	714-0104		Internal Cotter Pin 3/8" Dia.*		41	713-0261		32 Teeth—Sprocket Hub Ass'y.	N
14	748-0163		Spur Gear—21 Teeth		42	736-0921		L-Wash. for ½" Scr.*	
15	748-0161		Clutch Collar		43	712-0200		Hex Ins. Jam L-Nut ½-20 Thd.	
16	05054		Shifting Yoke		44	10470		Bearing Plate	
17	738-0315		Rod		45	716-0104		E-Ring for .500" Dia. Shaft	
18	748-0164		Sprocket—10 Teeth		46	<del>741-0199</del>		Flange Bearing w/Flats .753 I.D. (Plastic)	
19	713-0263		#41 Chain—½" Pitch x 33 Links		47	736-0287		FI-Wash. .81 I.D. x 1.25 O.D. x .060	
	713-0723		Master Link		48	712-0267		Hex Nut 5/16-18 Thd.*	
20	05093		28 Teeth—Sprocket Hub Ass'y.		49	736-0119		L-Wash. 5/16" Scr.*	
21	750-0229		Spacer—.62 I.D. x .88 O.D. x 1.030		50	710-0451		Carriage Bolt 5/16-18 x .75" Lg.	
22	736-0237		FI-Wash. .64 I.D. x 1.25 O.D. x .100		51	<del>713-0278</del>		8 Teeth Sprocket #41 Chain	
23	738-0459		Shifting Shaft		52	710-0190		Hex Scr. 5/16-18 x 4.00" Lg.	
24	714-0137		Hi-Pro Key 3/16 x 3/4" Dia. x 1.062	N	53	750-0324		Spacer .50 O.D. x .34 I.D. x 3.25" Lg.	
25	05137		32 Teeth Sprocket Hub Ass'y.		54	736-0119		L-Wash. 5/16" Scr.*	
26	710-0506		Hex Scr. ½-20 x 5.50" Lg.		55	712-0267		Hex Nut 5/16-18 Thd.*	
27	756-0325		5.25" O.D. Pulley with 9 Teeth Sprocket		56	713-0264		#41 Chain ½ Pitch x 37 Links	N
28	738-0314		Shaft			713-0723		Master Link	
					57	712-0273		Hex Jam L-Nut 5/16-24 Thd.	

\*For faster service obtain standard nuts, bolts and washers locally. If these items cannot be obtained locally, order by part number and size as shown on parts list.

(488—Mack Truck Yellow) When ordering parts if color or finish is important, use color code shown at left. (e.g. Mack Truck Yellow Finish—05546 (488).)

The engine is not under warranty by the Snow Thrower manufacturer. If repairs or service is needed on the engine, please contact your nearest authorized engine service outlet. Check the "Yellow Pages" of your telephone book under "Engines—Gasoline."

**Find It Fast  
In the  
Yellow Pages**

# 310-430A

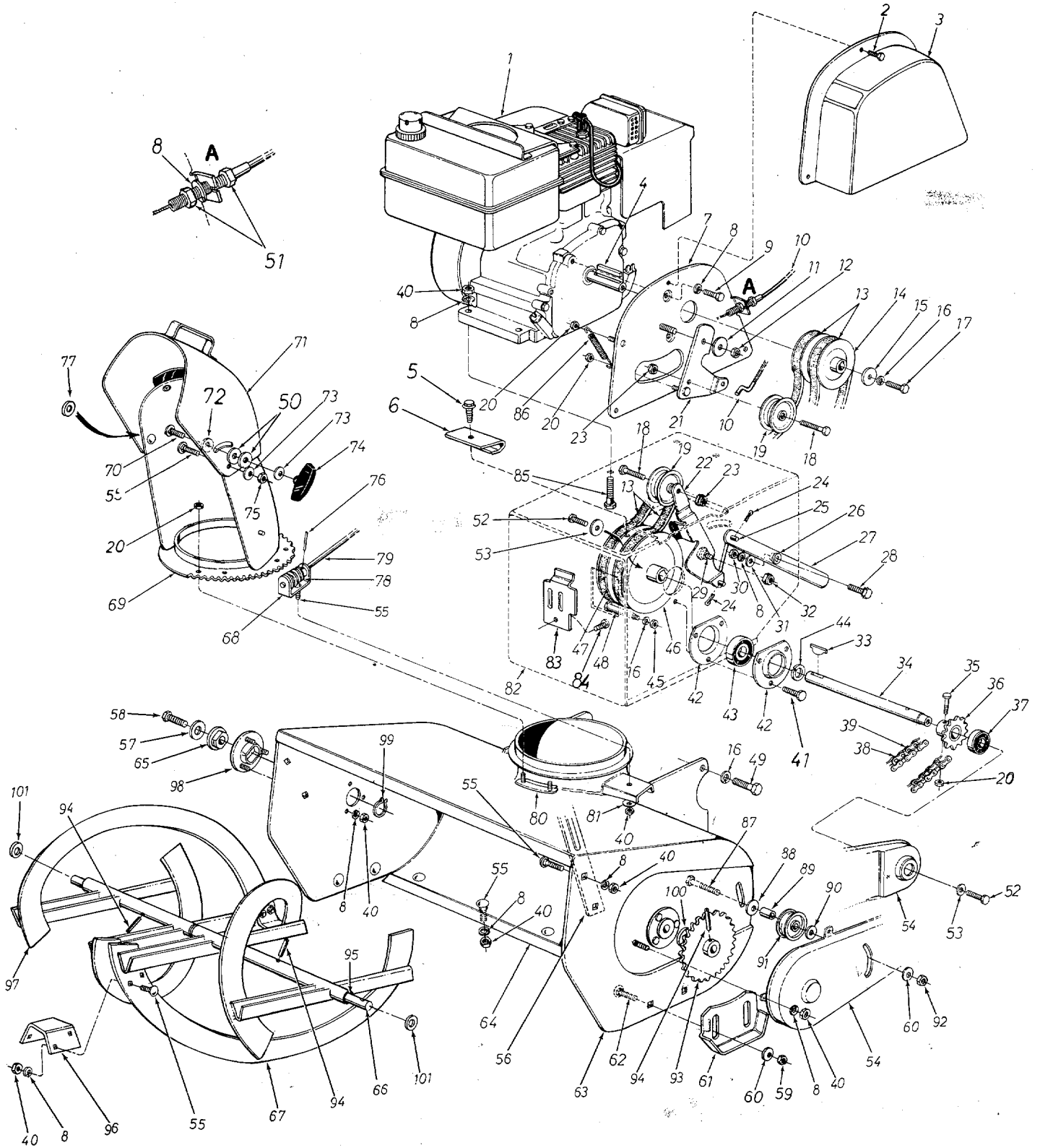

PARTS LIST FOR MODEL 310-430A

REF. NO.	PART NO.	COLOR CODE	DESCRIPTION	NEW PART	REF. NO.	PART NO.	COLOR CODE	DESCRIPTION	NEW PART
1	—		Engine		49	710-0623		Hex Self-Tap Scr. 3/8-16 x .75" Lg.	
2	710-0599		Hex Self-Tap Scr. 1/4-20 x .50" Lg.		50	736-0231		FI-Wash. .341" I.D. x 1.12" O.D.	
3	05621		Belt Cover	N	51	712-0254		Hex Jam Nut 5/16-24 Thd.*	
4	714-0105		Sq. Key 3/16 x 1.00" Lg.		52	710-0538		Hex Lock Screw 5/16-18 x .62" Lg.	
5	710-0600		Hex Wash. Hd. Self-Tap Scr. 5/16-24 x .50" Lg.		53	736-0242		Bell. Wash. .34 I.D. x .88 O.D. x .060	
6	05810		Belt Guard	N	54	05561		Chain Guard	
7	05821		Engine Plate Ass'y.	N	55	710-0260		Carr. Bolt 5/16-18 x .62" Lg.*	
8	736-0119		L-Wash. 5/16" Scr.*		56	05139		Drift Cutters	
9	710-0237		Hex Scr. 5/16-24 x .62" Lg.*		57	07386		FI-Wash.	
10	746-0374		Drive Clutch Control Cable	N	58	710-0371		Hex Scr. 5/16-18 x .88" Lg.	
11	736-0234		FI-Wash. .39 I.D. x 1.50 O.D. x .060		59	712-0798		Hex Nut 3/8-16 Thd.*	
12	712-0116		Hex Ins. Jam L-Nut 3/8-24 Thd.		60	736-0105		Bell. Wash. .40 I.D. x .88 O.D.	
13	754-0205		3 V-Belt 31.5" Lg.		61	05571		Slide Shoe	
14	756-0257		Engine Pulley		62	710-0389		Carr. Bolt 3/8-16 x .75" Lg.*	
15	736-0235		FI-Wash. .40 I.D. x 1.25 O.D. x .157		63	05540 —488		Spiral Housing Ass'y. 21"	
16	736-0169		L-Wash. 3/8" Scr.*		64	05001		Shave Plate	
17	710-0152		Hex Scr. 3/8-24 x 1.00" Lg.*		65	741-0170		Flange Brg. w/Flats 1.0" I.D.	
18	710-0723		Hex Scr. 3/8-24 x 1.25" Lg.*		66	738-0227		Spiral Shaft	
19	756-0137		Flat Idler 2.25 O.D.		67	05018		Spiral Ass'y.—L.H.	
20	712-0107		<del>Hex Cent. Lock Nut 1/2-20 Thd.</del> N		68	05515		Chute Brkt.	
21	05823		Drive Idler Brkt. Ass'y.		69	05482 —488		Chute Ass'y.	
22	05556		Thrower Idler Brkt. Ass'y.		70	710-0276		Carr. Bolt 5/16-18 x 1.00" Lg.*	
23	712-0266		Hex Cent. L-Nut 3/8-16 Thd.		71	05225 —488		Top Chute Ass'y.	
24	714-0111		Cotter Pin 3/32" Dia. x 1.00" Lg.*		72	736-0179		FI-Wash. .53 I.D. x 1.25 O.D. x .100	
25	747-0174		Clutch Rod 5/16" Dia. x 2.88 Lg.		73	736-0242		Bell. Wash. .34 I.D. x .88 O.D.	
26	748-0233		Shoulder Spacer		74	09966		Handle Knob Ass'y.	
27	05559		Thrower Clutch Bracket		75	712-0158		Hex Cent. L-Nut 5/16-18 Thd.	
28	710-0322		Hex Sems Scr. 5/16-18 x 1.00" Lg.*		76	715-0103		Spring Pin Roll 1/8" Dia. x .75" Lg.	
29	738-0281		Shld. Scr. .625" Dia. x .170"		77	736-0179		FI-Wash. .531 I.D. x 1.25 O.D.	
30	712-0158		Hex Cent. L-Nut 5/16-18 Thd.		78	717-0301		Worm—R.H. with Three Thread	
31	736-0231		FI-Wash. .34 I.D. x 1.12 O.D. x .125		79	747-0153		Chute Crank	
32	712-0266		Hex Cent. L-Nut 3/8-16 Thd.		80	05783		Chute Flange Keeper Ass'y.	N
33	714-0138		Woodruff Key 5/32 x 5/8 Dia.		81	736-0242		Bell. Wash. .34 I.D. x .88 O.D.	
34	<del>710-0606</del>		<del>Thrower Shaft 2" w/imp ring</del>		82	05785		Frame Ass'y.	N
35	710-0606		Hex Scr. 1/4-20 x 1.50" Lg.*		83	05673		Belt Guard Plate	
36	05156		14 Teeth Sprocket Hub Ass'y.		84	710-0726		Hex Wash. Self-Tap Scr. 5/16-18 x .75" Lg.	N
37	741-0155		Ball Brg. .625 I.D. x 1.38 O.D. x .438		85	710-0442		Hex Scr. 5/16-18 x 1.50" Lg.*	
38	713-0266		#41 Chain—1/2" Pitch x 83 Links		86	732-0264		Extension Spring .38 O.D. x 2.50" Lg.	
39	713-0723		#41 Master Link 1/2" Pitch Type II		87	710-0560		Carriage Bolt 3/8-16 x 1.75" Lg.	
40	712-0267		Hex Nut 5/16-18 Thd.*		88	736-0235		FI-Wash. .40 I.D. x 1.25 O.D.	
41	710-0600		Hex Wash. Hd. Self-Tap Scr. 5/16-18 x .50" Lg.		89	750-0252		Idler Spacer	
42	05244		Bearing Housing		90	736-0219		Bell. Wash. .40 I.D. x 1.12 O.D.	
43	741-0174		Self Aligning Brg. .750 I.D.		91	756-0192		Plastic Idler	
44	<del>712-0798</del>		<del>Hex Nut 3/8-16 Thd.*</del> See Ref. No. 39		92	712-0130		Hex Ins. L-Nut 3/8-16 Thd.	
45	712-0798		Hex Nut 3/8-16 Thd.*		93	713-0177		40 Tooth Sprocket Hub Ass'y.	
46	756-0258		1/2" V-Pulley .753 I.D.						
47	756-0325		5.25" O.D. Pulley with 9 Teeth Sprocket						
48	738-0117		Shld. Scr. .498" Dia. x 2.475" Lg.						

**PARTS LIST FOR MODEL 310-430A (Continued)**

REF. NO.	PART NO.	COLOR CODE	DESCRIPTION	NEW PART
94	715-0118		Spring Pin Spiral 5/16 x 1.75" Lg.	
95	05136		Plastic Bushing	
96	05023		Spiral Plate	
97	05017		Spiral Ass'y. — R.H.	
98	05360		Bearing Hsg. Ass'y.	
99	716-0121		Snap Ring for 1.50" Dia. Shaft	
100	736-0163		FI-Wash. 1.0" I.D. x <span style="background-color: black; color: black;">          </span> 1.62 O.D. X .030	
101	736-0250		FI-Wash. 1.06 I.D. x 1.75 O.D.	

**102 736-0254 FI-Wash. 34 I.D. X .62 O.D. X .06**

**103 736-0235 FI-Wash. 34 I.D. X 1.12 (L.H. Top side only)**

# PARTS INFORMATION

## POWER EQUIPMENT PARTS AND SERVICE

Parts and service for all MTD manufactured power equipment are available through the authorized service firms listed below. All orders should specify the model number of your unit, parts number, description of parts and the quantity of each part required.

<b>ALABAMA</b>	<b>BIRMINGHAM</b>	
Auto Electric & Carburetor Co. ....	2625 4th Ave. S. ....	35233
<b>ARKANSAS</b>	<b>FORT SMITH</b>	
Mity Mite Motors, Inc. ....	4515 South 16th Street	72901
	<b>NORTH LITTLE ROCK</b>	
Sutton's Lawn Mower Shop ....	Rt. 4 Box 368. ....	72117
<b>CALIFORNIA</b>	<b>PORTERVILLE</b>	
Billious ....	75 North D Street ....	93257
	<b>SAN BERNARDINO</b>	
Lawn Mower Supply Co. ....	25608 E. Baseline ....	92410
	<b>SAN FRANCISCO</b>	
J.W. Jewett Co. ....	981 Folsom St. ....	94107
<b>COLORADO</b>	<b>DENVER</b>	
South Denver Lawn Equip. ....	527 West Evans ....	80223
<b>FLORIDA</b>	<b>JACKSONVILLE</b>	
Radco Distributors ....	2403 Market St. ....	32206
	<b>OPA LOCKA</b>	
Small Eng. Dist. ....	2351 N.W. 147th St. ....	33054
<b>GEORGIA</b>	<b>EAST POINT</b>	
East Point Cycle & Key. ....	2834 Church St. ....	30344
<b>ILLINOIS</b>	<b>LYONS</b>	
Keen Edge Co. ....	8615 Ogden Ave. ....	60534
<b>INDIANA</b>	<b>ELKHART</b>	
Parts & Sales Inc. ....	2101 Industrial Pkwy. ....	46514
<b>IOWA</b>	<b>DUBUQUE</b>	
Power Lawn & Garden Equip. ....	2551 J.F. Kennedy. ....	52001
<b>LOUISIANA</b>	<b>NEW ORLEANS</b>	
Suhren Engine Co. ....	8330 Earhart Blvd. ....	70118
<b>MARYLAND</b>	<b>TAKOMA PARK</b>	
Center Supply Co. ....	6867 New Hampshire Ave. ....	20012
<b>MASSACHUSETTS</b>	<b>SPRINGFIELD</b>	
Morton B. Collins Co. ....	300 Birnie Ave. ....	01107
<b>MICHIGAN</b>	<b>LANSING</b>	
Lorenz Service Co. ....	2500 S. Pennsylvania. ....	48910
	<b>MOUNT CLEMENS</b>	
Power Equipment Dist. ....	36463 South Gratiot ....	48043
<b>MINNESOTA</b>	<b>HOPKINS</b>	
Hance Distributing Inc. ....	420 Excelsior Ave. W. ....	55343
	<b>ST. PAUL</b>	
Power Tools Inc. ....	3771 Sibley Memorial Hwy. ....	55122
<b>MISSISSIPPI</b>	<b>BILOXI</b>	
Biloxi Sales & Service, Inc. ....	506 Caillavet St. ....	39533
<b>MISSOURI</b>	<b>KANSAS CITY</b>	
Automotive Equip. Service ....	3117 Holmes St. ....	64109
	<b>ST. JOSEPH</b>	
Ross-Frazier Supply Co. ....	8th and Monterey ....	64503
	<b>ST. LOUIS</b>	
Henzler, Inc. ....	2015 Lemay Ferry Rd. ....	63125
<b>NEW JERSEY</b>	<b>BELLMAWR</b>	
Lawnmower Parts Inc. ....	717 Creek Rd. ....	08030
	<b>RUTHERFORD</b>	
Feld Distributor ....	28 Glen Rd. ....	07070
<b>NEW YORK</b>	<b>CARTHAGE</b>	
Gamble Dist., Inc. ....	West End Ave. ....	13619

## BRIGGS AND STRATTON, TECUMSEH AND PEERLESS PARTS AND SERVICE

Briggs & Stratton, Tecumseh and peerless parts and service should be handled by your nearest authorized engine service firm. Check the yellow pages of your telephone directory under the listing **Engines—Gasoline**, Briggs & Stratton or Tecumseh Lauson.

	<b>SYRACUSE</b>	
GTP Leisure Products Inc. ....	420 Marcellus St. ....	13204
<b>NORTH CAROLINA</b>	<b>GOLDSBORO</b>	
Smith Hardware Co. ....	515 N. George St. ....	27530
	<b>GREENSBORO</b>	
Dixie Sales Company ....	327 Battleground Ave. ....	27402
<b>OHIO</b>	<b>CARROLL</b>	
Stebe's Mid-State Mower Supply ...	Box 366-71 High St. ...	43112
	<b>CLEVELAND</b>	
Bleckrie, Inc. ....	7900 Lorain Ave. ....	44102
	<b>WADSWORTH</b>	
National Central. ....	687 Seville Rd. ....	44281
	<b>YOUNGSTOWN</b>	
Burton Supply Co. ....	1301 Logan Ave. Box 929 ...	44501
<b>OKLAHOMA</b>	<b>ADA</b>	
Ada Auto Supply ....	301 E. 12th St. ....	74820
	<b>MUSKOGEE</b>	
Victory Motors, Inc. ....	605 S. Cherokee. ....	74401
	<b>OKLAHOMA CITY</b>	
Forest Sales Inc. ....	1039 NW 63rd St. ....	73116
<b>OREGON</b>	<b>PORTLAND</b>	
Kenton Supply Co. ....	8216 N. Denver Ave. ...	97217
<b>PENNSYLVANIA</b>	<b>CHESTER</b>	
Stull Equipment Corp. ....	742 W. Front St. ....	19013
	<b>HARRISBURG</b>	
EECO Inc. ....	4021 N. 6th St. ....	17110
	<b>PHILADELPHIA</b>	
Thompson Rubber Co. ....	5222-24 N. Fifth St. ....	19120
	<b>PITTSBURGH</b>	
Bluemont Co. ....	11125 Frankstown Rd. ....	15235
<b>TENNESSEE</b>	<b>KNOXVILLE</b>	
Master Repair Service. ....	2000 Western Ave. ....	37921
	<b>MEMPHIS</b>	
Memphis Cycle & Supply Co. ....	421 Monroe Ave. ....	38103
American Sales & Service, Inc. ....	1922 Lynnbrook. ....	38116
<b>TEXAS</b>	<b>DALLAS</b>	
Marr Brothers, Inc. ....	423 E. Jefferson. ....	75203
	<b>FORT WORTH</b>	
Woodson Sales Corp. ....	1702 N. Syvania ....	76111
	<b>HOUSTON</b>	
Bullard Supply Co. ....	2409 Commerce St. ....	77003
	<b>SAN ANTONIO</b>	
Catto & Pully, Inc. ....	414 Live Oak ....	78298
<b>UTAH</b>	<b>SALT LAKE CITY</b>	
A-1 Engine & Mower Co. ....	437 E. 9th St. ....	84111
<b>VERMONT</b>	<b>BURLINGTON</b>	
Vermont Hdwe. Co. Inc. ....	180 Flynn Ave. ....	05401
<b>VIRGINIA</b>	<b>RICHMOND</b>	
RBI Corp. ....	963 Myers St. ....	23260
<b>WASHINGTON</b>	<b>SEATTLE</b>	
Bailey's Inc. ....	1414 14th Ave. ....	98102
<b>WEST VIRGINIA</b>	<b>CHARLESTON</b>	
Young's, Inc. ....	233 Virginia St., E. ....	25301
<b>WISCONSIN</b>	<b>APPLETON</b>	
Automotive Supply Co. ....	123 S. Linwood Ave. ...	54911

### WARRANTY PARTS AND SERVICE POLICY

The purpose of warranty is to protect the customer from defects in workmanship and materials, defects which are NOT detected at the time of manufacture. It does not provide for the unlimited and unrestricted replacement of parts. Use and maintenance are the responsibility of the customer. The manufacturer cannot assume responsibility for conditions which it has no control. Simply put, if it's the manufacturer's fault, it's the manufacturer's responsibility; if it's the customer's fault, it's the customer's responsibility.

#### CLAIMS AGAINST THE MANUFACTURER'S WARRANTY INCLUDES

1. **Replacement of Missing Parts** on new equipment.
2. **Replacement of Defective Parts** within the warranty period.
3. **Repair of Defects** within the warranty period.

All claims MUST be substantiated with the following information:

1. **Model Number** of unit involved.
2. **Date** unit was purchased or first put into service.
3. **Date of failure.**
4. **Nature of failure.**

## Free Manuals Download Website

<http://myh66.com>

<http://usermanuals.us>

<http://www.somanuals.com>

<http://www.4manuals.cc>

<http://www.manual-lib.com>

<http://www.404manual.com>

<http://www.luxmanual.com>

<http://aubethermostatmanual.com>

Golf course search by state

<http://golfingnear.com>

Email search by domain

<http://emailbydomain.com>

Auto manuals search

<http://auto.somanuals.com>

TV manuals search

<http://tv.somanuals.com>