

# OWNERS MANUAL

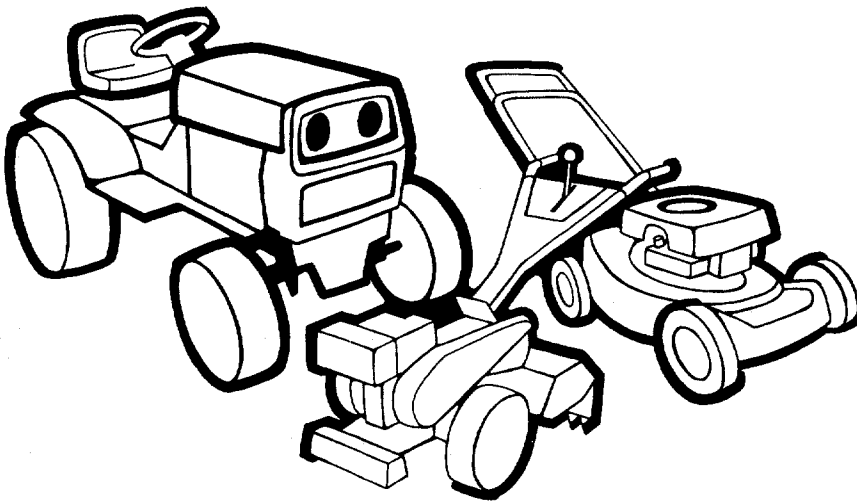

**8 H.P.  
REAR TINE  
TILLER**

**ASSEMBLY  
OPERATION  
MAINTENANCE  
PARTS LIST**

**Model Number  
214-412-000**

**Important:  
Read Safety Rules and  
Instructions Carefully**

Thank you for purchasing an  
American built product.

# INDEX

Safe Operation Practices .....	3	Lubrication .....	14
Assembly .....	4	Maintenance .....	14
Controls .....	8	Off-Season Storage .....	16
Operation .....	11	Illustrated Parts .....	18, 20, 22
How To Use Your Tiller .....	11	Parts List .....	19, 21, 23
Adjustments .....	13	Parts Information .....	Back Cover

## LIMITED WARRANTY

For one year from the date of original retail purchase, MTD PRODUCTS INC will either repair or replace, at its option, free of charge, F.O.B. factory or authorized service firm, any part or parts found to be defective in material or workmanship. Transportation charges for the movement of any power equipment unit or attachment are the responsibility of the purchaser. Transportation charges for any parts submitted for replacement under this warranty must be paid by the purchaser unless such return is requested by MTD PRODUCTS INC.

This warranty will not apply to any part which has become inoperative due to misuse, excessive use, accident, neglect, improper maintenance, alterations, or unless the unit has been operated and maintained in accordance with the instructions furnished. This warranty does not apply to the engine, motor, battery, battery charger or component parts thereof. Please refer to the applicable manufacturer's warranty on these items.

This warranty will not apply where the unit has been used commercially.

Warranty service is available through your local authorized service dealer or distributor. If you do not know the dealer or distributor in your area, please write to the Customer Service Department of MTD.

The return of a complete unit will not be accepted by the factory unless prior written permission has been extended by MTD.

This warranty gives you specific legal rights. You may also have other rights which vary from state to state.



This unit is equipped with an internal combustion engine and should not be used on or near any unimproved forest-covered, brush-covered or grass-covered land unless the engine's exhaust system is equipped with a spark arrester meeting applicable local or state laws (if any). If a spark arrester is used, it should be maintained in effective working order by the operator.

In the State of California the above is required by law (Section 4442 of the California Public Resources Code). Other states may have similar laws. Federal laws apply on federal lands. A spark arrester muffler is available at your nearest engine authorized service center.

**WARNING**

To reduce the potential for any injury, comply with the following safety instructions. Failure to comply with the instructions may result in personal injury.

## SAFE OPERATION PRACTICES FOR TILLERS

1. It is suggested that this manual be read in its entirety before attempting to assemble or operate this unit. Keep this manual in a safe place for future reference and for ordering replacement parts.
2. Your tiller is a precision piece of power equipment, not a plaything. Therefore, exercise extreme caution at all times.
3. Read this Owner's Manual carefully. Be thoroughly familiar with the controls and the proper use of the equipment.
4. Never allow children to operate a power tiller. Only persons well acquainted with these rules of safe operation should be allowed to use your tiller.
5. Keep the area of operation clear of all persons, particularly small children and pets.
6. Do not operate equipment when barefoot or wearing open sandals. Always wear substantial footwear.
7. Do not wear loose fitting clothing that could get caught on the tiller.
8. Do not start the engine unless the shift lever is in the neutral (N) position.
9. Do not stand in front of the tiller while starting the engine.
10. Do not place feet and hands on or near the tines when starting the engine or while the engine is running.
11. Never attempt to make a wheel or depth bar adjustment while the engine is running.
12. Do not leave the tiller unattended with the engine running.
13. Do not walk in front of the tiller while the engine is running.
14. Check the fuel before starting the engine. Gasoline is an extremely flammable fuel. Do not fill gasoline tank indoors, when the engine is running, or while the engine is still hot. Wipe off any spilled gasoline before starting the engine as it may cause a fire or explosion.
15. Do not run the engine while indoors. Exhaust gases are deadly poisonous.
16. Be careful not to touch the muffler after the engine has been running. It is hot.
17. Do not change the engine governor settings or overspeed the engine. Excessive engine speeds are dangerous.
18. Before any maintenance work is performed or adjustments are made, remove the spark plug wire and ground it on the engine block for added safety.
19. Use caution when tilling near buildings and fences. Rotating tines can cause damage or injury.
20. Before attempting to remove rocks, bricks and other objects from tines, stop the engine and be sure the tines have stopped completely. Disconnect the spark plug wire and ground to prevent accidental starting.
21. Check the tine and engine mounting bolts at frequent intervals for proper tightness.
22. Keep all nuts, bolts and screws tight to be sure the equipment is in safe working condition.
23. Never store the equipment with gasoline in the tank inside of a building where fumes may reach an open flame or spark. Allow the engine to cool before storing in any enclosure.

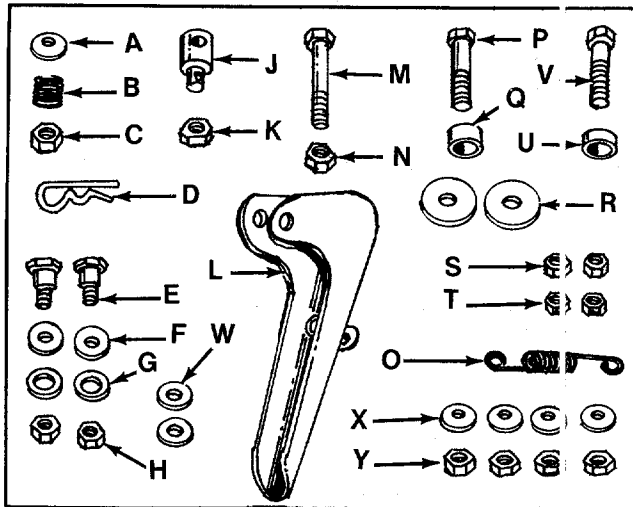

FIGURE 1.

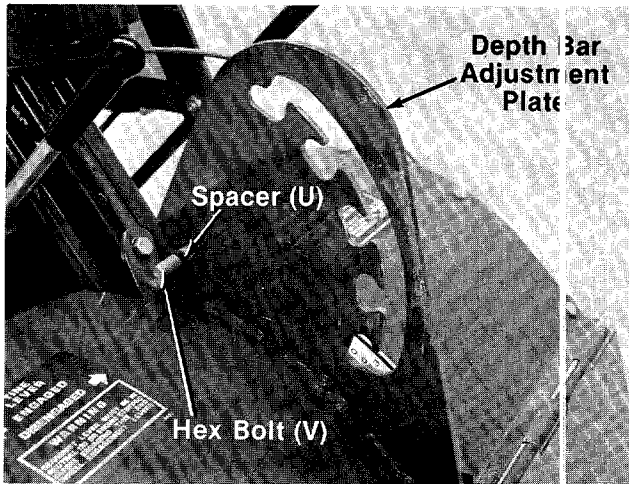

FIGURE 2.

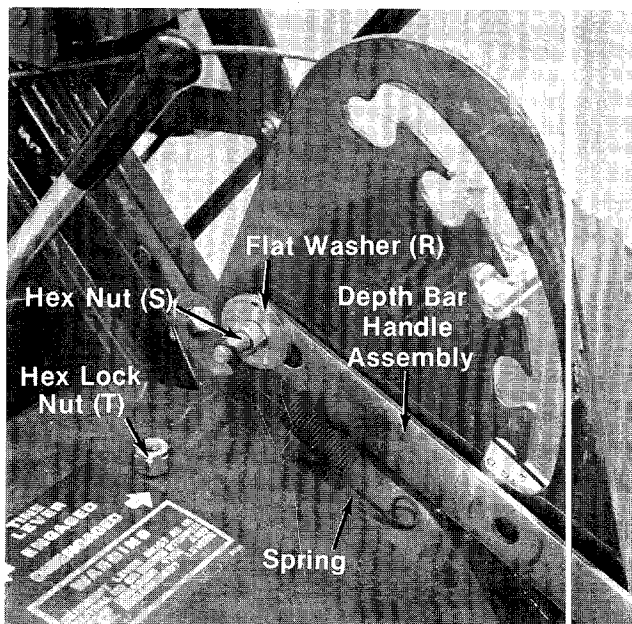

FIGURE 3.

## ASSEMBLY



This unit is shipped WITHOUT GASOLINE or OIL. After assembly, see separate engine manual for proper fuel and engine oil recommendations.

### ← Contents of Hardware Pack: (See Figure 1)

- A (1) Belleville Washer 3/8" I.D.
- B (1) Compression Spring
- C (1) Hex Lock Nut 3/8-24 Thread
- D (1) Hairpin Cotter
- E (2) Shoulder Bolts
- F (2) Belleville Washers 1/2" I.D.
- G (2) Flat Washers 1/2" I.D.
- H (2) Hex Top Lock Nuts 3/8-16 Thread
- J (1) Ferrule
- K (1) Hex Jam Nut 3/8-24 Thread
- L (1) Handle Adjustment Lever
- M (1) Hex Bolt 1/4-20 x 1.75" Long
- N (1) Hex Lock Nut 1/4-20 Thread
- O (1) Spring
- P (1) Hex Bolt 3/8-16 x 1.75" Long
- Q (1) Spacer .38" Long
- R (2) Flat Washers 3/8" I.D.
- S (2) Hex Nuts 3/8-16 Thread
- T (2) Hex Lock Nuts 3/8-16 Thread
- U (1) Spacer .18" Long
- V (1) Hex Bolt 3/8-16 x 1.5" Long
- W (2) Flat Washers 1/4" I.D.
- X (4) Belleville Washers 5/16" I.D.
- Y (4) Hex Nuts 5/16-18 Thread

### ← DEPTH BAR INSTALLATION

1. Grease the depth bar adjustment slots with an automotive chassis grease.
2. Place hex bolt (V) through the hole in the depth bar adjustment plate as shown in figure 2. The head of the bolt must be to the right side of the tiller. Place smaller spacer (U) on the hex bolt.



The right and left side of your tiller is determined from operator's position.

- ← 3. Place slot in depth bar handle assembly over the spacer and hex bolt. Secure with flat washer (R) and hex nut (S), tightening securely. Place one end of spring (O) onto the bolt. Thread hex lock nut (T) on the bolt until the two nuts are approximately 1/8" apart. See figure 3.

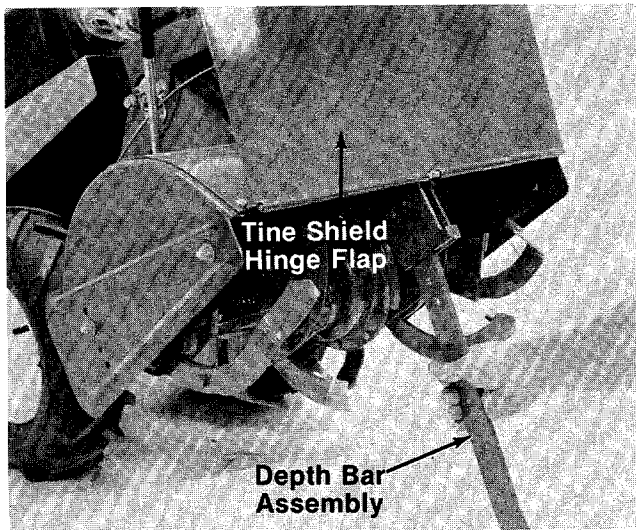

**FIGURE 4.**

4. Raise the tine shield hinge flap assembly. Insert the depth bar assembly up through the tine shield assembly as shown in figure 4.

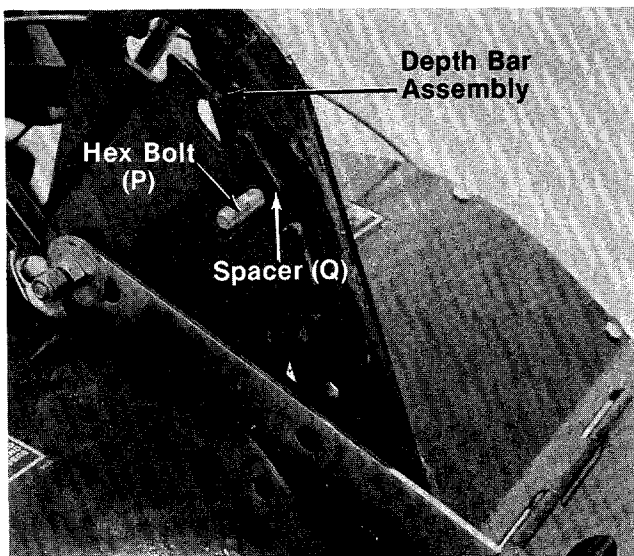

**FIGURE 5.**

5. Place hex bolt (P) through depth bar assembly and through notches in depth bar adjustment plate. Head of hex bolt must be to right side of the tiller. Place spacer (Q) on hex bolt. See figure 5.

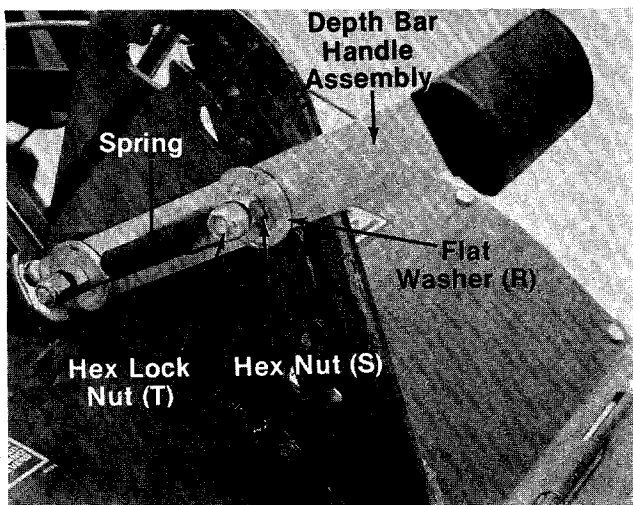

**FIGURE 6.**

6. Place hole in depth bar handle assembly over the spacer and hex bolt. Secure with flat washer (R) and hex nut (S), tightening securely, then backing off one turn. Handle must be able to pivot freely. See figure 6.
7. Place end of spring onto hex bolt. Thread hex lock nut (T) on the bolt until the two nuts are approximately 1/8" apart. See figure 6.

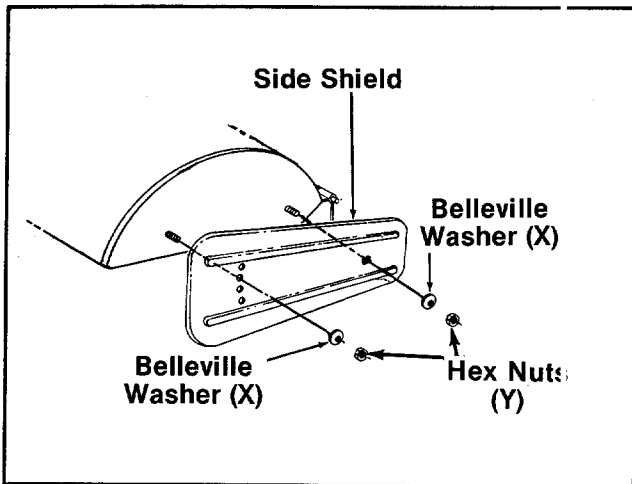

← Assemble the side shields to the tine shield as shown in figure 7, using belleville washers (X) (cupped side against the side shields) and hex nuts (Y). Side shields will be adjusted up or down as the depth bar is adjusted, as described in the Operation section.

FIGURE 7.

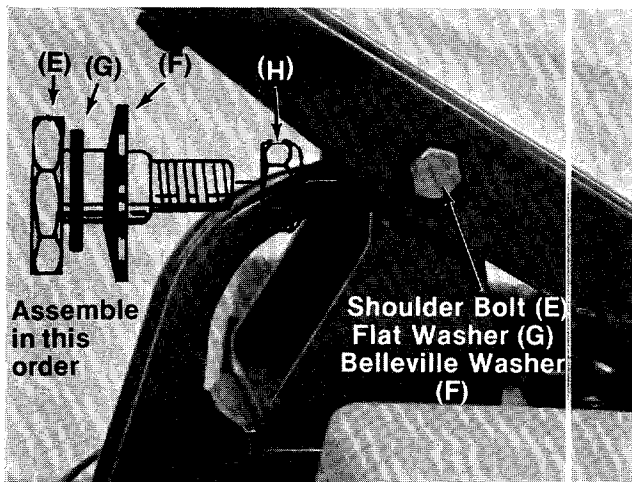

#### HANDLE ASSEMBLY

1. Place the handle assembly in position on the tiller so that the holes in handle line up with holes in mounting bracket.
2. Place flat washer (G) and belleville washer (F) over shoulder on shoulder bolt (E). Place shoulder bolt through handle mounting holes. Secure with hex top lock nut (H) from the inside of handle. See figure 8.

FIGURE 8.

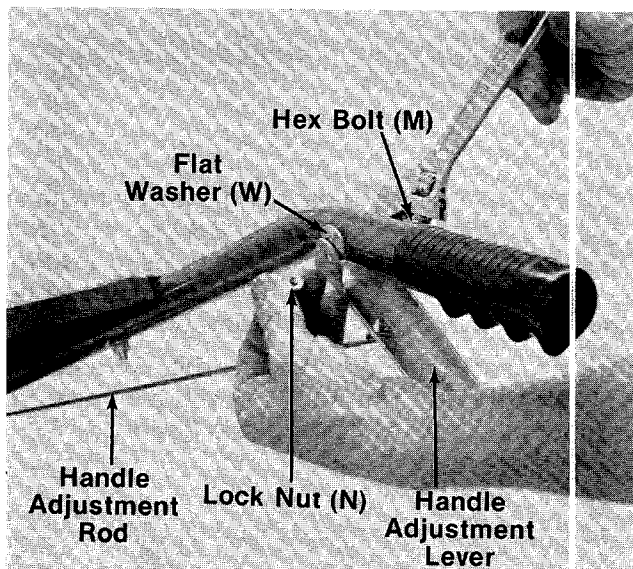

3. To assemble the handle adjustment lever (L), hook handle adjustment rod (already on handle) into lever. Hook to the outside.
4. Place a flat washer (W) on either side of the handle inside of the handle adjustment lever. Secure with hex bolt (M) and lock nut (N). See figure 9. Do not over tighten. Handle adjustment lever must pivot freely.

FIGURE 9.

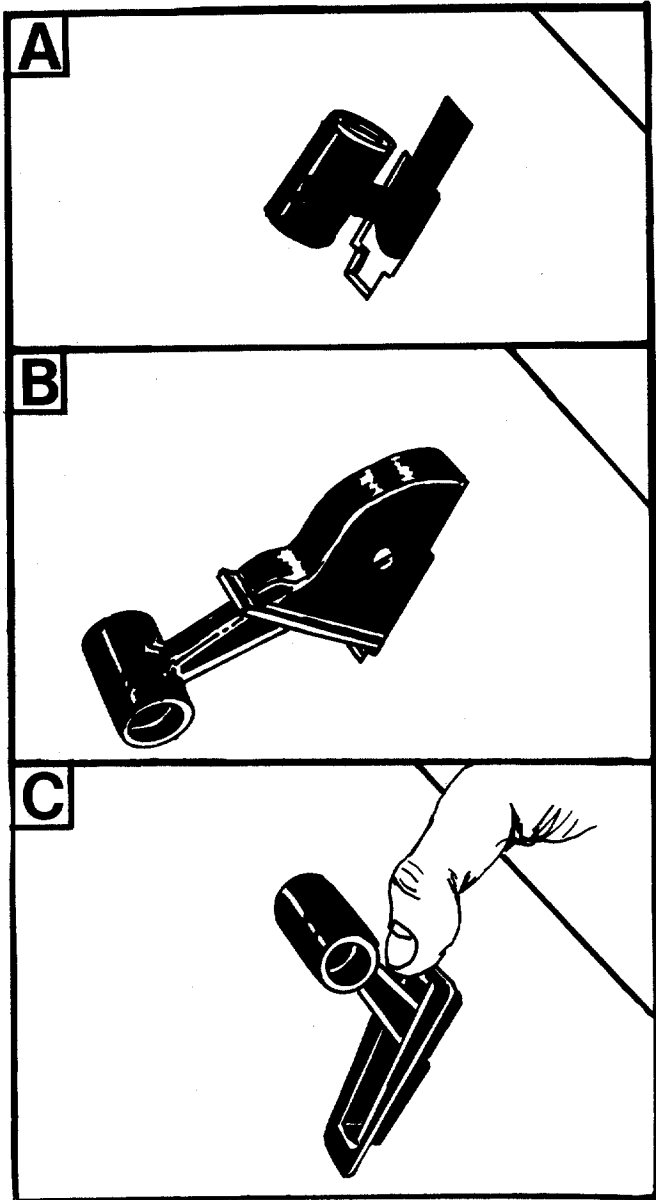

### THROTTLE CONTROL INSTALLATION

Assemble the throttle control to the handle panel as follows.

1. Hold the throttle control assembly beneath the handle panel. Turn the control sideways and insert the lever up through the wide portion of the slot on the handle panel. See figure 10A.

2. After the end of the lever is through the slot, turn and then tip the control forward as shown in figure 8B to slide it through the slot.



#### NOTE

The lever must be all the way to the back of the control housing as shown in figure 10B.

3. Push the control back into the slot in the handle panel and press in place. Be certain the control is locked securely into the slot.

FIGURE 10.

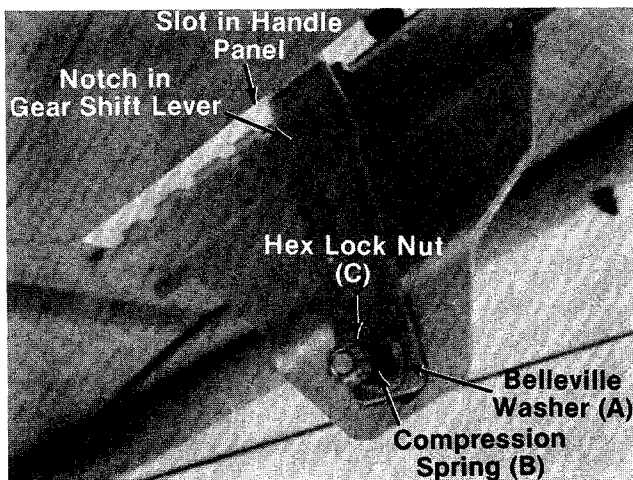

FIGURE 11.

### GEAR SHIFT ROD INSTALLATION

1. Assemble notched edge of gear shift lever so notch faces forward. Place gear shift lever through slot in handle panel. Place bottom hole in gear shift lever over weld stud. Secure with belleville washer (A), compression spring (B) and hex lock nut (C). See figure 11.

2. Tighten hex lock nut until nut is flush with stud. See figure 11.

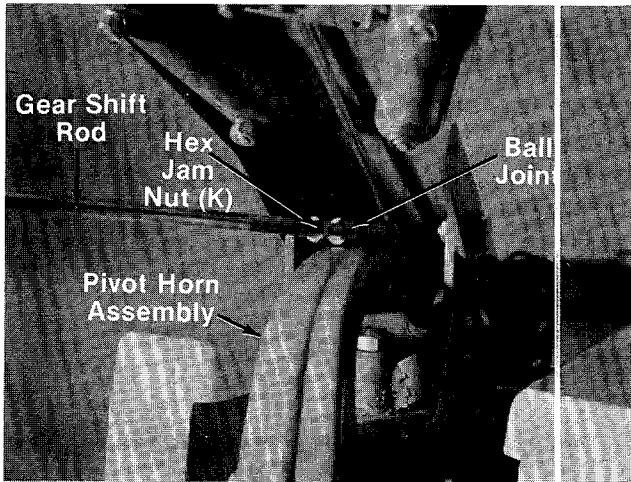

FIGURE 12.

3. Thread hex jam nut (K) on one end of gear shift rod. Then thread gear shift rod into ball joint on the top of pivot horn assembly 10 to 12 complete turns, approximately 1/2 inch. See figure 12. Lock hex jam nut against ball joint.

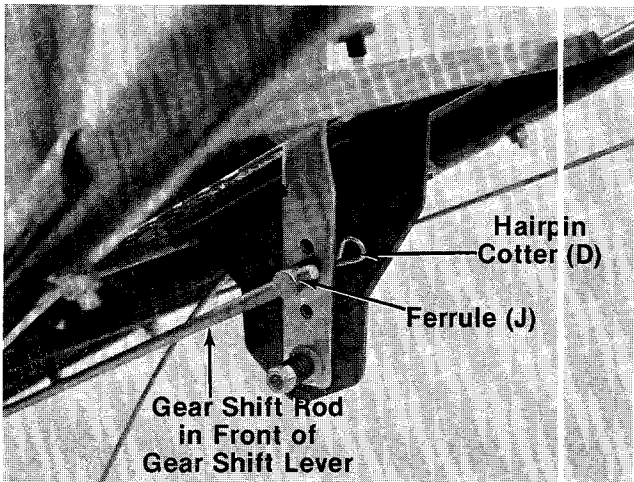

FIGURE 13.

4. Thread ferrule (J) on other end of gear shift rod. See figure 13.
5. Secure ferrule in gear shift lever as shown in figure 13 with hairpin cotter (D).



After all assembly is completed, the gear shift rod must be adjusted prior to initial operation.

### Gear Shift Rod Adjustment



**CAUTION**

Service engine with oil and gasoline before making this adjustment. Refer to the separate engine manual packed with your tiller.

1. Place the gear shift lever in "NEUTRAL" (N) position.
2. Place the tine engagement lever in the **disengaged** position. See figure 22.
3. Place wheel engagement lever in the **disengaged** position. See figure 23.
4. Place the throttle in the "START" position.
5. Move choke lever down (if engine is cold). See figure 17.
6. Start the engine.
7. Engage the gear shift lever through the five gears with the engine running and return to "NEUTRAL" (N).
8. Stop the engine.
9. Remove the hairpin from ferrule and pull out of gear shift lever.
10. Place gear shift lever in first gear (and pull lever to rear of slot). Adjust the ferrule to fit gear shift lever, and replace the hairpin.
11. **Repeat steps 6 through 10** to make the final adjustment.



# CONTROLS—Location and Use

## Gear Shift Lever

The gear shift lever is located in the center of handle panel.



The engine must be running to move the gear shift lever. Shifting gears with the engine off will cause damage to the clutch control rod.

1. Forward (1 thru 5)—Move the lever to the left and forward for each gear. See figure 14.

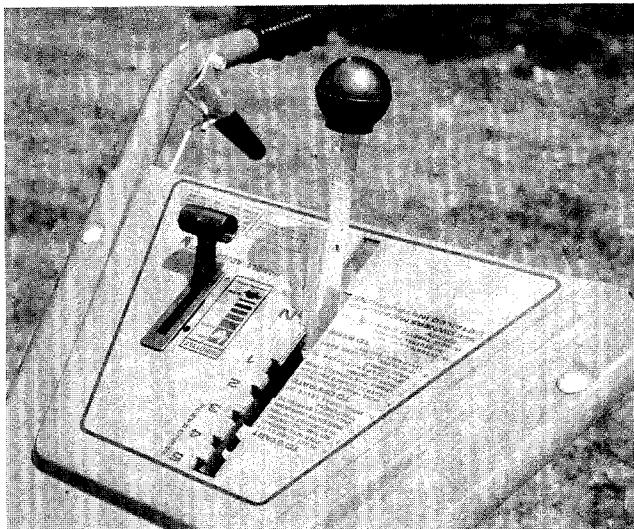

FIGURE 14.

- A. Use (1) first and (2) second gears when breaking the sod for the first time.
- B. Use (3) third and (4) fourth gears when tilling soil which has been tilled before.
- C. Use (5) fifth gear for pulverizing soil or for transporting the tiller.



Use first speed only when operating the tiller for the first time.

2. Neutral (N)—Move lever to detent marked "N."
3. Reverse (R)—Raise up on the handles to lift the tines out of the ground and pull the gear shift lever back (upward) slowly to obtain reverse. Always use caution when using the reverse. When using reverse, if gear shift lever is released it will snap back into neutral (N). See figure 15.

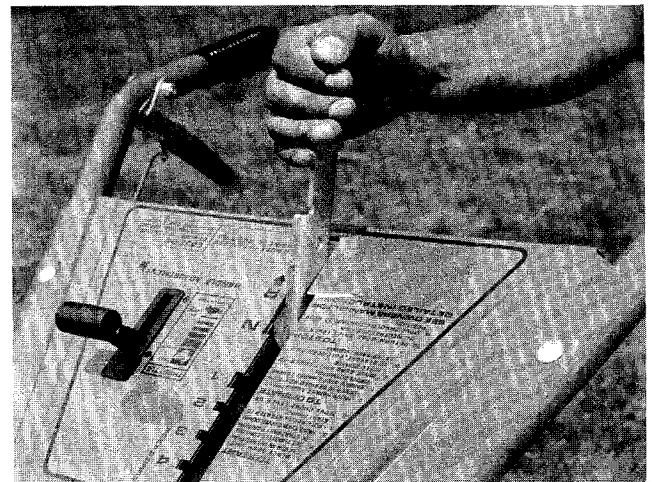

FIGURE 15.

## Throttle Control

The throttle control lever is located on the right hand side of handle panel and controls the engine speed.

1. Start—Push throttle control lever forward (down) to start position. See figure 16.
2. Stop—Pull lever back (upward) to stop the engine.

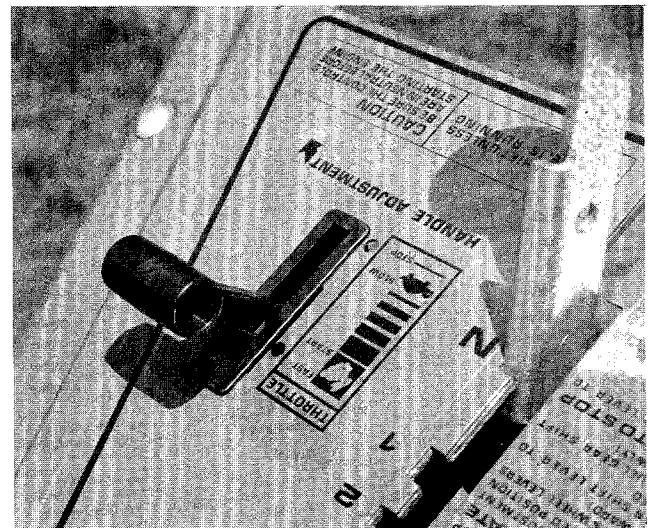
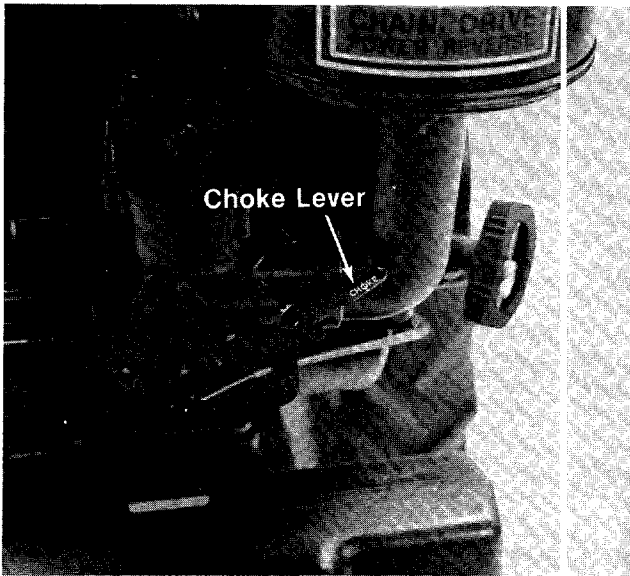

FIGURE 16.

## Choke

The choke is located on the engine just below the air cleaner. To choke the engine, move the choke lever down. See figure 17.



**FIGURE 17.**

**Handle Adjustment Lever**

The handle adjustment lever is located on the right hand handle bar. See figure 18.

Squeeze up on handle adjustment lever and place the handle in one of nine (9) positions. See figures 19, 20 and 21.

If the locking pin does not withdraw from the handle positioner assembly or if the locking pin does not seat securely into the holes in the handle positioner assembly, adjustment is required. Refer to Adjustment Section on page 13.

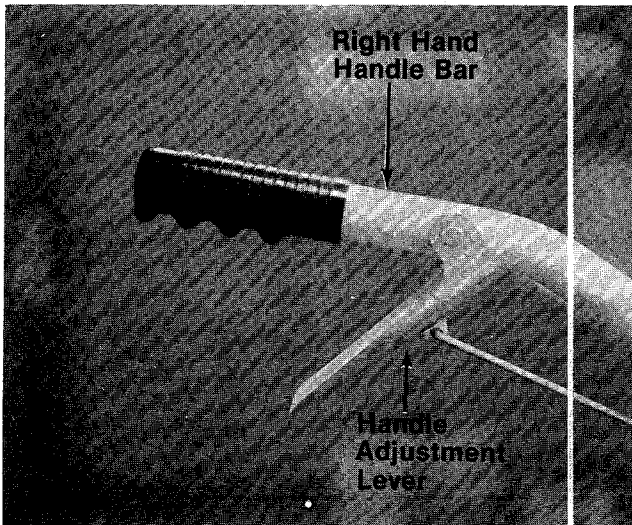

**FIGURE 18.**

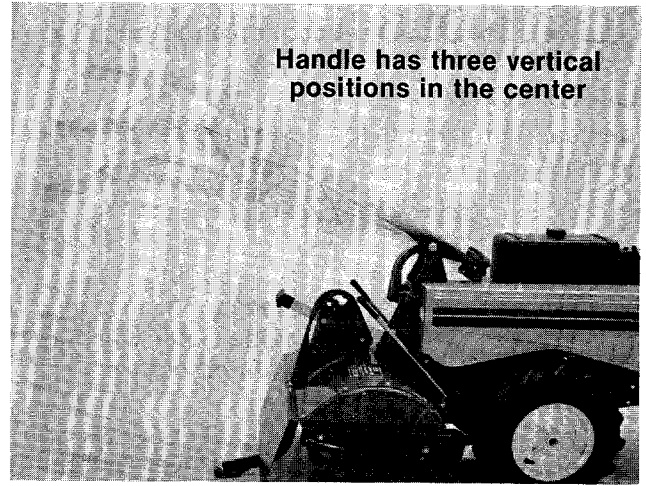

**FIGURE 19.**

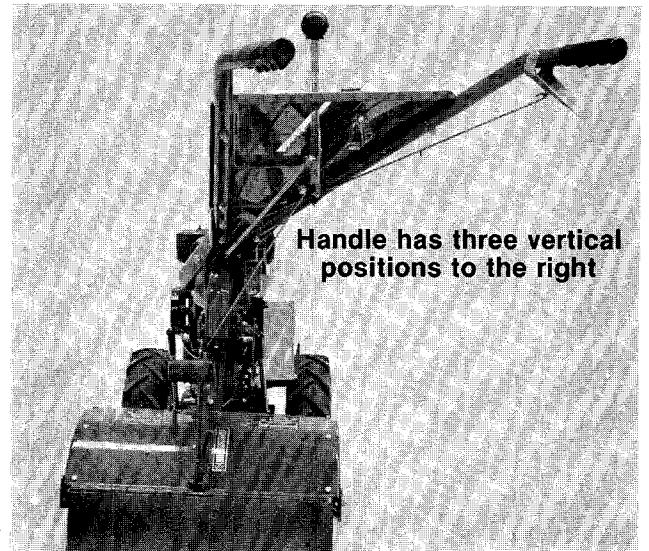

**FIGURE 20.**



**FIGURE 21.**



### WARNING

Before using the tiller, check to be certain the tines are assembled properly (sharp edge of the tines must enter the soil first). Refer to Operation Section.



### WARNING

The gear shift lever must be in **Neutral (N)** position before engaging or disengaging the tine and wheel engagement levers.

#### Tine Engagement Lever

The tine engagement lever is located on the left side of tiller.

To engage tines, move the lever outward. To disengage tines, move the lever inward. See figure 22.



### NOTE

It may be necessary to slightly engage gear shift lever to align the gears.

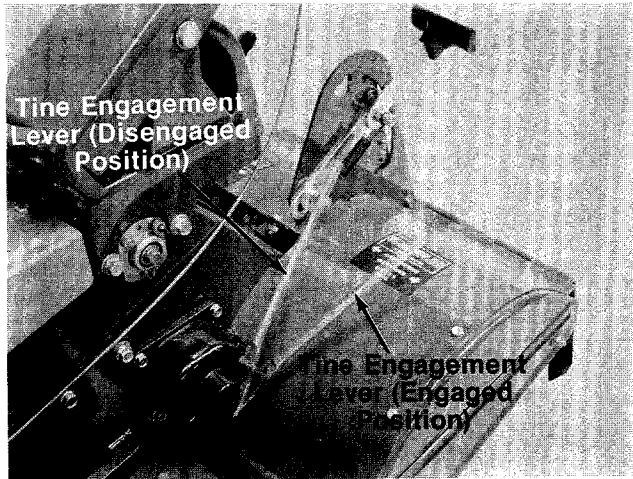

FIGURE 22.

#### Wheel Engagement Lever

The wheel engagement lever is located on the right side of tiller.

To engage wheels, move the lever outward. To disengage or stop wheels, move lever inward. See figure 23.

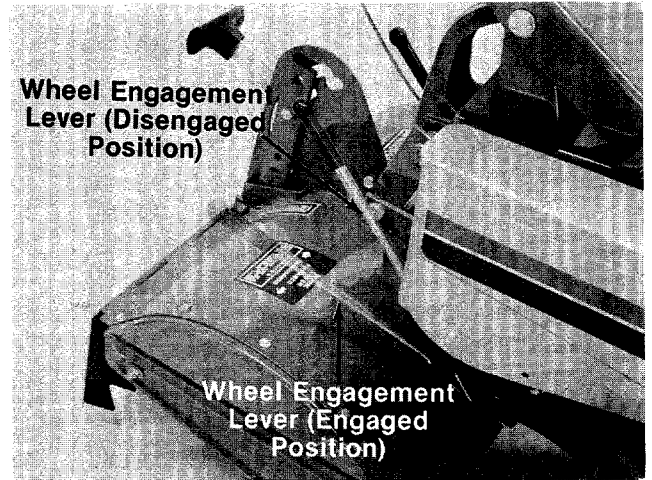

FIGURE 23.

## OPERATION



### CAUTION

Engine is shipped **without** oil.

#### BEFORE STARTING

1. Before operating tiller for the first time or if tines have been removed and reassembled for any reason, check to be certain the tines are assembled correctly. **The sharp edge of the tines must enter the soil first as shown in figure 24.** (Figure 24 illustrates the left hand tines, viewed from the left hand side of the tiller. Right hand tines rotate in the same direction as the left hand tines.)

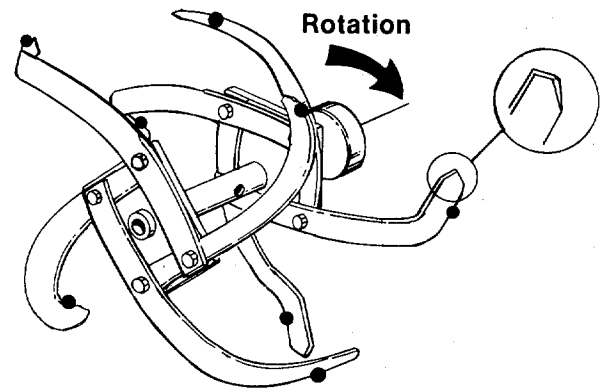

● Sharp Edge

FIGURE 24.

2. Fill crankcase with oil as instructed in the separate engine manual packed with your unit.
3. Fill fuel tank with clean, fresh, lead-free, low-lead or regular grade leaded gasoline.
4. Open fuel shut-off valve.

## TO START ENGINE



**WARNING**

**BE SURE NO ONE IS STANDING IN FRONT OF THE TILLER WHILE THE ENGINE IS RUNNING OR BEING STARTED.**

1. Place the gear shift lever in "NEUTRAL" (N) position. See figure 14.
2. Place the tine engagement lever in the disengaged position. See figure 22.
3. Place the wheel engagement lever in the disengaged position. See figure 23.
4. Place the throttle control lever in "START" position.
5. Move choke lever down to choke engine. See figure 17.



### NOTE

A warm engine may not require choking.

6. Stand at side of tiller. Grasp the starter handle and pull out rapidly. Return it slowly to the engine. Repeat as necessary.
7. After engine starts, move choke lever gradually to "OFF" position.

Refer to engine manual for additional engine information.

## TO STOP ENGINE

1. Move throttle control to "OFF" position.
2. Disconnect spark plug wire and ground to prevent accidentally starting while equipment is unattended.

## HOW TO USE YOUR TILLER



**WARNING**

**When operating the tiller for the first time, use the depth bar setting that gives 1 inch of tilling depth (second slot from the bottom). Refer to figure 25. Use first speed only.**

Your tiller has a variable speed pulley which allows you to change gears, First (1) through Fifth (5), without stopping. The gear shift lever is located on the top center of handle panel. There are Five (5) forward speeds, Neutral (N) and Reverse (R).

- A. Forward speeds: First and second speeds are generally used for tilling sod or soil which has not been tilled before. Third and fourth speeds are usually used for fine tilling or cultivating. The fifth speed is for pulverizing soil or for transporting the tiller. The soil conditions in your area will determine the speed you will want to use.



### IMPORTANT

**Do not** shift gears unless the engine is running. If the engine should stall while in gear, you **must** proceed as follows:

- 1.) Disconnect and ground the spark plug wire against the engine.
- 2.) Move tine and wheel engagement levers to the disengaged position.
- 3.) Pull the recoil starter rope, and at the same time pull back on gear shift lever. Pull the rope out as many times as it takes to move the gear shift lever into neutral (N) position. **Do Not** force shift lever back into neutral at any time.
- 4.) Move the gear shift lever through the forward speeds, neutral and reverse. Readjust control rod if necessary.

B. Neutral (N): The neutral detent on the handle panel is used when starting and stopping the tiller and going from a forward speed to reverse.

C. Reverse (R) Gear: The reverse gear is a dead-man type. If you put the tiller into reverse to back up or to unclog the tines, and you let go of gear shift lever, the reverse motion will **stop**. Reverse will **only** work when you pull the gear shift lever back and hold it in that position.

Raise the handles and lift the tines out of the ground before putting the tiller in reverse gear.



### CAUTION

Placing the tiller in reverse with the tines in the ground will cause premature wear of the reversing disc.

## TILLING

Tilling depth is controlled by the depth bar which can be adjusted to five different settings. See figure 25. Adjust the side shields as shown in figure 25 as you adjust the depth bar. Be certain spark plug wire is disconnected and grounded against the engine.

1. When using the tiller for the first time, use the second adjustment slot from the bottom (1" of tilling depth). See figure 25.

- When breaking up sod and for shallow cultivation, use the setting which gives 1" of tilling depth (second slot from the bottom). Place the side shields in their lowest position. For further depth, raise the depth bar and side shields and make one or two more passes over the area.
- When tilling loose soil, depth bar may be raised to the top slot to give the deepest tilling depth. Raise the side shields to their highest position.
- To transport tiller, lower the depth bar (use bottom adjustment slot).

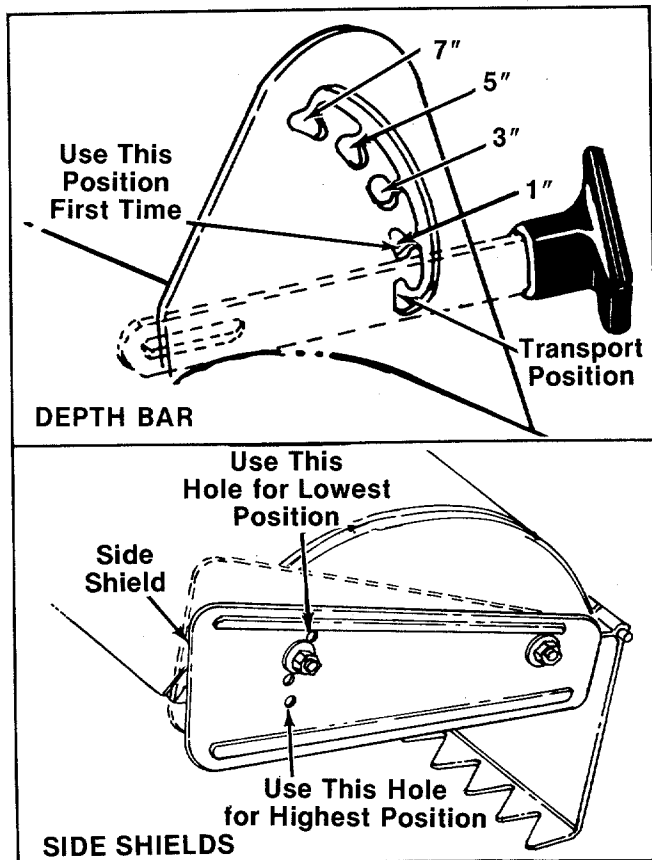

**FIGURE 25.**

To adjust the depth bar, lift up on the tiller handles. Pull the depth bar handle assembly and move the depth bar to desired setting. Release the handle. See figure 25.

To operate the tiller:

- Select the depth bar setting.
- Start engine as instructed on page 12.
- Engage wheel and tine engagement levers.
- Move gear shift lever to first speed position (wheels and tines will be moving).



Engage wheel drive before engaging the tine engagement lever.



To transport tiller, **do not** engage the tine engagement lever. Engage the wheels only.

For best results, it is recommended the garden be tilled twice (lengthwise, then widthwise) to pulverize the soil.

## ADJUSTMENTS

**HANDLE ADJUSTMENT LEVER (See Figure 26)**



Figure 26 is viewed from the bottom of handle panel.

Position A. Use if not enough free play.

Position B. Normal setting.

Position C. Use if pin will not withdraw completely from bracket.

To make the adjustment, loosen hex lock nut and reposition the rod in Position A, B or C. See figure 26.

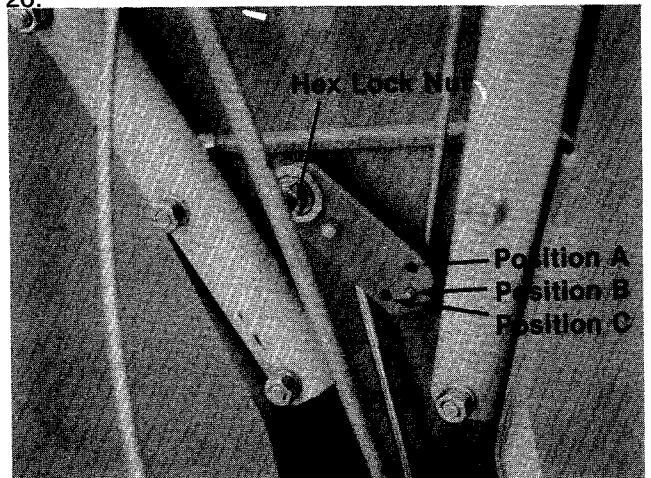
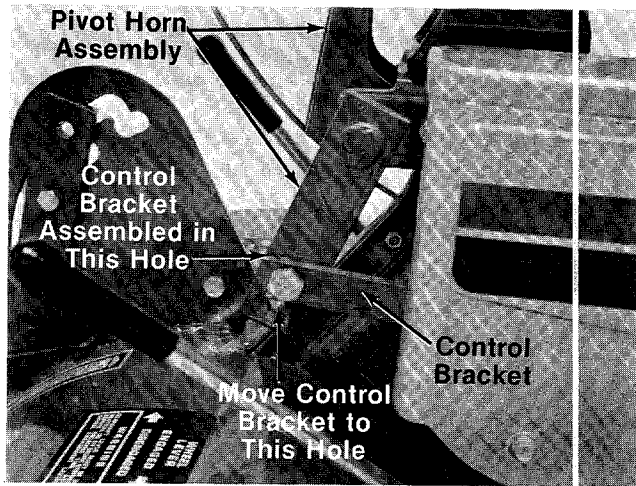

**FIGURE 26.**

### CONTROL BRACKET ADJUSTMENT

When the belt has become worn and/or stretched or the friction wheel has become worn, make the following adjustment.

Move the control bracket to the bottom hole on the pivot horn assembly and readjust the gear shift rod. See figure 27.



**FIGURE 27.**  
**THROTTLE CONTROL CABLE ADJUSTMENT**

1. Place the throttle control lever in "STOP" position.
2. Loosen the casing clamp screw and move the throttle control wire in as far as possible. See figure 28.
3. Tighten the casing clamp screw.

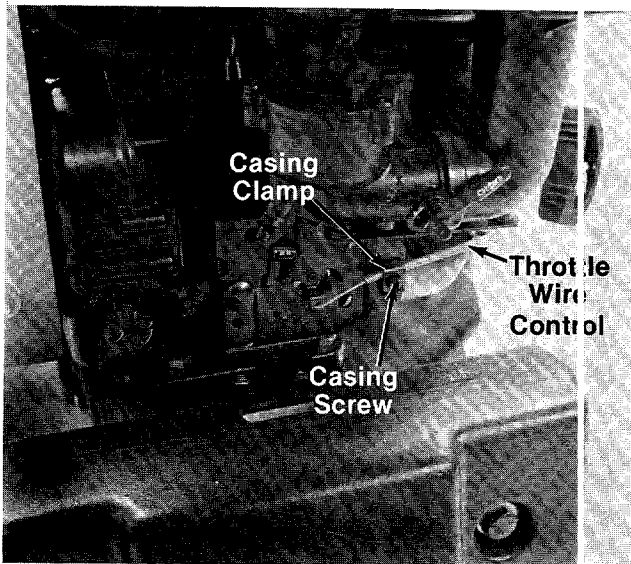

**FIGURE 28.**

**CARBURETOR ADJUSTMENT**



If any adjustments are made to the engine while the engine is running, (e.g. carburetor), disengage all clutches and tines. Keep clear of all moving parts. Be careful of heated surfaces and muffler.

Never make unnecessary adjustments. The factory settings are correct for most applications. If adjustments are needed, refer to the separate engine manual packed with your tiller.

**LUBRICATION**

**TRANSMISSION**

The transmission is lubricated and sealed at the factory. It requires no additional lubrication unless the transmission is disassembled. To fill with grease, lay the left half of the transmission on its side, add 28 ounces of Plastilube #0 grease and assemble the right half to it. This grease can be purchased from your nearest service dealer. (Order Part No. 737-0133.)

**DEPTH BAR ADJUSTMENT SLOTS**

Clean and grease the depth bar adjustment slots at least once a season with an automotive chassis grease.

**PIVOT POINTS**

Lubricate all pivot points and linkages at least once a season with light oil.

**MAINTENANCE**



Disconnect the spark plug wire and ground it against the engine before performing any repairs or maintenance.



If for any reason the tines are removed from the tiller, be certain the tines are reassembled so that the sharp edge of the tines enter the soil first. Refer to item number one under "Operation."

**ENGINE OIL**

After the first two hours of operating a new engine, drain the oil from the crankcase while the engine is still hot and refill the crankcase with new oil; thereafter change the oil after every 25 hours of operation.

To avoid spilling gasoline on your lawn or driveway, plan to change the oil when the gasoline tank and carburetor are empty.

To change the oil, refer to the separate engine manual.

Check oil level every eight hours of operation. Be sure level is maintained full to point of overflowing.

### AIR CLEANER

Under normal operating conditions, the air cleaner, located on top of the carburetor, must be serviced after every ten hours of use. Under extremely dusty operating conditions, the air cleaner must be serviced after every hour of operation.

To service the air cleaner, refer to the separate engine manual packed with your tiller.



### CAUTION

Never run your engine without air cleaner completely assembled.

### CLEANING ENGINE AND TINE AREA

Any fuel or oil spilled on the tiller should be wiped off promptly. Dirt, leaves and other debris must not be left to accumulate around the cooling fins or the engine or on any part of the tiller. Clean the underside of the tine shield after each use. The dirt washes off the tines easier if washed off immediately instead of after it dries.

### SPARK PLUG

The spark plug should be cleaned and the gap reset every 25 hours of engine operation. Spark plug replacement is recommended at the start of each tiller season; check engine manual for correct plug type and gap specification.

### FUEL SHUT-OFF VALVE AND FILTER

The valve and filter is located on the bottom of the gasoline tank located on top of the tiller.

Turn the valve knob in to shut off the fuel flow. Turn the valve knob out to operate the tractor. See figure 29.

The entire valve can be pulled out to clean the filter. When reassembling, place the rubber grommet into the gasoline tank first, then push the valve all the way in.



### WARNING

Only use factory approved parts if repairs are needed on the gasoline tank, grommet, valve or gasoline line.

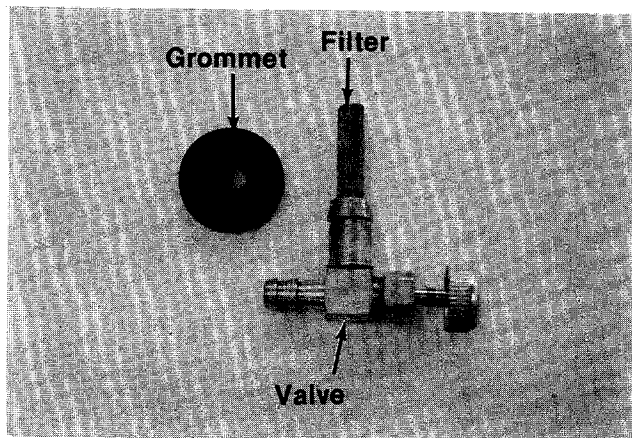

FIGURE 29.

### LIMITED TORQUE CLUTCH

If the limited torque clutch is disassembled for any reason, reassemble as shown on page 22.



### NOTE

Torque setting is 550 to 650 in. lbs.

If you do not have a torque wrench, proceed as follows:

1. Run the first nut on until it touches the spring bell washer.
2. Mark nut and plate with a scribe line.
3. Tighten nut 3/4 of a turn clockwise.
4. Then lock in place with the second hex jam nut.

### BELT REPLACEMENT



### CAUTION

Do not use an off-the-shelf belt.

Your tiller has been engineered with belts made of special material (Kevlar Tensile) for longer life and better performance. They should not be replaced with an off-the-shelf belt.

If belt replacement is required, order belt or belts by part number from your nearest authorized dealer.

Part No. 754-0220  
5/8" x 27" Short Belt

Part No. 754-0268  
5/8" x 51" Long Belt

### Front (Short) Belt Removal

1. Remove belt cover by removing the four self-tapping screws and flat washers. See figure 30.



### CAUTION

Muffler may be **hot** in the area of belt cover. Only remove the belt cover when engine is cool.

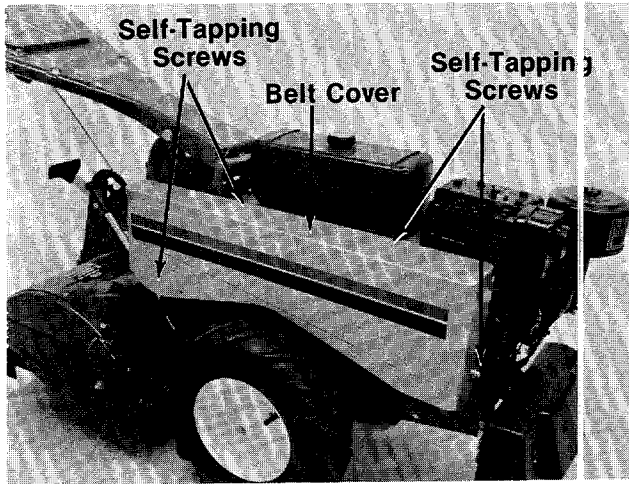

**FIGURE 30.**

- Place gear shift lever in neutral position. Hold friction disc with one hand. Remove three hex bolts and lock washers which hold the friction disc to the variable speed pulley. See figure 31. Lift belt off the variable speed pulley.



**NOTE**

Upon reassembly of friction disc, tighten the three bolts equally.

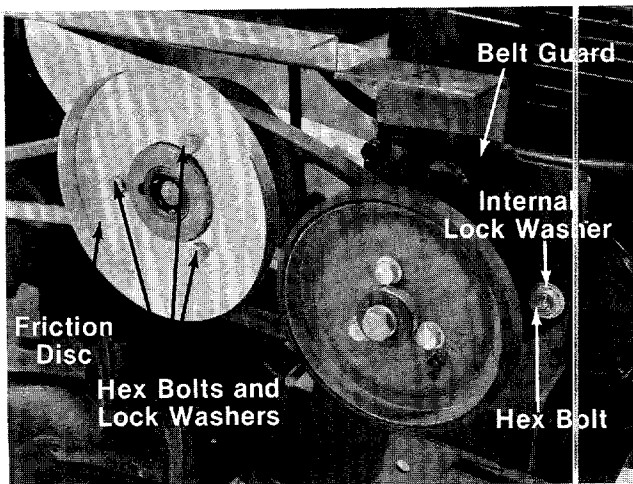

**FIGURE 31.**

- Remove the hex bolt and internal lock washer which holds the belt guard to the engine. See figure 31. Remove the belt guard. Remove and replace the belt.

**Rear (Long) Belt Removal**

- Follow step numbers 1 and 2 under "Front Belt Removal."
- Place the gear shift lever in one of the forward gears (as far forward as possible).

- Lift up on the idler pulley by hand, and remove the belt from beneath the idler pulley. Lift belt off the transmission pulley and variable speed pulley. See figure 32.

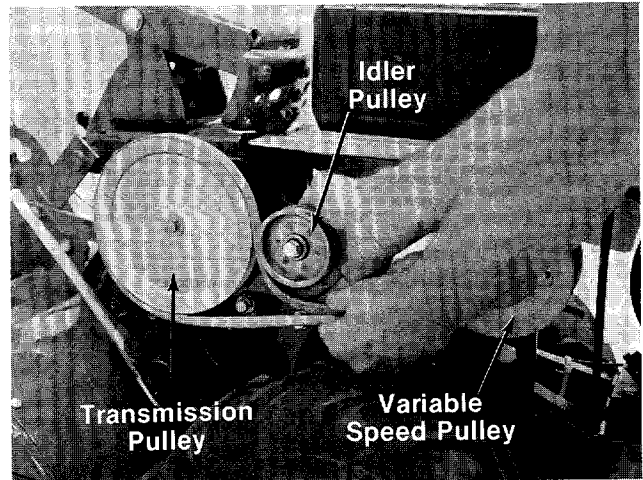

**FIGURE 32.**

- Reassemble in reverse order with the new belt.



**NOTE**

Be certain to assemble the new rear belt in the second groove on the variable speed pulley.

**TIRE CHAINS**

It may be necessary to move the right hand wheel assembly to the extreme outside position when using tire chains. See illustration below.

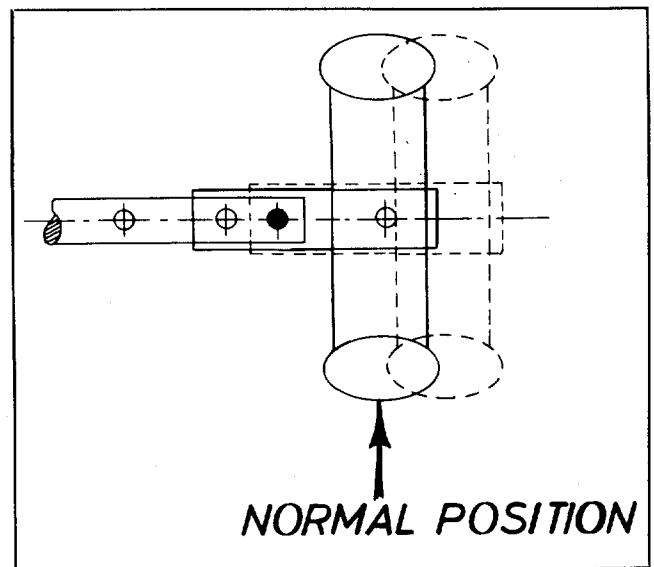



# OFF-SEASON STORAGE

If the tiller is to be inoperative for a period longer than 30 days, the following precautions are recommended. Keep your tiller in a weatherproof dry area. If stored for over 30 days the following steps will protect the essential engine parts from gum deposits.

1. Working outdoors, drain all fuel from the fuel tank. Use a clean dry cloth to absorb the small amount of fuel remaining in the tank, then run the engine until all fuel in carburetor is exhausted.



**WARNING**

**DO NOT DRAIN FUEL WHILE SMOKING, OR IF NEAR AN OPEN FIRE.**

2. Drain all the oil from the crankcase (this should be done after the engine has been operated and is still warm) and refill the crankcase with clean new oil.
3. Disconnect the spark plug wire and remove the spark plug from the cylinder. Pour about six drops of engine oil into the cylinder, and then pull the recoil starter several times to spread the oil on the cylinder wall. Replace the spark plug, but **DO NOT** connect the wire.
4. Clean the engine and the entire tiller thoroughly.

5. Wipe tines with oiled rag to prevent rust.



**CAUTION**

When storing any type of power equipment in an unventilated or metal storage shed, care should be taken to rust proof the equipment. Using a light oil or silicone, coat the equipment, especially any springs, bearings and cables.

## TILLER WINTERIZING INSTRUCTIONS FOR USE WITH SNOW BLADE:

1. For cold weather (below 32°F.), drain oil from tiller engine crankcase and replace with SAE 10W or 10W-20 detergent oil.
2. Replace any remaining fuel on hand or in the engine fuel tank with a fresh supply of winter grade fuel. Winter fuels contain additives for faster starts. Keep fuel tank full.



**NOTE**

It may be necessary to enrich the carburetor idle and high speed jets 1/8 to 1/4 turn (counterclockwise) for good performance.

3. In the spring of the year, before the tilling season, be sure to change engine oil back to SAE 30W detergent oil.

### TROUBLE SHOOTING CHART

SYMPTOM	POSSIBLE CAUSE(S)	SOLUTION
Engine fails to start	<ol style="list-style-type: none"> <li>1. Check fuel tank for gas.</li> <li>2. Spark plug lead wire disconnected.</li> <li>3. Faulty spark plug.</li> </ol>	<ol style="list-style-type: none"> <li>1. Fill tank if empty.</li> <li>2. Connect lead wire.</li> <li>3. Spark should jump gap between control electrode and side electrode. If spark does not jump, replace the spark plug.</li> </ol>
Hard starting or loss of power	<ol style="list-style-type: none"> <li>1. Spark plug wire loose.</li> <li>2. Dirty air cleaner.</li> </ol>	<ol style="list-style-type: none"> <li>1. Connect and tighten spark plug wire.</li> <li>2. Clean air cleaner as described in engine manual.</li> </ol>
Engine overheats	<ol style="list-style-type: none"> <li>1. Carburetor not adjusted properly.</li> <li>2. Air flow restricted.</li> <li>3. Engine oil level low.</li> </ol>	<ol style="list-style-type: none"> <li>1. Adjust carburetor. See engine manual.</li> <li>2. Remove blower housing and clean as described in the engine manual.</li> <li>3. Fill crankcase with the proper oil.</li> </ol>
Controls do not engage	Belts worn and/or stretched.	Make control bracket adjustment. See adjustment section of manual.

**NOTE:** For repairs beyond the minor adjustments listed above, please contact your local service dealer.

# NOTES

A large, empty rectangular box with a black border, occupying most of the page. It is intended for the user to write notes.

# Model 412

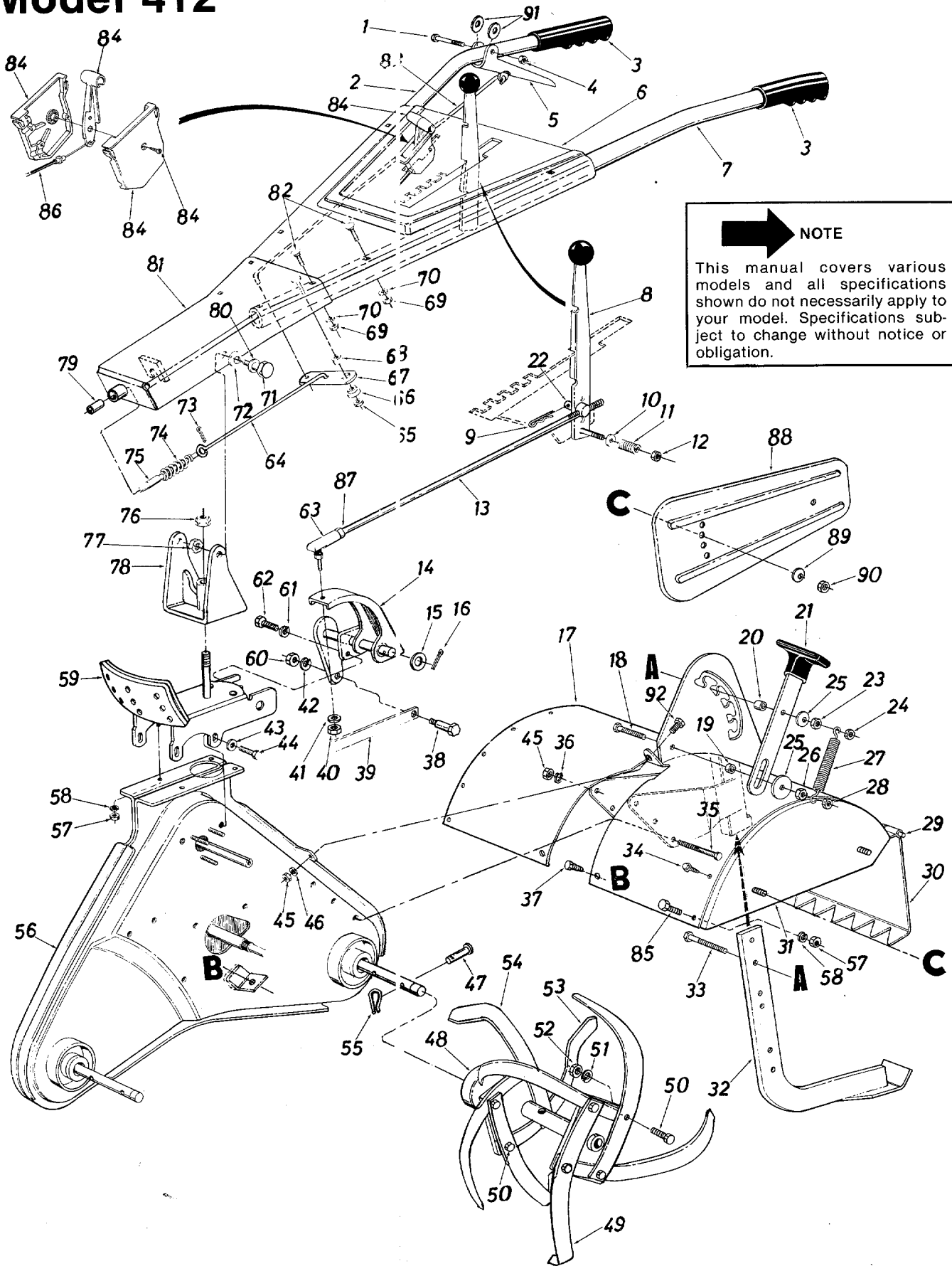

**NOTE**

This manual covers various models and all specifications shown do not necessarily apply to your model. Specifications subject to change without notice or obligation.

# Model 412

## PARTS LIST FOR MODEL 412 TILLER

REF. NO.	PART NO.	COLOR CODE	DESCRIPTION	NEW PART	REF. NO.	PART NO.	COLOR CODE	DESCRIPTION	NEW PART
1	710-0136		Hex Bolt 1/4-20 x 1.75" Lg.*		44	710-0623		Hex Wash. Hd. Self-Tap Scr.	
2	749-0268		Handle—R.H.		45	712-0241		Hex Nut 3/8-24 Thd.*	
3	720-0180		Grip		46	736-0169		L-Wash. 3/8" Scr.*	
4	712-0107		Hex Cent. L-Nut 1/4-20 Thd.		47	711-0679		Clevis Pin	
5	14844		Clutch Grip		48	15295		Tine Adapter Ass'y.	
6	04831		Handle Panel Ass'y.		49	15387		L.H. Tine Ass'y. Comp.	
7	749-0269		Handle—L.H.			15386		R.H. Tine Ass'y. Comp.	
8	04810		Clutch Handle Ass'y.					(Not Shown)	
9	714-0149		Hairpin Cotter		50	710-0192		Hex Bolt 3/8-24 x 1.25" Lg.*	
10	736-0105		Belleville Wash. .38" I.D.		51	736-0169		L-Wash. 3/8" I.D.*	
11	732-0193		Compression Spring .88" O.D. x .81" Lg.		52	712-0241		Hex Nut 3/8-24 Thd.*	
12	712-0214		Hex Cent. L-Nut 3/8-24 Thd.		53	742-0244		Tine—R.H.	
13	747-0278		Gear Shift Rod		54	742-0243		Tine—L.H.	
14	14734		Pivot Horn Ass'y.		55	714-0149		Hairpin Cotter	
15	736-0290		FI-Wash. .630 I.D. x 1.0" O.D. x .063		56	15385		Chain Case Ass'y. Comp.	
16	714-0474		Cotter Pin 1/8" Dia. x .75" Lg.*		57	712-0267		Hex Nut 5/16-18 Thd.*	
17	15381		Tine Shield Ass'y.		58	736-0119		L-Wash. 5/16" I.D.*	
18	710-0344		Hex Bolt 3/8-16 x 1.5" Lg.*		59	14744		Handle Positioner Ass'y.	
19	750-0527		Spacer .38 I.D. x .50 O.D. x .18 Lg.		60	712-0130		Hex Ins. L-Nut 3/8-16 Thd.	
20	750-0528		Spacer .38 I.D. x .50 O.D. x .38 Lg.		61	736-0119		L-Wash. 5/16" I.D.*	
21	14843		Depth Bar Handle Ass'y. w/Knob		62	710-0601		Hex Wash. Hd. Self-Tap Scr.	
22	711-0198		Ferrule		63	723-0156		Rod End 3/8-24 Thd.	
23	712-0798		Hex Nut 3/8-16 Thd.*		64	747-0254		Lower Handle Control Rod	
24	712-0130		Hex Ins. L-Nut 3/8-16 Thd.		65	712-0158		Hex Nut 5/16-18 Thd.*	
25	736-0227		FI-Wash. .38 I.D. x 1.50 O.D. x .13		66	748-0516		Pivot Handle Brg.	
26	712-0798		Hex Nut 3/8-16 Thd.*		67	04819		Pivot Handle Link	
27	732-0416		Spring—Depth Bar		68	736-0289		Bushing Wash.	
28	712-0130		Hex Ins. L-Nut 3/8-16 Thd.		69	712-0267		Hex Nut 5/16-18 Thd.*	
29	747-0252		Hinge Rod		70	736-0119		L-Wash. 5/16" I.D.*	
30	04804		Tine Shield Hinge Flap Ass'y.		71	738-0143		Shld. Bolt .500" Dia. x .660	
31	15389		Side Cover Tine Shield—L.H.		72	736-0253		Belleville Wash. .505" I.D. x 1.00" O.D.	
	15388		Side Cover Tine Shield—R.H. (Not Shown)		73	714-0474		Cotter Pin 1/8" Dia. x .75" Lg.*	
32	14731		Depth/Drag Bar Ass'y.		74	732-0132		Compression Spring	
33	710-0347		Hex Bolt 3/8-16 x 1.75" Lg.*		75	711-0663		Locking Pin	
34	710-0604		Hex Wash. Hd. Self-Tap Scr. 5/16-18 x .62" Lg.		76	712-0221		Hex Ins. L-Nut 5/8-16 Thd.	
	712-0292		Speed Nut		77	712-0181		Hex Top L-Nut 3/8-16 Thd.	
35	710-0830		Hex Bolt 3/8-24 x 3.0" Lg.		78	04812		Pivot Brkt. Ass'y.	
36	736-0169		L-Wash. 3/8" I.D.*		79	748-0150		Sleeve Brg. .50" I.D. x .62" O.D. x 1.12" Lg.	
37	710-0623		Hex Wash. Hd. Self-Tap Scr.		80	736-0192		FI-Wash. .50" I.D. x 1.00" O.D. x .090	
38	738-0258		Shoulder Bolt .50" Dia. x .25" Lg.		81	04792		Handle Mtg. Brkt. Ass'y.	
39	04841		Control Bracket		82	710-0458		Carriage Bolt 5/16-18 x 1.75" Lg.*	
40	712-0116		Hex Ins. L-Nut 3/8-24 Thd.		83	747-0255		Handle Lock Rod	
41	736-0169		L-Wash. 3/8" I.D.*		84	831-0692		Throttle Control Box Ass'y.	N
42	736-0169		L-Wash. 3/8" I.D.*		85	710-0118		Hex Bolt 5/16-18 x .75" Lg.*	
43	736-0105		Belleville Wash.		86	746-0502		Throttle Control Wire	N
					87	712-0711		Hex Jam Nut 3/8-24 Thd.	
					88	15390		Side Shield	
					89	736-0170		Bell-Wash.	
					90	712-0267		Hex Nut 5/16-18 Thd.	
					91	736-0173		FI-Wash. 1/4" I.D.	
					92	710-0191		Hex Bolt 3/8-24 x .75" Lg.	

(463—Top Flite Red)

(447—Patina Silver)

\*For faster service obtain standard nuts, bolts and washers locally. If these items cannot be obtained locally, order by part number and size as shown on parts list.

When ordering parts, if color or finish is important use the appropriate color code shown above. (e.g. Top Flite Red—04820 (463).)

# Model 412

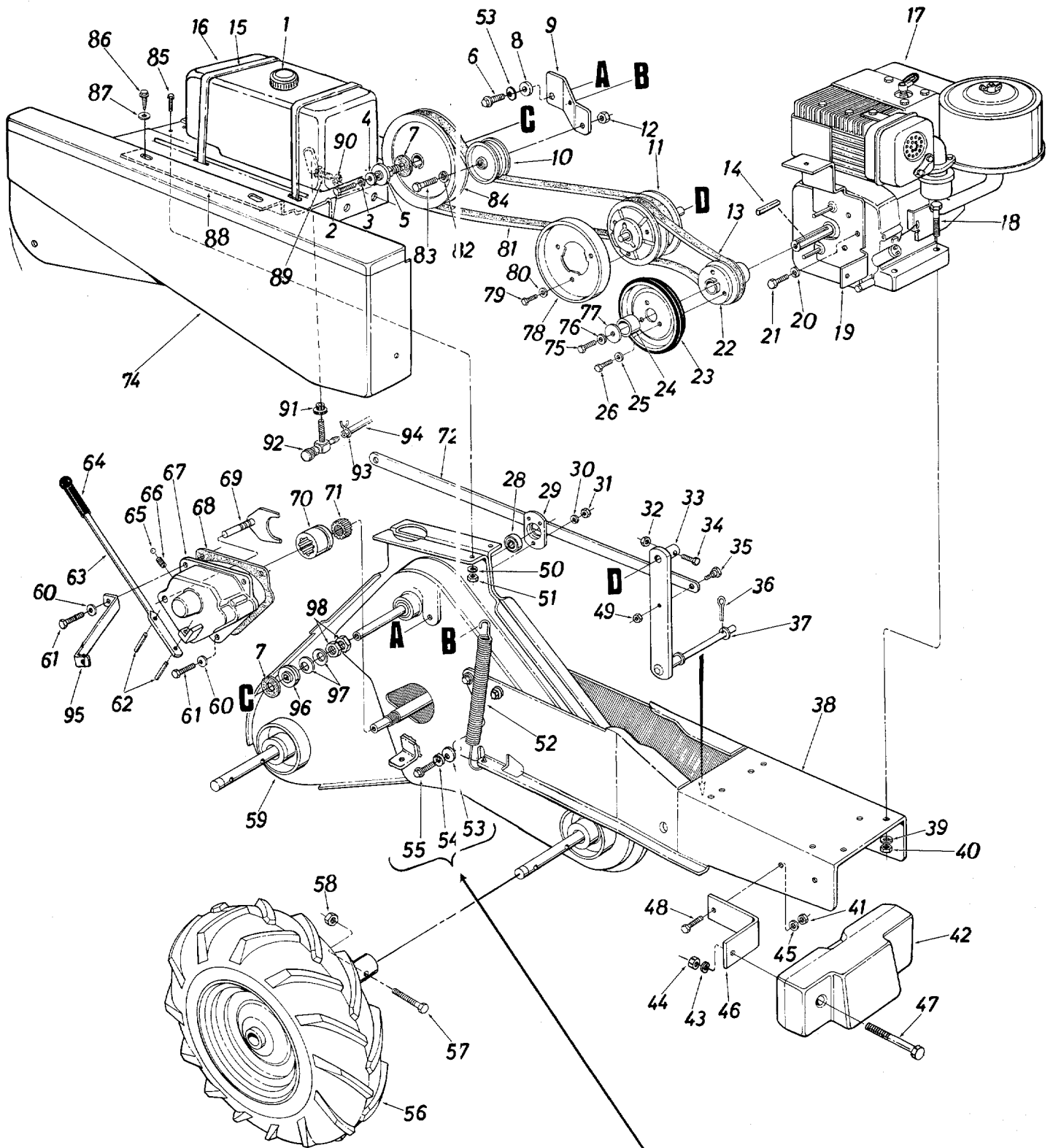

NOTE: The engine is not under warranty by the tiller manufacturer. . . If repairs or service is needed on the engine, please contact your nearest authorized engine service outlet. Check the "Yellow Pages" of your telephone book under "Engines—Gasoline."

Find It Fast  
In The  
Yellow Pages



**IMPORTANT**

The chain case **must be** assembled to the frame with 3/4" hex bolt, lock washer and belleville washer as shown.

# Model 412

## PARTS LIST FOR MODEL 412 TILLER

REF. NO.	PART NO.	COLOR CODE	DESCRIPTION	NEW PART	REF. NO.	PART NO.	COLOR CODE	DESCRIPTION	NEW PART
1	723-0365		Gas Cap		53	736-0105		Belleville Wash. 3/8" I.D.	
2	710-0876		Hex L-Bolt 5/16-24 x 1.5" Lg.		54	736-0169		L-Wash. 3/8" I.D.*	
3	736-0119		L-Wash. 5/16" I.D.*		55	710-0623		Hex Self-Tap Scr. 3/8-16 x .75" Lg.	
4	736-0231		FI-Wash. 5/16" I.D. x 1.125" O.D.		56	734-0806		Wheel Ass'y. Comp.—R.H.	
5	15727		Friction Disc Ass'y.	N		734-0807		Wheel Ass'y. Comp.—L.H. (Not Shown)	
6	710-0191		Hex Bolt 3/8-24 x 1.25" Lg.		57	710-0191		Hex Bolt 3/8-24 x 1.25" Lg.*	
7	761-0189		Friction Pad		58	712-0116		Hex Ins. L-Nut 3/8-24 Thd.	
8	738-0372		Shoulder Spacer		59	<del>45835</del> 15385		Chain Case Ass'y. Comp.	
9	14740		Idler Bracket		60	736-0119		L-Wash. 5/16" I.D.*	
10	756-0225		FI-Idler 2.75" Dia.		61	710-0601		Hex Tap Tite Scr. 5/16-18 x .75" Lg.	
11	717-0343		Variable Speed Ass'y.		62	715-0139		Headed Spiral Pin 3/16 x 13/16" Lg.	
12	712-0130		Hex Ins. L-Nut 3/8-16 Thd.		63	747-0265		Engagement Lever	
13	754-0220		"V"-Belt 5/8" x 27.0" Lg.		64	720-0143		Grip	
14	714-0118		Sq. Key 1/4" x 1.50" Lg.*		65	741-0862		Ball Detent .250" Dia.	
15	726-0153		Cable Tie		66	732-0863		Compression Spring	
16	751-0225		Gas Tank		67	719-0238		Shift Housing—R.H.	
17	—		Engine			719-0237		Shift Housing—L.H. (Not Shown)	
18	710-0380		Hex Bolt 5/16-18 x 1.75" Lg.*		68	721-0162		Gasket—Shift Housing	
19	14826		Belt Cover Support Ass'y.		69	04858		Shift Yoke Ass'y.—R.H.	
20	736-0114		Internal L-Wash. 1/2" I.D.			04859		Shift Yoke Ass'y.—L.H. (Not Shown)	
21	710-0121		Hex Bolt 1/2-20 x .75" Lg.		70	717-0383		Clutch Dog	
22	756-0296		Engine Pulley Ass'y.		71	717-0382		Clutch Dog Driver	
23	05080		Friction Wheel Ass'y.		72	04841		Control Brkt.	
24	750-0381		Spacer		74	15287		Shroud Belt Cover	
25	736-0119		L-Wash. 5/16" I.D.*		75	710-0314		Hex Bolt 7/16-20 x 1.00" Lg.	
26	710-0621		Hex Bolt 5/16-18 x .50" Lg.*		76	736-0171		L-Wash. 7/16" I.D.	
28	741-0155		Ball Bearing		77	736-0319		FI-Wash. .44 I.D. x 1.38" O.D.	
29	05034		Bearing Housing 1-3/8" O.D.		78	04836		Friction Disc	
30	736-0329		L-Wash. 1/4" I.D.*		79	710-0230		Hex Bolt 1/4-28 x .50" Lg.	
31	712-0138		Hex Nut 1/4-28 Thd.*		80	736-0329		L-Wash. 1/4" I.D.*	
32	712-0324		Hex Ins. L-Nut 1/4-20 Thd.		81	754-0268		"V"-Belt 5/8" x 51" Lg.	
33	04837		Variable Speed Brkt. Ass'y.		82	736-0169		L-Wash. 3/8" I.D.*	
34	710-0106		Hex Bolt 1/4-20 x 1.25" Lg.*		83	710-0344		Hex Bolt 3/8" x 1.50" Lg.*	
35	738-0380		Shld. Bolt 1/2" Dia. x .25" Lg.		84	756-0410		Input Pulley—Chain Case	N
36	714-0115		Cotter Pin 1/8" Dia. x 1.0" Lg.*		85	710-0195		Hex Bolt 1/4-28 x .62" Lg.	
37	736-0237		FI-Wash. .686" I.D. x 1.25" O.D.		86	710-0599		Hex Wash. Hd. Self-Tap Scr.	
38	14741 —452		Frame Ass'y.		87	736-0173		FI-Wash. 1/4" I.D.	
39	736-0119		L-Wash. 5/16" I.D.*		88	15290		Tank Mounting Brkt.	
40	712-0267		Hex Nut 5/16-18 Thd.*		89	710-0118		Hex Bolt 5/16-18 x .75" Lg.*	
41	712-0214		Hex Cent. L-Nut 3/8-24 Thd.		90	736-0119		L-Wash. 5/16" I.D.*	
42	723-0340		Weight		91	735-0149		Bushing—Gas Line	
43	736-0326		FI-Wash. .50" I.D. x 1.0" O.D.		92	751-0171		Shut-Off Valve	
44	712-0206		Hex Nut 1/2-13 Thd.*		93	723-0157		Clamp Gas Line	
45	736-0169		L-Wash. 3/8" I.D.*		94	751-0173		Gas Line 14 1/2" Lg.	
46	04860		Weight Mtg. Brkt.		95	15291		Brace	
47	710-0496		Hex Bolt 1/2-13 x 4.50" Lg.*		96	748-0296		Floating Disc	
48	710-0152		Hex Bolt 3/8-24 x 1.00" Lg.*		97	736-0352		Spring Bell-Wash.	
49	712-0130		Hex Ins. L-Nut 3/8-16 Thd.		98	712-0331		Hex Jam Nut 1.0-14	
50	736-0329		L-Wash. 1/4" I.D.*						
51	712-0138		Hex Cent. L-Nut 1/4-28 Thd.						
52	732-0384		Spring Idler Bracket						

# Model 412

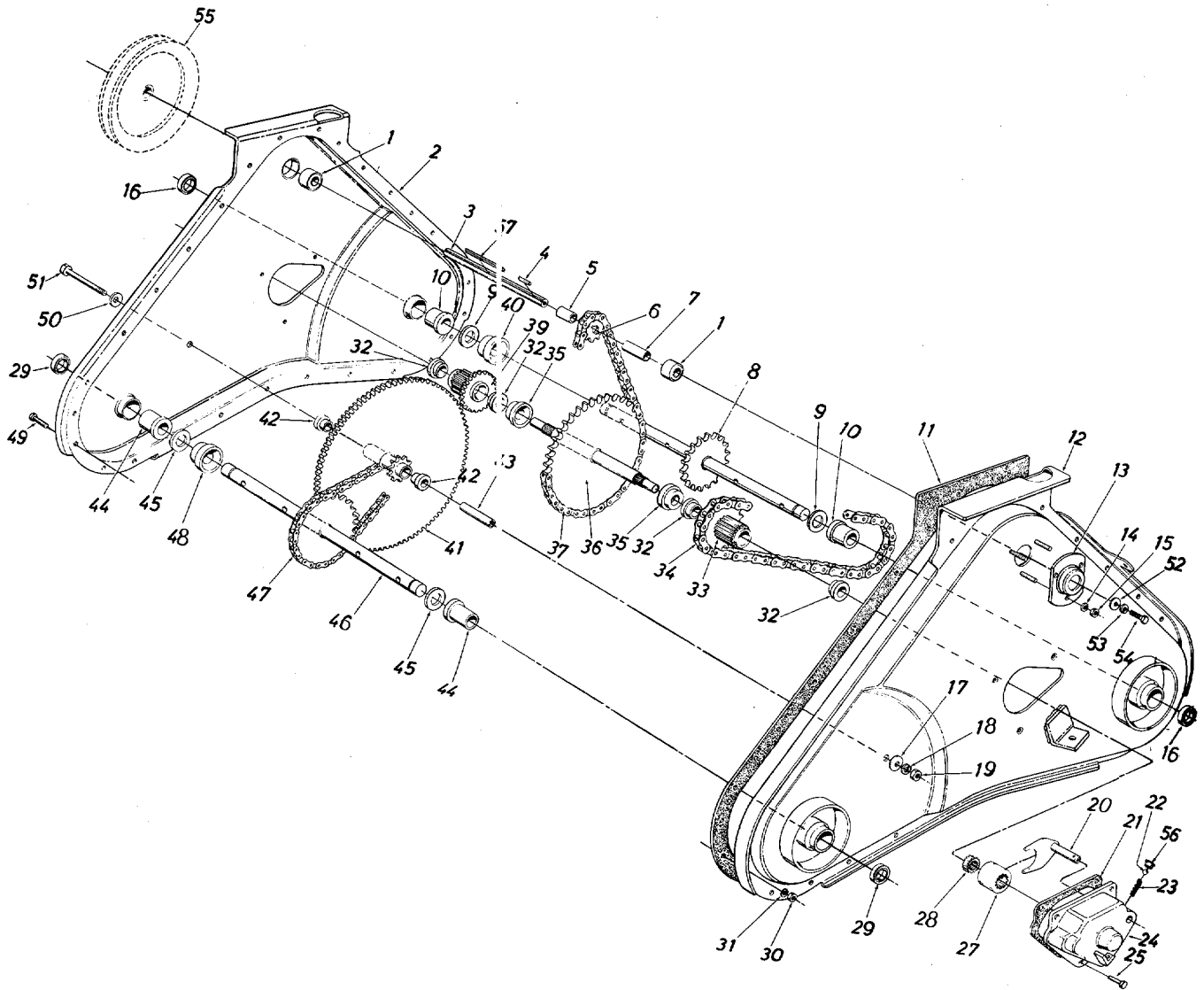

**NOTE: Use 28 ounces of Plastilube #0 grease. Order part no. 737-0133.**



# Model 412

## PARTS LIST FOR CHAIN CASE ASSEMBLY 15385

REF. NO.	PART NO.	COLOR CODE	DESCRIPTION	NEW PART	REF. NO.	PART NO.	COLOR CODE	DESCRIPTION	NEW PART
1	741-0155		Ball Bearing .62" I.D. x 1.38" O.D. x .44		29	721-0102		Seal 1.0" I.D. x 1.38" O.D.	
2	15384		Chain Case R.H. Half		30	712-0138		Hex Nut 1/4-28 Thd.*	
3	738-0379		Input Shaft .62" Dia.		31	736-0329		L-Wash. 1/4" I.D.*	
4	714-0122		Sq. Key 3/16" x 3/16" x .75" Lg.		32	741-0229		Flange Brg. 1.00" I.D.	
5	750-0379		Spacer .637" I.D. x .781" O.D. x .85" Lg.		33	14746		Sprocket Brg. Sleeve Ass'y.	
6	717-0210		Sprocket 9 Tooth x .62" Shaft		34	713-0313		#50 Chain—5/8" Pitch x 50 Links—Endless	
7	750-0378		Spacer .637" I.D. x .781" O.D. x 1.44" Lg.		35	750-0352		Stepped Spacer 1.0" I.D. x 1.75" O.D.	
8	14899		Tine Shaft Ass'y.		36	04823		Clutch Shaft Ass'y.	
9	736-0350		Fl-Wash. 1.28" I.D. x 1.62" O.D.		37	713-0250		#420 Chain 1/2" Pitch x 58 Links—Endless	
10	741-0381		Flange Bearing 1.25" I.D.		39	717-0512		Gear Bearing—Sleeve Ass'y.	187
11	721-0163		Gasket—Housing		40	750-0563		Spacer 1.25" I.D. x 2.0" O.D. x .68" Lg.	
12	15383		Chain Case L.H. Half		41	717-0511		Sprocket and Gear Ass'y.	
13	05034		Bearing Housing 1-3/8" O.D.		42	748-0184		Flange Brg. .628" I.D. x .753" O.D.	
14	736-0329		L-Wash. 1/4" I.D.*		43	750-0374		Hub Sleeve .38" I.D. x .625" O.D.	
15	712-0138		Hex Nut 1/4-28 Thd.		44	741-0189		Flange Brg. 1.00" I.D. x 1.188" O.D.	
16	721-0192		Seal 1.25" I.D.		45	736-0259		Fl-Wash. 1.0" I.D. x 1.62" O.D.	
17	736-0219		Belleville Wash.		46	04835		Axle Shaft Ass'y.	
18	736-0169		L-Wash. 3/8" I.D.*		47	713-0312		#420 Chain 1/2" Pitch 46 Links—Endless	
19	712-0214		Hex Cent. L-Nut 3/8-24 Thd.		48	750-0314		Spacer 1.0" I.D. x 2.0" O.D.	
20	04859		Shift Yoke Ass'y.—L.H.		49	710-0195		Hex Bolt 1/4-28 x .62" Lg.	
	04858		Shift Yoke Ass'y.—R.H. (Not Shown)		50	736-0219		Belleville Wash.	
21	721-0162		Gasket—Shift Housing		51	710-0629		Hex Bolt 3/8-24 x 2.75" Lg.*	
22	741-0862		Ball Detent .250 Dia.		52	736-0159		Fl-Wash. 5/16" I.D.	
23	732-0863		Compression Spring		53	736-0119		L-Wash. 5/16" I.D.*	
24	719-0237		Shift Housing—L.H.		54	710-0627		Hex L-Bolt 5/16-24 x .75" Lg.	
	719-0238		Shift Housing—R.H. (Not Shown)		55	756-0297	0410	Input Pulley—Chain Case	
25	710-0601		Hex Tap-Tite 5/16-18 x .75" Lg.		56	721-0165		Cap Plug .250" Dia.	
27	717-0383		Clutch Dog		57	714-0139		Sq. Key 3/16" x 2.0" Lg.	
28	717-0382		Clutch Dog Driver						

## Heavy Duty Rear Tine Garden Tiller Attachments Available for All-Season Use

- 31-0106 Depth Gauge Wheels (Pair)
- 31-0107 6-Tine Cultivator (Must be used with 31-0106 Depth Gauge Wheels)
- 31-0110 8" Furrow Opener
- 31-0111 15" Sweep Cultivator
- 31-0114 Wheel Weights (Pair)
- 31-0116 32" Leveling/Snow Blade (Must be used with 31-0121 Front Hitch Mount)
- 31-0121 Front Hitch Mount (For 32" Blade)

- 31-0144 "V"-Bar Cultivating Kit  
Kit Includes: "V"-Bar Frame, 4-Point Cultivating Tines, Hiller/Furrower, Depth Gauge Wheels (Pair).

To use these attachments on the tiller, it is necessary to:

1. Remove the tine shield hinge flap assembly.
2. Remove the depth bar assembly (except when using the 8" furrow opener and 15" sweep cultivator).
3. Remove the tines.

Note: Attachments are available through your local dealer or from the factory:  
Agri-Fab Inc., 303 W. Raymond Street, Sullivan, Illinois 61951 (217) 728-4334

# PARTS INFORMATION

## POWER EQUIPMENT PARTS AND SERVICE

Parts and service are available through the authorized service firms listed below. All orders should specify the model number of your unit, part numbers, description of parts and the quantity of each part required.

## BRIGGS AND STRATTON, TECUMSEH AND PEERLESS PARTS AND SERVICE

Briggs & Stratton, Tecumseh and Peerless parts and service should be handled by your nearest authorized engine service firm. Check the yellow pages of your telephone directory under the listing **Engines—Gasoline**, Briggs & Stratton or Tecumseh Lauson.

**NOTE:** If any parts are found to be missing or defective upon assembly of this unit, write to advise the factory so that immediate replacement can be made.

<b>ALABAMA</b> Auto Electric & Carburetor Co. . . . .	<b>BIRMINGHAM</b> 2625 4th Ave. S. . . . . 35233	<b>NORTH CAROLINA</b> Smith Hardware Co. . . . .	<b>GOLDSBORO</b> 515 N. George St. . . . . 27530
<b>ARKANSAS</b> Sutton's Lawn Mower Shop . . . . .	<b>NORTH LITTLE ROCK</b> 5301 Roundtop Drive Box 368, Rt. 4 . . . . . 72117	Dixie Sales Company . . . . .	<b>GREENSBORO</b> 335 N. Green . . . . . 27402
<b>CALIFORNIA</b> Billious . . . . .	<b>PORTERVILLE</b> 75 North D Street . . . . . 93257	<b>OHIO</b> Stebes Mid-State Mower Supply . . . . .	<b>CARROLL</b> Box 366, 71 High St. . . . . 43112
<b>COLORADO</b> Spitzer Industrial Products Co. . . . .	<b>DENVER</b> 6601 N. Washington St. . . . . 80229	Bleckrie, Inc. . . . .	<b>CLEVELAND</b> 7900 Lorain Ave. . . . . 44102
<b>FLORIDA</b> Radco Distributors . . . . .	<b>JACKSONVILLE</b> 4909 Victor St. Box 5459 . . . . . 32207	National Central . . . . .	<b>WADSWORTH</b> 687 Seville Rd. . . . . 44281
Small Eng. Dist. . . . .	<b>OPA LOCKA</b> 2351 N.W. 147th St. . . . . 33054	Burton Supply Co. . . . .	<b>YOUNGSTOWN</b> 1301 Logan Ave. Box 929 . . . . . 44501
<b>GEORGIA</b> East Point Cycle & Key . . . . .	<b>EAST POINT</b> 2834 Church St. . . . . 30344	<b>OKLAHOMA</b> Victory Motors, Inc. . . . .	<b>MUSKOGEE</b> 605 S. Cherokee . . . . . 74401
<b>ILLINOIS</b> Keen Edge Co. . . . .	<b>LYONS</b> 8615 Ogden Ave. . . . . 60534	<b>OREGON</b> Kenton Supply Co. . . . .	<b>PORTLAND</b> 8216 N. Denver Ave. . . . . 97217
<b>INDIANA</b> Parts & Sales Inc. . . . .	<b>ELKHART</b> 2101 Industrial Pkwy. . . . . 46516	<b>PENNSYLVANIA</b> EECO Inc. . . . .	<b>HARRISBURG</b> 4021 N. 6th St. . . . . 17110
<b>IOWA</b> Power Lawn & Garden Equip. . . . .	<b>DUBUQUE</b> 2551 J.F. Kennedy . . . . . 52001	Thompson Rubber Co. . . . .	<b>PHILADELPHIA</b> 5222-24 N. Fifth St. . . . . 19120
<b>LOUISIANA</b> Suhren Engine Co. . . . .	<b>NEW ORLEANS</b> 8330 Earhart Blvd. . . . . 70118	Bluemont Co. . . . .	<b>PITTSBURGH</b> 11125 Frankstown Rd. . . . . 15235
<b>MARYLAND</b> Center Supply Co. . . . .	<b>TAKOMA PARK</b> 6867 New Hampshire Ave. . . . . 20912	Frank Roberts & Sons . . . . .	<b>PUNXSUTAWNEY</b> R.D. 2 . . . . . 15767
<b>MASSACHUSETTS</b> Morton B. Collins Co. . . . .	<b>SPRINGFIELD</b> 300 Birnie Ave. . . . . 01107	Scranton Auto Ignition Co. . . . .	<b>SCRANTON</b> 1133-35 Wyoming Ave. . . . . 18509
<b>MICHIGAN</b> Lorenz Service Co. . . . .	<b>LANSING</b> 2500 S. Pennsylvania . . . . . 48910	<b>TENNESSEE</b> Master Repair Service . . . . .	<b>KNOXVILLE</b> 2000 Western Ave. . . . . 37921
Power Equipment Dist. . . . .	<b>MOUNT CLEMENS</b> 340 Hubbard . . . . . 48043	American Sales & Service, Inc. . . . .	<b>MEMPHIS</b> 3035-43 Bellbrook . . . . . 38116
<b>MINNESOTA</b> Hance Distributing Inc. . . . .	<b>HOPKINS</b> 420 Excelsior Ave. W. . . . . 55343	<b>TEXAS</b> Marr Brothers, Inc. . . . .	<b>DALLAS</b> 423 E. Jefferson . . . . . 75203
<b>MISSISSIPPI</b> Biloxi Sales & Service, Inc. . . . .	<b>BILOXI</b> 506 Caillavet St. . . . . 39533	Woodson Sales Corp. . . . .	<b>FORT WORTH</b> 1702 N. Sylvania . . . . . 76111
<b>MISSOURI</b> Automotive Equip. Service . . . . .	<b>KANSAS CITY</b> 3117 Holmes St. . . . . 64109	Bullard Supply Co. . . . .	<b>HOUSTON</b> 2409 Commerce St. . . . . 77003
Ross-Frazier Supply Co. . . . .	<b>ST. JOSEPH</b> 8th and Monterey . . . . . 64503	Engine House Inc. . . . .	<b>SAN ANTONIO</b> 8610 Botts Lane P.O. Box 17867 . . . . . 78217
Henzler, Inc. . . . .	<b>ST. LOUIS</b> 2015 Lemay Ferry Rd. . . . . 63125	<b>UTAH</b> A-1 Engine & Mower Co. . . . .	<b>SALT LAKE CITY</b> 439 E. 900 So. . . . . 84111
<b>NEW JERSEY</b> Lawnmower Parts Inc. . . . .	<b>BELLMAWR</b> 717 Creek Rd. . . . . 08030	<b>VIRGINIA</b> RBI Corp. . . . .	<b>ASHLAND</b> 101 Cedar Ridge Dr. . . . . 23005
<b>NEW MEXICO</b> Spitzer Eng. & Parts . . . . .	<b>ALBUQUERQUE</b> 1023 Third Ave. N.W. . . . . 87103	<b>WASHINGTON</b> Bailey's Inc. . . . .	<b>SEATTLE</b> 1414 14th Ave. . . . . 98122
<b>NEW YORK</b> Gamble Dist., Inc. . . . .	<b>CARTHAGE</b> West End Ave. . . . . 13619	<b>WISCONSIN</b> Automotive Supply Co. . . . .	<b>APPLETON</b> 123 S. Linwood Ave. P.O. Box 798 . . . . . 54911
		Horst Dist. . . . .	<b>CHILTON</b> 444 N. Madison . . . . . 53014

## WARRANTY PARTS AND SERVICE POLICY

(0783)

The purpose of warranty is to protect the customer from defects in workmanship and materials, defects which are NOT detected at the time of manufacture. It does not provide for the unlimited and unrestricted replacement of parts. Use and maintenance are the responsibility of the customer. The manufacturer cannot assume responsibility for conditions over which it has no control. Simply put, if it's the manufacturer's fault, it's the manufacturer's responsibility; if it's the customer's fault, it's the customer's responsibility.

### CLAIMS AGAINST THE MANUFACTURER'S WARRANTY INCLUDES:

1. Replacement of Missing Parts on new equipment.
2. Replacement of Defective Parts within the warranty period.
3. Repair of Defects within the warranty period.

All claims MUST be substantiated with the following information:

1. Model Number of unit involved.
2. Date unit was purchased or first put into service.
3. Date of failure.
4. Nature of failure.

MTD PRODUCTS INC • P.O. BOX 36900 • CLEVELAND, OHIO 44136

## Free Manuals Download Website

<http://myh66.com>

<http://usermanuals.us>

<http://www.somanuals.com>

<http://www.4manuals.cc>

<http://www.manual-lib.com>

<http://www.404manual.com>

<http://www.luxmanual.com>

<http://aubethermostatmanual.com>

Golf course search by state

<http://golfingnear.com>

Email search by domain

<http://emailbydomain.com>

Auto manuals search

<http://auto.somanuals.com>

TV manuals search

<http://tv.somanuals.com>