



User Guide for 4xN 10/100/1000 Span iMatrix Switch™

Model ISW-CU3-S4x16



Doc. PUB ISWCU3S4U Rev. 1, 07/06

PLEASE READ THESE LEGAL NOTICES CAREFULLY.

By using a Net Optics Switch you agree to the terms and conditions of usage set forth by Net Optics, Inc.

No licenses, express or implied, are granted with respect to any of the technology described in this manual. Net Optics retains all intellectual property rights associated with the technology described in this manual. This manual is intended to assist with installing Net Optics products into your network.

Trademarks and Copyrights

© 2006 by Net Optics, Inc. Net Optics® is a registered trademark of Net Optics, Inc. SpyderSwitch is a trademark of Net Optics, Inc. Additional company and product names may be trademarks or registered trademarks of the individual companies and are respectfully acknowledged.

Additional Information

Net Optics, Inc. reserves the right to make changes in specifications and other information contained in this document without prior notice. Every effort has been made to ensure that the information in this document is accurate.

Contents

Chapter 1

Introduction

Overview	1
Key Features	2
Unpacking and Inspection	3
About this Guide	3
Product Diagrams	4
LED Indicators	4

Chapter 2

Installing the iMatrix Switch

Overview	5
Installation Planning	5
Configuring the iMatrix Switch	6
Using the Command Line Interface (CLI)	6
Connecting to Switch Span Ports	10
Connecting to the Monitoring Device	10
Connecting the Remote Interface Port	11
Daisy Chaining iMatrix Switches	12

Chapter 3

Using iMatrix Switch Web Manager

Overview	15
Accessing Web Manager	15
Viewing Switch Status	16
Switch Control	17

Configuring the iMatrix Switch	17
Message Board	18

Chapter 4 Using System Manager

Overview	19
Installing System Manager	19
Exploring System Manager	23
Creating a Group	24
Deleting a Group	25
Adding iMatrix Switches	25
Deleting an iMatrix Switch	28
Configuring an iMatrix Switch	28
Viewing iMatrix Switch Information	29
Modifying an iMatrix Switch	31
Controlling Switch Connections	32
Entering Port Names and Notes	34

Appendix A Specifications and Models

Specifications	35
--------------------------	----

Appendix B Command Line Interface

Chapter 1

Introduction

Overview

Net Optics 4xN 10/100/1000 Span Port iMatrix Switches enhance LAN visibility by providing access across multiple 10/100/1000 Span ports for up to four analyzers or security devices. The physical layer connections through the iMatrix Switch eliminate the need to reconnect and reconfigure analyzers for each new monitoring task. This flexibility instantly improves ease of use and return on investment.

The 4xN 10/100/1000 Span iMatrix Switch supports simultaneous passive monitoring of any four Span ports connected to the iMatrix Switch, each with a separate distributed analyzer.

Scalable Deployment

Double or triple Span port coverage by daisy chaining iMatrix Switches. The Daisy Chain option allows a single monitoring device or host PC to manage up to three iMatrix Switches and 48 Span ports.

Remote Control

The iMatrix Switch Web Manager and System Manager allows you to remotely set IP parameters and change which link is monitored with a click of your mouse. The Web Manager is browser-based interface accessible from any PC with a browser and access to the iMatrix Switch's IP address. System Manager is an SNMP-based management interface.

Reliability

For extra uptime protection, Net Optics iMatrix Switches offer redundant power connections. Should the primary power source fail, the iMatrix Switch automatically switches to the backup power source. Power LEDs on the front of the iMatrix Switch indicate the current power source.

Key Features

Passive, Secure Technology

- Provides complete cross-link visibility at 1000 Mbps without data stream interference or introducing a point of failure
- Daisy Chain iMatrix Switches for doubled or tripled coverage
- Redundant power ensures monitoring uptime
- Fully RoHS compliant

Ease of Use

- Remote management software provides control over which links are being monitored
- LED indicators on the iMatrix Switch allow for quick status checks
- Front-mounted network connectors for easy installation and operation
- Flexible design with removable feet allows for either rack-mount or stand alone use
- Tested and compatible with all major manufacturers' monitoring devices, including protocol analyzers, probes, and intrusion detection/prevention systems

Support

- Net Optics offers free technical support throughout the lifetime of your purchase. Our technical support team is available from 8 am to 5 pm Pacific Time, Monday through Friday at +1 (408) 737-7777 and via email at ts-support@netoptics.com. FAQs are also available on Net Optics website at www.netoptics.com.

Unpacking and Inspection

Carefully unpack the 10/100/1000 Span Port iMatrix Switch and check for damaged or missing parts. The iMatrix Switch ships with the following:

- 10/100/1000 Span Port iMatrix Switch
- Two power cords
- One RS232 cable
- Nine straight-through CAT5e cables
- Two Mini-DIN cables
- 10/100/1000 Span Port iMatrix Switch Quick Install Guide
- One software CD
- Pads for surface mounting
- Brackets and fasteners for rack mounting

You may have also ordered an extended warranty. Carefully check the packing slip against parts received. If any part is missing or damaged, contact Net Optics' Customer Service immediately.

About this Guide

This Guide provides you all the information you need to configure and operate the 10/100/1000 Span Port iMatrix Switch. Please read the entire Guide before attempting to install or operate the iMatrix Switch.

This guide covers the following models:

Part Number	Description
ISW-CU3-S4X16	4x16 10/100/1000 Span Port iMatrix Switch

Product Diagrams

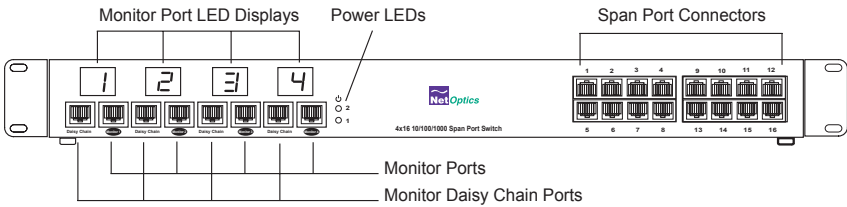

Figure 1: Front Panel ISW-CU3-S4X16



Figure 2: Rear Panel

LED Indicators

Monitor Port LEDs: Each Monitor Port has a 2-character LED that shows the number of the Span port currently connected to the monitor port.

Link/Activity Indicator: If a good link is established, the LED illuminates a steady green. If there is current activity on this link, the LED flashes.

10/100/1000 Indicator: If the Port is set to 10 Mbps, the LED will illuminate orange. If the Port is set to 100 Mbps, the LED will illuminate yellow. If the Port is set to 1000 Mbps, the LED will illuminate green.

PWR 1/ PWR 2: Main and Redundant Power. If the Tap is deployed with both power supplies, both LEDs illuminate when the Tap is connected to power. An off power LED indicates that the corresponding power supply is not functioning or not connected.

Chapter 2

Installing the iMatrix Switch

Overview

The procedure for installing the iMatrix Switch follows these basic steps:

- Plan the installation
- Configure IP parameters
- Mount the iMatrix Switch
- Connect the Management Port
- Connect to the network
- Connect to the monitoring devices
- Apply power to the iMatrix Switch
- Check the installation

Installation Planning

There are two methods for connecting your iMatrix Switch:

Single iMatrix Switch Mode

- A single monitoring device to controls the Monitor Ports of a single iMatrix Switch from one COM Port.

Daisy Chaining Mode

- Allows up to three iMatrix Switches to be controlled from one monitoring device or host PC.

Remote Access

The remote access features require that you assign an IP address to the iMatrix Switch. If you are daisy chaining iMatrix Switches, you only need an IP address for the Controller iMatrix Switch. You may also wish to assign a netmask.

If you plan to remotely control the iMatrix Switch over WAN, you can also set a gateway and IP address where you plan to use the SNMP management tool.

Configuring the iMatrix Switch

The iMatrix Switch is configured with default values that allow you to install the iMatrix Switch and then modify parameters from Web Manager or SNMP Manager.

The defaults values are:

IP Address: 10.60.0.123
Netmask: 255.255.0.0
Monitor Ports 1-4: Gigabit
CLI username: netoptics
CLI password: netoptics

You can set all parameters, check status, and control Monitor Port connections from the Command Line Interface. You can change most settings later from one of the remote interfaces.

Using the Command Line Interface (CLI)

All configuration and control options are accessible from the iMatrix Switch's Command Line Interface. You must set a new username and password, IP address for the iMatrix Switch, and the port speeds. Other parameters are optional and dependent on your installation.

For security reasons, some parameters can only be set with the CLI.

Use these commands to:

- Set CLI username and password
- Enable or disable the remote interfaces
- Turn character echo to the terminal emulation software on or off

If you wish to disable the Management Port and remote interfaces, you can do so from the CLI using the Display command.

To access the iMatrix Switch CLI:

1. Make sure power to the iMatrix Switch is off.
2. Connect a PC with terminal emulation software, such as HyperTerminal, to the iMatrix Switch Control Port 2 using the RS232 DB-9 cable supplied with the iMatrix Switch.

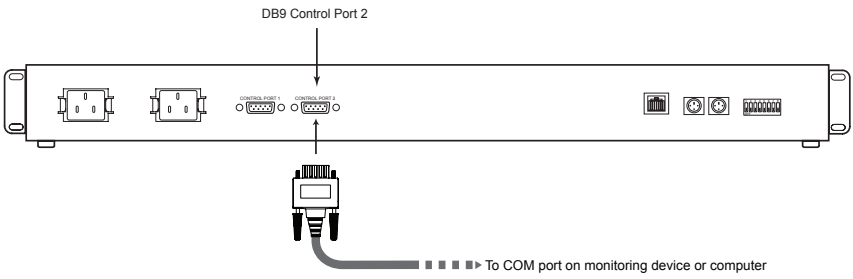

Figure 9: Connecting to the CLI

- 3. Launch your terminal emulation software and set the communication parameters to:

 - 19200 baud
 - 8 data bits
 - No parity
 - 1 stop bit
 - No flow control

- 3. Connect power to the iMatrix Switch. The CLI banner and login prompt appears.

```
*****  
* Net Optics Command Line Interface *  
*****  
Login:  
Password:
```

Figure 9: Login and Password Prompts

- 4. Type **netoptics** and press **Enter**.
- 5. At the password prompt, type **netoptics** and press **Enter**. The **NetOptics:** prompt appear.

To change the username and password:

- 1. Change the username by typing the following command:

set username <username>
where *<username>* is your new username.

2. Change the password by typing the following command:

```
set password <password>
```

where <password> is your new password.

3. Record the username and password in a secure location.

To set the iMatrix Switch IP address:

1. Type **set ip <ip address>** where <ip address> is the IP address you are assigning to the iMatrix Switch and press **Enter**.

For example, typing **set ip 10.60.0.100** sets the iMatrix Switch IP address to 10.60.0.100.

To display current settings:

1. Type **show set** and press **Enter**. The CLI displays the current settings similar to the example in Figure 10.

```
show set
  IP Address:          10.60.0.123
  Netmask:            255.255.0.0
  Manager:            10.10.1.40
  Gateway:            10.60.0.118
  HW Version:         REV 1.00
  SW Version:         REV 1.00
  Port 1 Parameters:  Gigabit
  Port 2 Parameters:  Gigabit
  Port 3 Parameters:  Gigabit
  Port 4 Parameters:  Gigabit
```

Figure 10: Show Set Command Example

To disable the remote interfaces:

1. Type **show display** and press **Enter** to view the current setting. The default value is Display: ON.
2. Type **display** and press **Enter**. Access to the iMatrix Switch from remote interfaces will be blocked.
3. To restore the display and remote interfaces, type **display** and press **Enter**.

To use the Help command:

1. Type **Help** and press **Enter** at the NetOptics prompt. The list of help topics is displayed.

```

NetOptics: help
*****
* Net Optics Command Line Interface *
*****
Usage: "help"
<variable>:
    set      - Configure various options.
    reset    - Reset options.
    switch   - Switch control commands.
    show     - show current configuration and
               status.
    echo     - Turn on or off echoing of
               characters.
    display- Toggle to enable/disable network
               - accessibility.
    help     - This help screen.
    
```

Figure 11: iMatrix Switch CLI Help Menu

5. To view the syntax for changing the iMatrix Switch’s configuration parameters, type **help set** and press **Enter**.
6. To view the syntax for other commands, type **help** followed by the command. For more information on CLI commands, see Appendix B.

Connecting to Switch Span Ports

1. Connect Span Port 1 of the iMatrix Switch to the appropriate Span port on your switch using CAT5e straight-through cables.
2. Repeat Step 1 for each additional network switch Span port you wish to monitor.

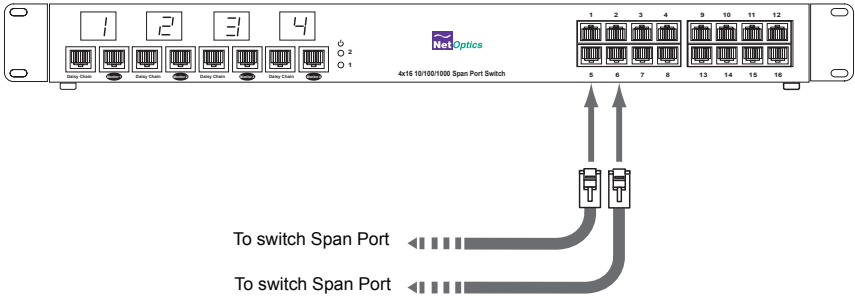

Figure 4: Connecting Span Ports

Connecting to the Monitoring Device

You need to connect the iMatrix Switch to the input ports (NICs) of the monitoring device and connect Control Port 2 to a COM port on the monitoring device or computer where you access the CLI.

1. Verify that the DIP switch located on the rear of the unit is set as shown in Figure 5 below.

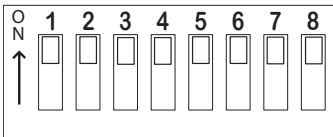

Figure 5: DIP Switch Settings for Single iMatrix Switch (Controller)

Note:

DIP switches 3 through 8 must remain in the ON position.

2. Connect a CAT5e cable to the iMatrix Switch Monitor Port 1 and the input port of the monitoring device.
3. Repeat Step 3 above to connect Monitor Ports 2 through 4 of the iMatrix Switch to a monitoring device.

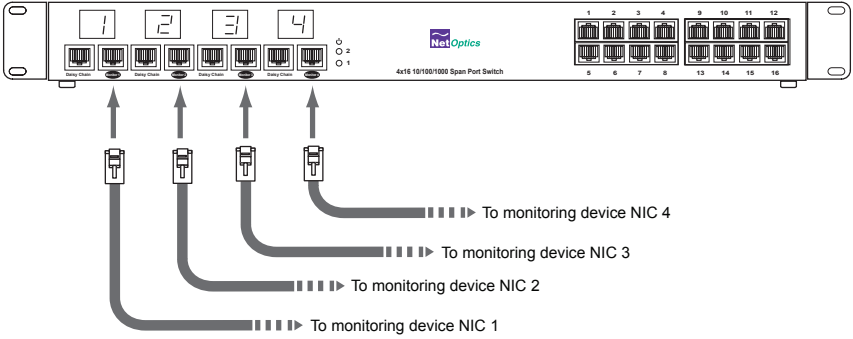

Figure 7: Connecting Monitor Ports

4. Supply power to the iMatrix Switch using the power cords included with the unit. Verify that the Power LEDs illuminate.

Connecting the Remote Interface Port

In order to access the remote interfaces, you must connect the Remote Interface Port to a network switch or hub as shown in Figure 8.

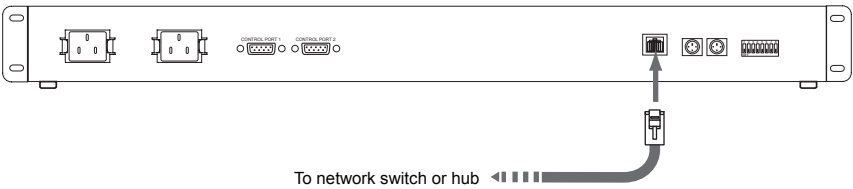

Figure 8: Connecting the Remote Interface Port

Note:

Access to the remote interface is controller by the Display command in the CLI. To have access to the remote interfaces, make sure the Display option is set to ON.

Daisy Chaining iMatrix Switches

You have the option of connecting as many as three switches together for control by a single monitoring device or computer. It does not matter if you are connecting the monitoring ports to one device or separate devices.

In a daisy chain configuration, one iMatrix Switch serves as the Controller to one or two Client iMatrix Switches. The Controller/Client relationship is set with the DIP switches on the rear of the iMatrix Switch. iMatrix Switches are set to function as a Controller by default. Network traffic is passed from the Clients to the Controller and control is sent through the Controller to the Clients.

The basic steps to daisy chaining iMatrix Switches are:

1. Connect the Controller iMatrix Switch as described in the previous sections.
2. Connect the Controller and Client Control Ports
3. Connect the Controller and Client Monitor Ports
4. Connect the additional Span Ports

To daisy chain iMatrix Switches:

1. Configure and install the Controller iMatrix Switch as described in the preceding sections.
2. Choose the iMatrix Switch you will use as Client 1 and set the DIP switch positions (located on rear of unit) as shown in Figure 9. If you are installing a third switch, set the DIP switch as shown in Figure 9 for Client 2.
3. Connect CAT5e cables between the Daisy Chain Ports of iMatrix Switch 1 and the Monitor Ports of iMatrix Switch 2. If you are connecting a third iMatrix Switch, connect CAT5e cables between the Daisy Chain Ports of iMatrix Switch 2 and the Monitor Ports of iMatrix Switch 3 (see Figure 9).

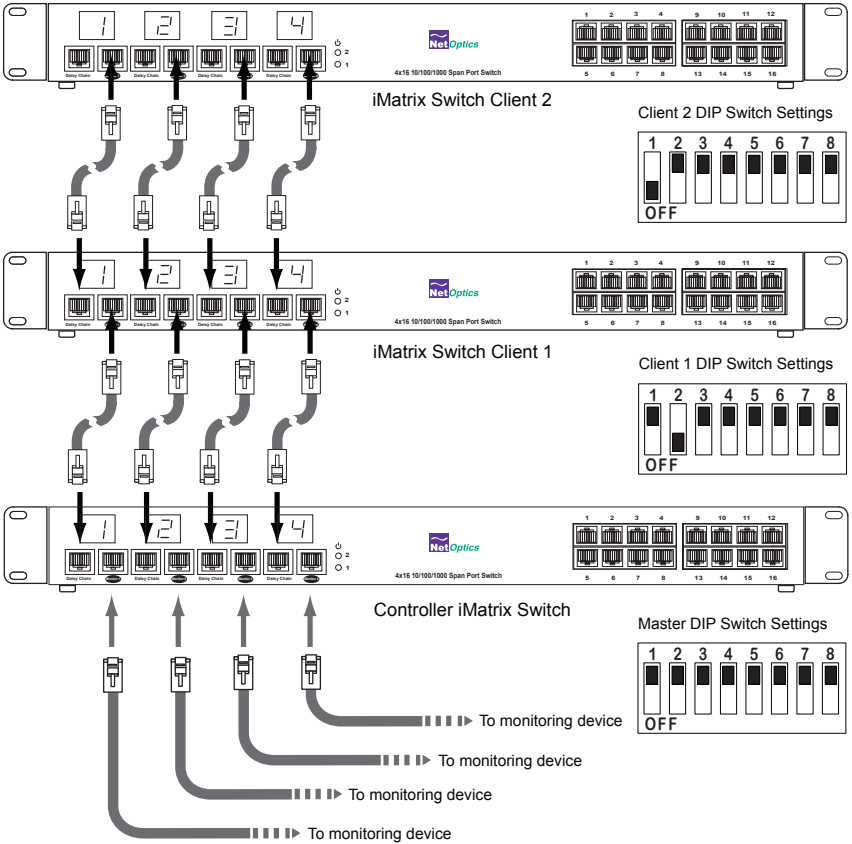

Figure 9: Connecting Daisy Chained Monitor Ports

4. Connect the supplied Mini-DIN cable between Daisy Chain Port OUT of the Controller iMatrix Switch and Daisy Chain Port IN of iMatrix Switch Client 1.

If you are installing a third iMatrix, connect the supplied Mini-DIN cable between Daisy Chain Port OUT of iMatrix Switch 2 and Daisy Chain Port IN of iMatrix Switch 3 (see Figure 10).

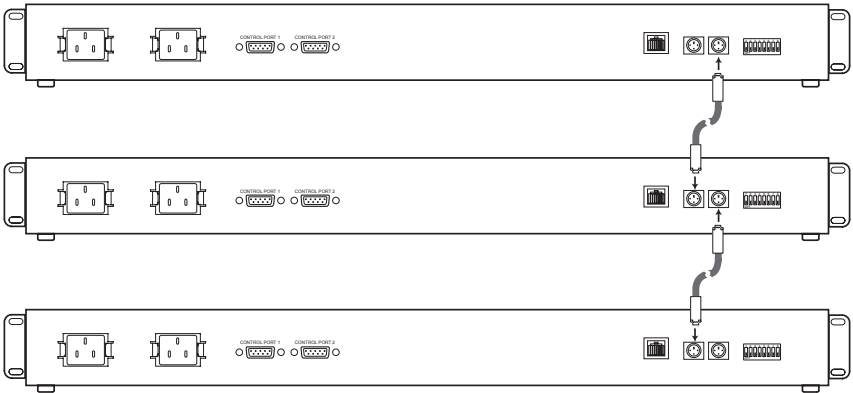

Figure 10: Connecting the Daisy Chain Control Ports

5. Supply power to the iMatrix Switch using the power cords included with the unit. Verify that the Power LEDs illuminate.

Chapter 3

Using iMatrix Switch Web Manager

Overview

This chapter describes how to monitor and control individual iMatrix Switches using Web Manager. The following topics are covered:

- Accessing Web Manager
- Viewing iMatrix Switch Status
- Controlling iMatrix Switch Connections
- Configuring the iMatrix Switch

Web Manager is the browser-based interface that allows you to change configuration settings, view status, and control which Span ports are connected to the monitoring devices.

Note:

To access Web Manager, the Display option in the CLI must be set to ON. For more information, see Using the Command Line Interface on page 4.

Accessing Web Manager

Web Manager is a browser-based interface that provides access to any iMatrix Switch with an IP address accessible from the computer running Web Manager. Web Manager supports all common browsers.

To access Web Manager:

1. Open an Internet browser on your computer.
2. Enter the iMatrix Switch's IP address in the URL box and press **Enter**. The default IP address is 10.60.0.123. The Web Manager page appears as shown in Figure 11.

Matrix Switch Web Manager

Switch Status

Total Switches <input style="width: 50px;" type="text" value="1"/>	Total Data Ports <input style="width: 50px;" type="text" value="16"/>
Switch 1 Model <input style="width: 150px;" type="text" value="Gigabit 4x16 Span Switch"/>	Switch 2 Model <input style="width: 150px;" type="text" value="unknown"/>
Switch 3 Model <input style="width: 150px;" type="text" value="unknown"/>	
Switch Hardware Version <input style="width: 50px;" type="text" value="REV 1.00"/>	Switch Software Version <input style="width: 50px;" type="text" value="REV 1.00"/>

Switch Control

Monitor 1 Control <input style="width: 50px;" type="text" value="0"/>	Monitor 2 Control <input style="width: 50px;" type="text" value="0"/>
Monitor 3 Control <input style="width: 50px;" type="text" value="0"/>	Monitor 4 Control <input style="width: 50px;" type="text" value="0"/>
Reset All Switches <input style="width: 50px;" type="button" value="No"/>	

Configuration

IP Address <input style="width: 100px;" type="text" value="10.60.0.123"/>	Manager IP Address <input style="width: 100px;" type="text" value="10.10.1.40"/>
Net Mask <input style="width: 100px;" type="text" value="255.0.0.0"/>	Gateway IP Address <input style="width: 100px;" type="text" value="10.60.0.118"/>
Monitor 1 Parameters <input style="width: 50px;" type="button" value="Gigabit"/>	Monitor 2 Parameters <input style="width: 50px;" type="button" value="Gigabit"/>
Monitor 3 Parameters <input style="width: 50px;" type="button" value="Gigabit"/>	Monitor 4 Parameters <input style="width: 50px;" type="button" value="Gigabit"/>

Message Board

Welcome to Net Optics iMatrix Switch

Figure 11: Web Manager Page

To save any changes to the iMatrix Switch, you must click **Submit Changes**. To update the display, click your browser's refresh button.

Viewing Switch Status

You can view iMatrix Switch information from the Switch Status section of Web Manager. The following table explains the status fields.

Field Name	Value	Description
Total Switches	1 - 4	Indicates the number of switches configured
Total Data Port	1 - 16	Display the total number of ports available for this switch model or the total number of Span ports available in a daisy-chain configuration.
Switch 1 Model	-	Displays the model of the switch
Switch 2 Model	-	Displays the model of the switch
Switch 3 Model	-	Displays the model of the switch

Field Name	Value	Description
Switch Hardware Version		Displays the hardware version of the switch
Switch Software Version		Displays the software version of the switch

Switch Control

Web Manager lets you set which data port is connected to the Monitor Port. To change the network link you are monitoring, enter the number of the data port for the link and click **Submit Changes**.

To disconnect the Monitor Port from all data ports, select **Yes** from the Reset All Switches drop-down menu and click **Submit Changes**.

Configuring the iMatrix Switch

Web Manager allows you to set the IP parameters for the switch. To change a setting, enter the IP address in the text box and click **Submit Changes**. The following table explains each available option.

Field Name	Function/Value	Description
IP Address	0.0.0.0	IP address of the iMatrix Switch. The default IP address is 10.60.0.123. You can change the IP address by typing a new IP address in the text box.
Net Mask	0.0.0.0	Displays current Net Mask of the iMatrix Switch. The default Net Mask is 255.255.0.0. You can change the Net Mask by typing a new Net Mask in the text box.
Manager IP Address	0.0.0.0	IP address of the computer running iMatrix System Manager over a WAN. You can change the IP address by typing a new IP address in the text box.
Gateway IP Address	0.0.0.0	Displays the IP address of the current WAN Gateway. You can change the Gateway by typing a new IP address in the text box.

Message Board

You can post a message about the iMatrix Switch in the Message Board text box. Anyone who open Web Manager for this iMatrix Switch will see your message.

To enter a message, simple click in the text box and type your message.

Chapter 4

Using System Manager

Overview

This chapter describes how to install and use Net Optics' System Manager, which allows you to change settings, view status, and retrieve data remotely from multiple Net Optics iMatrix Switch devices. The following topics are covered:

- Installing System Manager
- Exploring System Manager
- Creating a Group
- Adding and Deleting iMatrix Switches
- Using the Status Tab
- Using the Configuration Tab

Installing System Manager

The installation executable file for System Manager can be found on the CD included with the iMatrix Switch.

To install System Manger:

1. Locate **Setup.exe** on the CD and double click it. The License Agreement dialog box appears as shown in Figure 12.

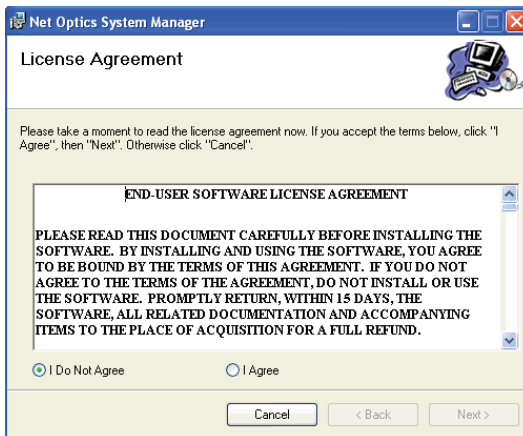

Figure 12: Net Optics System Manager License Agreement

3. After reading the agreement, select **I Agree** and click **Next** to install System Manager. The Welcome dialog box appears as shown in Figure 13.

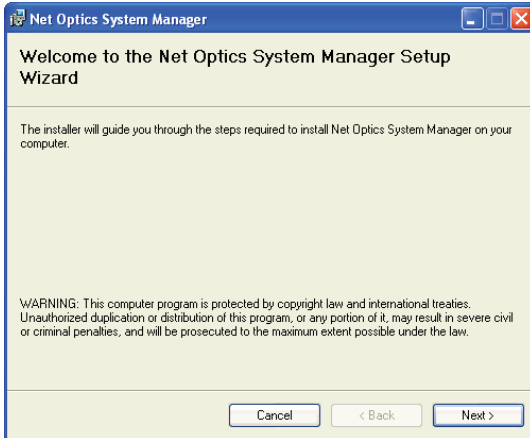

Figure 13: Welcome Dialog Box

2. Click **Next**. The Select Installation Folder dialog box shown in Figure 14 appears.

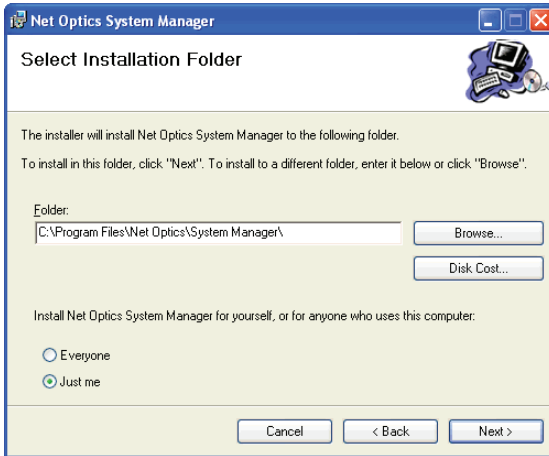

Figure 14: Select Installation Folder

3. To install in the default folder, make no changes to the path in the **Folder:** text box. To install in a different location, either type the path in the **Folder:** text box or click **Browse** to find another location.

To check the space available for System Manager on the selected drive, click **Disk Cost**.

4. To limit access to System Manager to the current user of the PC, select **Just Me**. To allow access to any user logged into the PC, select **Everyone**.
5. Click **Next**. The Confirm Installation dialog box shown in Figure 15 appears. To continue the installation, click **Next**. The Progress dialog box appears as shown in Figure 16.

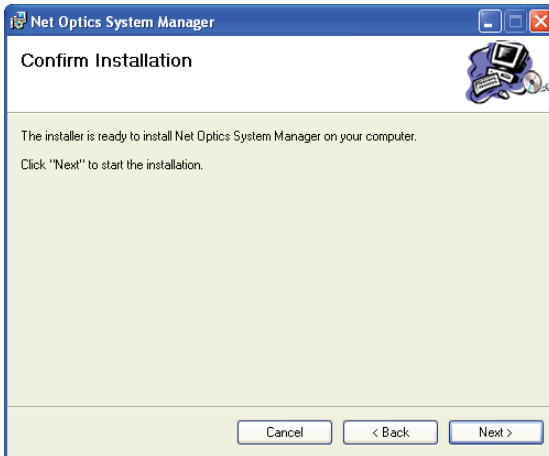

Figure 15: Confirm Installation

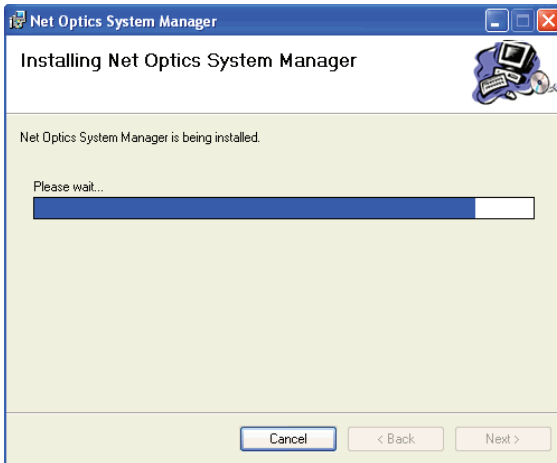

Figure 16: Installation Progress

6. If you want to stop the installation, click **Cancel**. When the installation is complete, the Installation Complete dialog box appears as shown in Figure 17.

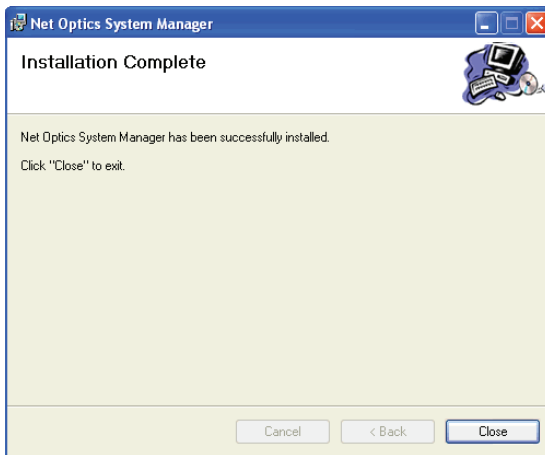

Figure 17: Installation Complete

7. Click **Close**. System Manager is now installed on your computer and there is a Net Optics shortcut icon on your desktop.

Exploring System Manager

This section explains the features and functions of System Manager. With System Manager you can:

- Create iMatrix Switch groups
- Add and delete iMatrix Switches from the system
- Remotely configure iMatrix Switches
- View iMatrix Switch status information
- Connect Monitor Ports to Span Ports
- Add text information about the iMatrix Switch

NOTE

To access the iMatrix Switch with System Manager, the Display option in the CLI must be set to ON. For more information, see Using the Command Line Interface on page 4.

To access System Manager:

1. Double click the System Manager icon on your PC desktop. The initial window, shown in Figure 18, will not show any iMatrix Switches.

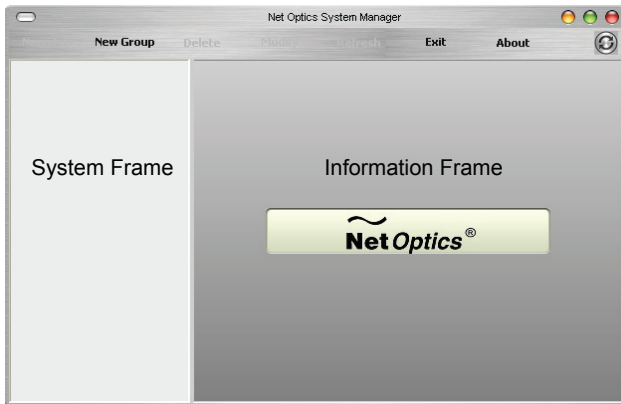

Figure 18: Initial window

The **System Frame** displays iMatrix Switches and iMatrix Switch Groups as you add them to the system. The **Information Frame** displays Status, Configuration and Control information for individual iMatrix Switches.

Tip!

To use pop-up menu shortcuts, click your right mouse button in the System Frame.

Using the Toolbar

Figure 19 shows the System Manager toolbar.

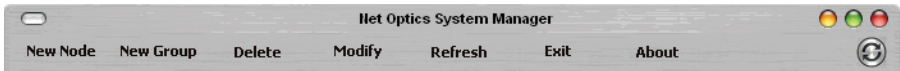

Figure 19: Toolbar

The table below describes the headings found on the toolbar.

Tool	Description
New Node	Add iMatrix Switches to a group
New Group	Create an iMatrix Switch group
Delete	Delete iMatrix Switch from System Manager
Modify	Change the iMatrix Switch name, IP address, model, and add notes
Refresh	Refresh the data displayed in the Information Frame.
Exit	Close Net Optics System Manager
About	View information about System Manager

Creating a Group

You can organize iMatrix Switch devices into groups for quick access. You must create a Group before you can add iMatrix Switches to your system.

To create an iMatrix Switch group:

1. Click **New Group** in the toolbar as shown in Figure 20. A new group bar appears in the System Frame as shown in Figure 21.

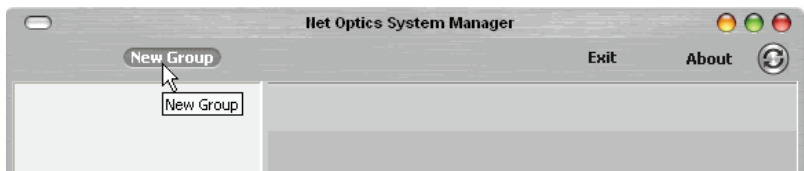

Figure 20: New Group

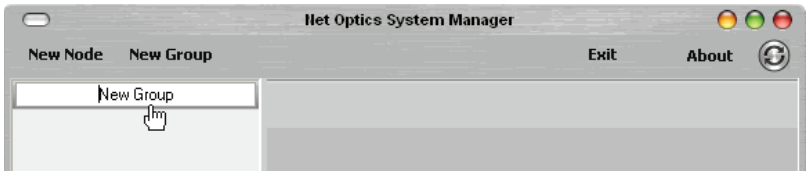

Figure 21: Group Bar

2. Type the name of the new group and press **Enter**.

Deleting a Group

You can delete a group however, all iMatrix Switches in that group will also be deleted from System Manager.

Note:

Deleting an iMatrix Switch from System Manager does not affect the current operating status of the iMatrix Switch. It will continue to pass traffic from the Span Ports connected at the time you delete the iMatrix Switch from System Manager to the Monitor Ports.

To delete a Group:

1. Right click on the group bar of the group you want to delete.
2. Select **Delete** from the pop-up menu. The Group and all associated iMatrix Switches are deleted from System Manager.

Adding iMatrix Switches

To configure and control iMatrix Switches with System Manager, you must add iMatrix Switches to System Manager. Once you have added an iMatrix Switch, you can configure, modify, group, and delete it from System Manager.

Note:

The iMatrix Switch must be connected to the network as described in Chapter 2 before it can be added to System Manager.

To add an iMatrix Switch to the system:

1. Select the Group to which you want to add an iMatrix Switch by clicking the group bar.
2. Click **New Node** in the toolbar as shown in Figure 22. The **New Node** dialog box appears as shown in Figure 23.

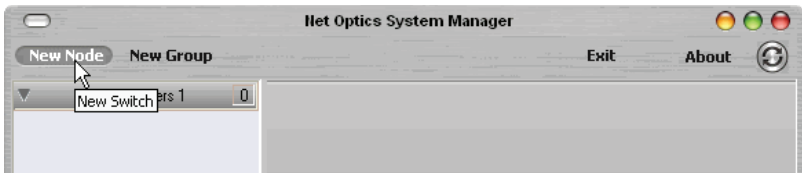

Figure 22: Adding a New iMatrix Switch

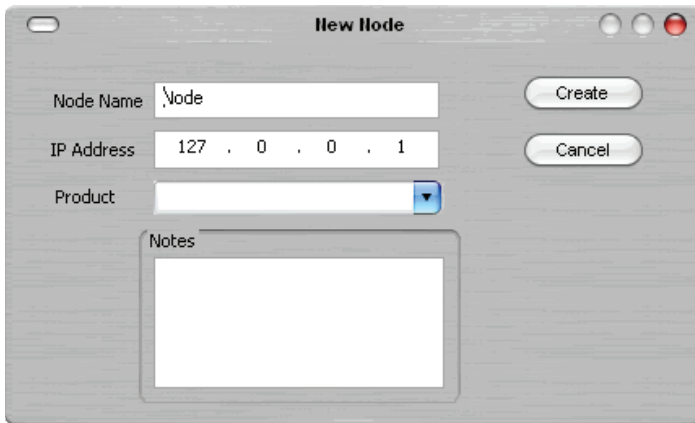

Figure 23: New iMatrix Switch

2. Enter a name for the iMatrix Switch you are adding in the **Node Name** text box. Each Node Name in the system must be unique.
3. Enter the IP address of the iMatrix Switch in the **IP Address** text box. Make sure the IP address is unique on the network.
4. Select your model of the iMatrix Switch from the **Product** drop-down list.
5. Enter any relevant information about the iMatrix Switch in the **Notes** text box.
6. Check your settings and click **Create**. The System Manger now shows the iMatrix Switch in the system similar to Figure 24.

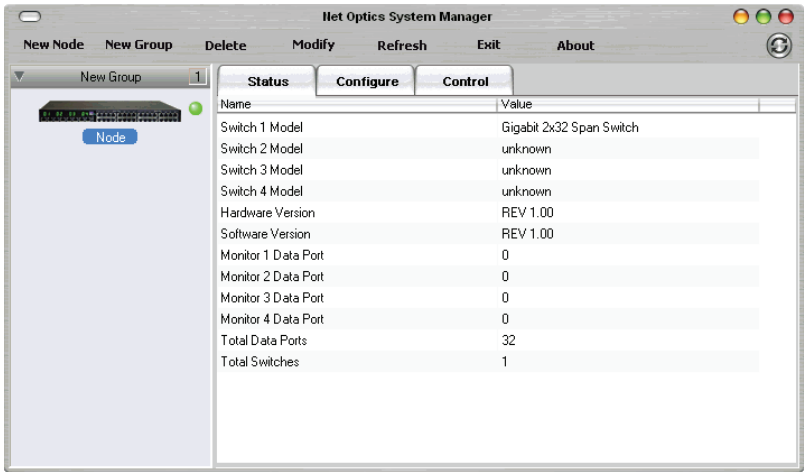

Figure 24: Net Optics System Manager with an iMatrix Switch

The indicator to the right of the iMatrix Switch picture blinks green when the iMatrix Switch is functioning normally. If there is an alarm condition on the iMatrix Switch, the indicator blinks red. If System Manager cannot communicate with the iMatrix Switch, the graphic of the switch appears grayed. Check that the iMatrix Switch is connected to the network and verify the configuration information.

- Repeat Steps 1-6 for each iMatrix Switch you are adding to System Manager.

Tip!

To change the order in which iMatrix Switches appear in the System Frame, click and drag iMatrix Switches into the desired order.

Deleting an iMatrix Switch

You can delete an iMatrix Switch from System Manager when you remove an iMatrix Switch from your network. If you have removed an iMatrix Switch from the network, System Manager continues to poll the iMatrix Switch's IP address for data until you delete the iMatrix Switch from System Manager.

To delete an iMatrix Switch from System Manager:

1. Select the iMatrix Switch you want to delete by clicking its icon.
2. Click **Delete** in the toolbar. A confirmation dialog box appears.

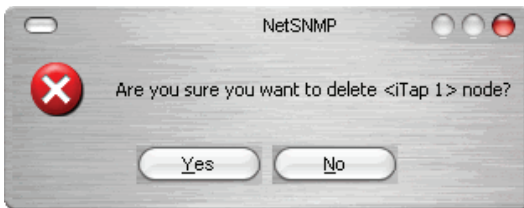

Figure 25: Delete Confirmation

3. Click **Yes** to delete the iMatrix Switch from System Manager.

Configuring an iMatrix Switch

You can set configuration parameters of an iMatrix Switch in the system from the **Configure** tab.

To configure the iMatrix Switch:

1. Click on the icon of the iMatrix Switch you want to configure and click the **Configure** tab as shown in Figure 26.

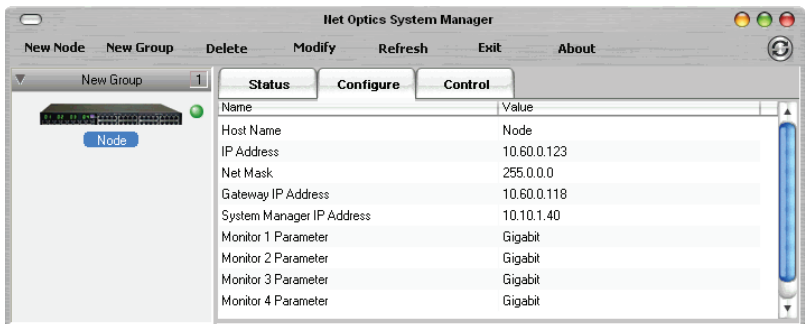

Figure 26: iMatrix Switch Configure Tab

2. For the parameter you wish to configure, click on the corresponding value field.
3. Select an option from the drop-down list or enter a new value from your keyboard.
4. The new configuration parameters take effect next time System Manager polls the iMatrix Switch.

The table below describes the configuration options on the Configure Tab.

Host Name	The name of the iMatrix Switch
IP Address	The IP address of the iMatrix Switch.
Netmask	The IP address netmask.
Gateway IP Address	The IP address of the gateway.
System Manager IP Address	The IP address of the host PC running System Manager or third-party SNMP management tool.
Monitor Port 1 Parameter	The speed setting for Monitor Port 1 (GigaBit, 10 Mbps, or 100 Mbps).
Monitor Port 2 Parameter	The speed setting for Monitor Port 2 (GigaBit, 10 Mbps, or 100 Mbps).
Monitor Port 3 Parameter	The speed setting for Monitor Port 3 (GigaBit, 10 Mbps, or 100 Mbps).
Monitor Port 4 Parameter	The speed setting for Monitor Port 4 (GigaBit, 10 Mbps, or 100 Mbps).

Viewing iMatrix Switch Information

System Manager allows you to view the current iMatrix Switch configuration information, including the Monitor Port connections.

To view iMatrix Switch information:

1. Click the image of the iMatrix Switch you want to view in the System Frame. A window similar to Figure 27 appears.

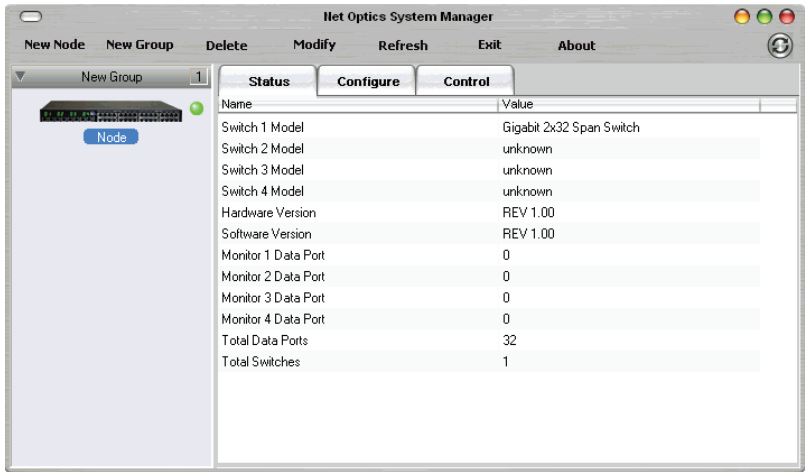

Figure 27: iMatrix Switch Status Tab

The Status tab is a read-only list of information from the iMatrix Switch. Use the scroll bar and arrows to view the entire list if necessary.

TIP!

Fields that have been updated since the last refresh appear with a circle and arrow just to the left of the value field.

The following table explains the status fields.

Switch 1 Model	Model of the Controller iMatrix Switch.
Switch 2 Model	Model of the first Client iMatrix Switch, if present.
Switch 3 Model	Model of the second Client iMatrix Switch, if present.
Hardware Version	Hardware version of the Controller iMatrix Switch. The hardware version is not displayed for Client iMatrix Switches.
Software Version	Software version of the Controller iMatrix Switch. The software version is not displayed for Client iMatrix Switches.
Monitor Port 1 Data Port	The Span Port currently connected to Monitor Port 1. To change the Monitor Port connection, use the Control Tab.
Monitor Port 2 Data Port	The Span Port currently connected to Monitor Port 2. To change the Monitor Port connection, use the Control Tab.
Monitor Port 3 Data Port	The Span Port currently connected to Monitor Port 3. To change the Monitor Port connection, use the Control Tab.

Monitor Port 4 Data Port	The Span Port currently connected to Monitor Port 4. To change the Monitor Port connection, use the Control Tab.
Total Data Ports	Total number of Data Ports on the iMatrix Switch including any ports on daisy-chained Client iMatrix Switches.
Total Switches	Total number of daisy-chained Client iMatrix Switches plus the Controller iMatrix Switch (1-3).

Modifying an iMatrix Switch

You can change the IP address and other basic iMatrix Switch configuration parameters from the Modify iMatrix Switch dialog box.

To modify the iMatrix Switch configuration:

1. In the System Frame, click on the image of the iMatrix Switch you want to change.
2. Click **Modify** in the toolbar. The Modify Node dialog box appears as shown in Figure 28.

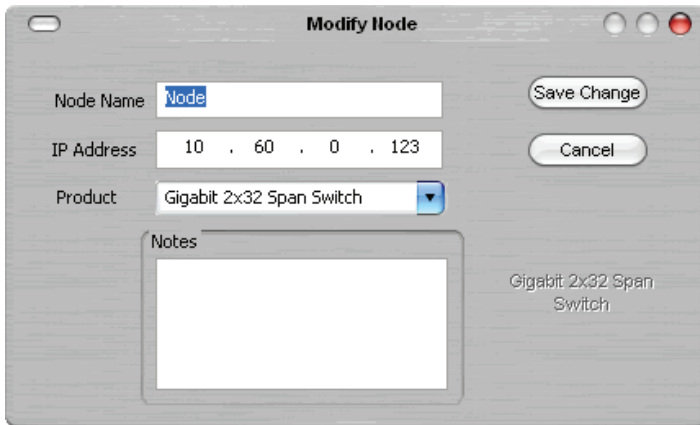

Figure 28: Modify iMatrix Switch

3. Make the desired changes and click **Save Change**.

Controlling Switch Connections

Use the Control Tab to connect the Monitor Ports to a connected Span Port. You can connect four monitoring devices to any four Span Ports on the switch or daisy-chained switches.

To connect a Monitor Port to a Span Port:

1. Click the **Control** tab. Figure 29 shows the Control Tab for a 2xN iMatrix Switch. The 4xN GigaBit Copper Span Switch will show four Monitor Port columns.

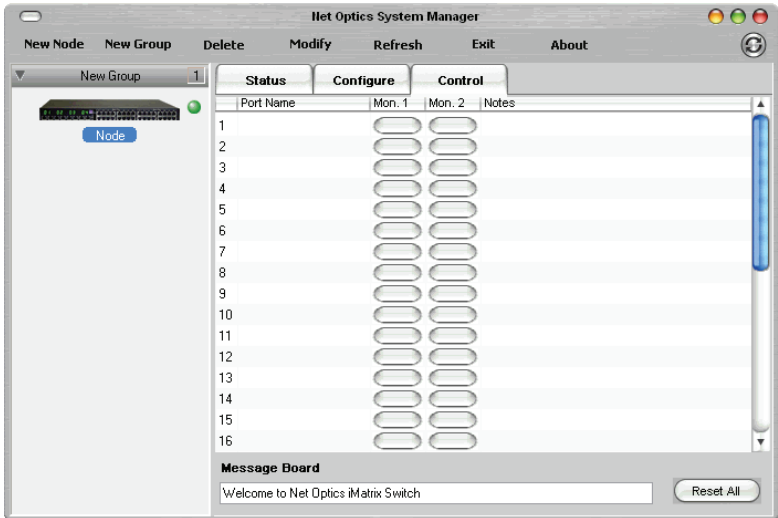

Figure 29: Control Tab

2. Click a port in the **Mon. 1** column to connect the device on Monitor Port 1 to a Span Port. The example in Figure 30 shows Monitor Port 1 connected to Span Port 2.

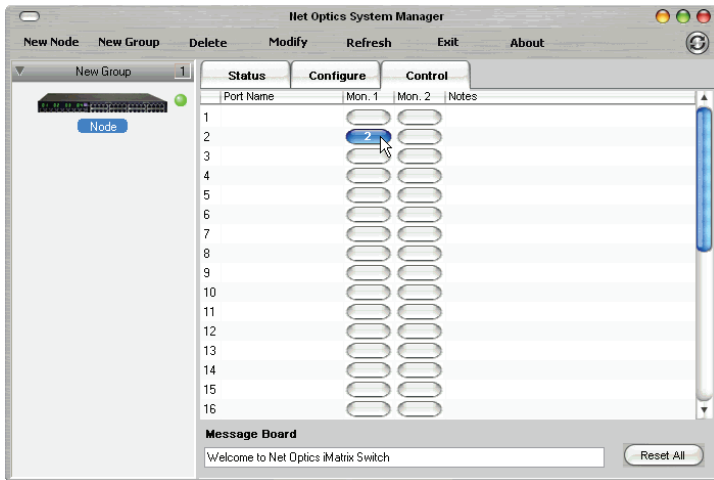

Figure 30: Connecting Monitor Port 1

- Click a port in the **Mon. 2** column to connect the device on Monitor Port 2 to a Span Port. The example in Figure 31 shows Monitor Port 2 connected to Span Port 4.

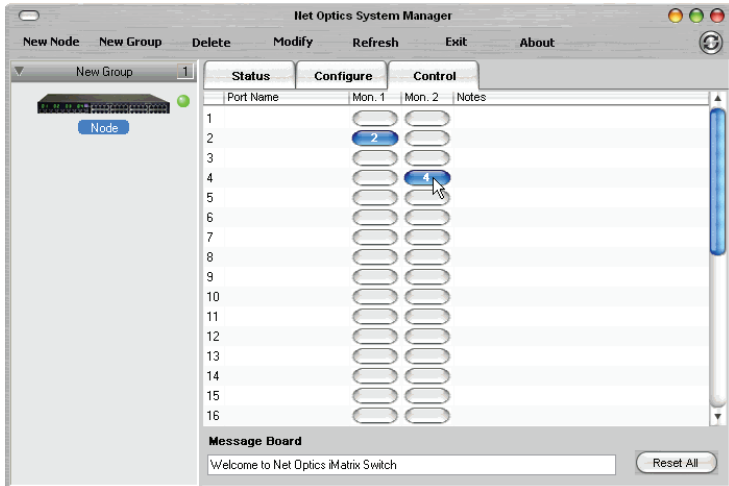

Figure 31: Connecting Monitor Port 2

- Repeat for Steps 1 and 2 for **Mon. 3** and **Mon. 4** columns. You cannot connect more than one Monitor Port to a Span Port.

4. To clear all port connections, click **Reset All**.

Entering Port Names and Notes

You have the option of naming the Span Ports and entering a note. Naming the Span Ports will make switch management easier. Add notes to the Span Port connection to communicate important information to other users of System Manager.

To enter Span Port Names and Notes:

1. Click the text box next to the Span Port number you wish to name.
2. Enter the name of the Span Port and press **Enter**.
3. Click the text box in the Note column to add a note about this Span Port.
4. You can also enter a message about this particular switch in the Message Board text box at the bottom of the page.

Appendix A

Specifications and Models

Specifications

Electrical

Power Input

100-240VAC, 0.5A, 47-63Hz

Environmental

Operating Temperature

0°C to 55°C

Storage Temperature

-10°C to 70°C

Relative Humidity

5% min, 95% max, non-condensing

Mechanical

Dimensions

1.75" high x 15.75" deep x 17" wide

Cable Interfaces:

Copper Cable Type: 22-24 AWG unshielded twisted pair cable, CAT5e
Link Distance Supported: 90 meters (includes network and monitor segments)

Connectors:

- (4) RJ45, 8-pin connectors (monitor ports)
- (4) RJ45, 8-pin connectors (monitor daisy chain ports)
- (16) RJ45, 8-pin connectors (Span ports)
- (2) Mini-DIN, 4-pin connectors (daisy-chain control)
- (2) DB9 serial control interfaces

Indicators

- (4) 2-character LED
- (20) Link/Activity LEDs
- (2) Power LEDs

Software**Command Line Interface**

Any terminal emulation software

iMatrix Web Manager

Any browser

iMatrix System Manager

Windows 98, Windows 2000, Windows XP

Certifications

Fully RoHS compliant

Appendix B

Command Line Interface

Command	Sub-Command	Syntax	Description
Help	Set	help set	Displays the set command options.
	Reset	help reset	Displays the reset command options.
	Show	help show	Displays the show command options.
	Echo	help echo	Displays the echo command options.
	Display	help display	Displays the display command options.
Set	IP	set ip <address>	Where <address> is the IP address of the iMatrix Switch.
	Netmask	set netmask <address>	Where <address> is the IP address of the netmask.
	Gateway	set gateway <address>	Where <address> is the IP address of the gateway.
	Manager	set manager <address>	Where <address> is the IP address of the remote manager.
	Parameter Port	set parameter port <port ID> <parameter>	Where <port ID> is 1, 2, 3, or 4 and <parameter> is 0 = GigaBit 1 = 10 Mbps 2 = 100 Mbps 3 = 1000 Mbps
	Username	set username <username>	Where <username> is the authorized user's name, 9 characters or less.
	Password	set password <password>	Where <password> is the authorized user's password, 9 characters or less.
Reset	Storage	reset storage	Resets configuration to factory defaults.
	Switch	reset switch	Disconnects all Monitor Ports from any data ports.

Command	Sub-Command	Syntax	Description
Switch	Monitor Port	switch monitor <monitor> port <port ID>	Sets which data port is monitored where <monitor> is 1, 2, 3, or 4 and <port ID> is the data port number
Show	Set	show set	Displays current settings.
	Switch	show status	Displays current data port connected to the monitor port.
	Display	show display	Displays the display setting. Display OFF disables remote interfaces.
	User	show user	Displays current user logged into the CLI.
Echo	n/a	echo <on/off>	Echo off stops typed character from being displayed on the screen.
Display	n/a	display	Toggles the remote interface on and off.

www.netoptics.com

© 2006 by Net Optics, Inc. All Rights Reserved.

Free Manuals Download Website

<http://myh66.com>

<http://usermanuals.us>

<http://www.somanuals.com>

<http://www.4manuals.cc>

<http://www.manual-lib.com>

<http://www.404manual.com>

<http://www.luxmanual.com>

<http://aubethermostatmanual.com>

Golf course search by state

<http://golfingnear.com>

Email search by domain

<http://emailbydomain.com>

Auto manuals search

<http://auto.somanuals.com>

TV manuals search

<http://tv.somanuals.com>