

Nikon Laser IRT 4-12X42

Instruction Manual



Congratulations on your choice of a Nikon Laser IRT. Your new scope is the finest example of Nikon's rugged and durable construction and precision bright optics; important qualities for a serious shooter's riflescope.

Whether you use your scope for hunting or for target shooting, the procedure for mounting is identical. After mounting the scope on your riflescope, follow the procedures for reticle alignment.

When setting the reticle for hunting, you should determine your standard range and then adjust the reticle based upon that reading distance. For targets which vary from that standard distance you may simply adjust the position of the reticle in relation to your target, or you may wish to use the procedure for trajectory compensation. It's up to your personal preference.

We hope that you will enjoy your new Nikon Laser IRT for many years to come. Enjoy using it, and above all, always follow safe shooting procedures!

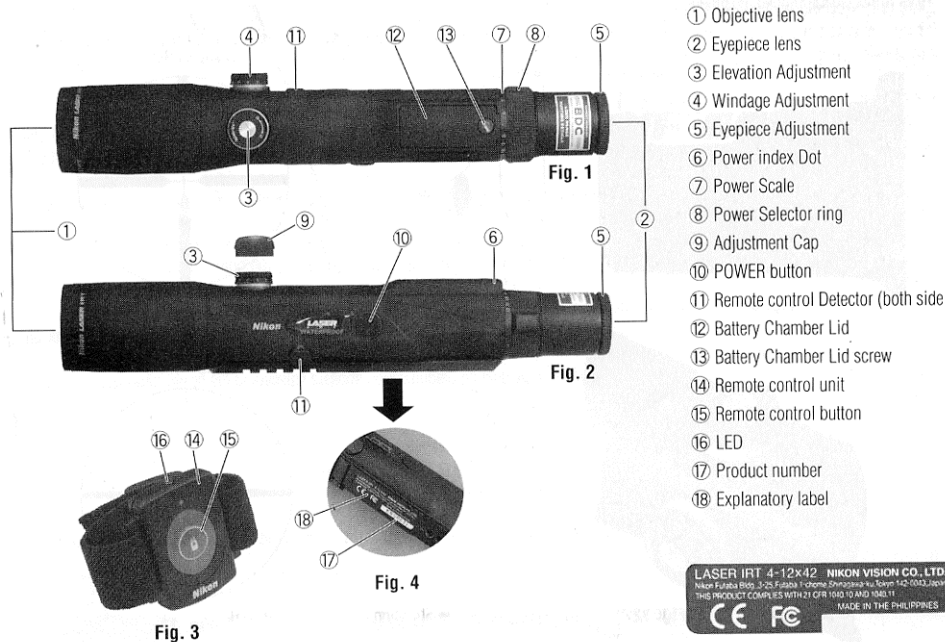

Please observe the following guidelines strictly so you can use the equipment properly and avoid potentially hazardous problems. Before using this product, read thoroughly the “SAFETY PRECAUTIONS” and instructions on correct usage accompanying the product. Use of controls or adjustments or performance of procedures other than those specified herein may result in hazardous radiation exposure.

Keep this manual within reach for easy reference.

- Specifications and design are subject to change without notice.
- No reproduction in any form of this manual, in whole or in part (except for brief quotation in critical articles or reviews), may be made without written authorization from NIKON VISION CO., LTD.

The product(s) described herein may be subject to export control regulations in the relevant country(ies). It (they) should not be exported without authorization of the exporting governmental authority if the regulations apply.

Key Features

- Measuring range: 33 yards-766 yards
- Distance measurement display: 1 yard
- Easy-to-aim 4-12x optical observation system

- Waterproof design (NOT designed for underwater usage)
- Invisible/Eyesafe FDA Class I Laser
- 8-second results display
- Compact, ergonomic design
- Stand-by mode (after approx. 8 sec. Unattended)
- Automatic shut-off (after approx. 2 hours. Unattended)
- Default to “Last Use” settings
- 12-second continuous measuring function
- Diopter adjustment function
- Infrared/manual control distance measurement system

The Nikon Laser IRT emits invisible, eyesafe, infrared energy pulses that reflect off the selected target back to its optical receiver. Sophisticated precision charge circuitry is used to instantaneously calculate distances, by measuring the time it takes for each pulse to travel from the rangefinder to the target and back. The maximum range of the instrument depends on the reflectivity of the target, its color, surface finish, size and shape.

The following factors ensure best range and accuracy:

- Nighttime use
- Cloudy weather
- Bright-colored targets
- Targets with highly reflective surfaces
- Targets with shiny exteriors
- Large-size targets
- Shooting targets facing at 90 degrees

Measurement may result in inaccuracy or failure in the following cases:

- Slender or small target
- Target has diffusing reflective surface
- Target does not reflect the laser beam (glass, a mirror, etc.)
- Black target
- Target has pronounced depth
- In snow, rain or fog
- Target measured through glass
- Reflective surface measured from diagonal direction
- Moving target
- Obstacle moving in front of the target
- When targeting the surface of water

Status of the Internal Display

1. Fig. 10, 11 - Reticle (aiming system)

Use to take aim at the target. Position the target at the center of the reticle, which will always appear in the display.

2. [BBB] - Distance/measurement status display

Digitally Indicates measured distance in yards. Also indicates measuring status such as "Measurement in progress". "Measurement unsuccessful" or "Unable to measure".

Display of results: (<100/yards) e.g.55 yards = [55v]

Display of results: (≤100/yards) e.g.576 yards = [576v]

[≡v] - Now measuring

[---v] - Fail to measure or can not measure distance.

3. [v] - Indicates distance being measured in yards and battery condition.

4. [-G-] - One shot measurement mode.

Display at "after power on" or "Measurement mode is changed".

5. [-C-] - Normal (continuous) measurement mode (Initial setting)

Display at "Measurement is over" or "Measurement mode is changed".

Changing Battery

- **Type of battery**

Scope – 3V CR2 Lithium Battery

Remote control unit – 3V CR2025 Lithium Battery

- **Battery change**

Scope

1. Loosen the Battery Chamber Lid screw with coin. (Fig. 5)
2. Replace the CR2 Lithium Battery correctly. (Fig. 6)
3. Tighten the lid screw firmly for air tightness

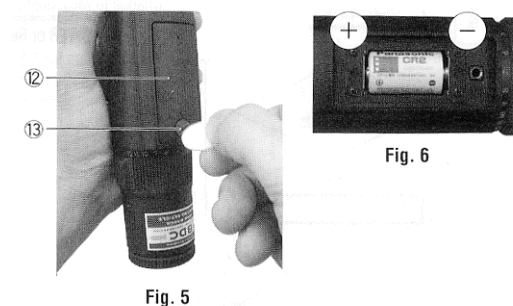

Remote control unit

1. Insert the metal plate into the groove of opposite side of LED. (Fig. 7)
2. Press down the metal plate (a) to lift up the rear cover (b). (Fig. 7) There are eight hinge stoppers. (Fig. 8) (Be careful to break the hinge stopper.)
3. Replace the CR2025 Lithium Battery correctly. (Fig. 8)
4. Put the rear cover back and press the edge of cover to catch the hinge stopper.

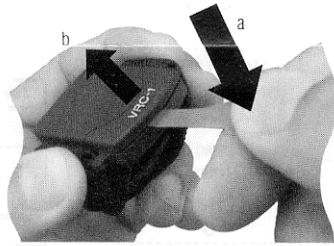

Fig. 7



○ shows a position of hinge stopper

Fig. 8

Battery condition

Scope

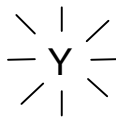

flashing: Battery charge is low and battery should be replaced.

Remote control unit

No information

Install the Remote control unit

1. The Remote control unit is attached near the thumb of the hand which is holding the gun.
2. The LED on the Remote control unit must turn the direction of the Remote control Detector. (Fig. 2 & 3)
3. Then fix the Remote control Unit with the band.

Effective control range is less than 20 inches.

Operational Summary

Riflescope

1. Diopter adjustment

(1) Look through the eyepiece with your eye positioned about 4 inches away from the eyepiece lens (Fig. 9), and you will see the Nikoplex reticle (Fig. 10), or the BDC reticle (Fig. 11).

Be sure your eye is positioned within proper alignment and proper eye relief otherwise the view will “black out”.

(2) Point the objective end of the scope at the sky (Do not point at the sun) or at a plain unpatterned wall.

Turn the eyepiece adjustment counter-clockwise and then turn it clockwise until the reticle appears sharp.

2. Magnification

- The Laser IRT 4-12X42 has a variable magnification from 4 to 12X. To change powers, just rotate the power selector ring until the desired magnification appears adjacent to the power index dot (Fig. 2).

3. Adjustment of the riflescope

Sighting through the riflescope, align the rifle with your aiming point on the target and shoot a trial round. If the bullet does not hit the aiming point, adjust the elevation and windage after removing the Adjustment cap, as follows:

4-12X42

- For the Laser IRT adjustment is made by turning the grip by hand. If the bullet hits under the aiming point, turn the grip in the direction of the arrow marked “U”. If the bullet hits to the left of the aiming point, turn the grip in the direction of the arrow marked “R” (Fig. 12).

Note:

- The windage and elevation scales of the Laser IRT 4-12X42 is calibrated in divisions of $\frac{1}{4}$ minute of angle with a click at intervals of $\frac{1}{4}$ minute of angle (half division).
- When adjusting the reticle to the point of aim, remember that one minute of angle equals approximately one inch (2.54 cm) at 100 yards (91.44 m). Therefore, if the impact point is two inches (5.08 cm) low and one inch (2.54 cm) right at 100 yards (91.44 m) Parallax Setting, you should adjust two minutes of the angle up one minute of the angle left.

Laser Range Finder

Caution – use of controls or adjustments or performance of procedures other than those specified herein may result in hazardous radiation exposure.

- 1. Install a battery in the battery chamber. (See “Changing Batteries”)**
- 2. Diopter adjustment Refer to Riflescope Diopter adjustment.**

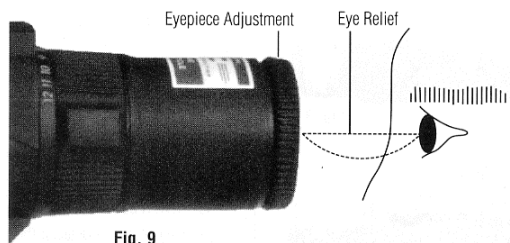

Fig. 9

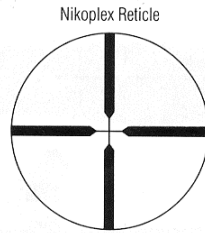

Fig. 10

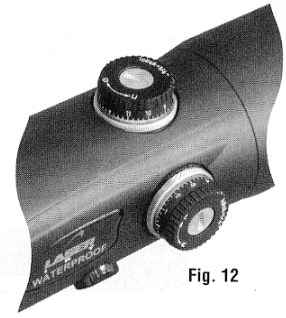

Fig. 12

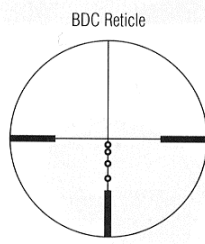
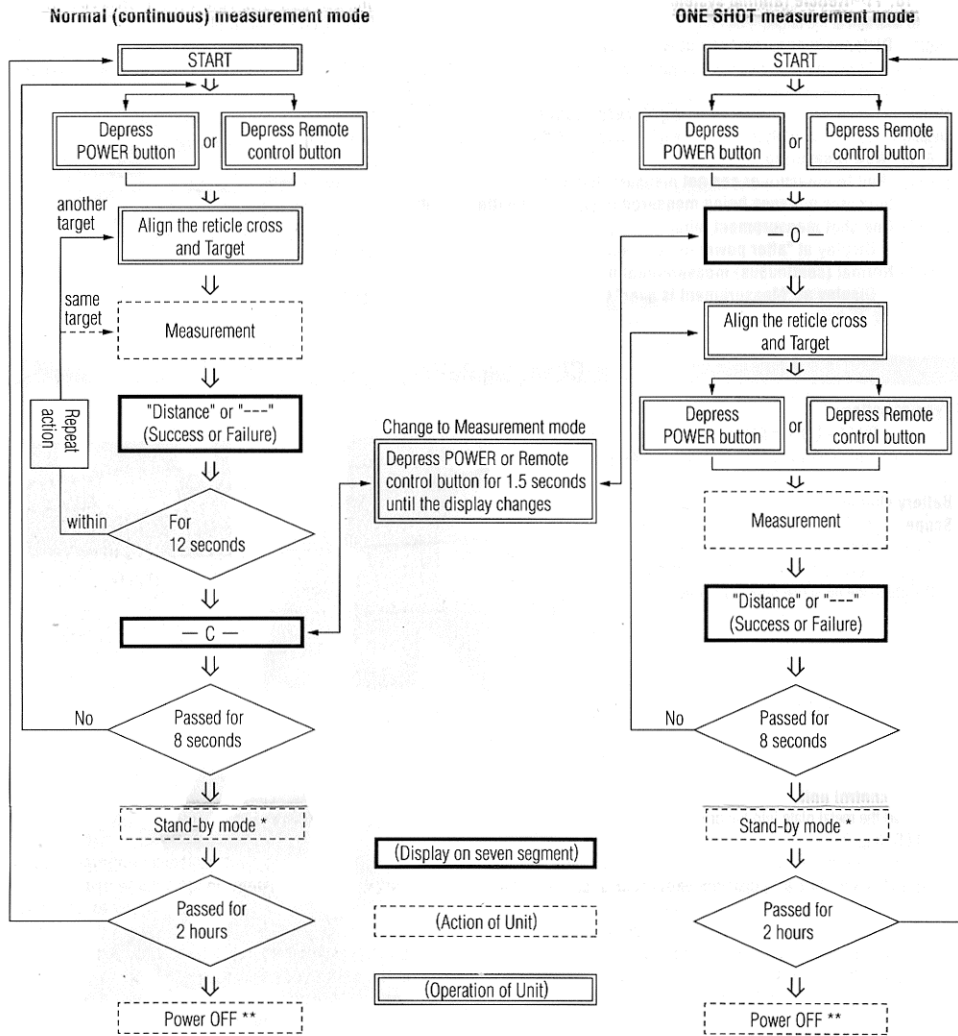

Fig. 11

3. Measuring

3. Measuring



4. Selecting measurement mode

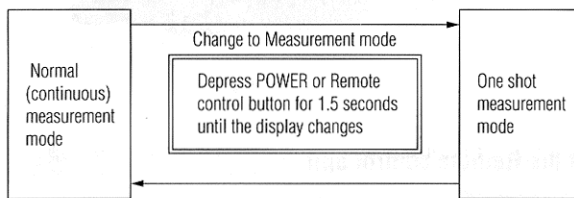

- Continuous measurement
The instrument continuously measures distance for 12 seconds.

ITEM SUPPLIED	
Body.....	1pc.
Eyepiece cap.....	1pc.
Objective cap.....	1pair
Remote control unit.....	1pc.
Battery (CR2 & CR2025).....	1pc. each
Mount base.....	2pc. (with tool)
Nikon cloth.....	1pc.

Specifications

MODEL

4-12x42

SCOPE

Actual magnification	4x-12x	
Objective diameter	(mm) 42	(in) 1.65
Exit pupil	(mm) 3.5 ☆	(in) 0.14 ☆
Eye relief	(mm) 74-75	* (in) 2.9-3.0
Field of view at 100 yds.	* (ft) 25.0-8.2	
Objective outside diameter	(mm) 52	(in) 2.05
Length	(mm) 330	(in) 13
Weight	(g) 660	(without battery) (oz) 23.3
Adjustment graduation **	¼: 1 click (moa)	
Maximum internal adjustment **	40 (Elevation & Windage) (moa)	
Parallax setting (at factory) (yards)	100	
Outside Diameter of Eyepiece	(mm) 39	(in) 1.78

LASER

Class	FDA Class I
Wavelength	905nm
Pulse duration	30ns
Output 15W	
Beam Divergence	0.036 degree

OTHERS

Measuring range	33-766 yards
Distance display	1 yard step
Structure Scope:	Waterproof (maximum depth of 2 meters for up to 5 minutes),
Battery chamber:	Water resistant ***
Operating temperature	-10° to +50°
Remote control unit	Attachable to a gun with the band
Power source	
Scope:	3 volts DC, CR-2 lithium battery x1
Remote control unit:	3 volts DC, CR2025 lithium battery x1

Safety & EMC

21 CRF PART 1040.10: 1985
FCC Part 15/Sub Part B Class B

☆ When maximum magnification (12x) is selected.

*(at minimum magnification) – (at maximum magnification)

** moa = minute of angle

*** The battery chamber is water resistant, not waterproof. Water may enter the device if the laser IRT is submerged in water. If water enters the battery chamber, wipe out any moisture and allow time for the chamber to dry.

Waterproof models:

The Laser IRT is waterproof, and will suffer no damage to the optical system if submerged or dropped in water to a maximum depth of 2 meters for up to 5 minutes.

The Laser IRT offers the following advantages:

- Can be used in conditions of high humidity, dust and rain without risk of damage.
- Nitrogen-filled design makes it resistant to condensation and mold.

Observe the following when using the Laser IRT:

- As the unit does not have perfectly sealed structure, it should not be operated nor held in running water.
- Any moisture should be wiped off before adjusting movable parts (Power selector Ring, eyepiece, etc.) of the Laser IRT to prevent damage and for safety reasons.

To keep your Laser IRT in excellent condition, Nikon Vision recommends regular servicing by an authorized dealer.

Troubleshooting/Repair

If your Nikon Laser IRT should require repair, please contact your local dealer for details regarding where to send it. Before doing so, you are advised to consult the Troubleshooting Table below.

Symptom

Check Points

Unit does not turn on –
LED fails to illuminate

- Depress POWER button
- Check and replace battery if necessary

Target range cannot be obtained	<ul style="list-style-type: none"> • Be sure that nothing, such as your hand or finger, is blocking the laser emission aperture and laser detector. • Be sure that the laser emission aperture and laser detector are clean. Clean them if necessary. • Be sure that the target shape and condition is appropriate to reflect the laser beam. • Replace battery.
[----] (“Cannot measure”) appears	<ul style="list-style-type: none"> • Be sure to hold the unit steady while depressing the POWER button. • Be sure the target is within measuring range (33-766 yards)
Closer target cannot be measured	<ul style="list-style-type: none"> • Be sure that nothing, such as leaves or grass, is between the Laser IRT and the target.
Target beyond a certain distance cannot be measured	<ul style="list-style-type: none"> • Be sure that nothing, such as leaves or grass, is between the Laser IRT and the target.
Measurement result is unstable	<ul style="list-style-type: none"> • Replace battery. • Be sure the target shape and condition is appropriate to reflect the laser beam. • Be sure to hold the unit steady while measuring the distance. • Be sure that nothing, such as leaves or grass, is between the Laser IRT and the target.
Incorrect result is displayed	<ul style="list-style-type: none"> • Replace battery.

- Be sure the target shape and condition is appropriate to reflect the laser beam.
- Be sure that nothing, such as leaves or grass, is between the Laser IRT and the target.

If problems persist after consulting the Troubleshooting Table, please contact your local dealer to check/repair the Laser IRT. Never let anyone other than the official representative of the product manufacturer check or repair the Laser IRT. Failure to follow this instruction could result in injury, or damage to the product.

This device complies with Part 15 of the FCC Rules. Operation is subject to the following two conditions: (1) This device may not cause harmful interference, and (2) this device must accept any interference received, including interference that may cause undesired operation.

This equipment has been tested and found to comply with the limits for a Class B digital device, pursuant to Part 15 of the FCC Rules. These limits are designed to provide reasonable protection against harmful interference in a residential installation. This equipment generates, uses and can radiate radio frequency energy and, if not installed and used in accordance with the instructions, may cause harmful interference to radio communications. However, there is no guarantee that interference will not occur in a particular installation. If this equipment does cause harmful interference to radio or television reception, which can be determined by turning the equipment off and on, the user is encouraged to try to correct the interference by one or more of the following measures:

- Reorient to relocate the receiving antenna.
- Increase the separation between the equipment and receiver.
- Consult the dealer or an experienced radio/TV technician for help.

Do not use the Laser IRT for purposes beyond the limits of its stated accuracy.

CAUTIONS BEFORE USE

Please observe the following guidelines strictly so you can use the equipment properly and avoid potentially hazardous problems. Before using this product, read thoroughly the “SAFETY AND OPERATION PRECAUTIONS” and instructions on

correct usage accompanying the product. Keep this manual within reach for easy reference.

 **WARNING**

This indication alerts you to the fact that any improper use ignoring the contents described herein can result in potential death or serious injury.

 **CAUTION**

This indication alerts you to the fact that any improper use ignoring the contents described herein can result in potential injury or material loss.

SAFETY AND OPERATION PRECAUTIONS

 **Warning**

- Never look directly at the laser beam or directly at the sun when using the Nikon Laser IRT.
- Do not depress the POWER button while aiming with the eye or looking into the optics from the objective side.
- Do not operate the unit with other additional optical elements, such as lenses or binoculars. Using an optical instrument together with the Nikon Laser IRT increases the danger of damaging the eyes.
- Do not disassemble the Nikon Laser IRT. A product that has been disassembled is not guaranteed by the manufacturer.
- If the Laser IRT's body cover is damaged, or if it emits a strange sound due to dropping or for some other cause, immediately remove the battery and stop using.

 **Cautions**

- When not using the Nikon Laser IRT, do not push the POWER button.
- Do not leave the Nikon Laser IRT within reach of small children.
- Rain, water, sand or mud should be removed from the Laser IRT body surface as soon as possible, using a soft, clean, dry cloth.
- Although the Nikon Laser IRT is waterproof, it is not designed for use underwater.
- Do not leave the Nikon Laser IRT in an unstable place, as it may fall and cause injury, or damage the equipment.
- Do not look through the Nikon Laser IRT while walking. You may walk into something and get hurt.
- Do not leave the Nikon Laser IRT in a car on a hot or sunny day, or near heat-generating equipment. This may damage or negatively affect it.

- Do not leave the Nikon Laser IRT in direct sunlight. Ultraviolet rays and excessive heat may negatively affect or even damage the unit.
- When the Nikon Laser IRT is exposed to sudden changes in temperature, water condensation may occur on lens surfaces. Do not use the product until the condensation has evaporated.
- Do not use alcohol for cleaning the main body.
- Do not leave the polyethylene bag used for packaging within the reach of small children.
- Be careful that small children do not inadvertently swallow the adjustment cap. If it does happen, consult a doctor immediately.
- If your Nikon Laser IRT should fail to operate correctly, discontinue use immediately and consult the Troubleshooting Table. If you are unable to fix the problem, contact your local dealer for instructions on where to send it for repair.

CARE AND MAINTENANCE

Lenses

- When removing dust on the lens surface, use a soft oil-free brush.
- When removing stains or smudges like fingerprints from the lens surface, wipe the lenses very gently with a soft clean cotton cloth or quality oil-free lens tissue. Use a small quantity of pure alcohol (not denatured) to wipe stubborn smudges. Do not use velvet cloth or ordinary tissue, as it may scratch the lens surface. Once the cloth has been used for cleaning the body, it should not be used again for the lens surface.

Main Body

- Clean the body surface with a soft, clean cloth and a dry cloth. Do not use benzene, thinner, or other organic agents because they may cause discoloration or rubber degeneration.

Storage

- Water condensation or mold may occur on the lens surface because of high humidity. Therefore, store the Nikon Laser IRT in a cool, dry place. After use on a rainy day or at night, thoroughly dry it at room temperature, then store in a cool, dry place.

NOTES ON LITHIUM BATTERY

If handled incorrectly, battery may rupture and leak, corroding equipment and staining clothing. Be sure to observe the following:

- Install battery with the + and – poles positioned correctly.
- Battery should be removed when exhausted or during extended periods of non-use.
- Use the same type of battery.
- If battery fluid contacts eyes or skin, rinse well with water. If swallowed, consult a doctor immediately.
- Do not short-circuit battery chamber terminals.
- Do not carry batteries together with keys or coins in a pocket or bag. This may overheat and short-circuit batteries.
- Do not put batteries in fire or water. Never disassemble batteries.
- Do not change batteries.
- Do not subject stored batteries to extremes in temperature.
- Do not subject batteries to strong vibrations or shock.

In the event that you should require service for your Nikon RIFLESCOPE, in case of U.S.A. market, please send it directly to:

Nikon Scope Service

841 Apollo Street, Suite 100

El Segundo, CA. 90245-4721

1-800-Nikon SV.

In other market, please bring it to dealer from which you purchased it.

Nikon Inc.

1300 Walt Whitman Road

Melville, NY 11747-3064

P: (631)547-8632

F: (631)547-4040

Free Manuals Download Website

<http://myh66.com>

<http://usermanuals.us>

<http://www.somanuals.com>

<http://www.4manuals.cc>

<http://www.manual-lib.com>

<http://www.404manual.com>

<http://www.luxmanual.com>

<http://aubethermostatmanual.com>

Golf course search by state

<http://golfingnear.com>

Email search by domain

<http://emailbydomain.com>

Auto manuals search

<http://auto.somanuals.com>

TV manuals search

<http://tv.somanuals.com>