

# ***Nikon***

DIGITAL CAMERA

# COOLPIX L620

## User's Manual





<b>Introduction</b>	
<b>Parts of the Camera</b>	
<b>The Basics of Shooting and Playback</b>	
<b>Shooting Features</b>	
<b>Playback Features</b>	
<b>Recording and Playing Back Movies</b>	
<b>General Camera Setup</b>	
<b>Connecting the Camera to a TV, Computer, or Printer</b>	
<b>Technical Notes and Index</b>	

# Introduction

## Read This First

Thank you for purchasing the Nikon COOLPIX L620 digital camera. Before using the camera, please read the information in "For Your Safety" (📖 viii-xi) and familiarize yourself with the information provided in this manual. After reading, please keep this manual handy and refer to it to enhance your enjoyment of your new camera.

## Confirming the Package Contents

In the event that any items are missing, please contact the store where you purchased the camera.



COOLPIX L620  
Digital Camera



Camera Strap

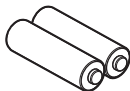

LR6/L40 (AA-size)  
alkaline batteries (x2)\*

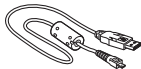

USB Cable UC-E16



ViewNX 2 CD



Reference Manual CD

- User's Manual (this manual)
- Warranty

\* The included batteries are for trial use only.

**NOTE:** A memory card is not included with the camera.

## About This Manual

If you want to start using the camera right away, see “The Basics of Shooting and Playback” (📖 10).

To learn about the parts of the camera and information that is displayed in the monitor, see “Parts of the Camera” (📖 1).

### About the Included “Reference Manual CD”

A PDF version of the COOLPIX L620 Reference Manual can be found on the included CD. Refer to it for more detailed information.

Viewing the “Reference Manual CD”







The Reference Manual can be viewed using Adobe Reader, available for free download from the Adobe website.

- 1 Start the computer and insert the “Reference Manual CD”.
- 2 Double-click the CD (**COOLPIX L620**) icon in **Computer** or **My Computer** (Windows) or on the desktop (Mac OS).
- 3 Double-click the **INDEX.pdf** icon to display the language selection screen. Click a language and follow the links to view the Reference Manual.

## Other Information

- Symbols and Conventions

To make it easier to find the information you need, the following symbols and conventions are used in this manual:

Icon	Description
	This icon indicates cautions and information that should be read before using the camera.
	This icon indicates notes and information that should be read before using the camera.
  *: "Reference Section",  : "Technical Notes and Index."	These icons indicate other pages containing relevant information;  *: "Reference Section",  : "Technical Notes and Index."

\* Refer to the *Reference Manual* for pages indicated with .

- SD, SDHC, and SDXC memory cards are referred to as "memory cards" in this manual.
- The setting at the time of purchase is referred to as the "default setting."
- The names of menu items displayed in the camera monitor, and the names of buttons or messages displayed on a computer monitor appear in bold.
- In this manual, images are sometimes omitted from monitor display samples so that monitor indicators can be more clearly shown.
- Illustrations and monitor content shown in this manual may differ from the actual product.

# Information and Precautions

## Life-Long Learning

As part of Nikon's "Life-Long Learning" commitment to ongoing product support and education, continually updated information is available online at the following sites:

- For users in the U.S.A.: <http://www.nikonusa.com/>
- For users in Europe and Africa: <http://www.europe-nikon.com/support/>
- For users in Asia, Oceania, and the Middle East: <http://www.nikon-asia.com/>

Visit these sites to keep up-to-date with the latest product information, tips, answers to frequently asked questions (FAQs), and general advice on digital imaging and photography. Additional information may be available from the Nikon representative in your area. Visit the site below for contact information:

<http://imaging.nikon.com/>

## Use Only Nikon Brand Electronic Accessories

Nikon COOLPIX cameras are designed to the highest standards and include complex electronic circuitry. Only Nikon brand electronic accessories (including battery chargers, batteries, and AC adapters) certified by Nikon specifically for use with this Nikon digital camera are engineered and proven to operate within the operational and safety requirements of this electronic circuitry.

THE USE OF NON-NIKON ELECTRONIC ACCESSORIES COULD DAMAGE THE CAMERA AND MAY VOID YOUR NIKON WARRANTY.

For more information about Nikon brand accessories, contact a local authorized Nikon dealer.

## Before Taking Important Pictures

Before taking pictures on important occasions (such as at weddings or before taking the camera on a trip), take a test shot to ensure that the camera is functioning normally. Nikon will not be held liable for damages or lost profits that may result from product malfunction.

## About the Manuals

- No part of the manuals included with this product may be reproduced, transmitted, transcribed, stored in a retrieval system, or translated into any language in any form, by any means, without Nikon's prior written permission.
- Nikon reserves the right to change the specifications of the hardware and software described in these manuals at any time and without prior notice.
- Nikon will not be held liable for any damages resulting from the use of this product.
- While every effort was made to ensure that the information in these manuals is accurate and complete, we would appreciate it were you to bring any errors or omissions to the attention of the Nikon representative in your area (address provided separately).

## Notice Concerning Prohibition of Copying or Reproduction

Note that simply being in possession of material that was digitally copied or reproduced by means of a scanner, digital camera or other device may be punishable by law.

### • Items prohibited by law from being copied or reproduced

Do not copy or reproduce paper money, coins, securities, government bonds or local government bonds, even if such copies or reproductions are stamped "Sample." The copying or reproduction of paper money, coins, or securities which are circulated in a foreign country is prohibited. Unless the prior permission of the government was obtained, the copying or reproduction of unused postage stamps or post cards issued by the government is prohibited.

The copying or reproduction of stamps issued by the government and of certified documents stipulated by law is prohibited.

### • Cautions on certain copies and reproductions

The government has issued cautions on copies or reproductions of securities issued by private companies (shares, bills, checks, gift certificates, etc.), commuter passes, or coupon tickets, except when a minimum of necessary copies are to be provided for business use by a company. Also, do not copy or reproduce passports issued by the government, licenses issued by public agencies and private groups, ID cards and tickets, such as passes and meal coupons.

### • Comply with copyright notices

The copying or reproduction of copyrighted creative works such as books, music, paintings, woodcut prints, maps, drawings, movies, and photographs is governed by national and international copyright laws. Do not use this product for the purpose of making illegal copies or to infringe copyright laws.



## Disposing of Data Storage Devices

Please note that deleting images or formatting data storage devices such as memory cards or built-in camera memory does not completely erase the original image data. Deleted files can sometimes be recovered from discarded storage devices using commercially available software, potentially resulting in the malicious use of personal image data. Ensuring the privacy of such data is the user's responsibility.

Before discarding a data storage device or transferring ownership to another person, erase all data using commercial deletion software, or format the device and then completely refill it with images containing no private information (for example, pictures of empty sky). Be sure to also replace any pictures selected for the **Select an image** option in the **Welcome screen** setting (📖 69). Care should be taken to avoid injury or damage to property when physically destroying data storage devices.

## For Your Safety

To prevent damage to your Nikon product or injury to yourself or to others, read the following safety precautions in their entirety before using this equipment. Keep these safety instructions where all those who use the product will read them.



This icon marks warnings, information that should be read before using this Nikon product, to prevent possible injury.

### WARNINGS

#### **Turn off in the event of malfunction**

Should you notice smoke or an unusual smell coming from the camera or AC adapter, unplug the AC adapter and remove the batteries immediately, taking care to avoid burns. Continued operation could result in injury. After removing or disconnecting the power source, take the equipment to a Nikon-authorized service representative for inspection.

#### **Do not disassemble**

Touching the internal parts of the camera or AC adapter could result in injury. Repairs should be performed only by qualified technicians. Should

the camera or AC adapter break open as the result of a fall or other accident, take the product to a Nikon-authorized service representative for inspection, after unplugging the product and/or removing the batteries.

#### **Do not use the camera or AC adapter in the presence of flammable gas**

Do not use electronic equipment in the presence of flammable gas, as this could result in explosion or fire.

#### **Handle the camera strap with care**

Never place the strap around the neck of an infant or child.

** Keep out of reach of children**

Particular care should be taken to prevent infants from putting the batteries or other small parts into their mouths.

** Do not remain in contact with the camera, battery charger, or AC adapter for extended periods while the devices are on or in use**

Parts of the devices become hot. Leaving the devices in direct contact with the skin for extended periods may result in low-temperature burns.

** Do not leave the product where it will be exposed to extremely high temperatures, such as in an enclosed automobile or in direct sunlight**

Failure to observe this precaution could cause damage or fire.

** Observe caution when handling batteries**

Batteries may leak or explode if improperly handled. Observe the following precautions when handling batteries for use in this product:

- Before replacing the batteries, turn the product off. If you are using an AC adapter, be sure it is unplugged.
- Use only the batteries approved for use in this product (📖 10). Do not combine old and new batteries or batteries of different makes or types.
- If Nikon rechargeable Ni-MH batteries EN-MH2 (EN-MH2-B2 or EN-MH2-B4) are purchased separately, charge and use each of them as a set. Do not combine batteries from different pairs.
- The EN-MH2 rechargeable batteries are for use with Nikon digital cameras only, and are compatible with COOLPIX L620.
- Insert batteries in the correct orientation.
- Do not short or disassemble batteries or attempt to remove or break battery insulation or casing.
- Do not expose batteries to flame or to excessive heat.

- Do not immerse in or expose to water.
  - Do not transport or store with metal objects such as necklaces or hairpins.
  - Batteries are prone to leakage when fully discharged. To avoid damage to the product, be sure to remove the batteries when no charge remains.
  - Discontinue use immediately should you notice any change in the batteries, such as discoloration or deformation.
  - If liquid from damaged batteries comes in contact with clothing or skin, rinse immediately with plenty of water.
-  **Observe the following precautions when handling the Battery Chargers (available separately)**
- Keep dry. Failure to observe this precaution could result in fire or electric shock.
  - Dust on or near the metal parts of the plug should be removed with a dry cloth. Continued use could result in fire.
  - Do not handle the power cable or go near the battery charger during lightning storms. Failure to observe this precaution could result in electric shock.
  - Do not damage, modify, forcibly tug or bend the power cable, place it under heavy objects, or expose it to heat or flame. Should the insulation be damaged and the wires become exposed, take it to a Nikon-authorized service representative for inspection. Failure to observe these precautions could result in fire or electric shock.
  - Do not handle the plug or battery charger with wet hands. Failure to observe this precaution could result in electric shock.
  - Do not use with travel converters or adapters designed to convert from one voltage to another or with DC-to-AC inverters. Failure to observe this precaution could damage the product or result in overheating or fire.

### **Use appropriate cables**

When connecting cables to the input and output jacks, use only the cables provided or sold by Nikon for the purpose, to maintain compliance with product regulations.

### **Handle moving parts with care**

Be careful that your fingers or other objects are not pinched by the lens cover or other moving parts.

### **CD-ROMs**

The CD-ROMs included with this device should not be played back on audio CD equipment. Playing CD-ROMs on an audio CD player could cause hearing loss or damage the equipment.

### **Observe caution when using the flash**

Using the flash close to your subject's eyes could cause temporary visual impairment. The flash should be no less than 1 m (3 ft 4 in.) from the subject. Particular care should be observed when photographing infants.

### **Do not operate the flash with the flash window touching a person or object**

Failure to observe this precaution could result in burns or fire.

### **Avoid contact with liquid crystal**

Should the monitor break, care should be taken to avoid injury caused by broken glass and to prevent liquid crystal from the monitor touching the skin or entering the eyes or mouth.

### **Turn the power off when using inside an airplane or the hospital**

Turn the power off while inside the airplane during take off or landing.

Do not use wireless network functions while in the air. Follow the instructions of the hospital when using while in a hospital.

The electromagnetic waves emitted by this camera may disrupt the electronic systems of the airplane or the instruments of the hospital. If you are using an Eye-Fi card, remove it from the camera before boarding an aircraft or entering a hospital.

## Notices

### Notice for Customers in the U.S.A.

#### **Federal Communications Commission (FCC) Radio Frequency Interference Statement**

This equipment has been tested and found to comply with the limits for a Class B digital device, pursuant to Part 15 of the FCC rules. These limits are designed to provide reasonable protection against harmful interference in a residential installation. This equipment generates, uses, and can radiate radio frequency energy and, if not installed and used in accordance with the instructions, may cause harmful interference to radio communications. However, there is no guarantee that interference will not occur in a particular installation. If this equipment does cause harmful interference to radio or television reception, which can be determined by turning the equipment off and on, the user is encouraged to try to correct the interference by one or more of the following measures:

- Reorient or relocate the receiving antenna.
- Increase the separation between the equipment and receiver.
- Connect the equipment into an outlet on a circuit different from that to which the receiver is connected.
- Consult the dealer or an experienced radio/television technician for help.



**Nikon**

**COOLPIX L620**

### **CAUTIONS**

#### **Modifications**

The FCC requires the user to be notified that any changes or modifications made to this device that are not expressly approved by Nikon Corporation may void the user's authority to operate the equipment.

## Interface Cables

Use the interface cables sold or provided by Nikon for your equipment. Using other interface cables may exceed the limits of Class B Part 15 of the FCC rules.

## Notice for customers in the State of California

### WARNING

Handling the cord on this product will expose you to lead, a chemical known to the State of California to cause birth defects or other reproductive harm.

### ***Wash hands after handling.***

Nikon Inc.,  
1300 Walt Whitman Road Melville,  
New York 11747-3064 USA  
Tel: 631-547-4200

## Notice for customers in Canada

CAN ICES-3 B / NMB-3 B

## Notice for Customers in Europe

This symbol indicates that electrical and electronic equipment is to be collected separately.



The following apply only to users in European countries:

- This product is designated for separate collection at an appropriate collection point. Do not dispose of as household waste.
- Separate collection and recycling helps conserve natural resources and prevent negative consequences for human health and the environment that might result from incorrect disposal.
- For more information, contact the retailer or the local authorities in charge of waste management.

This symbol on the batteries indicates that the batteries are to be collected separately.

























The following apply only to users in European countries:

- All batteries, whether marked with this symbol or not, are designated for separate collection at an appropriate collection point. Do not dispose of as household waste.
- For more information, contact the retailer or the local authorities in charge of waste management.















# Table of Contents

Introduction .....	ii	Step 3 Frame a Picture .....	22
Read This First .....	ii	Using the Zoom .....	23
Confirming the Package Contents .....	ii	Step 4 Focus and Shoot .....	24
About This Manual .....	iii	The Shutter-release Button .....	25
Information and Precautions .....	v	Step 5 Play Back Images .....	26
For Your Safety .....	viii	Step 6 Delete Images .....	27
WARNINGS .....	viii		
Notices .....	xii		
		<b>Shooting Features .....</b>	<b>29</b>
<b>Parts of the Camera .....</b>	<b>1</b>	📷 (Easy Auto) Mode .....	29
The Camera Body .....	1	Scene Mode (Shooting Suited to Scenes) ...	30
Attaching the Camera Strap .....	3	Tips and Notes .....	31
Raising and Lowering the Flash .....	3	Special Effects Mode	
Using Menus (MENU Button) .....	4	(Applying Effects When Shooting) .....	35
The Monitor .....	6	Smart Portrait Mode	
Shooting Mode .....	6	(Capturing Images of Smiling Faces) .....	37
Playback Mode .....	8	📷 (Auto) Mode .....	39
		Functions That Can Be Set Using the Multi	
		Selector .....	40
		Using the Flash .....	41
		Using the Self-timer .....	44
		Using Macro Mode .....	46
		Adjusting Brightness	
		(Exposure Compensation) .....	47
		Default Settings .....	48
		Functions That Can Be Set with the	
		MENU Button (Shooting Menu) .....	50
		Options Available in the Shooting Menu ...	51
		Functions That Cannot Be Used	
		Simultaneously .....	52
<b>The Basics of Shooting and Playback ...</b>	<b>10</b>		
Preparation 1 Insert the Batteries .....	10		
Applicable Batteries .....	10		
Preparation 2 Insert a Memory Card .....	12		
Internal Memory and Playback Cards .....	13		
Preparation 3 Setting the Display Language,			
Date, and Time .....	14		
Step 1 Turn the Camera On .....	18		
Step 2 Select a Shooting Mode .....	20		
Available Shooting Modes .....	21		

Focusing.....	54	Reference Section .....	 1
Using Face Detection.....	54	Using Easy Panorama	
Using Skin Softening.....	55	(Shooting and Playback) .....	 2
Using Target Finding AF.....	56	Shooting with Easy Panorama.....	 2
Subjects Not Suitable for Autofocus.....	57	Viewing Images Captured with Easy	
Focus Lock.....	58	Panorama .....	 5
Playback Features.....	59	Favorite Pictures Mode.....	 6
Playback Zoom.....	59	Adding Images to Albums.....	 6
Thumbnail Playback, Calendar Display.....	60	Playing Back Images in Albums.....	 7
Functions That Can Be Set with the		Removing Images from Albums.....	 8
MENU Button (Playback Menu).....	61	Changing the Favorites Album Icon ...	 9
Recording and Playing Back Movies....	63	Auto Sort Mode .....	 10
Recording Movies .....	63	List by Date Mode .....	 11
Functions That Can Be Set with the		Viewing and Deleting Images Captured	
MENU Button (Movie Menu).....	66	Continuously (Sequence).....	 12
Playing Back Movies .....	67	Viewing Images in a Sequence.....	 12
General Camera Setup.....	69	Deleting Images in a Sequence .....	 13
Functions That Can Be Set with the		Editing Still Images.....	 14
MENU Button (Setup Menu).....	69	Before Editing Images .....	 14
Connecting the Camera to a TV,		Quick Retouch:	
Computer, or Printer .....	71	Enhancing Contrast and Saturation ...	 15
Connection Methods.....	71	D-Lighting:	
Using ViewNX 2 .....	73	Enhancing Brightness and Contrast... ..	 15
Installing ViewNX 2 .....	73	Red-eye Correction: Correcting Red Eyes	
Transferring Images to the Computer .....	76	Caused by Using the Flash .....	 16
Viewing Images.....	78	Skin Softening: Softening Skin Tones... ..	 17
		Filter Effects:	
		Applying Digital Filter Effects.....	 18
		Small Picture:	
		Reducing the Size of an Image.....	 20
		Crop: Creating a Cropped Copy.....	 21

Connecting the Camera to a TV (Viewing Images on a TV).....	22	The Movie Menu .....	58
Connecting the Camera to a Printer (Direct Print).....	24	Movie Options.....	58
Connecting the Camera to a Printer...	25	Autofocus Mode .....	61
Printing Individual Images.....	26	Wind Noise Reduction .....	61
Printing Multiple Images .....	28	<b>The Setup Menu .....</b>	62
<b>Editing Movies .....</b>	31	Welcome Screen.....	62
<b>The Shooting Menu</b>		Time Zone and Date.....	63
(for  (Auto) Mode).....	33	Monitor Settings .....	65
Image Mode Settings		Print Date	
(Image Size and Quality).....	33	(Imprinting Date and Time).....	67
White Balance (Adjusting Hue) .....	35	Vibration Reduction.....	68
Continuous Shooting.....	38	Motion Detection.....	69
ISO Sensitivity .....	40	AF Assist .....	70
Color Options .....	41	Digital Zoom .....	70
AF Area Mode.....	42	Sound Settings.....	71
<b>The Smart Portrait Menu.....</b>	43	Auto Off .....	71
Skin Softening .....	43	Format Memory/Format Card.....	72
Smile Timer .....	44	Language.....	73
Blink Proof.....	45	TV Settings.....	73
<b>The Playback Menu.....</b>	46	Blink Warning.....	74
Print Order		Eye-Fi Upload.....	75
(Creating a DPOF Print Order).....	46	Reset All .....	76
Slide Show .....	50	Battery Type.....	77
Protect.....	51	Firmware Version.....	77
Rotate Image.....	53	<b>Error Messages.....</b>	78
Voice Memo .....	54	<b>File Names .....</b>	82
Copy (Copy Between Internal Memory and Memory Card) .....	55	<b>Optional Accessories .....</b>	83
Sequence Display Options .....	57	Attaching the AN-CP23 Camera Strap...	84
Choose Key Picture.....	57		

---

Technical Notes and Index.....		1
Caring for the Product .....		2
The Camera.....		2
Batteries.....		3
Memory Cards.....		5
Cleaning and Storage.....		6
Cleaning.....		6
Storage .....		7
Troubleshooting .....		8
Specifications .....		16
Approved Memory Cards.....		20
Index.....		23

# Parts of the Camera

## The Camera Body

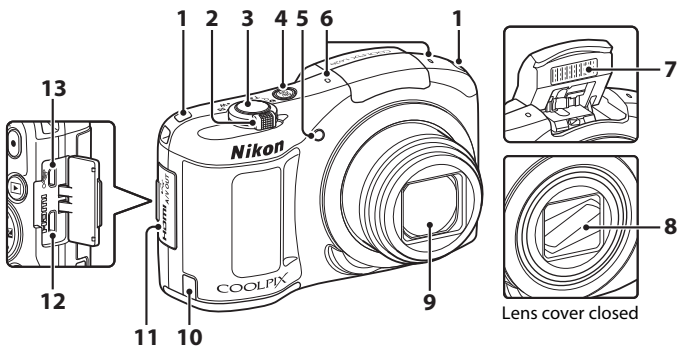

<b>1</b>	Eyelet for camera strap .....	3	<b>6</b>	Microphone (stereo) .....	61, 63
<b>2</b>	W : wide-angle .....	23	<b>7</b>	Flash .....	3, 41
	T : telephoto .....	23	<b>8</b>	Lens cover .....	
	: thumbnail playback .....	60	<b>9</b>	Lens .....	
	: playback zoom .....	59	<b>10</b>	Power connector cover (for AC adapter available separately from Nikon) .....	83
	: help .....	30	<b>11</b>	Connector cover .....	71
<b>3</b>	Shutter-release button .....	24	<b>12</b>	HDMI micro connector (Type D) .....	71
<b>4</b>	Power switch/power-on lamp .....	18	<b>13</b>	USB/audio/video output connector .....	71
<b>5</b>	Self-timer lamp .....	44			
	AF-assist illuminator .....	69			

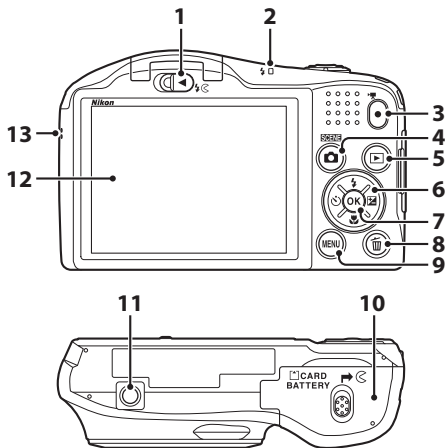

<b>1</b>	(flash pop-up) control.....	3, 41
<b>2</b>	Flash lamp.....	43
<b>3</b>	(movie-record) button.....	63
<b>4</b>	(shooting mode) button .....	29, 30, 35, 37, 39
<b>5</b>	(playback) button.....	26
<b>6</b>	Multi selector.....	4
<b>7</b>	(apply selection) button .....	4

<b>8</b>	(delete) button.....	27
<b>9</b>	<b>MENU</b> (menu) button .....	4, 50, 61, 66, 69
<b>10</b>	Battery-chamber/ memory card slot cover.....	10, 12
<b>11</b>	Tripod socket.....	18
<b>12</b>	Monitor.....	6
<b>13</b>	Speaker.....	61, 67

## Attaching the Camera Strap

Pass the strap through either the left or right strap eyelet and attach the strap.

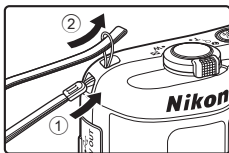

## Raising and Lowering the Flash

Slide the  (flash pop-up) control to raise the flash.

- See "Using the Flash" (📖 41) for more information about flash settings.
- Push the flash down gently to lower the flash until it clicks into place when not in use.

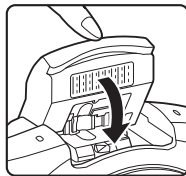
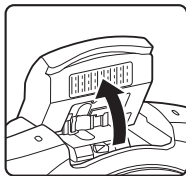
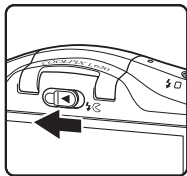

# Using Menu (MENU Button)

Use the multi selector and **OK** button to navigate the menus.

## 1 Press the MENU button.

- The menu is displayed.

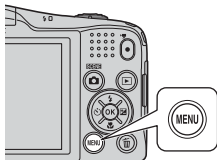

## 2 Press the multi selector ◀.

- The current menu icon is displayed in yellow.

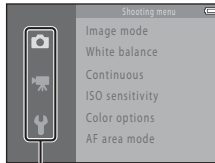

Menu icons

## 3 Select the desired menu icon.

- The menu is changed.

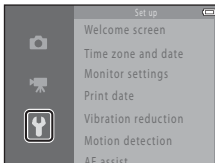

## 4 Press the OK button.

- The menu options become selectable.

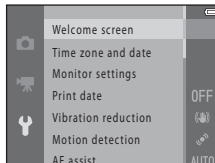



## 5 Select a menu option.

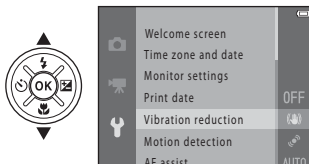

## 6 Press the **OK** button.

- The settings for the option you selected are displayed.

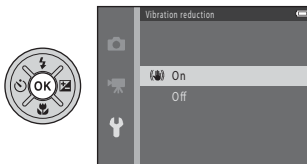

## 7 Select a setting.

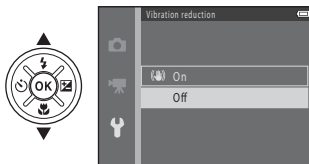



## 8 Press the **OK** button.

- The setting you selected is applied.
- When you are finished using the menu, press the **MENU** button.



### Notes About Setting Menu Options

- Certain menu options cannot be set depending on the current shooting mode or the state of the camera. Unavailable options are displayed in gray and cannot be selected.
- When a menu is displayed, you can switch to shooting mode by pressing the shutter-release button,  (shooting mode) button, or  (movie-record) button.

# The Monitor

The information that is displayed in the monitor during shooting and playback changes depending on the camera's settings and state of use.

By default, information is displayed when the camera is first turned on and when you operate the camera, and turns off after a few seconds (when **Photo info** is set to **Auto info** in **Monitor settings** (📖 69)).



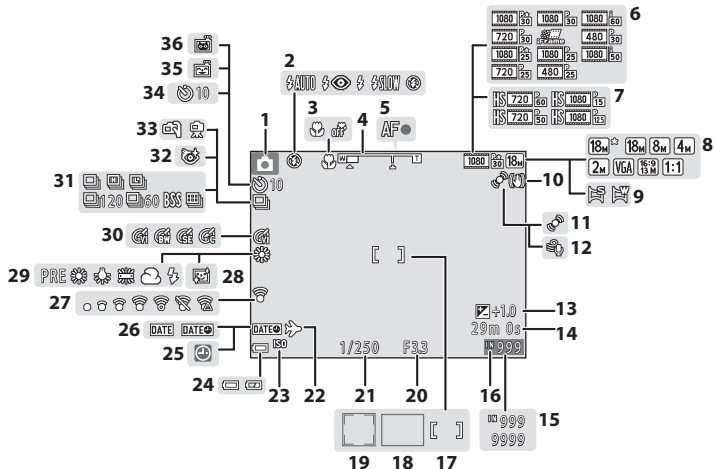





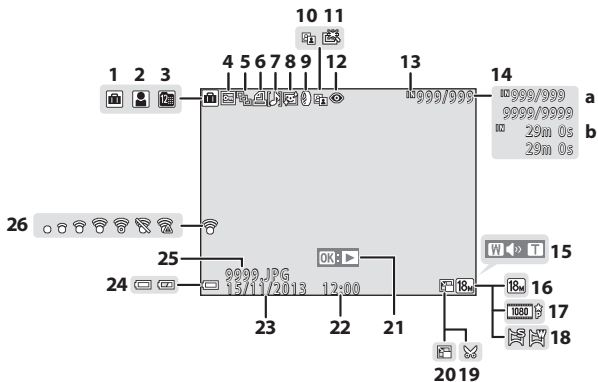











## Shooting Mode



<b>1</b>	Shooting mode.....	20, 21	<b>19</b>	Focus area (face detection, pet detection) .....	24, 34, 37
<b>2</b>	Flash mode.....	41	<b>20</b>	Aperture value .....	25
<b>3</b>	Macro mode.....	46	<b>21</b>	Shutter speed.....	25
<b>4</b>	Zoom indicator.....	23, 46	<b>22</b>	Travel destination icon .....	69
<b>5</b>	Focus indicator.....	24	<b>23</b>	ISO sensitivity.....	51
<b>6</b>	Movie options (normal speed movies)....	66	<b>24</b>	Battery level indicator .....	18
<b>7</b>	Movie options (HS movies) .....	66	<b>25</b>	“Date not set” indicator.....	14, 69
<b>8</b>	Image mode.....	51,  33	<b>26</b>	Print date.....	69
<b>9</b>	Easy panorama.....	33	<b>27</b>	Eye-Fi communication indicator .....	70
<b>10</b>	Vibration reduction icon.....	69	<b>28</b>	Skin softening.....	51
<b>11</b>	Motion detection icon .....	69	<b>29</b>	White balance mode.....	51
<b>12</b>	Wind noise reduction .....	66	<b>30</b>	Color options.....	51
<b>13</b>	Exposure compensation value .....	47	<b>31</b>	Continuous shooting mode .....	34, 51
<b>14</b>	Movie recording time remaining .....	63	<b>32</b>	Blink proof icon .....	51
<b>15</b>	Number of exposures remaining (still images) .....	18	<b>33</b>	Hand-held, tripod .....	31, 32
<b>16</b>	Internal memory indicator.....	18	<b>34</b>	Self-timer indicator .....	44
<b>17</b>	Focus area (center).....	24	<b>35</b>	Smile timer.....	51
<b>18</b>	Focus area (target finding AF) .....	51, 56	<b>36</b>	Pet portrait auto release .....	34

# Playback Mode



<b>1</b>	Album icon in favorite pictures mode... 	66
<b>2</b>	Category icon in auto sort mode .... 	10
<b>3</b>	List by date icon ..... 	11
<b>4</b>	Protect icon.....61, 	51
<b>5</b>	Sequence display (when <b>Individual pictures</b> is selected).....62, 	57
<b>6</b>	Print order icon .....61, 	46
<b>7</b>	Voice memo indicator.....61, 	54
<b>8</b>	Skin softening icon.....61, 	17
<b>9</b>	Filter effects icon.....61, 	18
<b>10</b>	D-Lighting icon.....61, 	15
<b>11</b>	Quick retouch icon.....61, 	15
<b>12</b>	Red-eye correction icon .....61, 	16
<b>13</b>	Internal memory indicator.....	13
<b>14</b>	(a) Current image number/ total number of images.....	26
	(b) Movie length.....	67
<b>15</b>	Volume indicator.....	67
<b>16</b>	Image mode.....	51, 
<b>17</b>	Movie options.....	66, 
<b>18</b>	Easy panorama.....	33, 
<b>19</b>	Crop icon.....	59, 
<b>20</b>	Small picture icon.....	61, 
<b>21</b>	Easy panorama playback guide... 33, 	5
	Sequence playback guide.....62, 	12
	Movie playback guide.....	67
<b>22</b>	Time of recording.....	14
<b>23</b>	Date of recording.....	14
<b>24</b>	Battery level indicator .....	18
<b>25</b>	File number and type..... 	82
<b>26</b>	Eye-Fi communication indicator .....	70, 

# The Basics of Shooting and Playback

## Preparation 1 Insert the Batteries

- 1 Open the battery-chamber/memory card slot cover.
  - Hold the camera upside down to prevent the batteries from falling out.



- 2 Insert the batteries.
  - Confirm that the positive (+) and negative (-) terminals are oriented correctly and insert the batteries.

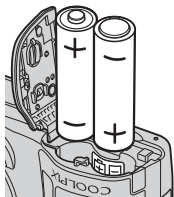

- 3 Close the battery-chamber/memory card slot cover.



### Applicable Batteries

- Two LR6/L40 (AA-size) alkaline batteries (included batteries)
- Two FR6/L91 (AA-size) lithium batteries
- Two EN-MH2 rechargeable Ni-MH (nickel metal hydride) batteries

## ✓ Removing the Batteries

- Turn the camera off and make sure that the power-on lamp and the monitor have turned off, and then open the battery-chamber/memory card slot cover.
- The camera, batteries, and memory card may be hot immediately after using the camera.

## ✓ Notes About the Batteries

- Do not combine old and new batteries or batteries of different makes or types.
- Batteries with the following defects cannot be used:

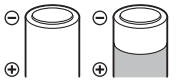

Batteries with peeling



Batteries with insulation that does not cover the area around the negative terminal

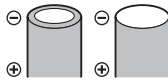

Batteries with a flat negative terminal

## ✓ Battery Type

By setting **Battery type** in the setup menu (📖 70) to match the type of batteries inserted in the camera, the batteries can perform more efficiently.

The default setting is the type of batteries included with purchase.

## 📎 Alkaline Batteries

Performance of alkaline batteries may vary greatly depending on the manufacturer. Choose a reliable brand.

## Preparation 2 Insert a Memory Card

### 1 Turn off the camera and open the battery-chamber/memory card slot cover.

- Hold the camera upside down to prevent the batteries from falling out.

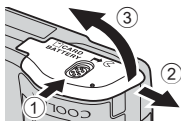

### 2 Insert the memory card.

- Slide the memory card in until it clicks into place.

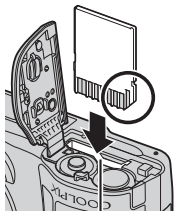

Memory card slot



#### **Be Careful to Insert the Memory Card in Correct Direction**

*Inserting the memory card upside down or backwards could damage the camera and the memory card.*



### 3 Close the battery-chamber/memory card slot cover.





## ✔ Formatting Memory Cards

The first time you insert a memory card that has been used in another device into this camera, make sure to format it with this camera. Insert the card into the camera, press the **MENU** button, and select **Format card** in the setup menu.

## Removing Memory Cards

Turn the camera off and make sure that the power-on lamp and the monitor have turned off, and then open the battery-chamber/memory card slot cover.

Gently push the memory card into the camera (①) to partially eject the card (②).

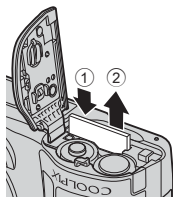

## ✔ High Temperature Caution

The camera, batteries, and memory card may be hot immediately after using the camera.

## Internal Memory and Memory Cards

Camera data, including images and movies, can be saved either in the camera's internal memory or on a memory card. To use the camera's internal memory, first remove the memory card.



## Preparation 3 Setting the Display Language, Date, and Time

When the camera is turned on for the first time, the language-selection screen and the date and time setting screen for the camera clock are displayed.

- If you exit without setting the date and time,  will flash when the shooting screen is displayed.

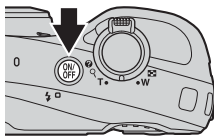
- Press the power switch to turn on the camera.



- Use the multi selector   to select the desired language and press the  button.

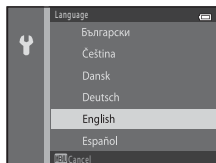

- Select **Yes** and press the  button.

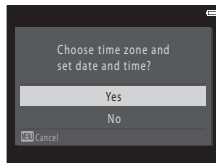

#### 4 Select your home time zone and press the **OK** button.

- To enable daylight saving time, press **▲**. When the daylight saving time function is enabled,  is displayed above the map. To turn off the daylight saving time function, press **▼**.

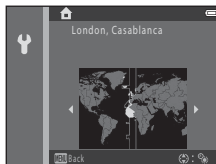

#### 5 Select the date format and press the **OK** button.

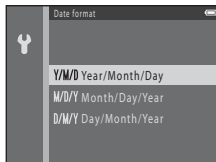

#### 6 Set the date and time, and press the **OK** button.

- Select a field: Press **◀▶** (changes between **D**, **M**, **Y**, hour, and minute).
- Edit the date and time: Press **▲▼**.
- Confirm the setting: Select the minute field and press the **OK** button.

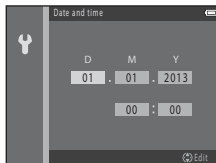

#### 7 Select **Yes** and press the **OK** button.

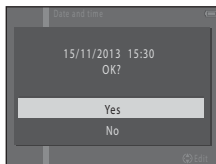

## 8 Press the button.

- The shooting-mode selection screen is displayed.







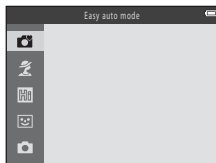

## 9 When **Easy auto mode** is displayed, press the button.

- The camera enters the shooting mode and you can take images in Easy auto mode (📖 20).
- To switch to another shooting mode, press ▲▼ before pressing the  button.





## Changing the Language Setting and the Date and Time Setting

- You can change these settings using the **Language** and **Time zone and date** settings in the  setup menu ( 69).
- You can enable or disable daylight saving time in the  setup menu by selecting **Time zone and date** followed by **Time zone**. Press the multi selector  and then  to enable daylight saving time and move the clock forward one hour, or  to disable daylight saving time and move the clock back one hour.

## The Clock Battery

- The camera's clock is powered by a built-in backup battery. The backup battery charges when the main batteries are inserted into the camera or when the camera is connected to an optional AC adapter, and it can run the clock for several days after about ten hours of charging.
- If the camera's backup battery becomes exhausted, the date and time setting screen is displayed when the camera is turned on. Set the date and time again. See step 3 ( 14) of "Preparation 3 Setting the Display Language, Date, and Time" for more information.

## Imprinting the Shooting Date on Printed Images

- You can permanently imprint the shooting date on images as they are captured by setting **Print date** in the setup menu ( 69).
- If you want the shooting date to be printed without using the **Print date** setting, print using the ViewNX 2 software ( 73).

# Step 1 Turn the Camera On

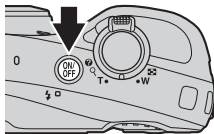

## 1 Press the power switch.

- The monitor turns on.
- To turn the camera off, press the power switch again.



## 2 Check the battery level indicator and the number of exposures remaining.

### Battery level indicator

Display	Description
	The battery level is high.
	The battery level is low.
<b>Battery exhausted.</b>	The camera cannot capture images. Replace the batteries.



### Battery level indicator



Number of exposures remaining

### Number of Exposures Remaining

The number of images that can be taken is displayed.





-  is displayed when no memory card is inserted in the camera, and images are saved in the internal memory.

## Notes About the Flash

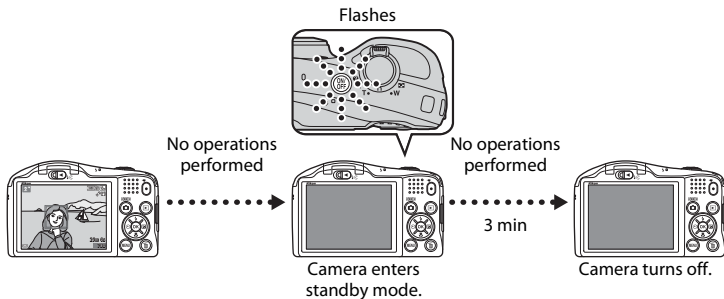
When you need to use the flash, such as when shooting in dark locations or when the subject is backlit, slide the  (flash pop-up) control to raise the flash ( 3, 41).

## The Auto Off Function





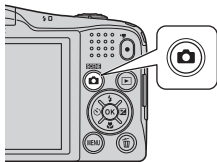

- The time that elapses before the camera enters standby mode is about one minute. The time can be changed using the **Auto off** setting in the setup menu ( 70).
- While the camera is in standby mode, the monitor turns back on if you perform any of the following operations:
  - Press the power switch, shutter-release button,  (shooting mode) button,  (playback) button, or  (movie-record) button

## Step 2 Select a Shooting Mode

- 1 Press the  button.



- 2 Use the multi selector   to select a shooting mode and press the  button.

-  (easy auto) mode is used in this example.
- The shooting mode setting is saved even after the camera is turned off.

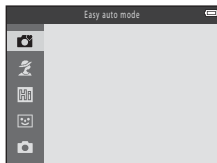



## Available Shooting Modes



### Easy auto mode

29

The camera automatically selects the optimum scene mode when you frame an image, making it even easier to take images using settings that suit the scene.



### Scene mode

30

Camera settings are optimized according to the scene that you select.



### Special effects

35

Effects can be applied to images during shooting.



### Smart portrait

37

When the camera detects a smiling face, you can take an image automatically without pressing the shutter-release button (smile timer). You can also use the skin softening option to smooth the skin tones of human faces.



### Auto mode

39

Used for general shooting. Settings can be adjusted to suit the shooting conditions and the type of shot you want to capture.

## Step 3 Frame a Picture

### 1 Hold the camera steady.

- Keep fingers and other objects away from the lens, flash, AF-assist illuminator, microphone, and speaker.

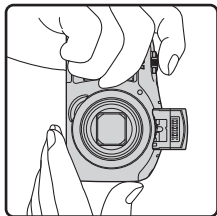
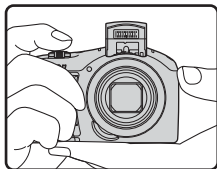

### 2 Frame the picture.

- When the camera automatically determines the scene mode, the shooting mode icon changes (📖 29).

Shooting mode icon

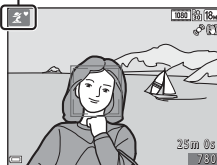

## ✓ Notes About Easy Auto Mode

- Depending upon shooting conditions, the camera may not select the desired scene mode. In this case, select another shooting mode (📖 30, 35, 37, 39).
- When the digital zoom is in effect, the scene mode changes to 📷.

## 📎 When Using a Tripod

- We recommend using a tripod to stabilize the camera in the following situations.
  - When shooting in dim lighting
  - When the flash is lowered or when using a shooting mode in which the flash does not fire
  - When using the telephoto setting
- When using a tripod to stabilize the camera during shooting, set **Vibration reduction** to **Off** in the setup menu (📖 69) to prevent potential errors caused by this function.

## Using the Zoom

When you move the zoom control, the zoom lens position changes.

- To zoom in closer to the subject: Move toward **T** (telephoto)
- To zoom out and view a larger area: Move toward **W** (wide-angle)

When you turn the camera on, the zoom moves to the maximum wide-angle position.

- The zoom operates quickly when you rotate the zoom control fully (except when recording movies).
- A zoom indicator is displayed at the top of the monitor when the zoom control is moved.
- Digital zoom, which allows you to further magnify the subject up to approximately 2x the maximum optical zoom ratio, can be activated by moving and holding the zoom control toward **T** when the camera is zoomed in to the maximum optical zoom position.

Zoom out **W**      **T** Zoom in

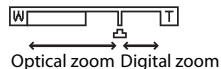
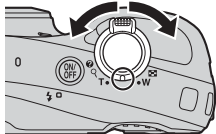

## 📎 Digital Zoom and Interpolation

While using digital zoom, the image quality decreases due to interpolation when the zoom is increased beyond the 📷 position. The position of 📷 moves to the right as the size of an image decreases.



Small image size

## Step 4 Focus and Shoot

### 1 Press the shutter-release button halfway.

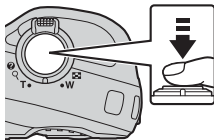

- When the subject is in focus, the focus area glows green (multiple focus areas can glow green).
- When you are using digital zoom, the camera focuses on the subject in the center of the frame and the focus area is not displayed. When the camera has focused, the focus indicator (  ) glows green.
- If the focus area or focus indicator flashes, the camera is unable to focus. Modify the composition and try pressing the shutter-release button halfway again.



### 2 Without lifting your finger, press the shutter-release button the rest of the way down.



## The Shutter-release Button

<p>Press halfway</p> 	<p>To set focus and exposure (shutter speed and aperture value), press the shutter-release button lightly until you feel a slight resistance. Focus and exposure remain locked while the shutter-release button is pressed halfway.</p>
<p>Press all the way</p> 	<p>Press the shutter-release button all the way to release the shutter and take an image. Do not use force when pressing the shutter-release button, as this may result in camera shake and blurred images. Press the button gently.</p>

### Notes About Saving Images and Recording Movies

The indicator showing the number of exposures remaining or the indicator showing the maximum movie length flashes while images are being saved or while a movie is being recorded. **Do not open the battery-chamber/memory card slot cover or remove the batteries or memory card** while an indicator is flashing. Doing this could result in loss of data, or in damage to the camera or the memory card.



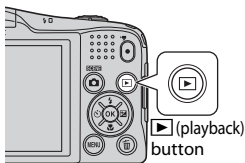

## Step 5 Play Back Images

### 1 Press the (playback) button.

- If you press and hold down the  (playback) button while the camera is turned off, the camera turns on in playback mode.



### 2 Use the multi selector to select an image to display.

- Press and hold down  to scroll through the images quickly.
- To return to shooting mode, press the  button or shutter-release button.

Display the previous image







Display the next image

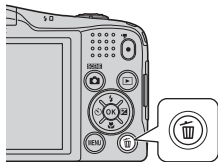

## Step 6 Delete Images

- 1 Press the  button to delete the image currently displayed in the monitor.



- 2 Use the multi selector   to select the desired deletion method and press the  button.

- To exit without deleting, press the **MENU** button.

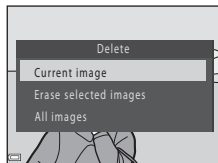

- 3 Select **Yes** and press the  button.

- Deleted images cannot be recovered.
- To cancel, select **No** and press the  button.

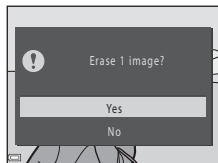

## Operating the Erase Selected Images Screen

**1** Use the multi selector ◀▶ to select an image to be deleted, and then use ▲ to display 🗑️.

- To undo the selection, press ▼ to remove 🗑️.
- Move the zoom control (📐 1) toward **T** (🔍) to switch to full-frame playback or **W** (🖼️) to switch to thumbnail playback.



**2** Add 🗑️ to all images that you want to delete and then press the **OK** button to confirm the selection.

- A confirmation dialog is displayed. Follow the instructions displayed in the monitor.

### ✓ Deleting Images in a Sequence

- If you press the 🗑️ button and delete a key picture while only key pictures are displayed for sequences of images (📖 62), all images in the sequence, including the key picture, are deleted.
- To delete individual images in a sequence, press the **OK** button to display them one at a time and press the 🗑️ button.

### ✍️ Deleting the Last Image Captured While in Shooting Mode



When using shooting mode, press the 🗑️ button to delete the last image that was saved.



# Shooting Features











## (Easy Auto) Mode

The camera automatically selects the optimum scene mode when you frame an image, making it even easier to take images using settings that suit the scene.

Enter shooting mode →  (shooting mode) button →  (easy auto) mode →  button

### Automatic Scene Selection

When the camera selects a scene mode, the shooting mode icon displayed in the shooting screen changes to that for the scene mode currently enabled.









	Portrait (close-ups of one or two people)
	Portrait (shots of three or more people, shots with large areas of background)
	Landscape
	Night portrait (close-ups of one or two people)
	Night portrait (shots of three or more people, shots with large areas of background)
	Night landscape
	Close-up
	Backlighting (shots with no people in them)
	Backlighting (shots with people in them)
	Other scenes

### Functions Available in (Easy Auto) Mode

















- Self-timer (📖 44)
- Exposure compensation (📖 47)
- Easy auto mode menu (📖 50)

## Scene Mode (Shooting Suited to Scenes)

When a scene is selected, camera settings are automatically optimized for the selected scene.

Enter shooting mode →  (shooting mode) button →  (second icon from the top\*) →      → select a scene →  button

\* The icon of the last scene selected is displayed.



 Portrait (default setting)	 Landscape <sup>2</sup>	 Sports <sup>1</sup> (  31)	 Night portrait (  31)
 Party/indoor <sup>1</sup> (  31)	 Beach <sup>1</sup>	 Snow <sup>1</sup>	 Sunset <sup>1,3</sup>
 Dusk/dawn <sup>2,3</sup>	 Night landscape <sup>2</sup> (  32)	 Close-up <sup>1</sup> (  32)	 Food <sup>1</sup> (  32)
 Museum <sup>1</sup> (  33)	 Fireworks show <sup>2,3</sup> (  33)	 Black and white copy <sup>1</sup> (  33)	 Backlighting <sup>1</sup> (  33)
 Easy panorama <sup>1</sup> (  33)	 Pet portrait (  34)		

<sup>1</sup> The camera focuses on the area in the center of the frame.

<sup>2</sup> The camera focuses at infinity.

<sup>3</sup> Use of a tripod is recommended, because the shutter speed is slow. Set **Vibration reduction** to **Off** in the setup menu ( 69) when using a tripod to stabilize the camera during shooting.

### To View a Description (Help Display) of Each Scene

Select a scene and move the zoom control ( 1) toward **T** () to view a description of that scene. To return to the original screen, move the zoom control toward **T** () again.

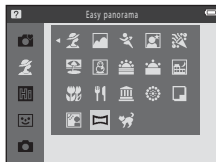



## Tips and Notes

### Sports

- While the shutter-release button is held all the way down, the camera shoots up to about 6 images continuously at a rate of about 2 fps (when **Image mode** is set to  **4896×3672**).
- The frame rate for continuous shooting may vary depending upon the current image mode setting, the memory card used, or shooting condition.
- Focus, exposure, and hue are fixed at the values determined with the first image in each series.



### Night portrait

- The flash always fires. Raise the flash before shooting.
- From the screen displayed after  **Night portrait** is selected, select **Hand-held** or **Tripod**.
- **Hand-held** (default setting):
  - When the  icon at the top left of the monitor glows green, press the shutter-release button all the way to capture a series of images which are combined into a single image and saved.
  - Once the shutter-release button is pressed all the way, hold the camera still until a still image is displayed. After taking an image, do not turn the camera off before the monitor switches to the shooting screen.
  - If the subject moves while the camera is shooting continuously, the image may be distorted, overlapped, or blurred.
- **Tripod**:
  - One image is captured at a slow shutter speed when the shutter-release button is pressed all the way.
  - Vibration reduction is disabled even when **Vibration reduction** ( 69) in the setup menu is set to **On**.

### Party/indoor

- To avoid the effects of camera shake, hold the camera steady. Set **Vibration reduction** to **Off** in the setup menu ( 69) when using a tripod to stabilize the camera during shooting.



## Night landscape

- From the screen displayed after  **Night landscape** is selected, select **Hand-held** or **Tripod**.
- Hand-held** (default setting):
  - When the  icon at the top left of the monitor glows green, press the shutter-release button all the way to capture a series of images which are combined into a single image and saved.
  - Once the shutter-release button is pressed all the way, hold the camera still until a still image is displayed. After taking an image, do not turn the camera off before the monitor switches to the shooting screen.
- Tripod:**
  - One image is captured at a slow shutter speed when the shutter-release button is pressed all the way.
  - Vibration reduction is disabled even when **Vibration reduction** ( 69) in the setup menu is set to **On**.

## Close-up

- Macro mode ( 46) is enabled and the camera automatically zooms to the closest position at which it can focus.

## Food

- Macro mode ( 46) is enabled and the camera automatically zooms to the closest position at which it can focus.
- You can adjust hue by using the multi selector  . The hue setting is saved in the camera's memory even after the camera is turned off.



## Museum

- The camera captures a series of up to ten images while the shutter-release button is held all the way down, and the sharpest image in the series is automatically selected and saved (BSS (Best Shot Selector)).
- The flash does not fire.

## Fireworks show

- The shutter speed is fixed at about four seconds.
- Six zoom positions are available.



## Black and white copy

- Use together with macro mode ( 46) when shooting subjects that are close to the camera.

## Backlighting

- The flash always fires. Raise the flash before shooting.

## Easy panorama

- From the screen displayed after  **Easy panorama** is selected, select the shooting range from **Normal (180°)** or **Wide (360°)**.
- The zoom position is fixed at wide-angle.
- Press the shutter-release button all the way down, remove your finger from the button, and then slowly pan the camera horizontally. Shooting ends when the camera captures the specified shooting range.
- Focus and exposure are locked when shooting starts.
- If you press the  button when a captured image is displayed in full-frame playback mode, the image scrolls automatically.
- The images cannot be edited on this camera.

See "Using Easy Panorama (Shooting and Playback)" ( 2) for more information.



## **Notes About Printing Panorama Images**

The entire image may not be able to be printed depending on the printer's settings. Additionally, printing may not be possible depending on the printer.

## Pet portrait

- When you point the camera at a dog or cat, the camera detects the pet's face and focuses on it. By default, the shutter is automatically released when focus is acquired (pet portrait auto release).
- From the screen displayed after  **Pet portrait** is selected, select **Single** or **Continuous**.
  - **Single**: Whenever the detected face is in focus, the camera captures one image.
  - **Continuous**: Whenever the detected face is in focus, the camera captures three images continuously.

## **Pet Portrait Auto Release**

- Press the multi selector  to change the **Pet portrait auto release** settings.
  - : The camera detects a dog or cat face and automatically releases the shutter when the detected face is in focus.
  - **OFF**: The camera does not release the shutter automatically, even if a dog or cat face is detected. Press the shutter-release button. The camera also detects human faces when **OFF** is selected.
- **Pet portrait auto release** is set to **OFF** after five bursts have been taken.
- Shooting is also possible by pressing the shutter-release button, regardless of the **Pet portrait auto release** setting. When **Continuous** is selected, you can take images continuously while holding down the shutter-release button all the way.

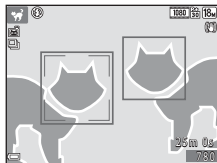

## **Focus Area**

- When the camera detects a face, the face is displayed inside a yellow border. When the camera acquires focus on a face displayed inside a double border (focus area), the double border turns green. If no faces are detected, the camera focuses on the subject in the center of the frame.
- In some shooting conditions, the pet face may not be detected and other subjects may be displayed inside a border.







## Special Effects Mode (Applying Effects When Shooting)

Effects can be applied to images during shooting.

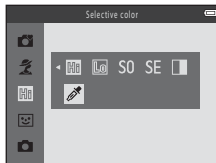
Enter shooting mode →  (shooting mode) button →  (third icon from the top\*) →  
▶▶▶▲▼◀▶▶ → select an effect →  button

\* The icon of the last effect selected is displayed.



Category	Description
 High key (default setting)	Gives the entire image a bright tone.
 Low key	Gives the entire image a dark tone.
<b>S0</b> Soft	Softens the image by adding a slight blur to the entire image.
<b>SE</b> Nostalgic sepia	Adds a sepia tone and reduces the contrast to simulate the qualities of an old photograph.
 High-contrast monochrome	Changes the image to black and white and gives it sharp contrast.
 Selective color	Creates a black and white image in which only the specified color remains.

- The camera focuses on the area in the center of the frame.
- When **Selective color** is selected, use the multi selector ▲▼ to select the desired color from the slider.

To change settings for any of the following functions, press the **OK** button to cancel color selection.

- Flash mode (📖 41)
- Self-timer (📖 44)
- Macro mode (📖 46)
- Exposure compensation (📖 47)

To return to the color selection screen, press the **OK** button again.





Slider



## Smart Portrait Mode (Capturing Images of Smiling Faces)

When the camera detects a smiling face, you can take an image automatically without pressing the shutter-release button (smile timer (📖 51)). You can use the skin softening option to smooth the skin tones of human faces.

Enter shooting mode →  (shooting mode) button →  Smart portrait mode →  button

### 1 Frame the picture.

- Point the camera at a human face.

### 2 Without pressing the shutter-release button, wait for the subject to smile.

- If the camera detects that the face framed by the double border is smiling, the shutter is automatically released.
- Whenever the camera detects a smiling face, it automatically releases the shutter.

### 3 End automatic shooting.

- Perform one of the operations listed below to end shooting.
  - Set **Smile timer** to **Off**.
  - Press the  button and select a different shooting mode.

### Notes About Smart Portrait Mode

Under some shooting conditions, the camera may be unable to detect faces or detect smiles (📖 54). The shutter-release button can also be used for shooting.

### When the Self-timer Lamp Flashes



When using smile timer, the self-timer lamp flashes when the camera detects a face and flashes quickly immediately after the shutter is released.



## Functions Available in Smart Portrait Mode

- Flash mode (📖 41)
- Self-timer (📖 44)
- Exposure compensation (📖 47)
- Smart portrait menu (📖 50)





## (Auto) Mode

Used for general shooting. Settings can be adjusted to suit the shooting conditions and the type of shot you want to capture.

Enter shooting mode →  (shooting mode) button →  (auto) mode →  button

- You can change how the camera selects the area of the frame to focus on by changing the **AF area mode** setting ( 51).  
The default setting is **Target finding AF** ( 56).

### Functions Available in (Auto) Mode

- Flash mode ( 41)
- Self-timer ( 44)
- Macro mode ( 46)
- Exposure compensation ( 47)
- Shooting menu ( 50)

## Functions That Can Be Set Using the Multi Selector

The functions that are available vary with the shooting mode, as shown below.

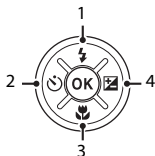

		(easy auto)	Scene	Special effects	Smart portrait	(auto)
1	Flash mode <sup>1</sup> (📖 41)	–	2		<sup>2</sup>	
2	Self-timer (📖 44)				<sup>2</sup>	
3	Macro (📖 46)	–			–	
4	Exposure compensation (📖 47)					

<sup>1</sup> Can be set when the flash is raised. The flash does not fire while it is lowered.

<sup>2</sup> Availability depends on the setting.

## Using the Flash

In dark locations or when the subject is backlit, you can take images with the flash by raising the flash.

When using  (auto) mode and other shooting modes, you can select the flash mode to match the shooting conditions.

### 1 Slide the (flash pop-up) control.

- The flash pops up.
- The flash does not fire while it is lowered.  is displayed to indicate that the flash does not fire.

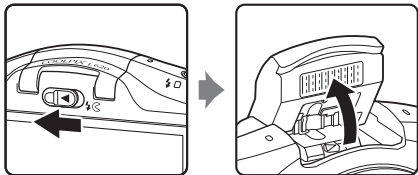

### 2 Press the multi selector (⚡).



### 3 Select the desired flash mode ( 42) and press the button.

- If a setting is not applied by pressing the  button within a few seconds, the selection will be canceled.

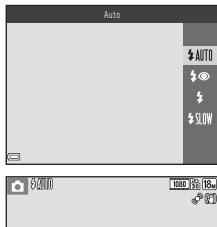

## Available Flash Modes

### AUTO Auto

The flash fires when necessary, such as in dim lighting.

- The flash mode icon on the shooting screen is displayed only immediately after the setting is made.

### Auto with red-eye reduction

Reduce red-eye in portraits caused by the flash ( 43).

### Fill flash

The flash fires whenever an image is taken. Use to “fill-in” (illuminate) shadows and backlit subjects.

### SLOW Slow sync

Suited to evening and night portraits that include background scenery. The flash fires when necessary to illuminate the main subject; slow shutter speeds are used to capture background at night or under dim lighting.

- Lower the flash when you do not want the flash to fire.

## ✓ Lowering the Flash

Push the flash down gently to lower the flash until it clicks into place when not in use (📖 3).

## 📎 The Flash Lamp

The status of the flash can be confirmed by pressing the shutter-release button halfway.

- On: The flash fires when you press the shutter-release button all the way down.
- Flashing: The flash is charging. The camera cannot shoot images.
- Off: The flash does not fire when an image is taken.

If the battery level is low, the monitor turns off while the flash is charging.

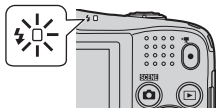

## 📎 The Flash Mode Setting

- The setting may not be available with some shooting modes.
- The setting applied in 📷 (auto) mode is saved in the camera's memory even after the camera is turned off.

## 📎 Red-eye Reduction

If the camera detects red eye while saving an image, the affected area is processed to reduce red-eye before the image is saved.

Note the following when shooting:

- More time than usual is required to save images.
- Red-eye reduction may not produce the desired results in all situations.
- In some cases, red-eye reduction may be applied to areas of an image unnecessarily. In these cases, select another flash mode and take the image again.

## Using the Self-timer

The camera is equipped with a self-timer that releases the shutter about ten seconds after you press the shutter-release button.

Set **Vibration reduction** to **Off** in the setup menu (📖 69) when using a tripod to stabilize the camera during shooting.

- 1 Press the multi selector ◀ (🕒).



- 2 Select **ON** and press the **OK** button.

- If a setting is not applied by pressing the **OK** button within a few seconds, the selection will be canceled.
- When the shooting mode is **Pet portrait** scene mode, 📷 (pet portrait auto release) is displayed (📖 34). The self-timer cannot be used.



- 3 Frame the picture and press the shutter-release button halfway.

- Focus and exposure are set.

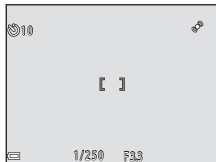



## 4 Press the shutter-release button the rest of the way down.

- Countdown starts. The self-timer lamp flashes and then glows steadily about one second before the shutter is released.
- When the shutter is released, the self-timer is set to **OFF**.
- To stop the countdown, press the shutter-release button again.

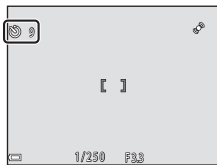

## Using Macro Mode

Use macro mode when taking close-up images.

- 1 Press the multi selector ▼ (👉).



- 2 Select **ON** and press the **OK** button.

- If a setting is not applied by pressing the **OK** button within a few seconds, the selection will be canceled.

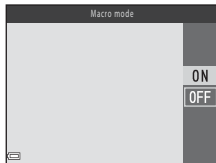

- 3 Move the zoom control to set the zoom ratio to a position where 👉 and the zoom indicator glow green.



- When the zoom ratio is set to a position where 👉 and the zoom indicator glow green, the camera can focus on subjects as close as approximately 10 cm (4 in.) from the lens. When the zoom is at the position where 👉 is displayed, the camera can focus on subjects as close as approximately 1 cm (0.4 in.) from the lens.

### ✓ Notes About Using the Flash

The flash may be unable to light the entire subject at distances of less than 50 cm (1 ft 8 in.).

### 📎 The Macro Mode Setting

- The setting may not be available with some shooting modes.
- The setting applied in 📷 (auto) mode is saved in the camera's memory even after the camera is turned off.

# Adjusting Brightness (Exposure Compensation)

You can adjust overall image brightness.

**1** Press the multi selector ► (📷).



**2** Select a compensation value and press the **OK** button.

- To brighten the image, set a positive (+) value.
- To darken the image, set a negative (-) value.
- The compensation value is applied, even without pressing the **OK** button.

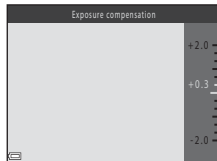





































## Exposure Compensation Value

The setting applied in  (auto) mode is saved in the camera's memory even after the camera is turned off.

## Default Settings

Default settings for each shooting mode are described below.

	Flash <sup>1</sup> (  41)	Self-timer (  44)	Macro (  46)	Exposure compensation (  47)
 (easy auto)	 AUTO <sup>2</sup>	Off	Off <sup>3</sup>	0.0
<b>Scene</b>				
 (portrait)	 	Off	Off <sup>4</sup>	0.0
 (landscape)	 <sup>4</sup>	Off	Off <sup>4</sup>	0.0
 (sports)	 <sup>4</sup>	Off <sup>4</sup>	Off <sup>4</sup>	0.0
 (night portrait)	  <sup>5</sup>	Off	Off <sup>4</sup>	0.0
 (party/indoor)	  <sup>6</sup>	Off	Off <sup>4</sup>	0.0
 (beach)	 AUTO	Off	Off <sup>4</sup>	0.0
 (snow)	 AUTO	Off	Off <sup>4</sup>	0.0
 (sunset)	 <sup>4</sup>	Off	Off <sup>4</sup>	0.0
 (dusk/dawn)	 <sup>4</sup>	Off	Off <sup>4</sup>	0.0
 (night landscape)	 <sup>4</sup>	Off	Off <sup>4</sup>	0.0
 (close-up)	 <sup>4</sup>	Off	On <sup>4</sup>	0.0
 (food)	 <sup>4</sup>	Off	On <sup>4</sup>	0.0
 (museum)	 <sup>4</sup>	Off	Off	0.0
 (fireworks show)	 <sup>4</sup>	Off <sup>4</sup>	Off <sup>4</sup>	0.0 <sup>4</sup>
 (black and white copy)	 <sup>4</sup>	Off	Off	0.0
 (backlighting)	 <sup>4</sup>	Off	Off <sup>4</sup>	0.0
 (easy panorama)	 <sup>4</sup>	Off <sup>4</sup>	Off <sup>4</sup>	0.0
 (pet portrait)	 <sup>4</sup>	 <sup>7</sup>	Off	0.0
 (special effects)	 AUTO	Off	Off	0.0
 (smart portrait)	 AUTO <sup>8</sup>	Off <sup>9</sup>	Off <sup>4</sup>	0.0
 (auto)	 AUTO	Off	Off	0.0

- 1 The setting that is used when the flash is raised.
- 2 The setting cannot be changed. The camera automatically selects the flash mode appropriate for the scene it has selected.
- 3 The setting cannot be changed. Automatically changes to macro mode when the camera selects **Close-up**.
- 4 The setting cannot be changed.
- 5 The setting cannot be changed. The flash mode setting is fixed at fill flash with slow sync and red-eye reduction.
- 6 Slow sync with red-eye reduction flash mode may be used.
- 7 Self-timer cannot be used. Pet portrait auto release can be turned on or off (📖 34).
- 8 Cannot be used when **Blink proof** is set to **On** or when **Smile timer** is set to **On (BSS)**.
- 9 Can be set when **Smile timer** is set to **Off**.

## Functions That Can Be Set with the MENU Button (Shooting Menu)

The settings listed below can be changed by pressing the **MENU** button during shooting.

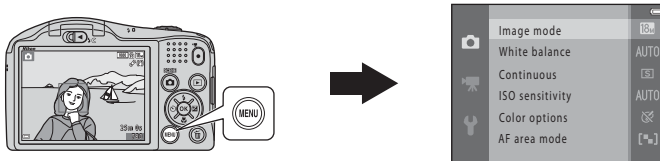













The settings that can be changed vary depending on the shooting mode, as shown below.

	Easy auto mode	Scene	Special effects	Smart portrait	Auto mode
Image mode*	✓	✓	✓	✓	✓
White balance	-	-	-	-	✓
Continuous	-	-	-	-	✓
ISO sensitivity	-	-	-	-	✓
Color options	-	-	-	-	✓
AF area mode	-	-	-	-	✓
Skin softening	-	-	-	✓	-
Smile timer	-	-	-	✓	-
Blink proof	-	-	-	✓	-



\* The setting is also applied to other shooting modes.

## Options Available in the Shooting Menu

Option	Description	
Image mode	Allows you to set the combination of image size and image quality used when saving images. <ul style="list-style-type: none"><li>• Default setting:  <b>4896x3672</b></li></ul>	 33
White balance	Allows you to adjust white balance to suit the weather conditions or light source in order to make the colors in images match what you see with your eyes. <ul style="list-style-type: none"><li>• Default setting: <b>Auto</b></li></ul>	 35
Continuous	Allows you to select <b>single</b> or continuous shooting. <ul style="list-style-type: none"><li>• Default setting: <b>Single</b></li></ul>	 38
ISO sensitivity	Allows you to control the camera's sensitivity to light. <ul style="list-style-type: none"><li>• Default setting: <b>Auto</b></li></ul> When <b>Auto</b> is selected,  is displayed in the monitor while shooting if ISO sensitivity increases.	 40
Color options	Allows you to change the color tones of images. <ul style="list-style-type: none"><li>• Default setting: <b>Standard color</b></li></ul>	 41
AF area mode	Allows you to determine how the camera selects the focus area that is used for autofocus. <ul style="list-style-type: none"><li>• Default setting: <b>Target finding AF</b> ( 56)</li></ul>	 42
Skin softening	Allows you to make the skin tones in human faces smoother. <ul style="list-style-type: none"><li>• Default setting: <b>On</b></li></ul>	 43
Smile timer	Allows you to select whether or not the camera automatically releases the shutter when it detects a human smiling face. <ul style="list-style-type: none"><li>• Default setting: <b>On (BSS)</b></li></ul>	 44
Blink proof	The camera automatically releases the shutter twice with every shot and saves one image in which the subject's eyes are open. <ul style="list-style-type: none"><li>• Default setting: <b>Off</b></li></ul>	 45

## Functions That Cannot Be Used Simultaneously

Some functions cannot be used with other menu options.

Restricted function	Option	Description
Flash mode	Continuous (📖 51)	When a setting other than <b>Single</b> is selected, the flash cannot be used.
	Smile timer (📖 51)	When <b>On (BSS)</b> is selected, the flash cannot be used.
	Blink proof (📖 51)	When <b>Blink proof</b> is set to <b>On</b> , the flash cannot be used.
Self-timer	Smile timer (📖 51)	When <b>Smile timer</b> is selected, the self-timer cannot be used.
Image mode	Continuous (📖 51)	<p><b>Image mode</b> is set as follows depending on the continuous shooting setting:</p> <ul style="list-style-type: none"> <li>• <b>Continuous H: 120 fps:</b>   (image size: 640 × 480 pixels)</li> <li>• <b>Continuous H: 60 fps:</b>   (image size: 1920 × 1080 pixels)</li> <li>• <b>Multi-shot 16:</b>   (image size: 2560 × 1920 pixels)</li> </ul>
White balance	Color options (📖 51)	When <b>Black-and-white</b> , <b>Sepia</b> , or <b>Cyanotype</b> is selected, the <b>White balance</b> setting is fixed at <b>Auto</b> .
ISO sensitivity	Continuous (📖 51)	When <b>Continuous H: 120 fps</b> , <b>Continuous H: 60 fps</b> , or <b>Multi-shot 16</b> is selected, the <b>ISO sensitivity</b> setting is automatically specified according to the brightness.
AF area mode	White balance (📖 51)	When a setting other than <b>Auto</b> is selected for <b>White balance</b> in <b>Target finding AF</b> mode, the camera does not detect the main subject.
Smile timer	Blink proof (📖 51)	When <b>Smile timer</b> is set to <b>On (BSS)</b> , it changes and is fixed at <b>On (single)</b> if <b>Blink proof</b> is set to <b>On</b> .



Restricted function	Option	Description
Blink proof	Smile timer (📖 51)	When <b>Smile timer</b> is set to <b>On (BSS)</b> , <b>Blink proof</b> is fixed at <b>Off</b> .
Print date	Continuous (📖 51)	When <b>Continuous H: 120 fps</b> or <b>Continuous H: 60 fps</b> is selected, date and time cannot be imprinted on images.
Motion detection	Flash mode (📖 41)	When the flash fires, <b>Motion detection</b> is disabled.
	Continuous (📖 51)	When a setting other than <b>Single</b> is selected, <b>Motion detection</b> is disabled.
	ISO sensitivity (📖 51)	When the ISO sensitivity is set to any setting other than <b>Auto</b> , <b>Motion detection</b> is disabled.
	Smile timer (📖 51)	When <b>On (BSS)</b> is selected, <b>Motion detection</b> is disabled.
Digital zoom	Continuous (📖 51)	When <b>Multi-shot 16</b> is selected, digital zoom cannot be used.
Shutter sound	Continuous (📖 51)	When a setting other than <b>Single</b> is selected, the shutter sound is disabled.

### ✔ Notes About Digital Zoom

- Depending on the shooting mode or the current settings, digital zoom may not be available (📷70).
- When digital zoom is in effect, the camera focuses in the center of the frame.

# Focusing

The focus area varies depending on the shooting mode.

## Using Face Detection

In the following shooting modes, the camera uses face detection to automatically focus on human faces.

- **Portrait**, **Night portrait**, or **Backlighting** in (easy auto) mode (29)
- **Portrait** or **Night portrait** in scene mode (30)
- Smart portrait mode (37)

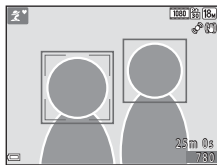

If the camera detects more than one face, a double border is displayed around the face that the camera focuses on, and single borders are displayed around the other faces.

If no faces are detected when the shutter-release button is pressed halfway, the camera focuses on the subject in the center of the frame.

### ✓ Notes About Face Detection

- The camera's ability to detect faces depends on a variety of factors, including the direction in which the faces are looking.
- The camera may be unable to detect faces in the following situations:
  - When faces are partially hidden by sunglasses or otherwise obstructed
  - When faces take up too much or too little of the frame

## Using Skin Softening

When the shutter is released while using one of the shooting modes listed below, the camera detects human faces and processes the image to soften facial skin tones (up to three faces).

- Smart portrait mode (📖 37)
-  **Portrait**,  **Night portrait**, or  **Backlighting** in  (easy auto) mode (📖 29)
- **Portrait** or **Night portrait** in scene mode (📖 30)

**Skin softening** can also be applied to saved images (📖 61, 📷 17).

### **Notes About Skin Softening**

- It may take more time than usual to save images after shooting.
- Under some shooting conditions, the desired skin softening results may not be achieved, and skin softening may be applied to areas of the image where there are no faces.

## Using Target Finding AF

When **AF area mode** (📖 51) in 📷 (auto) mode is set to **Target finding AF**, the camera focuses in the manner described below when you press the shutter-release button halfway:

- The camera detects the main subject and focuses on it. When the subject is in focus, the focus area glows green. If a human face is detected, the camera automatically sets focus priority on it.
- If no main subject is detected, the camera automatically selects one or more of the nine focus areas containing the subject closest to the camera. When the subject is in focus, the focus areas that are in focus glow green.

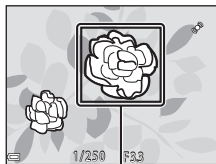

Focus area

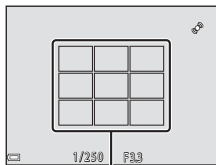

Focus areas

### ✓ Notes About Target Finding AF

- Depending on shooting conditions, the subject that the camera determines to be the main subject may vary.
- The main subject may not be detected when using certain **White balance** settings.
- The camera may not detect the main subject appropriately in the following situations:
  - When the subject is very dark or bright
  - When the main subject lacks clearly defined colors
  - When the shot is framed so that the main subject is at the edge of the monitor
  - When the main subject is composed of a repeating pattern

## Subjects Not Suitable for Autofocus

The camera may not focus as expected in the following situations. In some rare cases, the subject may not be in focus despite the fact that the focus area or the focus indicator glows green:

- Subject is very dark
- Objects of sharply differing brightness are included in the scene (e.g. the sun behind the subject makes that subject appear very dark)
- No contrast between the subject and surroundings (e.g. a portrait subject wearing a white shirt is standing in front of a white wall)
- Several objects are at different distances from the camera (e.g. the subject inside a cage)
- Subjects with repeating patterns (window blinds, buildings with multiple rows of similarly shaped windows, etc.)
- Subject is moving rapidly

In the situations noted above, try pressing the shutter-release button halfway to refocus several times, or focus on another subject positioned at the same distance from the camera as the actual desired subject, and use focus lock ( 58).

## Focus Lock

Focus lock shooting is recommended when the camera does not activate the focus area that contains the desired subject.

**1** Set **AF area mode** to **Center** in  (auto) mode ( 51).

**2** Position the subject in the center of the frame and press the shutter-release button halfway.

- Confirm that the focus area glows green.
- Focus and exposure are locked.

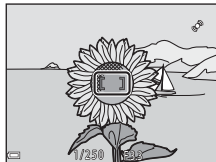

**3** Without lifting your finger, recompose the picture.

- Make sure to maintain the same distance between the camera and the subject.

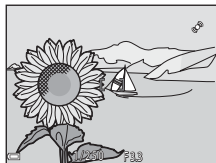

**4** Press the shutter-release button the rest of the way down to take the picture.



# Playback Features

## Playback Zoom

Moving the zoom control toward **T** (📄) in full-frame playback mode (📖 26) zooms in on the image.

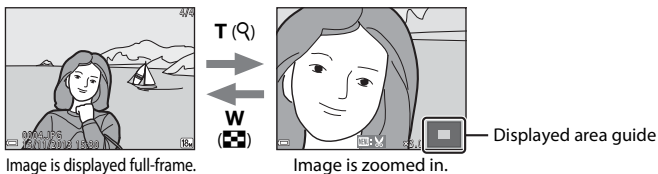

- You can change the zoom ratio by moving the zoom control toward **W** (📐) or **T** (📄).
- To view a different area of the image, press the multi selector ▲▼◀▶.
- If you are viewing an image that was captured using face detection or pet detection, the camera zooms in on the face detected at the time of shooting (except when viewing an image captured in a series). To zoom in on an area of the image where there are no faces, adjust the magnification rate and then press ▲▼◀▶.
- When a zoomed image is displayed, press the **OK** button to return to full-frame playback mode.

### Cropping Images

When a zoomed image is displayed, you can press the **MENU** button to crop the image to include only the visible portion and save it as a separate file (🔧21).

# Thumbnail Playback, Calendar Display

Moving the zoom control toward **W** (📐) in full-frame playback mode (📖 26) displays images as thumbnails.



- You can change the number of thumbnails displayed by moving the zoom control toward **W** (📐) or **T** (🔍).
- While using thumbnail playback mode, press the multi selector ▲▼◀▶ to select an image and then press the **OK** button to display that image full-frame.
- While using calendar display mode, press ▲▼◀▶ to select a date and then press the **OK** button to display the images captured on that day.













## ✓ Notes About Calendar Display







Images captured when the camera's date is not set are treated as images captured on January 1, 2013.



## Functions That Can Be Set with the MENU Button (Playback Menu)

When viewing images in full-frame playback mode or thumbnail playback mode, you can configure the menu operations listed below by pressing the **MENU** button.

Option	Description	
Quick retouch*	Allows you to create retouched copies in which contrast and saturation have been enhanced.	 15
D-Lighting*	Allows you to create copies with enhanced brightness and contrast, brightening dark portions of an image.	 15
Red-eye correction*	Corrects the red-eye effect that sometimes appears in the eyes when shooting using the flash.	 16
Skin softening*	The camera detects human faces in images and creates a copy with softer facial skin tones.	 17
Filter effects*	Digital filter effects can be used to apply a variety of effects to images.	 18
Print order	Allows you to select which images are printed, and how many copies of each image are printed, prior to printing.	 46
Slide show	Allows you to view images in an automatic slide show.	 50
Protect	Protects selected images from accidental deletion.	 51
Rotate image	Allows you to rotate the displayed image to portrait or landscape orientation.	 53
Small picture*	Creates a small copy of images.	 20
Voice memo	Allows you to use the camera's microphone to record voice memos and attach them to images.	 54
Copy	Allows you to copy images between the internal memory and a memory card.	 55

Option	Description	
Sequence display options	<p>Allows you to select whether to display only the key picture for a sequence of images captured continuously, or to display the sequence as individual images.</p> <ul style="list-style-type: none"> <li>When only the key picture is displayed for a sequence, press the  button to display each image in the sequence. Press the multi selector  to return to the key picture display.</li> </ul>	 57
Choose key picture	Allows you to change the key picture for images captured in sequence.	 57
Favorite pictures	Allows you to add images to an album. This option is not displayed in favorite pictures mode.	 6
Remove from favorites	Allows you to remove images from an album. This option is displayed only in favorite pictures mode.	 8

\* Edited images are saved as separate files. Some images may not be edited.

# Recording and Playing Back Movies

## Recording Movies

### 1 Display the shooting screen.

- Check the remaining amount of movie recording time.
- If **Photo info** in **Monitor settings** (📖 69) in the setup menu is set to **Movie frame+auto info**, the area that will be visible in the movie can be confirmed before movie recording starts.



Movie recording time remaining

### 2 Press the (movie-record) button to start movie recording.

- The camera focuses on the subject in the center of the frame.

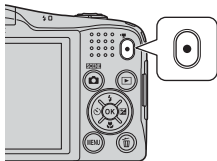

### 3 Press the (movie-record) button again to end recording.

## ✓ Maximum Movie Length

Individual movie files cannot exceed 4 GB in size or 29 minutes in length, even when there is sufficient free space on the memory card for longer recording.

- The maximum movie length for a single movie is displayed on the shooting screen.
- Recording may end before either limit is reached if camera temperature becomes elevated.
- The actual movie length may vary depending on the movie content, subject movement, or type of memory card.

## ✓ Notes About Saving Images and Recording Movies

The indicator showing the number of exposures remaining or the indicator showing the maximum movie length flashes while images are being saved or while a movie is being recorded. **Do not open the battery-chamber/memory card slot cover or remove the batteries or memory card** while an indicator is flashing. Doing this could result in loss of data, or in damage to the camera or the memory card.

## ✓ Notes About Movie Recording

- Memory cards with an SD Speed Class rating of 6 or faster are recommended when recording movies (Ⓢ:20). Movie recording may stop unexpectedly when memory cards with a lower Speed Class rating are used.
- There may be some degradation in image quality when digital zoom is used.
- The sounds of zoom control operation, zoom, autofocus lens drive movement, vibration reduction, and aperture operation when brightness changes may be recorded.
- The following phenomena may be seen in the monitor while recording movies. These phenomena are saved in the recorded movies.
  - Banding may occur in images under fluorescent, mercury-vapor, or sodium-vapor lighting.
  - Subjects that move quickly from one side of the frame to the other, such as a moving train or car, may appear skewed.
  - The entire movie image may be skewed when the camera is panned.
  - Lighting or other bright areas may leave residual images when the camera is moved.
- Depending on the distance to the subject or the amount of zoom applied, subjects with repeating patterns (fabrics, lattice windows, etc.) may have colored stripes (interference patterns, moire, etc.) in them during movie recording and playback. This occurs when the pattern in the subject and the layout of the image sensor interfere with each other; it is not a malfunction.

Download from [Www.Somanuals.com](http://Www.Somanuals.com). All Manuals Search And Download.

## Camera Temperature

- The camera may become warm when shooting movies for an extended period of time or when the camera is used in a hot area.
- If the inside of the camera becomes extremely hot when recording movies, the camera will automatically stop recording.



The amount of time remaining until the camera stops recording ( 10 s) is displayed.

After the camera stops recording, it turns itself off.

Leave the camera off until the inside of the camera has cooled.

## Notes About Autofocus

Autofocus may not perform as expected ( 57). Should this occur, try the following:





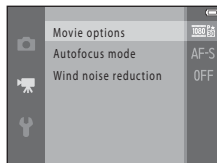

1. Set **Autofocus mode** in the movie menu to **Single AF** (default setting) before starting movie recording.
2. Frame another subject—positioned at the same distance from the camera as the intended subject—in the center of the frame, press the  ( movie-record) button to start recording, and then modify the composition.

## Functions That Can Be Set with the MENU Button (Movie Menu)

Enter shooting mode → MENU button →  menu icon →  button

The settings of the menu options listed below can be configured.



Option	Description	
Movie options	Select the movie type. Select normal speed to record movies at normal speed, or HS (high speed) to record movies that play in slow or fast motion. • Default setting:  <b>1080★/30p</b> or  <b>1080★/25p</b>	 58
Autofocus mode	Select either <b>Single AF</b> , which locks focus when movie recording begins, or <b>Full-time AF</b> , which continues focusing during movie recording. • Default setting: <b>Single AF</b>	 61
Wind noise reduction	Set whether or not to reduce wind noise during movie recording. • Default setting: <b>Off</b>	 61

## Playing Back Movies

Press the  button to enter playback mode.

Movies are indicated by the movie options icon ( 66).

Press the  button to play back movies.

- To adjust the volume, move the zoom control ( 1).





Movie options















Volume indicator

## Functions Available During Playback





Playback controls are displayed in the monitor.

The operations listed below can be performed by using the multi selector  to select a control and then pressing the  button.



Function	Icon	Description
Rewind		Hold down the  button to rewind the movie.
Advance		Hold down the  button to advance the movie.
Pause		Pause playback. The operations listed below can be performed while paused.
		 Rewind the movie one frame. Hold down the  button for continuous rewinding.
		 Advance the movie one frame. Hold down the  button for continuous advancing.
		 Resume playback.
		Extract the desired portion of a movie and save it as a separate file (  31).
End		Return to full-frame playback mode.

## Deleting Movies

To delete a movie, select the desired movie in full-frame playback mode ( 26) or thumbnail playback mode ( 60) and press the  button ( 27).











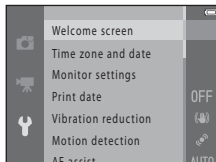

# General Camera Setup











## Functions That Can Be Set with the MENU Button (Setup Menu)

Press the **MENU** button →  (setup) menu icon →  button

The settings of the menu options listed below can be configured.



Option	Description	
Welcome screen	Allows you to select whether or not the welcome screen is displayed when the camera is turned on.	 62
Time zone and date	Allows you to set the camera clock.	 63
Monitor settings	Allows you to adjust photo information display, post-shooting image review, and monitor brightness settings.	 65
Print date	Allows you to imprint the shooting date and time on images.	 67
Vibration reduction	Allows you to select the vibration reduction setting used when shooting.	 68
Motion detection	Allows you to set whether or not the camera automatically increases the shutter speed to reduce blurring caused by camera shake if motion is detected when shooting still images.	 69
AF assist	Allows you to enable and disable the AF-assist illuminator.	 70
Digital zoom	Allows you to enable and disable digital zoom.	 70

Option	Description	
Sound settings	Allows you to adjust sound settings.	 71
Auto off	Allows you to set the amount of time that passes before the monitor turns off to save power.	 71
Format memory/ Format card	Allows you to format the internal memory or the memory card.	 72
Language	Allows you to change the camera's display language.	 73
TV settings	Allows you to adjust TV-connection settings.	 73
Blink warning	Allows you to set whether or not closed eyes are detected when taking images of people using face detection.	 74
Eye-Fi upload	Allows you to set whether or not to enable the function for sending images to a computer using a commercially available Eye-Fi card.	 75
Reset all	Allows you to reset the camera's settings to their default values.	 76
Battery type	Change this setting to match the type of batteries that are inserted in the camera.	 77
Firmware version	View the current camera firmware version.	 77

# Connecting the Camera to a TV, Computer, or Printer

## Connection Methods

You can enhance your enjoyment of images and movies by connecting the camera to a TV, computer, or printer.

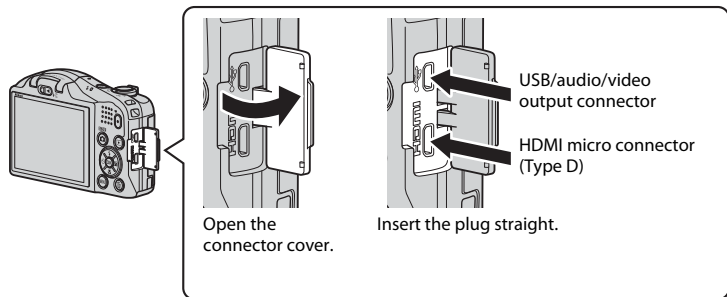

- Before connecting the camera to an external device, make sure the remaining battery level is sufficient and turn the camera off. Before disconnecting, make sure to turn the camera off.
- If the AC Adapter EH-65A (available separately) is used, this camera can be powered from an electrical outlet. Do not use any other make or model of AC adapter as it may cause the camera to heat up or malfunction.
- For information about the connection methods and subsequent operations, refer to the documentation included with the device in addition to this document.

**Viewing images on a TV** 22

Images and movies captured with the camera can be viewed on a TV.  
Connection method: Connect the video and audio plugs of the optional audio video cable to the TV's input jacks. Alternatively, connect a commercially available HDMI cable to the TV's HDMI input jack.

**Viewing and organizing images on a computer** 73

You can transfer images to a computer to perform simple retouching and manage image data.  
Connection method: Connect the camera to the computer's USB port with the included USB cable.

- Before connecting to a computer, install ViewNX 2 on the computer ( 73).

**Printing images without using a computer** 25

If you connect the camera to a PictBridge-compatible printer, you can print images without using a computer.  
Connection method: Connect the camera directly to the printer's USB port with the USB cable.

## Using ViewNX 2

ViewNX 2 is an all-in-one software package which enables you to transfer, view, edit and share images.

Install ViewNX 2 using the included ViewNX 2 CD-ROM.



### Installing ViewNX 2

- An Internet connection is required.

### Compatible Operating Systems

#### Windows

Windows 8, Windows 7, Windows Vista, Windows XP

#### Macintosh

Mac OS X 10.6, 10.7, 10.8

Refer to the Nikon website for details on system requirements, including the latest information on operating system compatibility.

# 1 Start the computer and insert the ViewNX 2 CD-ROM into the CD-ROM drive.

- Windows: If instructions for operating the CD-ROM are displayed in the window, follow the instructions to proceed to the installation window.
- Mac OS: When the **ViewNX 2** window is displayed, double-click the **Welcome** icon.

# 2 Select a language in the language selection dialog to open the installation window.

- If the desired language is not available, click **Region Selection** to choose a different region and then choose the desired language (the **Region Selection** button is not available in the European release).
- Click **Next** to display the installation window.

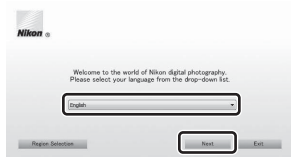

# 3 Start the installer.

- We recommend clicking **Installation Guide** in the installation window to check the installation help information and system requirements before installing ViewNX 2.
- Click **Typical Installation (Recommended)** in the installation window.

# 4 Download the software.

- When the **Software Download** screen is displayed, click **I agree - Begin download**.
- Follow the on-screen instructions to install the software.

---

## 5 Exit the installer when the installation completion screen is displayed.

- Windows: Click **Yes**.
- Mac OS: Click **OK**.

The following software is installed:

- ViewNX 2 (consisting of the three modules below)
  - Nikon Transfer 2: For transferring images to the computer
  - ViewNX 2: For viewing, editing, and printing transferred images
  - Nikon Movie Editor: For basic editing of transferred movies
- Panorama Maker (for creating a single panorama image of a landscape, etc. from a series of images that each capture a separate portion of the subject)

---

## 6 Remove the ViewNX 2 CD-ROM from the CD-ROM drive.

# Transferring Images to the Computer

## 1 Choose how images will be copied to the computer.

Choose one of the following methods:

- **Direct USB connection:** Turn the camera off and ensure that the memory card is inserted in the camera. Connect the camera to the computer using the USB cable. Turn the camera on. To transfer images that are saved in the camera's internal memory, remove the memory card from the camera before connecting it to the computer.

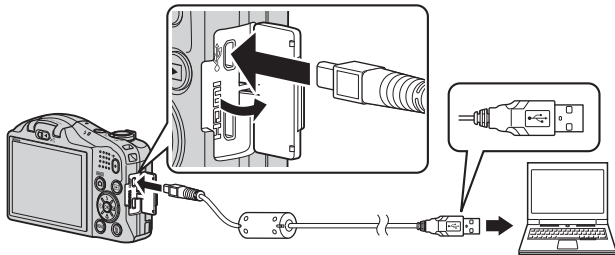

- **SD card slot:** If your computer is equipped with an SD card slot, the card can be inserted directly in the slot.
- **SD card reader:** Connect a card reader (available separately from third-party suppliers) to the computer and insert the memory card.



If a message is displayed prompting you to choose a program, select Nikon Transfer 2.

- **When using Windows 7**

If the dialog shown at right is displayed, follow the steps below to select Nikon Transfer 2.

- 1 Under **Import pictures and videos**, click **Change program**. A program selection dialog will be displayed; select **Import File using Nikon Transfer 2** and click **OK**.
- 2 Double-click **Import File**.

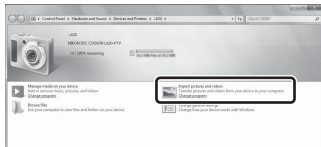

If the memory card contains a large number of images, it may take a while for Nikon Transfer 2 to start. Wait until Nikon Transfer 2 starts.

## ✓ Connecting the USB Cable

The connection may not be recognized if the camera is connected to the computer via a USB hub.

## 2 Transfer images to the computer.

- Confirm that the name of the connected camera or removable disk is displayed as the "Source" on the "Options" title bar of Nikon Transfer 2 (①).
- Click **Start Transfer** (②).

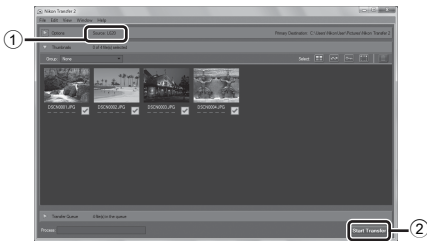

- At default settings, all the images on the memory card will be copied to the computer.

### 3 Terminate the connection.

- If the camera is connected to the computer, turn the camera off and disconnect the USB cable. If you are using a card reader or card slot, choose the appropriate option in the computer operating system to eject the removable disk corresponding to the memory card and then remove the card from the card reader or card slot.

## Viewing Images

### Start ViewNX 2.

- Images are displayed in ViewNX 2 when transfer is complete.
- Consult online help for more information on using ViewNX 2.



### Starting ViewNX 2 Manually

- **Windows:** Double-click the **ViewNX 2** shortcut icon on the desktop.
- **Mac OS:** Click the **ViewNX 2** icon in the Dock.



# Technical Notes and Index

<b>Caring for the Product</b> .....	<b>2</b>
The Camera.....	2
Batteries .....	3
Memory Cards .....	5
<b>Cleaning and Storage</b> .....	<b>6</b>
Cleaning.....	6
Storage.....	7
<b>Troubleshooting</b> .....	<b>8</b>
<b>Specifications</b> .....	<b>16</b>
Approved Memory Cards .....	20
<b>Index</b> .....	<b>23</b>

# Caring for the Product

## The Camera

To ensure continued enjoyment of this Nikon product, observe the precautions described below in addition to the warnings in "For Your Safety" (📖 viii-xiv) when using or storing the device.

### ✔ Do Not Drop

The product may malfunction if subjected to strong shock or vibration.

### ✔ Handle the Lens and All Moving Parts with Care

Do not apply force to the lens, lens cover, monitor, memory card slot, or battery chamber. These parts are easily damaged. Applying force to the lens cover could result in camera malfunction or damage to the lens. Should the monitor break, care should be taken to avoid injury caused by broken glass and to prevent the liquid crystal from the display touching the skin or entering the eyes or mouth.

### ✔ Keep Dry

The device will be damaged if immersed in water or subjected to high humidity.

### ✔ Avoid Sudden Changes in Temperature

Sudden changes in temperature, such as when entering or leaving a heated building on a cold day, can cause condensation to form inside the device. To prevent condensation, place the device in a carrying case or a plastic bag before exposing it to sudden changes in temperature.

### ✔ Keep away from Strong Magnetic Fields

Do not use or store this device in the vicinity of equipment that generates strong electromagnetic radiation or magnetic fields. Strong static charge or the magnetic fields produced by equipment such as radio transmitters could interfere with the monitor, damage data saved on the memory card, or affect the product's internal circuitry.

## **Do Not Point the Lens at Strong Light Sources for Extended Periods**

Avoid pointing the lens at the sun or other strong light sources for extended periods when using or storing the camera. Intense light may cause deterioration of the image sensor, producing a white blur effect in photographs.

## **Turn the Product off Before Removing or Disconnecting the Power Source**

Do not remove the batteries while the product is on, or while images are being saved or deleted. Forcibly cutting power in these circumstances could result in loss of data or in damage to product memory or internal circuitry.

## **Notes About the Monitor**

- Monitors and electronic viewfinders are constructed with extremely high precision; at least 99.99% of pixels are effective, with no more than 0.01% being missing or defective. Hence while these displays may contain pixels that are always lit (white, red, blue, or green) or always off (black), this is not a malfunction and has no effect on images recorded with the device.
- Images in the monitor may be difficult to see under bright lighting.
- The monitor is lit by an LED backlight. Should the monitor begin to dim or flicker, contact your Nikon-authorized service representative.

## **Batteries**

Be sure to read and follow the warnings in "For Your Safety" ( viii-xiv) before use.

### **Notes About Using Batteries**

- Used batteries may overheat. Handle with caution.
- Do not use batteries beyond their recommended expiration date.
- Do not turn the camera on and off repeatedly if discharged batteries are inserted in the camera.

### **Spare Batteries**

We recommend carrying spare batteries depending on where you are shooting. It may be difficult to purchase batteries in certain areas.

### **Charging Batteries**



If using optional rechargeable batteries, charge the batteries before taking pictures. Batteries are not charged at the time of purchase.

Be sure to read and follow the warnings noted in the operating instructions included with the battery charger.

## Charging Rechargeable Batteries

- Do not mix batteries with different amounts of charge remaining, or batteries of a different make or model.
- When using EN-MH2 batteries with this camera, charge two batteries at a time using Battery Charger MH-72. When using Battery Charger MH-73, charge two or four batteries at a time. Use only Battery Charger MH-72 or MH-73 to charge EN-MH2 batteries.
- When using Battery Charger MH-72 or MH-73, only charge EN-MH2 batteries.

## Notes About EN-MH1 Rechargeable Batteries and Battery Charger MH-70/71

- You can also use EN-MH1 Ni-MH rechargeable batteries with this camera.
- Use only Battery Charger MH-70 or MH-71 to charge EN-MH1 batteries.
- When using Battery Charger MH-70 or MH-71, only charge EN-MH1 batteries.
- Set **Battery type** ( 70,  77) to **COOLPIX (Ni-MH)**.

## Notes About Rechargeable Ni-MH Batteries

- If you repeatedly charge rechargeable Ni-MH batteries while they still have some charge remaining, the message **Battery exhausted.** may be displayed prematurely when using the batteries. This is due to the “memory effect,” in which the amount of charge the batteries can hold decreases temporarily. Use the batteries until there is no charge remaining and they will return to their normal behavior.
- Rechargeable Ni-MH batteries discharge even when not being used. We recommend charging the batteries just before using them.

## Cold Environment Usage

Battery performance decreases in cold environments. When using the camera in cold environments, try not to let the camera and batteries become too cold. The camera may not function if you use discharged batteries in cold environments. Keep spare batteries warm and alternate between two sets of batteries. Batteries that cannot be used because they have become too cold can often be used again when they have been warmed up.

## Battery Terminals

Dirt on the battery terminals can prevent the camera from functioning. Remove dirt from the terminals using a dry cloth.

## Remaining Battery Charge

If you insert discharged batteries into the camera, the camera may indicate that the batteries have adequate charge remaining. This is a characteristic of batteries.

## Recycling

Used batteries are a valuable resource. Please recycle used batteries in accordance with local regulations. Cover the battery terminals with plastic tape when recycling.

## Memory Cards

- Use only Secure Digital memory cards. See “Approved Memory Cards” (🔧:20) for recommended memory cards.
- Observe the precautions noted in the documentation included with your memory card.
- Do not affix labels or stickers to the memory card.
- Do not format the memory card using a computer.
- The first time you insert a memory card that has been used in another device into this camera, be sure to format it with this camera. We recommend formatting new memory cards with this camera before using them with this camera.
- Note that **formatting a memory card permanently deletes all images and other data on the memory card**. If there is data saved on the memory card that you wish to keep, copy that data to a computer before formatting.
- If the message **Card is not formatted. Format card?** is displayed when the camera is turned on, the memory card must be formatted. If there is data on the memory card that you do not want to delete, select **No** and press the  button. Copy that data to a computer before formatting. To format the memory card, select **Yes**.
- Observe the following precautions while formatting the memory card, saving and deleting images, and copying images to a computer, otherwise data or the memory card itself may be damaged.
  - Do not open the battery-chamber/memory card slot cover or remove the memory card or batteries.
  - Do not turn off the camera.
  - Do not disconnect the AC adapter.

# Cleaning and Storage

## Cleaning

Do not use alcohol, thinner, or other volatile chemicals.

Lens	Avoid touching glass parts with your fingers. Remove dust or lint with a blower (typically a small device with a rubber bulb attached to one end that is pumped to produce a stream of air out the other end). To remove fingerprints or other stains that cannot be removed with a blower, wipe the lens with a soft cloth, using a spiral motion that starts at the center of them and working toward the edges. If this fails, clean the lens using a cloth lightly dampened with commercial lens cleaner.
Monitor	Remove dust or lint with a blower. To remove fingerprints and other stains, clean the monitor with a soft, dry cloth, being careful not to apply pressure.
Body	Use a blower to remove dust, dirt, or sand, then wipe gently with a soft, dry cloth. After using the camera at the beach or other sandy or dusty environment, wipe off any sand, dust, or salt with a dry cloth lightly dampened with fresh water and dry thoroughly. <b>Note that foreign matter inside the camera could cause damage not covered by the warranty.</b>



## Storage

Turn the camera off when not in use. Be sure that the power-on lamp is off before putting the camera away. Remove the batteries if the camera will not be used for an extended period. Do not store the camera with naphtha or camphor moth balls, or in any of the following locations:

- Next to equipment that produces strong electromagnetic fields, such as televisions or radios
- Exposed to temperatures below  $-10^{\circ}\text{C}$  ( $14^{\circ}\text{F}$ ) or above  $50^{\circ}\text{C}$  ( $122^{\circ}\text{F}$ )
- Places that are poorly ventilated or subject to humidity of over 60%







To prevent mold or mildew, take the camera out of storage at least once a month. Turn the camera on and release the shutter a few times before putting the camera away again.









For storing the batteries, follow the precautions in "Batteries" (🔋:3) in "Caring for the Product" (🔋:2).

# Troubleshooting









If the camera fails to function as expected, check the list of common problems below before consulting your retailer or Nikon-authorized service representative.







## Power, Display, Settings Issues











Problem	Cause/Solution	
The camera is on but does not respond.	Wait for recording to end. If the problem persists, turn the camera off. If the camera does not turn off, remove and reinsert the battery or batteries or, if you are using an AC adapter, disconnect and reconnect the AC adapter. Note that although any data currently being recorded will be lost, data that have already been recorded will not be affected by removing or disconnecting the power source.	10, 18,  83
Camera turns off without warning.	<ul style="list-style-type: none"><li>• The camera automatically turns off to save power (auto off function).</li><li>• The camera or batteries have become too cold and cannot operate properly.</li><li>• The inside of the camera has become hot. Leave the camera off until the inside of the camera has cooled, and then try turning it on again.</li></ul>	19  4 –
Monitor is blank.	<ul style="list-style-type: none"><li>• The camera is off.</li><li>• The batteries are exhausted.</li><li>• The camera has entered standby mode to save power. Press the power switch, shutter-release button,  button,  button, or  (movie-record) button.</li><li>• The flash lamp flashes while the flash is charging. Wait for the flash to charge.</li><li>• The camera and computer are connected via a USB cable.</li><li>• The camera and TV are connected via an audio/video cable or HDMI cable.</li></ul>	18 18 1, 19  43  71, 76 71,  22



Problem	Cause/Solution	
Monitor is hard to read.	<ul style="list-style-type: none"> <li>Adjust the monitor brightness.</li> <li>The monitor is dirty. Clean the monitor.</li> </ul>	69,  65  6
Date and time of recording are not correct.	<ul style="list-style-type: none"> <li>If the camera clock has not been set,  flashes during shooting and movie recording. Images and movies saved before the clock is set are dated "00/00/0000 00:00" or "01/01/2013 00:00" respectively. Set the correct time and date from the <b>Time zone and date</b> option in the setup menu.</li> <li>The camera clock is not as accurate as ordinary watches or clocks. Periodically compare the time of the camera clock with that of a more accurate timepiece and reset as required.</li> </ul>	14, 69,  63
No indicators displayed in monitor.	<b>Hide info</b> is selected for <b>Photo info</b> in <b>Monitor settings</b> in the setup menu.	69,  65
<b>Print date</b> not available.	<b>Time zone and date</b> has not been set in the setup menu.	14, 69,  63
Date not imprinted on images even when <b>Print date</b> is enabled.	<ul style="list-style-type: none"> <li>The current shooting mode does not support <b>Print date</b>.</li> <li>The date cannot be imprinted on movies.</li> </ul>	69,  67
Screen for setting time zone and date is displayed when camera is turned on. Camera settings reset.	The clock battery is exhausted; all settings were restored to their default values.	14, 17
Camera becomes hot.	The camera may become hot when used for an extended period of time to shoot movies or send images using an Eye-Fi card, or when used in a hot environment; this is not a malfunction.	-
Camera makes sound.	When <b>Autofocus mode</b> is set to <b>Full-time AF</b> or while in some shooting modes, the camera may produce an audible focusing sound.	66,  61

## Shooting Issues

Problem	Cause/Solution	
Cannot switch to shooting mode.	Disconnect the HDMI cable or USB cable.	71, 76,  22,  25
No image captured when the shutter-release button is pressed.	<ul style="list-style-type: none"><li>• When the camera is in playback mode, press the  button or the shutter-release button.</li><li>• When menus are displayed, press the <b>MENU</b> button.</li><li>• The batteries are exhausted.</li><li>• When the flash lamp is flashing, the flash is charging.</li></ul>	1, 26 2 18 43
Camera cannot focus.	<ul style="list-style-type: none"><li>• The subject is too close. Try shooting using easy auto mode, <b>Close-up</b> scene mode, or macro mode.</li><li>• The subject is hard to focus on.</li><li>• Set <b>AF assist</b> in the setup menu to <b>Auto</b>.</li><li>• Turn the camera off and then on again.</li></ul>	29, 32, 46  57 69,  70 18
Images are blurred.	<ul style="list-style-type: none"><li>• Use the flash.</li><li>• Increase the ISO sensitivity value.</li><li>• Enable vibration reduction or motion detection.</li><li>• Use <b>BSS</b> (Best Shot Selector).</li><li>• Use a tripod to stabilize the camera when shooting (using the self-timer at the same time is more effective).</li></ul>	41 51,  40 69,  68,  69 33,  38 44





Problem	Cause/Solution	
Bright specks appear in images captured with flash.	The flash is reflecting off particles in the air. Lower the flash.	3
Flash does not fire.	<ul style="list-style-type: none"> <li>• The flash is lowered.</li> <li>• A scene mode that restricts the flash is selected.</li> <li>• <b>On (BSS)</b> is selected for <b>Smile timer</b> in the smart portrait menu.</li> <li>• <b>On</b> is selected for <b>Blink proof</b> in the smart portrait menu.</li> <li>• A function that restricts the flash is enabled.</li> </ul>	3, 41 48 51,  44 51,  45 52
Digital zoom cannot be used.	<ul style="list-style-type: none"> <li>• <b>Digital zoom</b> is set to <b>Off</b> in the setup menu.</li> <li>• Digital zoom cannot be used in the following situations. <ul style="list-style-type: none"> <li>- When <b>Portrait, Night portrait, Night landscape, Easy panorama,</b> or <b>Pet portrait</b> is selected in scene mode</li> <li>- When smart portrait mode is selected</li> <li>- When <b>Continuous</b> in the shooting menu is set to <b>Multi-shot 16</b></li> </ul> </li> </ul>	69,  70  30  37 51,  38
<b>Image mode</b> not available.	A function that restricts the <b>Image mode</b> option is enabled.	52
No sound when shutter is released.	<ul style="list-style-type: none"> <li>• <b>Off</b> is selected for <b>Sound settings &gt; Shutter sound</b> in the setup menu. No sound is produced with some shooting modes and settings, even when <b>On</b> is selected.</li> <li>• Do not block the speaker.</li> </ul>	70,  71  2
AF-assist illuminator does not light.	<b>Off</b> is selected for the <b>AF assist</b> option in the setup menu. AF-assist illuminator may not light depending on the current scene mode, even when <b>Auto</b> is selected.	69,  70

Problem	Cause/Solution	
Images appear smeared.	The lens is dirty. Clean the lens.	 6
Colors are unnatural.	White balance or hue is not adjusted properly.	32, 51,  35
Randomly spaced bright pixels ("noise") appear in image.	The subject is dark, and the shutter speed is too slow or ISO sensitivity is too high. Noise can be reduced by: <ul style="list-style-type: none"> <li>Using the flash.</li> <li>Specifying a lower ISO sensitivity setting.</li> </ul>	41 51,  40
Images are too dark (underexposed).	<ul style="list-style-type: none"> <li>The flash is lowered or a shooting mode that restricts the flash is selected.</li> <li>The flash window is blocked.</li> <li>The subject is beyond the range of the flash.</li> <li>Adjust exposure compensation.</li> <li>Increase ISO sensitivity.</li> <li>The subject is backlit. Select <b>Backlighting</b> scene mode, or raise the flash and set the flash mode setting to  (fill flash).</li> </ul>	3, 41, 48  22  18 47 51,  40 33, 41
Images are too bright (overexposed).	Adjust exposure compensation.	47
Unexpected results when flash set to  (auto with red-eye reduction).	When taking images with  (auto with red-eye reduction), or when taking images with <b>Night portrait</b> (either in easy auto mode or in scene mode) and the fill flash with slow sync and red-eye reduction is used, In-Camera Red Eye Fix may be applied to areas not affected by red-eye in rare cases. Use auto mode or any scene mode other than <b>Night portrait</b> , and change the flash mode to any setting other than  (auto with red-eye reduction) and try taking an image again.	31, 41
Skin tones are not softened.	<ul style="list-style-type: none"> <li>In some shooting conditions, facial skin tones may not be softened.</li> <li>For images containing four or more faces, try using the <b>Skin softening</b> effect in the playback menu.</li> </ul>	55 61,  17



Problem	Cause/Solution	
Saving images takes time.	<p>It may take more time to save images in the following situations.</p> <ul style="list-style-type: none"> <li>• When the noise reduction function is in operation, such as when shooting in a dark environment</li> <li>• When the flash mode is set to  (auto with red-eye reduction)</li> <li>• When shooting in <b>Night portrait</b> or <b>Night landscape</b> scene mode</li> <li>• When the skin softening function is applied while shooting</li> <li>• When using continuous shooting mode</li> </ul>	<p>–</p> <p>43</p> <p>31, 32</p> <p>55</p> <p>51, 38</p>

## Playback Issues

Problem	Cause/Solution	
File cannot be played back.	<ul style="list-style-type: none"> <li>• This camera may not be able to play back images saved with another make or model of digital camera.</li> <li>• This camera cannot play back movies recorded with another make or model of digital camera.</li> <li>• This camera may not be able to play back data edited on a computer.</li> </ul>	–
Cannot zoom in on image.	<ul style="list-style-type: none"> <li>• Playback zoom cannot be used with movies, small pictures, or images that have been cropped to a size of 320 × 240 or smaller.</li> <li>• This camera may not be able to zoom in on images captured with another make or model of digital camera.</li> </ul>	–
Cannot record voice memos.	<ul style="list-style-type: none"> <li>• Voice memos cannot be attached to movies.</li> <li>• Voice memos cannot be attached to images captured with other cameras. Voice memos attached to images using another camera cannot be played back on this camera.</li> </ul>	–

Problem	Cause/Solution	
Cannot edit image.	<ul style="list-style-type: none"> <li>• Some images cannot be edited. Images that have already been edited may not be edited again.</li> <li>• There is not enough free space in the internal memory or on the memory card.</li> <li>• This camera is unable to edit images captured with other cameras.</li> <li>• Editing functions used for images are not available for movies.</li> </ul>	33,  14 – – –
Cannot rotate image.	This camera cannot rotate images captured with another make or model of digital camera.	–
Images are not displayed on TV.	<ul style="list-style-type: none"> <li>• <b>Video mode</b> or <b>HDMI</b> is not correctly set in the <b>TV settings</b> setup menu.</li> <li>• The cables are connected to the HDMI micro connector (Type D) and to the USB/audio/video output connector simultaneously.</li> <li>• The memory card contains no images. Replace the memory card. Remove the memory card to play back images from the internal memory.</li> </ul>	70,  73 71, 76,  22,  25 12
Nikon Transfer 2 does not start when camera is connected to a computer.	<ul style="list-style-type: none"> <li>• The camera is off.</li> <li>• The batteries are exhausted.</li> <li>• The USB cable is not correctly connected.</li> <li>• The camera is not recognized by the computer.</li> <li>• Confirm system requirements.</li> <li>• The computer is not set to start Nikon Transfer 2 automatically. For more information about Nikon Transfer 2, refer to help information contained in ViewNX 2.</li> </ul>	18 18 71, 76 – 73 78
Images to be printed are not displayed.	<ul style="list-style-type: none"> <li>• The memory card contains no images. Replace the memory card.</li> <li>• Remove the memory card to print images from the internal memory.</li> </ul>	12 13



Problem	Cause/Solution	
Cannot select paper size with camera.	<p>The camera cannot be used to select the paper size in the following situations, even when printing from a PictBridge-compatible printer. Use the printer to select the paper size.</p> <ul style="list-style-type: none"> <li>• The printer does not support the paper sizes specified by the camera.</li> <li>• The printer automatically selects the paper size.</li> </ul>	<p>71, 26,  28            –</p>

# Specifications

## Nikon COOLPIX L620 Digital Camera

Type	Compact digital camera
Number of effective pixels	18.1 million
Image sensor	$\frac{1}{2.3}$ -in. type CMOS; approx. 18.91 million total pixels
Lens	NIKKOR lens with 14x optical zoom
Focal length	4.5–63.0 mm (angle of view equivalent to that of 25–350 mm lens in 35mm [135] format)
f/-number	f/3.3–5.9
Construction	11 elements in 10 groups (2 ED lens elements)
Digital zoom magnification	Up to 2x (angle of view equivalent to that of approx. 700 mm lens in 35mm [135] format)
Vibration reduction	Lens shift
Motion blur reduction	Motion detection (still pictures)
Autofocus (AF)	Contrast-detect AF
Focus range	<ul style="list-style-type: none"><li>• [W]: Approx. 50 cm (1 ft 8 in.)–<math>\infty</math>,</li><li>• [T]: Approx. 1.0 m (3 ft 4 in.)–<math>\infty</math></li><li>• Macro mode: Approx. 1 cm (0.4 in.) (wide-angle position relative to –<math>\infty</math>)</li></ul> (All distances measured from center of front surface of lens)
Focus-area selection	Center, face detection, target finding AF
Monitor	7.5 cm (3-in.), approx. 460k-dot, TFT LCD with anti-reflection coating and 5-level brightness adjustment
Frame coverage (shooting mode)	Approx. 96% horizontal and 96% vertical (compared to actual picture)
Frame coverage (playback mode)	Approx. 96% horizontal and 96% vertical (compared to actual picture)

<b>Storage</b>	
Media	Internal memory (approx. 83 MB), SD/SDHC/SDXC memory card
File system	DCF, Exif 2.3, and DPOF compliant
File formats	Still pictures: JPEG Sound files (voice memo): WAV Movies: MOV (Video: H.264/MPEG-4 AVC, Audio: LPCM stereo)
Image size (pixels)	<ul style="list-style-type: none"> <li>• 18M (High) [4896 × 3672]★</li> <li>• 18M [4896 × 3672]</li> <li>• 8M [3264 × 2448]</li> <li>• 4M [2272 × 1704]</li> <li>• 2M [1600 × 1200]</li> <li>• VGA [640 × 480]</li> <li>• 16:9 [4896 × 2754]</li> <li>• 1:1 [3672 × 3672]</li> </ul>
ISO sensitivity (Standard output sensitivity)	<ul style="list-style-type: none"> <li>• ISO 125–1600</li> <li>• ISO 3200 (available when using Auto mode)</li> </ul>
<b>Exposure</b>	
Metering mode	Matrix, center-weighted (digital zoom less than 2×), spot (digital zoom 2×)
Exposure control	Programmed auto exposure and exposure compensation (–2.0 – +2.0 EV in steps of $\frac{1}{3}$ EV)
<b>Shutter</b>	
Speed	Mechanical and CMOS electronic shutter <ul style="list-style-type: none"> <li>• <math>\frac{1}{1600}</math>–1 s</li> <li>• <math>\frac{1}{4000}</math> s (maximum speed during high-speed continuous shooting)</li> <li>• 4 s (<b>Fireworks show</b> scene mode)</li> </ul>
<b>Aperture</b>	
Range	Electronically-controlled ND filter (–2 AV) selection 2 steps (f/3.3 and f/6.6 [W])
Self-timer	Approx. 10 s

<b>Flash</b>	
Range (approx.) (ISO sensitivity: Auto)	[W]: 0.5–5.0 m (1 ft 8 in.–16 ft) [T]: 1.0–3.0 m (3 ft 4 in.–9 ft 10 in.)
Flash control	TTL auto flash with monitor preflashes
<b>Interface</b>	Hi-Speed USB
Data transfer protocol	MTP, PTP
<b>Video output</b>	Can be selected from NTSC and PAL
<b>HDMI output</b>	Can be selected from Auto, 480p, 720p, and 1080i
<b>I/O terminal</b>	Audio/video (A/V) output; digital I/O (USB) HDMI micro connector (Type D) (HDMI output)
<b>Supported languages</b>	Arabic, Bengali, Bulgarian, Chinese (Simplified and Traditional), Czech, Danish, Dutch, English, Finnish, French, German, Greek, Hindi, Hungarian, Indonesian, Italian, Japanese, Korean, Marathi, Norwegian, Persian, Polish, Portuguese (European and Brazilian), Romanian, Russian, Serbian, Spanish, Swedish, Tamil, Telugu, Thai, Turkish, Ukrainian, Vietnamese
<b>Power sources</b>	<ul style="list-style-type: none"> <li>• Two LR6/L40 (AA-size) alkaline batteries</li> <li>• Two FR6/L91 (AA-size) lithium batteries</li> <li>• Two EN-MH2 rechargeable Ni-MH batteries (available separately)</li> <li>• AC Adapter EH-65A (available separately)</li> </ul>
<b>Battery life<sup>1</sup></b>	
Still pictures	<ul style="list-style-type: none"> <li>• Approx. 150 shots when using alkaline batteries</li> <li>• Approx. 660 shots when using lithium batteries</li> <li>• Approx. 410 shots when using EN-MH2 batteries</li> </ul>
Movies (actual battery life for recording) <sup>2</sup>	<ul style="list-style-type: none"> <li>• Approx. 10 min when using alkaline batteries</li> <li>• Approx. 1 h 25 min when using lithium batteries</li> <li>• Approx. 55 min when using EN-MH2 batteries</li> </ul>
<b>Tripod socket</b>	1/4 (ISO 1222)
<b>Dimensions (W × H × D)</b>	Approx. 108.3 × 68.7 × 34.1 mm (4.3 × 2.8 × 1.4 in.) (excluding projections)
<b>Weight</b>	Approx. 237 g (8.4 oz) (including batteries and SD memory card)

## Operating environment

Temperature	0°C–40°C (32°F–104°F)
Humidity	85% or less (no condensation)

- Unless otherwise stated, all figures assume fresh LR6/L40 (AA-size) alkaline batteries and an ambient temperature of  $23 \pm 3$  °C ( $73.4 \pm 5.4$  °F) as specified by the Camera and Imaging Products Association (CIPA).
- <sup>1</sup> Battery life may vary depending on conditions of use, such as the interval between shots or the length of time that menus and images are displayed.  
The included batteries are for trial use only. Figures listed for lithium batteries are measured using commercially available FR6/L91 (AA-size) Energizer(R) Ultimate Lithium batteries.
  - <sup>2</sup> Individual movie files cannot exceed 4 GB in size or 29 minutes in length. Recording may end before this limit is reached if camera temperature becomes elevated.

## Specifications

- Nikon will not be held liable for any errors this manual may contain.
- The appearance of this product and its specifications are subject to change without notice.

## Approved Memory Cards

The following Secure Digital (SD) memory cards have been tested and approved for use in this camera.

- Memory cards with an SD Speed Class rating of 6 or faster are recommended for recording movies. When using a memory card with a lower Speed Class rating, movie recording may stop unexpectedly.

	SD memory card	SDHC memory card <sup>2</sup>	SDXC memory card <sup>3</sup>
SanDisk	2 GB <sup>1</sup>	4 GB, 8 GB, 16 GB, 32 GB	64 GB, 128 GB
TOSHIBA	–	4 GB, 8 GB, 16 GB, 32 GB	64 GB
Panasonic	2 GB <sup>1</sup>	4 GB, 8 GB, 16 GB, 32 GB	64 GB
Lexar	–	4 GB, 8 GB, 16 GB, 32 GB	64 GB, 128 GB

<sup>1</sup> If the memory card will be used with a card reader or similar device, make sure that the device supports 2 GB cards.

<sup>2</sup> SDHC compliant.

If the memory card will be used with a card reader or similar device, make sure that the device supports SDHC.



<sup>3</sup> SDXC compliant.

If the memory card will be used with a card reader or similar device, make sure that the device supports SDXC.



- Contact the manufacturer for details on the above cards. We cannot guarantee camera performance when using memory cards made by other manufacturers.

### **AVC Patent Portfolio License**

This product is licensed under the AVC Patent Portfolio License for the personal and noncommercial use of a consumer to (i) encode video in compliance with the AVC standard (“AVC video”) and/or (ii) decode AVC video that was encoded by a consumer engaged in a personal and non-commercial activity and/or was obtained from a video provider licensed to provide AVC video. No license is granted or shall be implied for any other use.

Additional information may be obtained from MPEG LA, L.L.C.

See **<http://www.mpegla.com>**.

## Trademark Information

- Microsoft, Windows and Windows Vista are either registered trademarks or trademarks of Microsoft Corporation in the United States and/or other countries.
- Macintosh and Mac OS are trademarks of Apple Inc., registered in the U.S. and other countries. The iFrame logo and the iFrame symbol are trademarks of Apple Inc.
- Adobe and Acrobat are registered trademarks of Adobe Systems Inc.
- SDXC, SDHC and SD Logos are trademarks of SD-3C, LLC.
- PictBridge is a trademark.
- HDMI, HDMI logo and High-Definition Multimedia Interface are trademarks or registered trademarks of HDMI Licensing LLC.

## HDMI

- All other trade names mentioned in this manual or the other documentation provided with your Nikon product are trademarks or registered trademarks of their respective holders.

## FreeType License (FreeType2)

Portions of this software are copyright © 2013 The FreeType Project  
(<http://www.freetype.org>). All rights reserved.

## MIT License (HarfBuzz)

Portions of this software are copyright © 2013 The HarfBuzz Project  
(<http://www.freedesktop.org/wiki/Software/HarfBuzz>). All rights reserved.



# Index

## Symbols

<b>T</b> Telephoto .....	23
<b>W</b> Wide-angle .....	23
Playback zoom .....	59
Thumbnail playback .....	60
Easy auto mode .....	29
Scene mode .....	30
Special effects mode .....	35
Smart portrait mode .....	37
Auto mode .....	39
Playback mode .....	26
Favorite pictures mode .....	66
Auto sort mode .....	10
List by date mode .....	11
Setup menu .....	69,  62
Apply selection button .....	2
Shooting mode button .....	2
Movie-record button .....	2
Playback button .....	2, 26
Delete button .....	2, 27
<b>MENU</b> button .....	2, 4, 50, 61, 66, 69
Flash pop-up control .....	2, 3, 41
Flash mode .....	41
Self-timer .....	44
Macro mode .....	46
Exposure compensation .....	47
Help .....	30

## A

AC adapter .....	83
AF area mode .....	51,  42
AF-assist illuminator .....	1, 69,  70
Album .....	9
Alkaline batteries .....	10
Aperture value .....	25
Audio/video cable .....	72,  22,  83
Audio/video-in jack .....	72,  22
Auto flash .....	42
Auto mode .....	39
Auto off .....	19, 70,  71
Auto sort menu .....	61,  10
Auto sort mode .....	10
Autofocus .....	57, 66,  61
Autofocus mode .....	66,  61

## B

Backlighting  .....	30, 33
Battery .....	10, 17
Battery charger .....	83
Battery level .....	18
Battery type .....	70,  77
Battery-chamber/memory card slot cover .....	2, 12
Beach  .....	30
Best shot selector .....	33,  38
Black and white copy  .....	30, 33

Refer to the *Reference Manual* for pages indicated with .

Black-and-white .....		41
Blink proof.....	51,	45
Blink warning.....	70,	74
Brightness .....		65
BSS.....	33,	38
Button sound.....		71

## C

Calendar display .....		60	
Choose key picture .....	62,	12,	57
Close-up		30, 32	
Color options.....	51,	41	
Compression ratio.....		33	
Computer.....		72, 76	
Connector cover.....		1	
Continuous shooting.....	51,	38	
Copy .....	61,	55	
Crop.....	59,	21	
Cyanotype .....		41	

## D

Date and time .....	14, 69,	63
Date format.....	15,	63
Daylight saving time .....	15,	64
Delete.....		27
Digital zoom.....	23, 69,	70
Direct print.....	72,	24
D-Lighting .....	61,	15
DPOF print.....		30
DSCN.....		82
Dusk/dawn		30

## E

Easy auto mode.....		29	
Easy panorama	30, 33,	2	
Easy panorama playback.....	33,	5	
Editing movies .....		31	
EN-MH1 .....		4	
EN-MH2 .....		83,	3
Exposure compensation.....		47	
Extension.....		82	
Eye-Fi upload.....	70,	75	
Eyelets for camera strap.....		1	

## F

Face detection .....		54
Favorite pictures .....	62,	6
Favorite pictures menu .....	61,	7
Favorite pictures mode .....		6
File name.....		82
Fill flash .....		42
Filter effects .....	61,	18
Fireworks show		30, 33
Firmware version.....	70,	77
Flash .....	1, 3, 41	
Flash lamp .....		2, 43
Flash mode.....		41
Flash pop-up control .....	2, 3, 41	
Focus.....	24, 54,	42
Focus area.....		24
Focus indicator .....		7
Focus lock.....		58
Food		30, 32

Refer to the *Reference Manual* for pages indicated with .

Format internal memory .....	70,	72	List by date menu .....	61,	11
Format memory cards .....	13, 70,	72	List by date mode .....		11
Formatting .....	13, 70,	72	Lithium batteries .....		10
FSCN .....		82	Low key		35
Full-frame playback mode .....		26	<b>M</b>		
Full-time AF .....	66,	61	Macro mode .....		46
<b>H</b>			Memory card .....	12,	20
HDMI .....		73	Memory card slot .....		12
HDMI cable .....	72,	22	Microphone (stereo) .....		1
HDMI device control .....		73	Monitor .....	2, 6,	6
HDMI micro connector .....		1	Monitor settings .....	69,	65
Help .....		30	Motion detection .....	69,	69
High key		35	MOV .....		82
High-contrast monochrome		35	Movie length .....		63
HS movie .....	66,	59,	Movie menu .....	66,	58
<b>I</b>			Movie options .....	66,	58
Identifier .....		82	Movie playback .....		67
Image mode .....	51,	33	Movie recording .....		63
Image review .....		65	Movie-record button .....		2
Imprinting date and time .....	17,	67	Multi selector .....		2
Internal memory .....		13	Multi-shot 16 .....		38
ISO sensitivity .....	51,	40	Museum		30, 33
<b>J</b>			<b>N</b>		
JPG .....		82	Night landscape		30, 32
<b>L</b>			Night portrait		30, 31
Landscape		30	Nikon Transfer 2 .....		75, 76
Language .....	70,	73	Nostalgic sepia <b>SE</b> .....		35
Lens .....	1,	16	Number of exposures remaining		
Lens cover .....		1	.....	18,	34

Refer to the *Reference Manual* for pages indicated with .

**O**

Optical zoom .....	23
Optional accessories .....	83

**P**

Panorama Maker.....	75
Paper size .....	26, 28
Party/indoor  .....	30, 31
Pet portrait auto release .....	34
Pet portrait  .....	30, 34
Photo info .....	65
PictBridge.....	72, 24
Playback.....	26, 67
Playback button.....	2, 26
Playback menu .....	61, 46
Playback mode.....	26
Playback zoom.....	59
Portrait  .....	30
Power.....	18
Power switch/power-on lamp.....	1, 18
Preset manual .....	36
Pressing halfway.....	25
Print .....	61, 72, 26, 28, 46
Print date.....	17, 69, 67
Print order.....	61, 46
Print order option.....	17, 47, 49
Printer.....	72, 24
Protect.....	61, 51

**Q**

Quick retouch.....	61, 15
--------------------	--------

**R**

Rechargeable battery .....	83
Rechargeable nickel-metal hydride batteries .....	10
Recording movies.....	63
Recording slow motion movies .....	66, 59, 60
Red-eye correction.....	61, 16
Red-eye reduction.....	42, 43
Remove from favorites .....	62, 8
Reset all .....	70, 76
Rotate image.....	61, 53
RSCN.....	82

**S**

Scene mode .....	30
Selective color  .....	35
Self-timer .....	44
Self-timer lamp.....	1, 45
Sepia.....	41
Sequence display options .....	62, 12, 57
Setup menu.....	69, 62
Shooting.....	18, 22, 24
Shooting menu.....	50, 33
Shooting mode button .....	2
Shutter sound.....	71
Shutter speed.....	25
Shutter-release button .....	1, 24
Single AF.....	66, 61
Single-frame shooting.....	51, 38

Refer to the *Reference Manual* for pages indicated with .

Skin softening.....	51, 61, 17, 43
Slide show .....	61, 50
Slow sync .....	42
Small picture .....	61, 20
Smart portrait menu.....	50, 43
Smart portrait mode .....	37
Smile timer .....	51, 44
Snow .....	30
Soft <b>SO</b> .....	35
Sound settings.....	70, 71
Speaker.....	2
Special effects mode.....	35
Sports .....	30, 31
SSCN.....	82
Standard color.....	41
Strap .....	3, 84
Sunset .....	30
<b>I</b>	
Thumbnail playback.....	60
Time difference .....	63
Time zone .....	15, 63
Time zone and date.....	14, 69, 63
Tripod socket .....	2, 18
TV .....	72, 22
TV settings .....	70, 73
<b>U</b>	
USB cable .....	72, 76, 25
USB/audio/video output connector .....	1, 71, 76, 22, 24

**V**

Vibration reduction.....	69, 68
Video mode.....	73
ViewNX 2.....	73, 74
Vivid color.....	41
Voice memo.....	61, 54
Volume .....	67, 54

**W**

WAV .....	82
Welcome screen .....	69, 62
White balance .....	51, 35
Wind noise reduction.....	66, 61

**Z**

Zoom .....	23
Zoom control.....	1, 23
Zoom in.....	23
Zoom out.....	23

Refer to the *Reference Manual* for pages indicated with .



A series of ten horizontal dashed lines spanning the width of the page, intended for handwriting practice.



No reproduction in any form of this manual, in whole or in part (except for brief quotation in critical articles or reviews), may be made without written authorization from NIKON CORPORATION.

**NIKON CORPORATION**

Printed in UAE

© 2013 Nikon Corporation

Download from [www.Somanuals.com](http://www.Somanuals.com). All Manuals Search And Download.



CT3G01(11)

6MN29011-01



## Free Manuals Download Website

<http://myh66.com>

<http://usermanuals.us>

<http://www.somanuals.com>

<http://www.4manuals.cc>

<http://www.manual-lib.com>

<http://www.404manual.com>

<http://www.luxmanual.com>

<http://aubethermostatmanual.com>

Golf course search by state

<http://golfingnear.com>

Email search by domain

<http://emailbydomain.com>

Auto manuals search

<http://auto.somanuals.com>

TV manuals search

<http://tv.somanuals.com>