

## Wireless Transmitter

# WT-3

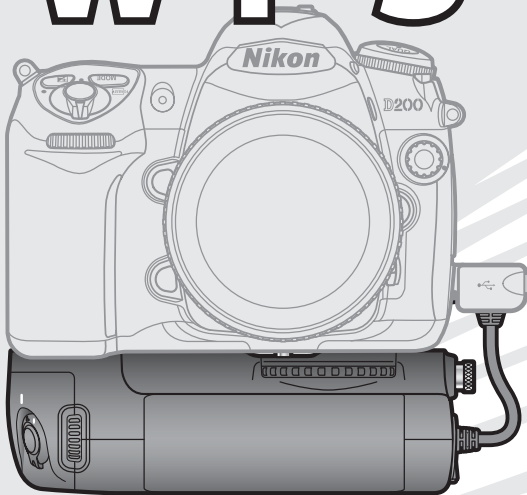

## User's Manual

### **Trademark Information**

Macintosh and Mac OS are trademarks of Apple Computer, Inc. Microsoft and Windows are registered trademarks of Microsoft Corporation. All other trade names mentioned in this manual or the other documentation provided with this Nikon product are trademarks or registered trademarks of their respective holders.

### **Apple Public Source License**

This product includes Apple mDNS source code that is subject to the terms of the Apple Public Source License located at URL <http://developer.apple.com/darwin/>.

Portions copyright © 1999-2004 Apple Computer, Inc. All Rights Reserved.

This file contains Original Code and/or Modifications of Original Code as defined in and that are subject to the Apple Public Source License Version 2.0 (the 'License'). You may not use this file except in compliance with the License. Please obtain a copy of the License at <http://www.opensource.apple.com/apsll> and read it before using this file.

The Original Code and all software distributed under the License are distributed on an 'AS IS' basis, WITHOUT WARRANTY OF ANY KIND, EITHER EXPRESS OR IMPLIED, AND APPLE HEREBY DISCLAIMS ALL SUCH WARRANTIES, INCLUDING WITHOUT LIMITATION, ANY WARRANTIES OF MERCHANTABILITY, FITNESS FOR A PARTICULAR PURPOSE, QUIET ENJOYMENT OR NON-INFRINGEMENT. Please see the License for the specific language governing rights and limitations under the License.

## For Your Safety

To prevent damage to your Nikon product or injury to yourself or to others, read the following safety precautions in their entirety before using this equipment. Keep these safety instructions where all those who use the product will read them.

The consequences that could result from failure to observe the precautions listed in this section are indicated by the following symbol:



This icon marks warnings, information that should be read before using this Nikon product to prevent possible injury.

### WARNINGS

#### Do not disassemble

Failure to observe this precaution could result in fire, electric shock, or other injury. Should the product break open as the result of a fall or other accident, disconnect the camera power source and take the product to a Nikon-authorized service representative for inspection.

#### Cut power immediately in the event of malfunction

Should you notice smoke or an unusual smell coming from the equipment, immediately unplug the AC adapter and remove the battery, taking care to avoid burns. Continued operation could result in injury. After removing the battery, take the equipment to a Nikon-authorized service representative for inspection.

#### Do not use in the presence of flammable gas

Failure to observe this precaution could result in explosion or fire.

#### Keep dry

Do not immerse in or expose to water or rain. Failure to observe this precaution could result in fire or electric shock.

#### Do not handle with wet hands

Failure to observe this precaution could result in electric shock.

#### Keep out of reach of children

Failure to observe this precaution could result in injury.

#### Observe proper precautions when handling batteries

Batteries may leak or explode if improperly handled. Observe the following precautions when handling batteries for use in this product:

- Be sure the product is off before replacing the battery. If you are using an AC adapter, be sure it is unplugged.
- Use only batteries approved for use in this equipment.
- Do not attempt to insert the battery upside down or backwards.
- Do not short or disassemble the battery.
- Do not expose the battery to flame or to excessive heat.
- Do not immerse in or expose to water.
- Replace the terminal cover when transporting the battery. Do not transport or store with metal objects such as necklaces or hairpins.
- Batteries are prone to leakage when fully discharged. To avoid damage to the product, be sure to remove the battery when no charge remains.
- When the battery is not in use, attach the terminal cover and store in a cool place.
- Immediately after use, or when the product is used on battery power for an extended period, the battery may become hot. Before removing the battery, turn the camera off and allow the battery to cool.
- Discontinue use immediately should you notice any changes in the battery, such as discoloration or deformation.

**⚠ Do not expose to high temperatures**

Do not leave the device in a closed vehicle under the sun or in other areas subject to extremely high temperatures. Failure to observe this precaution could result in fire or in damage to the casing or internal parts.

**⚠ Observe caution when using the WA-E1**

When using the WA-E1 extended range antenna (available separately), be careful not to put the tip of the antenna in your eye accidentally. Failure to observe this precaution could result in blindness or other visual impairment.

**⚠ CD-ROMs**

The CD-ROMs on which the software and manuals are distributed should not be played back on audio CD equipment. Playing CD-ROMs on an audio CD player could cause hearing loss or damage the equipment.

**⚠ Follow the instructions of hospital and airline personnel**

This device emits radio frequency radiation that could interfere with medical or navigational equipment. Do not use this device in a hospital or on board an airplane without first obtaining the permission of hospital or airline staff.

**Notices**

- No part of the manuals included with this product may be reproduced, transmitted, transcribed, stored in a retrieval system, or translated into any language in any form, by any means, without Nikon's prior written permission.
- Nikon reserves the right to change the specifications of the hardware and software described in these manuals at any time and without prior notice.
- Nikon will not be held liable for any damages resulting from the use of this product.
- While every effort has been made to ensure that the information in these manuals is accurate and complete, we would appreciate it were you to bring any errors or omissions to the attention of the Nikon representative in your area (address provided separately).

This product, which contains encryption software developed in the United States, is controlled by the United States Export Administration Regulations and may not be exported or re-exported to any country to which the United States embargoes goods. As of April 2006 the following countries were subject to embargo: Cuba, Iran, North Korea, Libya, Sudan, and Syria.

**Notice for Customers in the U.S.A.**

***U.S.A. Federal Communications Commission (FCC) Declaration of Conformity***

This device complies with Part 15 of the FCC rules. Operation of the device is subject to the following two conditions: (1) this device may not cause harmful interference, and (2) this device must accept any interference received, including interference that may cause undesired operation.

Products that contain a radio transmitter are labeled with FCC ID and may also carry the FCC logo.



**Nikon**  
**WT-3A**

### FCC Radio Frequency Interference Statement

This equipment has been tested and found to comply with the limits for a Class B digital device, pursuant to Part 15 of the FCC rules. These limits are designed to provide reasonable protection against harmful interference in a residential installation. This equipment generates, uses, and can radiate radio frequency energy and, if not installed and used in accordance with the instructions, may cause harmful interference to radio communications. However, there is no guarantee that interference will not occur in a particular installation. If this equipment does cause harmful interference to radio or television reception, which can be determined by turning the equipment off and on, the user is encouraged to try to correct the interference by one or more of the following measures:

- Reorient or relocate the receiving antenna.
- Increase the separation between the equipment and receiver.
- Connect the equipment into an outlet on a circuit different from that to which the receiver is connected.
- Consult the dealer or an experienced radio/television technician for help.

### CAUTIONS

#### *Modifications*

The FCC requires the user to be notified that any changes or modifications made to this device that are not expressly approved by Nikon Corporation may void the user's authority to operate the equipment.

#### *Interface Cables*

Use the interface cables sold or provided by Nikon for your equipment. Using other interface cables may exceed the limits of Class B Part 15 of the FCC rules.

### FCC Radiation Exposure Statement

The available scientific evidence does not show that any health problems are associated with using low power wireless devices. There is no proof, however, that these low power wireless devices are absolutely safe. Low power wireless devices emit low levels of radio frequency energy (RF) in the microwave range while being used. Whereas high levels of RF can produce health effects (by heating tissue), exposure to low level RF that does not produce heating effects causes no known adverse health effects. Many studies of low level RF exposures have not found any biological effects. Some studies have suggested that some biological effects might occur, but such findings have not been confirmed by additional research. This Wireless Transmitter (WT-3A) has been tested and found to comply with the Federal Communications Commission (FCC) guidelines on radio frequency energy (RF) exposures. The maximum SAR levels tested for the Wireless Transmitter (WT-3A) have been shown to be 0.2 W/kg at head.

This equipment complies with both FCC and IC radiation exposure limits set forth for an uncontrolled environment. When the Wireless Transmitter is connected with the WA-E1 extended range antenna, it is considered as a mobile radiator and should be installed and operated with a minimum distance of 20cm between the radiator and your body. This device should not be co-located or operated with any other antenna or transmitter.

#### **Notice for Customers in the State of California, U.S.A.**

**WARNING:** Handling the cord on this product will expose you to lead, a chemical known to the State of California to cause birth defects or other reproductive harm. *Wash hands after handling.*

Nikon Inc.,  
1300 Walt Whitman Road, Melville, New York  
11747-3064, U.S.A. Tel.: 631-547-4200

## Notices for Customers in Canada

**CAUTION:** This class B digital apparatus meets all requirements of the Canadian Interference Causing Equipment Regulations.

**ATTENTION:** Cet appareil numérique de la classe B respecte toutes les exigences du Règlement sur le matériel brouilleur du Canada.

### RSS-GEN Exposure of Humans to RF Fields

This equipment complies with both FCC and IC radiation exposure limits set forth for an uncontrolled environment. When the Wireless Transmitter is connected with the WA-E1 extended range antenna, it is considered as a mobile radiator and should be installed and operated with a minimum distance of 20 cm between the radiator and your body. The installer of this radio equipment must ensure that the antenna is located or pointed such that it does not emit RF field in excess of Health Canada limits for the general population; consult Safety Code 6, obtainable from Health Canada's website at <http://www.hc-sc.gc.ca/rpb>.

Operation is subject to the following two conditions: (1) this device may not cause interference, and (2) this device must accept any interference, including interference that may cause undesired operation of the device.

This device has been designed to operate with the antenna listed below, and having a maximum gain of 3.0 dB. Antennas not included in this list or having a gain greater than 3.0 dB are strictly prohibited for use with this device. The required antenna impedance is 50 ohms.

- The WA-E1 extended range antenna (available separately)

To reduce potential radio interference to other users, the antenna type and its gain should be so chosen that the equivalent isotropically radiated power (e.i.r.p.) is not more than that permitted for successful communication.

### Notice for Customers in Europe

Hereby, Nikon, declares that this digital camera is in compliance with the essential requirements and other relevant provisions of Directive 1999/5/EC.

### Notice for Customers in France

Outdoor use of wireless transceivers is prohibited in France.

### Symbol for Separate Collection in European Countries

This symbol indicates that this product is to be collected separately.

The following apply only to users in European countries:

- This product is designated for separate collection at an appropriate collection point. Do not dispose of as household waste.
- For more information, contact the retailer or the local authorities in charge of waste management.



## Table of Contents

For Your Safety.....	i	<b>Menu Guide.....</b>	<b>34</b>
Notices .....	ii	Wireless LAN System .....	34
<b>Introduction.....</b>	<b>1</b>	Mode.....	34
Supported Modes.....	2	Choose Profile .....	34
The WT-3 Setup Utility CD .....	2	FTP Registration (for Connection to ftp Servers Only) .....	35
System Requirements .....	3	Editing ftp Profiles .....	35
Parts of the WT-3 .....	4	<b>Settings (Transfer Mode Only) .....</b>	<b>46</b>
<b>Setup.....</b>	<b>6</b>	Auto Send .....	46
Updating the Camera Firmware .....	6	Delete After Send.....	46
Installing the WT-3 Setup Utility .....	7	Send File As.....	46
Copying Network Profiles to the Camera .....	11	Send Folder.....	47
Connecting the WT-3.....	18	Deselect All .....	47
Inserting the Battery.....	20	<b>Print (Print Mode Only) .....</b>	<b>47</b>
<b>Uploading Images: Transfer Mode.....</b>	<b>21</b>	<b>Appendices .....</b>	<b>48</b>
Connecting to the Host or ftp Server .....	21	Creating ftp Profiles Using the Camera Menus.....	48
Uploading Images.....	23	Troubleshooting .....	51
Interrupting Transmission .....	24	Glossary .....	52
Transfer Status .....	24	Specifications .....	55
Network Status .....	25	Index.....	56
<b>Controlling the Camera: PC Mode.....</b>	<b>26</b>		
Connecting to the Computer .....	26		
Controlling the Camera Using Nikon Capture 4 .....	28		
Network Status .....	29		
<b>Printing Pictures: Print Mode .....</b>	<b>30</b>		
Selecting a Printer.....	30		
Printing Pictures.....	31		
Printing Pictures Using the PD-10 Wireless Printer Adapter .....	32		





## Introduction

Thank you for purchasing a WT-3 or WT-3A wireless transmitter for compatible Nikon digital cameras. The WT-3 is for use in the country of sale, the countries of the European Union (EU) and European Free Trade Association (EFTA), Thailand, Japan, and Hong Kong. The WT-3A is for use in the country of sale, Canada, and the United States of America. The principal difference between the WT-3 and WT-3A is in the number of channels supported (14, 36); unless otherwise stated, all references to the WT-3 also apply to the WT-3A.

This manual describes how to connect the WT-3, how to control the camera from a computer, and how to transmit images to a computer or printer. Before using the WT-3, be sure to read the notices and warnings on pages i-iv.

The following symbols and conventions are used throughout this manual:



This icon marks cautions, information that should be read before use to prevent damage to the product.



This icon marks notes, information that should be read before using the device.



This icon marks tips, additional information that may be helpful when using the product.



This icon indicates that more information is available elsewhere in this manual.

### Background Knowledge

This manual assumes basic knowledge of ftp servers and local area networks (LAN). For more information on installing, configuring, and using devices in a network, contact the manufacturer or network administrator.

### Life-Long Learning

As part of Nikon's "Life-Long Learning" commitment to ongoing product support and education, continually-updated information is available on-line at the following sites:

- **For users in the U.S.A.:** <http://www.nikonusa.com/>
- **For users in Europe and Africa:** <http://www.europe-nikon.com/support>
- **For users in Asia, Oceania, and the Middle East:** <http://www.nikon-asia.com/>

Visit these sites to keep up-to-date with the latest product information, tips, answers to frequently-asked questions (FAQs), and general advice on digital imaging and photography. Additional information may be available from the Nikon representative in your area. See the URL below for contact information:

<http://nikonimaging.com/>

## Supported Modes

The WT-3 connects the camera to wireless and Ethernet networks. The camera can then be controlled remotely from a computer or photographs transmitted from the camera to an ftp server or printer. The WT-3 supports the following modes:

Mode	Host	Description	Network type	
Transfer mode	Computer or ftp server	Upload new or existing photographs to host.	Wireless and Ethernet	21
PC mode	Computer	Control camera from computer.		26
Print mode	Computer	Print JPEG photographs on printer connected to network computer.		30
	PD-10 wireless printer adapter	Print JPEG photographs on PictBridge printer connected to optional PD-10 wireless printer adapter.	Wireless only	32

## The WT-3 Setup Utility CD

The supplied WT-3 Setup Utility CD contains the following:

- **WT-3 Setup Utility** (📀 7, 11): Use this software to copy host profiles to the camera.
- **D200 A and B firmware version 2.00** (📀 6): Update to this version of the camera firmware before using the WT-3.
- **D200 firmware update manual** (📀 6): Read this manual for instructions on updating the camera firmware.

## Wireless Networks: Infrastructure Versus Ad-hoc

Wireless networks may be either *infrastructure* or *ad-hoc*.

- **Infrastructure:** Connection is via a wireless LAN access point.
- **Ad-hoc:** A peer-to-peer wireless network consisting solely of the WT-3 and the host.

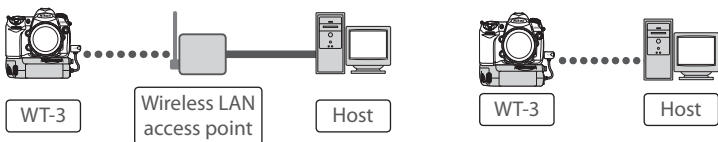

## System Requirements

Before using the WT-3 or WT-3 Setup Utility CD, confirm that your system meets the following requirements:

<b>Camera</b>	<ul style="list-style-type: none"><li>• <b>Model:</b> Nikon D200 digital single-lens reflex camera</li><li>• <b>Firmware:</b> A and B version 2.00 (provided on supplied WT-3 Setup Utility CD)</li></ul>
<b>Power source</b>	One EN-EL3e rechargeable Li-ion battery (supplied with D200) or EH-6 AC adapter (available separately)
<b>OS<sup>1</sup></b>	<ul style="list-style-type: none"><li>• <b>To connect to a computer:</b> Windows XP Service Pack 1 or later (Service Pack 2 recommended) or Mac OS X version 10.3 or later required (Power PC G4/G5 CPUs only). Connection to computers on other networks via router not supported.</li><li>• <b>To upload pictures to an ftp server:</b> Operation has been confirmed with Windows XP Professional and Mac OS X version 10.3 or later. Under these operating systems, ftp servers can be configured using standard ftp services such as IIS (Internet Information Services). Internet ftp connections and ftp servers running third-party software are not supported.</li></ul>
<b>Network</b>	<ul style="list-style-type: none"><li>• <b>Wireless:</b> Wireless LAN access point or computer with built-in or external wireless LAN adapter (IEEE 802.11b or 802.11g compliant).<sup>2</sup></li><li>• <b>Ethernet:</b> Ethernet cable and computer with built-in or external Ethernet port (100 base-TX or 10 base-T)</li></ul>
<b>Miscellaneous</b>	<ul style="list-style-type: none"><li>• <b>WT-3 Setup Utility:</b> required to copy computer profiles to camera (camera can be configured for use with ftp servers using either WT-3 Setup Utility or camera menus). WT-3 Setup Utility can not be used to configure camera for use with optional PD-10 wireless printer adapter.</li><li>• <b>CD-ROM drive:</b> required when installing WT-3 Setup Utility</li><li>• <b>USB:</b> UC-E4 USB cable (included with camera) and computer with built-in USB port required when copying network profiles to camera.<sup>3</sup></li></ul>

1. For the latest information on supported operating systems, see the Nikon website for your area (🌐 1).
2. For information on wireless network settings for Windows XP Professional and Mac OS X, see the online help for the WT-3 Setup Utility.
3. Connect the camera directly to the computer. The camera may not function as expected when connected via a hub, extension cable, or keyboard.

### The PD-10 Wireless Printer Adapter

A PictBridge-compatible printer with a flat (type A) USB connector is required for connection to the PD-10. A computer is not required.

### Multiple Transmitters

Simultaneous use of multiple WT-3 wireless transmitters with a single host may produce unexpected results. Do not attempt to use more than one WT-3 per host.

## Parts of the WT-3

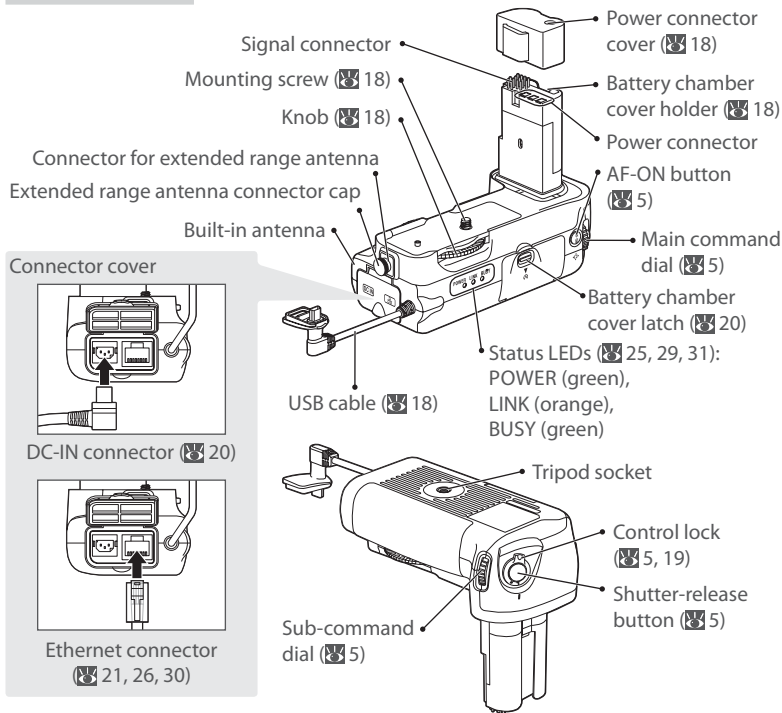

### The WA-E1 Extended Range Antenna (Available Separately)

The optional WA-E1 extended range antenna with tripod mount can be used to extend the range of wireless transmitters.

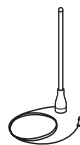

When using the WA-E1, remove the antenna connector cap (1) and connect the antenna as shown at right (2).



### Restrictions on Wireless Devices

Wireless regulations vary from country to country. Wireless devices are available for purchase only in countries in which they have been certified for use.

## The WT-3 Controls

The WT-3 is equipped with a shutter-release button, **AF-ON** button, and command dials for ease of use when taking photographs in tall (portrait) orientation. The shutter-release button and command dials perform the same functions as the matching controls on the camera body; for more information, see the camera manual. If desired, the controls on the WT-3 can be disabled by rotating the control lock to the **L** position. Please note that the control lock can not be used to turn the camera on or off.

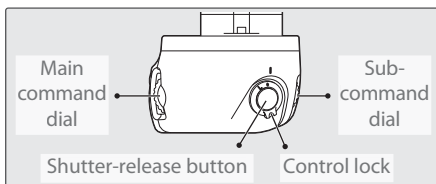

The command dials on the WT-3 are affected by the option selected for Custom Setting f5 (**Command dials**). See the camera manual for details.

The function performed by the WT-3 **AF-ON** button is determined by the option selected for Custom Setting a10 (**AF-ON for MB-D200**).

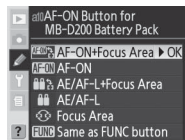

Option	Description
<b>AF-ON+ Focus Area</b> (default)	<b>AF-ON</b> button on WT-3 performs same function as camera <b>AF-ON</b> button. Focus area can be selected by pressing <b>AF-ON</b> button on WT-3 and rotating sub-command dial.
<b>AF-ON</b>	<b>AF-ON</b> button on WT-3 performs same function as camera <b>AF-ON</b> button.
<b>AE/AF-L+ Focus Area</b>	<b>AF-ON</b> button on WT-3 performs same function as camera <b>AE-L/AF-L</b> button. Focus area can be selected by pressing <b>AF-ON</b> button on WT-3 and rotating sub-command dial.
<b>AE/AF-L</b>	<b>AF-ON</b> button on WT-3 performs same function as camera <b>AE-L/AF-L</b> button.
<b>Focus Area</b>	Focus area can be selected by pressing <b>AF-ON</b> button on WT-3 and rotating sub-command dial.
<b>Same as FUNC button</b>	<b>AF-ON</b> button on WT-3 performs function currently assigned to camera <b>FUNC.</b> button using Custom Setting f4 ( <b>FUNC. Button</b> ).

# Setup

Follow the steps below to prepare the WT-3 for use:

**Update the camera firmware :** The WT-3 is supported from camera firmware A version 2.00 and B version 2.00. Users of earlier versions will need to update the camera firmware as described in the firmware update manual on the supplied WT-3 Setup Utility CD.

**Copy network profiles to the camera:** Users of Windows XP Service Pack 1 or later or Mac OS X version 10.3 or later can copy computer or printer profiles to the camera using the supplied WT-3 Setup Utility. Skip this step when using the camera rather than a computer to adjust settings for connection to an ftp server in transfer mode ( 48).

**Install the WT-3 Setup Utility ( 7)**

**Copy network profiles to the camera ( 11)**

**Connect the WT-3 ( 18)**

**Insert the battery ( 20)**

After setting up the WT-3 as described on the following pages, proceed to “Uploading Images: Transfer Mode” ( 21), “Controlling the Camera: PC Mode” ( 26), or “Printing Pictures: Print Mode” ( 30).

## Updating the Camera Firmware

The WT-3 is supported from camera firmware A version 2.00 and B version 2.00. Display the camera firmware version as described in the camera manual. If earlier versions are installed, update the camera firmware as described in the firmware update manual on the supplied WT-3 Setup Utility CD.

To display the firmware update manual, start the Install Center as described in Steps 1–3 of “Install the WT-3 Setup Utility” on page 7 (Windows) or 9 (Macintosh) and click **D200 Firmware** to display the “D200 Firmware” folder. Double-clicking **INDEX.pdf** displays a list of languages; click a language to display the update manual (Adobe Reader or Adobe Acrobat Reader 4.0 or later required).

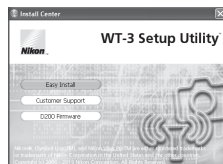

**D200 Firmware**

## Additional Updates

Once the camera firmware has been updated for use with the WT-3 as described above, all subsequent updates should be performed with the WT-3 connected ( 18) and **Off** selected for **Wireless transmitter > Wireless LAN system ( 34)**.

## Installing the WT-3 Setup Utility

The WT-3 Setup Utility is used to copy computer and printer profiles to the camera. The WT-3 Setup Utility is required when configuring the camera for connection to a computer in transfer, PC, and print modes. Either the WT-3 Setup Utility or the camera menus (🔗 48) can be used for connection to ftp servers in transfer mode.

Follow the steps below to install the WT-3 under Windows XP or Mac OS X.

### Supported Operating Systems

The WT-3 Setup Utility is compatible with Mac OS X version 10.3 or later (Power PC G4/G5 CPUs only) or a pre-installed version of Windows XP Service Pack 1 or later (Service Pack 2 recommended).

### Windows XP Service Pack 1 or Later

1 Start the computer and log in to an account with administrator privileges.

2 Insert the supplied installer CD in a CD-ROM drive. The "Select Region" dialog will be displayed; select a region and click **Next**.



#### If the "Select Region" Dialog Is Not Displayed

If the "Select Region" dialog is not displayed, select **My Computer** from the **Start** menu and double-click the icon for the CD-ROM drive containing the installer CD.

3 Select a language and click **Next**.

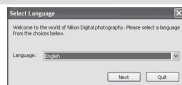

4 Click **Easy Install**.

#### Other Install Center Options

- **Customer Support:** View the ReadMe file or visit Nikon support websites.\*
- **D200 Firmware:** Update the camera firmware (🔗 6).  
\* Internet connection required.

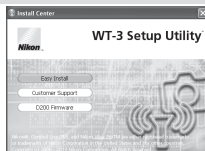

### The WT-3 Setup Utility

The WT-3 Setup Utility supplies the computer with information about the camera and controls image transfer. It must be installed on each of the host computers used by the WT-3. The WT-3 Setup Utility is not required for upload to an ftp server in transfer mode.

5 Click **Next**.

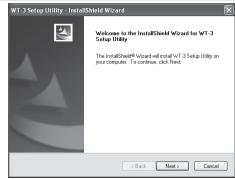

6 A license agreement will be displayed. After reading the agreement, select **I accept the terms in the license agreement** and click **Next** to accept and proceed with installation.

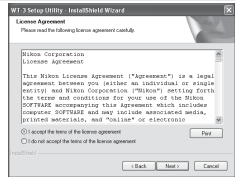

7 The default install location is displayed. Click **Next** to install the software to this folder. To choose another folder, click **Change...** and navigate to the desired location.

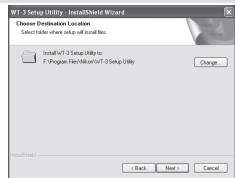

8 Clicking **Next** in Step 7 displays the dialog shown at right. Click **Install**.

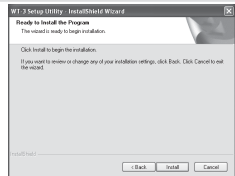

9 Click **Finish**.

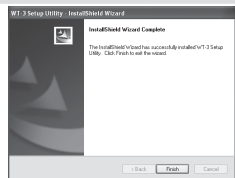

10 Click **Yes** and remove the WT-3 Setup Utility CD from the CD-ROM drive. If prompted to restart the computer, follow the on-screen instructions.

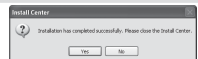



1 Start the computer and log in to an account with administrator privileges.

2 Insert the supplied installer CD in a CD-ROM drive. Double-click the installer CD icon on the desktop, and then double-click the **Welcome** icon. The "Select Region" dialog will be displayed; select a region and click **Next**.



3 Select a language and click **Next**.

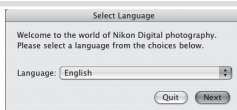

4 Click **Easy Install**.

#### Other Install Center Options

- **Customer Support:** View the ReadMe file or visit Nikon support websites.\*
- **D200 Firmware:** Update the camera firmware (6.6).  
\* Internet connection required.

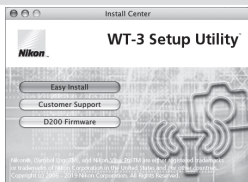

5 Enter the administrator name and password and click **OK**.



6 Read the license agreement and click **Continue**.



Click **Agree** to accept the terms of the license agreement and proceed with installation.



7 Click **Install**.

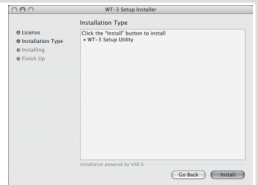

8 Click **Quit**.

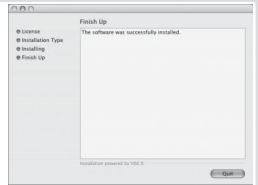

9 Click **OK** and remove the WT-3 Setup Utility CD from the CD-ROM drive. If prompted to restart the computer, follow the on-screen instructions.

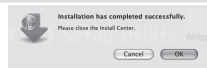

## Installing PictureProject

Install PictureProject before installing the WT-3 Setup Utility. The WT-3 Setup Utility must be reinstalled if PictureProject is installed after the WT-3 Setup Utility.

## Copying Network Profiles to the Camera

Profiles for network computers, ftp servers, and printers can be copied to the camera using the WT-3 Setup Utility. The WT-3 Setup Utility is required for connection to a computer in transfer, PC, and print modes. Either the WT-3 Setup Utility or the camera menus (🔑 48) can be used for connection to ftp servers in transfer mode.

### Supported Operating Systems

The WT-3 Setup Utility is compatible with Mac OS X version 10.3 or later (Power PC G4/G5 CPUs only) or a pre-installed version of Windows XP Service Pack 1 or later (Service Pack 2 recommended).

Before starting the WT-3 Setup Utility, ensure that the camera battery is fully charged or the optional EH-6 AC adapter is connected.

#### 1 Set the camera **USB** option to **PTP**.

1.1 Turn the camera on.



1.2 Select the **USB** in the camera setup menu and choose **PTP**.

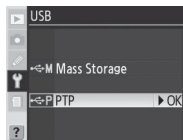

#### 2 Connect the UC-E4 USB cable supplied with the camera.

2.1 Turn the camera off.



2.2 Connect the UC-E4 as shown at right.

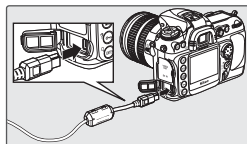

### Connecting the USB Cable

The USB cable can also be connected when the WT-3 is attached. Disconnect the WT-3 USB cable and connect the UC-E4 to the camera as described above.

3 Turn the camera on.



4 Turn the computer on and start the WT-3 Setup Utility.

- **Windows:** Double-click the **WT-3 Setup Utility** icon on the desktop
- **Macintosh:** Click the **WT-3 Setup Utility** icon in the Dock.

The dialog shown at right will be displayed; click **Next**.

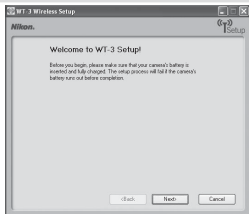

5 Select **Add/edit profile** and click **Next** to load camera network profiles into the computer.

For information on the other options in the "Select Action" dialog, see the note on the following page.

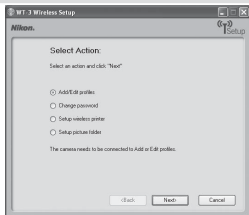

6 To add a new profile, select **Add new profile** and click **Next**. To edit an existing profile, select the profile and click **Next**. To delete an existing profile, select the profile and click **Delete**.

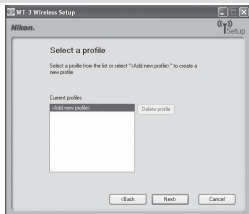

### Other Ways of Starting the WT-3 Setup Utility

WT-3 Setup Utility can also be started by:

- **Windows:** Clicking **Start** and selecting **All Programs > WT-3 Setup Utility > WT-3 Setup Utility**.
- **Macintosh:** Opening the "Applications:Nikon Software:WT-3 Setup Utility" folder and double-clicking the **WT-3 Setup Utility icon**.

## 7 Enter the following information.

- **Profile name:** Enter a name of up to 16 characters.
- **Profile type:** Choose **FTP server** to configure the camera for ftp (transfer mode only), or **Computer** to configure the camera for use with a computer in transfer (21), PC (26), and print (30) modes.
- **Interface type:** Choose **Ethernet only** if the network does not include wireless, or **Ethernet and Wireless** for wireless or wireless and Ethernet networks.

Click **Next**. When a new profile is created under

Windows XP Service Pack 2, the dialog shown in Step 8 will be displayed. With third-party LAN adapters or fixed IP addressing, or a profile created under Windows XP Service Pack 1 or Mac OS, proceed to Step 9 if **Ethernet and Wireless** is selected for interface type, or to Step 10 if **Ethernet only** is selected.

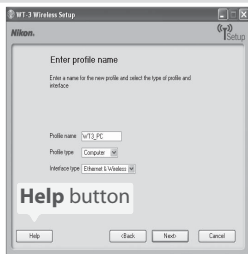

### Help

Click the **Help** button for online help.

### The "Select Action" Dialog

The other options in the "Select Action" dialog are described below. Note that the camera need not be connected to a computer to choose a printer or change the upload folder.

- **Change password:** The dialog shown at right will be displayed. By default, no password is required to change device profiles using the WT-3 Setup Utility. A password can be added by selecting **Change password**. If the camera is later connected to a different computer, a password prompt will be displayed. Once the correct password has been entered, the prompt will not be displayed again. To change an existing password, enter the old password before typing the new password. To remove the password, select **Reset password (profiles will be lost)** and click **Next**. Please note that resetting the password deletes all existing device profiles from the camera. Click **Back** to exit without changing password settings.
- **Setup wireless printer:** By default, the system default printer for the host computer will be used when printing pictures. To choose a different printer, select **Setup wireless printer** (17).
- **Setup picture folder:** The dialog shown at right will be displayed. Select a destination for uploaded pictures from the following options and click **Next**:



**Use PictureProject folder:** Pictures will be cataloged in PictureProject version 1.6.1 or later.

**Specify a different folder:** To choose a folder, click the  button.

The default destination is the "WT-3" folder in "My Pictures" (Windows) or "Pictures" (Macintosh).

8 Choose from the following options.

- **Automatic setup (recommended):** If more than one network adapter is available, choose an adapter from the pull-down menu (if **Ethernet only** is selected in Step 7, the menu will list Ethernet adapters only). Click **Next**. If **Ethernet and Wireless** was selected in Step 7 and the computer is configured for use with an existing infrastructure network, you will be prompted either to choose an existing infrastructure network or to set up a new ad-hoc network for use with the camera; select the desired option and click **Next**. If **FTP server** was selected in Step 7, proceed to Step 11. Otherwise proceed to Step 12.
- **Manual setup (for advanced users):** To adjust settings manually, select this option and click **Next**. If **Ethernet and Wireless** was selected in Step 7, proceed to Step 9. Otherwise proceed to Step 10.

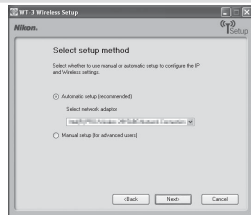

9 Enter wireless network settings and click **Next**.

- **Network name (SSID):** Enter a network name or choose from a list of existing networks (Ⓝ 36). Do not change the name if it is supplied automatically.
- **Network type:** Infrastructure or ad-hoc (Ⓝ 36).
- **Channel** (ad-hoc networks only): Choose the channel (1–13) used by the host. If channel 12 or 13 is selected for the WT-3A, channel 11 will be used instead.
- **Authentication:** Choose the type of authentication used by the computer or access point. The camera supports WPA-PSK, WPA2-PSK, open system, and shared key authentication. WPA-PSK and WPA2-PSK are available only in infrastructure mode.
- **Encryption:** Choose the type of encryption used on the network. Depending on the authentication used, the following types of encryption are available:  
**Open:** none, 64-bit WEP, 128-bit WEP      **Shared:** 64-bit WEP, 128-bit WEP  
**WPA-PSK:** TKIP, AES      **WPA2-PSK:** AES
- **Encryption key:** If the network uses encryption, enter the network key. The number of the characters required depends on the type of encryption used:

	WEP (64-bit)	WEP (128-bit)	TKIP, AES
Number of characters (ASCII)	5	13	8–63
Number of characters (hexadecimal)	10	26	64

- **Key index:** In infrastructure networks that use WEP encryption, enter the host or access point key index. The default index is 1.

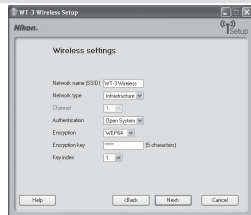

## 10 Enter network TCP/IP settings.

- **Obtain IP address automatically:** Select this option if the network is configured to supply IP addresses automatically. If the network does not include a DHCP server, addresses will be supplied by Auto IP (52).
- **IP address:** If the network is configured for manual IP addressing, enter an IP address for the WT-3.
- **Subnet mask:** If the network is configured for manual IP addressing, enter a subnet mask for the WT-3.
- **Default gateway:** If the network requires a gateway address, select this option and enter the address supplied by the network administrator. This option applies only if **FTP server** is selected for **Profile type** in Step 7.
- **DNS server:** If a **Domain Name Server** exists on the network, select this option and enter the address supplied by the network administrator. This option applies only if **FTP server** is selected for **Profile type** in Step 7.

Click **Next**. If **FTP server** was selected for **Profile type** in Step 7, the dialog shown in Step 11 will be displayed. Otherwise proceed to Step 12.

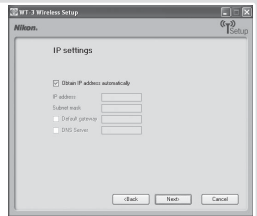

## 11 Enter ftp settings and click **Next**.

- **FTP server name:** Enter the URL or IP address of the ftp server.
- **FTP server port:** Enter the port number for the ftp server. The default is port 21.
- **FTP server path:** Choose the folder to which pictures will be uploaded. If no path is specified, pictures will be uploaded to the home directory.
- **Use anonymous login:** Select this option for anonymous login, or leave this option unchecked to supply a user name and password.
- **Use FTP server proxy:** If a proxy server is required for ftp, select this option and enter the server name and port number for the proxy server.
- **Passive mode:** Select this option to use PASV mode.

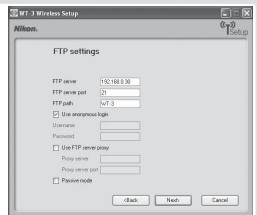

## Ad-hoc Wireless Networks

Ad-hoc mode uses IP addresses beginning with 169.254. If the computer later becomes part of an infrastructure network, it must be reconfigured for automatic IP addressing and the camera wireless profile modified to reflect the new settings. Consult the network administrator for details.

- 12 Network settings will be listed as shown at right. Click **Next** to proceed to Step 13, or **Back** to return to the previous step.

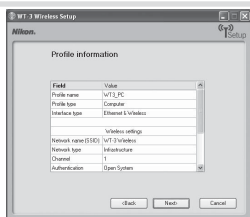

- 13 The dialog shown at right will be displayed. Select **Finish wizard** and click **Next** to exit the WT-3 Setup Utility and proceed to Step 14, or choose **Select another action to perform** and click **Next** to return to Step 5 (12) and add or edit profiles, change the password, choose a printer, or change the upload folder.

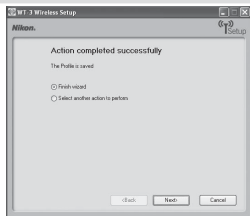

- 14 Turn the camera off and disconnect the USB cable.

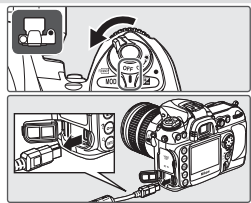

### MAC Address Filtering

If the network using MAC address filtering, the filter must be supplied with the MAC address of the WT-3. After attaching the WT-3 to the camera, choose **Firmware version > MAC address** from the camera setup menu and note the wireless and Ethernet MAC addresses.

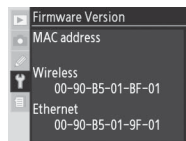

### Firewall Settings

The WT-3 uses TCP ports 20 and 21 for ftp and TCP port 15740 and UDP port 5353 when connecting to a computer. Computer firewalls must be configured to allow access to these ports, as otherwise the computer may not be able to access the WT-3.

### Profiles

A separate profile must be created for each host and ftp server.



## Creating a Printer Profile

The default printer for computer profiles (🔗 13) is the system printer for the host computer. To choose a different printer, start the WT-3 Setup Utility as described in Step 4 of “Copying Network Profiles to the Camera” (🔗 12; there is no need to connect the camera to the computer), then follow the steps below.

### Using the PD-10

See “Printing Pictures Using the PD-10 Wireless Printer Adapter” (🔗 32) for more information on printing pictures using the PD-10.

- 1 Select **Setup wireless printer** in the “Select Action” dialog and click **Next**.

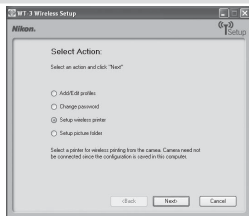

- 2 Choose a printer and click **Next**.

- **Windows:** Select a printer from the pull-down menu. Printer settings can be adjusted in the Windows “Printer and Fax” dialog before printing.

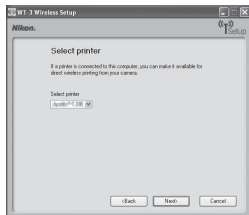

- **Macintosh:** Click **Select Printer...** to choose a printer and adjust printer settings. Click **Print** to return to the WT-3 Setup Utility.



- 3 Exit the WT-3 Setup Utility and disconnect the camera as described in Steps 13–14 of “Copying Network Profiles to the Camera” (🔗 16).

## Connecting the WT-3

- 1 Turn the camera off and rotate the control lock on the WT-3 to the **L** position.



- 2 Remove the power connector cover from the WT-3 and attach it to the camera strap or store it in a safe place. Be sure to replace the power connector cover when the WT-3 is not in use.

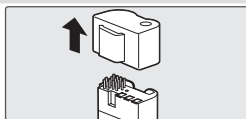

- 3 Open the camera battery chamber cover and remove the battery, then remove the battery chamber cover as shown at right.

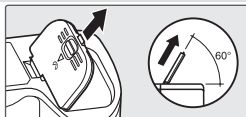

**Important:** To ensure that the cover is not lost, place it in the WT-3 battery chamber cover holder.

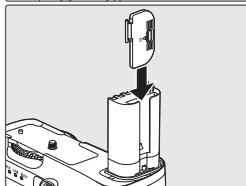

- 4 Insert the WT-3 into the camera battery chamber as shown.

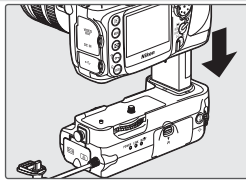

- 5 Rotate the knob in the direction shown to fasten the WT-3 securely to the camera.



- 6 Open the camera USB connector cover and connect the USB cable from the WT-3 to the camera USB connector.

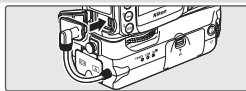

## **PB-6 Bellows**

A PK-13 auto-extension ring and a PB-6D spacer are required when using PB-6 bellows with the WT-3.

## **Disconnecting the WT-3**

To disconnect the WT-3:

**1** Rotate the WT-3 control lock to the **L** position and turn the camera off.



**2** Disconnect the USB cable.

**3** Rotate the knob clockwise to unscrew the WT-3 from the camera tripod mount and remove the WT-3 from the camera battery chamber.

**4** Replace the camera battery chamber cover.

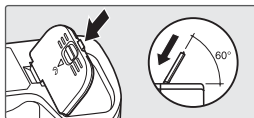

## **The Control Lock**

Turn the camera off and rotate the WT-3 control lock to the **L** position when connecting or disconnecting the WT-3 or inserting or removing the battery.

## Inserting the Battery

To power the camera when the WT-3 is in place, insert the camera battery into the WT-3 battery chamber. The WT-3 takes one EN-EL3e rechargeable Li-ion battery; other batteries can not be used. Note that the drain on the battery is increased when the WT-3 is attached.

- 1 Turn the camera off and rotate the control lock on the WT-3 to the **L** position.



- 2 Open the battery chamber cover.

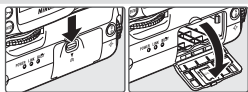

- 3 Insert the battery as shown on the inside of the battery chamber cover. The battery latch will slide aside during insertion and pop up to lock the battery in place when fully inserted.

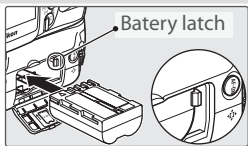

- 4 Close the battery-chamber cover. Make sure the cover is properly latched. The latch will click into place when the cover is fully closed.



- 5 Turn the camera on and check the battery level in the control panel or viewfinder or using the **Battery Info** option in the camera setup menu.



## Removing the Battery

Being careful not to drop the battery, open the battery chamber cover and remove the battery as shown at right.

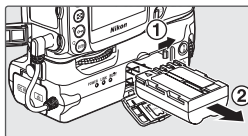

## The EH-6 AC Adapter

The optional EH-6 AC adapter can also be used to power the camera when the WT-3 is connected. Connect the DC plug on the AC adapter to the WT-3 DC-IN connector, not to the camera.

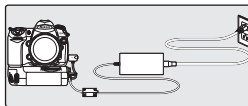

## Uploading Images: Transfer Mode

Choose transfer mode to upload photographs to a computer or ftp server. The principal steps are:

1 Connect to the host or ftp server..... 21-22

2 Upload images ..... 23-25

Before connecting to the host, create a host profile using the WT-3 Setup Utility (21-22) and be sure that the host is running. Settings for connection for an ftp server can also be adjusted from the camera menus (48-50).

### Connecting to the Host or ftp Server

- 1 Turn the camera off and insert the memory card containing the pictures to be sent.

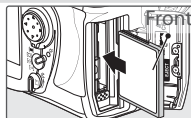

- 2 To access the network via Ethernet, connect the Ethernet cable (4). Note that wireless transfer is disabled while an Ethernet cable is connected. Disconnect the Ethernet cable before accessing a wireless network. Turn the camera off before connecting or disconnecting the Ethernet cable.

- 3 Turn the camera on.



- 4 Select **Transfer mode** for the **Wireless transmitter** > **Mode** option in the camera setup menu (34).

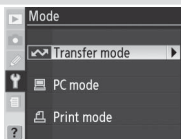

### Choose PTP



Before connecting the WT-3, set the **USB** option in the camera setup menu to **PTP** (11).

- 5 A list of available connection profiles will be displayed. Press the multi selector up or down to highlight the desired profile and press to the right to select.

#### Viewing Profile Information

Press the camera  button to view information on the selected profile.

#### Editing ftp Server Profiles

If an ftp server profile is selected, ftp settings can be edited manually by pressing the camera  button. See the Menu Guide for more information ( 35).

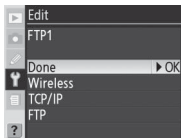
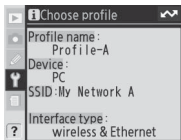

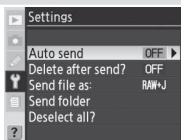

- 6 Choose **Settings** in **Wireless transmitter** menu to edit the following transfer options:

Option	Description	
<b>Auto send</b>	Upload photos as they are taken.	46
<b>Delete after send?</b>	Delete photos from camera memory card after upload.	46
<b>Send file as</b>	Send NEF + JPEG images as JPEG only or as NEF and JPEG.	46
<b>Send folder</b>	Upload all photos in selected folder.	47
<b>Deselect all?</b>	Deselect all images selected for upload.	47

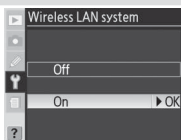

- 7 Select **On** for **Wireless transmitter > Wireless LAN system** ( 34).



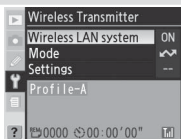

- 8 Confirm that the selected profile is displayed in green in the top level of the wireless transmitter menu. For information on what to do if an error is displayed, see "Troubleshooting" ( 51).



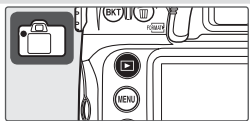

## Uploading Images

- 1 Press the  button to view pictures on the memory card. Display the first picture to be sent in single-image playback or highlight it in the thumbnail list.

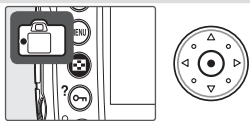

- 2 Press the center of the multi selector while pressing the  button. The image will be marked with a white "send" icon and transmission will begin immediately. During upload, images are marked with a green "sending" icon. Repeat this process to send additional images (pictures will be sent in the order selected).



Images that have been successfully uploaded are marked with a blue "sent" icon. Images can be re-sent by pressing the center of the multi selector while pressing the  button to change the blue "sent" icon to a white "send" icon.

### During Upload

Do not remove the memory card or disconnect the Ethernet cable during upload.

### File Names

If the destination folder on an ftp server contains files with the same names as images selected for upload, the files on the server will be *replaced* by the images uploaded from the camera. Selecting **On** for Custom Setting d6 (**File No. Sequence**) during shooting will prevent the camera from creating files with duplicate file names. When uploading files from multiple cameras to the same server, assign each camera its own folder.

### Loss of Signal

Transmission may be interrupted if the signal is lost ( 25). Transmission can be resumed by turning the camera off and then on again, activating the camera exposure meters, or selecting **On** for **Wireless transmitter > Wireless LAN system** once the signal is restored.

## Interrupting Transmission

To cancel transmission of images marked with a white “send” icon or green “sending” icon, select the images during playback and press the center of the multi-selector while pressing the  button. The icon will be removed. Any of the following actions will also interrupt transmission:

- Turning the camera off
- Choosing **Off** in the **Wireless transmitter > Wireless LAN system** menu
- Selecting **Yes** for **Wireless transmitter > Settings > Deselect all**

## Transfer Status

During playback, the status of images selected for upload is shown as follows:

### : “Send”

Images that have been selected for upload are marked with a white  icon.



### : “Sending”

A green  icon is displayed during upload.



### : “Sent”

Images that have been uploaded successfully are marked with a blue  icon.



## Turning the Camera Off

“Send” marking will be saved if the camera is turned off or **Off** is selected for **Wireless transmitter > Wireless LAN system** while transmission is in progress. Transmission of images marked with a “send” icon will resume when the camera is turned on, the shutter-release button is pressed halfway, or **On** is selected for **Wireless transmitter > Wireless LAN system**.

## Removing the “Send,” “Sending,” and “Sent” Icons

“Send,” “sending,” and “sent” icons can be removed from all images by selecting **Yes** for **Wireless transmitter > Settings > Deselect all?** ( 47).



## Network Status

The status of the link between the server and the WT-3 is shown by the status LEDs and by the display in the top level of the wireless transmitter menu.

### The Status LEDs

The **POWER** LED lights when the WT-3 is on. Signal quality is shown by the **LINK** LED: the faster the LED blinks, the better the signal and the faster data can be transmitted. The **BUSY** LED lights while data are being sent.

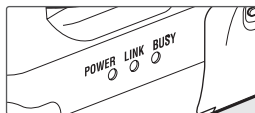



Status	POWER	LINK	BUSY
Camera or exposure meters off, or <b>Off</b> selected for <b>Wireless transmitter &gt; Wireless LAN system</b>	● (off)	● (off)	● (off)
Connecting to host computer or ftp server	○ (on)	○ (on)	● (off)
Waiting to send data	○ (on)	⚙ (blinks)	● (off)
Sending data	○ (on)	⚙ (blinks)	○ (on)
Connection error	⚙ (blinks)	● (off)	● (off)
WT-3 hardware malfunction	⚙ (blinks)	⚙ (blinks)	⚙ (blinks)

### The Status Display

Network status can also be viewed in the top level of the wireless transmitter menu.

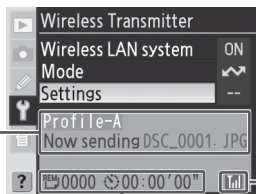
**Status area:** The status of the connection to the host. The host name is displayed in green when a connection is established. While files are being transferred, the status display shows "Now sending" followed by the name of the file being sent. Any errors that occur during transfer are also displayed here.



**REM** : The estimated time required to send the remaining images.

**Signal strength:** This icon shows five levels of wireless signal strength. It is displayed in red when no signal can be detected. For maximum signal strength, ensure a clear line of sight between the WT-3 antenna and the wireless LAN adapter or access point. A  icon is displayed when the WT-3 is connected via Ethernet.

## Controlling the Camera: PC Mode

In PC mode, a camera equipped with a WT-3 can be controlled over a wireless network from a computer running Nikon Capture 4 version 4.4 or later (available separately) and photographs saved directly to the computer hard disk instead of the camera memory card. The principal steps are:

**Connect to the computer** .....  26–27

**Control the camera using Nikon Capture 4** .....  28–29

The WT-3 Setup Utility must be installed on the host computer. Before connecting to the host, create a host profile using the WT-3 Setup Utility ( 11–16) and be sure that the host is running.

### Connecting to the Computer

**1** To access the network via Ethernet, connect the Ethernet cable ( 4). Note that wireless transfer is disabled while an Ethernet cable is connected. Disconnect the Ethernet cable before accessing a wireless network. Turn the camera off before connecting or disconnecting the Ethernet cable.

**2** Turn the camera on.



**3** Select **PC mode** for the **Wireless transmitter > Mode** option in the camera setup menu ( 34).

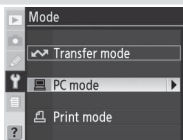

#### Choose PTP

Before connecting the WT-3, set the **USB** option in the camera setup menu to **PTP** ( 11).

#### PictureProject Version 1.6.1 or Later

In PC mode, PictureProject Transfer can be used to transfer pictures to the computer, where they will be cataloged in the PictureProject software supplied with the camera (version 1.6.1 or later required).

- 4 A list of available connection profiles will be displayed. Press the multi selector up or down to highlight the desired profile and press to the right to select.

#### Viewing Profile Information

Press the camera  button to view information on the selected profile.

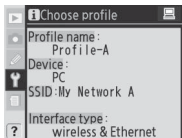

- 5 Select **On** for **Wireless transmitter > Wireless LAN system** ( 34).

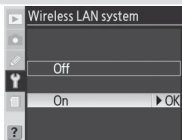

- 6 The message "Now in PC mode" will be displayed in the top level of the wireless transmitter menu when a connection is established. For information on what to do if an error is displayed, see "Troubleshooting" ( 51).

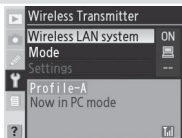

## Controlling the Camera Using Nikon Capture 4

1 Complete the steps in "Connecting to a Computer" (📖 26).

2 Start Nikon Capture 4 Camera Control on the host computer and confirm that **PC** is displayed in the camera control panel.



3 Control the camera as described in the *Nikon Capture 4 User's Manual*. Any photographs taken while the camera is connected will be recorded directly to the computer hard disk.

### ✓ Ethernet Networks: Do Not Disconnect the Ethernet Cable

Do not disconnect the Ethernet cable while the camera is on.

### ✎ Wireless Networks: Loss of Signal During Transfer

A loss of signal may interrupt the connection while pictures are being transferred to Nikon Capture 4 Camera Control. If the **POWER** LED on the WT-3 is blinking (📖 29), select **Off** for the **Wireless transmitter > Wireless LAN system** option in the camera setup menu and then select **On** again. Transfer will resume when the connection is re-established. *Do not turn the camera off.* Transfer can not be resumed once the camera is turned off.

## Network Status

The status of the link between the server and the WT-3 is shown by the status LEDs and by the display in the top level of the wireless transmitter menu.

### The Status LEDs

The **POWER** LED lights when the WT-3 is on. Signal quality is shown by the **LINK** LED: the faster the LED blinks, the better the signal and the faster data can be transmitted. The **BUSY** LED lights while data are being sent.

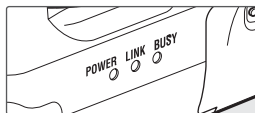



Status	POWER	LINK	BUSY
Camera or exposure meters off, or <b>Off</b> selected for <b>Wireless transmitter &gt; Wireless LAN system</b>	● (off)	● (off)	● (off)
Connecting to computer	○ (on)	○ (on)	● (off)
Waiting for connection	○ (on)	✳ (blinks)	● (off)
Connected; camera control possible	○ (on)	✳ (blinks)	○ (on)
Connection error	✳ (blinks)	● (off)	● (off)
WT-3 hardware malfunction	✳ (blinks)	✳ (blinks)	✳ (blinks)

### The Status Display

Network status can also be viewed in the top level of the wireless transmitter menu.

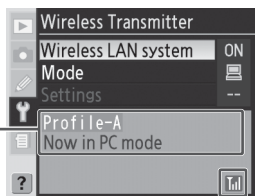
**Status area:** The status of the connection to the host. The host name is displayed in green when a connection is established. Any errors that prevent the camera from connecting to the host are also displayed here.



**Signal strength:** This icon shows five levels of wireless signal strength. It is displayed in red when no signal can be detected. For maximum signal strength, ensure a clear line of sight between the WT-3 antenna and the wireless LAN adapter or access point. A  icon is displayed when the WT-3 is connected via Ethernet.

## Printing Pictures: Print Mode

Choose print mode to print JPEG pictures from the camera to a printer connected to a network computer or to the optional PD-10 wireless printer adapter (📷 32). RAW pictures can not be printed directly from the camera, but can be printed using PictureProject or Nikon Capture version 4.4 or later. Index prints are available with the PD-10 only. The principal steps in printing JPEG pictures from the camera are:

Select a printer ..... 📷 30–31

Print pictures ..... 📷 31

Before printing, create a host profile (📷 11–16) and adjust printer settings (📷 17).

### Selecting a Printer

- 1 Turn the camera off and insert the memory card containing the pictures to be printed.

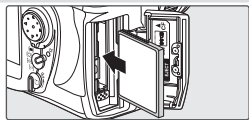

- 2 To access the network via Ethernet, connect the Ethernet cable (📷 4). Note that wireless transfer is disabled while an Ethernet cable is connected. Disconnect the Ethernet cable before accessing a wireless network. Turn the camera off before connecting or disconnecting the Ethernet cable.

- 3 Turn the camera on and confirm that the printer and host computer or wireless printer adapter are on.



- 4 Select **Print mode** for the **Wireless transmitter > Mode** option in the camera setup menu (📷 34).

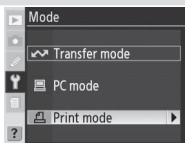

### Choose PTP

Before connecting the WT-3, set the **USB** option in the camera setup menu to **PTP** (📷 11).

### Use a Reliable Power Source

Be sure the camera battery is fully charged or use an EH-6 AC adapter (available separately).

- 5 A list of available printer profiles will be displayed. Press the multi selector up or down to highlight the desired profile, then press to the right to select and return to the top level of the wireless transmitter menu.

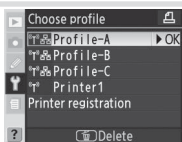

#### Viewing Profile Information

Press the camera button to view information on the selected profile.

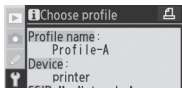

## Printing Pictures

- 1 Select **On** for **Wireless transmitter > Wireless LAN system** ( 34).

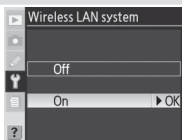

- 2 Select **Print** in the top level of the wireless transmitter menu to connect to the printer. The status LEDs will light as a connection is negotiated with the printer.

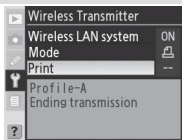

- 3 Print photographs from the Print menu as described in "Printing Via Direct USB Connection: Printing Multiple Photographs" in the camera manual. The index print option is only available with the optional PD-10 wireless printer adapter.

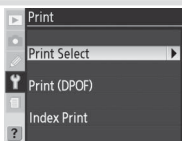

### The Status LEDs

The **POWER** LED lights when the WT-3 is on. Signal quality is shown by the **LINK** LED: the faster the LED blinks, the better the signal and the faster data can be transmitted. The **BUSY** LED lights while data are being sent.

Status	POWER	LINK	BUSY
Camera or exposure meters off, camera not connected to printer, or transmission error	● (off)	● (off)	● (off)
Connected to printer; pictures can be printed	○ (on)	⚡ (blinks)	○ (on)
Error connecting to printer	⚡ (blinks)	● (off)	● (off)
WT-3 hardware malfunction	⚡ (blinks)	⚡ (blinks)	⚡ (blinks)

## Printing Pictures Using the PD-10 Wireless Printer Adapter

The optional PD-10 wireless printer adapter allows photographs to be printed directly from the camera without cables or a computer. The principal steps for using the PD-10 are:

Create a profile for the PD-10 ..... 32–33

Selecting a printer ..... 30–31

Print pictures ..... 31

See the PD-10 manual for more information. The first step can be omitted once a profile has been created.

### Creating a Profile for the PD-10

- 1 Connect the PD-10 to a PictBridge-compatible printer as described in the PD-10 manual and turn both the PD-10 and printer on.

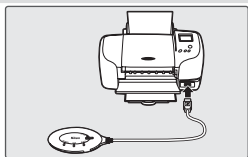

- 2 Turn the camera on.



- 3 Select **On** for the **Wireless transmitter > Wireless LAN system** option in the camera setup menu (34).

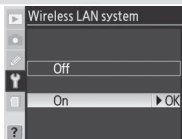

- 4 Select **Print mode** for **Wireless transmitter > Mode** (34).

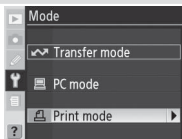



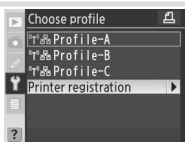

- 5 Select **Printer registration**. Note that printer registration will not be available if the camera already contains nine profiles; if necessary, delete a profile using the  button.

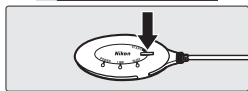

- 6 The message shown at right will be displayed in the camera monitor. Press the **START** button on the wireless printer adapter for about two seconds.



- 7 A message will be displayed asking if you want to connect to the printer. Select **Yes** to print pictures from the Print menu ( 31), or **No** to return to Step 5. The PD-10 can now be selected from the profile list as described in "Selecting a Printer" ( 30).

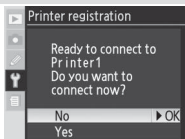

# Menu Guide

This section describes the settings available for the **Wireless transmitter** option in the camera setup menu when the WT-3 is connected.

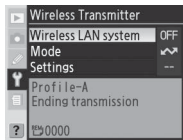

## Wireless LAN System

Turn the WT-3 on or off. Select **Off** to reduce the drain on the battery. When **On** is selected, power consumption is reduced if no memory card is inserted in transfer and print modes or if no data are being transmitted in print mode. Note that in transfer mode transfer will resume immediately when the transceiver is turned on.

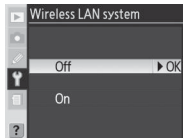

## Mode

Choose from **Transfer mode** (F21), **PC mode** (F26), and **Print mode** (F30). Selecting any of these options displays a profile list showing the connections available in the selected mode.

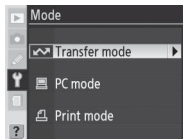

## Choose Profile

Selecting an option from the **Mode** menu displays a profile list showing the connections available in the selected mode. The WT-3 can store a total of up to nine host, server, and printer profiles. To delete a profile, highlight it in the profile list and press the **Delete** button. To edit an ftp server profile, highlight the profile and press the **Edit** button (F35).



To view profile information, highlight the desired profile and press the **Info** button. The following information will be displayed.

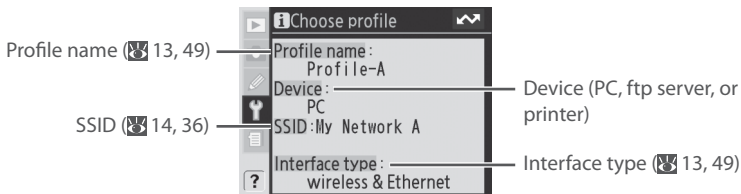

## FTP Registration (for Connection to ftp Servers Only)

In transfer mode, ftp profiles can be created without using the WT-3 Setup Utility. See the Appendix for more information (48).

### Editing ftp Profiles

To edit an ftp server profile, highlight it in the profile list in transfer mode and press the **OK** button. Choose the settings to be edited from **Wireless**, **TCP/IP**, and **FTP**, or select **Done** to save changes and return to the profile list. Only ftp server profiles can be edited in this fashion; to edit other profiles, use the WT-3 Setup Utility.

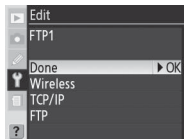

### Wireless

This option contains settings for connection to a wireless network and is only displayed if the interface type for the selected profile is **Wireless & Ethernet**. The wireless menu has two pages of options; to scroll between pages, press the multi-selector up or down.

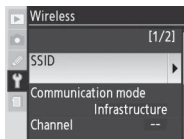

### Text Entry

The following dialog is displayed when text entry is required.

**Keyboard area:** Use multi selector to highlight letters, press center to select.



**Text display area:** Text appears in this area. To move cursor, press **OK** while using up, down, left, and right buttons on multi-selector.

Use the multi selector to highlight the desired character in the keyboard area and press the center of the multi selector to insert the highlighted character at the current cursor position (note that if a character is entered when the field is full, the last character in the field will be deleted). To delete the character under the cursor, press the **DEL** button. To move the cursor to a new position, press the **OK** button while using the multi-selector.

To complete entry and return to the previous menu, press the **OK** button. To exit to the previous menu without completing text entry, press **END**.

**SSID:** A BSS- or ESS-ID is required for connection to a wireless LAN adapter or access point. To change the BSS- or ESS-ID, highlight the current ID, press the multi selector to the right, and enter a new ID as described in the note on the previous page. Press **ENTER** to return to the wireless menu (1/2).

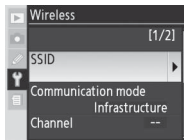

**Communication mode:** Choose a mode according to how the wireless network is set up.

Option	Description
<b>Infrastructure</b> (default)	Connection to wireless network is via access point.
<b>Ad-hoc</b>	Direct peer-to-peer wireless connection to host.

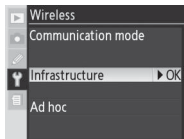

### Channel\*

1

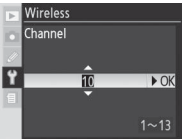
Choose channel.†

2

Return to wireless menu (1/2).

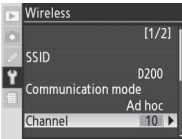
\* Not required if **Infrastructure** is selected for **Communication mode**.

† The WT-3 offers a choice of thirteen channels (1–13), the WT-3A a choice of eleven channels (1–11).

### Wireless Menu, Page 2/2

**Authentication:** Choose the type of authentication used by the computer or access point. The camera supports WPA-PSK, WPA2-PSK, open system, and shared key authentication. WPA-PSK and WPA2-PSK are available only in infrastructure mode.



### Using the Menus

If the shutter-release button on the camera or WT-3 is pressed while menus are displayed, the monitor will turn off and any changes to the current profile will be lost. Do not press the shutter-release button while editing profiles.

## Encryption

1

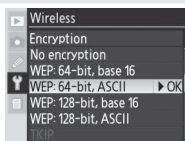

Highlight encryption method.

2



Return to wireless menu (2/2).

3



Highlight encryption key. Skip Steps 3–5 if **No encryption** was selected in Steps 1–2.

4

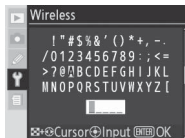

Edit encryption key:

- Base 16: press multi selector left or right to select character, up or down to change. 64-bit keys require 10 digits, 128-bit keys 26 digits, TKIP and AES keys 64 digits.
- ASCII: enter key as described on page 26. 64-bit keys are 5 characters long, 128-bit keys 13 characters long, TKIP and AES keys 8 to 63 characters long.

5

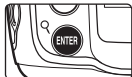

Return to wireless menu (2/2).

## Encryption

The type of encryption available depends on the option selected for **Authentication** (26, 36):

- **Open:** none, Wep: 64-bit,base 16, Wep: 64-bit,ASCII, Wep: 128-bit,base 16, Wep: 128-bit,ASCII
- **Shared:** Wep: 64-bit,base 16, Wep: 64-bit,ASCII, Wep: 128-bit,base 16, Wep: 128-bit,ASCII
- **WPA-PSK:** TKIP, AES
- **WPA2-PSK:** AES

**Key index:** In infrastructure networks that use WEP encryption, choose the key index used by the host or access point.

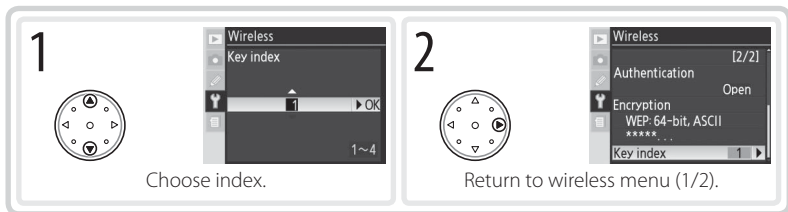

### TCP/IP

Adjust TCP/IP settings as described on the following pages. The TCP/IP menu has two pages of options; to scroll between pages, press the multi selector up or down.

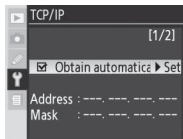

### TCP/IP Menu, Page 1/2

**Obtain automatically:** Highlight this option and press the multi selector right to toggle it on (✓) or off. Turn this option on if the wireless network is configured to supply an IP address automatically by DHCP server or Auto IP (52). Otherwise turn it off and enter the address and subnet mask supplied by the network administrator as described on the following page.

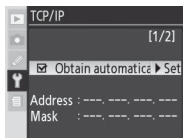

1

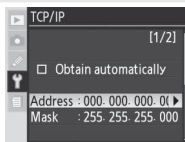

Highlight **Address**.

2

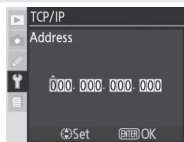

Enter edit mode.

3

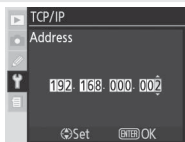

Press multi selector left or right to select, up or down to change.

4

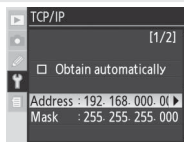
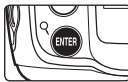

Exit to TCP/IP menu (1/2). If subnet mask is required, proceed to Step 5.

5

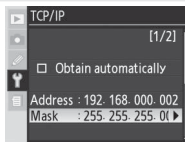

Highlight **Mask**.

6

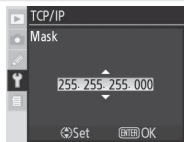

Enter edit mode.

7

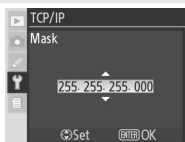

Choose subnet mask.

8

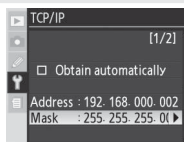
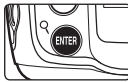

Exit to TCP/IP menu (1/2).

**Use gateway:** Highlight this option and press the multi selector right to toggle it on (✓) or off. If the network requires a gateway address, turn this option on and enter the address supplied by the network administrator as described below.

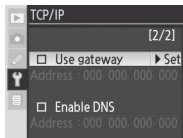

1

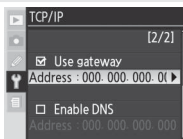

Highlight **Address**.

2

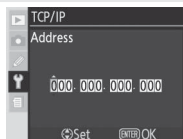

Enter edit mode.

3

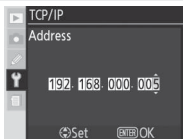

Press multi selector left or right to select, up or down to change.

4

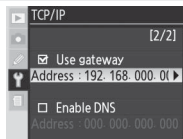





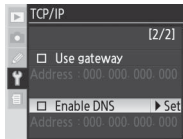

Return to TCP/IP menu (2/2).

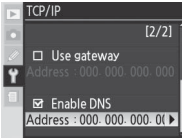

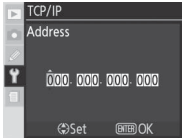
**Enable DNS:** Highlight this option and press the multi selector right to toggle it on (✓) or off. If a **Domain Name Server (DNS)** exists on the network, turn this option on and enter the address supplied by the network administrator as described below.

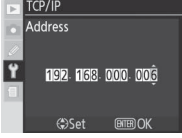

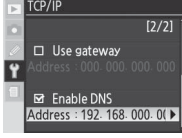
<p>1</p>   <p>Highlight <b>Address</b>.</p>	<p>2</p>   <p>Enter edit mode.</p>
<p>3</p>   <p>Press multi selector left or right to select, up or down to change.</p>	<p>4</p>   <p>Return to TCP/IP menu (2/2).</p>





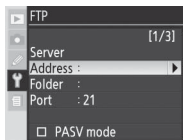





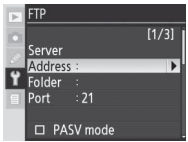

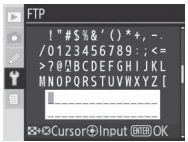

## FTP

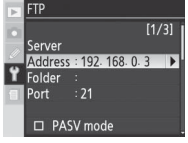
Adjust ftp settings as described on the following pages. The ftp menu has three pages of options; to scroll between pages, press the multi selector up or down.

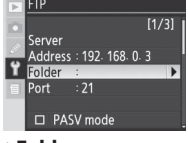

### FTP Menu, Page 1/3

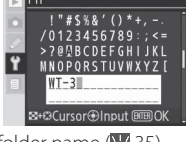
#### Server

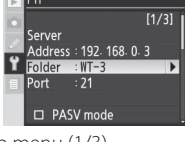
<p>1</p> 	
<p>Highlight <b>Address</b>.</p>	
<p>2</p> 	
<p>Display text entry dialog.</p>	
<p>3</p> 	
<p>Enter server address (required;  35).</p>	
<p>4</p> 	
<p>Return to ftp menu (1/3).</p>	
<p>5</p> 	
<p>Highlight <b>Folder</b>.</p>	
<p>6</p> 	
<p>Display text entry dialog.</p>	
<p>7</p> 	
<p>Enter destination folder name ( 35).</p>	
<p>8</p> 	
<p>Return to ftp menu (1/3).</p>	

9

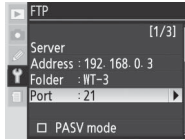

Highlight **Port**.

10



Enter edit mode.

11

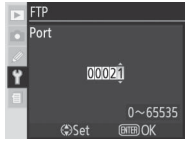

Press multi selector left or right to select, up or down to change.

12

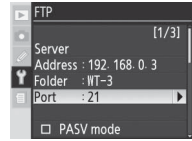





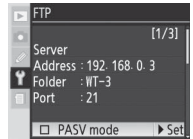



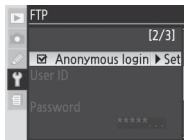



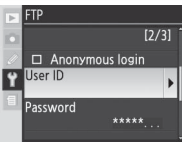

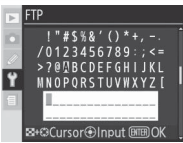
Return to ftp menu (1/3).

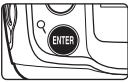
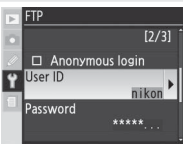
**PASV mode:** Highlight this option and press the multi selector right to toggle PASV mode on (✓) or off. Turn this option off to use normal (PORT) mode. Be sure the server supports PASV mode before turning this option on.





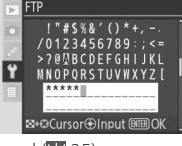

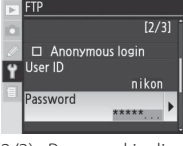



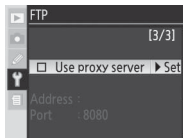



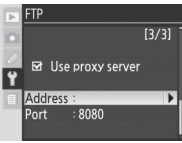

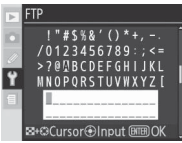
**Anonymous login:** Highlight this option and press the multi-selector right to toggle it on (✓) or off. Turn this option on for anonymous login, off to enter a user name and password as described below.

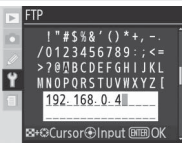
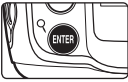
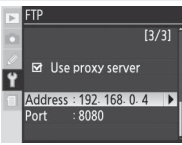

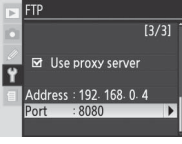
<p>1</p>   <p>Highlight <b>User ID</b>.</p>	<p>2</p>   <p>Display text entry dialog.</p>
<p>3</p>   <p>Enter user name (35).</p>	<p>4</p>   <p>Return to ftp menu (2/3).</p>
<p>5</p>   <p>Highlight <b>Password</b>.</p>	<p>6</p>   <p>Display text entry dialog.</p>
<p>7</p>   <p>Enter password (35).</p>	<p>8</p>   <p>Return to ftp menu (2/3). Password is disguised as a row of dots.</p>

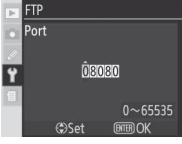
**Use proxy server:** Highlight this option and press the multi selector right to toggle it on (✓) or off. If a proxy server is required for ftp, turn this option on and enter an address and port number as described below.

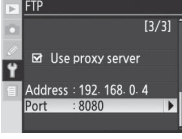

<p>1</p>   <p>Highlight <b>Address</b>.</p>	<p>2</p>   <p>Display text entry dialog.</p>
<p>3</p>   <p>Enter proxy server address (↵ 35).</p>	<p>4</p>   <p>Return to ftp menu (3/3).</p>
<p>5</p>   <p>Highlight <b>Port</b>.</p>	<p>6</p>   <p>Enter edit mode.</p>
<p>7</p>   <p>Press multi selector left or right to select, up or down to change.</p>	<p>8</p>   <p>Return to ftp menu (3/3).</p>

## Settings (Transfer Mode Only)

The following settings are available in transfer mode:

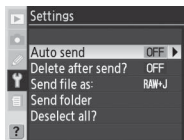

### Auto Send

Choose whether to upload photographs to the server as they are taken.

Option	Description
<b>Off</b> (default)	Photos are not automatically uploaded as they are taken. Photos can be selected for transmission when camera is in playback mode.
<b>On</b>	Photos are uploaded immediately after being recorded to camera memory card.* Be sure memory card is inserted in camera before shooting.

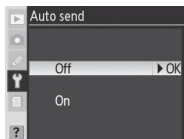

\* Pictures will not be uploaded to the server if **Off** is selected in the **Wireless transmitter > Wireless LAN system** menu. Pictures will instead be marked with a “send” indicator as they are recorded to the memory card.

### Delete After Send?

Select **Yes** to delete photographs from the camera memory card automatically once upload is complete (the default option is **No**). Files uploaded before this option was selected are not affected. Photographs will not be deleted while displayed in slide shows or in the delete, print set, and preset white balance menus. Sequential file numbering is used while this option is in effect, regardless of the option selected for Custom Setting d6 (**File No. Sequence**).

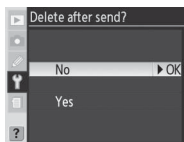

### Send File As

When uploading NEF+JPEG images to an ftp server, choose whether to send both NEF (RAW) and JPEG files or only the JPEG files.

Option	Description
<b>NEF (RAW) + JPEG</b> (default)	Upload both NEF (RAW) and JPEG files. JPEG files are sent first.
<b>JPEG only</b>	Upload JPEG files only.

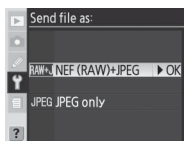

## Send Folder

All files in the selected folder (including those already marked as “sent”) will be uploaded in ascending order by file number, beginning when the folder is selected. The folder itself will not be uploaded. This option is not available when the memory card contains no folders.

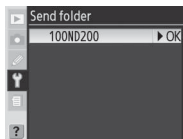

## Deselect All?

Select **Yes** to remove “send,” “sending,” and “sent” marking from all images on the memory card. Upload of any images marked with a “sending” icon will immediately be terminated.

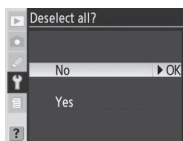

## Print (Print Mode Only)

Choose a printer from the profile list. Once a connection has been established, photographs can be printed as described in “Printing Via Direct USB Connection: Printing Multiple Photographs” in the camera manual. This option is only available when **On** is selected for **Wireless transmitter > Wireless LAN system** in the camera setup menu. Note that index printing is only available with the optional PD-10 wireless printer adapter.

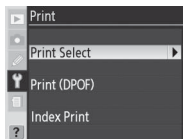

# Appendices

## Creating ftp Profiles Using the Camera Menus

In transfer mode, the camera menus can be used to create ftp profiles in place of the WT-3 Setup Utility. Before creating an ftp profile with the camera menus, set the camera **USB** option to **PTP** and connect the WT-3. To prevent unexpected loss of power, be sure the battery is fully charged or use an optional EH-6 AC adapter. The drain on the battery can be reduced by selecting **Off** for the **Wireless transmitter > Wireless LAN system** option in the camera setup menu before adjusting ftp settings.

1 Turn the camera on.



2 Select **Transfer mode** for **Wireless transmitter > Mode** (F34).

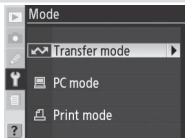

3 A profile list will be displayed showing the connections available in transfer mode. Highlight **FTP registration** and press the multi selector to the right. Note a new ftp profile can not be created if the camera already contains nine profiles; if necessary, delete a profile using the (F16) button.

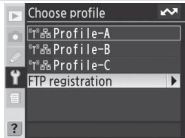

## Firewalls

The WT-3 uses TCP ports 20 and 21 for ftp. It may be necessary to adjust firewall settings before connecting to a server behind a firewall (F16).

## Using the Menus

If the shutter-release button on the camera or WT-3 is pressed while menus are displayed, the monitor will turn off and any changes to the current profile will be lost. Do not press the shutter-release button while editing profiles.

## Editing Existing ftp Profiles

See the Menu Guide for information on using the camera menus to edit existing ftp profiles (F35).



4 The registration dialog shown at right will be displayed. Press the multi selector up or down to highlight an option, then press to the right to select. Select **Done** to proceed to Step 5 when settings are complete.

**Rename:** The dialog shown at right will be displayed. Enter a profile name of up to 16 characters as described in “Text Entry” (35) and press the **Done** button to return to the registration dialog.

**Interface type:** The dialog shown at right will be displayed. Highlight one of the following options and press the multi selector to the right to return to the registration dialog.

Option	Description
<b>Wireless &amp; Ethernet</b> (default)	Connect via wireless and/or Ethernet.
<b>Ethernet only</b>	Connect via Ethernet only.

**Wireless:** If **Wireless & Ethernet** is selected for **Interface type**, select this option to adjust wireless settings as described in the Menu Guide (35–38). Press the multi selector to the left to return to the registration dialog when settings are complete.

**TCP/IP:** Adjust TCP/IP settings as described in the Menu Guide (38–41). Press the multi selector to the left to return to the registration dialog when settings are complete.

**FTP:** Adjust ftp settings as described in the Menu Guide (42–45). Press the multi selector to the left to return to the registration dialog when settings are complete.

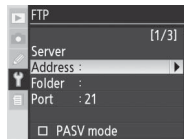
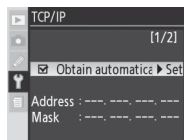
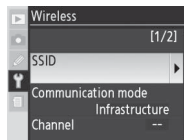
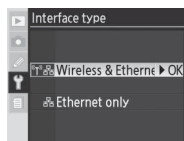
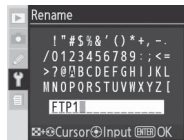
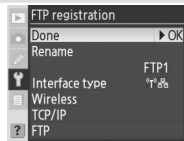

**5** If **On** is selected for **Wireless transmitter > Wireless LAN system**, a confirmation dialog will be displayed. Choose from the following options:

- **Yes:** Open a connection to the new server and return to the top level of the wireless transmitter menu.
- **No:** Return to Step 3 without connecting to the server.

If the wireless transmitter is off, the dialog shown in Step 3 will be displayed and the WT-3 will not open a connection to the new server.

## **Errors**

An error will be displayed if the new profile does not match server settings. Edit wireless, TCP/IP, and ftp settings as described in the Menu Guide (🔗 35).

## Troubleshooting

Problem	Solution	
	<ul style="list-style-type: none"> <li>• Confirm that battery is inserted in WT-3 and is fully charged.</li> </ul>	20
	<ul style="list-style-type: none"> <li>• Reattach WT-3.</li> </ul>	18
	<ul style="list-style-type: none"> <li>• Insert memory card (transfer and print modes only).</li> </ul>	21, 30
"POWER" LED does not light.	<ul style="list-style-type: none"> <li>• Turn camera on.</li> </ul>	—
	<ul style="list-style-type: none"> <li>• Press shutter-release button halfway to activate exposure meters.</li> </ul>	—
	<ul style="list-style-type: none"> <li>• Select <b>On</b> for <b>Wireless transmitter &gt; Wireless LAN system</b> option in camera setup menu.</li> </ul>	34
	<ul style="list-style-type: none"> <li>• Open connection to printer (print mode only).</li> </ul>	31
All LEDs blink at once.	WT-3 hardware error. Contact a Nikon-authorized service representative.	25, 29, 31
<b>Wireless transmitter</b> option not available.	<ul style="list-style-type: none"> <li>• Reattach WT-3.</li> </ul>	18
	<ul style="list-style-type: none"> <li>• Select <b>PTP</b> for <b>USB</b> option in camera setup menu.</li> </ul>	11
Excessive radio interference.	Change orientation of camera or antenna.	4
Camera displays "Ethernet cable is not connected."	Connect Ethernet cable or change interface setting to <b>Wireless &amp; Ethernet</b> .	4, 13, 49
	<ul style="list-style-type: none"> <li>• Confirm that host and wireless LAN adapter are on.</li> </ul>	—
	<ul style="list-style-type: none"> <li>• Ensure that there are no obstacles between WT-3 and wireless LAN adapter.</li> </ul>	—
Camera displays wireless error.	<ul style="list-style-type: none"> <li>• Check settings for host and/or wireless LAN adapter and adjust camera settings appropriately.</li> </ul>	14, 35
	<ul style="list-style-type: none"> <li>• Check settings for host and/or wireless LAN adapter and adjust camera settings appropriately.</li> </ul>	14, 35
Camera displays TCP/IP or FTP error.	<ul style="list-style-type: none"> <li>• Check firewall settings.</li> </ul>	16, 48
Memory card error displayed.	Confirm that memory card is properly inserted.	21, 30
Photos can not be transferred to computer to which PictureProject has been installed.	<ul style="list-style-type: none"> <li>• PictureProject version is incorrect. Update to latest version or install version supplied with D200.</li> <li>• <b>Macintosh:</b> If PictureProject was installed after WT-3 Setup Utility, reinstall WT-3 Setup Utility.</li> </ul>	—
Transfer interrupted before all photographs are sent.	Transfer will resume if camera is turned off and then on again, exposure meters are reactivated, or <b>On</b> for <b>Wireless transmitter &gt; Wireless LAN system</b> .	34
Error displayed stating that no images are available for printing.	Only JPEG images can be printed from the camera. Transfer RAW (NEF) images to computer and print them from PictureProject or Nikon Capture version 4.4 or later.	—

## Glossary

**Ad-hoc:** Devices in an ad-hoc wireless network communicate directly (“peer to peer”), without a wireless access point.

**AES (Advanced Encryption Standard):** An encryption standard developed for use by the American government. AES has been praised for combining strong encryption with rapid processing.

**Auto IP (APIPA—Automatic Private IP Addressing):** Allows devices in a network to automatically assign themselves unique IP addresses if no DHCP server is found on the network. Auto IP uses addresses from 169.254.1.0 to 169.254.254.255 and a subnet mask of 255.255.0.0. These addresses are neither global nor private but are reserved for Auto IP.

**BSS-ID (Basic Service Set ID):** All wireless devices on an ad-hoc wireless network share the same BSS-ID. The BSS-ID may be up to thirty-two characters long and is case sensitive. *See also* Ad-hoc.

**Channel:** When multiple wireless LANs with different ESS-IDs are operating on a single frequency within a given area, transmission speeds will drop. Specifying a separate channel (frequency) for each network can prevent interference and increase transmission speeds (note that all devices in the same network must be set to the same channel). In the IEEE 802.11b/g standard, the 2.4-GHz band is divided into 14 channels, each separated by 4 MHz.

**DHCP (Dynamic Host Configuration Protocol) Server:** Each device in a TCP/IP network requires an IP address. If a DHCP server is present on the network, IP addresses will be assigned automatically.

**DNS (Domain Name Server):** A server that contains a database of IP addresses and host names for the machines it administers and that converts host names to IP addresses in response to queries from clients. Each DNS can also query other Domain Name Servers for addresses not listed in its database.

**ESS-ID (Extended Service Set ID):** Multiple BSSs can be configured to form an ESS, allowing users to roam between wireless access points. Only devices with the same ESS-ID as a given access point can communicate with that access point. The ESS-ID may be up to thirty-two characters long and is case sensitive.

**Ethernet:** The name given to the IEEE 802.3 LAN standard. Devices in an Ethernet network are connected via UTP cables for transmission speeds of up to 10Mbps (10 base-T) or 100Mbps (100 base-TX).

**Gateway:** A network node that acts as an entrance to another network, for example between a company network and the Internet.

**IIS (Internet Information Services):** Microsoft’s name for its Web server software. Notable for its close connection to Windows-based systems through Active Server Pages (ASPs). When installed as part of the operating system, IIS makes it relatively easy to build web a server.

**Infrastructure:** Devices in an infrastructure network communicate via wireless access points that may be connected to an Ethernet network, allowing wireless and Ethernet devices to coexist on a single network.

**IP address:** The address given to each node in a TCP/IP network. All nodes in a TCP/IP network must have a unique IP address. Private IP addresses are recommended for nodes that are part of a local network.

**Key index:** A number identifying which WEP key is to be used for encryption when communicating via an access point with more than one WEP key. All devices on the network must use the same key index.

**LAN (Local Area Network):** A network of computers located in relatively close proximity to one another. LANs generally support data transfer speeds of 10–100 Mbps.

**MAC (Media Access Control) Address:** A unique hardware address for each device on a network, required when sending and receiving packets.

**Open system:** The name given to a wireless network using no authentication (open authentication). Open systems are relatively insecure, as a password is not required to gain access to the server.

**PASV mode:** PASV mode is used by clients behind firewalls, when it allows the ftp server to supply the port number.

**Private IP address:** An IP address that is only visible within a local network. Because packets using a private IP address can not be transmitted to another network, they are usually sent between networks via a proxy server or NAT. Private IP addresses in the range 10.0.0.0–10.255.255.255 are termed “class A.” Class B addresses are in the range 172.16.0.0–172.31.255.255, class C addresses in the range 192.168.0.0–192.168.255.255. The class of address used depends on the size of the network. Class C addresses are often used for small networks.

**Protocol:** A set of rules for passing information back and forth between devices in a network. By defining such elements of communication as how links are established, how receipt of a signal is acknowledged, how data are encoded, and how to handle errors, a protocol ensures that data are transmitted without loss of information.

**Proxy:** A server that stands between large networks and local networks or computers, typically to ensure security. One element of a firewall.

**PTP-IP (Picture Transfer Protocol over Internet Protocol):** A commonly used name for the CIPA DC-005-2005 image transfer protocol for transmitting images over LANs. It represents an extension to the Picture Transfer Protocol (PTP) used to transfer images between cameras and computers connected via USB cable. The WT-3 uses PTP-IP to communicate with host computers.

**Shared key:** An authentication system in which WEP keys are used to establish whether a client has access to the network. Communication is restricted to devices with the same WEP key.

**SS-ID (Service Set ID):** An SS-ID prevents interference between devices in different networks by allowing communication only between devices that share an SS-ID. See BSS-ID, ESS-ID.

**Subnet mask:** A mask that divides a network into subnets.

**TCP/IP (Transmission Control Protocol/Internet Protocol):** A dual protocol consisting of a transport-layer protocol (TCP) that divides data into packets which it later reassembles, and a network protocol (IP) that handles transmission of the packets between points in the network. It can be implemented on different platforms, allowing data to be transmitted between machines with different operating systems.

**TKIP (Temporal Key Integrity Protocol):** An encryption standard using dynamic WPA-PSK keys that change periodically or after a specified amount of data have been transmitted, making it more secure than WEP, which uses fixed keys.

**UDP (User Datagram Protocol):** A fast but unreliable transport layer transmission protocol using the OSI model.

**USB (Universal Serial Bus):** A standard for connecting peripheral devices. USB supports data transfer rates of up to 480Mbps (USB 2.0). Devices connected via USB can be connected and disconnected with the power on ("hot plug") and do not require separate IRQ (interrupt request) numbers, preventing conflicts with other devices.

**WAN (Wide Area Network):** A network connecting computers or LANs in widely separated locations. The Internet is an example of a WAN.

**WEP (Wired Equivalent Privacy):** A type of encryption in which the data transmitted between devices is encoded using a shared encryption key (WEP key).

**Wireless LAN access point:** A wireless transceiver that acts as the connection between wireless devices and a wireless network.

**WPA-PSK (WiFi Protected Access with Pre-Shared Key):** A type of authentication for wireless networks using previously-established (pre-shared) TKIP or AES keys. Wireless devices using this form of authentication can only communicate with devices with the same pre-shared key.

## Specifications

Wireless	
<b>Standards</b>	IEEE 802.11b/g (standard wireless LAN protocol), ARIB STD-T66 (standard for low power data communications systems)
<b>Communications protocols</b>	IEEE 802.11g: OFDM IEEE 802.11b: DBPSK, DQPSK, CCK
<b>Operating frequency</b>	WT-3: 2412–2472 MHz (13 channels) WT-3A: 2412–2462 MHz (11 channels)
<b>Range (line of sight)</b>	Approximately 80 m (262 ft.) with built-in antenna Approximately 280 m (919 ft.) with WA-E1 extended range antenna and large antenna at wireless LAN access point
<b>Data rates*</b>	IEEE 802.11g: 6, 9, 12, 18, 24, 36, 48, and 54 Mbps IEEE 802.11b: 1, 2, 5.5, and 11 Mbps
<b>Security</b>	TKIP, AES, 128/64-bit (104/40-bit) WEP
<b>Access protocols</b>	Infrastructure/ad-hoc
Ethernet	
<b>Standards</b>	IEEE 802.3u (100 base-TX)/IEEE 802.3 (10 base-T)
<b>Data rates</b>	10/100 Mbps with auto detect
<b>Port</b>	100 base-TX/10 base-T (AUTO-MDIX)
<b>Data transfer protocols</b>	PTP-IP, ftp
<b>Power consumption</b>	3.5 W maximum
<b>Power source</b>	Rechargeable EN-EL3e Li-ion battery × 1 (supplied with D200), EH-6 AC adapter (available separately)
<b>Operating environment</b>	Temperature: 0–40 °C (32–131 °F) Humidity: less than 85% (no condensation)
<b>Weight</b>	WT-3: 295 g/10.4 oz (body only) WT-3A: 295 g/10.4 oz (body only)
<b>Dimensions (W × H × D)</b>	152 mm × 110 mm × 72.5 mm (6.0 in. × 4.3 in. × 2.9 in.)

\* Maximum logical data rates according to IEEE standard. Actual rates may differ.

## Battery Life

The number of shots that can be taken with a fully-charged EN-EL3e battery (1500 mAh) varies with the condition of the batteries, temperature, and how the camera and WT-3 are used. The following measurements were performed at a temperature of 20°C (68°F) both with the WT-3 off and while uploading photographs to a Windows XP Professional SP2 computer using **Auto send**.

### Example 1

<b>Network</b>	None (WT-3 off)	Wireless (802.11g, infrastructure mode)	Ethernet (100 base-TX)
<b>No. of shots</b>	1600	1000	1100
<b>Camera settings</b>	Zoom Nikkor AF-S VR 70–200 mm f/2.8G IF ED lens (VR off); continuous high-speed shooting mode; continuous-servo autofocus; image quality set to JPEG Basic; image size set to <b>M</b> ; shutter speed $\frac{1}{250}$ s; shutter-release pressed halfway for three seconds and focus cycled from infinity to minimum range three times with each shot; after six shots, monitor turned on for five seconds and then turned off; cycle repeated after eight seconds.		

### Example 2

<b>Network</b>	None (WT-3 off)	Wireless (802.11g, infrastructure mode)	Ethernet (100 base-TX)
<b>No. of shots</b>	300	200	210
<b>Camera settings</b>	Zoom Nikkor AF-S VR 24–120 mm f/3.5–5.6G IF ED lens (VR off); single-frame shooting mode; single-servo autofocus; image quality set to JPEG Normal; image size set to <b>L</b> ; shutter speed $\frac{1}{250}$ s; shutter-release pressed halfway for five seconds and focus cycled from infinity to minimum range once with each shot; built-in Speedlight fired at full power with every other shot; AF-assist illuminator lights when Speedlight is used; cycle repeated after eight seconds; camera turned off for one minute after ten photographs have been transferred.		

The following can reduce battery life:

- Using the monitor
- Repeated autofocus operations
- Keeping the shutter-release button pressed halfway
- Taking NEF (RAW) photographs
- Slow shutter speeds

To ensure maximum battery performance:

- Keep the battery contacts clean. Soiled contacts can reduce battery performance.
- Use EN-EL3e batteries immediately after charging. Batteries will lose their charge if left unused.

The battery level displayed by the camera may vary with changes in temperature.



## Index

### Symbols

   24

### A

AC adapter, 20

Access point. *See* Wireless LAN, access point

Ad-hoc, 2, 14, 36, 52

Antenna, 4

**Auto send**, 46

### B

BSS-ID, 36, 52

BUSY. *See* Status LEDs

### C

Channel, 14, 36, 52

Connecting the WT-3, 18

### D

**Delete after send?**, 46

**Deselect all?**, 47

DHCP server, 15, 38, 52

Domain Name Server (DNS), 15, 41, 52

### E

Encryption, 14, 37

key, 14, 37, 54

Errors, 51

ftp, 51

TCP/IP, 51

wireless, 51

ESS-ID, 36, 52

Ethernet, 2, 4, 21, 26, 30, 52

### F

File names, 23, 24, 25

Folders, 15, 42. *See also* **Send folder**

**FTP**, 42, 49

ftp

errors. *See* Errors, ftp

server, 2, 3, 15, 21, 35, 48

FTP ERROR. *See* Errors, ftp

### G

Gateway, 15, 40, 52

### I

IP address, 15, 38, 53

Infrastructure, 2, 14, 36, 53

### L

LAN. *See* Wireless LAN, Ethernet

LED. *See* Status LEDs

LINK. *See* Status LEDs

### M

MAC address, 16

Memory cards, 21, 30

Menus, 34–47, 48–50

entering text in, 35

**Mode**, 2, 21, 26, 30, 34

### N

Nikon Capture 4, 26, 28

### P

Password, 13

PASV mode, 15, 43, 53

PC mode, 2, 26

PictureProject, 13, 26

Port, 16, 48

POWER. *See* Status LEDs

Printing, 30

Print mode, 2, 30

Proxy, 15, 45, 53

PTP-IP, 53, 55

### S

**Send folder**, 47

**Send file as**, 46

Server. *See* ftp, server

**Settings**, 46

SS-ID, 14, 36, 53

Status. *See* Link quality; Status LEDs

Status LEDs, 4, 25, 29, 31

### T

**TCP/IP**, 38, 49

TCP/IP, 15, 38, 49, 54

Transfer mode, 2, 21, 35, 46, 48

### U

Upload, 21, 23

deleting images after, 46

interrupting, 24

selecting images for, 23

**USB**, 11

User ID, 44

### W

**Wireless**, 35, 49

Wireless LAN, 2, 14, 35, 49

access point, 2, 54

**Wireless LAN system**, 22, 27, 31, 32, 34

**Wireless transmitter**, 34

WT-3 Setup Utility, 2, 3, 7, 11

## Free Manuals Download Website

<http://myh66.com>

<http://usermanuals.us>

<http://www.somanuals.com>

<http://www.4manuals.cc>

<http://www.manual-lib.com>

<http://www.404manual.com>

<http://www.luxmanual.com>

<http://aubethermostatmanual.com>

Golf course search by state

<http://golfingnear.com>

Email search by domain

<http://emailbydomain.com>

Auto manuals search

<http://auto.somanuals.com>

TV manuals search

<http://tv.somanuals.com>