

# User's Manual

## *α* MICtube

### STEREO TUBE PREAMP







[www.altoproaudio.com](http://www.altoproaudio.com)  
Version 2.3 September 2005  
— English —

## SAFETY RELATED SYMBOLS



 This symbol, wherever used, alerts you to the presence of un-insulated and dangerous voltages within the product enclosure. These are voltages that may be sufficient to constitute the risk of electric shock or death.

 This symbol, wherever used, alerts you to important operating and maintenance instructions. Please read.

-  Protective Ground Terminal
-  AC mains (Alternating Current)
-  Hazardous Live Terminal

**ON:** Denotes the product is turned on.

**OFF:** Denotes the product is turned off.

### WARNING

Describes precautions that should be observed to prevent the possibility of death or injury to the user.

### CAUTION

Describes precautions that should be observed to prevent damage to the product.

 Disposing of this product should not be placed in municipal waste and should be separate collection.

### WARNING

#### • Power Supply

Ensure that the mains source voltage (AC outlet) matches the voltage rating of the product. Failure to do so could

result in damage to the product and possibly the user.

Unplug the product before electrical storms occur and when unused for long periods of time to reduce the risk of electric shock or fire.

#### • External Connection

Always use proper ready-made insulated mains cabling (power cord). Failure to do so could result in shock/death or fire. If in doubt, seek advice, from a registered electrician.

#### • Do not Remove any Covers

Within the product are areas where high voltages may present. To reduce the risk of electric shock do not remove any covers unless the AC mains power cord is removed.

**Covers should be removed by qualified service personnel only.**

No user serviceable parts inside.

#### • Fuse

To prevent fire and damage to the product, use only the recommended fuse type as indicated in this manual. Do not short-circuit the fuse holder. Before replacing the fuse, make sure that the product is OFF and disconnected from the AC outlet.

#### • Protective Ground

Before turning the product ON, make sure that it is connected to Ground. This is to prevent the risk of electric shock.

Never cut internal or external Ground wires. Likewise, never remove Ground wiring from the Protective Ground Terminal.

- **Operating Conditions**

Always install in accordance with the manufacturer's instructions.

To avoid the risk of electric shock and damage, do not subject this product to any liquid/rain or moisture. Do not use this product when in close proximity to water.

Do not install this product near any direct heat source.

Do not block areas of ventilation. Failure to do so could result in fire.

Keep product away from naked flames.

- **Servicing**

Refer all servicing to qualified service personnel only.

Do not perform any servicing other than those instructions contained within the User's Manual.

## **IMPORTANT SAFETY INSTRUCTIONS**

Read these instructions

Follow all instructions

Keep these instructions. Do not discard.

Heed all warnings.

Only use attachments/accessories specified by the manufacturer.

- **Power Cord and Plug**

Do not tamper with the power cord or plug.

These are designed for your safety.

Do not remove Ground connections!

If the plug does not fit your AC outlet seek advice from a qualified electrician.

Protect the power cord and plug from any physical stress to avoid risk of electric shock.

Do not place heavy objects on the power cord. This could cause electric shock or fire.

- **Cleaning**

When required, either blow off dust from the product or use a dry cloth.

Do not use any solvents such as Benzol or Alcohol.

For safety, keep product clean and free from dust.

## Preface

Dear Customer,

Thanks for choosing ▲LTO Stereo Tube Preamplifier and thanks for choosing one of the results of ▲LTO AUDIO TEAM job and researches.

For our ▲LTO AUDIO TEAM, music and sound are more than a job...are first of all passion and let us say...our obsession!

We have been designing professional audio products for a long time in cooperation with some of the major brands in the world in the audio field.

The ▲LTO line presents unparalleled analogue and digital products made by Musicians for Musicians in our R&D centers in Italy, Netherlands, United Kingdom and Taiwan.

The core of our digital audio products is a sophisticated DSP (Digital Sound Processor) and a large range of state of the art algorithms which have been developed by our Software Team for the last 7 years

Because we are convinced you are the most important member of ▲LTO AUDIO TEAM and the one confirming the quality of our job, we would like to share with you our work and our dreams, pay attention to your suggestions and your comments. Following this idea we create our products and we will create the new ones! From our side, we guarantee you and we will guarantee you also in future the best quality, and the best fruits of our continuous researches and the best prices.

Our  $\alpha$  MICtube Stereo Preamplifier is the result of many hours of listening and tests involving common people, area experts, musicians and technicians. The result of this effort is a half rack space unit, the heart of which is an extremely low-noise microphone pre-amp circuit that uses discrete components to produce a highly transparent sound.

Nothing else to add, but that we would like to thank all the people that made the ▲LTO  $\alpha$  MICtube Stereo Preamplifier a reality available to our customers, thank our designers and all the ▲LTO staff, there to make possible the realization of products containing our idea of music and sound and there to support you, our customers, in the best way, conscious that you are our best richness.

Thank you very much.  
▲LTO AUDIO TEAM

## TABLE OF CONTENT

<b>1. INTRODUCTION</b> .....	5
<b>2. FEATURE LIST</b> .....	5
<b>3. CONTROL ELEMENTS</b> .....	5
3.1 The Front Panel	
<b>a. Guidepost of The Front Panel</b>	
<b>b. Supplementary Descriptions</b>	
3.2 The Rear Panel	
<b>a. Power Supply Connection</b>	
<b>b. Analogue Inputs/Outputs</b>	
<b>4. INSTALLATION &amp; CONNECTION</b> .....	8
4.1 Mains Connection	
4.2 Audio Connection	
<b>a. Wiring Configuration</b>	
<b>b. In Line Connection</b>	
4.3. Rack Mounting	
<b>5. APPLICATIONS</b> .....	9
5.1 The $\alpha$ MICtube as A Microphone Preamplifier	
5.2 The $\alpha$ MICtube as A Direct-Injection Box (DI Box)	
5.3 The $\alpha$ MICtube as A Level Translator	
<b>6. TECHNICAL SPECIFICATIONS</b> .....	11
6.1 Block Diagram	
6.2 Specifications	
<b>7.WARRANTY</b> .....	13

## 1. INTRODUCTION

Thank you very much for expressing your confidence in ▲LTO products by purchasing our  $\alpha$  MICtube Stereo Tube Preamplifier. With the  $\alpha$  MICtube you have acquired an extremely musical and flexible Stereo Microphone Preamplifier which is based on many years of experience and findings in amplifier technology and is used through the world in renowned studios, sound reinforcement systems as well as in broadcast and television studios. The ▲LTO  $\alpha$  MICtube meets highest and no-compromise requirements in terms of operation, sound, specifications and workmanship.

The ▲LTO  $\alpha$  MICtube is a half rack space unit, the heart of the  $\alpha$  MICtube is an extremely low-noise microphone pre-amp circuit that uses discrete components just like 12AX7WA Tubes and TL074CD J-FET Quad Operational Amplifier IC to produce a highly transparent sound! The switchable +48V Phantom Power supply allows you to operate your condenser microphone more conveniently.

## 2. FEATURE LIST :

- Half rack space
- Robust and Compact design
- Dual Servo Microphone Preamplifier
- 20dB pad
- +48V phantom power
- Phase Reverse
- 8-Digit Output Level meter
- 12AX7WA Low Noise Tubes
- Output section includes XLR and 1/4" connectors for driving two separate signal paths
- 1/4", high Z input on the front panel for instrument preamplification
- High quality and fidelity components
- SMD Technology for top performance
- Manufactured under QS9000, VDA6.1 certified management system

## 3. CONTROL ELEMENTS

### 3.1 The Front Panel:

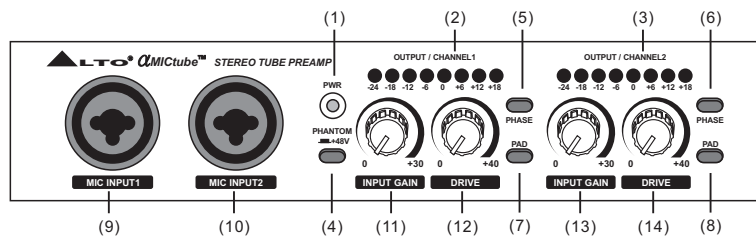

### a. Guidepost of the front panel

- (1) Power LED
- (2) CHANNEL 1 Output Level Display LED
- (3) CHANNEL 2 Output Level Display LED
- (4) Phantom Power Switch
- (5)(6) Phase Reverse Switch
- (7)(8) 20dB PAD
- (9)(10) Combination Microphone (XLR) and Instrument (1/4 inch) input
- (11)(13) Input Gain Control (0 to 30 dB)
- (12)(14) Drive Control (0 to 40 dB)

### b. Supplementary Descriptions

#### ■ Phantom Power Switch (4):

This switch activates the +48 volts phantom power to supply condenser mics and any other devices requiring continuous power by means of the XLR cable. The +48V is applied both to the positive (pin2) and negative inputs (pin3) of the XLR connector:

XLR Connector	Phantom Power Supply
PIN1 ( Ground )	GND
PIN2 ( Positive )	+48V
PIN3 ( Negative )	+48V

**Caution:** Please make sure that you are using an appropriate microphone before you activate this switch to supply the +48V phantom power. Read the operating instructions accompanying the microphone. Some condenser mics might need another type of power supply, old dynamic microphones could be damaged by the +48V voltage, and unbalanced microphones should never be operated in combination with a +48V power supply.

#### ■ Phase Reverse Switch (5 for CHANNEL 1 and 6 for CHANNEL 2):

This Phase Reverse Switch reverses the audio signal's phase by 180°, Normally, you won't need this switch, however, in some cases, it might be necessary, for example: the inversion of the pins of the XLR connector may be necessary to alter the audio phase of two link microphones to compensate for phase cancellation. It may be required that the wiring of a cable's XLR connector be switch to successfully utilize Phantom power.

#### ■ 20dB Pad (7 for CHANNEL 1 and 8 for CHANNEL 2):

A 20dB Pad is available on each channel to attenuate the incoming signal level to provide increased "headroom" for the operator.

#### ■ Input Gain (11 for CHANNEL 1 and 13 for CHANNEL 2):

This control sets the amount of boost to the signal being processed by this pre-amplifier. Use this control to adapt the  $\alpha$  MICtube to either home recording level

-10dBV ) or professional level (+4dbu). When the gain is too low, the tube effect becomes less audible and the S/N (Signal to Noise) ratio deteriorates. Generally, Dynamic mics and instruments without preamps will require more gain than condenser mics and instruments that have a built-in preamp. If you should require more signal out of the preamp for a hotter recording level, cranking up the gain should provide all the signal that you'll need.

To obtain the best possible S/N (Signal to Noise) ratio and subsequently the best transparent sound, keep an eye on the 8 Digit Output Level Meter .

▀ *Drive (12 for CHANNEL 1 and 14 for CHANNEL 2):*

The effect achieved by this control can be subtle to extreme, depending on the settings being used. A "warming up" of the sound can be noticed at lower settings. This desirable effect is especially good for microphones and on an electric bass and the resulting sound is infinitely richer and sweeter.

An over-driven signal can be achieved by significantly raising the level of the Drive control. This over-driven tube effect is extremely useful in providing cool guitar sounds and way cool for use with harmonicas for that authentic "Blues harp" vibe. The limits on the possibilities of the Drive control are up to you, your application and your imagination.

### 3.2 The Rear Panel

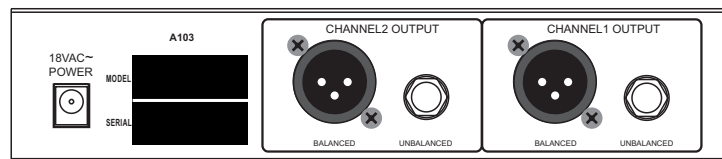

#### a. Power Supply Connection

Please use the 18VAC AC/AC Adaptor provided by ▲LTO to connect your α MICtube. Detail your can follow the illustration.

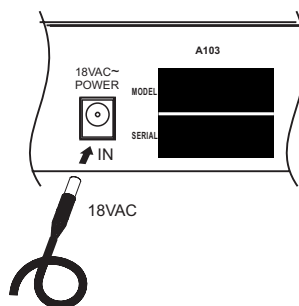

#### b. Analogue Inputs / Outputs

The Output XLR Connector is servo balanced and operates at +4dBu. The Output 1/4" Phone jack is unbalanced and operates at -10dBv.



## 4. INSTALLATION & CONNECTION:

### 4.1 Mains Connection

- Please ensure that the ▲LTO  $\alpha$  MICtube Stereo Microphone Preamplifier is connected to the correct supply voltage before operating this unit.
- Only use the 18VAC AC/AC Adaptor provided by ▲LTO.

### 4.2 Audio Connection

The ▲LTO  $\alpha$  MICtube Stereo Tube Preamp presents with balanced XLR connectors and 1/4" TRS phone jack and it can be interfaced by several ways to support a variety of applications without any signal loss.

#### a. Wiring Configuration

Either the 1/4" TRS (Tip-Ring-Sleeve) phone jack or the XLR servo connector can be wired in balanced and unbalanced modes, which will be determined by the actual application status, Please wire your systems as the following examples:

- For 1/4" Phone jack

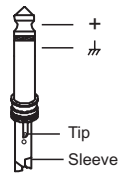

TS Type Unbalanced

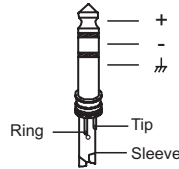

TRS Type Balanced

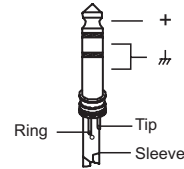

TRS Type Unbalanced

- For XLR connector

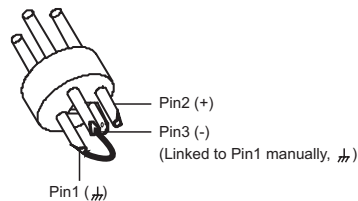

XLR Type Unbalanced

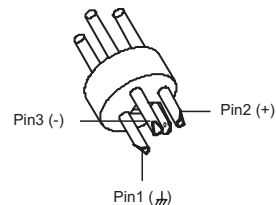

XLR Type Balanced

#### b. In Line Connection

For these applications, the  $\alpha$  MICtube Stereo Tube Preamp provides XLR connectors and 1/4" TRS phone jack to easily interface with most professional audio devices. Follow the configuration examples below for your particular connection.

- Balanced

- Unbalanced

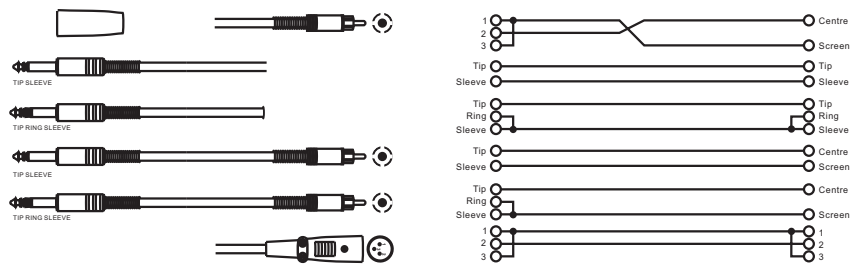

#### 4.3 Rack Mounting

### 5. APPLICATIONS

#### 5.1 The $\alpha$ MICtube as A Microphone Preampfier

On the output side, which may damage subsequent devices, so you should turn down all the level controls beforehand, or you can press the 20dB Pad (7/8) to attenuate the incoming signal level about 20dB, then hook up a microphone to the XLR and 1/4" Combination Input (9/10), use either the jack or XLR output connectors to connect the audio system.

Now, power up the entire equipment, if you wish to use a condenser mic requiring +48V phantom power, please press the Phantom Power Switch (4) (to avoid electric damage, please read Control Elements "Phantom Power Switch" carefully). After that, please adjust your Input Gain Control and Drive Control to get the best result.

### 5.2 The $\alpha$ MICtube as A Direct-Injection Box (DI Box)

When audio signals produced by instruments such as guitars, keyboards, etc. are transported over long unbalanced lines, the transmission quality may be affected by Hum or other interference signals included in the cable. So called DI Box are used to solve this issue: the DI Box converts the unbalanced signal coming from the instrument into a balanced signal that is sent over the line. Interference included in balanced cables is then eliminated by a subsequent balanced input stage.

Using the  $\blacktriangle$ LTO  $\alpha$  MICtube as a Stereo Microphone Preamplifier for this application is very easy. Simply connect the line output of your instrument to the XLR and 1/4" TRS combination Input on the front panel of  $\alpha$  MICtube, then use the  $\alpha$  MICtube's balanced output to send the signal to the next stage.

### 5.3 The $\alpha$ MICtube as A Level Translator

Semi-professional appliances in home recording system are normally operated with a nominal level of 10dBV, while the level used in studios and other professional application is 0dBu or +4dBu. So, when you connect devices of both types to each other, you should consider some kind of level translators of course.

The  $\blacktriangle$ LTO  $\alpha$  MICtube as a Stereo Microphone Preamplifier is pretty suited for this application. The Input Gain control allows you to raise or lower your input signal level by as much as 30dB. The functions Phase Inversion is also enabled in this mode.

## 6. TECHNICAL SPECIFICATIONS

### 6.1 Block Diagram

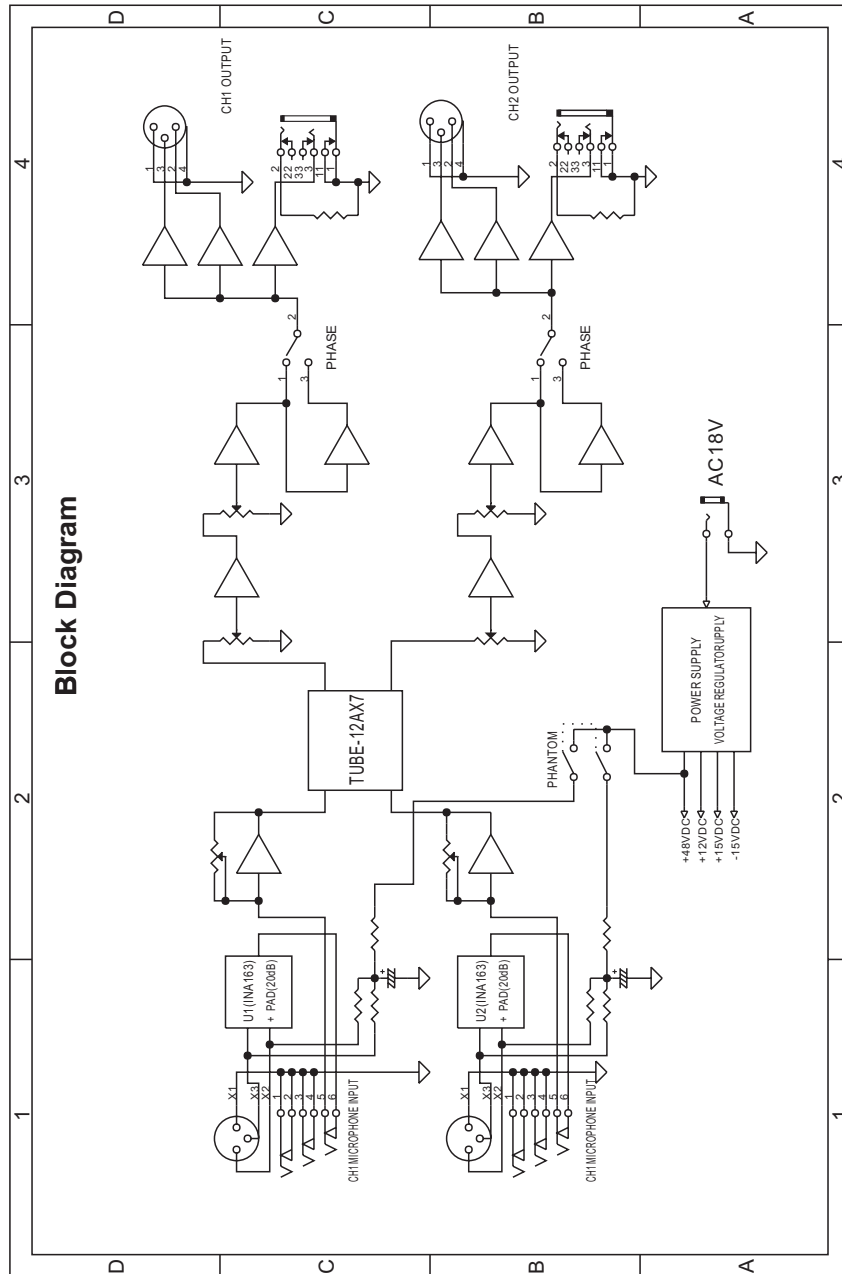

## 6.2 Specifications

<b>Input</b>		
	XLR Impedance	5K Ohm
	1/4" High Z	1M Ohm
	Connectors	Neutrik™ Combo
<b>Output</b>		
	XLR Balanced	100 Ohms
	1/4" Unbalanced	100 Ohms
<b>Panel Controls</b>		
	Tube Drive	0dB to +40dB
	Gain	0dB to +30dB
	Phase Reverse	
	20dB Pad	
	+48V Phantom Power	
<b>Performance</b>		
	THD + Noise	<0.5%
	Signal To Noise	>90dB
	Power Supply Rejection	>98dB
	Amplifier Type	Dual Servo
<b>Meter</b>		
	8-Digit LED	-24dBu to +18dBu
<b>Physical</b>		
	Weight	1.05Kg
	Dimensions	199(W) × 153(D) × 45(H)mm
	Chassis	Steel
	Panel	Brushed Aluminum (▲LTO® Style)
<b>Power Supply</b>		
	Type	Servo controlled, stabilized
	Input	18VAC
	Power	14 Watts
	Transformer	External Wall Mount

## **7. WARRANTY**

### **1. WARRANTY REGISTRATION CARD**

To obtain Warranty Service, the buyer should first fill out and return the enclosed Warranty Registration Card within 10 days of the Purchase Date.

All the information presented in this Warranty Registration Card gives the manufacturer a better understanding of the sales status, so as to purport a more effective and efficient after-sales warranty service.

Please fill out all the information carefully and genuinely, miswriting or absence of this card will void any of your warranty service.

### **2. RETURN NOTICE**

2.1 In case of return for any warranty service, please make sure that the product is well packed in its original shipping carton, and it can protect your unit from any other extra damage.

2.2 Please provide a copy of your sales receipt or other proof of purchase with the returned machine, and give detail information about your return address and contact telephone number.

2.3 A brief description of the defect will be appreciated.

2.4 Please prepay all the costs involved in the return shipping, handling and insurance.

### **3. TERMS AND CONDITIONS**

3.1 ▲LTO warrants that this product will be free from any defects in materials and/or workmanship for a period of 1 year from the purchase date if you have completed the Warranty Registration Card in time.

3.2 The warranty service is only available to the original consumer, who purchased this product directly from the retail dealer, and it can not be transferred.

3.3 During the warranty service, ▲LTO may repair or replace this product at its own option at no charge to you for parts or for labor in accordance with the right side of this limited warranty.

3.4 This warranty does not apply to the damages to this product that occurred as the following conditions:

- Instead of operating in accordance with the user's manual thoroughly, any abuse or misuse of this product.
  - Normal tear and wear
  - The product has been altered or modified in any way .
  - Damage which may have been caused either directly or indirectly by another product/ force/etc.
  - Abnormal service or repairing by anyone other than the qualified personnel or technician.
- And in such cases, all the expenses will be charged to the buyer.

3.5 In no event shall ▲LTO be liable for any incidental or consequential damages. Some states do not allow the exclusion or limitation of incidental or consequential damages, so the above exclusion or limitation may not apply to you.

3.6 This warranty gives you the specific rights, and these rights are compatible with the state laws, you may also have other statutory rights that may vary from state to state.

**SEIKAKU TECHNICAL GROUP LIMITED**  
No. 1, Lane 17, Sec. 2, Han Shi West Road, Taichung 40151 Taiwan  
<http://www.altoproaudio.com> Tel: 886-4-22313737  
email: [alto@altoproaudio.com](mailto:alto@altoproaudio.com) Fax: 886-4-22346757

All rights reserved to ALTO. All features and content might be changed without prior notice. Any photocopy, translation, or reproduction of part of this manual without written permission is forbidden. Copyright © 2005 SEIKAKU GROUP

NF00870-2.3



## Free Manuals Download Website

<http://myh66.com>

<http://usermanuals.us>

<http://www.somanuals.com>

<http://www.4manuals.cc>

<http://www.manual-lib.com>

<http://www.404manual.com>

<http://www.luxmanual.com>

<http://aubethermostatmanual.com>

Golf course search by state

<http://golfingnear.com>

Email search by domain

<http://emailbydomain.com>

Auto manuals search

<http://auto.somanuals.com>

TV manuals search

<http://tv.somanuals.com>