

At your side.
brother®

USER'S GUIDE

MFC-3420C

MFC-3820CN



At your side.
brother®

THIS EQUIPMENT IS DESIGNED TO WORK WITH A TWO WIRE ANALOGUE PSTN LINE FITTED WITH THE APPROPRIATE CONNECTOR.

APPROVAL INFORMATION

Brother advises that this product may not function correctly in a country other than where it was originally purchased, and does not offer any warranty in the event that this product is used on public telecommunication lines in another country.

Compilation and Publication Notice

Under the supervision of Brother Industries Ltd., this manual has been compiled and published, covering the latest product descriptions and specifications.

The contents of this manual and the specifications of this product are subject to change without notice.

Brother reserves the right to make changes without notice in the specifications and materials contained herein and shall not be responsible for any damages (including consequential) caused by reliance on the materials presented, including but not limited to typographical and other errors relating to the publication.



EC Declaration of Conformity under the R & TTE Directive

Manufacturer

Brother Industries, Ltd.
15-1, Naeshiro-cho, Mizuho-ku,
Nagoya 467-8561, Japan

Plant

Brother Industries (Shen Zhen) Ltd
G02414-1, Bao Chang Li Bonded
Transportation Industrial Park,
Bao Long Industrial Estate,
Longgang, Shenzhen, China

Herewith declare that:

Products description: Facsimile Machine
Type: Group 3
Model Name: MFC-3420C / MFC-3820CN

is in conformity with provisions of the R & TTE Directive (1999/5/EC) and we declare compliance with the following standards :

Safety : EN60950:2000

EMC : EN55022:1998 Class B
EN55024:1998
EN61000-3-2:1995 + A14:2000
EN61000-3-3:1995

Year in which CE marking was First affixed : 2003

Issued by : Brother Industries, Ltd.

Date : 16th July 2003

Place : Nagoya, Japan

Signature :







Takashi Maeda
Manager
Quality Management Group
Quality Management Dept.
Information & Document Company





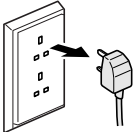

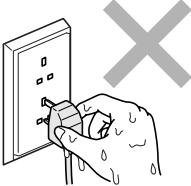

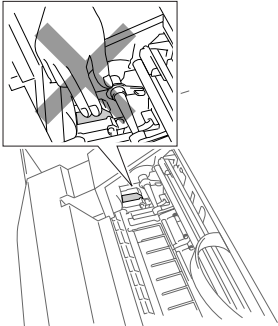
Safety precautions

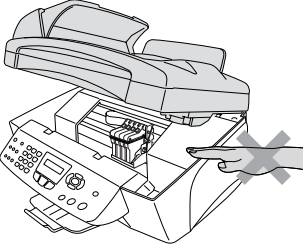
To use the machine safely

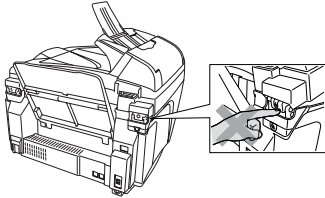
Please refer to these instructions for later reference and before attempting any maintenance.

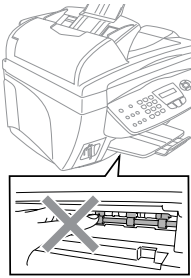
WARNING

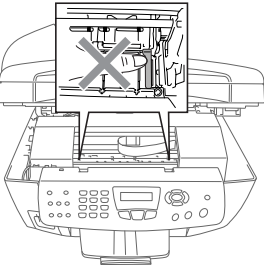
	<p>There are high voltage electrodes inside the machine. Before you clean the machine or clear a paper jam, make sure you have unplugged the telephone line cord first and the power cord from the AC power socket.</p> 		<p>Do not handle the plug with wet hands. Doing this might cause an electrical shock.</p> 
	<p>To prevent injuries, be careful not to put your fingers on the area shown in the illustration. Because that part is extremely HOT after you use your machine.</p> 		

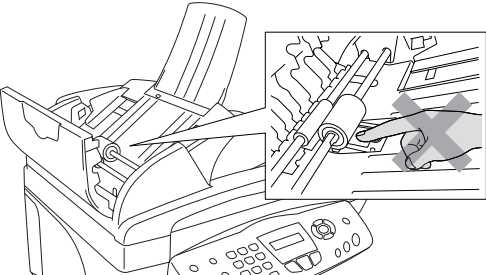
	<p>To prevent injuries, be careful not to put your hands on the edge of the machine under the scanner cover.</p> 	 <p>To prevent injuries, be careful not to put your fingers in the area shown in the illustration.</p> 
	<p>To prevent injuries, be careful not to touch the area shaded in the illustration.</p> 	 <p>To prevent injuries, be careful not to touch the edge of the metallic part shown in the illustration.</p> 
	<p>To prevent injuries, be careful not to put your fingers in the area shown in the illustration.</p> 	

! WARNING

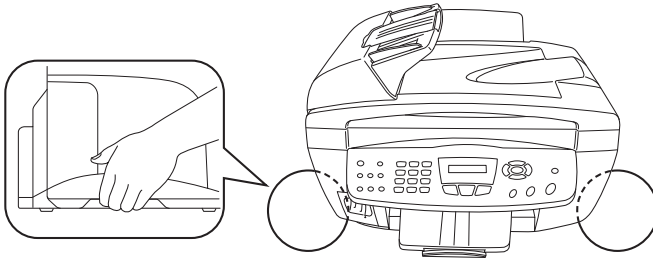

- When you move the machine, grasp the side handholds as shown above. Do NOT carry the machine by holding it at the bottom.
- Use caution when installing or modifying telephone lines. Never touch telephone wires or terminals that are not insulated unless the telephone line has been disconnected at the wall socket. Never install telephone wiring during a lightning storm. Never install a telephone wall socket in a wet location.
- This product must be installed near an socket that is easily accessible. In case of emergencies, you must disconnect the power cord from the socket in order to shut off power completely.

IMPORTANT SAFETY INSTRUCTIONS

When using your telephone equipment, basic safety precautions should always be followed to reduce the risk of fire, electric shock and injury to persons, including the following:



1. Do not use this product near water, for example, near a bath tub, wash bowl, kitchen sink or laundry tub, in a wet basement or near a swimming pool.
2. Avoid using a telephone (other than a cordless type) during an electrical storm. There may be a remote risk of electric shock from lightning.
3. Do not use the telephone to report a gas leak in the vicinity of the leak.

SAVE THESE INSTRUCTIONS

Choosing a location

Place your machine on a flat, stable surface that is free of vibration and shocks, such as a desk. Put the machine near a socket and a standard, grounded AC power outlet. Choose a location where the temperature remains between 10° and 35°C.

! Caution

- Avoid placing your machine in a high-traffic area.
- Avoid placing your machine on the carpet.
- Do not place near heaters, air conditioners, water, chemicals, or refrigerators.
- Do not expose the machine to direct sunlight, excessive heat, moisture, or dust.
- Do not connect your machine to electrical sockets controlled by wall switches or automatic timers.
- Disruption of power can wipe out information in the machine's memory.
- Do not connect your machine to electrical sockets on the same circuit as large appliances or other equipment that might disrupt the power supply.
- Avoid interference sources, such as speakers or the base units of cordless phones.

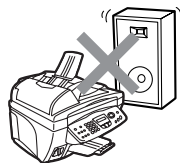
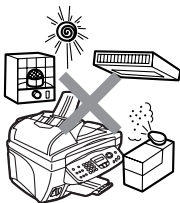

Quick Reference Guide



Sending faxes

Automatic Transmission

- 1 If it is not illuminated in green, press  (**Fax**).
- 2 Load your document. (See *Load documents* on page 2-1.)
- 3 Enter the fax number using Speed-Dial, Search or the dial pad.
- 4 Press **Mono Start** or **Colour Start**.

Receiving faxes

Select Receive Mode

- 1 Press **Menu/Set**, **0**, **1**.
- 2 Press  or  to select Fax Only, Manual, Fax/Tel or External TAD, and then press **Menu/Set**.

Storing numbers

Storing Speed-Dial numbers



- 1 Press **Menu/Set**, **2**, **3**, **1**.
- 2 Using the dial pad, enter a two-digit Speed-Dial location number, and then press **Menu/Set**.
- 3 Enter a number (up to 20 digits), and then press **Menu/Set**.
- 4 Enter a name up to 15 characters (or leave it blank), and then press **Menu/Set**.
- 5 Press **Stop/Exit**.

Dialling operations

Speed-Dialling

- 1 If it is not illuminated in green, press  (**Fax**).
- 2 Load your document. (See *Load documents* on page 2-1.)
- 3 Press **Search/Speed Dial**, press #, and then press the two-digit Speed-Dial number.
- 4 Press **Mono Start** or **Colour Start**.

Using Search

- 1 If it is not illuminated in green, press  (**Fax**).
- 2 Press **Search/Speed Dial**, and then enter the first letter of the name you're looking for.
- 3 Press  or  search the memory.
- 4 Press **Mono Start** or **Colour Start**.

Making copies

Single copy

- 1 Press  (**Copy**) to illuminate it in green.
- 2 Load your document. (See *Load documents* on page 2-1.)
- 3 Press **Mono Start** or **Colour Start**.

Sorting multiple copies (Using the ADF)





- 1 Press  (**Copy**) to illuminate it in green.
- 2 Load your document in the ADF.
- 3 Use the dial pad to enter the number of copies you want (up to 99).
- 4 Press **Options**.
- 5 Press  or  select **Stack/Sort**, and then press **Menu/Set**.
- 6 Press  or  select **Sort**, and then press **Menu/Set**.
- 7 Press **Mono Start** or **Colour Start**.

Table of Contents

1

Introduction	1-1
Using this Guide	1-1
Finding information	1-1
Symbols used in this Guide	1-1
Control panel overview	1-2
Turning the machine to Power Save condition	1-5
About fax machines	1-7
Fax tones and handshake	1-7
ECM (Error Correction Mode).....	1-8
Connecting the machine	1-9
Connecting an external telephone.....	1-9
Connecting an external telephone answering device (TAD)	1-10
Sequence	1-10
Connections	1-12
Recording outgoing message (OGM) on an external TAD	1-12
Using extension telephones (For U.K. only).....	1-13
Multi-line connections (PBX)	1-15
If you are installing the machine to work with a PBX.....	1-15
Custom features on your phone line.....	1-15

2

Loading documents and paper	2-1
Load documents	2-1
Using the automatic document feeder (ADF)	2-1
Recommended environment	2-1
Using the scanner glass	2-3
About paper	2-4
Handling and using special paper	2-4
Paper capacity of the paper tray	2-5
Paper specifications for the paper tray	2-5
Paper capacity of the output paper support	2-6
Printable area	2-7
How to load paper and envelopes	2-8
To load paper or other media	2-8
To load glossy paper	2-9
To load envelopes	2-10

3

On-screen programming	3-1
User-friendly programming	3-1
Menu table	3-1
Memory storage	3-1
Navigation keys	3-2

4

Getting started	4-1
Initial Setup	4-1
Setting the Date and Time	4-1
Setting the Station ID	4-2
Entering text	4-3
Inserting spaces	4-3
Making corrections	4-3
Repeating letters	4-3
Special characters and symbols	4-4
Setting Tone or Pulse dialling mode (Except for the Nordic Countries)	4-4
Setting PABX (MFC-3420C only)	4-4
Setting the Phone Line Type (MFC-3820CN only)	4-5
PABX and TRANSFER	4-5
General Setup	4-6
Setting the Mode Timer	4-6
Setting the Paper Type	4-7
Setting the Ring Volume	4-8
Setting the Beeper Volume	4-8
Setting the Speaker Volume	4-9
Setting the Clock Change	4-9
Power Save Setting	4-10

5

Setup Receive	5-1
Basic receiving operations	5-1
Choosing the Receive Mode	5-1
To select or change your Receive Mode	5-2
Setting the Ring Delay	5-3
Setting the F/T Ring Time (Fax/Tel mode only)	5-4
Fax Detect	5-5
Printing a reduced incoming fax (Auto Reduction)	5-6
Printing a fax from the memory	5-6
Advanced receiving operations	5-7
Operation from extension telephones	5-7
For Fax/Tel mode only	5-7
Using a cordless external handset	5-8
Changing the remote codes	5-8

Reception into memory (Not available for colour fax reception)	5-9
If the Memory Receive is On at this time.....	5-9
If the Memory Receive is Off at this time.....	5-9
Polling.....	5-10
Secure Polling	5-10
Setup for Polling Receive (Standard)	5-10
Setup for Polling Receive with Secure Code.....	5-11
Setup Delayed Polling Receive	5-11
Sequential Polling.....	5-12
Telephone services	5-13
BT Callsign (For U.K. Only)	5-13
To enable the machine to work with BT Callsign (Only with your external phone)	5-13

6

Setup Send	6-1
How to fax.....	6-1
Enter Fax mode	6-1
How to dial.....	6-1
Manual dialling.....	6-1
Speed-Dialling	6-2
Search	6-2
Faxing from the automatic document feeder (ADF) ...	6-2
Faxing from the ADF	6-2
Faxing from the scanner glass	6-3
Out of Memory message	6-4
Automatic transmission	6-4
Manual transmission.....	6-5
Basic sending operations	6-6
Sending faxes using multiple settings	6-6
Contrast.....	6-6
Fax Resolution.....	6-7
Manual and automatic fax Redial	6-8
Colour fax transmission.....	6-8
Dual Access (Not available for colour faxes).....	6-9
Real Time Transmission.....	6-9
Checking job status	6-10
Cancelling a job while scanning, dialling and sending the document.....	6-11
Cancelling a scheduled job.....	6-11
Advanced sending operations	6-12
Broadcasting (Not available for colour faxes).....	6-12
Overseas Mode	6-13
Delayed Fax (Not available for colour faxes).....	6-14

Delayed Batch Transmission (Not available for colour faxes).....	6-15
Setup for Polled Transmit (Standard) (Not available for colour faxes).....	6-15
Setup for Polled Transmit with Secure Code (Not available for colour faxes).....	6-16
TX Lock	6-17
Using TX Lock	6-18
Setting Up the TX Lock for the First Time	6-18
Changing the TX Lock Password	6-19
Switching TX Lock ON.....	6-19
Switching OFF TX Lock.....	6-20

7

Quick-Dial numbers and dialling options	7-1
Storing numbers for easy dialling	7-1
Storing Speed-Dial numbers.....	7-1
Changing Speed-Dial numbers.....	7-2
Setting up Groups for Broadcasting.....	7-3
Dialling options	7-5
Access codes and credit card numbers.....	7-5
Pause	7-6
Fax Redial.....	7-6
Tone or Pulse	7-6

8

Remote Fax Options	8-1
Fax Forwarding.....	8-1
Programming a Fax Forwarding number.....	8-1
Setting Fax Storage.....	8-2
Backup Print	8-2
Setting your Remote Access Code.....	8-3
Remote Retrieval.....	8-4
Using your Remote Access Code.....	8-4
Remote commands.....	8-5
Retrieving fax messages	8-6
Changing your Fax Forwarding number	8-6

9

Printing reports	9-1
Machine settings and activity.....	9-1
Customizing the Transmission Verification Report	9-1
Setting the Journal Period	9-2
Printing reports	9-3
To print a report.....	9-3

Making copies	10-1
Using the machine as a copier	10-1
Enter Copy mode.....	10-1
Making a single copy	10-2
Making multiple copies	10-2
Out of Memory message	10-3
Using the Copy keys (Temporary settings)	10-4
Enlarge/Reduce.....	10-5
Quality	10-6
Options	10-7
Paper Type.....	10-8
Paper Size.....	10-9
Brightness	10-10
Contrast.....	10-11
Sorting copies using the ADF.....	10-12
N in 1 copy (Page Layout).....	10-13
Changing the default copy settings	10-15
Copy Quality.....	10-15
Brightness.....	10-15
Contrast.....	10-15
Colour Adjustment.....	10-16
Legal limitations.....	10-17

Walk-Up PhotoCapture Center™ (MFC-3820CN only)	11-1
Introduction.....	11-1
PhotoCapture Center™ requirements	11-1
Basic flow	11-2
Getting started	11-3
Printing the Index (Thumbnails).....	11-5
Printing images.....	11-6
Number of Copies	11-7
DPOF printing.....	11-8
Changing the default settings	11-9
Print Quality.....	11-9
Paper & Size.....	11-9
Brightness.....	11-10
Contrast.....	11-10
Colour enhancement	11-11
Cropping.....	11-12
Understanding the Error Messages.....	11-13
Using PhotoCapture Center™ from your PC.....	11-14
Using PhotoCapture Center™ for scanning documents	11-14

Important information	12-1
For your safety.....	12-1
IT power system (For Norway only).....	12-1
LAN connection	12-1
International ENERGY STAR® Compliance	
Statement	12-1
Important safety instructions.....	12-2
Trademarks.....	12-4

Troubleshooting and routine maintenance	13-1
Troubleshooting.....	13-1
Error messages	13-1
Document jams.....	13-4
Document is jammed in the top of	
the ADF unit.....	13-4
Document is jammed inside the ADF unit.	13-4
Printer jam or paper jam	13-5
Paper is jammed inside the front of	
the machine.	13-5
Paper is jammed inside the paper tray	13-6
Paper is jammed inside the machine.....	13-7
If you are having difficulty with your machine	13-8
How to improve print quality	13-12
Cleaning the print head.....	13-12
Print quality check.....	13-12
Checking the ink volume.....	13-15
Packing and shipping the machine	13-16
Routine maintenance.....	13-19
Cleaning the scanner.....	13-19
Cleaning the machine printer platen	13-20
Replacing the ink cartridges	13-21

Glossary	G-1
-----------------------	------------

Specifications	S-1
Product description.....	S-1
General	S-1
Print media.....	S-2
Copy	S-3
PhotoCapture Center (MFC-3820CN only).....	S-3
Fax.....	S-4
Scanner	S-5
Printer	S-6
Interfaces	S-6

Computer requirements	S-7
Consumable items	S-8
Network (LAN) (MFC-3820CN only)	S-8
Index	I-1
Remote Retrieval Access card	R-1

1 Introduction

Using this Guide

Thank you for buying a Brother Multi-Function Center (MFC). Your machine is simple to use, with LCD screen instructions to guide you through programming it. You can make the most of your machine by viewing through this Guide.





Finding information

All the chapter headings and subheadings are listed in the Table of Contents. You will be able to find information about a specific feature or operation by checking the Index at the back of this Guide.

Symbols used in this Guide

Throughout this Guide you'll see special symbols alerting you to important warnings, notes and actions. To make things clearer and to help you press the correct keys, we used special fonts and added some of the messages that will appear in the LCD.

- Bold** Bold typeface identifies specific keys on the machine control panel.
- Italics* Italicized typeface emphasizes an important point or refers you to a related topic.
- Courier New* Courier New type face identifies the messages on the LCD of the machine.

-  Warnings inform you what to do to avoid possible personal injury.
-  Cautions specify procedures you must follow or avoid to prevent possible damage to the machine.
-  Notes tell you how you should respond to a situation that may arise or give tips about how the current operation works with other features.
-  Improper Setup alerts you to devices and operations that are not compatible with the machine.

Control panel overview

MFC-3420C

MFC-3820CN

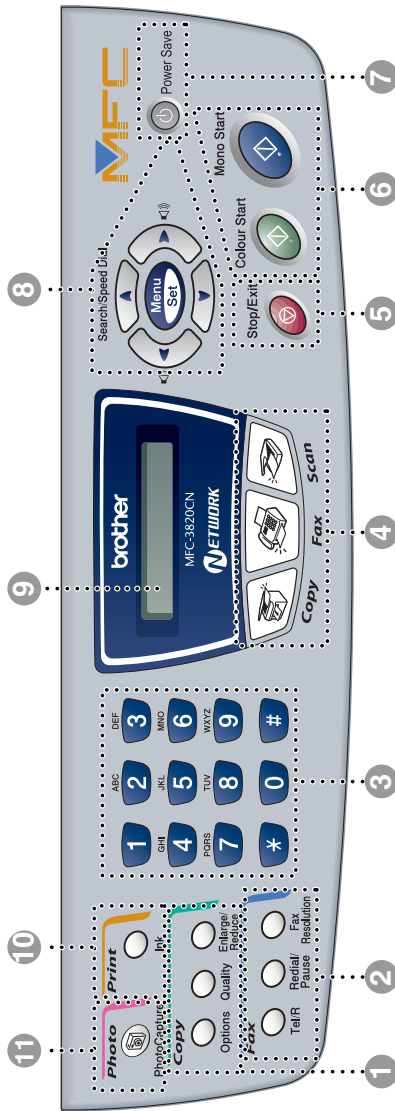
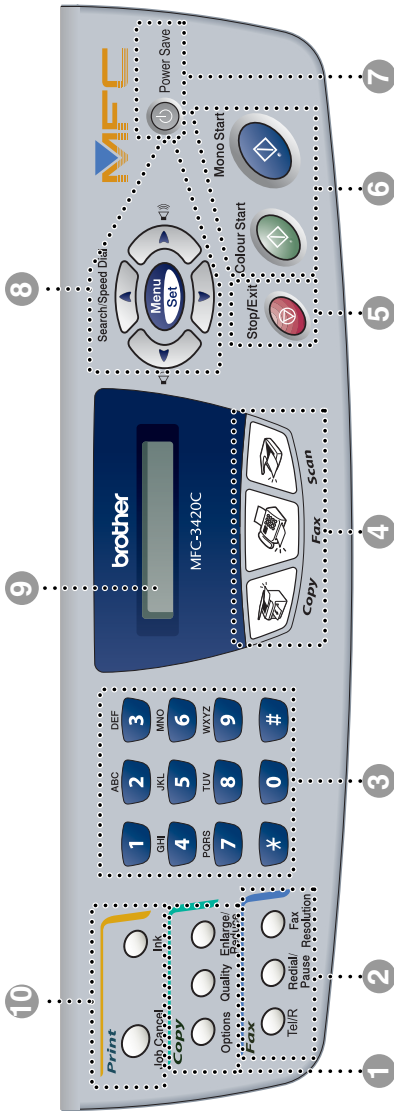

1 Copy keys

(Temporary settings):

Options

You can quickly and easily select temporary settings for copying.

Quality

Use this key to temporarily change the quality for Copying.

Enlarge/Reduce

Lets you enlarge or reduce copies depending on the ratio you select.

2 Fax and telephone keys:

Fax Resolution

Sets the resolution when you send a fax.

Redial/Pause

Redials the last number you called. It also inserts a pause in auto dial numbers.

Tel/R

This key is used to have a telephone conversation having picked up the external handset in F/T pseudo-ringing etc. Also, use this key to transfer a call to another extension when it is connected to a PABX.

3 Dial Pad

Use these keys to dial telephone and fax numbers and as a keyboard for entering information into the machine.

The # key lets you temporarily switch the dialling mode during a telephone call from Pulse to Tone.

4 Mode keys:



Fax

Lets you access Fax mode.



Copy

Lets you access Copy mode.



Scan

Lets you access Scan mode.

5 Stop/Exit



Stops an operation or exits from the menu.

6 Mono Start



Lets you start sending faxes or making copies in black and white. Also lets you start a scanning operation. (Colour or mono, depending on the scanning setting on your PC)

Colour Start



Lets you start sending faxes or making copies in full colour. Also lets you start a scanning operation. (Colour or mono, depending on the scanning setting on your PC)

7 Power Save

You can turn the machine to power save condition.

8 Navigation keys:

Menu/Set

Lets you access the Menu to program and store your settings in the machine.



When using the speaker or during ringing in fax mode, you can press these keys to adjust the volume.



Search/Speed Dial

Lets you look up numbers that are stored in the dialling memory. It also lets you dial stored numbers by pressing # and a two-digit number.



Press to scroll backward to a menu selection.

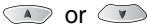

Press to scroll through the menus and options.

Also, you can use these keys to do a numeral search for the names of stored numbers in fax mode.

9 Liquid Crystal Display (LCD)

Displays messages on the screen to help you set up and use your machine.

10 Print keys

Job Cancel (MFC-3420C only)

Clears data from the printer memory.

Ink

Lets you clean the print heads, replace an ink cartridge and check the available ink volume.

11 Photo Key: (MFC-3820CN only)

PhotoCapture

Lets you access the PhotoCapture Center.

Turning the machine to Power Save condition

When the machine is idle, you can turn it to Power Save condition by pressing the **Power Save** key. In Power Save mode, the machine will receive telephone calls, and also receive faxes in Fax Only, Fax/Tel or External TAD mode. The delayed faxes that have been set up will be sent. You can even retrieve faxes using Remote Retrieval if you are away from your machine. If you want to do other operations, you must turn the machine back on.

Turning the machine to Power Save condition

Press and hold down the **Power Save** key until the LCD shows:

Shutting Down

The LCD light will turn off.

Turning the machine to Power Save condition off

Press and hold down the **Power Save** key until the LCD shows:

Please Wait

The LCD will show the date and time (Fax mode).



Even if you turned the machine off, it will periodically clean the print head to preserve print quality.

If you unplug the AC power cord, no machine operations will be available.



You can turn the machine Off by customizing the **Power Save** key as shown next page. In this Off mode, no machine operation will be available. (See *Power Save Setting* on page 4-10.)



The external telephone is always available.

P. Save Setting	Receive Mode	Available Operations
Fax Receive:On (default)	Fax Only Fax/Tel External TAD	Fax Receive, Fax Detect, Delayed Fax, Remote Fax Option, Remote Retrieval: <ul style="list-style-type: none"> ■ You cannot receive fax with Mono Start or Colour Start. ■ Delayed Fax and Remote Fax Option should be set before you switch off the machine.
	Manual	Delayed Fax, Fax Detect: <ul style="list-style-type: none"> ■ You cannot receive fax with Mono Start or Colour Start. ■ Delayed Fax should be set before you switch off machine.
Fax Receive:Off	—	No machine operations will be available.

About fax machines

Fax tones and handshake

When someone is sending a fax, the machine sends fax calling tones (CNG tones). These are quiet, intermittent beeps every 4-seconds. You'll hear them after you dial and press **Mono Start** or **Colour Start** and they will continue for about 60 seconds after dialling. During that time, the sending machine must begin the "handshake", or connection, with the receiving machine.

Each time you use automatic procedures to send a fax, you are sending CNG tones over the phone line. You'll soon learn to listen for these quiet beeps each time you answer a phone on your fax line, so you will know if you are receiving a fax message.

The receiving fax responds with fax receiving tones, which are loud, chirping sounds. A receiving fax chirps for about 40 seconds over the phone line, and the LCD shows *Receiving*.

If your machine is set to the *Fax Only* mode, it will answer every call automatically with fax receiving tones. If the other person hangs up, your machine will continue to send the "chirps" for about 40 seconds, and the LCD continues to show *Receiving*. To cancel receiving, press **Stop/Exit**.

The fax 'handshake' is the time in which the sending machine's CNG tones and the receiving machine's "chirps" overlap. This must be for at least 2 to 4 seconds, so both machines can understand how each is sending and receiving the fax. The handshake cannot begin until the call is answered, and the CNG tones only last for about 60 seconds after the number is dialled. So it is important for the receiving machine to answer the call in as few rings as possible.



When you have an external Telephone Answering Device (TAD) on your fax line, your TAD will decide the number of rings before the call is answered.

Pay special attention to the directions for connecting a TAD in this chapter. (See *Connecting an external telephone answering device (TAD)* on page 1-10.)

ECM (Error Correction Mode)

The Error Correction Mode (ECM) is a way for the machine to check a fax transmission while it is in progress. If the machine detects errors during fax transmission, it resends the pages of the fax that had an error. ECM transmissions are only possible between fax machines that both have this feature. If they do, you may send and receive fax messages that are continuously being checked by the machine.

Your machine must have enough memory for this feature to work.

Connecting the machine

Connecting an external telephone

You can connect a separate telephone (or telephone answering device) as shown in the diagram below.

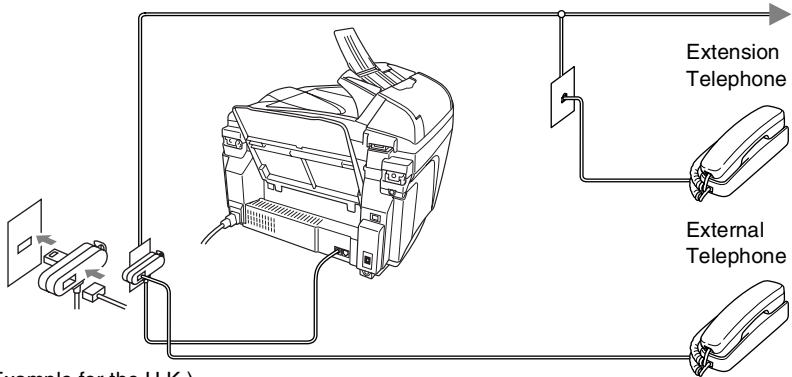

(Example for the U.K.)

When this phone (or TAD) is in use, the LCD shows Telephone.

Connecting an external telephone answering device (TAD)

Sequence

You may choose to connect an answering device. However, when you have an **external** TAD on the same telephone line as the machine, the TAD answers all calls and the machine “listens” for fax calling (CNG) tones. If it hears them, the machine takes over the call and receives the fax. If it doesn’t hear CNG tones, the machine lets the TAD continue playing your outgoing message so your caller can leave you a voice message.

The TAD must answer within four rings (the recommended setting is two rings). The machine cannot hear CNG tones until the TAD has answered the call, and with four rings there are only 8 to 10 seconds of CNG tones left for the fax “handshake”. Make sure you carefully follow the instructions in this guide for recording your outgoing message. We do not recommend using the toll saver feature on your external answering machine if it exceeds five rings.

 If you do not receive all your faxes, reduce the Ring Delay setting on your external TAD.

 **Unless you are using Distinctive Ring, do not connect a TAD elsewhere on the same phone line.**

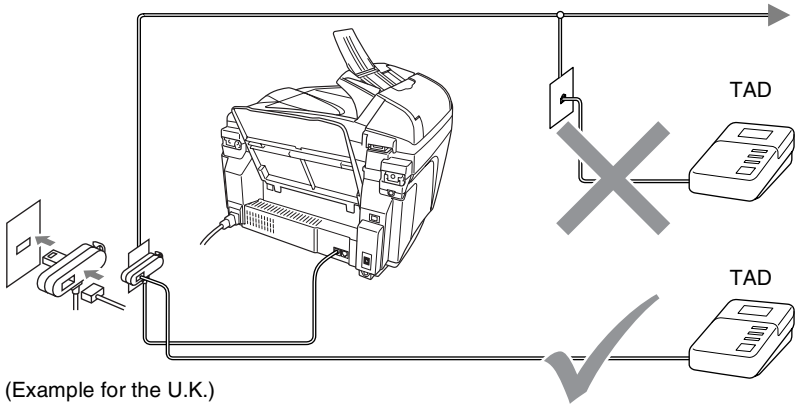

When the TAD is in use, the LCD shows Telephone.

Connections

The external TAD must be connected as shown above.

- 1** Set your external TAD to one or two rings. (The machine's Ring Delay setting does not apply.)
- 2** Record the outgoing message on your external TAD.
- 3** Set the TAD to answer calls.
- 4** Set the Receive Mode to `External TAD`.
(See *Choosing the Receive Mode* on page 5-1.)

Recording outgoing message (OGM) on an external TAD

Timing is important in recording this message. The message sets up the ways to handle both manual and automatic fax reception.

- 1** Record 5 seconds of silence at the beginning of your message. (This allows your machine time to listen for the fax CNG tones of automatic transmissions before they stop.)
- 2** Limit your speaking to 20 seconds.
- 3** End your 20-second message by giving your Fax Receive Code for people sending manual faxes. For example:
*"After the beep, leave a message or send a fax by pressing * 51 and Start."*



We recommend beginning your OGM with an initial 5-second silence because the machine cannot hear fax tones over a resonant or loud voice. You may try omitting this pause, but if your machine has trouble receiving, then you must re-record the OGM to include it.

Using extension telephones (For U.K. only)

It may be that your premises are already wired with parallel extension telephones, or you intend to add extension telephones to your line, in addition to your machine. While the simplest arrangement is straightforward parallel connection, there are some reasons as to why this arrangement will cause unsatisfactory service, the most obvious of which is inadvertent interruption of a facsimile transmission by someone picking up an extension telephone in order to make an outgoing call. Additionally, fax receive code may not operate reliably in such a simple configuration.

This machine may also be set to make a delayed transmission (i.e. a transmission at a pre-set time). This pre-set job may coincide with someone picking up an extension handset.

Such problems can easily be eliminated however, if you arrange modification of your extension wiring circuit, such that extension devices are connected “downstream” of your machine, in a master/slave configuration (see fig. 2 on next page). In such a configuration, this machine can always detect whether a telephone is in use, thus it will not attempt to seize the line during that time. This is known as “telephone off-hook detection.”

The inadvisable configuration is shown in figure 1 on the next page, and the recommended master/slave configuration is shown in figure 2.

This new connection configuration can be arranged by contacting BT, Kingston upon Hull Telecommunications, your PABX maintainer or a qualified telephone installation company as appropriate. Simply explained, the extension telephone circuit should be terminated on a normal modular plug (BT 431A style), which in turn should be inserted into the modular socket of the white “T”-shaped connector provided as part of the line cord assembly.

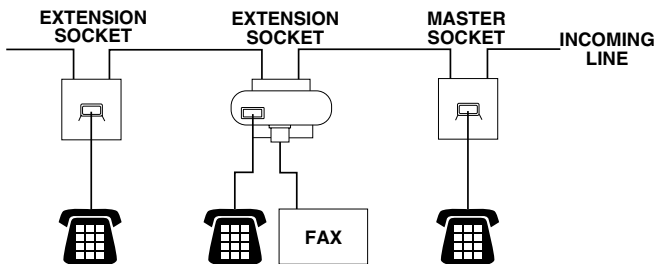

INADVISABLE CONNECTION OF EXTENSION SOCKETS
Fig. 1.

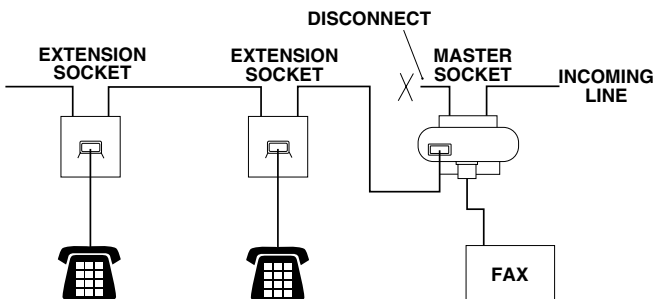

RECOMMENDED CONNECTION OF EXTENSION SOCKETS
Fig. 2.



These phones are now connected as external devices as per page 1-9, because they are connected to the fax machine via the T-connector.

Multi-line connections (PBX)

Most offices use a central telephone system. While it is often relatively simple to connect the machine to a key system or a PBX (Private Branch Exchange), we suggest that you contact the company that installed your telephone system and ask them to connect the machine for you. It is advisable to have a separate line for the machine. You can then leave the Receive Mode set to Fax Only to receive faxes any time of the day or night.

If the machine is to be connected to a multi-line system, ask your installer to connect the unit to the last line on the system. This prevents the unit from being activated each time a telephone call is received.

If you are installing the machine to work with a PBX

- 1** It is not guaranteed that the unit will operate properly under all circumstances with a PBX. Any cases of difficulty should be reported first to the company that handles your PBX.
- 2** If all incoming calls will be answered by a switchboard operator, it is recommended that the Receive Mode be set to *Manual*. All incoming calls should initially be regarded as telephone calls.

Custom features on your phone line

If you have Voice Mail, Call Waiting, Call Waiting/Caller ID, RingMaster, an answering service, an alarm system or other custom feature on one phone line it may create a problem with the operation of your machine. (and *Custom features on a single line*. on page 13-9.)

2

Loading documents and paper

Load documents

You can send a fax, copy and scan from the ADF (automatic document feeder) or from the scanner glass.

Using the automatic document feeder (ADF)

The ADF can hold up to 20 pages and feeds each sheet individually. Use standard (80 g/m²) paper and always fan the pages before putting them in the ADF.

Recommended environment

Temperature: 20° C - 30° C

Humidity: 50% - 70%

Paper: 80 g/m² A4

- ⊘ DO NOT use paper that is curled, wrinkled, folded, ripped, stapled, paper clipped, pasted or taped.
DO NOT use cardboard, newspaper or fabric. (To fax, copy or scan this kind of document, see *Using the scanner glass* on page 2-3.)
- Make sure documents written with ink are completely dry.
- Documents to be faxed must be from 14.8 to 21.6 cm wide and 14.8 to 35.6 cm long.

1 Unfold the ADF Document Support.

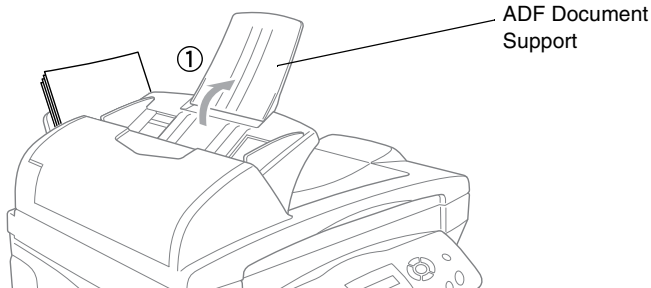

2 Fan the pages well and stagger them at an angle. Make sure you put the documents **face up, top edge first** in the ADF until you feel them touch the feed roller.

3 Adjust the paper guides to fit the width of your documents.

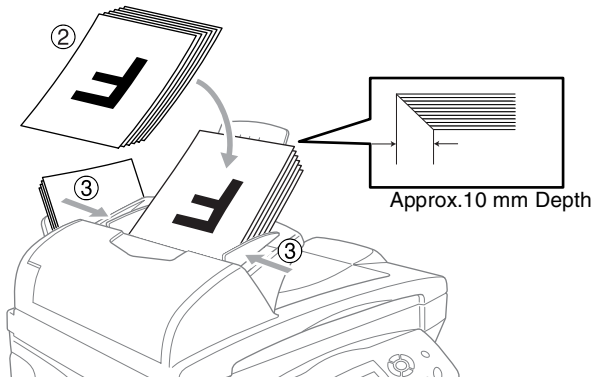

! **DO NOT** pull on the document while it is feeding.



To use the ADF, we recommend that the scanner glass must be empty.

Using the scanner glass

You can use the scanner glass to fax pages of a book or one page at a time. Documents must be A4 size (21.6 to 29.7 cm).

! To use the scanner glass, the ADF must be empty.

1 Lift the document cover.

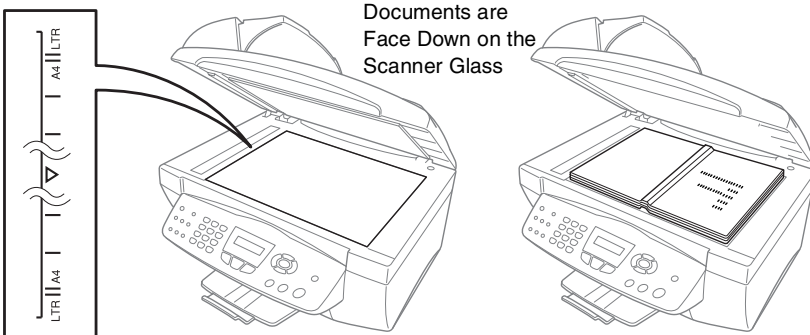

2 Using the document guidelines on the left, center the document face down on the scanner glass.

3 Close the document cover.

! If the document is a book or is thick, do not slam the cover or press on it.

About paper

The print quality of your document can be affected by the kind of paper you use in the machine.

To get the best print quality for the settings you've chosen, always set the Paper Type to match the type of paper you load.

You can use plain paper, inkjet paper (coated paper), glossy paper, transparencies and envelopes.

We recommend testing various paper types before purchasing large quantities.

For best results, use the recommended paper.



When you print on inkjet paper (coated paper), transparencies and glossy paper, be sure to select the proper media in the “Basic” tab in the printer driver or in the Paper Type setting in the menu (**Menu/Set, 1, 2**).

Also avoid stacking by removing each page after it exits the machine to avoid smudging.

Handling and using special paper

- Store paper in its original packaging, and keep it sealed. Keep the paper flat and away from moisture, direct sunlight and heat.
- The coated side of glossy paper is shiny. Avoid touching the shiny (coated) side. Load glossy paper with the shiny side facing up toward you.
- Avoid touching either side of transparencies, because they absorb water and perspiration easily, and this may cause decreased output quality. Transparencies designed for laser printers/copiers may stain your next document. Use only transparencies recommended for inkjet printing.

Paper capacity of the paper tray

Paper Type	Paper Size	Number of sheets
Plain Paper (Cut Sheet)	Letter, Executive, A4, A5, A6, B5 (JIS)	100 of 80 g/m ² up to 10 mm
	Legal	50 of 80 g/m ²
Inkjet Paper	Letter, A4	20
Glossy Paper	Letter, A4	20
Transparencies	Letter, A4	10
Envelopes	DL, COM-10, C5, Monarch, JE4	10
Photo Card	102 mm X 152 mm, L (89 mm X 127 mm), 2L (127 mm x 178 mm)	30
Index Card	127 mm x 203 mm	30

* You can copy only on A4, A5 and Photo Card (102 mm X 152 mm) paper.

* You can receive faxes only on A4 paper.

Paper specifications for the paper tray

Cut Sheet Paper Weight	Plain Paper: 64 to 120 g/m ² Inkjet Paper: 64 to 200 g/m ² Glossy Paper: Up to 220 g/m ² Index card: Up to 120 g/m ²
Thickness	Plain Paper: 0.08 to 0.15 mm Inkjet Paper: 0.08 to 0.25 mm Glossy Paper: Up to 0.25 mm Envelopes: Up to 0.52 mm Photo Card: Up to 0.42 mm Index card: Up to 0.15 mm

Paper capacity of the output paper support

Output Paper Support	<p>Up to 50 sheets of 80 g/m² (A4)</p> <ul style="list-style-type: none">■ Transparencies and glossy paper must be picked up from the output paper support one page at a time to avoid smudging.■ Legal cannot be stacked on the output paper support.
----------------------	--

⊘ Do not use paper or envelopes:

- that are damaged, curled, wrinkled, or irregularly shaped

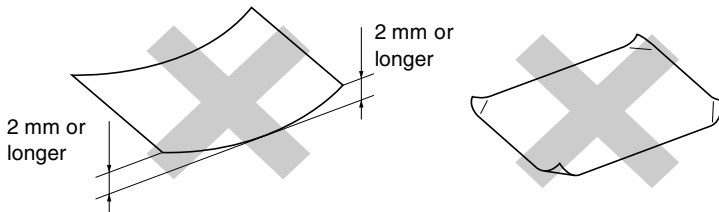

- that are extremely shiny or highly textured
- that were previously printed by a printer
- that cannot be arranged uniformly when stacked
- that are made with a short grain

⊘ Do not use envelopes:

- that are of a baggy construction
- that are embossed (have raised writing on them)
- that have clasps on them
- that are not sharply creased
- that are preprinted on the inside

Printable area

The printable area depends on the settings in the application you are using. The figures below show the unprintable areas on cut sheet paper and envelopes.

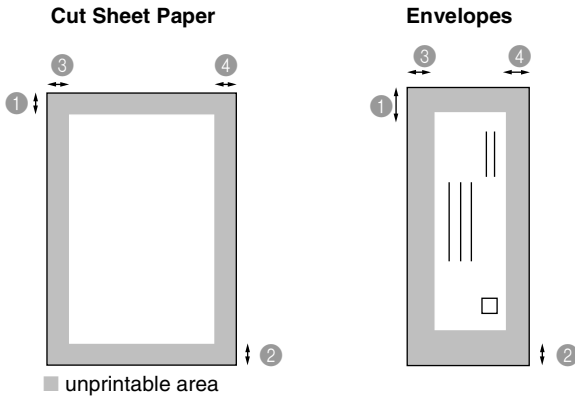

Paper	Paper Size		① Top	② Bottom	③ Left	④ Right
Cut Sheet	A4	Fax	3 mm	12 mm	3 mm	3 mm
		Printer	3 mm	3 mm	3 mm	3 mm
		Copy	3 mm	3 mm	3 mm	3 mm
	A5	Printer	3 mm	3 mm	3 mm	3 mm
		Copy	3 mm	3 mm	3 mm	3 mm
	A6, JIS_B5, Exective	Printer	3 mm	3 mm	3 mm	3 mm
Letter, Legal	Printer	3 mm	3 mm	6 mm	6 mm	
Photo Card	102 mm x 152 mm	Printer	3 mm	3 mm	3 mm	3 mm
		Copy	3 mm	3 mm	3 mm	3 mm
	L, 2L	Printer	3 mm	3 mm	3 mm	3 mm
Index Card	127 mm x 203 mm	Printer	3 mm	3 mm	3 mm	3 mm
Envelopes	DL, C5, COM10, Monarch, JE4	Printer	10 mm	20 mm	3 mm	3 mm



Printable area depends on the Printer driver settings.

The figures above are approximate and the printable area may vary depending on the type of cut sheet paper you are using.

How to load paper and envelopes

To load paper or other media

- 1 Fan the stack of paper well to avoid paper jams and mis-feeds.

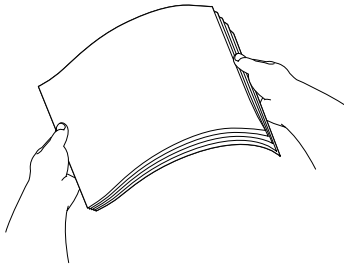

- 2 Press and slide the paper guide to fit the paper width.

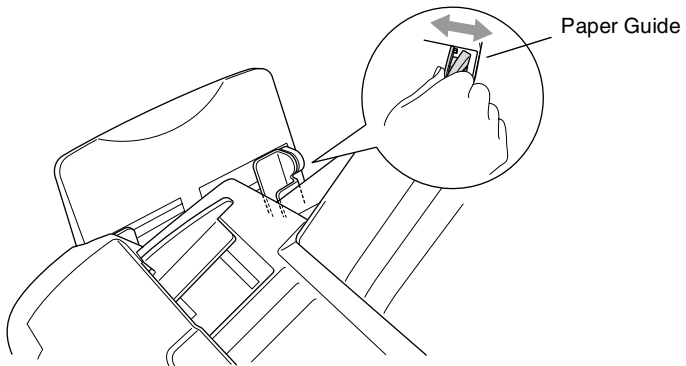

3 Gently insert the paper.

Make sure the print side is towards you and the paper is below the maximum paper mark.

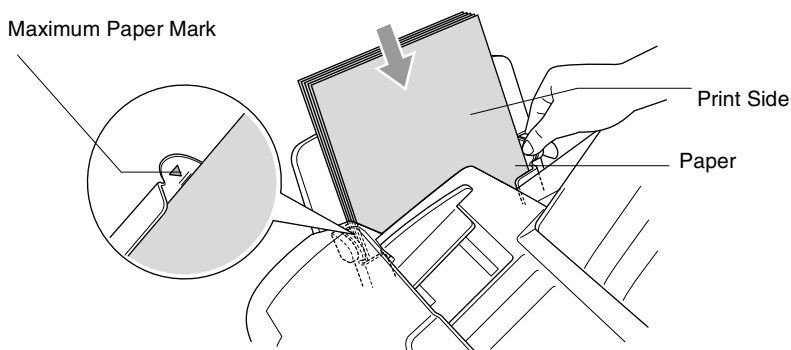

To load glossy paper

1 Fan the stack of glossy paper well.

2 Put a sheet of plain paper in the paper tray first, and then put the stack of glossy paper on top of it.



If the glossy sheets are 'double-feeding', put one sheet in the paper tray at a time.

To load envelopes

- 1 Before loading, press the corners and sides of the envelopes to make them as flat as possible.

 If the envelopes are 'double-feeding', put one envelope in the paper tray at a time.

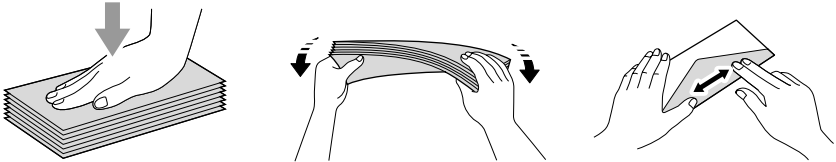

- 2 Press and slide the paper guide to fit the width of the envelopes. Insert them into the paper tray with the address side toward you and pointed in the direction below.

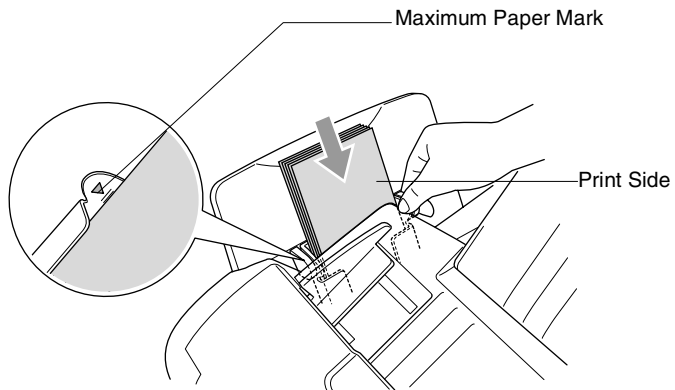

3 On-screen programming

User-friendly programming

Your machine is designed to be easy to use with LCD on-screen programming using the navigation keys. User-friendly programming helps you take full advantage of all the menu selections your machine has to offer.

Since your programming is done on the LCD, we have created step-by-step on-screen instructions to help you program your machine. All you need to do is follow the instructions as they guide you through the menu selections and programming options.

Menu table

You can probably program your machine without the User's Guide if you use the Menu table that begins on page 3-3. These pages will help you understand the menu selections and options that are found in the machine's programs.



You can program your machine by pressing **Menu/Set**, followed by the menu numbers.

For example to set **Fax Resolution** to **Fine**:

Press **Menu/Set**, **2**, **2**, **2** and  or  to select **Fine**.





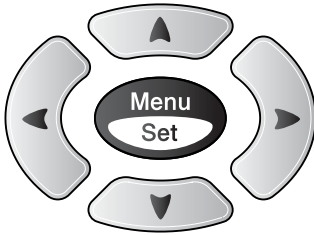

Press **Menu/Set**.

Memory storage

If there is a power failure, you will not lose your menu settings because they are stored permanently. Temporary settings (such as Contrast, Overseas Mode, and so on) will be lost. You may also have to reset the date and time.

Navigation keys



-  * Access the menu
-  * Go to the next menu level
-  * Accept an option
-  * Scroll through the current menu level
-  * Go back to the previous menu level
-  * Exit the menu

You can access the menu mode by pressing **Menu/Set**.
When you enter the menu, the LCD scrolls.

Press **1** for General Setup menu

1.General Setup

—OR—

Press **2** for Fax menu

2.Fax

—OR—



Press **3** for Copy menu

3.Copy

⋮



Press **0** for Initial Setup

0.Initial Setup

You can scroll more quickly through each menu level by pressing the arrow for the direction you want:  or .

Then set an option by pressing **Menu/Set** when that option appears on the LCD.

The LCD will then show the next menu level.

Press  or  to scroll to your next menu selection.

Press **Menu/Set**.

When you finish setting an option, the LCD shows *Accepted*.



Use  to scroll backward if you passed your choices or want to save keystrokes.

Press the Menu numbers.
(ex. Press **1, 2** for Paper Type)

—OR—

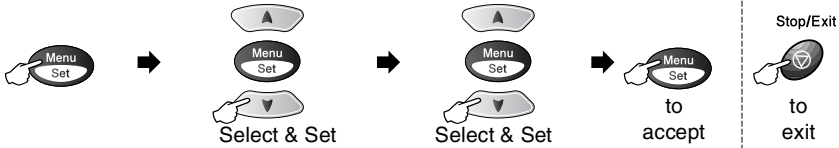

Main Menu	Submenu	Menu Selections	Options	Descriptions	Page	
1.General Setup	1.Mode Timer	—	5 Mins 2 Mins 1 Min 30 Secs 0 Sec Off	Sets the time to return to Fax mode.	4-6	
	2.Paper Type	—	Plain Inkjet Glossy (4-Color or 3-Color) Transprncy	Sets the type of paper in the paper tray.	4-7	
	3.Volume	1.Ring	—	High Med Low Off	Adjusts the ring volume.	4-8
		2.Beeper	—	High Med Low Off	Adjusts the volume level of the beeper.	4-8
		3.Speaker	—	High Med Low Off	Adjusts the speaker volume.	4-9
	4.Clock Change	—	—	To Summer Time To Winter Time	Adjusts the machine's clock by one hour for summer/winter time.	4-9
5.P. Save Setting	—	—	Fax Receive: On Off	Customizes the Power Save key not to receive fax in Standby mode.	4-10	



The factory settings are shown in Bold.

Press the Menu numbers.
(ex. Press 1, 2 for Paper Type)

—OR—



Main Menu	Submenu	Menu Selections	Options	Descriptions	Page
2.Fax	1.Setup Receive (In Fax mode only)	1.Ring Delay	01-04 (02) (UK only) 00-05 (02) (Nordic countries only)	Sets the number of rings before the machine answers in Fax or Fax/Tel mode.	5-3
		2.F/T Ring Time	70 Sec 40 Sec 30 Sec 20 Sec	Sets the pseudo/double-ring time in Fax/Tel mode.	5-4
		3.Fax Detect	On Off	Receives fax messages without pressing the Start key.	5-5
		4.Remote Code	On (*51, #51) Off	You can answer all calls at an extension or external phone and use codes to turn the machine on or off. You can personalize these codes.	5-8
		5.Auto Reduction	On Off	Reduces the size of incoming faxes.	5-6
		6.Memory Receive	On Off	Automatically stores any incoming faxes in its memory if it runs out of paper.	5-9
		7.Polling RX	Standard Secure Timer	Sets up your machine to poll another fax machine.	5-10



The factory settings are shown in Bold.

Press the Menu numbers.
(ex. Press **1, 2** for Paper Type)

—OR—



Main Menu	Submenu	Menu Selections	Options	Descriptions	Page
2.Fax (Continued)	2.Setup Send (In Fax mode only)	1.Contrast	Auto Light Dark	Changes the lightness or darkness of faxes you send.	6-6
		2.Fax Resolution	Standard Fine S.Fine Photo	Sets the default resolution for outgoing faxes.	6-7
		3.Delayed Fax	—	Set the time of day in 24 hour format that the delayed faxes will be sent.	6-14
		4.Batch TX	On Off	Combines delayed faxes to the same fax number at the same time of day into one transmission.	6-15
		5.Real Time TX	Off On Next Fax Only	You can send a fax without using the memory.	6-9
		6.Polled TX	Standard Secure	Sets up the document on your machine to be retrieved by another fax machine.	6-15
		7.Overseas Mode	On Off	Adjusts for overseas transmissions, which can sometimes cause problems.	6-13
	3.Set Quick-Dial	1.Speed-Dial	—	Stores Speed-Dial numbers, so you can dial by pressing only a few keys (and Start).	7-1
		2.Setup Groups	—	Sets up a Group number for Broadcasting.	7-3



The factory settings are shown in Bold.

Press the Menu numbers.
(ex. Press 1, 2 for Paper Type)

—OR—

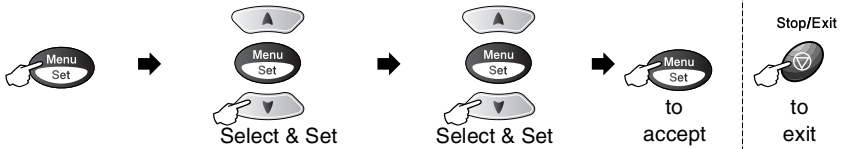

Main Menu	Submenu	Menu Selections	Options	Descriptions	Page
2.Fax (Continued)	4.Report Setting	1.XMIT Report	On On+Image Off Off+Image	Initial setup for Transmission Verification Report and Journal Report.	9-1
		2.Journal Period	Every 7 Days Every 2 Days Every 24 Hours Every 12 Hours Every 6 Hours Every 50 Faxes Journal: Off		9-2
	5.Remote Fax Opt	1.Fax Forward	On Off	Sets the machine to forward fax messages.	8-1
		2.Fax Storage	On Off	Stores incoming faxes in the memory so you can retrieve them while you are away from your machine.	8-2
		3.Remote Access	---*	You must set your own code for Remote Retrieval.	8-3
		4.Print Document	—	Prints incoming faxes stored in the memory.	5-6 8-2
	6.Remaining Jobs	—	—	Checks which jobs are in the memory or cancels a delayed fax or polling job.	6-10
	0. Miscellaneous	1.TX Lock	—	Prohibits most functions except receiving faxes into memory.	6-17
		2.BT Callsign (U.K. Only)	On Off	Use with BT Callsign.	5-13



The factory settings are shown in Bold.

Press the Menu numbers.
(ex. Press 1, 2 for Paper Type)

—OR—

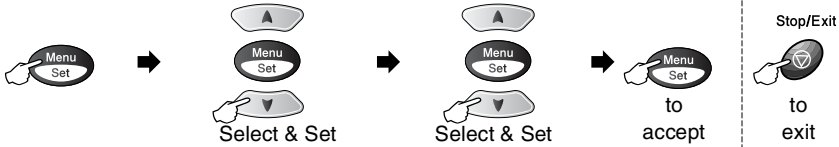

Main Menu	Submenu	Menu Selections	Options	Descriptions	Page	
3.Copy	1.Quality		Best Normal Fast	Selects the Copy resolution for your type of document.	10-15	
	2.Brightness	—	- o o o o ■ + - o o o o □ + - o o o o □ + - o ■ o o o + - ■ o o o o +	Adjusts the brightness.	10-15	
	3.Contrast	—	- o o o o ■ + - o o o o □ + - o o o o □ + - o ■ o o o + - ■ o o o o +	Adjusts the contrast for copies.	10-15	
	4.Color Adjust	1.Red		R:- o o o o ■ + R:- o o o o □ + R:- o o o o □ + R:- o o o o □ + R:- ■ o o o o +	Adjusts the amount of Red in copies.	10-16
		2.Green		G:- o o o o ■ + G:- o o o o □ + G:- o o o o □ + G:- o o o o □ + G:- ■ o o o o +	Adjusts the amount of Green in copies.	
		3.Blue		B:- o o o o ■ + B:- o o o o □ + B:- o o o o □ + B:- o o o o □ + B:- ■ o o o o +	Adjusts the amount of Blue in copies.	



The factory settings are shown in Bold.

Press the Menu numbers.
(ex. Press 1, 2 for Paper Type)

—OR—

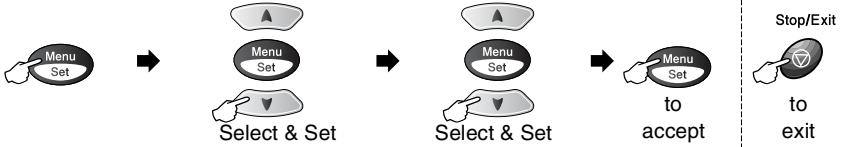

Main Menu	Submenu	Menu Selections	Options	Descriptions	Page
4.PhotoCapture (MFC-3820CN only)	1.Print Quality	—	Normal Fine Photo	Selects the print quality.	11-9
	2.Paper & Size	—	10x15cm Glossy 13x18cm Glossy A4 Glossy A4 Plain 10x15cm Inkjet A4 Inkjet	Selects the paper and print size.	11-9
	3.Brightness	—	- □□□□ + - □□□□ + - □□□□ + - □□□□ + - ■□□□ +	Adjusts the brightness.	11-10
	4.Contrast	—	- □□□□ + - □□□□ + - □□□□ + - □□□□ + - ■□□□ +	Adjusts the contrast.	11-10
	5.Color Enhance	Enhance:On Enhance:Off	1.White Balance - □□□□ + - □□□□ + - □□□□ + - □□□□ + - ■□□□ + 2.Sharpness - □□□□ + - □□□□ + - □□□□ + - □□□□ + - ■□□□ + 3.Color Density - □□□□ + - □□□□ + - □□□□ + - □□□□ + - ■□□□ +	Adjusts the hue of the white areas.	11-11
			Enhances the detail of the image.		
			Adjusts the total amount of colour in the image.		



The factory settings are shown in Bold.

Press the Menu numbers.
(ex. Press **1, 2** for Paper Type)

—OR—



Main Menu	Submenu	Menu Selections	Options	Descriptions	Page
4.PhotoCapture (MFC-3820CN only) (Continued)	6.Cropping		Cropping:On Cropping:Off	Crops the image around the margin to fit the paper size or print size. Turn this feature off if you want to print whole images or prevent unwanted cropping.	11-12
	7.Scan to Card	1.Quality	B/W 200x100 dpi B/W 200 dpi Color 150 dpi Color 300 dpi Color 600 dpi	Selects the Scan resolution for your type of original.	2-23 ^{*1}
		2.B/W File Type	TIFF PDF	Selects the default file format for black and white scanning.	2-23 ^{*1}
		3.ColorFile Type	PDF JPEG	Selects the default file format for colour scanning.	2-23 ^{*1}
4.Test Print (MFC-3420C only) 6.Test Print (MFC-3820CN only)				You can print a test sample page to check the print quality and adjust the Vertical Alignment.	13-12



The factory settings are shown in **Bold**.

^{*1} See the complete Software User's Guide on the CD-ROM.

Press the Menu numbers.
(ex. Press 1, 2 for Paper Type)

—OR—

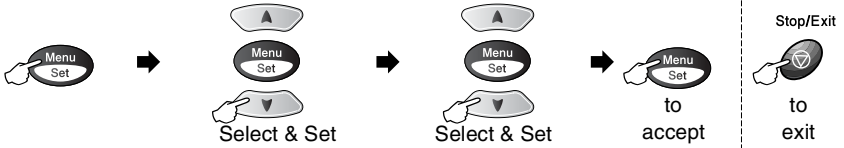

Main Menu	Submenu	Menu Selections	Options	Descriptions	Page
5.LAN (MFC-3820CN only)	1.Setup TCP / IP	1.BOOT Method	Auto Static RARP BOOTP DHCP	You can choose the BOOT method that best suits you needs.	See Network User's Guide on the CD-ROM
		2.IP Address	[000-255]. [000-255]. [000-255]. [000-255]	Enter the IP address.	
		3.Subnet Mask	[000-255]. [000-255]. [000-255]. [000-255]	Enter the Subnet mask.	
		4.Gateway	[000-255]. [000-255]. [000-255]. [000-255]	Enter the Gateway address.	
		5.Host Name	BRN_XXXXXX	Enter the Host name.	
		6.WINS Config	Auto Static	You can choose the WINS configuration mode.	
		7.WINS Server	(Primary) 000.000.000.000	Specifies the IP address of the primary or secondary server.	
		8.DNS Server	(Primary) 000.000.000.000	Specifies the IP address of the primary or secondary server.	
		9.APIPA	On Off	Automatically allocates the IP address from the link-local address range.	



The factory settings are shown in Bold.

Press the Menu numbers.
(ex. Press 1, 2 for Paper Type)

—OR—



Main Menu	Submenu	Menu Selections	Options	Descriptions	Page
5. LAN (MFC-3820CN only) (Continued)	2. Setup Misc.	1. Ethernet	Auto 100B-FD 100B-HD 10B-FD 10B-HD	Selects Ethernet link mode.	See Network User's Guide on the CD-ROM
		2. Time Zone	GMT-XX:XX	Sets the time zone for your country.	
5. Print Reports (MFC-3420C only) 7. Print Reports (MFC-3820CN only)	1. Help List	—	—	You can print these lists and reports.	9-3
	2. Quick-Dial	—	—		
	3. Fax Journal	—	—		
	4. XMIT Verify	—	—		
	5. User Settings	—	—		
	6. Network Config (MFC-3820CN only)	—	—		
0. Initial Setup	1. Receive Mode	—	Fax Only Fax/Tel External TAD Manual	You can choose the receive mode that best suits your needs.	5-1 5-2
	2. Date/Time	—	—	Puts the date and time on the LCD and in headings of faxes you send.	4-1
	3. Station ID	—	Fax Name	Program your name and fax number to appear on each page you fax.	4-2
	4. Tone/Pulse	—	Tone Pulse	Selects the dialling mode.	4-4



The factory settings are shown in Bold.

Press the Menu numbers.
(ex. Press **1, 2** for Paper Type)

—OR—

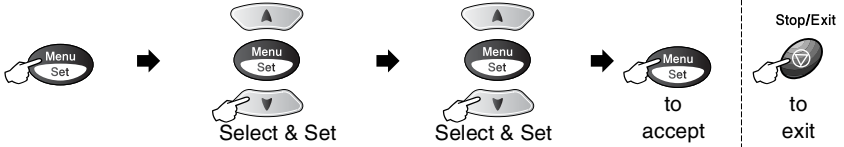

Main Menu	Submenu	Menu Selections	Options	Descriptions	Page
0.Initial Setup (Continued)	5.PBX (MFC-3420C only)	—	On off	Turn on this function if the machine is connected to PABX (private automatic Branch Exchange).	4-4
	5.Phone Line Set (MFC-3820CN only)	—	Normal PBX ADSL	Selects the phone line type.	4-5
	6.Local Language (For Czech and Hungarian)	—	Czech Hungarian English	Allows you to change the LCD Language for your country.	See Quick Setup Guide
	6.Local Language (For Norwegian, Swedish, Danish and Finnish)	—	Norwegian Swedish Danish Finnish English	Allows you to change the LCD Language for your country.	See Quick Setup Guide



The factory settings are shown in Bold.

4 Getting started

Initial Setup

Setting the Date and Time

Your machine displays the date and time and if you set up the Station ID it prints on every fax you send. If there is a power failure, you may have to reset the date and time. All other settings will not be affected.

- 1** Press **Menu/Set, 0, 2.**
- 2** Enter the last two digits of the year.
Press **Menu/Set.**
- 3** Enter two digits for the month.
Press **Menu/Set.**
(For example, enter 09 for September, or 10 for October.)
- 4** Enter two digits for the day.
Press **Menu/Set.**
(For example, enter 06 for 6th.)
- 5** Enter the time in 24-Hour format.
Press **Menu/Set.**
(For example, enter 15:25 for 3:25 P.M.)
- 6** Press **Stop/Exit.**
The LCD now shows the date and time whenever the machine is in Fax mode.

Setting the Station ID

You should store your name or company name and fax number on all fax pages that you send.

It is important that you enter the fax number in the internationally standardised format, i.e. in accordance with the following strict sequence:

- The “+” (plus) character (by pressing * key)
- Your Country Code (e.g. “44” for the United Kingdom, “41” for Switzerland)
- Your local area code minus any leading “0” (“9” in Spain)
- A space
- Your number on the local exchange, using spaces to aid readability as appropriate.

As an example, if the machine is installed in the United Kingdom and the same line is to be used for both fax and voice calls, and your national telephone number is 0161 444 5555, then you must set the fax and telephone number parts of your station ID as:

+44 161 444 5555.

1 Press **Menu/Set, 0, 3.**

3.Station ID

2 Enter your fax number (up to 20 digits).

Fax:

Press **Menu/Set.**



You cannot enter a hyphen.

3 Use the dial pad to enter your name (up to 20 characters).

Name:

Press **Menu/Set.**

4 Press **Stop/Exit.**

The LCD will go back standby mode automatically.



If the Station ID has already been programmed, the LCD will ask you to press **1** to make a change or **2** to exit without changing.

Entering text

When you are setting certain menu selections, such as the Station ID, you may need to type text into the machine. Most number keys have three or four letters printed above them. The keys for **0**, **#** and ***** do not have printed letters because they are used for special characters.

By pressing the appropriate number key repeatedly, you can access the character you want.

Press Key	one time	two times	three times	four times
2	A	B	C	2
3	D	E	F	3
4	G	H	I	4
5	J	K	L	5
6	M	N	O	6
7	P	Q	R	S
8	T	U	V	8
9	W	X	Y	Z

Inserting spaces

To enter a space, press  once between numbers and twice between characters.



Making corrections

If you entered a letter incorrectly and want to change it, press  to move the cursor under the incorrect character. Then press **Stop/Exit**. All letters above and to the right of the cursor will be deleted. Re-enter the correct character. You can also back up and type over incorrect letters.

Repeating letters

If you need to enter a character that is on the same key as the previous character, press  to move the cursor to the right before you press the key again.

Special characters and symbols

Press *****, **#** or **0**, and then press  or  to move the cursor under the special character or symbol you want. Then press **Menu/Set** to select it.

Press ***** for (space) ! " # \$ % & ' () * + , - . / €

Press **#** for : ; < = > ? @ [] ^ _

Press **0** for Ä Æ Ö Ü À Ç È É 0

Setting Tone or Pulse dialling mode (Except for the Nordic Countries)

1 Press **Menu/Set, 0, 4.**

4. Tone/Pulse

2 Press  or  to select Pulse (or Tone).

Press **Menu/Set.**

3 Press **Stop/Exit.**

Setting PABX (MFC-3420C only)

If the machine is connected to a PABX system, set PBX to On. If not, set it to Off.

1 Press **Menu/Set, 0, 5.**

5. PBX

2 Press  or  to select On (or Off).

Press **Menu/Set.**

3 Press **Stop/Exit.**

Setting the Phone Line Type (MFC-3820CN only)

If you are connecting this machine to a PBX or PABX, you need to change the Phone Line Type to PBX by completing the following steps. If you are connecting this machine to a phone line that is also using a ADSL (Asymmetric Digital Subscriber Line) to send and receive faxes, it is also necessary to change the Phone Line Type to ADSL by completing the following steps.

1 Press **Menu/Set, 0, 5**.

5.Phone Line Set

2 Press  or  to select PBX, ADSL (or Normal).

Press **Menu/Set**.

3 Press **Stop/Exit**.

PABX and TRANSFER

The machine is initially set to be connected with PSTN (Public Switched Telephone Network) lines. However, many offices use a central telephone system or Private Automatic Branch Exchange (PABX). Your fax can be connected to most types of PABX. The recall facility on the machine supports timed break recall only (TBR), PABX normally can work with this for gaining access to an outside line, or for transferring a call to another extension: The feature works when the **Tel/R** key is pressed.



You can program a **Tel/R** keypress as part of a number stored in a Speed-Dial location. When programming the Speed-Dial number (Function menu 2-3-1 or 2-3-2) press **Tel/R** first (the screen displays "!"), then enter the telephone number. If you do this, you do not need to press **Tel/R** each time before you dial using a Speed-Dial location. (See *Storing numbers for easy dialling* on page 7-1.)

However, if PBX is set to **Off**, you cannot use the Speed-Dial number that the **Tel/R** key press is programmed into.

General Setup

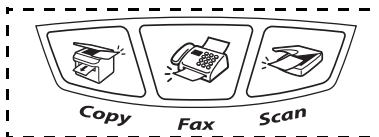

Setting the Mode Timer

The machine has three temporary mode keys on the control panel: Fax, Copy and Scan. You can change the number of seconds or minutes the machine takes after the last Copy or Scan operation before it returns to Fax mode. If you select **OFF**, the machine stays in the mode you used last.



1 Press **Menu/Set**, **1**, **1**.

1.Mode Timer

2 Press  or  to select

0 Sec, 30 Secs, 1 Min, 2 Mins, 5 Mins or Off.

3 Press **Menu/Set**.

4 Press **Stop/Exit**.

Setting the Paper Type



To get the best print quality, set the machine for the type of paper you are using.

1 Press **Menu/Set**, **1**, **2**.

2. Paper Type

2 Press  or  to select Plain, Inkjet, Glossy or Transprncy.

Press **Menu/Set**.

3 If you selected Glossy, press  or  to select Glossy : 4-Color or Glossy : 3-Color.

Press **Menu/Set**.

 The print quality of black ink varies depending on the kind of glossy paper you are using. Black ink is used when you select Glossy : 4-Color. If the glossy paper you are using repels the black ink, select Glossy : 3-Color, which simulates black ink by combining the three ink colours.

4 Press **Stop/Exit**.



 The machine ejects paper with printed surfaces face up onto the paper tray in the front of the machine. When you use transparencies or glossy paper, remove each sheet immediately to prevent smudging or paper jams.

Setting the Ring Volume

You can adjust the ring volume when your machine is idle (not being used). You can turn the ring **Off** or you can select the ring volume level.

1 Press **Menu/Set, 1, 3, 1.**



1.Ring

2 Press  or  to select (Low, Med, High or Off).

Press **Menu/Set.**

3 Press **Stop/Exit.**

—OR—



In Fax mode, press  or  to adjust the volume level. Every time you press these keys, the machine will ring so you can hear the active setting as the LCD shows it. The volume changes with each key press. The new setting will stay until you change it again.

Setting the Beeper Volume

You can change the beeper volume. The default (factory) setting is **Low**. When the beeper is on, the machine beeps every time you press a key or make a mistake and after a fax is sent or received.

1 Press **Menu/Set, 1, 3, 2.**

2.Beeper

2 Press  or  to select your option.

(Low, Med, High or Off)

Press **Menu/Set.**



3 Press **Stop/Exit.**

Setting the Speaker Volume

You can adjust the machine's one-way speaker volume.

1 Press **Menu/Set, 1, 3, 3.**

3.Speaker

2 Press  or  to select
(Low, Med, High or Off).

Press **Menu/Set.**



3 Press **Stop/Exit.**

Setting the Clock Change

You can easily let the machine's clock gain or lose one hour by using this feature.

1 Press **Menu/Set, 1, 4.**

4.Clock Change

2 Press  or  to select To
Summer Time (or To Winter Time)

3 Press **Menu/Set.**

4 Press **1** to change to Winter Time or Summer Time.

—OR—

Press **2** to exit without changing.

Power Save Setting

You can customise the machine's **Power Save** key. The default mode is On. Your machine can receive faxes or calls even if the machine is Power Save mode. If you want to have your machine not to receive faxes or calls, turn this setting to `Fax Receive:Off`. (See *Turning the machine to Power Save condition* on page 1-5.)

1 Press **Menu/Set**, **1**, **5**.

5.P.Save Setting

2 Press  or  to select Off (or On).

3 Press **Menu/Set**.

4 Press **Stop/Exit**.

5 Setup Receive

Basic receiving operations

Choosing the Receive Mode

There are four different Receive Modes for your machine. You can choose the mode that best suits your needs.

LCD	How it works	When to use it
Fax Only (automatic receive)	The machine automatically answers every call as a fax.	For dedicated fax lines.
Fax/Tel* (fax and telephone) (with an external or extension telephone)	The machine controls the line and automatically answers every call. If the call is a fax it will receive the fax. If the call is not a fax it will ring (pseudo/double ring) for you to pick up the call.	Use this mode if you expect to receive lots of fax messages and few telephone calls. You cannot have an answering machine on the same line, even if it is on a separate wall socket/phone socket on the same line. You cannot use the telephone company's Voice Mail in this mode.
External TAD (with an external answering machine)	The external answering machine (TAD) automatically answers every call. Voice messages are stored on the external TAD. Fax messages are printed.	Use this mode if you have connected an answering machine on your phone line. The TAD setting works only with an external answering machine. Ring Delay and F/T Ring Time do not work in this setting.
Manual (manual receive) (with an external or extension telephone)	You control the phone line and must answer every call yourself.	Use this mode when you are using a computer modem on the same line or if you don't receive many fax messages or with Distinctive Ring. If you answer and hear fax tones, wait until the machine takes over the call, then hang up. (See <i>Fax Detect</i> on page 5-5.)



* In Fax/Tel mode you must set the Ring Delay and F/T Ring Time.

To select or change your Receive Mode

1 If it is not illuminated in green, press  (**Fax**).

2 Press **Menu/Set, 0, 1**.

1.Receive Mode

3 Press  or  to select

Fax Only, Fax/Tel, External TAD or Manual.

Press **Menu/Set**.

4 Press **Stop/Exit**.

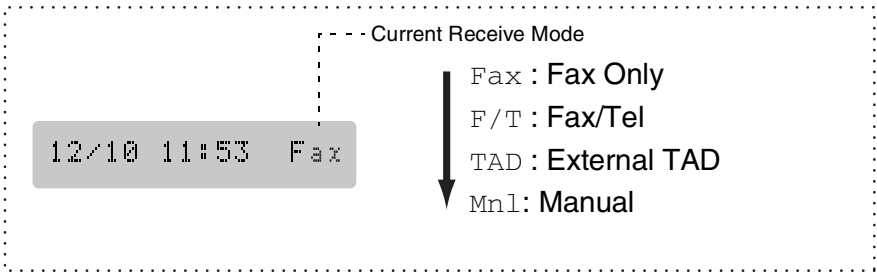

 If you are changing the Receive Mode while in another operation, the LCD will return to that operation.



Setting the Ring Delay

The Ring Delay sets the number of times the machine rings before it answers in **Fax Only** or **Fax/Tel** mode. If you have extension phones on the same line as the machine or subscribe to the telephone company's Distinctive Ring service, keep the Ring Delay setting of 4.

(See *Fax Detect* on page 5-5 and *Operation from extension telephones* on page 5-7.)



- 1** If it is not illuminated in green, press  **(Fax)**.
- 2** Press **Menu/Set, 2, 1, 1**.
- 3** Press  or  to select how many times the line rings before the machine answers.
Press **Menu/Set**.
(If you select 00, the line won't ring at all.)
- 4** Press **Stop/Exit**.

1.Ring Delay

Setting the F/T Ring Time (Fax/Tel mode only)

If you set the Receive Mode to Fax/Tel, you'll need to decide how long the machine will signal you with its special pseudo/double-ring when you have a *voice* call. (If it's a fax call, the machine prints the fax.)

This pseudo/double-ring happens after the initial ringing from the phone company. Only the machine rings and no other phones on the same line will ring with the special pseudo/double-ring. However, you can still answer the call on any extension phone (in a separate wall socket/phone socket) on the same line as the machine. (See *Operation from extension telephones* on page 5-7.)

- 1** If it is not illuminated in green, press  **(Fax)**.
- 2** Press **Menu/Set, 2, 1, 2**. 2.F/T Ring Time
- 3** Press  or  to select how long the machine will ring to alert you that you have a voice call (20, 30, 40 or 70 seconds).
Press **Menu/Set**.
- 4** Press **Stop/Exit**.

 Even if the caller hangs up during the pseudo/double-ringing, the machine will continue to ring for the set time.

Fax Detect

When you use this feature, you don't have to press **Mono Start**, **Colour Start**, or the Fax Receive Code *51 when you answer a fax call. Selecting **On** allows the machine to receive fax calls automatically, even if you lift the handset of an extension or external phone. When you see **Receiving** on the LCD or when you hear 'chirps' through the handset of an extension phone connected to another phone socket, just replace the handset and your machine will do the rest. Selecting **Off** means you'll have to activate the machine yourself by lifting the handset of an external or extension phone, and then press **Mono Start** or **Colour Start** on the machine—**OR**—by pressing *51 if you are not at your machine. (See *Operation from extension telephones* on page 5-7.)



If this feature is set to **On**, but your machine doesn't connect a fax call when you lift a extension or external phone handset, press the Fax Receive Code *51.

If you send faxes from a computer on the same phone line and the machine intercepts them, set Fax Detect to **Off**.

1 If it is not illuminated in green, press  **(Fax)**.

2 Press **Menu/Set, 2, 1, 3**.

3.Fax Detect

3 Use  or  to select **On** (or **Off**).

Press **Menu/Set**.

4 Press **Stop/Exit**.

Printing a reduced incoming fax (Auto Reduction)

If you choose **On**, the machine reduces an incoming fax automatically, so that it fits on to one page of A4 size paper.

1 If it is not illuminated in green, press  **(Fax)**.

2 Press **Menu/Set, 2, 1, 5**.

5.Auto Reduction

3 Use  or  to select **On** (or **Off**).

Press **Menu/Set**.

4 Press **Stop/Exit**.

 If you receive faxes that are split onto two pages, turn on this setting. But if sending document is too long, the machine may print it on two pages.

 If left and right margins are cut off, turn on this setting.

Printing a fax from the memory

If you set Fax Storage to **ON** for Remote Retrieval, you can still print a fax from the memory when you are at your machine. (See *Setting Fax Storage* on page 8-2.)

1 Press **Menu/Set, 2, 5, 4**.

4.Print Document

2 Press **Mono Start** or **Colour Start**.

3 After printing has finished, press **Stop/Exit**.

Advanced receiving operations

Operation from extension telephones

If you answer a fax call on an extension telephone, or an external telephone, you can make your machine take the call by using the Fax Receive Code. When you press the Fax Receive Code ***51**, the machine starts to receive a fax. (See *Fax Detect* on page 5-5.)

If the machine answers a voice call and pseudo/double-rings for you to take over, use the Telephone Answer Code **#51** to take the call at an extension phone. (See *Setting the F/T Ring Time (Fax/Tel mode only)* on page 5-4.)

If you answer a call and no one is on the line, you should assume that you're receiving a manual fax.

- Press ***51** and wait for the chirp or until the machine's LCD displays Receiving, and then hang up.

Your caller will have to press Start to send the fax.

For Fax/Tel mode only

When the machine is in Fax/Tel mode, it will use the F/T Ring Time (pseudo/double-ringing) to alert you to pick up a voice call.

If you're at the machine, you can lift the handset to answer.

Lift the external telephone's handset, and then press **Tel/R** to answer.

If you're at an extension phone, you'll need to lift the handset during the F/T Ring Time and then press **#51** between the pseudo/double rings. If no one is on the line, or if someone wants to send you a fax, send the call back to the machine by pressing ***51**.

Using a cordless external handset

If your cordless telephone is connected onto the line socket unit and you typically carry the cordless handset elsewhere, it is easier to answer calls during the Ring Delay. If you let the machine answer first, you will have to go to the machine so you can press **Tel/R** to transfer the call to the cordless handset.

Changing the remote codes

Remote Codes might not work with some telephone systems. The preset Fax Receive Code is ***51**. The preset Telephone Answer Code is **#51**.



If you are always disconnected when accessing your external TAD remotely, try changing the Fax Receive Code and Telephone Answer Code to another three-digit code (such as **###** and **998**).

1 If it is not illuminated in green, press  **(Fax)**.

2 Press **Menu/Set, 2, 1, 4**.

4.Remote Code

3 Press  or  to select **On** (or **Off**).

Press **Menu/Set**.

4 If you want to, enter a new Fax Receive Code.

Press **Menu/Set**.

5 If you want to, enter a new Telephone Answer Code.

Press **Menu/Set**.

6 Press **Stop/Exit**.

Reception into memory (Not available for colour fax reception)

As soon as the paper tray becomes empty during fax reception, the screen will display **Check Paper**; please put some paper in the paper tray. (See *How to load paper and envelopes* on page 2-8.)

If the Memory Receive is On at this time...

The current fax reception will continue, with the remaining page(s) being stored in memory, subject to available memory. Subsequent incoming faxes will also be stored into memory until the memory is full, following this no further incoming fax call will be automatically answered. To print all data put fresh paper in the paper tray and press **Mono Start** or **Colour Start**.

If the Memory Receive is Off at this time...

The current fax reception will continue, with the remaining page(s) being stored in memory, subject to available memory. Subsequent incoming faxes calls will not be automatically answered until fresh paper is put in the paper tray. To print the last fax received, put paper in the paper tray and press **Mono Start** or **Colour Start**.

1 If it is not illuminated in green, press  (**Fax**).

2 Press **Menu/Set, 2, 1, 6**.

6.Memory Receive

3 Use  or  to select **On** (or **Off**).

Press **Menu/Set**.

4 Press **Stop/Exit**.

Polling

Polling is the process of retrieving faxes from another fax machine. You can use your machine to 'poll' other machines, or you can have someone poll your machine.

Everyone who is involved in Polling needs to set up their fax machines for Polling. When someone polls your machine to receive a fax, they pay for the call. If you poll someone's fax machine to receive a fax, you pay for the call.



Some fax machines do not respond to the Polling feature.

Secure Polling

Secure Polling is a way to keep your documents and others from falling into the wrong hands while the machine is set up for polling. You can use Secure Polling only with another Brother fax machine. Anyone who polls to receive a fax must enter the polling secure code.



Setup for Polling Receive (Standard)

Polling Receive is when you call another fax machine to receive a fax from it.

1 If it is not illuminated in green, press  **(Fax)**.

2 Press **Menu/Set**, **2**, **1**, **7**.

7.Polling RX



3 Press  or  to select Standard.

Press **Menu/Set**.

4 Enter the fax number you are polling.
Press **Mono Start** or **Colour Start**.



Setup for Polling Receive with Secure Code

You need to make sure you are using the same secure code as the other party.

- 1 If it is not illuminated in green, press  **(Fax)**.
- 2 Press **Menu/Set, 2, 1, 7.** 7.Polling RX
- 3 Press  or  to select **Secure.**
Press **Menu/Set.**
- 4 Enter a four-digit secure code.
This is the same as the security code of the fax machine you are polling.
- 5 Press **Menu/Set.**
- 6 Enter the fax number you are polling.
- 7 Press **Mono Start** or **Colour Start.**

Setup Delayed Polling Receive

You can set the machine to begin Polling Receive at a later time.

- 1 If it is not illuminated in green, press  **(Fax)**.
- 2 Press **Menu/Set, 2, 1, 7.** 7.Polling RX
- 3 Press  or  to select **Timer.**
Press **Menu/Set.**
- 4 The screen prompts you to enter the time you want to begin polling.
- 5 Enter the time (in 24-hour format) you want to begin polling.
For example, enter 21:45 for 9:45 PM.
- 6 Press **Menu/Set.**
- 7 Enter the fax number you are polling,
Press **Mono Start** or **Colour Start.**
The machine makes the polling call at the time you entered.



You can set up only one Delayed Polling.



Sequential Polling

The machine can request documents from several fax units in a single operation. You just specify several destinations in Step 5. Afterward, a Sequential Polling Report will be printed.

1 If it is not illuminated in green, press  **(Fax)**.

2 Press **Menu/Set**, **2**, **1**, **7**.

7.Polling RX

3 Press  or  to choose **Standard**, **Secure** or **Timer**.

Press **Menu/Set** when the screen displays the setting you want.

4 If you selected **Standard**, go to Step 5.

■ If you selected **Secure**, enter a four-digit number and press **Menu/Set**, and then go to Step 5.

■ If you selected **Timer**, enter the time (in 24-hour format) you want to begin polling and press **Menu/Set**, and then go to Step 5.

5 Specify the destination fax machines (up to 390), which you wish to poll by using **Speed-Dial**, **Search**, a **Group** (see *Setting up Groups for Broadcasting* on page 7-3) or the dial pad. You must press **Menu/Set** between each location.

6 Press **Mono Start** or **Colour Start**.

The machine polls each number or group in turn for a document.

 Press **Stop/Exit** while the machine is dialling to cancel the polling process.

To cancel all sequential polling receive jobs, press **Menu/Set**, **2**, **6**. (See *Cancelling a scheduled job* on page 6-11.)

Telephone services

BT Callsign (For U.K. Only)

This machine feature lets you use the BT Callsign subscriber service which allows you to have at least two separate telephone numbers on one phone line. Each phone number has its own distinctive ringing pattern, so you know which phone number is ringing. This is one way you can have a separate phone number for your machine. Your machine has a BT Callsign compatible distinctive ringing function, allowing you to dedicate a second phone number (on the same phone line) just for receiving faxes.



You can switch BT callsign off temporarily, then turn it back on. When you get a new fax number, make sure you reset this function.



When you set the BT Callsign feature to ON, the receive mode is set to **Manual** automatically. You can not change the receive mode to the other mode while the BT Callsign is set to on.

To enable the machine to work with BT Callsign (Only with your external phone)

1 Press **Menu/Set, 2, 0, 2**.

The screen displays the current setting of this feature.

2 Press  or  to select **On** (or **Off**).

3 Press **Menu/Set**.

4 Press **Stop/Exit**.





If you turn off the BT Callsign, receive mode stays **Manual**. You need to set receive mode again.

6 Setup Send

How to fax

You can send faxes from the ADF (automatic document feeder) or from the scanner glass.

Enter Fax mode

Before sending faxes, make sure  (**Fax**) is illuminated in green. If not, press  (**Fax**) to enter Fax mode. The default setting is Fax.

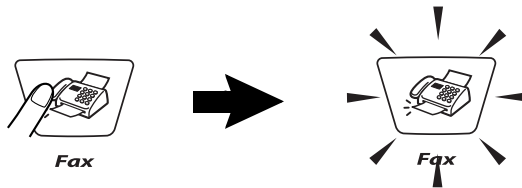

How to dial

There are three ways to dial.

Manual dialling

Press all of the digits of the phone or fax number.



Speed-Dialling

Press **Search/Speed Dial**, #, and then the two digit Speed-Dial number. (See *Storing Speed-Dial numbers* on page 7-1.)

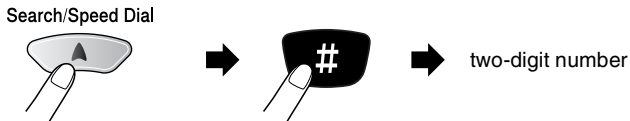

 If the LCD shows **Not Registered** when you enter the Speed-Dial number, a number has not been stored for it.

Search

You can search for names you have stored in the Speed-Dial memories. Press **Search/Speed Dial** and the navigation keys to search. (See *Storing Speed-Dial numbers* on page 7-1.)

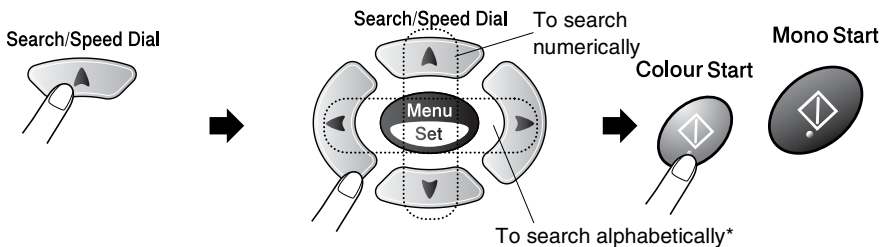

* To search alphabetically, you can use dial pad to enter the first letter of the name you are looking for.

Faxing from the automatic document feeder (ADF)

Faxing from the ADF

- 1 If it is not illuminated in green, press  (**Fax**).
- 2 Load your document. (See *Load documents* on page 2-1.)
- 3 Dial the fax number.

Press **Mono Start** or **Colour Start**. The machine starts scanning the first page.

Faxing from the scanner glass

You can use the scanner glass to fax pages of a book or one page at a time. The documents can be up to A4 size. To cancel, press **Stop/Exit**.

1 If it is not illuminated in green, press  (**Fax**).

2 Load your document on the scanner glass. (See *Using the scanner glass* on page 2-3.)

3 Dial the fax number.

Press **Mono Start** or **Colour Start**.

The machine starts scanning the first page.

If you press **Colour Start**, the machine starts sending.

4 To send a single page, press **2** (or press **Mono Start** again).

The machine starts sending the document.

—**OR**—

To send more than one page, press **1** and go to Step 5.

5 Place the next page on the scanner glass.

Press **Menu/Set**.

The machine starts scanning. (Repeat Steps 4 and 5 for each additional page.)



■ If the memory is full and you are faxing a single page, it will be sent in real time.

■ If you need to cancel before the fax is sent, press **Stop/Exit**. You cannot send multiple pages for colour faxes.

Out of Memory message

If you get an *Out of Memory* message while scanning the first page of a fax, press **Stop/Exit** to cancel the scan. If you get an *Out of Memory* message while scanning a subsequent page, you will have the option to press **Mono Start** to send the pages scanned so far, or to press **Stop/Exit** to cancel the operation.



If the memory is full and you are faxing a single page, it will be sent in real time.

Automatic transmission

This is the easiest way to send a fax.



Do not pick up the hand set of the external phone.

1

If it is not illuminated in green, press  **(Fax)**.

2

Load your document. (See *Load documents* on page 2-1.)

3

Enter the fax number using the dial pad, Speed-Dial or Search. (See *How to dial* on page 6-1.)

4

Press **Mono Start** or **Colour Start**.

Manual transmission

Manual transmission lets you hear the dialling, ringing and fax-receiving tones while sending a fax.

- 1** If it is not illuminated in green, press  (**Fax**).
- 2** Load your document. (See *Load documents* on page 2-1.)
- 3** Pick up the handset of the external phone and listen for a dial tone.
- 4** On the external phone, dial the fax number you want to call.
- 5** When you hear the fax tone, press **Mono Start** or **Colour Start**.
- 6** If you picked up the handset of the external phone, replace it.

Basic sending operations

Sending faxes using multiple settings

When you send a fax you can choose any combination of these settings: contrast, resolution, overseas mode, delayed fax timer, polling transmission or real time transmission.

1 If it is not illuminated in green, press  (**Fax**) before pressing **Menu/Set**. After each setting is accepted, the LCD will ask if you want to enter more settings:

2 Press **1** to select more settings. The LCD will return to the `Setup Send` menu.

Next

1.Yes 2.No

—OR—

Press **2** if you have finished choosing settings and go to the next step.

Contrast

If your document is very light or very dark, you may want to set the contrast.

Use `Light` to send a light document or make the fax darker.

Use `Dark` to send a dark document or make the fax lighter.

1 If it is not illuminated in green, press  (**Fax**).

2 Load your document. (See *Load documents* on page 2-1.)

3 Press **Menu/Set, 2, 2, 1**.

1.Contrast

4 Press  or  to select `Auto`, `Light` or `Dark`.

Press **Menu/Set**.

5 Press **1** if you want to choose more settings and the LCD will return to the `Setup Send` menu.



—OR—

Press **2** if you have finished choosing settings.

6 Enter a fax number.



Press **Mono Start** or **Colour Start**.

Fax Resolution

You can use the **Fax Resolution** key to change the setting temporarily (for this fax only). In fax mode, press **Fax Resolution** and  or  to select the setting you want, and then press **Menu/Set**.

—OR—

You can change the default setting:

- 1 If it is not illuminated in green, press  (**Fax**).
- 2 Load your document. (See *Load documents* on page 2-1.)
- 3 Press **Menu/Set, 2, 2, 2**. 2.Fax Resolution
- 4 Press  or  to select the resolution you want.
Press **Menu/Set**.
- 5 Press **1** if you want to choose more settings and the LCD will return to the *Setup Send* menu.

—OR—

Press **2** if you have finished choosing settings.

- 6 Enter a fax number.

Press **Mono Start** or **Colour Start**.

Standard	Suitable for most typed documents.
Fine	Good for small print and transmits a little slower than Standard resolution.
S.Fine	Good for small print or artwork and transmits slower than Fine resolution.
Photo	Use when the document has varying shades of gray or photograph. This has the slowest transmission time.

Manual and automatic fax Redial

If you are sending a fax manually and the line is busy, press **Redial/Pause**, and then press **Mono Start** or **Colour Start** to try again. If you want to make a second call to the last number dialled, you can save time by pressing **Redial/Pause** and **Mono Start** or **Colour Start**.

Redial/Pause only works if you dialled from the control panel.

If you are sending a fax automatically and the line is busy, the machine will automatically redial up to three times at five minutes intervals.

Colour fax transmission

Your machine can send a colour fax to machines that support this feature.

However, colour faxes cannot be stored in the memory, so Delayed fax and Polling Transmit features are not available.

- 1 If it is not illuminated in green, press  **(Fax)**.
- 2 Load your document. (See *Load documents* on page 2-1.)
- 3 Enter the fax number using the dial pad, Speed-Dial or Search.
- 4 Press **Colour Start**.

 When you send a colour fax, the machine will send it in real time (even if `Real Time TX` is set to `Off`).

 You can not send multiple pages from the scanner glass.

Dual Access (Not available for colour faxes)

You can dial a number, and begin scanning the fax into memory—even when the machine is sending from memory or receiving faxes. The LCD shows the new job number and available memory.



Your machine normally uses Dual Access. However, to send a colour fax, the machine will send the document in real time (even if **Real Time TX** is **Off**).

The number of pages you can scan into the memory will vary depending on the data that is printed on them.



If you get a **Out of Memory** message while scanning the first page of a fax, press **Stop/Exit** to cancel scanning. If you get a **Out of Memory** message while scanning a subsequent page, you can press **Mono Start** to send the pages scanned so far, or press **Stop/Exit** to cancel the operation.

Real Time Transmission

When you are sending a fax, the machine will scan the documents into the memory before sending. Then, as soon as the phone line is free, the machine will start dialling and sending.

If the memory becomes full, the machine will send the document in real time (even if **Real Time TX** is set to **Off**).

Sometimes, you may want to send an important document immediately, without waiting for memory transmission. You can set **Real Time TX** to **On** for all documents or for the next fax only.



If you want to fax multiple pages from the scanner glass, **Real Time Transmission** should be set to **Off**.

1 If it is not illuminated in green, press  (**Fax**).

2 Load your document. (See *Load documents* on page 2-1.)

3 Press **Menu/Set, 2, 2, 5**.



5.Real Time TX

4 To change the default setting, press  or  to select On (or Off).



Press **Menu/Set**.

Go to Step 6.

—OR—

For the next fax transmission only, press  or  to select Next Fax Only.

Press **Menu/Set**.

5 Press  or  to select Next Fax:On (or Next Fax:Off).

Press **Menu/Set**.

6 Press **1** if you want to choose more settings and the LCD will return to the Setup Send menu.

—OR—

Press **2** if you have finished choosing settings.

7 Enter a fax number.

Press **Mono Start** or **Colour Start**.



In Real Time Transmission, the redial feature doesn't work.





If you are sending a colour Fax, the machine will send it in real time (even if Real Time TX is set to Off).

Checking job status

Check which jobs are still waiting in the memory to be sent. (If there are no jobs, the LCD shows No Jobs Waiting.)

1 Press **Menu/Set, 2, 6**.

6.Remaining Jobs

2 If you have more than one job waiting, press  or  to scroll through the list.

3 Press **Stop/Exit**.

Canceling a job while scanning, dialling and sending the document

You can cancel a job while you are scanning it into memory by pressing **Stop/Exit**.

You can also cancel a job while the machine is dialling or sending the document by pressing **Stop/Exit**.



Canceling a scheduled job

You can cancel a fax job that is stored and waiting in memory.

1 Press **Menu/Set**, **2**, **6**.

6.Remaining Jobs

Any jobs that are waiting will appear on the LCD.

2 If you have more than two jobs waiting, press  or  to select the job you want to cancel.

Press **Menu/Set**.

—OR—

If you only have one job waiting, go to Step 3.

3 Press **1** to cancel.

—OR—

Press **2** to exit without cancelling.

To cancel another job go to Step 2.

4 Press **Stop/Exit**.

Advanced sending operations

Broadcasting (Not available for colour faxes)

Broadcasting is when the same fax message is automatically sent to more than one fax number. Using the **Menu/Set** key, you can include Groups, Speed-Dial numbers and up to 50 manually dialled numbers. If you did not use up any of the numbers for Groups, access codes or credit card numbers, you can 'broadcast' faxes to as many as 90 (MFC-3420C only) or 150 (MFC-3820CN only) different numbers. However, the available memory will vary depending on the types of jobs in the memory and the number of locations used for broadcasting. If you broadcast to the maximum numbers available, you will not be able to use Dual Access and Delayed fax.

To include Speed-Dial numbers and manually dialled numbers in the same broadcast, you must press **Menu/Set** between each of the numbers. Use **Search/Speed Dial** to help you choose the numbers easily.

(See *Setting up Groups for Broadcasting* on page 7-3.)

After the broadcast is finished, a Broadcast Report will be printed to let you know the results.



- Enter the long dialling sequence numbers as you would normally, but remember that each Speed-Dial number counts as one number, so the number of locations you can store becomes limited.
- If the memory is full, press **Stop/Exit** to stop the job or if more than one page has been scanned, press **Mono Start** to send the portion that is in the memory.

- 1 If it is not illuminated in green, press  (**Fax**).
- 2 Load your document. (See *Load documents* on page 2-1.)
- 3 Enter a number using Speed-Dial, a Group number, Search or manual dialling using the dial pad.
(Example: Group number)

- 4 When the LCD displays the fax number or name of the other party, press **Menu/Set**.
You will be asked to press the next number.
- 5 Enter the next number.
(Example: Speed-Dial number)
- 6 When the LCD displays the fax number or name of the other party, press **Menu/Set**.
- 7 Enter another fax number.
(Example: Manual dialling using the dial pad.)
- 8 Press **Mono Start**.

Overseas Mode

If you are having difficulty sending a fax overseas due to possible interference on the phone line, we recommend that you turn on the Overseas Mode. After you send a fax using this feature, the feature will turn itself off.

- 1 If it is not illuminated in green, press  (**Fax**).
- 2 Load your document. (See *Load documents* on page 2-1.)
- 3 Press **Menu/Set, 2, 2, 7**. 7.Overseas Mode
- 4 Press  or  to select On (or Off).
Press **Menu/Set**.
- 5 Press **1** if you want to choose more settings and the LCD will return to the *Setup Send* menu.
—OR—
Press **2** if you have finished choosing settings.
- 6 Enter a fax number.
Press **Mono Start** or **Colour Start**.

Delayed Fax (Not available for colour faxes)

During the day you can store up to 50 faxes in the memory to be sent within 24 hours. These faxes will be sent at the time of day you enter in Step 4. Press **Menu/Set** to accept it, or enter another time for the faxes to be sent.

- 1 If it is not illuminated in green, press  (**Fax**).
- 2 Load your document. (See *Load documents* on page 2-1.)
- 3 Press **Menu/Set, 2, 2, 3**. 3.Delayed Fax
- 4 Enter the time you want the fax to be sent (in 24-hour format).
Press **Menu/Set**.
(For example, enter 19:45 for 7:45 PM.)
- 5 Press **1** if you want to choose more settings and the LCD will return to the `Setup Send` menu.
—OR—
Press **2** if you have finished choosing settings.
- 6 Enter a fax number.
Press **Mono Start**.



The number of pages you can scan into the memory depends on the amount of data that is printed on each page.

Delayed Batch Transmission (Not available for colour faxes)

Before sending the delayed faxes, your machine will help you economize by sorting all the faxes in the memory by destination and scheduled time. All delayed faxes that are scheduled to be sent at the same time to the same fax number will be sent as one fax to save transmission time.

1 If it is not illuminated in green, press  **(Fax)**.

2 Press **Menu/Set, 2, 2, 4**.

4.Batch TX

3 Press  or  to select **On** (or **Off**).

Press **Menu/Set**.

4 Press **Stop/Exit**.

Setup for Polled Transmit (Standard) (Not available for colour faxes)

Polled Transmit is when you set up the machine to wait with a document in memory so another fax machine can retrieve it.

1 If it is not illuminated in green, press  **(Fax)**.

2 Load your document. (See *Load documents* on page 2-1.)

3 Press **Menu/Set, 2, 2, 6**.

4 Press  or  to select **Standard**.

Press **Menu/Set**.

5 Press **1** if you want to select additional settings. The display returns to the **Setup Send** menu.



—OR—

Press **2** if you finished selecting settings, and go to Step 5.

6 Press **Mono Start** and wait for the fax to be polled.

Setup for Polled Transmit with Secure Code (Not available for colour faxes)

When you choose `Polled TX:Secure`, anyone who polls the machine must enter the polling secure code.

- 1** If it is not illuminated in green, press  (**Fax**).
- 2** Load your document. (See *Load documents* on page 2-1.)
- 3** Press **Menu/Set, 2, 2, 6**.
- 4** Press  or  to select `Secure`.
Press **Menu/Set**.
- 5** Enter a four-digit number.
Press **Menu/Set**.
- 6** Press **1** if you want to select additional settings. The display returns to the `Setup Send` menu.

—OR—

Press **2** if you finished selecting settings, and go to Step 7.

- 7** Press **Mono Start**.

The machine starts scanning the document.



You can use Secure Polling only with another Brother fax machine.



The document will be stored and can be retrieved from any other fax machine until you delete the fax in memory by using the Cancelling a job function. (See *Cancelling a scheduled job* on page 6-11.)

TX Lock

This feature allows you to prevent unauthorised access to the machine. When switched On, TX Lock prohibits most functions. The following functions listed are available while TX Lock is switched On.

- Receiving faxes
- Answering & making telephone calls with an external telephone
- Scheduled Delayed Transmission*
- Polling*
- Fax Forwarding*
- Remote Retrieval



* Provided it was set before TX Lock was switched ON.

Using TX Lock

You must use a password to switch TX Lock ON and OFF.

Setting Up the TX Lock for the First Time

- 1 Press **Menu/Set**, **2**, **0**, **1**. 1.TX Lock
- 2 Enter a 4-digit number as a new password. New Passwd:XXXX
- 3 Press **Menu/Set**. Verify:XXXX

The screen prompts you to re-enter the password.
- 4 Re-enter the password and press **Menu/Set**.
- 5 Press  or  to choose **Set TX Lock**.
- 6 Press **Menu/Set**. The screen prompts you to enter the password. Password:XXXX
- 7 Enter a 4-digit password, followed by **Menu/Set**.



This is the same as the security password of the machine already stored.

The screen displays *Accepted* for 2 seconds, followed by *TX Lock Mode - TX Lock is now switched ON*.



If the password you enter at Step 7 is incorrect, the screen would display *Wrong Password*. After 2 seconds the display will then return to normal (displaying the date & time). You must then switch ON TX Lock again. (See *Switching TX Lock ON* on page 6-19.)



Changing the TX Lock Password

- 1 Press **Menu/Set**, **2**, **0**, **1**. 1.TX Lock
- 2 Press  or  to choose Set Password.
- 3 Press **Menu/Set**. Old Passwd:XXXX

The screen prompts you to enter the old password.
- 4 Enter the current password.
- 5 Press **Menu/Set**. New Passwd:XXXX
- 6 Enter a 4-digit number as a new password.
- 7 Press **Menu/Set**. Verify:XXXX

The screen prompts you to re-enter the new password.
- 8 Enter the new password again and press **Menu/Set**.
- 9 Press **Stop/Exit**.

Switching TX Lock ON

- 1 Press **Menu/Set**, **2**, **0**, **1**. 1.TX Lock
- 2 Press  or  to choose Set TX Lock.
- 3 Press **Menu/Set**. The screen prompts you to enter the password. Password:XXXX
- 4 Enter a 4-digit password, followed by **Menu/Set**.

This is the same as the security password of the machine already stored.

The screen displays *Accepted* for 2 seconds, followed by TX Lock Mode - TX Lock is now switched ON.



If the password you enter at Step 4 is incorrect, the screen would display *Wrong Password*. After 2 seconds the display will then return to normal (displaying the date & time). You must then start from Step 1 to set TX Lock.

Switching OFF TX Lock

1 When TX Lock is switched ON, press **Menu/Set**.

Password:XXXX

2 Enter a 4-digit password and press **Menu/Set**.

The screen displays *Accepted*, then after 2 seconds the display reverts to normal. TX Lock is now switched OFF.



If the password you enter at Step 2 is incorrect, the screen would display *Wrong Password*. After 2 seconds the display will then return to displaying *TX Lock Mode*. You must then start from Step 1 to switch OFF TX Lock.

If you forget the TX Lock password, please contact your Brother dealer or Brother for assistance.

7

Quick-Dial numbers and dialling options

Storing numbers for easy dialling

You can set up your machine to do two types of easy dialling: Speed-Dial and Groups for Broadcasting faxes.



If you lose electrical power, the quick-dial numbers that are in the memory will not be lost.

Storing Speed-Dial numbers

You can store Speed-Dial numbers, so that when you dial you will only have to press a few keys (**Search/Speed Dial**, #, the two-digit number, and **Mono Start** or **Colour Start**). The MFC-3420C can store 40 Speed-Dial numbers and the MFC-3820CN can store 100 numbers.

1 Press **Menu/Set**, **2**, **3**, **1**.

1.Speed-Dial

2 Use the dial pad to enter a two-digit

Speed-Dial location number

(01-40 for MFC-3420C, 00-99 for MFC-3820CN).

(For example, press **05**.)

Press **Menu/Set**.

3 Enter the phone or fax number (up to 20 digits).

Press **Menu/Set**.

4 Use the dial pad to enter the name (up to 15 characters).

Press **Menu/Set**.

(You can use the chart on page 4-3 to help you enter letters.)

—OR—

Press **Menu/Set** to store the number without a name.

5 Go to Step 2 to store another Speed-Dial number.

—OR—

Press **Stop/Exit**.

Changing Speed-Dial numbers

If you try to store a Speed-Dial number where a number is already stored, the LCD will show the name stored there (or number) and will ask you to do one of the following:



- 1 Press **1** to change the stored number.

1.Change 2.Exit

—OR—

Press **2** to exit without making a change.

How to change the stored number:

- If you want to erase the whole number or whole name, press **Stop/Exit** when the cursor is under the first the digits or letters. The characters above and to the right of the cursor will be deleted.
 - If you want to change a character, use  or  to position the cursor under the character you want to change, and then type over it.
- 2 Enter a new number.
Press **Menu/Set**.
 - 3 Follow the directions beginning at Step 5 in Storing Speed-Dial numbers on the previous page.

Setting up Groups for Broadcasting

Groups allow you to send the same fax message to many fax numbers by pressing only a few keys (**Search/Speed Dial**, **#**, the two-digit number, and **Mono Start**). First, you'll need to store each fax number as a Speed-Dial number.

Then, you can combine them into a Group. Each Group uses up a Speed-Dial number. You can have up to six Groups, or you can assign up to 39 numbers (MFC-3420C) or up to 99 numbers (MFC-3820CN) to one large Group.

(See *Storing Speed-Dial numbers* on page 7-1 and *Broadcasting* (Not available for colour faxes) on page 6-12.)

1 Press **Menu/Set**, **2**, **3**, **2**.

2.Setup Groups

2 Use the dial pad to enter the two-digit Speed-Dial number where you want to store the Group.

Speed-Dial? #

Press **Menu/Set**.

Speed-Dial? #07

(For example, press **07** and **Menu/Set**.)

3 Use the dial pad to enter the Group number.

Setup Group:G01

Press **Menu/Set**.

(For example, press **1** for Group 1.)



The Group number must be between 1 and 6.

4 To include Speed-Dial numbers in the Group, press them as follows:

G01:#01#09

For example, for Speed-Dial numbers 05 and 09. Press **Search/Speed Dial**, **05**, **Search/Speed Dial**, **09**. The LCD shows: #05#09.

5 Press **Menu/Set** to accept the Speed-Dial numbers for this Group.

6 Use the dial pad and the chart on page 4-3 to enter a name for the Group.

Name:

Press **Menu/Set**.

(For example, type NEW CLIENTS).

7 Press **Stop/Exit**.



You can print a list of all the Speed-Dial numbers. Group numbers will be marked in the column of "GROUP".
(See *Printing reports* on page 9-3.)

Dialling options



There are three ways to dial. (See *How to dial* on page 6-1.)

Access codes and credit card numbers

Sometimes you may want to choose from several long distance carriers when you make a call. Rates may vary depending on the time and destination. To take advantage of low rates, you can store the access codes or long-distance carriers and credit card numbers as Speed-Dial numbers. You can store these long dialling sequences by dividing them and setting them up on separate keys in any combination. You can even include manual dialling using the dial pad. The combined number will be dialled in the order that you entered it as soon as you press **Mono Start** or **Colour Start**.

(See *Storing Speed-Dial numbers* on page 7-1.)

For example, you can store '555' on Speed-Dial #03 and '7000' on Speed-Dial #02. If you press **Search/Speed Dial, #03, Search/Speed Dial, #02, and Mono Start** or **Colour Start**, you will dial '555-7000'.

To temporarily change a number, you can substitute part of the number with manual dialling using the dial pad.

For example, to change the number to 555-7001 you could press **Search/Speed Dial, #03** and then press **7001** using the dialling pad.



If you must wait for another dial tone or signal at any point in the dialling sequence, store a pause there in the number by pressing **Redial/Pause**. Each key press adds a 3.5-second delay.

Pause

Press **Redial/Pause** to insert a 3.5-second pause between numbers. If you are dialling overseas, you can press **Redial/Pause** as many times as needed to increase the length of the pause.

Fax Redial

If you're sending a fax manually and the line is busy, press **Redial/Pause** to try again. Any time you want to make a second call to the last number dialled, press **Redial/Pause** to save time.

If you're sending a fax automatically and the line is busy, the machine will automatically redial one time five minutes after the transmission.

Tone or Pulse

If you have a Pulse dialling service, but need to send Tone signals (for example, for telephone banking), follow the instructions below. If you have Touch Tone service, you will not need this feature to send tone signals.

- 1** Lift the handset of the external phone.
- 2** Press **#** on the control panel of your machine. Any digits dialled after this will send tone signals.
- 3** When you hang up, the machine will return to the Pulse dialling service.

8

Remote Fax Options

(Not available for colour faxes)

Fax Forwarding



After you have selected Fax Forwarding, Fax Storage is set to **On** automatically. If you bring the Fax Forwarding feature back to **Off**, Fax Storage stays on.

Programming a Fax Forwarding number

When Fax Forwarding is set to **On**, your machine stores the received fax in the memory. Then it dials the fax number you've programmed and forwards the fax message.

1 Press **Menu/Set**, **2**, **5**, **1**.

1.Fax Forward

2 Press  or  to select **On** (or **Off**).

Press **Menu/Set**.

The LCD will ask you to enter the fax number to which faxes will be forwarded.

3 Enter the forwarding number (up to 20 digits).

Press **Menu/Set**.

4 Press **Stop/Exit**.

Setting Fax Storage

If you set Fax Storage to ON, you will be able to retrieve fax messages from another location using Fax Forwarding or Remote Retrieval operations. (See *Remote commands* on page 8-5.) If there is paper in your machine, a back-up copy of each fax will be printed. The LCD will show when you have a fax stored in memory.

1 Press **Menu/Set, 2, 5, 2.**

2.Fax Storage

The LCD will ask you to choose a fax setting.

2 Press  or  to select On (or Off).

Press **Menu/Set.**

3 Press **Stop/Exit.**



If there are faxes in the memory when you turn Fax Storage OFF, the LCD will ask if you want to erase the faxes in the memory.

Erase All Doc?

1.Yes 2.No

If you press **1**, all fax data is erased and Fax Storage is turned off.

If you press **2**, faxes are not erased and Fax Storage stays on. (See *Printing a fax from the memory* on page 5-6.)



■ After you have selected the Fax Forwarding feature, Fax Storage is set to **On** automatically. If you turn the Fax Forwarding feature back to **Off**, Fax Storage stays on.

Backup Print

If you've set Fax Storage to **On**, your machine automatically prints faxes as they are received into the memory.

This is a safety feature in case the power goes off so you won't lose your messages.

Setting your Remote Access Code

The remote access code lets you access the Remote Retrieval features when you are away from your machine. Before you use the remote access and retrieval features, you have to set up your own code. The default code is inactive code (--- *).

1 Press **Menu/Set**, **2**, **5**, **3**.

3.Remote Access

2 Enter a three-digit code using numbers **0-9**, ***** or **#**.

Press **Menu/Set**. (The preset ‘*’ cannot be changed.)

 Do not use the same digits that appear in your Fax Receive Code (***51**) or Telephone Answer Code (**#51**).
(See *Operation from extension telephones* on page 5-7.)

3 Press **Stop/Exit**.

 You can change your code at any time by entering a new one. If you want to make your code inactive, press **Stop/Exit** in Step 2 to restore the inactive setting (--- *).

Remote Retrieval

You can call your machine from any touch tone telephone or fax machine, then use the Remote Access Code and remote commands to retrieve fax messages. Be sure to cut out the Remote Retrieval Access Card on the last page and keep it with you at all times.

Using your Remote Access Code

- 1** Dial your fax number from a telephone or another fax machine using touch tone.
 - 2** When your machine answers, immediately enter your Remote Access Code (3 digits followed by *).
 - 3** The machine signals if it has received fax messages:
 - 1 long beep — Fax messages**
 - No beeps — No messages**
 - 4** The machine gives two short beeps, which tells you to enter a command. The machine will hang up if you wait longer than 30 seconds to enter a command. The machine will beep three times, if you enter an invalid command.
 - 5** Press **90** to reset the machine when you've finished.
 - 6** Hang up.
-  If your machine is set to `Manual` mode and you want to use the remote retrieval features, you can access your machine by waiting about 2 minutes after it starts ringing, and then entering the Remote Access Code within 30 seconds.

Remote commands

Follow the commands below to access features when you are away from the machine. When you call the machine and enter your Remote Access Code (3 digits followed by *), the system will give two short beeps and you must enter a remote command.

Remote commands	Operation details
95 Change the Fax Forwarding settings	
1 OFF	If you hear one long beep, the change has been accepted. If you hear three short beeps, you cannot change it because the conditions have not been met. You can register your Fax Forwarding number by entering 4. (See <i>Changing your Fax Forwarding number</i> on page 8-6.) Once you have registered the number, Fax Forwarding will be set to On.
2 Fax Forwarding	
4 Fax Forwarding number	
6 Fax Storage ON	You can turn Fax Storage to On (or Off) after you have retrieved or erased all your messages).
7 Fax Storage OFF	
96 Retrieve a fax	
2 Retrieve all faxes	Enter the number of a remote fax machine to receive stored fax message(s). (See page 8-6.)
3 Erase faxes from the memory	If you hear one long beep, you can erase fax messages from the memory.
97 Check the receiving status	
1 Fax	You can check whether your machine has received any faxes. If yes, you will hear one long beep. If no, you will hear three short beeps.
98 Change the Receive Mode	
1 External TAD	If you hear one long beep, you can change the Receive Mode.
2 Fax/Tel	
3 Fax Only	
90 Exit	After a long beep, you can exit Remote Retrieval.

Retrieving fax messages

- 1 Dial your fax number.
 - 2 When your machine answers, immediately enter your Remote Access Code (3 digits followed by *). If you hear one long beep, you have messages.
 - 3 As soon as you hear two short beeps, use the dial pad to press **962**.
 - 4 Wait for the long beep, and then use the dial pad to enter the number of the remote fax machine where you want your fax messages sent to followed by ## (up to 20 digits).
-  You cannot use * and # as dial numbers. However, press # if you want to store a pause.
- 5 Hang up after you hear your machine beep. Your machine will call the other machine, which will then print your fax messages.

Changing your Fax Forwarding number

You can change the default setting of your fax forwarding number from another telephone or fax machine using Touch Tone.

- 1 Dial your fax number.
 - 2 When your machine answers, immediately enter your Remote Access Code (3 digits followed by *). If you hear one long beep, you have messages.
 - 3 When you hear two short beeps, use the dial pad to press **954**.
 - 4 Wait for the long beep, and then use the dial pad to enter the new number of the remote fax machine where you want your fax messages forwarded followed by ## (up to 20 digits).
-  You cannot use * and # as dial numbers. However, press # if you want to store a pause.
- 5 Hang up after you hear your machine beep.

9 Printing reports

Machine settings and activity

You need to set up the Transmission Verification Report and Journal Period in the menu table.

Press **Menu/Set, 2, 4, 1.**

1.XMIT Report

—OR—

Press **Menu/Set, 2, 4, 2.**

2.Journal Period

Customizing the Transmission Verification Report

You can use the Transmission Report as proof that you sent a fax. This report lists the time and date of transmission and whether the transmission was successful (OK). If you select **On** or **On+Image**, the report will print for every fax you send.

If you send a lot of faxes to the same place, you may need more than the job numbers to know which faxes you must send again. Selecting **On+Image** or **Off+Image** will print a section of the fax's first page on the report to help you remember.



When the Verification Report is turned **Off**, the Report will only print it there is a transmission error, and in the **RESULT** column it will show **NG**.

1 Press **Menu/Set, 2, 4, 1.**

1.XMIT Report

2 Press  or  to select **Off**, **Off+Image**, **On** or **On+Image**.

Press **Menu/Set.**



3 Press **Stop/Exit.**

Setting the Journal Period

You can set the machine to print a journal at specific intervals (every 50 faxes, 6, 12 or 24 hours, 2 or 7 days). If you set the interval to **Off**, you can print the report by following the Steps on the next page. The default setting is **Every 50 Faxes**.

1 Press **Menu/Set, 2, 4, 2**.

2. Journal Period

2 Press  or  to choose an interval.

Press **Menu/Set**.

(If you choose 7 days, the LCD will ask you to choose a day on which to begin the 7-day countdown.)

3 Enter the time to begin printing in 24-hour format.

Press **Menu/Set**.

(For example: enter 19:45 for 7:45 PM.)

4 Press **Stop/Exit**.



If you select 6, 12, 24 hours, 2 or 7 days, the machine will print the report at the selected time and then erase all jobs from its memory. If the machine's memory becomes full with 200 jobs before the time you selected has passed, the machine will print the Journal early and then erase all jobs from memory. If you want an extra report before it is due to print, you can print it without erasing the jobs from memory.





If you select **Every 50 Faxes**, the machine will print the Journal when the machine has stored 50 jobs.

Printing reports

- | | |
|---------------------------------------|---|
| 1.Help List | Prints the Help List so you can see at-a-glance how to quickly program your machine. |
| 2.Quick-Dial | Lists names and numbers stored in the Speed-Dial memory, in numerical order. |
| 3.Fax Journal | Lists information about the last incoming and outgoing faxes.
(TX means Transmit.) (RX means Receive.) |
| 4.XMIT Verify | Prints a Transmission Verification Report for your last transmission. |
| 5.User Settings | Lists your settings. |
| 6.Network Config
(MFC-3820CN only) | Lists your Network settings. |

To print a report



- 1** For MFC-3420C, press **Menu/Set**, **5**.
For MFC-3820CN, press **Menu/Set**, **7**.
- 2** Press  or  to select the report you want.
Press **Menu/Set**.
—OR—
Enter the number of the report you want to print.
For example, press **1** to print the Help List.
- 3** Press **Mono Start**.

10 Making copies

Using the machine as a copier

You can use your machine as a copier, making up to 99 copies at a time.

Enter Copy mode

Before making copies, make sure that  (**Copy**) is illuminated in green. If it is not, press  (**Copy**) to enter **Copy** mode. The default setting is Fax. You can change the number of seconds or minutes that the machine stays in Copy mode. (See *Setting the Mode Timer* on page 4-6.)

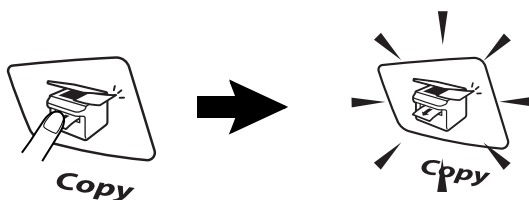

The LCD shows the default copy setting

100% Normal 01

Copy Ratio

Quality

No of Copies

Making a single copy

- 1 Press  (**Copy**) to illuminate it in green.
- 2 Load your document. (See *Load documents* on page 2-1.)
- 3 Press **Mono Start** or **Colour Start**.

 To stop copying, press **Stop/Exit**.

Making multiple copies

- 1 Press  (**Copy**) to illuminate it in green.
- 2 Load your document. (See *Load documents* on page 2-1.)
- 3 Use the dial pad to enter the number of copies you want (up to 99).
- 4 Press **Mono Start** or **Colour Start**.

 To sort the copies, press the **Options** key. (See *Using the Copy keys (Temporary settings)* on page 10-4.)

Out of Memory message

If the memory becomes full while you are making copies, the LCD message will guide you through the next step.

Out of Memory

If the `Out of Memory` message appears, press **Stop/Exit** to cancel or **Mono Start** or **Colour Start** to copy scanned pages. You will need to clear some jobs from the memory before you can continue.



To gain extra memory, you can turn off Fax Storage.
(See *Setting Fax Storage* on page 8-2.)

—OR—

Print the faxes that are in the memory.
(See *Printing a fax from the memory* on page 5-6.)

When you get an `Out of Memory` message, you may be able to make copies if you first print incoming faxes in the memory to restore the memory to 100%.

Using the Copy keys (Temporary settings)

When you want to change the settings only for the next copy, use the Temporary Copy keys. You can use different combinations.

These settings are temporary, and the machine returns to its default settings 60 seconds after it finishes copying. If you want to use these temporary settings again, place the next document in the ADF within that time. However, if you have set the Mode Timer for copy and Scan modes to 0 or 30 seconds, the machine returns to the default settings after the number of seconds that has been set for mode timer. (See *Setting the Mode Timer* on page 4-6.)





Enlarge/Reduce

You can select the following enlargement or reduction ratios.

Auto sets the machine to calculate the ratio that fits the size of your paper. **Custom** allows you to enter a ratio from 25% to 400%.

Press Enlarge/Reduce 	100%
	142% : A5→A4
	198% : 10X15cm→A4
	200%
	Custom (25-400%)
	97% : LTR→A4
	83% : LGL→A4
	69% : A4→A5
	50%

- 1 Press  (**Copy**) to illuminate it in green.
- 2 Load your document. (See *Load documents* on page 2-1.)
- 3 Use the dial pad to enter the number of copies you want (up to 99).
- 4 Press **Enlarge/Reduce**.
- 5 Press  or  to select the enlargement or reduction ratio you want.

Press **Menu/Set**.

—OR—

You can select **Custom** and press **Menu/Set**.

Use the dial pad to enter an enlargement or reduction ratio from 25% to 400%.

Press **Menu/Set**. (For example, press **5 3** to enter 53%.)

- 6 Press **Mono Start** or **Colour Start**.

—OR—



Press other temporary copy keys for more settings.





Special Copy Options (2in1, 4in1 or Poster) are not available with **Enlarge/Reduce**.

Quality





You can select the copy quality. The default setting is **Normal**.

 Quality and  or 	Normal	Recommended mode for ordinary printouts. Good copy quality with adequate copy speed.
	Fast	Fast copy speed and lowest ink consumption. Use FAST to save time (document to be proof-read, large documents or many copies).
	Best	Use this mode to copy precise images such as photographs. BEST uses the highest resolution and slowest speed.

- 1 Press  (**Copy**) to illuminate it in green.
- 2 Load your document. (See *Load documents* on page 2-1.)
- 3 Use the dial pad to enter the number of copies you want (up to 99).
- 4 Press **Quality**.
- 5 Press  or  to choose the copy quality (**Fast**, **Normal** or **Best**).
Press **Menu/Set**.
- 6 Press **Mono Start** or **Colour Start**.
—OR—
Press other Temporary Copy keys for more settings.

Options



Use the **Options** key to set the following copy settings only for the next copy.

Press Copy Options	Menu Selections	Options	Factory Setting	Page
 Options	 +  select	 +  select		
	Paper Type	Plain/Inkjet/ Glossy (4-Color or 3-Color)/ Transparency	Plain	10-8
	Paper Size	A4/A5/ 10 (W) X15 (H) cm	A4	10-9
	Brightness	- ■■■■ +	- ■■■■ +	10-10
	Contrast	- ■■■■ +	- ■■■■ +	10-11
	Stack/Sort	Stack/Sort	Stack	10-12
	Page Layout	Off (1 in 1)/ 2 in 1/4 in 1 (P)/ 4 in 1 (L)/ Poster (3 x 3)	Off (1 in 1)	10-13
No. of Copies	No. of Copies:01 (01-99)	01		

After you finish choosing settings using the **Options** key, the LCD shows **Press Start** and then returns to Menu selections.







Press **Mono Start** or **Colour Start** if you're finished choosing settings.

—OR—

Press  or  to select more settings.

Paper Type

You can change the paper type only for the next copy. Select the type of media that you are using to get the best print quality.

- 1 Press  (**Copy**) to illuminate it in green.
- 2 Load your document. (See *Load documents* on page 2-1.)
- 3 Use the dial pad to enter the number of copies you want (up to 99).
- 4 Press **Options** and  or  to select **Paper Type**.
Press **Menu/Set**.
- 5 Press  or  to select the type of paper you are using (Plain, Inkjet, Glossy or Transparency).
Press **Menu/Set**.
- 6 If you selected **Glossy**, press  or  to select **Glossy : 4-Color** or **Glossy : 3-Color**.
Press **Menu/Set**.

 The print quality of black ink depends on the type of glossy paper you are using. Black ink is used when you select **Glossy : 4-Color**. If the glossy paper you are using repels the black ink, select **Glossy : 3-Color**, which simulates black ink by combining the three ink colours.

- 7 Press **Colour Start** or **Mono Start**.

—OR—

Press  or  for more settings.







 You can change the default Paper Type setting at any time. (See *Setting the Paper Type* on page 4-7.)

Paper Size

You can change the paper size setting only for the next copy.











You can copy only on, A4, A5 and Photo Card (10(W)X15(H)cm) paper.

- 1 Press  (**Copy**) to illuminate it in green.
- 2 Load your document. (See *Load documents* on page 2-1.)
- 3 Use the dial pad to enter the number of copies you want (up to 99).
- 4 Press **Options** and  or  to select Paper Size.
Press **Menu/Set**.
- 5 Press  or  to select the size of paper you are using (A4, A5 or 10 (W) X15 (H) cm).
Press **Menu/Set**.
- 6 Press **Mono Start** or **Colour Start**.
—OR—
Press  or  for more settings.









Brightness

You can adjust the copy brightness to make copies darker or lighter.

- 1 Press  (**Copy**) to illuminate it in green.
- 2 Load your document. (See *Load documents* on page 2-1.)
- 3 Use the dial pad to enter the number of copies you want (up to 99).
- 4 Press **Options** and  or  to select *Brightness*.
Press **Menu/Set**.

- 5 Press  to make a lighter copy.
—OR—
Press  to make a darker copy.
Press **Menu/Set**.
- 6 Press **Mono Start** or **Colour Start**.
—OR—
Press  or  for more settings.







Contrast

You can adjust the copy contrast to help an image look sharper and more vivid.

- 1 Press  (**Copy**) to illuminate it in green.
- 2 Load your document. (See *Load documents* on page 2-1.)
- 3 Use the dial pad to enter the number of copies you want (up to 99).
- 4 Press **Options** and  or  to select **Contrast**.
Press **Menu/Set**.

- 5 Press  to increase the contrast.
—OR—
Press  to decrease the contrast. Press **Menu/Set**.
- 6 Press **Mono Start** or **Colour Start**.
—OR—
Press  or  for more settings.





Sorting copies using the ADF

You can sort multiple copies. Pages will be stacked in the order 123, 123, 123, and so on.

- 1** Press  (**Copy**) to illuminate it in green.
- 2** Load your document. (See *Load documents* on page 2-1.)
- 3** Use the dial pad to enter the number of copies you want (up to 99).
- 4** Press **Options** and  or  to select **Stack/Sort**.
Press **Menu/Set**.
- 5** Press  or  to select **Sort**.
Press **Menu/Set**.
- 6** Press **Mono Start** or **Colour Start**.
—OR—
Press  or  for more settings.

N in 1 copy (Page Layout)

You can save paper by copying either two or four pages onto one page. If you want to print a poster, use the scanner glass.

- 1 Press  (**Copy**) to illuminate it in green.
- 2 Load your document. (See *Load documents* on page 2-1.)
- 3 Use the dial pad to enter the number of copies you want (up to 99).
- 4 Press **Options** and  or  to select **Page Layout**. Press **Menu/Set**.
- 5 Press  or  to select **2 in 1**, **4 in 1 (P)**, **4 in 1 (L)**, **Poster (3 x 3)** (or **Off (1 in 1)**). Press **Menu/Set**.
- 6 Press **Mono Start** or **Colour Start** to scan the document.
If you placed the document in the ADF, the machine starts printing.

If you are using the scanner glass:

- 7 After the machine scans the page, the LCD shows;
Press **1** to scan next page.
- 8 Put the next document on the scanner glass.
Press **Menu/Set**.

Repeat Steps 7 and 8 for each page of the layout.
- 9 After all the pages of the document have been scanned, press **2** to end.

 (P) means Portrait and (L) means Landscape.

 For 2 in 1 or 4 in 1 copies, you can only use A4 paper.

 For 2 in 1, 4 in 1 (P), 4 in 1 (L) or Poster (3 x 3), you can not use the Enlarge/Reduce setting.

 If you selected **Glossy** in the Paper Type setting, 2 in 1 and 4 in 1 copies are not available.

 2 in 1 or 4 in 1 copies in colour are not available with Multiple Copies.

2 in 1



4 in 1 (P)

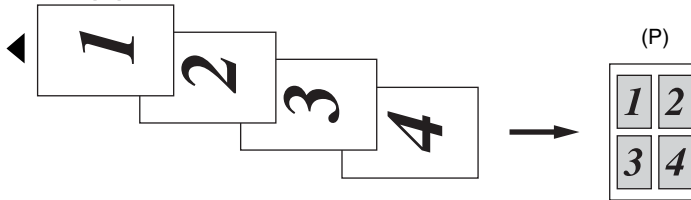

4 in 1 (L)

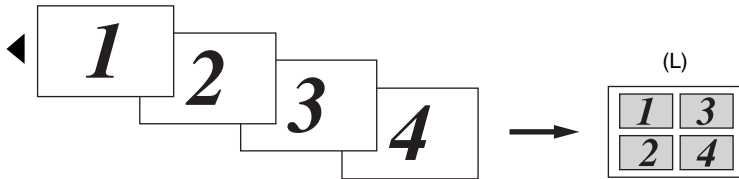

Poster (3X3)

You can make a poster size copy of a photograph.

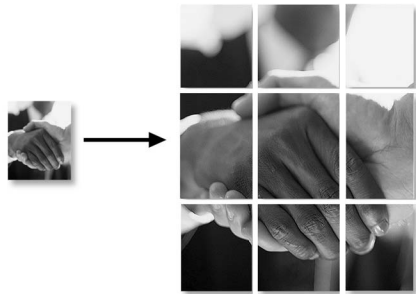



For Poster copies, you cannot make more than one copy.

Changing the default copy settings



You can change the default copy settings. These settings will stay until you change them again.

Copy Quality

- 1 Press **Menu/Set**, **3**, **1**.
- 2 Press  or  to select Normal, Best or Fast.
Press **Menu/Set**.
- 3 Press **Stop/Exit**.

1.Quality



Brightness

- 1 Press **Menu/Set**, **3**, **2**.
- 2 Press  to make a lighter copy.
—OR—
Press  to make a darker copy.
Press **Menu/Set**.
- 3 Press **Stop/Exit**.

2.Brightness

Contrast

You can change the contrast to help an image look sharper and more vivid.

- 1 Press **Menu/Set**, **3**, **3**.
- 2 Press  to increase the contrast.
—OR—
Press  to decrease the contrast.
Press **Menu/Set**.
- 3 Press **Stop/Exit**.

3.Contrast

Colour Adjustment

1 Press **Menu/Set**, **3**, **4**.

4.Color Adjust

2 Press  or  to select Red, Green or Blue.

Press **Menu/Set**.

3 Press  to increase the colour saturation.

—OR—

Press  to decrease the colour saturation.

Press **Menu/Set**.

4 Return to Step 2 to select the next colour.

—OR—

Press **Stop/Exit**.

Legal limitations

Colour reproductions of certain documents are illegal and may result in either criminal or civil liability. This memorandum is intended to be a guide rather than a complete listing of every possible prohibition. In case of doubt, we suggest that you check with relevant authorities as to any particular questionable documents.

The following are examples of documents which should not be copied:

- Paper money
- Bonds or other certificates of indebtedness
- Certificates of Deposit
- Armed Forces Service or Draft papers.
- Passports
- Postage Stamps (cancelled or uncanceled)
- Immigration Papers
- Welfare documents
- Cheques or Drafts drawn by Governmental Agencies
- Identification Documents, badges or insignias
- Licences and Certificates of Title to motor vehicles

Copyrighted works cannot be copied. Sections of a copyrighted work can be copied for 'fair use'. Multiple copies would indicate improper use.

Works of art should be considered the equivalent of copyrighted works.

11 Walk-Up PhotoCapture Center™ (MFC-3820CN only)

Introduction

Your Brother machine includes four media drives (slots) for use with popular digital camera media: CompactFlash®, SmartMedia®, Memory Stick® and SD (Secure Digital) Memory card.



CompactFlash®



SmartMedia®



Memory Stick®



SD Card

The PhotoCapture Center™ feature lets you print digital photos from your digital camera at high resolution to get photo quality printing.

PhotoCapture Center™ requirements

To avoid error conditions, please remember:

- The DPOF file on the media card must be in a valid format.
- The image file extension must be .JPG (Other image file extensions .JPEG, .TIF, .GIF and so on will not be recognized).
- Walk-up PhotoCapture Center™ printing must be performed separately from PhotoCapture Center™ operations using the PC. (Simultaneous operation is not available.)
- IBM Microdrive™ is not compatible with the machine.
- The machine can read up to 999 files in a media card.
- Use only Smart media cards with a 3.3v voltage rating.



When printing the INDEX or IMAGE, the PhotoCapture Center™ will print all the valid images, even if one or more images have been corrupted. A portion of the corrupted image may be printed.

Basic flow



Even if your machine is not connected to your computer, you can print photos directly from the digital camera media. This is the basic flow of the direct printing operation. For more detail information, please read this chapter from the next page.

1 Insert the media card firmly into the media drive (slot).
PhotoCapture key lights. (See *Getting started* on page 11-3.)

2 Press **PhotoCapture**.



If your digital camera supports DPOF printing, see *DPOF printing* on page 11-8.

3 Print the index which shows thumbnails views of photos stored on your media card. Even if the machine is not connected to the computer, you can know the individual image number on the media card.

Press  or  to select `Print Index` and then press **Menu/Set**.

Press **Colour Start** to start printing index sheet.

(See *Printing the Index (Thumbnails)* on page 11-5.)

4 To print the images, press  or  to select `Print Images` and then press **Menu/Set**.

Enter image number and press **Menu/Set**.

Press **Colour Start** to start printing.

(See *Printing images* on page 11-6.)

You can change the settings for printing images, such as the number of Copies, Paper Type, Paper & Print Size, Print Quality, Brightness and Colour Enhance. (See *Changing the default settings* on page 11-9.)

Getting started

-  There are separate slots on your machine, for a CompactFlash[®] card, a SmartMedia[®] card, Memory Stick[®] and SD Card. Use only Smart media cards with a 3.3v voltage rating.

Firmly insert the card into the appropriate slot.

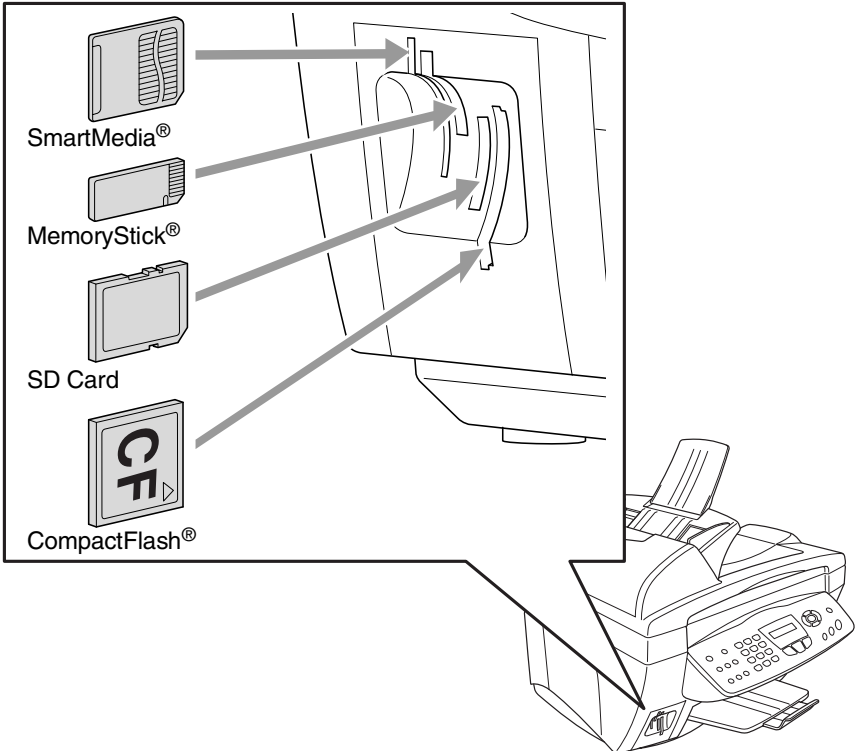

PhotoCapture key Lights:

- **PhotoCapture** light is ON, the media card is inserted properly.
- **PhotoCapture** light is OFF, the media card is not properly inserted.
- **PhotoCapture** light is BLINKING, the media card is being read or written to.



⚠ Do NOT unplug the power cord or remove the media card from the media drive (slot) while the machine is reading or writing to the card (the **PhotoCapture** key is blinking). **You will lose your data or damage the card.**

The machine can only read one Media card at a time so do not insert more than one card. The settings that you want to use with the card will be kept until you take out the media card from the drive (slot), print images or press **Stop/Exit**.

1 Insert the media card firmly into the media drive (slot).

2 When you insert your media card into the proper slot, the LCD shows.

C.Flash Active

Press PhotoCapture key...



The media active message will be shown for 60 seconds and then disappear. Even in that case, you can enter the PhotoCapture mode by pressing **PhotoCapture**.

3 Press **PhotoCapture**.

The LCD shows:

Photo:Select ▲▼



Print Index ▲▼



Select

Print Images ▲▼

(See *Printing the Index (Thumbnails)* on page 11-5.)

(See *Printing images* on page 11-6.)

Printing the Index (Thumbnails)

The PhotoCapture Center™ assigns numbers for images (such as No.1, No.2, No.3, and so on).



→ [No. 1]
DEI.JPG

01.01.2003
100KB



It does not recognize any other numbers or file names that your digital camera or PC have used to identify the pictures. You can print a thumbnail page (Index page with 6 or 4 images per line). This will show all the pictures on the media card.

1 Make sure you inserted the media card.
Press **PhotoCapture**. (See page 11-3.)

2 Press  or  to select
Print Index.

Print Index ▾

Press **Menu/Set**.

3 Press  or  to select
6 Images/Line or
4 Images/Line.

6 Images/Line ▾

Press **Menu/Set**.



Index

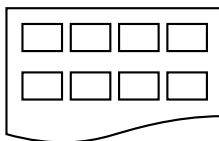

4 Images/Line

Index

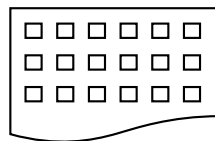

6 Images/Line

4 Press **Colour Start** to start printing.



Print time for 4 Images/Line will be slower than 6 Images/Line, but the quality is better. To print an image, see the next page.

Printing images

Before you can print an individual image, you have to know the image number.



Print the Index first.

(See *Printing the Index (Thumbnails)* on page 11-5.)

1

Make sure you inserted the media card.

Press **PhotoCapture**. (See page 11-3.)

2

Press  or  to choose

Print Images 

Print Images.

Press **Menu/Set**.



If your media card is with DPOF information, the LCD shows
DPOF Print:Yes, please go to *DPOF printing* on page 11-8.

3

Use the dial pad to enter the image number that you want to be printed from the Index page (Thumbnails).

No. :1, 3, 6

Press **Menu/Set**.

Repeat this step until you have entered all the image numbers that you want to print.



You can enter all the numbers at one time by using the ***** key for a comma or the **#** key for hyphen.

(For example, Enter **1 * 3 * 6** - to print images No.1, No.3 and No.6. Enter **1#5** to print images No.1 to No.5).

4



After you have selected all the image numbers.

Press **Menu/Set** again, and go to Step 5.

—OR—

To print without changing any settings, press **Colour Start**.

Paper Type & Paper Size

- 5** Press  or  to select the type of paper you are using, (10x15cm Glossy, 13x18cm Glossy, A4 Glossy, A4 Plain, 10x15cm Inkjet or A4 Inkjet).

Press **Menu/Set**.



If you selected A4, go to Step 6.

If you selected another size, go to Step 7.

—OR—

To print without changing settings, press **Colour Start**.

Print Size





- 6** If you selected A4, press  or  to select the print size (10X8cm, 13X9cm, 15X10cm, 18X13cm or 20X15cm).

Press **Menu/Set**, and go to Step 7.

—OR—

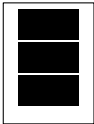
To print without changing settings, press **Colour Start**.

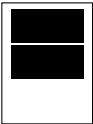
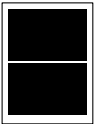
Printed Position

① 10X8cm	② 13X9cm	③ 15X10cm	④ 18X13cm	⑤ 20X15cm
				

Number of Copies

- 7** Use the dial pad to enter the number of copies you want.

Press **Menu/Set**.

- 8** Press **Colour Start** to print.

DPOF printing

DPOF stands for Digital Print Order Format.

Major Digital Camera manufacturers (Canon Inc., Eastman Kodak Company, Fuji Photo Film Co. Ltd., Matsushita Electric Industrial Co. Ltd. and Sony Corporation.) created this standard to make it easier to print images from a digital camera.

If your digital camera supports DPOF printing, you will be able to select on the Digital Camera display the images and number of copies you want to print.

When the memory card (CompactFlash®, SmartMedia®, Memory Stick® or SecureDigital) with DPOF information is put into your machine, you can print the selected image easily.



- 1 Insert your media card into the proper drive (slot).

C.Flash Active



The media active message will be shown for 60 seconds and then disappear. Even in that case, you can enter the PhotoCapture mode by pressing **PhotoCapture**.



- 2 Press **PhotoCapture**.

- 3 Press  or  to select **Print Images** to select individual images.

Press **Menu/Set**.

- 4 If there is a DPOF file on the card, the LCD shows:

DPOF Print:Yes ◆

- 5 Press  or  to select DPOF Print:Yes.

DPOF Print:No ◆

Press **Menu/Set**.



If you want to print an Index (thumbnails) or choose the images and their print options now, select **DPOF Print:No**.

- 6 Press **Colour Start** to print.

Changing the default settings

You can adjust the Print Quality, Paper & Print Size, Brightness, Contrast, Colour Enhance and Cropping settings, that are shown in the chart. These settings will remain set until you change them again.

Press **Menu/Set, 4**, followed by the number of the setting you want to change. (See details on the following pages.)

Print Quality

1 Press **Menu/Set, 4, 1**.

1.Print Quality

2 Press  or  to select Normal, Fine or Photo.

Press **Menu/Set**.

3 Press **Stop/Exit**.

Paper & Size



1 Press **Menu/Set, 4, 2**.

2.Paper & Size

2 Press  or  to select

10x15cm Glossy, 13x18cm Glossy, A4 Glossy, A4 Plain, 10x15cm Inkjet or A4 Inkjet.



Press **Menu/Set**.

3 If you selected A4, press  or  to select the print size (10X8cm, 13X9cm, 15X10cm, 18X13cm or 20X15cm).

Press **Menu/Set**.

4 Press **Stop/Exit**.



Brightness

- 1 Press **Menu/Set, 4, 3.**
- 2 Press  to make a lighter print.
—OR—
Press  to make a darker print.
Press **Menu/Set.**
- 3 Press **Stop/Exit.**

3.Brightness

Contrast

You can choose the contrast setting. More Contrast will make an image look sharper and more vivid.

- 1 Press **Menu/Set, 4, 4.**
- 2 Press  to increase the contrast.
—OR—
Press  to decrease the contrast.
Press **Menu/Set.**
- 3 Press **Stop/Exit.**

4.Contrast

Colour enhancement

You can turn on the colour enhancement feature to print more vivid images.

1 Press **Menu/Set**, **4**, **5**.

5.Color Enhance

2 Press  or  to select **On** (or **Off**).

Press **Menu/Set**.

 If you select **On**, you can customize the **White Balance**, **Sharpness** or **Colour Density**.



3 If you selected **On**,



Press  or  to select **White Balance**.

Press **Menu/Set**.

—OR—

To skip the **White Balance**.

Press  or  to select **Sharpness** or **Color Density**.

4 Press  or  to adjust the degree of **White Balance**.

Press **Menu/Set**.

5 Repeat Step 4 and Step 5 to adjust the degree of **Sharpness** and **Colour Density**.

—OR—

Press **Stop/Exit**.

■ **White Balance**

This setting adjusts the hue of the white areas of an image. Lighting, Camera settings and other influences will effect the appearance of white. The white areas of a picture may be slightly pink, yellow or some other colour. By using this adjustment you can correct this effect and bring the white areas back to pure white.

■ **Sharpness**

This setting enhances the detail of an image. It is similar to adjusting the fine focus on a camera. If the image is not in true focus and you cannot see the fine details of the picture, then adjust the sharpness.



■ **Colour Density**

This setting adjusts the total amount of colour in the image. You can increase or decrease the amount of colour in an image to improve a washed out or weak picture.

Cropping

If your photo is too long or wide to fit the available space on your selected layout, part of the image will be automatically cropped.

The default setting is **On**. If you want to print whole image, turn this setting to **Off**.

- 1** Press **Menu/Set, 4, 6**.
- 2** Press  or  to select **Off** (or **On**).
Press **Menu/Set**.
- 3** Press **Stop/Exit**.

Cropping:On

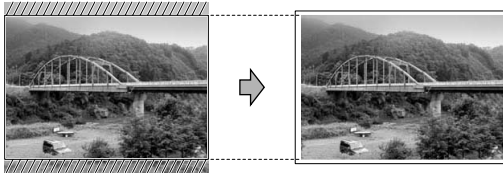

Cropping:Off

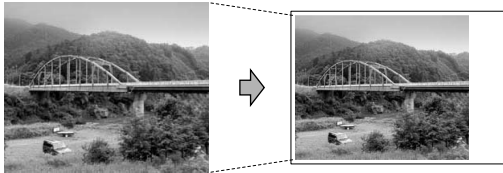

Understanding the Error Messages

Once you are familiar with the types of errors that can occur while you're using the PhotoCapture Center™, you can easily identify and troubleshoot any difficulties.

When an error message appears on the LCD, the machine will beep to get your attention.

Media Error—This message will appear if you insert a media card that is either bad or not formatted, or when there is a problem with the media drive. To clear this error, take out the media card.

No File—This message will appear if you try to access the media card in the drive (slot) does not contain a .JPG file.

Out of Memory—This message will appear if you are working with images that are too large for the machine's memory.

Unsupported Card—This message will appear if you insert a media card that is not supported.

Using PhotoCapture Center™ from your PC

You can access the media card that is in the media drive (slot) of the machine from your PC.

See Using PhotoCapture Center™ from your PC. (See *Using the PhotoCapture Center™ from your PC* on page 7-1 in Software User's Guide on the CD-ROM or *Using the PhotoCapture Center™ from a Macintosh® (MFC-3320CN and MFC-3820CN only)* on page 9-24 in the Software User's Guide on the CD-ROM.)

Using PhotoCapture Center™ for scanning documents

You can scan the documents into a media card. (See *Scan to Card (MFC-3320CN and MFC-3820CN only)* on page 2-22 in Software User's Guide on the CD-ROM.)

12 Important information

For your safety

To ensure safe operation the three-pin plug supplied must be inserted only into a standard three-pin power point which is effectively grounded through the normal household wiring.

The fact that the equipment operates satisfactorily does not imply that the power is grounded and that the installation is completely safe. For your safety, if in any doubt about the effective grounding of the power, consult a qualified electrician.

IT power system (For Norway only)

This product is also designed for IT power system with phase to phase voltage 230V.

LAN connection

Caution

Do not connect this product to a LAN connection that is subject to over-voltages.

International ENERGY STAR[®] Compliance Statement

The purpose of the International ENERGY STAR[®] Program is to promote the development and popularization of energy-efficient office equipment.

As an ENERGY STAR[®] Partner, Brother Industries, Ltd. has determined that this product meets the ENERGY STAR[®] guidelines for energy efficiency.



Important safety instructions

- 1** Read all of these instructions.
- 2** Save them for later reference.
- 3** Follow all warnings and instructions marked on the product.
- 4** Unplug this product from the wall socket before cleaning. Do not use liquid or aerosol cleaners. Use a damp cloth for cleaning.
- 5** Do not use this product near water.
- 6** Do not place this product on an unstable cart, stand, or table. The product may fall, causing serious damage to the product.
- 7** Slots and openings in the cabinet and the back or bottom are provided for ventilation; to ensure reliable operation of the product and to protect it from overheating, these openings must not be blocked or covered. The openings should never be blocked by placing the product on a bed, sofa, rug, or other similar surface. This product should never be placed near or over a radiator or heater. This product should never be placed in a built-in installation unless proper ventilation is provided.
- 8** This product should be operated from the type of power source indicated on the label. If you are not sure of the type of power available, call your dealer or local power company.
Use only the power cord supplied with this machine.
- 9** This product is equipped with a 3-wire grounded plug, a plug having a third (grounded) pin. This plug will only fit into a grounded power outlet. This is a safety feature. If you are unable to insert the plug into the outlet, call your electrician to replace your obsolete outlet. Do not defeat the purpose of the grounded plug.
- 10** Do not allow anything to rest on the power cord. Do not place this product where people can walk on the cord.

- 11** Do not place anything in front of the machine that will block received faxes. Do not place anything in the path of received faxes.
- 12** Wait until pages have exited the machine before picking them up.
- 13** Unplug this product from the wall outlet and refer servicing to Authorized Service Personnel under the following conditions:
 - When the power cord is damaged or frayed.
 - If liquid has been spilled into the product.
 - If the product has been exposed to rain or water.
 - If the product does not operate normally when the operating instructions are followed. Adjust only those controls that are covered by the operating instructions. Improper adjustment of other controls may result in damage and will often require extensive work by a qualified technician to restore the product to normal operation.
 - If the product has been dropped or the cabinet has been damaged.
 - If the product exhibits a distinct change in performance, indicating a need for service.
- 14** To protect your product against power surges, we recommend the use of a power protection device (Surge Protector).

Trademarks

The Brother logo is a registered trademark of Brother Industries, Ltd.

Brother is a registered trademark of Brother Industries, Ltd.

Multi-Function Link is a registered trademark of Brother International Corporation.

© Copyright 2003 Brother Industries, Ltd. All rights reserved.

Windows and Microsoft are registered trademarks of Microsoft in the U.S. and other countries.

Macintosh is a registered trademark of Apple Computer, Inc.

PaperPort and TextBridge are registered trademarks of ScanSoft, Inc.

Presto! PageManager is a registered trademark of NewSoft Technology Corporation.

Microdrive is a trademark of International Business Machine Corporation.

SmartMedia is a registered trademark of Toshiba Corporation.

CompactFlash is a registered trademark of ScanDisk Corporation.

Memory Stick is a registered trademark of Sony Corporation.

MagicGate is a trademark of Sony Corporation.

Each company whose software title is mentioned in this manual has a Software License Agreement specific to its proprietary programs.

All other brand and product names mentioned in this User's Guide, the Software User's Guide, and the Network User's Guide (MFC-3820CN only) are registered trademarks of their respective companies.

13 Troubleshooting and routine maintenance

Troubleshooting

Error messages

As with any sophisticated office product, errors may occur. If this happens, your machine identifies the problem and displays an error message. The most common error messages are shown below.

ERROR MESSAGES		
ERROR MESSAGE	CAUSE	ACTION
BT Callsign On	The machine is set BT Callsign to ON. You cannot change the Receive Mode from Manual to another mode.	Set BT Callsign to OFF. (See <i>BT Callsign (For U.K. Only)</i> on page 5-13.)
Check Cartridge	An ink cartridge is not properly installed.	Take out the ink cartridge and put it in again seating it properly. (See <i>Replacing the ink cartridges</i> on page 13-21.)
Check Original	The document scanned from ADF was longer than about 90cm.	See <i>Using the automatic document feeder (ADF)</i> on page 2-1 or <i>Document jams</i> on page 13-4.
Check Paper Size	Paper is not the correct size.	Reload the correct size of paper (A4), and then press Mono Start or Colour Start .
Check Paper	The machine is out of paper.	Add paper, and then press Mono Start or Colour Start .
	The paper is jammed in the machine.	See <i>Printer jam or paper jam</i> on page 13-5.
Comm. Error	Poor phone line quality caused a communication error.	Try the call again. If the problem continues, call the telephone company and ask them to check your phone line.
Connection Fail	You tried to poll a fax machine that is not in Polled Waiting mode.	Check the other fax machine's polling setup.

ERROR MESSAGES		
ERROR MESSAGE	CAUSE	ACTION
Cover Open	The scanner cover is not closed completely.	Lift the scanner cover and then close it again.
Disconnected	The other person or other person's fax machine stopped the call.	Try to send or receive again.
Data Remains	Print data remains in the machine's memory.	Re-start printing from your computer.
	Print data remains in the machine's memory. The USB cable was unplugged while the computer was sending the data to the machine.	Press Stop/Exit . The machine will cancel the job and eject the page that is being printed.
High Temperature	The print heads are too warm.	Allow the machine to cool down.
Ink Empty	One or more of the ink cartridges is empty. The machine will stop all print operations. While memory is available, black and white faxes will be received into memory. If a sending machine has a colour fax, the machine's 'handshake' will request that the fax be sent as black and white. If the sending machine has the ability to convert it, the colour fax will be received into memory as a black and white fax.	Replace the ink cartridges. (See <i>Replacing the ink cartridges</i> on page 13-21.)
Low Temperature	The print heads are too cold.	Allow the machine to warm up.
Machine Error XX	The machine has a mechanical problem.	Call Brother Customer Service.
Media Error (MFC-3820CN)	The media card is either bad or not formatted.	Reinsert the correct media card.
Near Empty	One or more of the ink cartridges are running out of ink. If a sending machine has a colour fax, the machine's 'handshake' will request that the fax be sent as black and white. If the sending machine has the ability to convert it, the colour fax will be received into memory as a black and white fax.	Order a new ink cartridge.
No File (MFC-3820CN only)	The media card in the media drive does not contain a .JPG file.	Reinsert the correct media card.
No Response/Busy	The number you dialled does not answer or is busy.	Verify the number and try again.
Not Registered	You tried to access a Speed Dial number that is not programmed.	Set up the Speed Dial number. (See <i>Storing Speed-Dial numbers</i> on page 7-1.)

ERROR MESSAGES		
ERROR MESSAGE	CAUSE	ACTION
Out of Memory (May occur when the machine's used as a printer)	You can't store data in the memory.	(Fax sending or copy operation in process) Press Stop/Exit and wait until the other operations in progress finish and then try again. —OR— Clear the data in the memory. (See <i>Out of Memory message</i> on page 10-3.) (Printing operation in process) Reduce print resolution.
Paper Jam	The paper is jammed in the machine.	(See <i>Printer jam or paper jam</i> on page 13-5.)
Unsupported Card (MFC-3820CN only)	You inserted a media card that can not be used.	Reinsert the correct media card.

Document jams

If the document is jammed, follow the steps below.

Document is jammed in the top of the ADF unit.

- 1 Take out any paper from the ADF that is not jammed.
- 2 Lift the ADF cover.
- 3 Pull the jammed document out to the right.

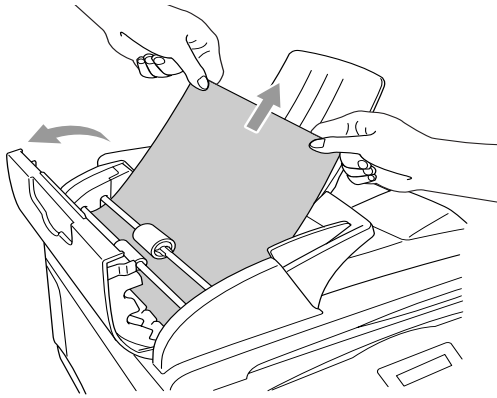

- 4 Close the ADF cover.
- 5 Press **Stop/Exit**.

Document is jammed inside the ADF unit.

- 1 Take out any paper from the ADF that is not jammed.
- 2 Lift the document cover.
- 3 Pull the jammed document out to the right.

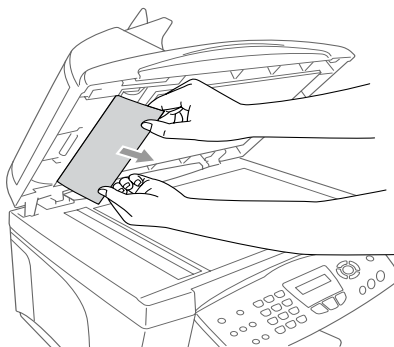

- 4 Close the document cover. Press **Stop/Exit**.

Printer jam or paper jam

Remove the jammed paper depending on where it is jammed in the machine.

Paper is jammed inside the front of the machine.

Pull the jammed paper toward you.



Paper is jammed in the paper tray.

- 1** Remove any paper from the paper tray that is not jammed.

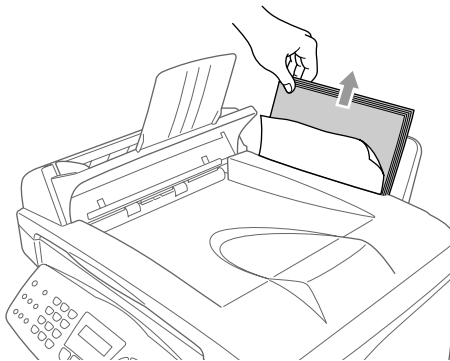

2 Pull up the jammed paper to remove it.

 If you have difficulty removing the jammed paper, press and hold the paper release lever as you pull out the page.

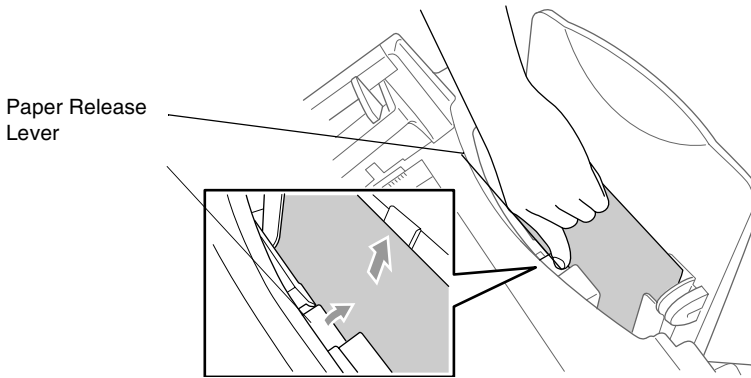

Paper is jammed inside the paper tray

1 Pull the paper tray out of the machine.

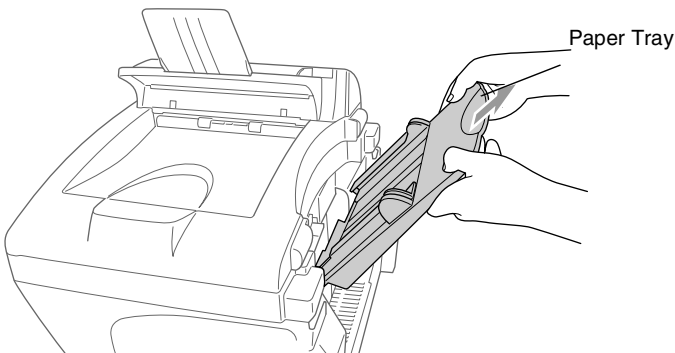

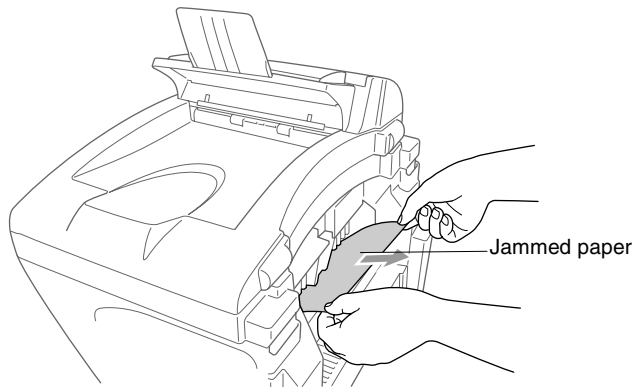

- 2 Pull up the jammed paper to remove it.

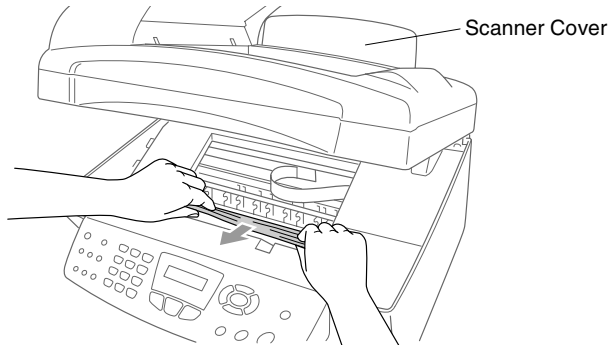

Paper is jammed inside the machine.

- 1 Open the scanner cover by lifting the scanner cover.
- 2 Remove the jammed paper.



 If the jammed paper is under the print heads, unplug the machine, and then you can move the print heads to take out the paper.

- 3 Close the scanner cover.

If you are having difficulty with your machine

If you think there is a problem with your machine or the way your faxes look, *make a copy first*. If the copy looks good, the problem is probably not your machine. Check the chart below and follow the troubleshooting tips.

DIFFICULTY	SUGGESTIONS
Printing or Receiving Faxes	
Condensed print and white streaks across the page or the top and bottom of sentences are cut off.	This can be caused by static or interference on the telephone line. You can make a copy using the Mono Start key to see if the same problem occurs. If the copy is also bad, call your Brother dealer for service.
Poor quality print.	Make sure the Printer Driver or Paper Type setting in the menu matches the type of paper you are using. (See <i>Media Type</i> on page 1-6 in Software User's Guide on the CD-ROM and <i>Setting the Paper Type</i> on page 4-7.) If you are using plain paper, try using the types of recommended paper. (See <i>About paper</i> on page 2-4.) Don't handle the paper until the ink is dry. Adjust the Vertical Alignment. (See <i>Print quality check</i> on page 13-12.)
Smudged stain at the top center of the printed page.	Make sure the paper is not too thick or not curled. (See <i>About paper</i> on page 2-4.)
Printing is too dark or too light.	Make sure your ink cartridges are fresh. Cartridges are good for up to two years, after that the ink may become clogged. Cartridge expiration dates are printed on the package. Make sure the Printer Driver matches the type of paper you are using. (See <i>Media Type</i> on page 1-6 in Software User's Guide on the CD-ROM.) Try using the recommended types of paper. (See <i>About paper</i> on page 2-4.) The recommended environment for your machine is between 20°C to 33°C.
Printing appears dirty or ink seems to run.	Make sure you are using the proper types of paper. (See <i>About paper</i> on page 2-4.) Don't handle the paper until the ink is dry. The recommended environment for your machine is between 20°C to 33°C.
White horizontal lines appear in text or graphics.	Clean the print heads. (See <i>Cleaning the print head</i> on page 13-12.)
Stains appear on the reverse side or at the bottom of the page	Make sure the Printer Platen is not dirty with ink. (See <i>Cleaning the machine printer platen</i> on page 13-20.)
Vertical black lines when receiving.	The sender's scanner may be dirty. Ask the sender to make a copy to see if the problem is on with the sending machine. Try receiving from another fax machine. If the copy is also bad, call your Brother dealer for service.
Received colour fax prints only in black and white.	Replace the colour ink cartridges that are empty or nearly empty, and then ask the other person to send the colour fax again. (See <i>Replacing the ink cartridges</i> on page 13-21.) Check that Fax Storage is set to OFF. (See <i>Setting Fax Storage</i> on page 8-2.)
Left and Right margins are cut off or a single page is printed on two pages.	Turn on Auto Reduction. (See <i>Printing a reduced incoming fax (Auto Reduction)</i> on page 5-6.)

DIFFICULTY	SUGGESTIONS
Phone Line or Connections	
The machine does not answer when called.	Make sure the machine is in the correct receiving mode for your setup. (See <i>Basic receiving operations</i> on page 5-1.) Check for a dial tone. If possible, call your machine to hear it answer. If there is still no answer, check the telephone line cord connection. If there is no ringing when you call your machine, ask your telephone company to check the line.
Sending Faxes	
Poor sending quality.	Try changing your resolution to <i>Fine</i> or <i>S. Fine</i> . Make a copy to check your machine's scanner operation.
Transmission Verification Report says 'Result:NG' or 'Result:ERROR'.	There is probably temporary noise or static on the line. Try sending the fax again. If you send a PC FAX message and get 'Result:NG' or, on the Transmission Verification Report, your machine may be out of memory. To gain extra memory, you can turn off Fax Storage (see <i>Setting Fax Storage</i> on page 8-2), print fax messages in memory (see <i>Printing a fax from the memory</i> on page 5-6) or cancel a Delayed Fax or Polling Job (See <i>Cancelling a scheduled job</i> on page 6-11.) If the problem continues, ask the telephone company to check your phone line.
Vertical black lines when sending.	If the copy you made shows the same problem, your scanner is dirty. (See <i>Cleaning the scanner</i> on page 13-19.)
Handling Incoming Calls	
machine 'Hears' Voice as CNG Tone.	If your machine is set to Fax Detect ON, it is more sensitive to sounds. Your machine may mistakenly interpret certain voices or music on the line as a calling fax machine and respond with fax receiving tones. Deactivate the fax by pressing Stop/Exit . Try avoiding this problem by turning Fax Detect to OFF. (See <i>Fax Detect</i> on page 5-5.)
Sending a Fax Call to the machine.	If you answered at the machine, press Mono Start and hang up immediately. If you answered on an extension phone, press your Fax Receive Code (default setting is \times 51). When your machine answers, hang up.
Custom features on a single line.	If you have Call Waiting, Call Waiting/Caller ID, Ring Master, Voice Mail, an alarm system or any other custom feature on a single phone line with your machine, it may create a problem sending or receiving fax data. For example: If you are sending or receiving a fax message while a custom feature signal comes through on the line, the signal can temporarily interrupt or disrupt the fax data. Brother's ECM feature should help overcome this problem. This condition is related to the telephone system industry and is common to all devices that send and receive data on a single, shared line with custom features. If avoiding a slight interruption is crucial to your business, we recommend a separate phone line with no custom features.

DIFFICULTY	SUGGESTIONS
Printer Difficulties	
Horizontal lines appear in text or graphics.	Clean the print head. (See <i>Cleaning the print head</i> on page 13-12.) If you clean the print heads five times and the print has not improved, call Brother or your dealer for service.
Scanning Difficulties	
TWAIN errors appear while scanning.	Make sure the Brother TWAIN driver is selected as the primary source. In PaperPort, click Scan in the File menu and select the Brother TWAIN driver.
Software Difficulties	
Cannot perform '2 in 1 or 4 in 1' printing.	Check that the paper size setting in the application and in the printer driver are the same.
Cannot print when using Paint Brush.	Try setting the Display setting to '256 colours.'
Cannot print when using Adobe Illustrator.	Try to reduce the print resolution.
Thick lines and thin lines appear alternately. (banding)	<ol style="list-style-type: none"> 1. Open the 'Basic' tab in the printer driver. 2. Click 'Setting' in the Basic tab of the printer driver. 3. Turn OFF 'Bi-Directional Printing' by un-checking it. (See <i>Bi-Directional Printing</i> on page 1-7 in Software User's Guide on the CD-ROM.)
There are some dense lines.	Check 'Reverse Order' in the Basic tab of the printer driver.
Printing is slow.	In the 'Colour' tab from the 'Advanced' tab in the printer driver, uncheck the Colour Enhancement.
Colour Enhancement is not working properly.	If the image data is not full colour in your application (Such as 256 colour), Colour Enhancement will not work. Please use at least 24 bit colour data with the Colour Enhancement feature.
'MFC is Busy' or 'MFC Connect Failure' Error Message appears.	Make sure the machine is not showing an error message on the LCD.
'MFC Connect Failure'	If the machine is not connected to your PC and you have loaded the Brother software, the PC will show 'MFC Connect Failure' each time you restart Windows®. You can ignore this message or you can turn it off as follows. Double-click "\\tool\warnOff.REG" from the supplied CD-ROM. The Scan key on the machine's control panel will not work unless you restart your PC with the machine connected. To turn it back on, Double-click "\\tool\WarnOn.REG" from the supplied CD-ROM.

DIFFICULTY	SUGGESTIONS
PhotoCapture Center™ Difficulties (MFC-3820CN only)	
Removable Disk does not work properly.	<p>a) Have you installed the Windows® 2000 update? If not, do the following:</p> <ol style="list-style-type: none"> 1. Disconnect the USB cable. 2. Install the Windows 2000® update. Please see the Quick Setup Guide. After the installation the PC will be automatically restarted. 3. Wait about 1 minute after you reboot the PC, and then connect the USB cable. <p>b) Take out the media card and put it back in again.</p> <p>c) If you have tried "Eject", you must take out the media card before you continue.</p> <p>d) If an error message appears when you try to eject the media card, it means the card is being accessed. Wait a while and then try again.</p> <p>e) If all of the above do not work, please turn off your PC and machine, and then turn them on again. (You will have to unplug the power cord of the machine to turn it off.)</p>
Network Difficulties (MFC-3820CN only)	
I cannot print over the Network	<p>Make sure that your machine is powered on and is On Line and in Ready mode. Print Network Configuration list. (See <i>Printing reports</i> on page 9-3.) Then the current settings of the network are printed. Reconnect the LAN cable to the hub to verify that the cabling and Network connections are good. If possible, try connecting the machine to a different port on your hub using a different cable. If the connections are good, the machine shows LAN active in 2 seconds.</p>

How to improve print quality

Cleaning the print head

To ensure good print quality, the machine will regularly clean the print head. You can start the cleaning process when needed.

Clean the print head and ink cartridges if you get a horizontal line in the text or graphics on your printed pages. You can clean two colours at a time (Black/Cyan, Yellow/Magenta), or all four colours at once.

Cleaning the print head consumes ink. Cleaning too often uses ink unnecessarily.

WARNING

Do NOT clean the print head by touching it with your hand or a cloth.

1 Press **Ink**.

2 Press  or  to select **Cleaning**.

Press **Menu/Set**.

3 Press  or  to select the colour you want to clean.

Press **Menu/Set**.

The machine will clean the print head. When cleaning is finished, the machine will go back standby mode automatically.



If you clean the print head at least five times and the print has not improved, call Brother your dealer for service.

Print quality check

If the print quality is not good, you can print a Print Quality Check Sheet to help you find the settings you may need to change.

1 For MFC-3420C, press **Menu/Set**, **4**.

For MFC-3820CN, press **Menu/Set**, **6**.

2 Press **Mono Start** or **Colour Start**.

The machine begins printing the Print Quality Check Sheet.

3 Check the sheet to see if the quality and alignment are OK by following STEPs A and B.

STEP A: Colour block quality check

The LCD shows:

Is Step "A" OK?

1.Yes 2.No

- 4 Check the quality of the four colour blocks on the sheet. (Black/Cyan/Yellow/Magenta).
- 5 If all lines are clear and visible, press **1** (Yes) to go to **STEP B**.
—OR—
If you can see missing short lines as shown below, press **2** (No).

OK

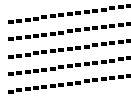

Poor

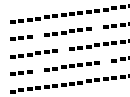

The LCD will ask you if the print quality is OK for each colour.

Black OK?

1.Yes 2.No

- 6 Press **2** (No) for any colour with a problem.

The LCD shows:

Press **1** (Yes). The machine will start cleaning the colours.

Start Cleaning?

1.Yes 2.No

- 7 After cleaning is finished, press **Mono Start** or **Colour Start**. The machine will start printing the Print Quality Check Sheet again and then return to **STEP A**.
- 8 If **STEP A** is OK, press **1** to proceed to **STEP B**.

STEP B: Alignment Check

The LCD shows:

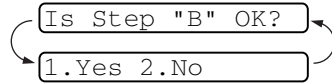

- 9** Check the 600 dpi and 1200 dpi test prints to see if number 5 most closely matches number 0. If the number 5 sample of both the 600 dpi and 1200 dpi are the best matches, press **1** (Yes) to finish **STEP B**.

—OR—

If another test print number is a better match for either 600 dpi or 1200 dpi, press **2** (No) to select it.

- 10** For 600 dpi, press the number of the test print that most closely matches the number 0 sample (1-8).

600dpi Adjust

Select Best #

- 11** For 1200 dpi, press the number of the test print that most closely matches the number 0 sample (1-8).

1200dpi Adjust

Select Best #

- 12** Repeat Steps 1 and 2 (in *Print Quality Check*) to print another sample Print Quality Check Sheet and then check it.

- 13** Press **Stop/Exit**.



When an ink head nozzle is clogged the printed sample looks like this.



After the ink head nozzle is cleaned, the horizontal lines are gone.

If you still see missing ink in this Print Quality Check Sheet, repeat the cleaning and test print procedures at least five times. If ink is still missing after the fifth cleaning and test print, replace the ink cartridge for the clogged colour. (Perhaps the ink cartridge was in your machine over six months or the expiration date written on the cartridge package has passed. Or, the ink may not have been stored properly before use.)

After replacing the ink cartridge, check it by printing another Print Quality Check Sheet. If the problem still exists, repeat the cleaning and test print procedures at least five times for the new ink cartridge. If ink is still missing, call Brother dealer.



Caution

Do NOT touch the print head. Touching the print heads may cause permanent damage and may void the print head's warranty.

Checking the ink volume



You can check the ink that is left in the cartridge.

1 Press **Ink**.

2 Press  or  to select Ink Volume.

Ink Volume ▾

Press **Menu/Set**.

3 Press  or  to select the colour you want to check.

Bk: -□□□■□□□+ ▾

The LCD shows the ink volume.

4 Press **Stop/Exit**.

 You can check the ink volume from your computer. (See *MFC Remote Setup* on page 5-1 in Software User's Guide on the CD-ROM or *MFC Remote Setup (Mac OS® X)* on page 9-22 in Software User's Guide on the CD-ROM.)

Packing and shipping the machine

Whenever you transport the machine, use the packing materials that came with your machine. If you do not pack the machine properly, you could void your warranty.

Caution

Do NOT unplug the machine after a print job until you hear the final click.

- 1** First, remove all the ink cartridges and attach the white shipping cover. (See *Replacing the ink cartridges* on page 13-21.) After attaching the white shipping cover, press all the ink cartridge covers down.

When attaching the white shipping cover, make sure it clips into place as shown in the diagram.

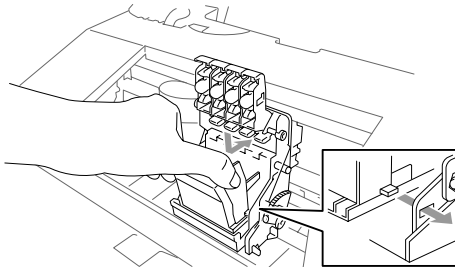

Caution

If you are not able to find the shipping cover, do NOT remove the ink cartridges before shipping. It is essential that the machine be shipped with either the shipping cover or the ink cartridges in position. Shipping without them will cause damage to your machine and may void your warranty.

- 2** Unplug the machine from the telephone wall socket and remove the telephone line cord from machine.
- 3** Unplug the machine from the AC outlet.
- 4** Unplug the USB cable from the machine, if it is connected.

5 Attach the yellow protective bar.

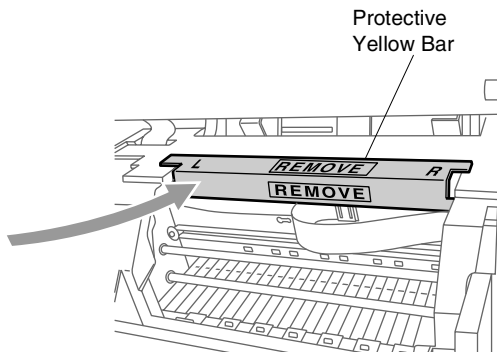

6 Remove the paper tray and output paper support.

7 Wrap the machine in the bag and place it in the original carton with the original packing material.

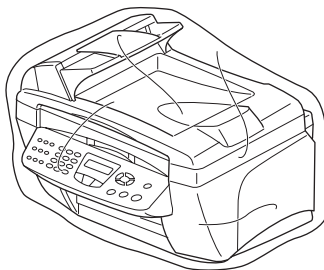

- 8** Pack the printed materials in the original carton as shown below.
Do not pack the used ink cartridges in the carton.

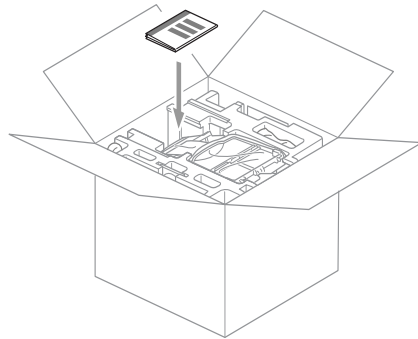
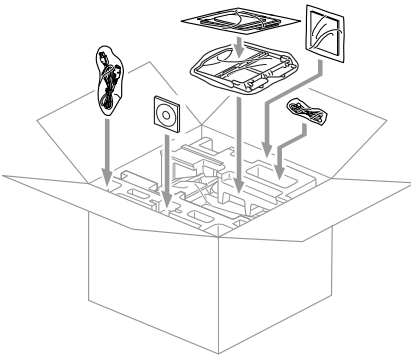
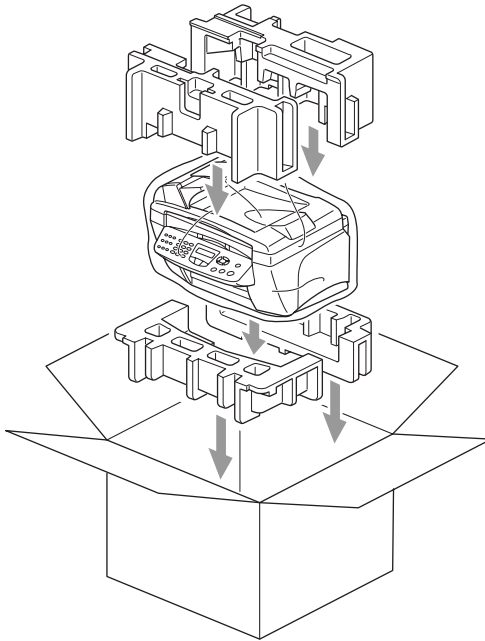

- 9** Close the carton.

Routine maintenance

Cleaning the scanner

Unplug the machine and lift the document cover. Clean the scanner glass and the white film with isopropyl alcohol on a soft lint-free cloth.

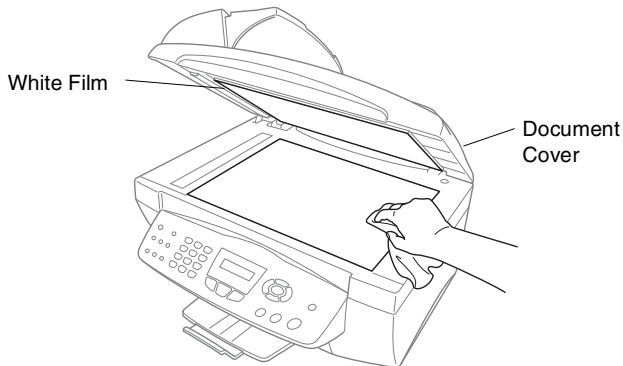

Open the document cover. Clean the white film and the glass strip under the film with isopropyl alcohol on a lint-free cloth.

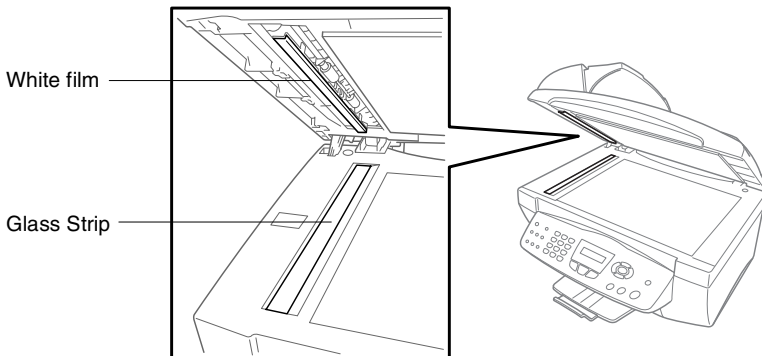

Cleaning the machine printer platen

- ⚠ Be careful not to touch the paper feed star wheels and flat cable, and encoding film.
- ⚠ Be sure to unplug the machine from the AC power outlet before cleaning the printer platen.
To clean your machine printer platen, wipe it with a soft lint free cloth that is dry.

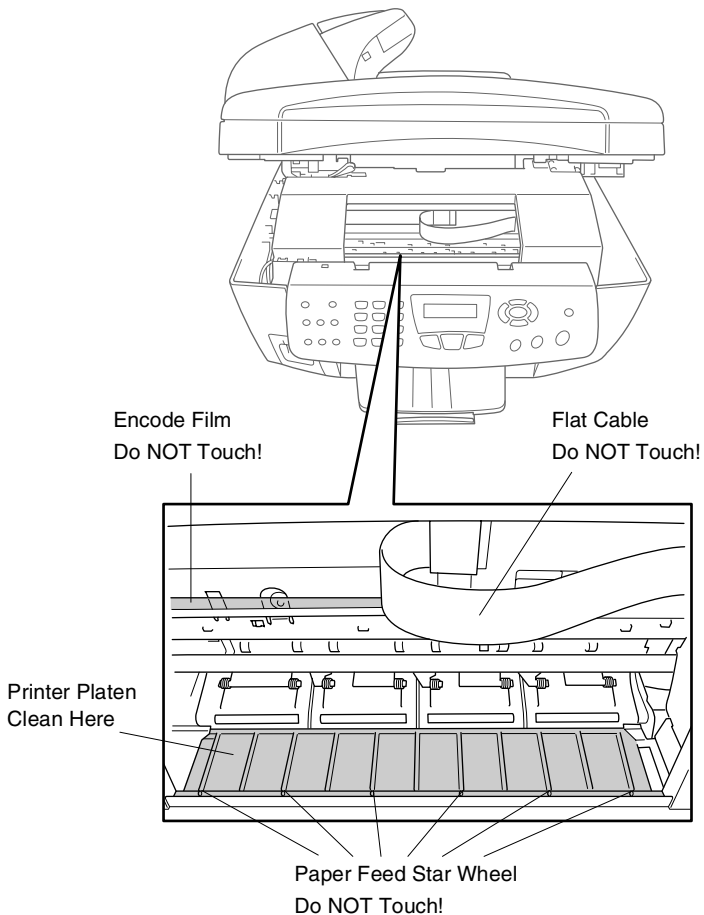



Replacing the ink cartridges

Your machine is equipped with an ink dot counter that automatically monitors the ink level in each colour cartridge. When the counter detects an ink cartridge is running out of ink, the machine will notify you with a message on the LCD.

The LCD shows you which colour cartridges are low or empty. Be sure to follow the LCD prompts so you replace the colour cartridges in the appropriate order.

When the ink cartridges are running low, you must use the Ink key to begin the cartridge replacement (Steps 1 to 3). If the ink is empty, skip to Step 3.

- 1 Press **Ink**.
- 2 Press  or  to select **Replace Ink**. Press **Menu/Set**.

 If one or more ink cartridges are empty, for example Black, the LCD shows **Pls Open Cover**.

- 3 Lift the scanner cover.
- 4 Push the appropriate coloured ink cartridge covers and remove the used ink cartridge.

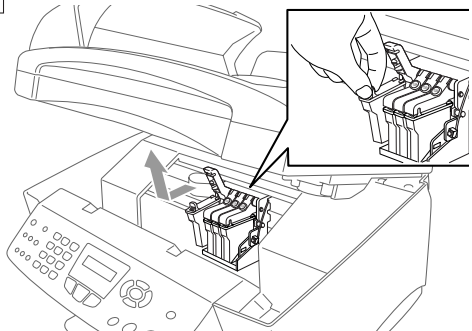
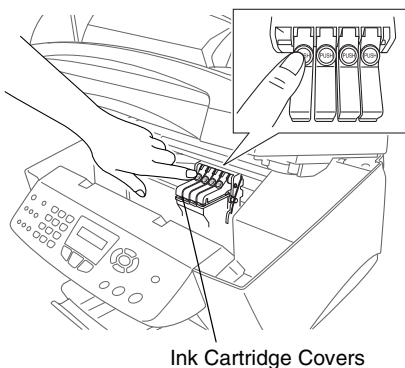

- 5 Open the new ink cartridge bag for the colour shown on the LCD, and then take out the ink cartridge.
- 6 Hold the new ink cartridge as shown in the illustration, and then peel the sealing tape from the side of the ink cartridge. Carefully peel the tape in the direction away from you.

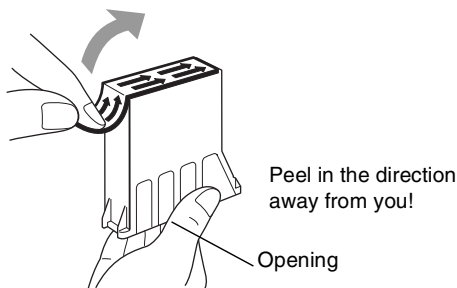

-  To prevent spilling ink and staining your hands and clothing, remove the sealing tape gently.
- 7 Each colour has its own correct position. Insert each new ink cartridge into the carriage.
 - 8 After installing the ink cartridge, close the scanner cover. Your machine prepares for a “head cleaning” and goes online. The LCD prompts you to verify that you removed the ink cartridge for each colour. Example: Have you removed Blck? 1.Yes 2.No.
- 9 If you removed the ink cartridge, press **1**.
- OR—
- If you did not remove the ink cartridge, press **2**.
- The LCD prompts you to verify that the ink cartridge was a *new* one. Example: Changed to new Blck? 1.Yes 2.No.

10 If the ink cartridge you installed is not a brand new one, please be sure to press **2**.

—OR—

For each *new* cartridge, press **1** on the dial pad to automatically reset the ink dot counter for that colour. (The ink dot counter enables the machine to notify you when a colour is running low.) The machine will enter a cleaning cycle for approximately 3 minutes for each replaced cartridge. The LCD alternately shows *Cleaning* and *Please Wait*.

When the machine completes the cleaning cycle, the LCD returns to Standby mode condition.

WARNING

If ink gets in your eyes, irrigate them with water immediately and call a doctor if you are concerned.

Caution

- DO NOT remove ink cartridges if you do not need to replace them. If you do so, it may reduce the ink quantity and the printer will not know the quantity of ink left in the cartridge.
- DO NOT shake the ink cartridges, because the ink may spill when you take off the sealing tape.
- If ink stains your body or clothing, wash with soap or detergent immediately.
- If you install an ink cartridge in the wrong colour position, you must clean the print head several times before you start printing (after correcting the cartridge installation) because the colours were mixed.
- Once you open an ink cartridge, install it in the machine and use it up within six months of installation. Use unopened ink cartridges by the expiration date written on the cartridge package.

- Brother multifunction machines are designed to work with ink of a particular specification and work to a level of optimum performance when used with genuine Brother ink cartridges. Brother cannot guarantee this optimum performance if ink or ink cartridges of other specifications are used. Brother does not therefore recommend the use of cartridges other than genuine Brother cartridges with this machine or the refilling of empty cartridges with ink from other sources. If damage is caused to the print head or other parts of this machine as a result of the use of ink or ink cartridges other than genuine Brother products due to the incompatibility or lack of suitability of those products with this machine, any repairs required as a result will not be covered by the warranty.



If the **Ink Empty** message is on the display after you have installed ink cartridges, check that the ink cartridges are installed properly.

G Glossary

- ADF (automatic document feeder)** The document can be placed in the ADF and scanned one page at a time automatically.
- Auto Reduction** Reduces the size of incoming faxes.
- Automatic fax transmission** Sending a fax without picking up the handset of an external phone.
- Automatic Redial** A feature that enables your machine to redial the last fax number after five minutes if the fax did not go through because the line was busy.
- Backup Print** Your machine prints a copy of every fax that is received and stored in memory. This is a safety feature so you will not lose messages during a power failure.
- Batch Transmission** (Black and white faxes only) As a cost savings feature, all delayed faxes to the same fax number will be sent as one transmission.
- Brightness** Changing the Brightness makes the whole image lighter or darker.
- Beeper Volume** Volume setting for the beep when you press a key or make an error.
- Broadcasting** The ability to send the same fax message to more than one location.
- Cancel Job** Cancels a programmed job, like Delayed Fax or Polling.
- CNG tones** The special tones (beeps) sent by fax machines during automatic transmission to tell the receiving machine that a fax machine is calling.
- Coding method** Method of coding the information contained in the document. All fax machines must use a minimum standard of Modified Huffman (MH). Your machine is capable of greater compression methods, Modified Read (MR), Modified Modified Read (MMR) and JPEG, if the receiving machine has the same capability.
- Communication error (or Comm. Error)** An error during fax sending or receiving, usually caused by line noise or static.

Compatibility group The ability of one fax unit to communicate with another. Compatibility is assured between ITU-T Groups.

Contrast Setting to compensate for dark or light documents, by making faxes or copies of dark documents lighter and light documents darker.

Delayed Fax Sends your fax at a specified later time that day.

Distinctive Ring A subscriber service purchased from the telephone company that gives you another phone number on an existing phone line. The Brother machine uses the new number to simulate a dedicated fax line.

Dual Access Your machine can scan outgoing faxes or scheduled jobs into memory at the same time it is sending a fax or receiving or printing an incoming fax.

ECM (Error Correction Mode) Detects errors during fax transmission and resends the pages of the fax that had an error.

Extension phone A telephone on the fax number that is plugged into a separate wall socket.

External phone A TAD (telephone answering device) or telephone that is plugged into the socket.

F/T Ring Time The length of time that the Brother machine rings (when the Receive Mode setting is Fax/Tel) to notify you to pick up a voice call that it answered.

Fax Detect Enables your machine to respond to CNG tones if you interrupt a fax call by answering it.

Fax Forwarding Sends a fax received into the memory to another pre-programmed fax number.

Fax Storage You can print stored faxes later or retrieve them from another location using Fax Forwarding, Paging, or Remote Retrieval functions.

Fax tones The signals sent by sending and receiving fax machines while communicating information.

Fax/Tel You can receive faxes and telephone calls. Do not use this mode if you are using a telephone answering device (TAD).

Fine resolution Resolution is 203 x 196 dpi. It is used for small print and graphs.

- Gray scale** The shades of gray available for copying and faxing photographs.
- Group number** A combination of Speed-Dial numbers that are stored in a Speed-Dial location for Broadcasting.
- Help list** A printout of the complete Menu table that you can use to program your machine when you do not have the User's Guide with you.
- Fax Journal** Lists information about the last 200 incoming and outgoing faxes. TX means Transmit. RX means Receive.
- Journal Period** The pre-programmed time period between automatically printed Fax Journal Reports. You can print the Fax Journal on demand without interrupting the cycle.
- LCD (liquid crystal display)** The display screen on the machine that shows interactive messages during On-Screen Programming and shows the date and time when the machine is idle.
- Manual fax** When you lift the handset of your external telephone or press **Tel/R** so you can hear the receiving fax machine answer before you press **Mono Start** or **Colour Start** to begin transmission.
- Menu mode** Programming mode for changing your machine's settings.
- MFL-Pro Suite (MFC-3820CN only)** Turns your machine into a printer and a scanner and enables PC faxing using the machine.
- MFL-Pro Suite (MFC-3420C only)** Turns your machine into a printer and a scanner and enables PC fax (sending) using the machine.
- OCR (optical character recognition)** The bundled ScanSoft® TextBridge® software application converts an image of text to text you can edit.
- Out of Paper Reception** Receives faxes into the machine's memory when the machine is out of paper.
- Overseas Mode** Makes temporary changes to the fax tones to accommodate noise and static on overseas phone lines.

Pause Allows you to place a 3.5 second delay in the dialling sequence stored on Speed-Dial numbers. Press **Redial/Pause** as many times as needed for longer pauses.

PhotoCapture Center™ (MFC-3820CN only) Allows you to print digital photos from your digital camera at high resolution for photo quality printing.

Photo resolution A resolution setting that uses varying shades of gray for the best representation of photographs.

Polling The process of a fax machine calling another fax machine to retrieve waiting fax messages.

Pulse A form of rotary dialling on a telephone line.

Quick Dial List A listing of names and numbers stored in Speed-Dial memory, in numerical order.

Real Time Transmission When memory is full, you can send faxes in real time.

Remaining jobs You can check which jobs are waiting in memory and cancel jobs individually.

Remote Activation Allows you to transfer a fax call, answered at an external or extension phone, to the machine.

Remote Deactivation (Fax/Tel mode only) When the machine answers a voice call, it pseudo/double-rings. You can pick up the call at an extension phone by pressing this code (# 5 1).

Remote Access Code Your own four-digit code (---*) that allows you to call and access your machine from a remote location.

Remote Retrieval Access The ability to access your machine remotely from a touch tone phone.

Resolution The number of vertical and horizontal lines per inch. See: Standard, Fine, Super Fine and Photo.

Ring Delay The number of rings before the machine answers in Fax Only mode.

Ring Volume Volume setting for the machine's ring.

Scanning The process of sending an electronic image of a paper document into your computer.

Scan to Card (MFC-3820CN only) You can scan a black and white or colour document into a Media Card. Black and white images will be in TIFF file format and colour images may be in PDF or JPEG file format.

Search An electronic, alphabetical listing of stored Speed-Dial and Group numbers.

Speed-Dial A pre-programmed number for easy dialling. You must press the **Search/Speed Dial** key and then #, and the two digit code to start the dialling process.

Standard resolution 203 x 97 dpi. It is used for regular size text and quickest transmission.

Station ID The stored information that appears on the top of faxed pages. It includes the sender's name and fax number.

Super Fine resolution 392 x 203 dpi. Best for very small print and line art.

TAD (telephone answering device) You can connect an external device or answering machine to the EXT. socket of the machine.

Temporary settings You can select certain options for each fax transmission and copy without changing the default settings.

Tone A form of dialling on the telephone line used for Touch Tone telephones.

Transmission The process of sending faxes over the phone lines from your machine to the receiving fax machine.

Colour Enhancement (MFC-3820CN only) Adjusts the colour in the image for better print quality by improving sharpness, white balance and colour density.

Xmit Report (Transmission Verification Report) A listing for each transmission, that shows its date, time and number.

S Specifications

Product description

General

Memory Capacity	8 MB (MFC-3420C) 16 MB (MFC-3820CN)
Automatic Document Feeder (ADF)	Up to 20 pages Temperature: 20°C - 30°C Humidity: 50% - 70% Paper: 80 g/m ² A4 size
Paper Tray	100 Sheets (80 g/m ²)
Printer Type	Ink Jet
Print Method	Piezo with 75 × 4 nozzles
LCD (Liquid Crystal Display)	16 characters × 1 line
Power Source	220 - 240V 50/60Hz
Power Consumption	(MFC-3420C) Minimum Under 3.5 watts Standby: 7 Wh or less (25°C) Peak: 22 Wh or less (MFC-3820CN) Minimum Under 4 watts Standby: 9.5 Wh or less Peak: 26 Wh or less

Dimensions

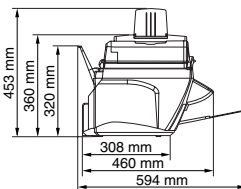
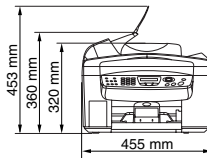

Weight	10 kg (MFC-3420C)
	11 kg (MFC-3820CN)
Noise	Operating: 48 dB A or less
	Standby: 35 dB A or less
Temperature	Operating: 10 - 35°C
	Best Print Quality: 20 - 33°C
Humidity	Operating: 20 to 80% (without condensation)
	Best Print Quality: 20 to 80% (without condensation)

Print media

Paper Input

Paper Tray

- Paper type:
Plain paper, recycled paper, inkjet paper (coated paper), glossy paper, transparencies* and envelopes
 - Paper size:
Letter, Legal, Executive, A4, A5, A6, JIS_B5, envelopes (commercial No.10, DL, C5, Monarch, JE4), Photo card, Index card.
For more details, see *Paper specifications for the paper tray* on page 2-5.
 - Maximum paper tray capacity: Approx. 100 sheets of 80 g/m² plain paper
- * Use only transparencies recommended for inkjet printing.

Paper Output

Up to 50 sheets of A4 plain paper (Face up print delivery to the output paper support)

For inkjet (coated paper) and transparency, we recommend removing printed pages from the output paper support immediately after they exit the machine to avoid smudging.

Copy

Colour/Black	Colour/Black
Copy Speed	Mono Up to 12 pages/minute (A4 paper) Colour Up to 10 pages/minute (A4 paper) Does not include the time it takes to feed the paper. Based on Brother standard pattern. Fast mode
Multiple Copies	Stacks or Sorts up to 99 pages
Enlarge/Reduce	25% to 400% (in increments of 1%)
Resolution	Max. 1200 x 1200 dpi

PhotoCapture Center (MFC-3820CN only)

Available Media	CompactFlash® (Microdrive™ is not compatible) (Compact I/O card such as Compact LAN card and Compact Modem card are not supported.) SmartMedia® (3.3V) (Not available for use with ID) Memory Stick® (Not available for music data with MagicGate) SD (Secure Digital) Memory Card
File Extension (Media Format) (Image Format)	DPOF, EXIF, DCF Photo Print: JPEG*, TIFF Scan to Card: JPEG, PDF (Colour) TIFF, PDF (Black) * Progressive JPEG format is not available.
Colour Enhancement	Colour Enhance
Number of Files	Up to 999 files in the media card
Folder	File must be in the 3rd stratum of the folder of Media Card

Fax

Compatibility	ITU-T Group 3
Coding System	MH/MR/MMR/JPEG
Modem Speed	Automatic Fallback 14400 bps: (MFC-3420C) 33600 bps: (MFC-3820CN)
Document Size	ADF Width: 148 mm to 216 mm ADF Height: 148 mm to 356 mm Scanner Glass Width: Max. 216 mm Scanner Glass Height: Max. 297 mm
Scanning Width	208 mm
Printing Width	204 mm
Gray Scale	256 levels
Polling Types	Standard, Secure, Timer Sequential: (B&W only)
Contrast Control	Automatic/Light/Dark (manual setting)
Resolution	<ul style="list-style-type: none">• Horizontal 203 dot/inch (8 dot/mm)• Vertical Standard -<ul style="list-style-type: none">3.85 line/mm (Black)7.7 line/mm (Colour)Fine - 7.7 line/mm (Black/Colour)Photo - 7.7 line/mm (Black)Superfine - 15.4 line/mm (Black)
Speed-Dial	40 stations (MFC-3420C) 100 stations (MFC-3820CN)
Broadcasting	90 stations (MFC-3420C) 150 stations (MFC-3820CN)
Automatic Redial	3 times at 5 minute intervals
Auto Answer	0, 1, 2, 3 or 4 rings (0, 1, 2, 3, 4, or 5 rings - Nordic countries only)
Communication Source	Public switched telephone network.

Memory Transmission	Up to 200* ¹ /170* ² pages (MFC-3420C) Up to 480* ¹ /400* ² pages (MFC-3820CN)
Out of Paper Reception	Up to 200* ¹ /170* ² pages (MFC-3420C) Up to 480* ¹ /400* ² pages (MFC-3820CN)

*1 "Pages" refers to the "Brother Standard Chart No. 1" (a typical business letter, Standard resolution, MMR code). Specifications and printed materials are subject to change without prior notice.

*2 "Pages" refers to the "ITU-T Test Chart #1" (a typical business letter, Standard resolution, MMR code). Specifications and printed materials are subject to change without prior notice.

Scanner

Colour/Monochrome	Colour/Monochrome
TWAIN Compliant	Yes (Windows® 98/98SE/Me/2000 Professional) Mac OS® 8.6-9.2/Mac OS® X 10.2.1 or greater
WIA Compliant	Yes (Windows® XP)
Resolution	Up to 9,600 × 9,600 dpi (interpolated)* Up to 600 × 2,400 dpi (optical) * Maximum 1200 x 1200 dpi scanning with Windows® XP (resolution up to 9,600 x 9,600 dpi can be selected by using the Brother scanner utility)
Scanning Speed	Colour: up to 5 sec. Mono: up to 3 sec. (A4 size in 100 × 100 dpi)
Document Size	ADF Width: 148 mm to 216 mm ADF Height: 148 mm to 356 mm Scanner Glass Width: Max. 216 mm Scanner Glass Height: Max. 297 mm
Scanning Width	210 mm
Gray Scale	256 levels



Mac OS® X scanning is supported in Mac OS® X 10.2.1 or greater.

Printer

Printer Driver	Windows® 98/98SE/Me/2000 Professional and XP driver supporting Brother Native Compression mode and bi-directional capability Apple® Macintosh® QuickDraw® Driver For Mac OS® 8.6-9.2/Mac OS® X 10.1/10.2.1 or greater
Resolution	Up to 4800 x 1200 optimized dots per inch (dpi)* 1200 x 1200 dots per inch (dpi) 600 x 600 dots per inch (dpi) 600 x 300 dots per inch (dpi) 600 x 150 dots per inch (dpi) * <i>Black and White Printing:</i> The machine prints using black ink up to 4800 x 1200 optimized dpi when Photo mode is selected in the printer driver. * <i>Colour Printing:</i> The machine uses Brother's OP Technology to automatically vary the printing resolution for producing the highest quality output. Brother's OP Technology is automatically activated during colour printing using Photo mode and selects the print resolution appropriate for the printing task up to 4800 x 1200 optimized dpi when printing on photo quality paper. * Output image quality varies based upon many factors including but not limited to input image resolution and quality and print media.
Print Speed	up to 14 pages/minute (Mono)* up to 12 pages/minute (Colour)* * Based on Brother standard pattern. * A4 size in draft mode. * Does not include the time it takes to feed the paper.
Printing Width	8.03 inches (204 mm)
Disk-Based Fonts	35 TrueType

Interfaces

USB	A Standard Universal Serial Bus cable that is not longer than 2.0 m.
------------	--

Computer requirements

Minimum System Requirements						
Computer Platform & Operating System Version		Processor Minimum Speed	Minimum RAM	Recommended RAM	Available Hard Disk Space	
					Driver	Application Software* ¹
Windows® Operating System	98, 98SE	Pentium 75MHz	24 MB	32 MB	80 MB (MFC-3420C) 160 MB (MFC-3820CN)	100 MB
	Me	Pentium 150MHz	32 MB	64 MB		
	2000 Professional	Pentium 133MHz	64 MB	128 MB		
	XP* ³	Pentium 233MHz			180 MB	
Apple® Macintosh® Operating System	Mac OS® 8.6 - 9.2 (Printing, Scanning* ⁴ and PC-FAX Send Only)	All base models meet minimum Requirements	32 MB	64 MB	80 MB	200 MB
	Mac OS® X 10.1/10.2.1 or greater (Printing* ⁵ , Scanning* ^{2,4} , PC-FAX Send and Remote Setup* ⁶ Only)		128 MB	160 MB		
NOTE: All registered trademarks referenced herein are the property of their respective companies.						
For the latest drivers, go to the Brother Solutions Center at http://solutions.brother.com/						



*¹ Application Software is different for Windows® and Macintosh®

*² Scanning is supported in 10.2.1 or greater.

*³ Maximum 1200 x 1200 dpi scanning with Windows® XP. (Resolutions up to 9600 x 9600 dpi can be selected using the Brother Utility.)

*⁴ Dedicated “Scan” key and direct Network Scanning (MFC-3820CN) not supported in Mac® Operation System.

*⁵ Network printing and PC-FAX sending supported in Mac OS® X 10.2.4 or greater. (MFC-3820CN)

*⁶ Network Remote Setup not supported in Mac® Operating System. (MFC-3820CN)

Consumable items

Ink

Black and 3 individual colour ink cartridges separate from the print heads.

Service Life of Ink Cartridge

Approximately 500 page/Black cartridge at 5% coverage with 600 x 150 dpi resolution (Fast).

Approximately 400 page/Colour cartridge at 5% coverage with 600 x 150 dpi resolution (Fast).

These numbers are based on consecutive printing; the numbers will vary based on print frequency and number of pages.

The machine periodically cleans the print head to maintain print quality. This process consumes a small amount of ink.

Network (LAN) (MFC-3820CN only)

You can connect your machine to a network for Network Printing, Network Scanning and Internet Fax. Also included is Brother BRAdmin Professional Network Management software.

Support for:

Windows® 98/Me/2000/XP

Mac OS® 8.6 - 9.2, Mac OS® X 10.1/10.2.4 or greater*
Ethernet 10/100 BASE-TX Auto Negotiation
TCP/IP

RARP, BOOTP, DHCP, APIPA, NetBIOS, WINS
LPR/LPD, Port9100,
SSDP, Rendezvous, FTP

* Network Printing and PC-FAX are available for Mac OS® 8.6-9.2, Mac OS® 10.2.4 or greater.

* Mac OS® 8.6-9.2 (Quick Draw over TCP/IP)

* Mac OS® X 10.2.4 or greater (Rendezvous)

* Network Scanning and Remote Setup are not available for Mac.

* Media drive is not available for Mac.

Included Utilities:

BRAdmin Professional (Windows®)



BRAdmin Professional is not supported in Mac OS®.

Index

A

- Access codes, storing and dialling 7-5
- ADF (automatic document feeder) 2-1, 6-2
- ADF cover 13-4
- Answering machine (TAD) 1-10
 - connecting 1-12
- Automatic dialing 7-1
- fax receive 5-1
- fax redial 6-8
- transmission 6-4

B

- Broadcasting 6-12
 - setting up Groups for 7-3

C

- Canceling
 - Fax Forwarding 8-5
 - fax jobs in memory 6-10
 - jobs awaiting redial 6-11
 - Paging 8-5
- Cleaning
 - print head 13-12
 - printer platen 13-20
 - scanner 13-19
- CNG tones 1-7
- Color Enhance
 - PhotoCapture Center™ 11-11
- Connecting
 - external TAD 1-10
 - external telephone 1-9
- Consumable items S-8

- Control panel overview 1-2

Copy

- brightness 10-10
- color adjustment 10-16
- contrast 10-15
- default settings 10-15
- Enlarge/Reduce 10-5
- enter Copy mode 10-1
- keys 10-4
- multiple 10-2
- Out of Memory 10-3
- Page Layout 10-13
- paper 10-8
- Quality key 10-6
- quality setting 10-15
- single 10-2
- Sort (ADF only) 10-12
- temporary settings 10-4
- using ADF 10-2

- Cordless phone 5-8

- Credit Card Numbers 7-5

- Custom telephone features
 - on a single line 1-15, 13-9

D

- Date and Time 4-1

- Delayed Batch Transmission 6-15

- Delayed Fax 6-14

Dialling

- a pause 7-6
- access codes and credit card numbers 7-5
- automatic fax redial 6-8
- automatic transmission 6-4
- Groups 6-12
- manual 6-1

Search	6-2
Speed-Dial	6-2
Dual Access	6-9

E

ECM (Error Correction Mode)	1-8
Envelopes	2-5, 2-7
Error messages on LCD ...	13-1
Check Paper	13-1
Comm. Error	13-1
Ink Empty	13-2
Not Registered	6-2
Out of Memory	13-3
while scanning a document	10-3
EXT	
external telephone	1-10
TAD (answering machine)	1-10
Extension telephone, using	5-7
Extension Telephones	1-13
External telephone	1-9

F

Fax codes	
changing	5-8, 8-3
Fax Receive Code	5-7
Remote Access Code	8-3
Telephone Answer Code ...	5-7
Fax Detect	5-5
Fax Forwarding	
changing remotely	8-5, 8-6
Fax Storage	8-2
Backup Print	8-2
printing from memory	5-6
turning on	8-2

Fax, stand-alone	
receiving	5-1
difficulties	13-8
Fax Forwarding	8-5
from extension phone	5-7
reducing to fit on paper ...	5-6
retrieving from a remote site	8-6
Ring Delay, setting	5-3
sending	6-1
automatic	6-4
Broadcasting	6-12
canceling from memory	6-11
colour fax	6-8
contrast	6-6
delayed	6-14
enter Fax mode	6-1
from ADF	6-2
from memory (Dual Access)	6-9
from scanner glass	6-3
manual	6-5
overseas	6-13
Real Time Transmission	6-9
redialing	7-6
resolution	6-7
Fax/Tel mode	
answering at extension phones	5-7
double-ringing (voice calls)	5-4
F/T Ring Time	5-4
Fax Receive Code	5-7
receiving faxes	5-7
Ring Delay	5-3
Telephone Answer Code ...	5-7

G

- Gray scale S-4, S-5
- Groups for Broadcasting 7-3

H

HELP

- display messages 3-1
- navigation keys 3-2
- Help List 9-3

I

Ink cartridges

- checking ink volume 13-15
- replacing 13-21
- Ink Dot Counter 13-21

J

Jams

- original 13-4
- paper 13-4

L

LCD (liquid crystal display)

- 3-1, 3-2

M

Maintenance, routine 13-19

Manual

- dialing 6-1
- receive 5-1
- transmission 6-5

Memory Storage 3-1

Menu Selection Table 3-1

Mode, entering

- Copy 10-1
- Fax 6-1
- Scan 1-3

Multi-line connections (PBX)

- 1-15

O

Options key (copying)

- Brightness 10-10
- Paper Size 10-9
- Paper Type 10-8

P

PABX 1-15, 4-4, 4-5

Paper 2-4, S-2

- capacity 2-5
- size of original 2-1
- Type 4-7

Phone line

- connections 1-12
- difficulties 13-9
- multi-line (PBX) 1-15

PhotoCapture Center™

- CompactFlash® 11-1
- DPOF printing 11-8
- Memory Stick® 11-1
- Printing images 11-6
- Printing Index 11-5
- SmartMedia® 11-1
- specifications S-3

Power failure 3-1

Print

- area 2-7
- difficulties 13-8
- drivers S-6
- fax from memory 5-6
- improving quality 13-12
- paper jams 13-5
- report 9-3
- resolution S-6
- specifications S-6

Programming your MFC

- 3-1, 3-2

Q

Quality key (copying) 10-4

R

Receive Mode	5-2
External TAD	5-1
Fax Only	5-1
Fax/Tel	5-1
Manual	5-1
Redial/Pause	6-8
Reducing	
copies	10-5
reducing	
long faxes	5-6
Remote Retrieval	8-4
access code	8-3, 8-4
commands	8-5
getting your faxes	8-6
Reports	9-1
Fax Journal	9-3
Help List	9-3
how to print	9-3
Network Configuration	9-3
Quick-Dial	9-3
Transmission Verification	
.....	9-1, 9-3
User Settings	9-3
Resolution	
copy	S-3
fax (Standard, Fine,	
SuperFine, Photo)	S-4
print	S-6
scan	S-5
setting for next fax	6-7
Ring Delay, setting	5-3

S

Safety Instructions	iii, 12-2
Setup	
Date and Time	4-1
Station ID (fax header)	
entering text	4-2
Shipping the machine	13-16

Speed-Dial

changing	7-2
dialing	6-2

T

TAD (telephone answering	
device), external	1-10, 5-1
connecting	1-10, 1-12
Receive Mode	5-1
recording OGM	1-12
Temporary copy settings ...	10-4
Text, entering	4-3
special characters	4-4
Tone signals on Pulse line ...	7-6
Troubleshooting	13-1
checking ink volume	13-15
error messages on LCD ...	13-1
if you are having difficulty	
incoming calls	13-9
phone line difficulties ...	13-9
printer difficulties	13-10
printing or receiving faxes	
.....	13-8
sending faxes	13-9
original jam	13-4
paper jam	13-5
print quality	13-12
TX Lock	6-17, 6-18

V

Volume, setting	4-8
beeper	4-8
ring	4-8
speaker	4-9

Remote Retrieval Access card

If you plan to receive fax messages while away from your machine, carrying the Remote Retrieval Access Card printed below will serve as a convenient reminder of the retrieval procedures. Simply cut out the card and fold it to fit your wallet or organizer. Keeping it handy will help you derive the full benefit of your MFC's Fax Forwarding, and Remote Retrieval features.

REMOTE RETRIEVAL ACCESS CARD

Using Remote Access Code

- 1 Dial your fax number from a telephone or fax machine using touch tone.
- 2 When your machine answers, immediately enter your Remote Access Code (3 digits followed by *).
- 3 Your machine signals the kinds of messages it received:
1 long beep — Fax messages
No beeps — No messages.
- 4 After 2 short beeps, enter a command.
- 5 Press **90** to reset your machine when you finish.
- 6 Hang up.

CHECK RECEIVING STATUS
Press **971**
1 long beep — Fax messages
3 short beeps — No messages

CHANGE RECEIVE MODE
Press **98**
then for External TAD, press **1**.
Fax/Tel, press **2**.
Fax Only, press **3**.

EXIT REMOTE OPERATION
Press **90**.

1

4

Fold ←

← Fold

Changing Remote Access Code

When you are at the machine:

- 1 Press **Menu/Set**, 2, 5, 3.
- 2 Enter a three-digit number from 000 to 998.
The * cannot be changed.
- 3 Press **Menu/Set**.
- 4 Press **Stop/Exit**.

Remote Commands

CHANGE FAX FORWARDING SETTING

Press **9 5**. Turn feature **Off**, press **1**,
then **10**. Select Fax Forwarding, press **2**.

Fold ←

Program Fax Forwarding Number, press **4**. Enter the new fax number where you want your fax messages forwarded followed by **##**.

Turn Fax Storage On, press **6**.
Turn Fax Storage Off, press **7**.

RETRIEVE A FAX

Press **9 6**.

then **10**.

Retrieve all faxes, press **2**.

then enter the number of remote fax machine followed by **##**.
After the beep, hang up and wait.

Erase all fax messages, press **3**.

→ Fold

2

3



This machine is approved for use in the country of purchase only, local Brother companies or their dealers will only support machines purchased in their own countries.

UK/IRE/SAF/PAN NORDIC
Version A

Free Manuals Download Website

<http://myh66.com>

<http://usermanuals.us>

<http://www.somanuals.com>

<http://www.4manuals.cc>

<http://www.manual-lib.com>

<http://www.404manual.com>

<http://www.luxmanual.com>

<http://aubethermostatmanual.com>

Golf course search by state

<http://golfingnear.com>

Email search by domain

<http://emailbydomain.com>

Auto manuals search

<http://auto.somanuals.com>

TV manuals search

<http://tv.somanuals.com>