



# Explorer 657





## Fishfinder and Chartplotter

Installation and Operation Manual

# **NORTHSTAR**

[www.northstarnav.com](http://www.northstarnav.com)

**IMPORTANT SAFETY INFORMATION**  
**Please read carefully before installation and use.**

	This is the safety alert symbol. It is used to alert you to potential personal injury hazards, Obey all safety messages that follow this symbol to avoid possible injury or death.
	WARNING indicates a potentially hazardous situation which, if not avoided, could result in death or serious injury
	CAUTION indicates a potentially hazardous situation which, if not avoided, could result in minor or moderate injury.
	CAUTION used without the safety alert symbol indicates a potentially hazardous situation which, if not avoided, may result in property damage.

**DISCLAIMER:** It is the owner's sole responsibility to install and use the instrument and transducers in a manner that will not cause accidents, personal injury or property damage. The user of this product is solely responsible for observing safe boating practices.

BRUNSWICK NEW TECHNOLOGIES INC. AND ITS SUBSIDIARIES AND AFFILIATES DISCLAIM ALL LIABILITY FOR ANY USE OF THIS PRODUCT IN A WAY THAT MAY CAUSE ACCIDENTS, DAMAGE OR THAT MAY VIOLATE THE LAW.

Governing Language: This statement, any instruction manuals, user guides and other information relating to the product (Documentation) may be translated to, or

has been translated from, another language (Translation). In the event of any conflict between any Translation of the Documentation, the English language version of the Documentation will be the official version of the Documentation.

This manual represents the Explorer 657 as at the time of printing. Brunswick New Technologies Inc. and its subsidiaries and affiliates reserve the right to make changes to specifications without notice.

Copyright © 2006 Brunswick New Technologies Inc. Northstar™ is a registered trademark of Brunswick New Technologies Inc

#### **FCC Statement**

Note: This equipment has been tested and found to comply with the limits for a Class B digital device, pursuant to Part 15 of the FCC Rules. These limits are designed to provide reasonable protection against harmful interference in a normal installation. This equipment generates, uses and can radiate radio frequency energy and, if not installed and used in accordance with the instructions, may cause harmful interference to radio communications. However, there is no guarantee that interference will not occur in a particular installation. If this equipment does cause harmful interference to radio or television reception, which can be determined by turning the equipment off and on, the user is encouraged to try to correct the interference by one or more of the following measures:

- Reorient or relocate the receiving antenna.
- Increase the separation between the equipment and receiver.
- Connect the equipment into an output on a circuit different from that to which the receiver is connected.
- Consult the dealer or an experienced technician for help.
- A shielded cable must be used when connecting a peripheral to the serial ports.

## Important

The choice, location, angle and installation of the instrument & transducers are critical to performance of the system as intended. Follow instructions in this manual carefully. If in doubt, consult your Northstar dealer.

Ensure that any holes cut are in a safe position and will not weaken the boat's structure. If in doubt, consult a qualified boat builder.

Do not install plastic through hull transducers in solid wooden hulls. Leaking through the hull may result.

Do not install bronze transducers in metal hulls. This will cause electrolytic corrosion that may result in damage to the hull or transducer.

**Sonar Performance:** The accuracy of the sonar depth display can be affected by many factors, including the type and location of the transducer and water conditions. Ensure that the transducer is located and used correctly.

**Global Positioning System:** The Global Positioning System (GPS) is operated by the US Government which is solely responsible for its operation, accuracy and maintenance. The GPS system is subject to changes which could affect the accuracy and performance of all GPS equipment anywhere in the world including the 657. Whilst the Northstar 657 is a precision navigation instrument, it can be misused or misinterpreted, which can result in its use being unsafe. To reduce the risk of misusing or misinterpreting the 657, the user must read and understand all aspects of this Installation and Operation manual. We also suggest that the user practice all operations using the built in simulator before using the 657 at sea.

**Electronic Chart:** The electronic chart used by the 657 is an aid to navigation and is designed to supplement the use of official government charts not replace them. Only official government charts supplemented by notices to mariners contain the information required for safe and prudent navigation. Always supplement the information provided by the 657 with other plotting sources such as observations, depth soundings, radar and hand compass bearings. Should the information not agree then the discrepancy must be resolved before proceeding any further.

**Sonar fishfinder:** The accuracy of the sonar depth display can be limited by many factors, including the type of the transducers, the location of the transducers and water conditions. It is the user's responsibility to ensure the 657 transducers are installed and used correctly.

**AIS:** The AIS features on this chart-plotter are designed as a safety aid only and do not guarantee safety at sea. AIS transmission is mandatory on some, but not all, vessels. You should check your local laws and regulations for requirements in your area. As a result of different legal requirements, different vessel sizes and uses, you should not assume that your AIS equipped chart-plotter will show the location of ALL vessels in your area. Careful prudence, judgement, and safe navigation practices should always be exercised. AIS should be used to complement radar, but AIS is not a substitute for radar.

**Fuel Computer:** Fuel economy can alter drastically depending on the boat loading and sea conditions. The fuel computer should not be the sole source of information concerning available fuel onboard and the electronic information should be supplemented by visual or other checks of the fuel load. This is necessary due to possible operator induced errors such as forgetting to reset the fuel used when filling the tank, running the engine with the fuel computer not switched on or other operator controlled actions that may render the device inaccurate. Always ensure that adequate fuel is carried onboard for the intended trip plus a reserve to allow for unforeseen circumstances.

**Failure to adhere to these warnings may lead to death, serious injury or property damage. Northstar disclaims all liability for installation or use of this product that causes or contributes to death, injury or property damage or that violates any law.**

The 657 is set up with default units of feet, °F (Fahrenheit), US gallons and knots. To change the units, see section 17-10.

# Contents

---

<b>1 Introduction</b> .....	<b>7</b>
1-1 Overview .....	8
1-2 Cleaning and maintenance .....	8
1-3 Plug-in cards .....	8
1-4 Removing and replacing the display unit .....	9
<b>2 Basic Operation</b> .....	<b>10</b>
2-1 Using the keys .....	10
2-2 Turning on and off / auto power .....	11
2-3 Backlight and night mode .....	12
2-4 Man overboard (MOB) .....	12
2-5 Alarms .....	13
2-6 Simulate mode .....	13
2-7 The main windows .....	14
<b>3 Navigation: Chart</b> .....	<b>19</b>
3-1 Introduction to navigating .....	19
3-2 Chart window .....	21
3-3 Distance and bearing calculator .....	23
3-4 Projected course .....	23
3-5 Tracks and tracking .....	24
<b>4 Navigation: Highway window</b> .....	<b>24</b>
<b>5 Navigation: Waypoints</b> .....	<b>25</b>
5-1 Waypoints window .....	25
5-2 Managing waypoints .....	26
<b>6 Navigation: Routes</b> .....	<b>27</b>
6-1 Routes window .....	28
6-2 Managing routes .....	28
<b>7 Satellites</b> .....	<b>30</b>
7-1 Satellite window .....	31
<b>8 Sonar fishfinding: Introduction</b> .....	<b>31</b>
8-1 Using the 657 .....	31
8-2 Interpreting the display .....	32
8-3 Single and Dual frequency fishfinding .....	34

8-4 Fish detection and display .....	37
8-5 Range .....	38
8-6 Gain and threshold .....	39
<b>9 Sonar fishfinding: Displays .....</b>	<b>40</b>
9-1 Sonar history display - no split .....	40
9-2 Sonar Zoom and Full Screen Zoom displays .....	41
9-3 Sonar Bottom display .....	42
9-4 Sonar 50/200 display .....	42
9-5 Sonar A-Scope display .....	43
<b>10 Gauges window .....</b>	<b>44</b>
<b>11 Data window .....</b>	<b>44</b>
<b>12 Fuel functions and display .....</b>	<b>45</b>
12-1 What the fuel computer does .....	45
12-2 Fuel window .....	45
12-3 When you add or remove fuel .....	46
12-4 Low fuel alarm .....	47
12-5 Boat speed sensors .....	47
12-6 Fuel consumption curves .....	49
12-7 Calibration .....	51
<b>13 Tides window .....</b>	<b>52</b>
<b>14 User card window .....</b>	<b>53</b>
<b>15 AIS .....</b>	<b>54</b>
15-1 Viewing AIS Vessels .....	55
15-2 Dangerous Vessels .....	55
15-3 AIS Windows .....	56
<b>16 DSC/Buddy track windows .....</b>	<b>57</b>
16-1 The displays .....	57
16-2 Using the displays .....	58
<b>17 Setting up the 657 .....</b>	<b>59</b>
17-1 Setup > System .....	61
17-2 Setup > Chart .....	62
17-3 Setup > Sonar .....	65
17-4 Setup > GPS .....	66

17-5 Setup > Fuel .....	66
17-6 Setup > Track.....	68
17-7 Setup > AIS.....	69
17-8 Setup > Logs .....	69
17-9 Setup > Alarms .....	70
17-10 Setup > Units.....	71
17-11 Setup > Comms .....	71
17-12 Setup > Calibrate .....	72
17-13 Setup > Time .....	73
17-14 Setup > Favorites .....	73
17-15 Setup > Simulate .....	74
<b>18 Installation .....</b>	<b>74</b>
18-1 Installation: What comes with the 657 .....	75
18-2 Installation: Options and Accessories .....	75
18-3 Installation: The display unit .....	77
18-4 Installation: Power/data cable .....	78
18-5 Installation: GPS antenna .....	79
18-6 Installation: Sonar transducer .....	80
18-7 Installation: Northstar petrol/gasoline sensors.....	80
18-8 Installation: SmartCraft™ .....	81
18-9 Installation: Other NavBus instruments.....	81
18-10 Installation: Other NMEA instruments .....	82
18-11 Installation: Setup and test .....	83
<b>Appendix A - Specifications.....</b>	<b>84</b>
<b>Appendix B - Troubleshooting.....</b>	<b>86</b>
B-1 General problems .....	86
B-2 GPS navigation problems.....	87
B-3 Fuel consumption problems.....	87
B-4 Sonar fishfinding problems .....	88
<b>Appendix C - Glossary and navigation data.....</b>	<b>90</b>

# 1 Introduction

**Quick reference** to the built-in and optional features:

Feature	Type	See	Requires
<b>General</b>	How to use the keys and displays	2	
	Troubleshooting	Appendix B	
	Simulate mode	2-6	
	Glossary of special names	Appendix C	
	Specifications	Appendix A	
<b>MOB</b>	Man overboard key	2-4	
<b>Navigation</b>	Overview of how to navigate	3-1	GPS fix
	Finding the boat's position on the chart	3-2	
	Navigate to any point or to a waypoint	3-1	
	Navigate along a route	3-1	
	Projected course: An estimate of progress	3-4	
	Tracks: records of where the boat has been	3-5	
	GPS receiver status	7	
	Saving and loading data with a user card	14	User card
<b>Chart data</b>	Chart features (built in world chart)	3-2	
	Chart details	3-2-4 & 5	C-MAP™ chart
	Tides at a port	11	C-MAP™ chart
	AIS	15	
<b>Alarms</b>	Built in alarms	2-5	
	SmartCraft™ engine alarms	1-1	SmartCraft™
<b>Boat data</b>	Data at top of main displays	2-7-3	
	Compass at top of main displays	2-7-4	
	Dedicated data window	11	
<b>Fuel</b>	Fuel computer, petrol/gasoline engine	12	Fuel sensors
	Fuel computer, SmartCraft™ engines	12	SmartCraft™
	What to do when you add or remove fuel	12-1	
<b>Sounder</b>	Overview of the depth sounder	8	Sounder
	Depth, bottom features, water features	8	Sounder
	Fishfinder	8	Sounder
<b>Other boats</b>	Track your buddy, polling other boats	16	DSC VHF
	Distress calls	16	DSC VHF

## 1-1 Overview

---

The Northstar 657 is a compact, rugged, highly integrated marine chartplotter and fishfinder. It is easy to use and has an easy to read color display. Complex functions can be performed with a few key presses, taking the hard work out of boating.

The available functions, displays and setup menus depend on the optional sensors and instruments that are installed:

- Sonar functions require a sonar transducer to be installed
- Fuel functions require one or more petrol/gasoline or diesel fuel sensors to be installed.
- SmartCraft™ engine functions require a SmartCraft™ system to be installed. For information on using SmartCraft™, see the *SmartCraft™ Gateway Installation and Operation Manual*.

- DSC/Buddy track functions require a Northstar DSC VHF radio with Buddy track support to be installed.
- The 657 can send data to other instruments, such as an autopilot, and receive data from other instruments.
- AIS functions require an optional AIS receiver to be installed.

For information on installing options, see section 18-2.

This manual describes how to install and operate the 657. Special terms are explained in Appendix C. For maximum benefit, please read this manual carefully before installing and using the unit. For more information on this instrument and other Northstar products, go to our website, [www.northstarnav.com](http://www.northstarnav.com).

## 1-2 Cleaning and maintenance

---

The 657 screen is covered by a proprietary anti-reflection coating. To avoid damage, clean the screen only with a damp cloth and mild detergent when dirty or covered in sea salt. Avoid abrasive cleaners, petrol or other solvents. If a plug-in card gets dirty or wet, clean it with a damp cloth or mild detergent.

Cover or remove a transom-mounted transducer when repainting the hull. If painting over a through hull transducer with antifouling paint,

use only one coat of paint. Remove the previous coat of antifouling paint by sanding it lightly.

To optimize performance, avoid walking on or jamming cables and connectors. Keep the transducer free of weed, paint and debris. Do not use a high pressure water blast on a speed sensor paddlewheel as it may damage the bearings.

Push the dust cover over the display when the 657 is turned off.

## 1-3 Plug-in cards

---

The 657 can use two kinds of plug-in card:

- 1 C-MAP™ chart cards** have chart details required for navigating in a particular region. When a chart card is plugged in, the extra details automatically appear on the 657 chart window.

The 657 can use NT, NT+ and NT-MAX cards. NT-MAX cards have much more chart information than earlier cards, including photos of points of interest.

- 2 C-MAP™ user cards** are used to store navigation data. Each user card expands the 657 memory and allows the data to be transferred to another 657 easily. (see section 14).

**Note:** The older 5 volt user cards are not supported.



## Changing the plug-in card



Gold contacts under here

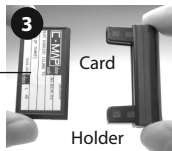

### CAUTION

Handle plug-in cards carefully. Keep them in their protective cases when not plugged into the 657.

Keep the holder in place in the 657 at all times to prevent moisture from entering the card compartment.

Turn the 657 off (see section 2-2).

Pull the card holder out of the 657 and pull any card out of holder.

Put the card in its case.

Push new card into holder. Ensure the gold contacts are on the outer edge and underneath (see above).

Keep the card's case.

Push card holder fully into 657

## 1-4 Removing and replacing the display unit

If the display unit is bracket mounted then the display unit can easily be removed and replaced for security or protection.

### Removing the display unit:

- 1 Turn the display unit off (see section 2-2) and put the dust cover on.
- 2 Loosen the knob on the mounting bracket and lift the unit off the bracket.
- 3 Unplug the connectors from the display unit; turning each locking collar anticlockwise until you can pull the plug out.
- 4 Push the attached dust covers over the exposed ends of the connectors.
- 5 Store the display unit in a dry clean place, such as the optional Northstar carry bag.

### Replacing the display unit

- 1 Remove the dust covers from the connectors. Plug the connectors into the back of the display unit:
  - Match the connector's color to the socket color.

- Insert each connector and turn the locking collar clockwise until it is finger tight.

Nothing will be damaged if a cable is plugged into the wrong socket by mistake.

- 2 Hold the display unit in place on the mounting bracket. Adjust the tilt of the display for best viewing, then hand tighten the knob on the mounting bracket. Remove the dust cover.



## 2 Basic Operation

### Overview of the keys



**ESC** ESCAPE - Go back to an earlier menu or display. In chart mode, centres chart at boat's position.

**DISP** DISPLAY - Show a menu of the main displays. To go to a display, select it from the menu (see section 2-7).

**▲▼◀▶** CURSOR KEYS - to move the cursor or the selection highlight.

**MENU** MENU - Show a menu of the options for the current window. Press **MENU** again to display the Setup menu (see section 17).

**ENT** ENTER - Start an action or accept a change.

**+ -** ZOOM - Chart window: Zoom in or out to display different areas and detail on the chart.  
Sonar window: Change the depth range displayed.

**F** FAVORITES - Allows you to quickly switch between your saved favorite displays.

**×** MOB - (Man Overboard, see section 2-4).

**⏻** POWER - Turn 657 on and off (see section 2-2); adjust the backlighting (see section 2-3).

### 2-1 Using the keys

In this manual:

**Press** means to push the key for less than a second.

**Hold** means to hold the key down.

The internal beeper beeps when a key is pressed (to disable or enable the beep, see section 17-1).

#### Using the menus

Operate the 657 by selecting items from menus. Items can be submenus, commands or data.

#### Selecting a submenu

A **▶** after a menu item indicates a submenu, for example Chart **▶**. Press **▲** or **▼** to move the highlight to the submenu, then press **ENT**.

#### Starting a command

Press **▲** or **▼** to move the highlight to the command, for example Goto cursor, then press **ENT**.

### Changing data

First press **▲** or **▼** to move the highlight to the data to change, then:

#### a) To change a tick box

means On or Yes

means Off or No.

Press **ENT** or **▶** to change the tick box.

#### b) To select an option

1 Press **ENT** to display the menu of options.

Palette	Normal
Map datum	Normal
NMEA datum offset	Sunlight
Map shift	Night

2 Press **▲** or **▼** to move the highlight to the option you want, then press **ENT**.



#### c) To change a name or number:

1 Press **ENT** to display the name or number:

2 Press **◀** or **▶** to select a letter or digit to change. Press **▲** or **▼** to change the letter or digit.

Repeat this to change other letters or numbers.

3 Press **ENT** to accept the new value. Or press **ESC** to ignore the changes.

#### d) To change a slider value

Press **◀** to decrease the value or **▶** to increase the value.



## 2-2 Turning on and off / auto power

### Turning on manually

If the 657 is not wired for auto power, press **ⓘ** to turn the unit on. If necessary, adjust the display to be easy to read (see section 2-3).

**Note:** If the 657 is not wired for auto power then the 657 does not record engine hours and might not record fuel consumption (see section 18-4).

### Turning off manually

If the 657 is not wired for auto power or if the ignition switch is off, hold down **ⓘ** until the display turns off.

### Auto power



If the 657 is wired for auto power (see section 18-4), then:

- The 657 automatically turns on when you turn the boat's ignition switch on.
- You can not turn the 657 off while the ignition switch is on.
- If Auto power off (see section 17-1) is  the 657 automatically turns off when you turn the boat's ignition switch off.
- If Auto power off (see section 17-1) is , the 657 stays on when you turn the boat's ignition switch off. You can now turn the 657 off manually.



## 2-3 Backlight and night mode

To go to the Backlight display, press  briefly.

### Backlight

The display and keys are backlit. To change the backlight level, highlight  select Backlight, then press  to dim or  to brighten.

When you have finished, press .

 **Tip:** Press  twice to give the brightest screen, with maximum backlight and Night mode off.

## 2-4 Man overboard (MOB)

The MOB feature saves the boat's position and then navigates back to this point.

### WARNING

MOB will not work if the 657 does not have a GPS fix.



- 1 Press .  
The 657 stores the boat's position as a waypoint called MOB.
- 2 The 657 changes to the chart window, with the MOB waypoint at the center of the chart. The chart zooms in for accurate navigation. If the chart can not show the required small scale, the 657 changes to plotter mode (a white display with crosshatching and no chart details, see section 17-2).
- 3 The 657 sets the MOB waypoint to be the destination to navigate to.

**If the NMEA output (autopilot) is off** (see section 17-11) use the 657 to manually navigate to the destination MOB waypoint (see sections 3-1-1 and 3-1-2).

### Night mode

Night mode sets the palette for all displays.

- Normal palette, for daytime
- A palette optimised for night time.

To change mode, highlight Night mode, then press  or . To change only the chart palette, see section 17-2.

**If the NMEA output (autopilot) is on**, the 657 asks if the autopilot is active.

Select:

**No:** Use the 657 to manually navigate to the destination MOB waypoint (see sections 3-1-1 and 3-1-2).

**Yes:** The 657 asks if the boat is to go to the MOB waypoint.

Select:

**Yes:** to immediately start navigating to the MOB waypoint.

### WARNING

This might result in a sudden and dangerous turn.

**No:** disengage the autopilot; then use the 657 to manually navigate to the destination MOB waypoint (see sections 3-1-1 and 3-1-2).

### To cancel MOB or set another MOB

- 1 Press  again to display a menu.
- 2 Select an option from the menu.

 **Tip:** The MOB waypoint remains on the chart after the MOB has been cancelled. To delete the MOB waypoint, see section 5-2-5.

## 2-5 Alarms

---

When the 657 detects an alarm condition, it displays a warning message on the display, the internal beeper sounds and any external beepers or lights operate.

Press **ESC** to clear the alarm. The alarm will sound again if the alarm condition occurs again.

The 657 has user settable alarms (see section 17-9).

## 2-6 Simulate mode

---

In Simulate mode, the 657 ignores data from the GPS antenna and other transducers and sensors and the 657 generates this data itself. Otherwise, the 657 functions normally.

There are two simulate modes:

- Normal: Allows a user to become familiar with the 657 off the water.
- Demo: Simulates a boat moving along a route and automatically displays different 657 functions.

To start and stop Simulate mode, and for more information, see section 17-15. In simulate mode, Simulate or Demo flashes at the bottom of the display.



Never have Simulate mode on when the 657 is navigating on the water.

## 2-7 The main windows

The display menu allows quick access to the main windows. Full-screen Chart and Sonar are at the top of the menu. Other windows are available from the **More...** sub menu.

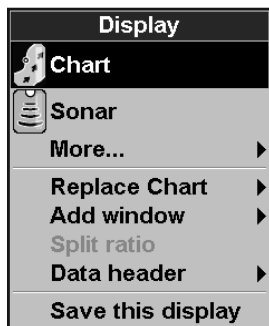

### Note

- 1 The windows available depend on the optional sensors and instruments that are installed (see section 1-1).
- 2 Set up commonly used windows as favorites and press  to switch between windows (see section 2-7-2).

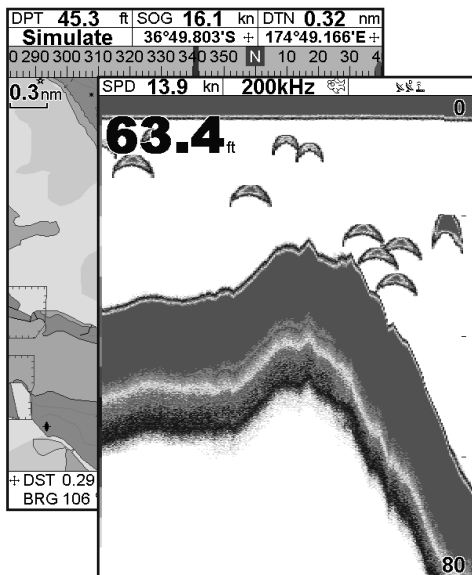

**Note:** The windows below the menu divider can only be shown full screen without a data header. (see section 2-7-3).

Display

- Chart
- More...
- Replace Chart
- Add window
- Split ratio
- Data header
- Save this display

Display

- Gauges
- Highway
- Fuel
- Data
- Tanks
- Waypoints
- Routes
- Satellite
- Tides
- User card
- AIS
- DSC
- Engine faults

The image shows a stack of seven display windows. From top to bottom:

- Water speed:** A gauge showing speed in kn and RPM, with a needle pointing to approximately 30.
- GPS speed:** A gauge showing speed in kn and RPM, with a needle pointing to approximately 30.
- Depth:** A gauge showing depth in ft and Water speed in kn, with a needle pointing to approximately 20.
- Port Water:** A fuel gauge showing Used (32.0) and Remaining (68.0) percentages.
- Stbd Fuel:** A fuel gauge showing Used (40.0) and Remaining (60.0) percentages.
- Port Oil:** A fuel gauge showing Used (28.0) and Remaining (72.0) percentages.
- Stbd Oil:** A fuel gauge showing Used (36.0) and Remaining (64.0) percentages.

Waypoints

Name	Latitude	DST(nm)	Dngr
AKL0	36°50'33"S	1754	No
Tides			
AKL1	CAPE TOWN	Distance	
AKL2	10:32:44		
AKL3	01/Jan/05		
AKL4	Sunrise		
AKL4	Sunset		
AMS0	Low water		
AMS0	2.23 ft	11:	
AMS1	2.09 ft	23:	
AMS2	6.1		
AMS3	4.3		
CAE0	3.6		
CAE1	2.8		
CAE1	2.1		
Time	11:5		

User card

Name	Type	Date	Time
Device not formatted			
Note: All time		Track 2:	0
in memory		Track 3:	0
Waypts:		Track 4:	0
Routes: 10		Track 5:	0
Track 1:			0

## 2-7-1 Multi window displays

The 657 can show two windows at once.

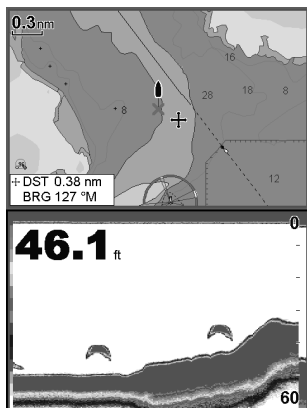

### Adding a window to the display

Press **DISP**, select Add window and select a window to add. The 657 automatically rearranges the display to show the new window.

### Changing window size

- 1 Press **DISP** and select Split ratio.
- 2 Press **▲** or **▼** to change the height of the windows.

**Note:** Some windows are fixed in size.

- 3 Press **ENT**.

### Exchanging two windows on the display

- 1 Press **DISP** twice to change the active window.
- 2 Press **DISP**, select Replace and select the second window.

The 657 exchanges the two windows.

### Replacing a window on the display

- 1 Press **DISP** twice to change the active window.
- 2 Press **DISP**, select Replace and select a new window that is not currently visible.

**Note:**

When some windows are small then not all the data is shown.

### The active window

If there is more than one window displayed, the active window is indicated by a red border. Press **DISP** twice to change the active window.

Pressing **MENU** will display the options menu for the active window.

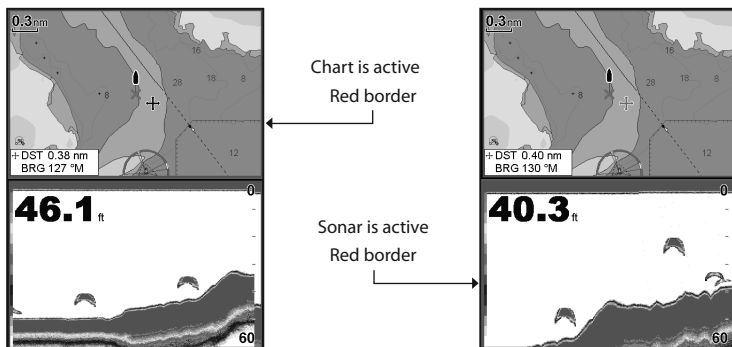



## 2-7-2 Favorite displays

The 657 has a list of commonly used displays, called favorite displays. There can be up to six favorite displays.

Sonar, Gauges, Fuel, Data, and Tanks windows can be combined in a display. Each of these displays can have a data header (see section 2-7-3) and a compass (see section 2-7-4).

### Selecting a favorite display

To select another favourite, press  one or more times. For example, with six favourites:

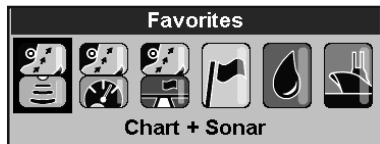

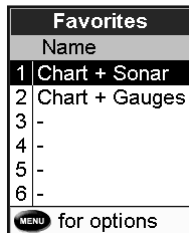

### Adding a favorite display to the list

- 1 Set up the display with the window or windows you want in the new favorite (see section 2-7).
- 2 Press  and select **Save this display**. The 657 displays the favorites list.
- 3 Select where in the list to add the new favorite. If you select an existing favorite display then the new favorite will replace the existing favorite in the list.



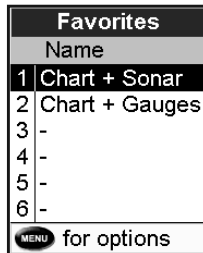

### Deleting a favorite display from the list

- 1 Press  twice then select **Favorites**.
- 2 Highlight the display to delete, press  and select **Delete**.



### Changing the order of the favorites list

- 1 Press  twice then select **Favorites**.
- 2 Highlight the display to move, press  and select **Move up** or **Move down**.

### 2-7-3 Data header

The displays can show data at the top, called the data header.

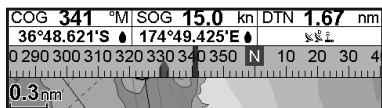

When you select a window from the display menu (see section 2-7) the 657 displays an appropriate data header for the window.

Each favorite display (see section 2-7-2) has its own data header. When you press **ENT** to recall a favorite display, the 657 recalls the favorite displays data header.

#### Setting the data header for a display

- 1 Press **DISP** and select Data header.
- 2 To turn the data header on or off:
  - i Select Data.
  - ii Select  or
- 3 To select the size of the data:
  - i Select Size.
  - ii Select the size to display.
- 4 To change the data displayed:
  - i Select Data setup.
    - ii Change a data field:
      - a Press the cursor keys to highlight the field.
      - b Press **ENT** to display a menu of data items.
      - c Select a data item that is available on your system or select None to leave the field empty.
    - iii Repeat the above step to set the other data fields.

**Tip:** If all fields in a line are None then the line will not be displayed and the data header will take less space on the display.

- 5 Press **ESC**

**Tip:** The data header will change when you select another display. To set a data header that you can recall later, set the header as part of a favorites display (see below).

### Favorites displays and data headers

To set a data header for a favorites display, follow the steps to add a favorite (see section 2-7-2 - Adding a favorite display to the list). In step 1, set the data header for the favorite as described above.

### 2-7-4 Compass

The chart, sonar and highway displays can show a compass at the top of the window.

The compass always shows the boat's course over ground (COG), a black symbol in the middle. When the boat is navigating to a point, the compass also shows bearing to the destination (BRG), a red symbol.

In this example, BRG is 332°M and COG is 341°M.

To turn the compass off or on:

- 1 Press **MENU** and select Data header.
- 2 Set Compass to  or

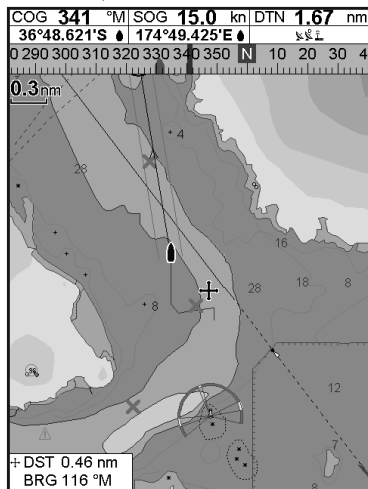

## 3 Navigation: Chart

The chart window shows the chart, the boat's position course and navigation data.

### 3-1 Introduction to navigating

The 657 has two ways of navigating, going straight to a point or following a route.

#### 3-1-1 Navigating to a point

When the 657 is navigating to a point, the chart and highway displays show navigation data:

- The boat position 
- The destination point marked with a circle.
- The boat's plotted course to the destination.
- Two CDI lines, parallel to the boat's plotted course, which indicate the maximum expected deviation from the plotted course.

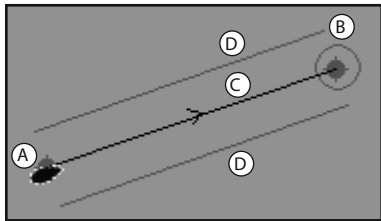

For more information, see appendix C.

If the 657 is connected to an autopilot, the 657 will send data to the autopilot to steer the boat to the destination. Start the autopilot before starting to navigate to the point.

If the 657 has no autopilot, steer the boat manually:

- use the boat position and destination on the chart or highway displays
- or use navigation data displayed on the data header (see section 2-7-3)
- or use COG and BRG on the compass (see section 2-7-4).

#### Note:

- If the XTE alarm is enabled, an alarm will sound if the boat deviates too much from its intended course (see section 17-9).
- If the arrival radius alarm is enabled, then an alarm will sound to show that the boat has reached the destination (see section 17-9).

#### 3-1-2 Going to a waypoint or to a point on the chart

A waypoint is a position that you can set on the 657 chart, for example a fishing spot or a point on a route (see section 5).

##### Going to a waypoint from the chart window

- Go to the chart window.
- Move the cursor to the waypoint: either use the cursor keys or use Find (see section 3-2-5).
- Press **MENU** and select Goto.

##### Going to a waypoint from the waypoints window

- Go to the waypoints window.
- Press **▲** or **▼** to highlight the waypoint to goto.
- Press **MENU** and select Goto.

##### Going to a point on the chart

- Switch to a chart window.
- Move the cursor to the destination point: either use the cursor keys or use Find (see section 3-2-5).

#### WARNING

Make sure the course does not pass over land or dangerous waters.

- Press **MENU** and select Goto cursor.

#### Navigating

The 657 navigates to the point as described in section 3-1-1.

#### Cancelling navigating

Go to a Chart window, press **MENU** and select Cancel goto.

 **Tip:** Before starting, create waypoints at points of interest. Create a waypoint at the start of the trip for you to navigate back to (see section 5-2-1).

### 3-1-3 Following a route

#### Preparing

A route is a list of waypoints that the boat can follow (see section 6).

- To create waypoints before creating the route, see section 5-2-1.
- To create a route, see section 6-2-1.

#### Starting a route from the chart window:

- 1 Go to the chart window.
- 2 Press **MENU** and select **Start Route**
- 3 Press **▲** or **▼** to highlight the route to follow. Press **ENT**.
- 4 The 657 asks for the direction to traverse the route.  
Select **Forward** (the order the route was created) or **Reverse**.
- 5 The 657 displays the chart with the route marked and starts navigating from the start of the route.

#### Starting a route from the routes window:

- 1 Go to the routes window.
- 2 Then follow step 3 as in **starting a route from the chart window** above.

#### Navigating

The 657 navigates to each waypoint on the route in turn as described in section 3-1-1.

The 657 stops navigating to the waypoint at the end of the current leg and starts the next leg of the route:

- a when the boat comes within 0.025 nm of the waypoint
- b or when the boat passes the waypoint
- c or if you skip the waypoint.

#### Skipping a waypoint

To skip a waypoint, go to a chart window, press **MENU** and select **Skip**. The 657 starts navigating straight towards the next waypoint on the route.



Skipping a waypoint with the autopilot on might result in a sudden course change.

#### Cancelling a route

When the boat has reached the final waypoint, or to stop the boat following the route at any time, cancel the route. Go to a chart window, press **MENU** and select **Cancel route**.

### 3-2 Chart window

To go to the Chart window, press **DISP** then select **Chart**.

A typical chart window shows:

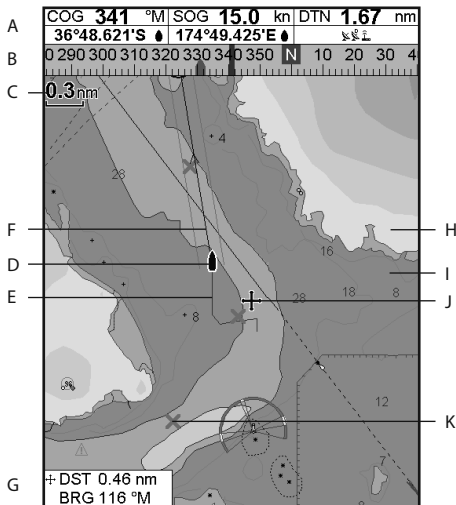

A	Data header. To turn the data off or on or to change what data is displayed, see section 2-7-3
B	Compass (see section 2-7-4)
C	Chart scale (see section 3-2-3)
D	Boat position (see section 3-2-1)
E	Boat track (see section 3-5)
F	Boat course and CDI lines (see Appendix C, CDI).
G	Distance and bearing of cursor from boat
H	Land
I	Sea
J	The cursor (see section 3-2-1)
K	A typical waypoint (see section 5)
<p><b>Note:</b> To change the types of information displayed on the chart, see section 17-2. To change to a perspective view of the chart, see section 3-2-6.</p>	





### 3-2-1 Chart modes

The Chart has two modes:

#### Center on boat mode

To switch to center on boat mode in the chart window, press **ESC**. The boat  is at the center of the chart. As the boat moves through the water, the chart automatically scrolls to keep the boat in the center of the chart. The cursor (see below) is turned off.

#### Cursor mode

The keys , ,  and  are called cursor keys. To switch to cursor mode in the chart window, hold down a cursor key. The cursor  appears and moves away from the boat:

- Press the key which points in the direction that the cursor will move, for example press  to move the cursor down.
- Press midway between two of the cursor keys to make the cursor move diagonally.
- Hold a cursor key down to make the cursor move continuously across the display.



In Cursor mode:

- The distance (**DST**) and bearing (**BRG**) of the cursor from the boat are displayed at the bottom corner of the display.
- The chart does not scroll as the boat moves.
- If the cursor reaches the edge of the display, the chart will scroll.



For example, hold down  to move the cursor to the right side of the display and the chart will scroll to the left.

### 3-2-2 Latitude and longitude

Latitude and longitude can be displayed in the data header. The display is degrees and minutes to three decimal places, about 2 m (6 ft) resolution. Normally the position is the boat's position, and the latitude and longitude has a boat symbol to show this:

 36° 29.637' N or S Latitude  
 175° 09.165' E or W Longitude



If the cursor has been moved in the last ten seconds, then the position is the cursor's position, and the latitude and longitude has a cursor symbol to show this:

 36° 29.841' N or S Latitude  
 175° 09.012' E or W Longitude

### WARNING

When reading the boat position, make sure the position is not the cursor position.



### 3-2-3 Chart scale

Press  to zoom in and display a smaller area of the chart in more detail. Press  to zoom out and display a bigger area in less detail.







The chart scale is displayed at the top left of the chart:



### 3-2-4 Chart symbols and information

The chart shows many kinds of symbols, such as waypoints, ports, marinas, buoys and beacons. If necessary, press  or  to choose a chart scale where the symbol is displayed.

To see stored information about a symbol:

- 1 Either move the cursor to the symbol on the chart and wait two seconds or use Find to move the cursor to a symbol for a port or service (see section 3-2-5).
- 2 A window appears at the bottom of the display with some information about the symbol.
- 3 To see more detail about a symbol or a list of associated items for the symbol, press **ENT**.
  - i Select an item to display. If there are more items than will fit on the display, press  or  to scroll up or down.  
Select a camera icon to display a photo of the item. If the photo is too big to fit on the display, press , ,  or  to scroll the photo.  
Select Tide Station to display a tide chart for the position (see section 13).
  - ii Select other items or press **ESC** to return to the chart.

To see stored information about nearby symbols press **MENU** and select **Chart info**. Then follow step 3 above.

### 3-2-5 Finding a chart symbol

To find and display a chart symbol:

- 1 Press **MENU** and select Find.
- 2 Select the type of symbol: Waypoints, Routes, Ports by name, Ports & services, Tide stations or AIS Vessels.
- 3 For Ports & services: select the type of service to find.

For Ports by name: press **←**, **→**, **▲** or **▼** to enter a name or letters contained in the port name, then press **ENT**.

- 4 A list of items is displayed. If there are more items than will fit on the display, press **+** or **-** to page up and down.

For Ports by name: to search for a different port name, press **ESC**, change the name, then press **ENT**.

- 5 Select the item and press **ENT**. The chart window changes to show the item in the middle of the display.

To see stored information about the item, press **ENT** (see section 3-2-4).

### 3-2-6 Perspective view

Perspective view shows the chart from an angle instead of from straight above. To turn perspective view on or off, press **MENU** and set Perspective to  or .

### 3-3 Distance and bearing calculator

The distance and bearing calculator can plot a course of one or several legs and show the bearing and length of each leg, as well as the total distance along the course. The completed course can be converted into a route.

To use the distance and bearing calculator:

- 1 Select the Chart window. Press **MENU** and select Distance.
- 2 Move the cursor to the start of the first leg. It does not matter if this point is a waypoint or not. Press **ENT**.
- 3 To add a leg to the course, move the cursor to the end of the leg. It does not matter if this point is a waypoint or not. The display shows the bearing and length of the leg, as well as the total distance along the course. Press **ENT**.

- 4 To remove the last leg from the course, press **MENU** and select Remove.
- 5 Repeat the above two steps to enter the whole course.
- 6 To save the new course as a route, press **MENU** and select Save. This also saves any new points on the course as new waypoints, with default names. If necessary, edit the route later (see section 6-2-2) and edit any new waypoints later (see section 5-2-3).
- 7 Finally, press **ESC** to return to the chart window.

### 3-4 Projected course

If Projected course is turned on, then the 657 will display the projected position based on the course over ground (COG), speed and a specified time. To turn Projected course on and off and to set the time, see section 17-2.

- A Projected position
- B Boat's projected course
- C Boat position

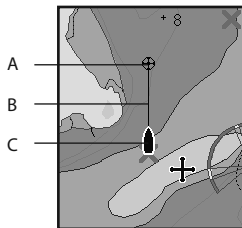

### 3-5 Tracks and tracking

Tracking records the boat's position to memory at regular intervals, which can be:

- Time intervals.
- Or distance intervals.

The track of where the boat has been can be displayed on the chart. The 657 can display one track while recording another.

To work with tracks, see section 17-6.

The 657 can store five tracks:

- Track 1 can hold up to 2000 points and is intended to record the normal progress of the boat.
- Tracks 2, 3, 4 and 5 can hold up to 500 points each and are intended to record sections to be retraced accurately, for example entering a river mouth.

**Tip:** Record a reference track and then use the track to help navigate the same trip later. For example, record a reference track as you leave harbour. Then if you return to harbour and visibility is poor, select the chart and navigate manually along the reference track back into

the harbour. Record reference tracks in good conditions.

When recording is on and the track becomes full then recording continues and the oldest points in the track are deleted. The maximum length of a track depends on the selected track interval: a small interval will give a shorter, more detailed track and a long interval will give a longer, less detailed track, as shown in these examples:

#### Time intervals

Interval	Track 1	Track 2, 3, 4 or 5
1 sec	33 minutes	8 minutes
10 sec	5.5 hours	1.4 hours
1 min	33 hours	8 hours

#### Distance intervals

Interval	Track 1	Track 2, 3, 4 or 5
0.01	20	5
1	2,000	500
10	20,000	5,000

The track lengths are in the current distance units, for example nm.

## 4 Navigation: Highway window

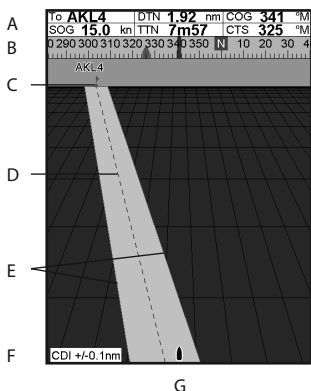

The highway window has a bird's eye view of the boat's course to a destination:

To go to the highway window, press **DISP**, select **More**, then select **Highway**.

#### The highway window shows:

- A Optional data header (see section 2-7-3)
- B Optional compass (see section 2-7-4)
- C Destination waypoint
- D Boat's plotted course to destination
- E CDI lines, parallel to the boat's plotted course (see Appendix C, CDI). The CDI lines are like a highway over the water where the boat will move.
- F CDI scale
- G The boat position is at the bottom, center of the display.

#### **WARNING**

The highway window does not show land, dangerous waters or chart symbols.



## 5 Navigation: Waypoints

A waypoint is a position that you can set on the 657 chart, for example a fishing spot or a point on a route. The 657 can have up to 3000 waypoints. A waypoint can be created, changed or deleted.

A waypoint has:

- A name (up to eight characters).
- An icon showing what kind of waypoint it is. The available icons are:



- A position.
- A color for the waypoint symbol and name on the chart.

- A type:

**Normal:** A normal waypoint can be navigated to or included in a route.

**Danger:** A danger waypoint is a point to avoid. If the boat comes within the danger radius of a danger waypoint the unit can sound an alarm. (see section 17-9).

- A display option:

Controls how the waypoint is displayed when the Waypoints setup option is set to Selected (see section 17-2):

Off: The waypoint is not displayed.

Icon: The waypoint icon is displayed.

I+N (Icon and Name): The waypoint icon and name are displayed.

If there are many waypoints, use this feature to select which waypoints are displayed on the chart.

**Note:** The other choices for Waypoints are Hide all and Show all (see section 16-2).

### 5-1 Waypoints window

To go to the waypoints window, press **DISP**, select **More**, then select **Waypoints**.

The waypoints window is a list of the waypoints that have been entered, each with waypoint symbol, name, latitude and longitude, distance and bearing from the boat, type and display option.

If there are more waypoints than will fit on the display, press **+** or **-** to scroll up or down a page at a time.

Waypoints				
▼Name	Latitude	DST(nm)	Dngr	
	Longitude	BRG(°M)	Disp	
✕ AKL0	36°50.338'S	7654	No	
	174°46.495'E	116	Icon	
✕ AKL1	36°49.945'S	7656	No	
	174°49.021'E	116	Icon	
✕ AKL2	36°49.079'S	7657	No	
	174°49.695'E	116	Icon	
✕ AKL3	36°47.849'S	7658	No	
	174°49.200'E	116	Icon	
✕ AKL4	36°46.974'S	7659	No	
	174°49.081'E	116	Icon	
✕ AMS0	53°19.180'N	5257	No	
	007°18.545'E	18	Icon	
✕ AMS1	53°19.762'N	5258	No	
	007°14.141'E	18	Icon	
✕ AMS2	53°19.927'N	5258	No	
	007°10.720'E	18	Icon	
✕ AMS3	53°19.927'N	5259	No	
	007°07.868'E	18	Icon	
✕ CAE0	32°46.675'N	6848	No	
	079°57.248'W	330	Icon	
✕ CAE1	32°46.199'N	6848	No	
	079°56.591'W	330	Icon	

to page up/down

## 5-2 Managing waypoints

### WARNING

Do not create a navigation waypoint on land or in dangerous water.

### 5-2-1 Creating a new waypoint

#### Creating and editing a new waypoint from the chart window

- 1 To create a waypoint at the boat position, press **ESC** to switch the chart to center on boat mode.

Or, to create a waypoint at a different point, move the cursor to that point on the chart.

- 2 Press **ENT**.
- 3 A new waypoint, with the default name and data is created.
- 4 Change the waypoint data if necessary (see section 5-2-7).

#### Creating a new waypoint from the waypoints window

- 1 In the waypoints window, press **MENU** and select **Create**.
- 2 A new waypoint, with a default name and data, is created at the boat position.
- 3 Change the waypoint data if necessary (see section 5-2-7).

**Note:** Waypoints can also be created when a route is created (see section 6-2-1).

### 5-2-2 Moving a waypoint

#### Moving a waypoint from the chart window

- 1 In the chart window, move the cursor to the waypoint to move.
- 2 Press **MENU** and select **Move**.
- 3 Move the cursor to the new position and press **ENT**.

#### Moving a waypoint from the waypoints window

To move a waypoint from the waypoints window, edit the waypoint (see section 5-2-3) and change the latitude and longitude.

### 5-2-3 Editing a waypoint

#### Editing a waypoint from the chart window

- 1 In the chart window, move the cursor to the waypoint to edit.

- 2 When the waypoint data is displayed, press **ENT**.
- 3 Change the waypoint data (see section 5-2-7).

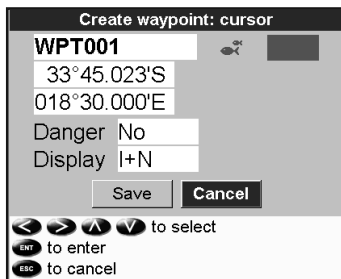

Create waypoint: cursor

WPT001

33°45.023'S

018°30.000'E

Danger No

Display I+N

Save Cancel

← → ▲ ▼ to select

ENT to enter

ESC to cancel

#### Editing a waypoint from the waypoints window

- 1 In the waypoints window, press **▲** or **▼** to highlight the waypoint to edit. Press **MENU** and select **Edit**.
- 2 Change the waypoint data (see section 5-2-7).

### 5-2-4 Displaying a waypoint on the chart

This goes to the chart window, and shows the selected waypoint at the center of the window.

- 1 In the waypoints window, press **▲** or **▼** to highlight the waypoint to display. Press **MENU** and select **Display**.  
Or, in the Chart window, press **MENU**, select **Find**, then select **Waypoints**. Select a waypoint from the list.

- 2 The 657 switches to the chart window, with the selected waypoint at the center of the chart.

### 5-2-5 Deleting a waypoint

A waypoint can not be deleted if the boat is navigating to it or if the waypoint is used in more than one route. A waypoint that is used in one route can be deleted.

### WARNING

When a waypoint is deleted from a route, check that the changed route does not cross land or dangerous waters.

### Deleting a waypoint from the chart window

- 1 In the chart window, move the cursor to the waypoint to delete.
- 2 Press **MENU** and select Delete.
- 3 Select Yes to confirm.

### Deleting a waypoint from the waypoints window

- 1 In the waypoints window, press **▲** or **▼** to highlight the waypoint to delete. Press **MENU** and select Delete.
- 2 Select Yes to confirm.

### 5-2-6 Deleting all waypoints

- 1 In the waypoints window and press **MENU** and select Delete all.
- 2 Select Yes to confirm.

### 5-2-7 Changing a waypoint's data

To change the waypoint data when it is displayed in a window:

- 1 Select the data to change.  
Press **ENT**.  
Use the cursor keys to change the data.  
Press **ENT**.

- 2 If necessary, repeat the above step to change other data.
- 3 Select Save.

### 5-2-8 Sort Waypoints

To change how the waypoints list is displayed:

- 1 Press **MENU** and select Sort by.
- 2 Select how to display the list:  
Name: In alphabetical order by name.  
Icon: Grouped by icon type.  
Distance: In order of distance from the boat.

An arrow at the top of a column indicates how the waypoints are sorted.

### 5-2-9 Navigating to a waypoint

See section 3-1-2.

## 6 Navigation: Routes

A route is a list of waypoints that the boat can navigate along. Routes can be created, changed and deleted.

The 657 can have up to 25 routes. Each route can have up to 50 waypoints.

A route can:

- Start and stop at the same waypoint .
- Include waypoints more than once.

The 657 can navigate along a route in either direction. Waypoints on the route can be skipped.

Routes are a powerful feature when the 657 is connected to an autopilot, allowing the vessel to be automatically guided along the route.



**WARNING**

Make sure the course does not pass over land or dangerous waters.

## 6-1 Routes window

The routes window is a list of the routes that have been entered, each with route name, start waypoint, end waypoint, number of legs and total distance.

To go to the routes window, press **DISP**, select **More**, then select **Routes**.

If there are more routes than will fit on the display, press **+** or **-** to scroll up or down a page at a time.

Routes		
Name	Start	End
AKLDEMO	AKL0	AKL4
AMSDEMO	AMS0	AMS3
CAEDEMO	CAE0	CAE4
CPTDEMO	CPT0	CPT4
GOADEMO	GOA0	GOA4
LRHDEMO	LRH0	LRH4
OSLDEMO	OSL0	OSL5
SFODEMO	SFO0	SFO5
SOUDEMO	SOU0	SOU4
SYDDEMO	SYD0	SYD4

to page up/down

## 6-2 Managing routes

### **⚠ WARNING**

After creating or changing a route, display the route on the chart and check that it does not cross land or dangerous water.

### 6-2-1 Creating a new route

#### A. Creating a new route from the chart window

While creating the route:

- Press **+** or **-** to change the range; scroll the chart by moving the cursor to the edge of the chart.
  - A data box at the bottom left of the display shows the route name and total distance. If the cursor is near a leg, it shows the length and bearing of the leg as well.
  - The legs of a route must start and end at waypoints. If a leg does not start or end at an existing waypoint then a new waypoint will be created automatically (to change the new waypoint data, see section 5-2-7).
  - You can not use a Danger waypoint in a route.
- In the chart window, press **MENU** and select **New route**.
  - The route is given a default name:

- Change the name if necessary.
  - Select **OK**.
- To enter the legs of the route:
    - Move the cursor to the start of the route and press **ENT**.
    - A waypoint is created with a default name. to save this waypoint press enter, to edit the waypoint refer to 5-2-7
    - Press **ENT** a dotted leg line is displayed from the cursor to the previous waypoint
    - Move the cursor to the end of the first leg and press **ENT**.
    - Repeat i to iv until the last waypoint in the route is placed and saved
    - Press **ESC** to complete the route
- Menu options while creating a route:
- To add a waypoint to the route
    - Press **MENU** and select **Add**.
  - To insert a waypoint in the route by breaking one leg into two:
    - Move the cursor to the leg you want to break.
    - Press **MENU** and select **Insert**.
    - Move the cursor to where the new route waypoint will be.

- iv Press **ENT**.
- 3 To move a waypoint in the route:
  - i Move the cursor to the waypoint to move.
  - ii Press **MENU** and select Move.
  - iii Move the cursor to where the waypoint will be.
  - iv Press **ENT**.
- 4 To remove a waypoint from the route:
  - i Move the cursor to the waypoint to remove from the route.
  - ii Press **MENU** and select Remove. The waypoint is removed from the route, but the waypoint is not deleted.
- 5 To start navigating the route
  - i Press **MENU** and select Start
- 6 To end creating the route
  - i Press **MENU** and select End
- 7 To delete the route
  - i Press **MENU** and select Delete
  - ii Select yes to confirm.

 **Tip:** The distance and bearing calculator can also be used to enter a course and save it as a route (see section 3-3).

## B. Creating a new route from the routes window

- 1 In the routes window, press **MENU** and select Create.
- 2 A new route, with a default name and no waypoints, is displayed.
- 3 To change the route name:
  - i Select the route name at the top of the display and press **ENT**.
  - ii Change the name if necessary.
  - iii Press **ENT**.
- 4 To insert a waypoint in the route:
  - i Select where the waypoint will be:
    - To insert the first waypoint in a new route, select Leg 1.
    - To insert a waypoint at the end of the route, select the unused leg at the end of the list of waypoints.
    - Otherwise, select the waypoint to insert the new waypoint in front of.

- ii Press **ENT**. A list of waypoints is displayed. Select the waypoint to use.
- As waypoints are inserted, the distance and bearing of each leg is shown automatically. If the route has more waypoints than will fit on the display, press **▲** or **▼** to see them.
- 5 To remove a waypoint from the route:
    - i Select the waypoint to remove.
    - ii Press **MENU** and select Remove.
  - 6 Repeat this process until the route is finished.
  - 7 Press **ESC**.
  - 8 Display the route on the chart (see section 6-2-3) and check that the route does not cross land or dangerous water.

## 6-2-2 Editing a route

### Editing a route from the chart

- 1 In the routes window, select the route to edit. Press **MENU** and select Edit on chart.
- 2 The selected route is displayed on the chart, with a circle around the first waypoint.
- 3 Edit the route as described in section 6-2-1 A, starting at step 4.

### Editing a route from the routes window

- 1 In the routes window, press **▲** or **▼** to highlight the route to edit. Press **MENU** and select Edit.
- 2 The selected route is displayed: the route name and a list of the waypoints.
- 3 Edit the route as described in section 6-2-1 B, starting at step 3.

## 6-2-3 Displaying a route on the chart

To view the selected route at the center of the display:

- 1 In the routes window, press **▲** or **▼** to highlight the route to display. Press **MENU** and select Display.
- Or, in the Chart window, press **MENU**, select Find, then select Route. Select a route from the list.
- 2 The 657 displays the selected route on the chart.

### 6-2-4 Deleting a route

- 1 In the routes window, press **▲** or **▼** to highlight the route to delete. Press **MENU** and select **Delete**.
- 2 Select **Yes** to confirm.

### 6-2-5 Deleting all routes

- 1 In the routes window, press **MENU** and select **Delete all**.
- 2 Select **Yes** to confirm.

### 6-2-6 Navigating a route

See section 3-1-3.

## 7 Satellites

---

### GPS worldwide navigation

The US Government operates the GPS system. Twenty-four satellites orbit the earth and broadcast position and time signals. The positions of these satellites are constantly changing. The GPS receiver analyses the signals from the closest satellites and calculates exactly where it is on earth. This is called the GPS position.

The accuracy of the GPS position is typically better than 10 m (33 ft) for 95% of the time. A GPS antenna can receive signals from the GPS satellites when it is almost anywhere on earth.

### DGPS

A DGPS system uses correction signals to remove some of the errors in the GPS position. The 657 can use one of two types of DGPS system:

- **WAAS and EGNOS DGPS**

WAAS and EGNOS are two satellite based DGPS systems. The correction signals are broadcast by satellites and are received by the 657's standard GPS antenna. The accuracy of the corrected GPS position is typically better than 5 m (15 ft) for 95% of the time.

WAAS covers all of the USA and most of Canada. EGNOS will cover most of Western Europe when it becomes operational.

- **Differential beacon DGPS**

Differential beacons are land based radio transmitters that broadcast correction signals that can be received by a special receiver on the boat. Differential beacons are usually only installed near ports and important waterways, and each beacon has a limited range. The accuracy of the corrected GPS position is typically better than 2 to 5 m (6 to 16 ft).

### GPS receiver

Northstar GPS units have a sensitive 12-channel receiver, which tracks signals from all GPS satellites visible above the horizon and uses measurements from all satellites more than 5° above the horizon to calculate the position.

Each time a GPS receiver is turned on, it normally takes about 50 seconds before it outputs the first position. Under some circumstances it will take up to two minutes or longer.

## 7-1 Satellite window

The satellite window has information about the GPS satellites and GPS position.

To go to the satellite window, press **DISP**, select **More**, then select **Satellite**.

**The satellite window shows:**

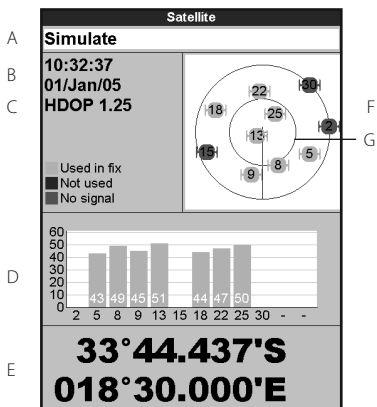

- A Status of GPS antenna, for example Acquiring, GPS fix, No GPS. If the unit is in Simulate mode it displays Simulate (see section 2-6).
- B Time and date from GPS satellites. Time is local time (UTC [GMT] plus local offset, see section 17-13)
- C HDOP: The error in the GPS position caused by satellite geometry. A low value indicates a more precise fix, a high value a less precise fix
- D Signal strengths of up to twelve visible GPS satellites. The higher the bar the stronger the signal
- E Boat position
- F Positions of visible GPS satellites:
  - Outer circle is horizon
  - Inner circle is 45° elevation
  - Center is directly above
  - North is at top of display
- G If the boat is moving, COG is a line from center

## 8 Sonar fishfinding: Introduction

Sonar functions require an optional sonar transducer to be installed and set up.

This section explains how to interpret the sonar displays, when and why to use the different frequencies and how fish are detected and displayed.

### 8-1 Using the 657

The 657 uses a sonar transducer attached to the hull. The transducer generates an ultrasonic pulse (sound that is above the hearing range of the human ear), which travels down towards the bottom at a speed of about 4800 ft/sec (1463 m/sec), spreading out into a cone shape.

When the pulse meets an object, such as a fish or the bottom, it is partly reflected back up towards the boat as an echo. The depth of the object or bottom is calculated by the 657 by measuring

the time taken between sending a pulse and receiving the echo. When an echo has been returned, the next pulse is sent.

The 657 converts each echo into an electronic signal, displayed as a vertical line of pixels. The most recent echo appears on the extreme right of the display, with the older echoes being scrolled towards the left, eventually disappearing off the display.

The scroll speed depends upon the water depth and scroll speed setting. See sections 17-3 and section 8-2, for more information.

The appearance of echoes displayed are affected by:

- the 657 settings (see sections 17-3, 8-5 and 8-6)
- echoes (different fish types, different bottom types, wrecks and seaweed; see section 8-2)
- noise (water clarity and bubbles; see section 8-2).

### ***Cruising, Fishing and Manual Modes***

The 657 has three sonar operating modes:

- **Cruising mode:** Use this when on the move. The 657 automatically adjusts its settings to compensate for water clarity and to display the bottom.

- **Fishing mode:** Use this when fishing. The 657 automatically adjusts its settings to compensate for water clarity and to best display fish, the bottom and other details.
- **Manual mode:** Use this to fine-tune the 657 settings by hand. Best results are often achieved in manual mode, but practice and experience are required to obtain the optimum settings for different conditions.

For more information about modes, see sections 8-5 and 8-6.



Use the automatic Cruising or Fishing modes when learning to use the 657 or when travelling at speed.

## ***8-2 Interpreting the display***

The sonar displays do not show a fixed distance travelled by the boat; rather, they display a history, showing what has passed below the boat during a certain period of time.

The history of the sonar signal displayed depends the depth of the water and the scroll speed setting.

In shallow water, the echoes have a short distance to travel between the bottom and the boat. In deep water, the history moves across the display more slowly because the echoes take longer to travel between the bottom and the boat. For example, when the scroll speed is set to Fast, at depths over 1000 ft (300 m) it takes about 2 minutes for the data to move across the display, whereas at 20 ft (6 m) it takes only about 25 seconds.

The scroll speed can be set by the user to display either a longer history with less fish information or a shorter history with more fish details (see section 17-3).

If the boat is anchored, the echoes all come from the same area of bottom. This produces a flat bottom trace on the display.

The screen shot shows a typical sonar display with the Fish symbols turned Off.

### ***Strength of echoes***

The colours indicate differences in the strength of the echo. The strength varies with several factors, such as the:

- Size of the fish, school of fish or other object.
- Depth of the fish or object.
- Location of the fish or object. (The area covered by the ultrasonic pulse is a rough cone shape and the echoes are strongest in the middle.)
- Clarity of water. Particles or air in the water reduce the strength of the echo.
- Composition or density of the object or bottom.

**Note:** Planing hulls at speed produce air bubbles and turbulent water that bombard the transducer. The resulting ultrasonic noise may be picked up by the transducer and obscure the real echoes.



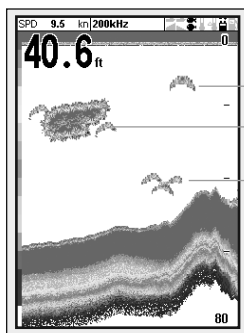

- A Single fish
- B Large school of fish
- C Small school of fish
- D Bottom

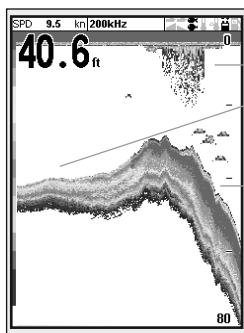

- A Kelp / Weed
- B Soft bottoms such as mud, weed and sand show as narrow bands
- C Hard bottoms such as rock or coral show as wide bands

### Bottom types

Mud, weed and sandy bottoms tend to weaken and scatter the sonar pulse, resulting in a weak echo. Hard, rocky or coral bottoms reflect the pulse, resulting in a strong echo.

### Frequency and cone width

The sonar pulse generated by the 657 transducer travels down through the water, spreading outwards in a cone shape. The cone width is dependent upon the frequency of the pulse; at 50 kHz it is approximately 45°, and at 200 kHz it is approximately 11°.

The differences in the cone width affect what is displayed. See section 8-3.

Water Depth	Cone width at 50 kHz	Cone width at 200 kHz
25	20	5
50	40	10
100	80	20
150	130	30
200	170	40
300	250	60
400	330	80
600	500	120
800	660	150
1000	830	190

45° cone

11° cone

## Shadows

Shadows are created around areas where the ultrasonic beam cannot 'see'. These areas include hollows on the bottom or beside rocks and ledges, where the strong echoes returned off the rocks obscure the weak echoes of the fish and may also create a double bottom trace. See following for an example of the sonar display in such an environment. A double bottom trace is shown on the display.

When looking for fish with the wide angled 50 kHz frequency, be aware of increased shadows. Use the high frequency 200 kHz in areas that have rocks and ledges because this frequency reduces the shadow effect considerably.

### Example of shadows

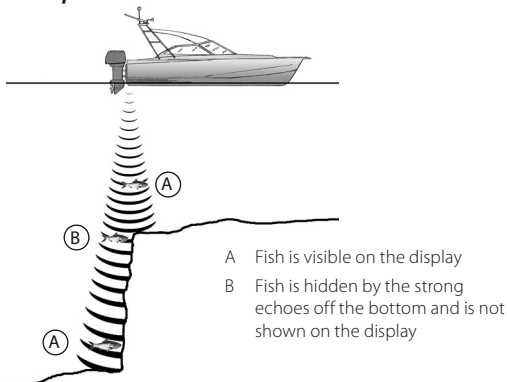

### Sonar display of same area

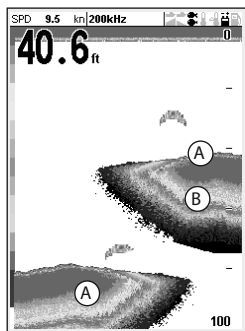

## 8-3 Single and Dual frequency fishfinding

### Sonar frequencies

The 657 has two sonar frequencies, 200 kHz and 50 kHz. To select the sonar frequency to use:

- 1 Go to a sonar display (see section 9).
- 2 Press **MENU**, select **F**requency and select 200 kHz, 50 kHz, or **M**ixed.

### When to use 200 kHz

The 200 kHz frequency is especially suitable for use in shallow and medium depth water, typically less than 500 ft (150 m) and while running at speed.

At 200 kHz, the narrow cone reduces any noise caused by air bubbles.

The 200 kHz frequency generates a higher definition pulse which produces little shadow and returns excellent detail over a small area of bottom. Therefore, it gives excellent bottom

discrimination capability and is particularly good at showing individual fish, including bottom dwellers.

### When to use 50 kHz

The 50 kHz frequency is particularly suitable for use in deep water, typically greater than 500 ft (150 m).

At 50 kHz, the cone covers an area of water about four times wider than the 200 kHz cone and penetrates to a greater depth with minimal loss of the return signal.

However, it produces a lower definition display with more shadow compared to the 200 kHz frequency. This means that a group of small fish, for example, could be displayed as a single item, while any fish very close to the bottom may not be found at all.

This frequency is useful for getting a deep, wide overview of the area so that any areas of interest can be identified and then examined in detail with the 200 kHz frequency.

### ***When to use Mixed***

The Mixed frequency combines the 200 kHz and the 50 kHz echoes on one sonar display, filling in detailed echoes in the center of the sonar cone.

### ***When to use 50/200 kHz***

Operating the 657 at both 50 kHz and 200 kHz simultaneously on a split display can be very useful when operating in shallow to medium water, typically less than 500 ft (150 m), because the 50 kHz section of the display shows the general area, while the 200 kHz section can be viewed simultaneously for a more detailed look at any interesting feature.

To use 50/200 kHz, select the Split 50/200 display (see section 9-4).

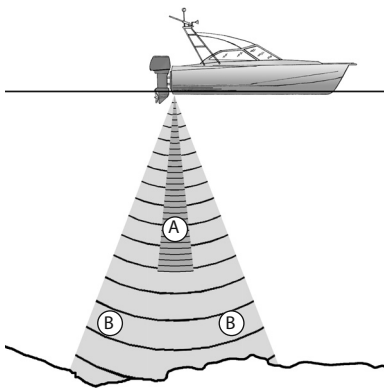

- A Narrow angle, more detailed 200 kHz cone
- B Wide angle, less detailed 50 kHz cone

**Comparison of the same fish scenario displayed at different frequencies:**

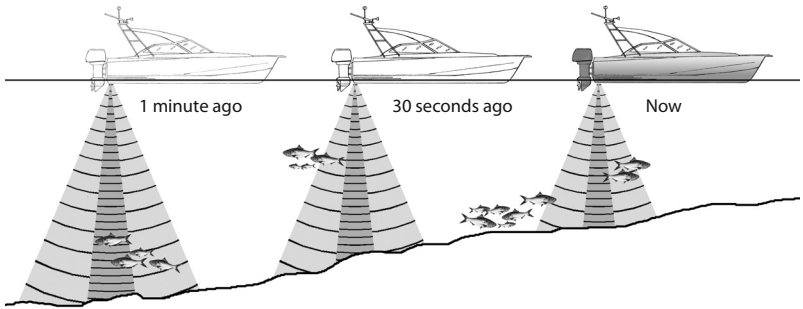

**50 kHz display**

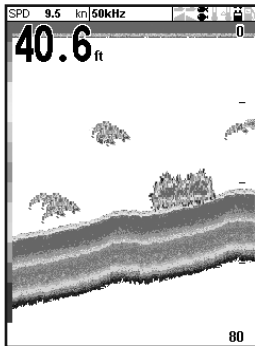

**200 kHz display**

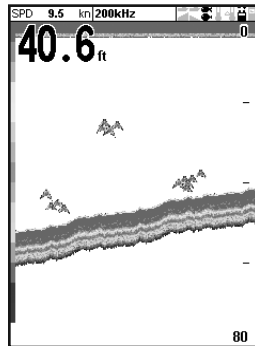

**200/50 KHz display**

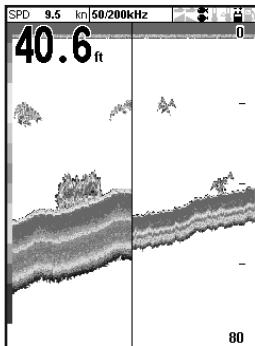

**Mixed display**

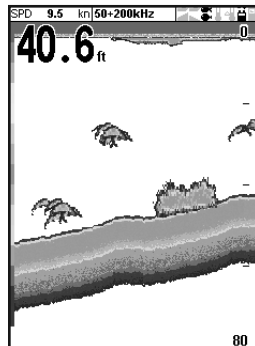

## 8-4 Fish detection and display

### Where to find fish

Underwater features like reefs, wrecks and rocky outcrops attract fish. Use the 50 kHz or 50/200 kHz frequency display to find these features, then look for fish by passing over the feature slowly several times using the Zoom display (see section 9-2). If there is a current, the fish will often be found downstream of the feature.

When fishing with the 657 with the Fish symbols  $\text{O} \text{E} \text{E}$ , a weak fuzzy band may appear between the bottom trace and surface. This might indicate a thermocline - a rapid change in water temperature, such as the edge of a warm or cold current. The temperature difference can form a barrier which the fish may not swim through. In fresh water, fish often collect around a thermocline.

### Fish symbols

The 657 uses Northstar's SBN II technology to analyse sonar echoes and identify which are likely to be fish. The 657 can be set up to display a fish symbol and the depth over these echoes (see section 17-3, Fish symbols). While SBN is very sophisticated it is not foolproof - there will be times when the 657 will not be able to differentiate between fish and large air bubbles or rubbish.

Depending on the strength of a fish signal, the 657 can display a small, medium or large symbol (see section 17-3, Fish filter).

To see the maximum amount of information from the echoes, turn Fish symbols off. Fish appear as arches on the display.

### Fish arches

In good conditions, a fish passing through the cone-shaped ultrasonic pulse is displayed as a fish arch. The 50 kHz frequency uses a wider cone than the 200 kHz frequency. This makes the fish arches easier to see.

A fish arch starts when a fish enters the weak edge of the sonar cone, generating a weak echo that is displayed as the start of the fish arch. As the fish moves closer to the middle of the cone, the distance between the transducer and the fish reduces and the echo is displayed at progressively shallower depths, producing a rising shape. When the fish passes directly beneath the middle of the cone, the echo becomes strongest and thickest. As the fish passes out of the middle of the cone the reverse happens with a progressively weaker and deeper echo.

There are many reasons why fish arches may not be seen. For example:

- Poor transducer installation (see *Transom Transducers Installation Guide*).
- If the boat is anchored then fish will tend to show on the display as horizontal lines as they swim into and out of the transducer sonar beam. Slow speeds in deeper water give the best fish arch returns.
- Range is important. It will be much easier to see fish arches when using zoom mode to concentrate on a particular section of water, rather than just displaying everything from the surface to the bottom. Zooming increases screen resolution and is necessary for good fish arches.
- It is difficult to get fish arches in shallow water as the transducer sonar beam is very narrow near the surface and fish do not stay within the beam long enough to display an arch. Several fish in shallow water tend to display as randomly stacked areas of color.
- Wave motion may result in distorted fish arches.



Fun fish symbol



Normal fish symbol



Fun symbol + depth



Fish arch + depth

## 8-5 Range

Range is the vertical depth displayed on the 657 sonar display. For example, if the range is 100 m, then the sonar display shows depths between 0 and 100 m. The range is displayed at the bottom, right corner of a sonar display.

The 657 has two range modes:

**Auto:** The 657 adjusts the range automatically so that the bottom of the water is always shown at the bottom of the display. Auto range is recommended for normal operation.

To set Auto mode:

- 1 Go to a sonar display (see section 9).
- 2 Press **MENU**, select **Range** and select **Auto**.

**Manual:** The 657 does not adjust the range automatically. If the bottom depth is below the range, the bottom will not appear on the display. Manual range is useful if the bottom depth changes rapidly, because Auto range will cause the display to change range frequently.

To set Manual range or to change the range:

- 1 Go to a sonar display (see section 9).
- 2 Either press **+** to increase range or press **-** to decrease range

### **WARNING**

Use the Auto range when learning to use the 657 or when travelling at speed.

### **Zoom range and offset**

The sonar Zoom and Bottom displays can show a magnified part of the range (see sections 9-2 and 9-3).

## 8-6 Gain and threshold

Gain and threshold settings control the amount of detail displayed on a sonar display:

**Gain:** The gain of the sonar receiver. The gain should be high to display good detail, but if the gain is too high then information from the strong bottom signal is lost and false echoes might be displayed. There is a separate gain setting for each sonar frequency, 50 kHz and 200 kHz.

**Threshold:** Return echoes less than the threshold are ignored. The threshold should be as low as possible, but if the threshold is too low, unwanted noise will be displayed. Threshold is set as a percentage of gain. For example, if the threshold is 50 %, then return echoes less than 50 % of the maximum signal are ignored. There is a separate threshold setting for each sonar frequency, 50 kHz and 200 kHz.

### The gain window

To display or change the current settings for gain, select a sonar display and press **ENT**. Select **Threshold** to display the thresholds.

Gain	
Mode	Manual
200kHz	13
50kHz	13
Threshold	<input checked="" type="checkbox"/>
200kHz	15%
50kHz	15%

This display is called the gain window.

### Changing mode

The 657 has three operating modes. In Cruising and Fishing modes, the 657 automatically adjusts gain and threshold for good performance. In manual mode, you can hand adjust the settings.

To change the mode from the Gain window, Select **Mode** and then select **Fishing**, **Cruising** or **Manual**. When you select **Manual**, the 657 reverts to your last manual settings.

### Changing gain and threshold

- 1 In the Gain window, press **▲** or **▼** to select the setting to adjust.
- 2 Press **◀** or **▶** adjust the setting. The 657 changes to Manual mode.

**Tip:** Use the A-scope window to help set gain or threshold manually (see section 9-5).

## 9 Sonar fishfinding: Displays

To show the Sonar display, press **DISP** then select Sonar.

There are five kinds of sonar display. To use a display, press **MENU**, select Sonar splits, then select the type of display to use:

**No split:** Sonar history display at a single or mixed frequency (see section 9-1).

**Split zoom:** Sonar history plus a zoomed section (see section 9-2).

**Full screen zoom:** See section 9-2.

**Split bottom:** Sonar history plus a bottom trace in a zoomed section (see section 9-3).

**Split 50/200:** Sonar histories at 50 and 200 kHz (see section 9-4).

**Split A-Scope:** Sonar history plus echo strength (see section 9-5).

If the display is split, adjust the split ratio if required:

- 1 Press **MENU** and select Sonar display split.
- 2 Press **←** or **→** to adjust the ratio.
- 3 Press **ENT**.

Options	
Sonar splits	No Split
Frequency	No Split
Gain	Split Zoom
Range	Full screen zoom
A-Scope	Split Bottom
<b>MENU</b> for setup	Split 50 / 200
	Split A-Scope

### 9-1 Sonar history display - no split

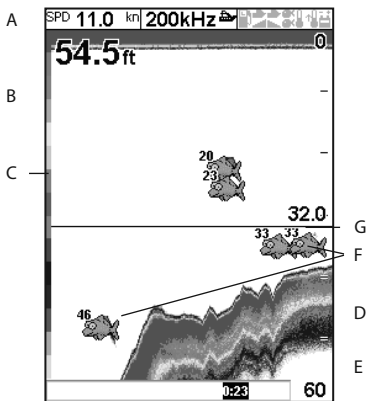

- A Optional data header (see section 2-7-3)
- B Depth
- C Color bar
- D Bottom
- E Range
- F Fish symbols with depth
- G Depth line

The window scrolls from right (most recent echoes) to left (oldest echoes).



### 9-1-1 Extended history mode

To review an old sonar echo, use ◀ or ▶ to move back and forward through the sonar history. The time since the echoes shown on the screen were recorded is displayed at the bottom of the screen. Press **ESC** to return to the most recent echo.

The digital depth shown is always the current depth, even in extended history mode.

The History Position Bar indicates the age of the most recent echo on the screen, and the position of the current screen in the recorded history.

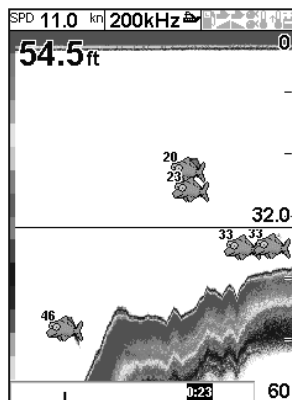

History position bar

### 9-2 Sonar Zoom and Full Screen Zoom displays

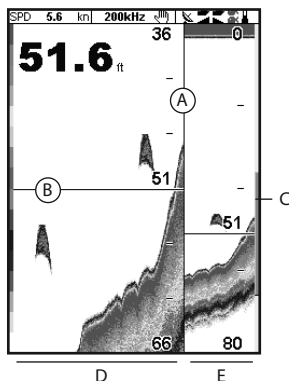

- A Divider line
- B Depth line marks the center of the zoomed area
- C Zoom bar
- D Zoom section
- E Sonar history

These windows show a zoomed section of the sonar history. The Sonar Zoom display shows the sonar history on the right and the zoomed section on the left. The Full Screen Zoom display shows the zoomed section only.

The zoom bar on the far right shows the area of the history that is magnified in the zoom section:

- Press ◀ or ▶ to adjust the zoom range (the range of depths included in the zoom section).
- If **Bottom lock** is on, the zoom depth (the depth of the zoom section) is adjusted automatically so that the bottom is always displayed in the zoom section.

If **Bottom lock** is off, press ▲ or ▼ to manually adjust the zoom depth.

#### Bottom lock

To turn **Bottom lock** on or off:

- 1 Press **MENU** and select **Bottom lock**.
  - 2 Select **On** or **Off**.
- or If **Bottom lock** is on, pressing ▲ or ▼ will turn it off.

### 9-3 Sonar Bottom display

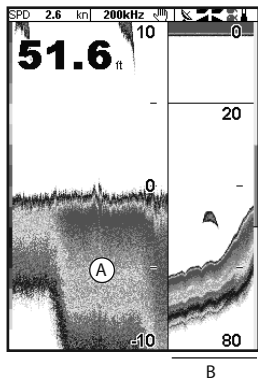

- A Zoomed bottom signal
- B Sonar history

The display shows the sonar history on the right and the bottom signal as a flat trace in the center of the zoom section on the left. The flat trace make it easy to compare the echo strengths shown in the bottom signals. This can help to identify the type of bottom and objects close to the bottom.

The zoom bar on the far right shows the area of the history that is magnified in the zoom section:

- Use the ◀ or ▶ keys to adjust the zoom range.
- The 657 calculates the zoom depth automatically.

It is not necessary to turn Bottom lock on for this display.

### 9-4 Sonar 50/200 display

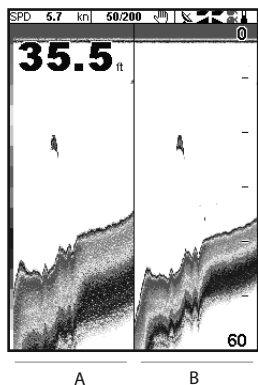

- A
- B

The display shows:

- A the 50 kHz sonar history on the left
- B the 200 kHz sonar history on the right.

Gain can be set independently for each frequency (see section 8-6). Range applies to both frequencies (see section 8-5).

## 9-5 Sonar A-Scope display

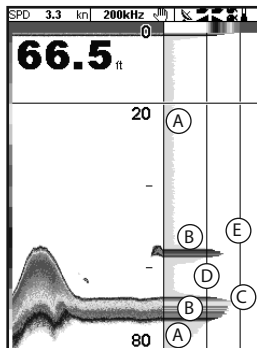

The display shows the sonar history on the left and the A-Scope display on the right. The A-Scope shows:

- A, B, C The strengths of echoes being received now from different depths - the longer the horizontal line the stronger the signal:
  - A Unwanted noise echoes.
  - B Echoes from fish and the bottom
  - C The strongest echo, usually from the bottom
- D A vertical line showing the threshold, the weakest echo to display on the sonar history
- E A vertical line showing the gain setting; echoes above this strength will display as the maximum signal strength

Use the A-Scope while adjusting the gain and threshold settings manually (see section 8-6).

### Setting gain and threshold

It is convenient to use the A-scope display when adjusting gain and threshold manually. Follow this procedure to adjust gain and threshold for normal circumstances:

- 1 Switch to a sonar display (see section 9). If necessary, press **+** or **-** to adjust range so that the bottom is displayed.
- 2 If necessary, select the sonar frequency to adjust the settings for. Press **MENU**, select **FREQUENCY** and select 200 kHz or 50 kHz.
- 3 Press **MENU**, select Sonar splits then select Split A-scope.
- 4 Press **ENT** to display the Gain window. To adjust gain or threshold for a frequency, press **▲** or **▼** to select the setting to adjust, then press **◀** or **▶** to change the setting.
- 5 Set threshold to zero.
- 6 Adjust Gain so the peak of the strong signal from the bottom just touches the gain line.
- 7 Adjust threshold so that it is just to the right of the noise.

- 8 Press **ESC** to close the gain window.
- 9 If required, repeat these steps to adjust gain and threshold for the other frequency.

**Note:** Setting the gain higher will display more detail from weak echoes, like fish, but will lose detail from the strong echo from the bottom.

### Fish recognition

The echo strengths shown on the A-scope can be useful in recognising the type of fish. Different species of fish have different sizes and shapes of swim bladders. The air in the swim bladder reflects the ultrasonic pulse, so the strength of the echo varies between fish species according to the size and shape of the swim bladder.

When catching fish from a school, note the species and the strength of the echo that it returns on the A-scope. Then, when that particular echo is seen again, it is likely to be the same fish species.

### Bottom type

The shape of the echo strengths in the A-Scope can help you to recognise the type of bottom.

## 10 Gauges window

The Gauges window shows boat data, such as water speed, as analog gauges. To select the Gauges window, press **DISP**, select More, then select Gauges. Before using the Gauges window, set Speed range, Max RPM and Max fuel flow (see section 17-12).

### Selecting a Gauges layout

To select a layout from the Gauges window, press **MENU**, select Layout, then select a layout from the list.

### Changing a gauge layout

You can change the data displayed on each gauge in a layout.

- 1 Select the layout to change (see above).
- 2 Press **MENU** and select Gauge setup.
- 3 Highlight the gauge to change. Press **ENT** and select the data to display in the gauge.
- 4 Repeat the above step to change other gauges.
- 5 Press **ESC**.

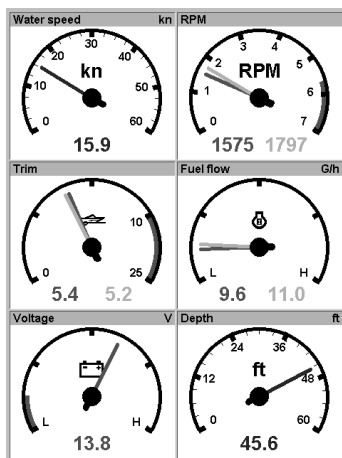

## 11 Data window

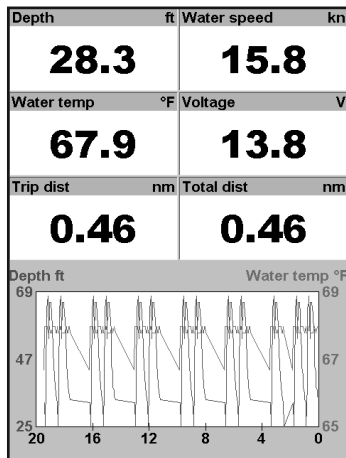

The data window has large numeric data fields and a graph of depth and water temperature if available. To go to the data window, press **DISP**, select More, then select Data.

To select what data is displayed:

- 1 Press **MENU** and select Data setup.
- 2 Change a data field:
  - i Press the cursor keys to highlight the field.
  - ii Press **ENT** to display a menu of data items.
  - iii Select a data item that is available on your system or select None to leave the field empty.
- 3 Repeat the above step to set the other data fields.
- 4 Press **ESC**.

## 12 Fuel functions and display

The Fuel functions require optional petrol/gasoline or SmartCraft™ fuel sensors to be installed and set up.

### 12-1 What the fuel computer does

Each engine has a flow sensor installed to measure the engine's fuel flow.

The 657 uses these flows, together with boat speed and engine RPM if available to estimate the fuel remaining in the tank(s), fuel used, range and fuel economy. This data is displayed on the fuel window (see section 12-2).

You can:

- display the fuel used during a trip (see section 12-2)
- set low fuel alarms (see section 12-4)
- make fuel consumption curves - graphs of fuel consumption and boat speed as a function of engine RPM - to monitor and optimise boat performance. (see section 12-6)

### WARNING

To ensure the fuel data is accurate:

- When you add or remove fuel from a tank, tell the 657 (see section 12-3)
- If the boat has petrol/gasoline sensors, calibrate them during installation or if the fuel readings seem inaccurate (see section 12-7)
- Choose an appropriate type of boat speed sensor to calculate economy, range and the fuel consumption curve (see section 12-5)
- If the boat uses a paddlewheel sensor to measure speed, calibrate it during installation or if the speed readings seem inaccurate.

### 12-2 Fuel window

To go to the Fuel window, press **DISP**, select **More**, then select **Fuel**.

The display differs according to the number of engines and tanks. If engine RPM is available and if you have made and selected a Fuel Consumption Curve (see section 12-6), press **▶** to switch between a Summary or a Fuel curve display.

#### The Fuel window shows

##### Speed

To select a boat speed sensor, see section 12-5-1.

##### RPM (if available)

If engine RPM is not available, the display shows depth.

##### Remaining

The fuel remaining in the tank(s) is shown as a vertical gauge on the right of the display. The height of the yellow bar(s) show how much fuel remains in the tank(s). If you have set a low fuel

alarm (see section 12-4), a red bar shows the level at which the alarm will trigger. If there are two tanks, the left bar shows the port tank, the right bar shows the starboard tank.

##### Used

The fuel used during a trip. On a multi-engine boat, the data for the port engine is on the left of the display.

When you want to start measuring how much fuel is used, go to the Fuel window and:

- In a single engine boat, press **MENU** and select **Clear used**.
- In a multi-engine boat, the fuel used by each engine and the total fuel used are shown. Press **MENU**, select **Clear used** and select:
  - **Port or Starboard** to clear the fuel used by one engine
  - **Both** to clear the total fuel used.

## Fuel window

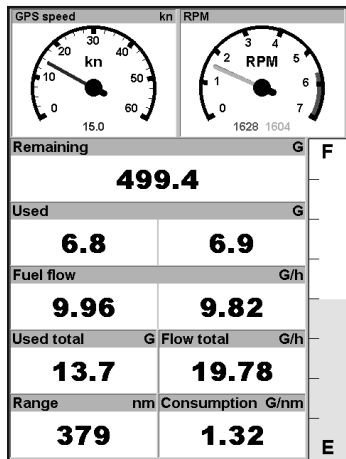

## Fuel flow

The fuel flow for the engine(s). On a multi engine boat, the data for the port engine is on the left of the display. Use the flows to check the load of each engine.

## Range

The estimated boat range at the current fuel flow. The value can depend on the type of speed sensor (see section 12-5).

## Economy

The distance travelled per unit of fuel used. The value can depend on the type of speed sensor (see section 12-5). The larger the value, the better the fuel economy. Adjust the throttle and trim to achieve the best economy.

## Fuel consumption curve

A graph of fuel consumption and boat speed as a function of engine RPM. Use the curve to monitor and optimise boat performance (see section 12-6).

### 12-3 When you add or remove fuel

When you add or remove fuel, you must tell the 657, otherwise the fuel data will be meaningless.

#### A When you completely fill a tank

Go to the fuel window and press **MENU**.

Then:

- On a single-tank boat, select **Fill tank**.
- On a multi-tank boat, select **Fill tank**, then select the tank you have filled.

**Note:** Underfloor fuel tanks are often difficult to refill to the same level twice, due to air pockets.

#### With underfloor fuel tanks:

- Trim the boat to the same angle in the water each time you follow procedure A.
- Mostly use procedure B below when adding fuel, but completely fill the tank and follow procedure A about every tenth time you add fuel.

#### B When you partially fill a tank

- 1 Add fuel to a tank and write down how much fuel you add.
- 2 From the Fuel window, press **MENU** and select **Add fuel**.
- 3 On a multi-tank boat, select the tank that you have added fuel to.
- 4 Change the number to the amount of fuel that you added.

**Note:** If you follow procedure B every time you add fuel, then a small error will accumulate, because it is hard to measure exactly how much fuel you add. To avoid this, completely fill the tank and follow procedure A about every tenth time you add fuel.

### C When you remove fuel

- 1 Before removing fuel, go to the Fuel window, press **MENU** and select **Set remaining**.
- 2 On a multi-tank boat, select the tank that you are removing fuel from.
- 3 Write down the value of Remaining for the tank; this is the amount of fuel originally in the tank.
- 4 Remove fuel from the tank and write down how much fuel you remove.
- 5 Subtract the amount of fuel you removed from the amount of fuel originally in the tank to calculate the amount of fuel now in the tank.

- 6 Change the number on the Set Remaining menu to the amount of fuel that you calculated was now in the tank.
- 7 Press **ENT**

**Note:** You can also use this procedure when you add fuel to a tank. In this case, add the fuel you have added to the amount of fuel originally in the tank to calculate the amount of fuel now in the tank.

## 12-4 Low fuel alarm

---

To set a low fuel alarm for a tank:

- 1 Press **MENU** twice, select **Fuel** then select **Setup tanks**.
- 2 On a multi-tank boat, select the tank to set the alarm for.
- 3 Select **Tank alarm** and enter a fuel level to trigger the low fuel alarm.

When a low fuel alarm is set, the alarm's fuel level is shown on the fuel window tank levels as a red bar. The alarm can also be set using the Alarms setup menu (see section 17-9)

## 12-5 Boat speed sensors

---

### 12-5-1 Selecting a boat speed sensor

The fuel calculations can use boat speeds from the GPS, or from a paddlewheel sensor or pitot sensor if these optional sensors are installed:

- Paddlewheel and pitot sensors measure the speed through the water; GPS speed is speed over ground; these sensors can give different values for Range, Economy and the fuel consumption curves (see section 12-5-2).
- A pitot sensor is more accurate than a paddlewheel sensor at high speeds but is not accurate at low speeds. A paddlewheel sensor is more accurate than a pitot sensor at low speeds.

### To select an optional speed sensor

- 1 Press **MENU** twice, select **Fuel** and select **Speed source**.
- 2 To use a paddlewheel or pitot sensor, select **Water speed**, otherwise select **Ground speed** to use GPS speed.
- 3 If you selected **Water speed** and you have both a paddlewheel sensor and a pitot sensor:
  - i Press **ESC**, select **SmartCraft** and select **Speed type**
  - ii Select **Paddlewheel** or **Pitot**.

**Tip:** You can select a different speed sensor during a trip.

### 12-5-2 Water speed and ground speed

A paddlewheel sensor and a pitot sensor measure water speed, the boat speed through the water. A GPS measures ground speed, the boat speed over the bottom of the water. If there is a current, then these speeds will be different, and the log, trip log, economy and range will be different, as shown below.

Water speed is better for measuring the boat's potential performance. Ground speed is better for going to a destination because it takes currents into account. To select a speed sensor, see section 12-5-1.

#### When the current is from ahead, ground speed is less than water speed

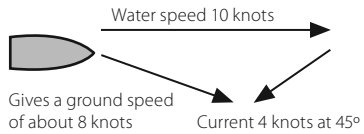
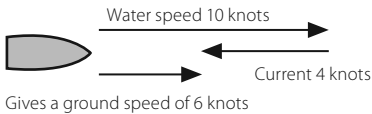

For this example:

If the boat travels for one hour, uses 3 gallons of fuel per hour and has 50 gallons of fuel left:

	<b>Speed</b>	<b>Log</b>	<b>Economy</b>	<b>Range</b>
Using water speed:	10 knots	10 nm	3.3 nm / gal	165 nm
Using ground speed:	6 knots	6 nm	2.0 nm / gal	100 nm

#### When the current is from behind, ground speed is more than water speed

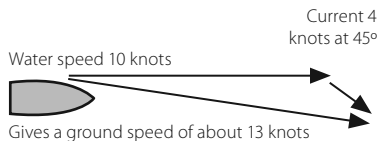
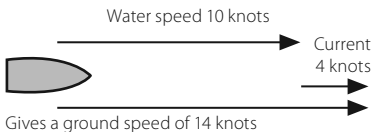

For this example:

If the boat travels for one hour, uses 3 gallons of fuel and has 50 gallons of fuel left:

	<b>Speed</b>	<b>Log</b>	<b>Economy</b>	<b>Range</b>
Using water speed:	10 knots	10 nm	3.3 nm / gal	165 nm
Using ground speed:	14 knots	14 nm	4.7 nm / gal	235 nm



## 12-6 Fuel consumption curves

A fuel consumption curve shows fuel consumption (fuel used per unit of distance travelled) and boat speed as a function of engine RPM. Fuel consumption curves require engine RPM, which requires SmartCraft™ or diesel sensors to be installed. Fuel consumption curves are powerful tools for assessing boat performance in different conditions and for helping you to run at the most economical speed and trim for the conditions.

### 12-6-1 Making a fuel consumption curve

To make a fuel consumption curve you will need to run the boat in a straight line for about 15 minutes using the engine's full RPM range. For your first curve, choose a calm day with light wind and little current; have a typical load and a freshly cleaned hull. Later, you can make fuel consumption curves for different boat, weather or sea conditions. Compare these with your first curve to see how your boat's performance changes with conditions.

#### Making a curve

- 1 Start running the boat in a straight line.
- 2 Choose a speed source for the curve (see section 12-5-1). Normally choose Water speed to measure the boat's potential performance.
- 3 Press **MENU** twice, then select Fuel.
- 4 Select Fuel consumption curve, then select New.
- 5 Enter the comfortable maximum RPM you know you can achieve for the engine rather than the maker's value.

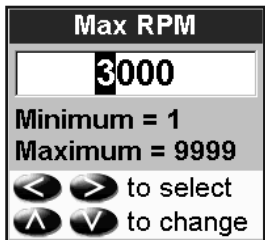

- 6 The 657 then asks you to set the minimum RPM. Set the throttle to idle; on a multi engine boat set all engines to about the same idle RPM.

Now, do not change the engine speed. Wait for about 60 seconds for the boat to stabilise, then press **ENT**. Wait while the fuel computer records the data.

- 7 The 657 then asks you to set the throttle to achieve a vessel RPM. On a multi engine boat set all engines to about the vessel RPM. When the engine RPMs are correct, the Vessel RPM box will turn green.

Now, do not change the engine speed. Wait for about 60 seconds for the boat to stabilise, ensuring the Vessel RPM box stays green. Then press **ENT**. Wait while the fuel computer records the data.

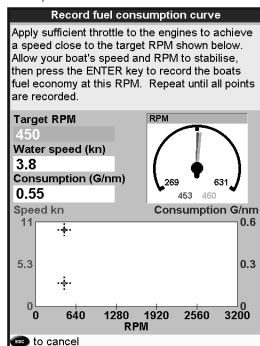

- 8 The 657 repeats the above step to record data up to the maximum RPM. Then the 657 asks if you want to save the curve. Select Yes. The fuel computer asks for a name for the curve. Change the default name if required. Then press **ENT**. The 657 stores the new curve.

**Note:** To interrupt making the curve at any time, press **ESC**.

## 12-6-2 Managing fuel consumption curves

### Renaming a curve

- 1 Press **MENU** twice, then select Fuel1.
- 2 Select Fuel consumption curve. Select Name and select the name of the curve to rename.
- 3 Select Rename and press **ENT**. Change the name.

## 12-6-3 Using fuel consumption curves

### Deleting a curve

- 1 Press **MENU** twice, then select Fuel1.
- 2 Select Fuel consumption curve. Select Name and select the name of the curve to delete.
- 3 Select Delete.

### Selecting a curve

- 1 You must make a fuel consumption curve before you can use it (see section 12-6-1).
- 2 On the Fuel window, press **MENU**, select Fuel consumption curve and select the name of the curve to use.
- 3 On the fuel window, press **▶** if necessary to select Fuel curve and display the fuel consumption curve.

### Note:

- a On a multi engine boat, keep the RPM of all engines similar while using a curve.
- b The shape of the curve depends on the type of speed sensor you selected when making the curve (see sections 12-5-1 and 12-5).

### Using a curve

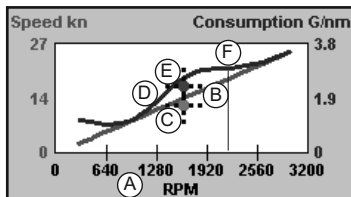

Compare your boat's performance now, at the current RPMs, with the boat's performance when you made the curve. You can compare your boat's performance now with a curve made under ideal conditions or with a curve made under similar conditions.

### Information in a curve

- A RPM of the boat now. For a twin engine boat, the RPM is the average of the two RPMs.
- B Red curve: boat speeds at different RPMs recorded when you made this fuel consumption curve.
- C Red marker: the boat speed now. This marker is below the red curve, showing that the boat speed now at this RPM is less than when you recorded the curve.
- D Blue curve: fuel consumption at different RPMs recorded when you made this fuel consumption curve.
- E Blue marker: the fuel consumption now. This marker is below the blue curve, showing that the fuel consumption now at this RPM is better than when you recorded the curve.
- F If the blue curve has a dip, then running the boat at this RPM will give the best speed for the least fuel consumption.

## 12-7 Calibration

---

Calibrate petrol/gasoline fuel flow sensors during installation, or if the fuel readings seem inaccurate and the other troubleshooting suggestions do not help (see appendix B troubleshooting).

### Note

- SmartCraft™ fuel sensors are factory calibrated and should never need recalibrating.
- On a multi engine boat, calibrate each engine's sensor. This can be done at the same time with a portable tank for each engine or at different times using one portable tank.
- Calibrating a sensor requires accurate measurement of the fuel consumption. This is best done using a small portable tank. At least 4 gallons (15 litres) of fuel should be used to ensure an accurate calibration.
- It is often very difficult to fill underfloor tanks to the same level twice due to air pockets, so the more fuel used, the more accurate the calibration.

To calibrate the sensor(s):

- 1 Record the level of the fuel in the tank(s).
- 2 Connect the portable tank(s) to the engine through the fuel sensor(s).
- 3 Run the engine at normal cruising speed until at least 4 gallons (15 litres) of fuel has been used per engine.
- 4 Check the actual amount of fuel used per engine by refilling the portable tank(s) to the original level and noting the reading(s) of the fuel dispenser's gauge.
- 5 Press **MENU** twice, select **Fuel** then select **Setup engines**.
- 6 On a single engine boat, select **Calibrate** and change the displayed value to be equal to the reading of the fuel dispenser's gauge, then press **ENT**.

On a multi-engine boat select the engine.

Select **Calibrate** and change the displayed value to be equal to the reading of the fuel dispenser's gauge, then press **ENT**. Repeat for the other engines.

## 13 Tides window

The tides window is available on C-MAP charts. The tides window shows tide information at a tide station for the selected date.

**Note:** The tides window requires the local time offset to be set to work correctly (see section 17-13)

To show the tides window for the tide station nearest to the boat, press **DISP**, select **More**, then select **Tides**.

To go to the tides window for any tide station:

- 1 From the chart window, press **MENU** and select **Find**.
- 2 Select **Tide stations**.

- 3 A list of tide stations are displayed. Select the tide station to display. The chart redraws with the tide station centred.
- 4 Press **MENU** and select **Chart info**.
- 5 Select **Tide height**.

### Choosing the date of the tide chart

- 1 Press **MENU**.
- 2 Select **Today**, **Next day** or **Prev day**.  
To choose a different date from these, select **Set date**, edit the date, press **ENT**.

### The tides window shows data for the chosen date

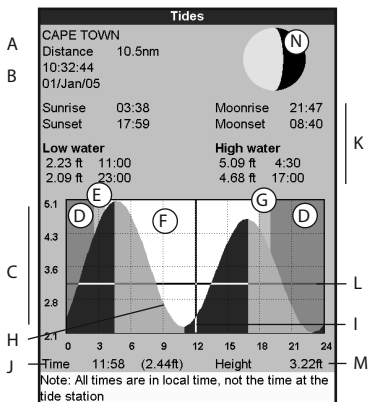

- A Tide station name and distance from boat
- B Current time and chosen date for display
- C Tide chart
- D Night
- E Dawn
- F Day
- G Dusk
- H Tide height
- I Time cursor, a vertical dotted line. Press **←** or **→** to move cursor sideways
- J Time of cursor and tide height at that time
- K Data for the chosen date
- L Tide height cursor, a horizontal dotted line. Press **▲** or **▼** to move cursor up and down.
- M Height of cursor on the tide chart
- N Moon phase for moon at the current time on the chosen date

### CAUTION

The tides window requires the local time offset to be set to work correctly (see section 17-13)

## 14 User card window

A C-MAP™ user card is an optional plug-in card that can store data files (see section 1-3). There are three types of files: waypoints, routes or a track.

To go to the user card window, press **DISP**, select **More**, then select **User card**.

### CAUTION

- 1 Before using a user card, remove any chart card and plug the user card in. When you have finished with the user card, remove the user card and replace the chart card (see section 1-3).
- 2 The older 5 volt cards are not supported.

### The user card window has:

#### File list

A list of the files on any user card in the 657. If there are more files than will fit on the display, press **+** or **-** to scroll up or down a page at a time.

#### Waypts, Routes

The number of waypoints and routes currently in the 657.

#### Track 1 to Track 5

The number of points in tracks 1 to 5 currently in the 657.

#### Note:

- 1 To save 657 data onto the user card, use the Save command (see below).
- 2 Data stored on the user card and shown on the file list is not available to be used by the 657 until loaded into the 657 with the LOAD command (see below).

### Saving data to the user card

This saves all the 657's waypoints, all the 657's routes or one of the 657's tracks to one file on the user card.

- 1 Press **MENU** and select **Save**.
- 2 Select **Waypts, Routes** or **Tracks**.
- 3 For **Tracks**, select the track number to save.
- 4 The new file is created. Change the name if required. The new file appears in the file list.

User card			
Name	Type	Date	Time
Device not formatted			
In memory		Track 2:	0
Waypts:	51	Track 3:	0
Routes:	10	Track 4:	0
Track 1:	8	Track 5:	0

### Loading data from the user card to the 657

This loads one file from the user card to the 657:

- A waypoints file: The new waypoints are added to any existing waypoints in the 657. If a new waypoint has the same name as an existing waypoint but has different data, the 657 displays both waypoints. Select:

**Skip:** Do not load the new waypoint.

**Replace:** Load the new waypoint and replace the existing one.

**Skip all:** Do not load any new waypoints which have the same names as existing waypoints.

**Rplc all:** Load all new waypoints which have the same names as existing waypoints; the new waypoints replace the existing waypoints.

- A routes file: The new routes are added to any existing routes in the 657. If a new route has the same name as an existing route but has different data then the 657 asks which route to keep.
- A track file: The new track will replace the existing track in the 657.

To load a file to the 657:

- 1 Select the file to load.
- 2 Press **MENU** and select Load.

### **Deleting a file from the user card**

- 1 Select the file to delete.
- 2 Press **MENU** and select Delete.
- 3 Select Yes to confirm.

### **Rereading the file information**

This reads the file names from the user card and displays them. Reading does not load any file data into the 657. You should not need to do this.

- 1 Press **MENU** and select Card.
- 2 Select Read.

### **Formatting the user card**

Formatting prepares a user card for use. Format the card if there is an error message saying that the card is not formatted. Any data files on the card are deleted.

- 1 Press **MENU** and select Card.
- 2 Select Format.
- 3 Select Yes to confirm.

### **Sorting the file names**

This sorts the displayed file names.

- 1 Press **MENU** and select Sort.
- 2 Select sort by Name, Type or Time.

## **⚠ WARNING**

Do not format a chart card.

## **15 AIS**

AIS is short for Automatic Identification System. The International Convention for Safety of Life At Sea (SOLAS) requires all vessels greater than 300 tons and all passenger vessels to be equipped with AIS Transponders. All vessels equipped with AIS permanently broadcast via one or more of the two dedicated VHF channels. This transmission may include information about the vessels MMSI-number, its call sign, name, position, course, heading, speed, rate of turn and type of vessel.

This unit can receive and display AIS information when connected to an AIS receiver. Available AIS vessels transmitting in the local area are show on the chart when this feature is enabled.

The following AIS receivers are supported by this unit:

- Comar SLR200 (external GPS).
- Weatherdock Two Channel AIS Receiver "EASY AIS", Part No. 5-A-013 (external GPS).
- NASA Marine AIS Engine 2 channel Receiver (external GPS).

Other AIS receivers may work but have not been tested with this unit.

To enable AIS from the system menu check the AIS box. (see section 15-1)

## 15-1 Viewing AIS Vessels

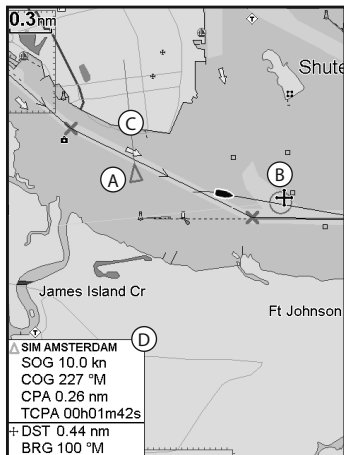

- A AIS Vessel
- B Dangerous Vessel
- C Projected Course
- D Data Box

When the cursor is placed over an AIS vessel for at least two seconds, a data box appears at the bottom of the window with information about the AIS vessel.

For complete AIS information on the AIS vessel place the cursor over an AIS vessel for at least two seconds and press **ENT**.

Vessel info: SIM CHARLESTON	
Position 36°30.410'S 174°04.813'E	
COG 268°M	BRG 116°M
SOG 21.4 kn	DST 7635 nm
CPA 6233 nm	TCPA 149h28m33s
Heading 266°M	ROT 2°/min
MMSI 123456789 Callsign CAE IMO 0	
Nav status Under way Type Cargo - All Vessels Dest CHARLESTON, USA ETA --/--	
Length 639.8 ft	Antenna Location
Beam 82.0 ft	
Draught 23.0 ft	
to continue	

Press either **ENT** or **ESC** to clear the information.

## 15-2 Dangerous Vessels

The 657 calculates the time of closest point of approach (TCPA) and closest point of approach (CPA) for each AIS vessel.

This is used to determine potential dangerous vessels. If the TCPA and the CPA is below the trigger values then it will be considered dangerous. (See section 17-9 for setting the dangerous vessel alarm)

A dangerous vessel is indicated on the chart by a red circle around the icon.

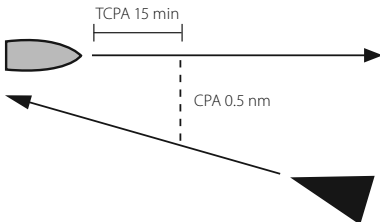

## 15-3 AIS Windows

To go to the AIS windows, press **DISP**, select **More**, then press **◀** or **▶** to select one of the two windows: Vessels or Safety msgs (rx).

If there are more items than will fit on the window, press **+** or **-** to see the others.

AIS			
Vessels		Safety msgs (rx)	
DST (nm) BRG (°M) (kn)	SOG (kn)	MMSI Name	CPA (nm) TCPA
7635 116	21.4	123456789 SIM CHARLES..	6391 132h27m24s
7641 116	9.9	894351656 SIM GENOVA	6856 290h02m02s
7672 116	2.1	156649841 SIM CAPETOW..	7683 01h07m40s
7678 116	10.0	721198100 SIM AMSTERD..	2297 608h16m06s

**+** **-** to page up/down

### Vessels

This is a sorted list of vessels currently being received by the AIS receiver. The maximum number of vessels that the system will support is 250. Once maximum is reached, vessels furthest away from the current location will be replaced. A vessel will be removed from the list if no information is received within 6 minutes from the last message.

### Displaying an AIS vessel on the chart

- 1 Press **▲** or **▼** to select a vessel.
- 2 Press **MENU** and select **Display**. The Instrument switches to chart window, with the selected vessel position in the middle.

## Displaying Full AIS Details

- 1 Press **▲** or **▼** to select a vessel.
- 2 Press **MENU** and select **More Info** or press **ENT**.

This window displays all information for the selected AIS vessel provided by the AIS receiver.

## Sorting Vessels

Press **MENU**, select **Sort** and select one of the options.

This sorts the list based on the chosen category.

## Safety msgs (rx)

AIS		
Vessels		Safety msgs (rx)
Time	MMSI	Message
09:35:01 02/May/87	546946501	Iceberg, right ahead!
10:42:34 08/Nov/88	594988954	Man overboard! Man overboard!

**+** **-** to page up/down

Safety msgs (rx) are broadcasted messages received by the AIS receiver. This window displays the date and time of message received, MMSI of AIS vessel that broadcasted the message, and the message itself. Safety msgs (rx) list will store up to 10 messages. The oldest message is replaced when the list is full.



## 16 DSC/Buddy track windows

Buddy track requires an optional Northstar DSC VHF radio to be installed. Buddy track tracks other boats which have DSC radios connected to their GPS receivers by NavBus and are in VHF range. For information on setting up and using the VHF radio for buddy track, see the radio's operation manual.

To go to the DSC/Buddy track windows, press **DISP**, select **More**, then select **DSC**. Then from the DSC/BuddyTrack window press **←** or **→** to select one of the three displays: Distress, Poll or Buddy track.

If there are more items than will fit on the display, press **+** or **-** to see the others.

### 16-1 The displays

DSC/Buddy track			
Distress	Poll	Buddy track	
Date Time	Latitude Longitude	Name	MMSID
01/Jan/05 10:31:07	00°00.666'N 000°00.666'E	Bob	124122316
01/Jan/05 10:30:08	00°00.666'N 000°00.666'E	Bob	124122316

Collision  
 to page up/down

DSC/Buddy track			
Distress	Poll	Buddy track	
Date Time	Latitude Longitude	Name	MMSID
01/Jan/05 10:31:28	00°00.000'N 000°00.000'E	Peter	513318886
01/Jan/05 10:31:17	00°00.000'N 000°00.000'E	Shane	143053013
01/Jan/05 10:31:08	00°00.000'N 000°00.000'E	Mark	422782911
01/Jan/05 10:30:57	00°00.000'N 000°00.000'E	John	126643621
01/Jan/05 10:30:47	00°00.000'N 000°00.000'E	Reuben	105285716
01/Jan/05 10:30:38	00°00.000'N 000°00.000'E	Paul	447427149
01/Jan/05 10:30:27	00°00.000'N 000°00.000'E	Peter	513318886
01/Jan/05 10:30:17	00°00.000'N 000°00.000'E	Shane	143053013
01/Jan/05 10:30:08	00°00.000'N 000°00.000'E	Mark	422782911

to page up/down

DSC/Buddy track		
Distress	Poll	Buddy track
	<b>Mark</b>	Position: 33°44.995'S 018°30.000'E Time: 10:31:47 MMSID: 422782911
	<b>Peter</b>	Position: 00°01.320'N 000°01.320'E Time: 10:31:47 MMSID: 513318886
	<b>Paul</b>	Position: 00°01.980'S 000°01.980'W Time: 10:31:47 MMSID: 447427149
	<b>Reuben</b>	Position: 00°02.640'S 000°02.640'E Time: 10:31:47 MMSID: 105285716

#### Distress

Boats that have sent DSC distress messages and their positions.

#### Poll

Boats you have manually polled on the VHF radio, and their position at that time.

#### Buddy track

Buddy boats from your DSC radio. The radio regularly calls the boats and updates their positions.

When your DSC radio receives a distress message, the 657 creates a distress waypoint at the boat position. Distress waypoints have default names like DSTRSS01. The 657 displays a Distress warning.

Select:

- **OK** to return to what you were doing.
- **Display** to switch to Chart and display the position of the boat sending the distress message.

Distress	
00°00.666'N	000°00.666'E
<b>Collision</b>	
MMSID: 124122316	10:31:07
Bob	01/Jan/05
<b>OK</b>	<b>Display</b>

## Boat positions

The boat positions on the 657 can differ from the true boat positions:

**Distress:** The position is the distress waypoint, which is where the boat was when it sent the distress message.

**Polled boats:** The position is where the boat was when you last polled the boat.

**Buddy track:** The position is where the boat was when your radio last polled the boat.

## 16-2 Using the displays

### Displaying a boat on the chart

- 1 Press **▲** or **▼** to select a boat.
- 2 Press **MENU** and select **Display**. The 657 switches to chart window, with the selected boat position in the middle (see Boat positions above).

### Going to a boat

- 1 Press **▲** or **▼** to select a boat.
- 2 Press **MENU** and select **Go to**. The 657 starts navigating to the boat's position (see Boat positions above).

### Creating a waypoint

Polled and buddy track boats are not waypoints. To create a waypoint at the position of a polled boat (see Boat positions above):

- 1 Press **▲** or **▼** to select a boat.
- 2 Press **MENU** and select **Create waypoint**. Edit the waypoint data if required (see section 5-2-7).

### Editing a waypoint

A distress message creates a waypoint for the boat or you can create a waypoint at a polled boat's position. To change the data of these waypoints:

- 1 Press **▲** or **▼** to select a boat.
- 2 Press **MENU** and select **Edit waypoint**. Edit the waypoint data if required (see section 5-2-7).

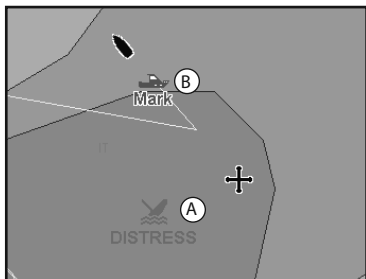

On a chart window:

- A Distress boats are distress waypoints
- B Buddy track boats are buddy symbols

### Deleting a boat

At the Distress or Poll displays:

- 1 Press **▲** or **▼** to select a boat.
- 2 Press **MENU** and select **Delete**. The boat is deleted from that display. Delete any boat waypoint manually (see section 5-2-5).

Buddy track boats automatically disappear from the Buddy track window when your DSC radio can not pick up their signal.

### Deleting all boats

At the Distress or Poll displays:

- 1 Press **▲** or **▼** to select a boat.
- 2 Press **MENU** and select **Delete all**. All boats are deleted from that display and any boat waypoints are deleted.

## 17 Setting up the 657

---

The 657 has a number of advanced features which are set up through the setup menu. We recommend that you become familiar with the operation of the unit using the default settings before making any changes in these menus.

To go to a setup option menu, press **MENU** twice, then select an option.

**Note:**

- 1 The Setup menu options are explained in the following sections.
- 2 Section 2-1 describes how to set or change data in the setup menus.
- 3 The setup data available will depend on the optional sensors and instruments installed.

Setup	
System	▶
Chart	▶
Sonar	▶
GPS	▶
Fuel	▶
SmartCraft	▶
Track	▶
AIS	▶
Logs	▶
Alarms	▶
Units	▶
Comms	▶
Calibrate	▶
Time	▶
Favorites	▶
Simulate	▶

## Setup option menus

Factory default settings are shown. The setup data available will depend on the optional sensors and instruments installed.

### System (see 17-1)

System	
Language	English
Backlight	15
Night mode	<input type="checkbox"/>
Key beep	<input checked="" type="checkbox"/>
Auto power off	<input type="checkbox"/>
Factory reset	<input type="checkbox"/>
About	
Sonar	<input checked="" type="checkbox"/>
SmartCraft	<input checked="" type="checkbox"/>
AIS	<input checked="" type="checkbox"/>
Buddy track	<input checked="" type="checkbox"/>

### Chart (see 17-2)

Chart	
Rotation	North up
Palette	Normal
Map datum	WGS-84
NMEA datum offset	<input type="checkbox"/>
Map shift	Off
General	▶
Water	▶
Land	▶
Other	▶

General, Water, Land and Other submenus (17-2)

General	
Plotter mode	<input type="checkbox"/>
Mixing levels	<input type="checkbox"/>
AntiClutter	<input type="checkbox"/>
Value added data	<input type="checkbox"/>
Projected course	Off
CDI scale	0.1 nm
Lat/lon grid	<input type="checkbox"/>
Boundaries	Auto
Text/icon Size	Small

Water	
Water features	<input checked="" type="checkbox"/>
Bathymetric lines	<input checked="" type="checkbox"/>
Spot soundings	<input checked="" type="checkbox"/>
Bath & sndgs min	0 ft
Bath & sndgs max	50 ft
Tidal Stream	<input checked="" type="checkbox"/>

Land	
Land features	<input checked="" type="checkbox"/>
Land elevation	<input checked="" type="checkbox"/>

Other	
Waypoints	Selected
Names	<input checked="" type="checkbox"/>
Lights	On
Nav-aids	INT
Attention areas	<input checked="" type="checkbox"/>

### Sonar (see 17-3)

Sonar	
Frequency	200kHz
Scroll speed	Fast
Fish symbols	Off
Fish depth labels	<input type="checkbox"/>
Fish filter	Small
Fish sensitivity	Medium
Digit size	Medium
Palette	White
Interference filter	<input type="checkbox"/>
Noise filter	Off
Surface clutter filter	<input type="checkbox"/>
Pulse length	Auto
Pulse power	Auto

### GPS (see 17-4)

GPS	
GPS source	NMEA
DGPS source	WAAS/EGNOS
Restart GPS	<input type="checkbox"/>
Static navigation	Off
Speed filter	5
Course filter	4

### Fuel (see 17-5)

Fuel	
Source	Gasoline
Num engines	1
Num tanks	1
Setup engines	▶
Setup tanks	▶
Diesel sensors	<input type="checkbox"/>
Fuel consumption curve	▶
Speed source	Ground speed
Max fuel flow	26 G
Max RPM	3000

### Track (see 17-6)

Track	
Record	1
Display	1
Plotting interval	Distance
Distance	0.1 nm
Time	10 sec
Memory used	0%
Send track	<input type="checkbox"/>
Delete track	<input type="checkbox"/>

### AIS (see 17-7)

AIS	
Filter by distance	300 nm
Filter by speed	0 kn
Show dangerous only	<input type="checkbox"/>
Dangerous vessel alarm	<input type="checkbox"/>
TCPA limit	2 min
CPA limit	0.1 nm
Projected course	Off

### Logs (see 17-8)

Logs	
Reset trip dist	<input type="checkbox"/>
Reset total dist	<input type="checkbox"/>
Reset engine hours	<input type="checkbox"/>
Trip dist	0.00 nm
Total dist	0.00 nm
Engine hours	0.0 hrs

### Alarms (see 17-9)

Alarms	
Arrival radius	▶
Anchor alarm	▶
XTE	<input type="checkbox"/>
Danger	▶
DGPS	<input checked="" type="checkbox"/>
AIS	▶
Fish	<input type="checkbox"/>
Too shallow	▶
Too deep	▶
Temperature	▶
Temperature rate	▶
Low battery	▶
Fuel	▶

### Units (see 17-10)

Units	
Distance	nm
Distance small	ft
Speed	kn
Depth	ft
Fuel	USGal
Compass	°M
Temperature	°F
Wind	TRUE
Pressure	kPa
Baro	mB

### Comms (see 17-11)

Comms	
NMEA out	<input type="checkbox"/>
NMEA data	<input type="checkbox"/>
Lat/Lon d.p's	3
NavBus	<input checked="" type="checkbox"/>
NavBus group	0

SmartCraft™

(See the *SmartCraft™ Gateway Installation and Operation Manual*)

### Calibrate (see 17-12)

Calibrate	
Speed	
Speed filter	Off
Temperature	
Temp filter	5 sec
Keel offset	0.0 ft
Speed range	Low

### Time (see 17-13)

Time	
Local offset	+00:00
Time format	24 hour
Date format	dd/MMM/yy

### Favorites (see 17-14)

Favourites	
Name	
1	Chart + Sonar
2	Chart + Gauges
3	-
4	-
5	-
6	-
[MENU] for options	

### Simulate (see 17-15)

Simulate	
Simulate	<input type="checkbox"/>
Mode	Normal
Speed	1.0 kn
Course	0 °M
Route	

## 17-1 Setup > System

Press **MENU** twice, then select System:

System	
Language	English
Backlight	15
Night mode	<input type="checkbox"/>
Key beep	<input checked="" type="checkbox"/>
Auto power off	<input type="checkbox"/>
Factory reset	
About	
Sonar	<input checked="" type="checkbox"/>
SmartCraft	<input checked="" type="checkbox"/>
AIS	<input checked="" type="checkbox"/>
Buddy track	<input checked="" type="checkbox"/>

### Language

Select the language for the displays.

**Tip:** In case you can't read the current language, the language setting is found at the top of the system menu.

### Backlight

Select the backlight level for the keys and display (see also section 2-3)

### Night mode

Night mode sets the palette for all displays.

- Normal palette, for daytime
- All displays have a palette optimised for night time.

See also section 2-3. To change only the chart palette, see section 17-2.

### Key beep

Enables or disables the beep when a key is pressed.

### Auto power off

See section 2-2.

### Factory reset

This option returns all of the 657 settings (except the language, waypoints and routes) to the default factory settings shown on the setup menus.

### About window

The about window shows:

- The software version and date.
- The world chart version.
- Any card fitted.

- The number of waypoints, routes and tracks you have stored.
- Connector wiring information.

In the unlikely event of having to contact a Northstar dealer for service, quote the software version number and date.

About			
Copyright © 2004-2006 Northstar			
Model	657		
Software	1.0.0, Aug 19 2006		
Hardware	4.18.10		
Bootloader	1.0.0		
Cartography	7.0.8.26R		
SmartCraft	--		
World chart			
World Wide Background (CF95W02) 1.67			
Slot 1: No card			
Waypoints	3000	0	Used
Routes	25	0	Used
Tracks	5	1	Used
Powercomms cable <input type="checkbox"/> Black			
1	<input checked="" type="checkbox"/> Black	Ground	
2	<input type="checkbox"/> Brown	Not used	
3	<input type="checkbox"/> White	NMEA out	
4	<input type="checkbox"/> Blue	NavBus-	
5	<input type="checkbox"/> Red	+12VAV in	
6	<input type="checkbox"/> Orange	NavBus+	
7	<input type="checkbox"/> Yellow	Ignition	
8	<input type="checkbox"/> Green	Ext Alarm	
GPS/Fuel/AIS cable <input type="checkbox"/> Yellow			
Refer to manual			
Sonar cable <input type="checkbox"/> Blue			

### Sonar

- Disable any sonar transducer and disable sonar functions.
- A sonar transducer is fitted. Enable sonar operation.

See section 18-6.

### SmartCraft™

- No SmartCraft™ gateway is fitted. Disable SmartCraft™ functions.
- SmartCraft™ gateway is fitted. Enable SmartCraft™ operation.

See section 18-8.

### AIS

- No appropriate AIS receiver is fitted. Disable AIS.
- An appropriate AIS receiver is fitted. Enable AIS.

See section 17-11.

### Buddy track

- No DSC VHF radio is fitted. Disable Buddy track.
- A DSC VHF radio is fitted. Enable Buddy track.

See section 18-8

## 17-2 Setup > Chart

Press **MENU** twice, then select Chart:

Chart	
Rotation	North up
Palette	Normal
Map datum	WGS-84
NMEA datum offset	<input type="checkbox"/>
Map shift	Off
General	
Water	▶
Land	▶
Other	▶

General	
Plotter mode	<input type="checkbox"/>
Mixing levels	<input type="checkbox"/>
AntiClutter	<input type="checkbox"/>
Value added data	<input type="checkbox"/>
Projected course	Off
CDI scale	0.1 nm
Lat/lon grid	<input type="checkbox"/>
Boundaries	Auto
Text/Icon Size	Small

Water	
Water features	<input checked="" type="checkbox"/>
Bathymetric lines	<input checked="" type="checkbox"/>
Spot soundings	<input checked="" type="checkbox"/>
Bath & sndgs min	0 ft
Bath & sndgs max	50 ft
Tidal Stream	<input checked="" type="checkbox"/>

Land	
Land features	<input checked="" type="checkbox"/>
Land elevation	<input checked="" type="checkbox"/>

Other	
Waypoints	Selected
Names	<input checked="" type="checkbox"/>
Lights	On
Nav-aids	INT
Attention areas	<input checked="" type="checkbox"/>

### Rotation

The options for chart rotation are:

**North up:** North is always at the top of the chart window.

**Track up:** The chart is rotated so that the boat direction is to the top of the display. This option is useful for navigating narrow harbours or rivers. The 657 asks for a course deviation resolution; this is how much the boat direction needs to change to make the chart redraw.

 **Tip:** If the chart redraws too frequently, increase the course deviation setting.

**Course up:** This option is only available if the boat is navigating to a destination. The chart is rotated so that the plotted course to the destination is vertical.

### Palette

Select the color scheme for the LCD display. The options are:

#### Normal

**Sunlight:** Brighter colors, more visible in sunlight.

**Night:** Reversed colors for night, to preserve night vision.

### Map datum

657 GPS positions are based on a worldwide reference (datum) known as WGS 84. Most paper charts are based on WGS 84. However, some paper charts are based on other datums. In these cases, the latitude and longitude coordinates of objects on the 657 chart window are different to the latitude and longitude coordinates of these objects on the paper chart. This applies to all objects, such as the boat, waypoints, tracks, lines of latitude and longitude and cartographic features such as land, rocks, buoys and depth contours.

Use Map datum to select the 657 map datum to match the datum of the paper chart. Then, the latitude and longitude coordinates of objects displayed on the 657 will change to match the corresponding coordinates on the paper chart.

### Setting map datum

- 1 In the Chart setup menu, select Map datum.
- 2 Select the map datum for the paper chart you are using.
- 3 If you select a datum other than WGS 84 the 657 asks if you want to apply the NMEA datum offset (see below).

### WARNING

When you change to a chart with a different datum, change the 657 map datum again.

## NMEA datum offset

If you select a map datum other than WGS 84, the map datum offset can be applied to latitude and longitude coordinates sent on the 657 NMEA output:

- Latitude and longitude coordinates displayed on any NMEA repeater do not match the coordinates on the 657. Latitude and longitude coordinates broadcast on any NMEA VHF transmitter will be the same as the coordinates on a WGS 84 chart.
- Latitude and longitude coordinates displayed on any NMEA repeaters match the coordinates on the 657. However, latitude and longitude coordinates broadcast on any NMEA VHF transmitter will be slightly offset from coordinates on a WGS 84 chart.

## Map shift



Map shift is for eliminating minor offsets. It should not be used if the correct datum is available. Use map shift with caution: incorrect application will cause incorrect boat positions.

Some charts have consistent position errors. To correct this, apply a map shift. After a map shift:

- The positions of cartographic features (such as land, rocks, buoys and depth contours) move on the 657 chart window to where they should be.
- The positions of the boat, waypoints, tracks, and lines of latitude and longitude on the 657 chart window remain unchanged.

### Applying a map shift



- 1 Move the boat to a known point on the chart, for example a marina berth.
- 2 In the Chart setup menu, select **Map shift**.
- 3 Move the cursor to the position on the chart where the boat actually is.
- 4 Press **MENU** and select **Set**.
- 5 Press **ESC** to set the new map shift. The boat will now be displayed at its actual location.

### Clearing the map shift

Clearing the map shift removes any map shift from the cartographic features on the 657 chart window.

- 1 In the Chart setup menu, select **Map shift**.
- 2 Press **MENU** and select **Clear**.
- 3 Press **ESC**.

General submenu	
<b>Plotter mode</b>	<input type="checkbox"/> Normal: only scales available on the chart card can be displayed <input checked="" type="checkbox"/> If you press <b>+</b> or <b>-</b> to select a chart scale which is not available, on the chart card, the chart window will change to this scale but will only display the boat position and track (if enabled). The rest of the display is white with black crosshatch lines and no chart information is displayed. This is useful to zoom to a small scale to track small boat movements or if there is no detailed chart for an area
<b>Mixing levels</b>	Mixes lower detail charts with higher detail charts on chart boundaries <input type="checkbox"/> Lower detail chart is not shown <input checked="" type="checkbox"/> Lower detail chart shown; this is slower to redraw
<b>Anticlutler</b>	<input type="checkbox"/> Names and icons shown. <b>Note:</b> this is independent of the change in detail shown at different zoom levels <input checked="" type="checkbox"/> Hides some less important names and icons to make the chart clearer
<b>Value added data</b>	<input checked="" type="checkbox"/> Non marine chart data shown

<b>Projected course</b>	The 657 can estimate the course after a given time, based on the current speed and heading (see section 3-4). The options are 2 minutes, 10 minutes, 30 minutes, 1 hour, 2 hours or Off
<b>CDI scale</b>	See Appendix C. The options are 0.05, 0.1, 0.2, 0.5, 1.0, 2.0, 4.0 and 10.0 distance units
<b>Lat/lon grid</b>	<input checked="" type="checkbox"/> Displays a latitude and longitude grid
<b>Boundaries</b>	Displays boundaries around areas where more detailed chart coverage is available: Auto shows the next four detail levels; On shows all
<b>Text/icon size</b>	Select the size of chart text and icons
<b>Water submenu</b>	
<b>Water features</b>	<input checked="" type="checkbox"/> Displays marine sediment labels (for example, M shows areas of mud) and tide station icons 
<b>Bathymetrics</b>	Displays underwater depth contours between Bath & sndgs min and max
<b>Spot soundings</b>	Displays depth soundings between Bath & sndgs min and max
<b>Bath &amp; sndgs min</b>	The minimum depth for Bathymetrics and Spot soundings
<b>Bath &amp; sndgs max</b>	The maximum depth for Bathymetrics and Spot soundings
<b>Tidal flow</b>	<input checked="" type="checkbox"/> Displays dynamic tide flows: arrows on a chart showing the present tide stream and orientation (requires a GPS fix and an NT-MAX card)
<b>Land submenu</b>	
<b>Land features</b>	<input checked="" type="checkbox"/> Displays land features, for example regions, rivers, roads, railways, airports
<b>Land elevation</b>	<input checked="" type="checkbox"/> Displays land contours, shaded like depths (requires an NT Max card)
<b>Other submenu</b>	
<b>Waypoints</b>	Displays waypoints: Hide all only displays waypoints on any selected route; Selected displays waypoints with their display option set to Icon or I+N (Icon and Name) (see section 5)
<b>Names</b>	<input checked="" type="checkbox"/> Displays place names
<b>Lights</b>	Light House display options: Off hides all light indicators (the icon still shows); No sectors hides sectors; On shows sectors; Animated activates light animation. <b>Note:</b> with light animation enabled sectors are not visible, animation only operates in single chart view or in the top chart of chart + chart
<b>Nav-aids</b>	Displays signals (fog, radar, radio stations) and bouys. Int and US select the icon format; Smp1 draws simpler icons
<b>Attention areas</b>	<input checked="" type="checkbox"/> Displays attention area boundaries and information icons  ; attention areas are important areas, such as restricted anchorages or shallow areas



## 17-3 Setup > Sonar

Press **MENU** twice, then select Sonar:

Sonar	
Frequency	200kHz
Scroll speed	Fast
Fish symbols	Off
Fish depth labels	<input type="checkbox"/>
Fish filter	Small
Fish sensitivity	Medium
Digit size	Medium
Palette	White
Interference filter	<input type="checkbox"/>
Noise filter	Off
Surface clutter filter	<input type="checkbox"/>
Pulse length	Auto
Pulse power	Auto

### Frequency

There is a choice of: 200 kHz, 50 kHz and Mixed. For information about selecting a suitable frequency for the water conditions. (see section 8-3)

### Scroll speed

Use this to set the scroll speed on the display. There is a choice of: Very Fast, Fast, Medium, Slow and Pause. The depth of the water also affects the speed of the display.

Faster scroll speeds combined with a slow boat speed (typically between 2 and 6 knots) shows the most fish detail. Medium or Slow scroll speeds result in sonar information being displayed over a longer period, but with less detail (see Section 8-2).

### Fish symbols

The 657 always displays echoes from fish (fish arches, see section 8-4). If fish symbols are on, a symbol is displayed over the arch (see section 8-4). The options are:

- Off: No fish symbol is displayed.
- Fun or Normal: A fish symbol is displayed.
- Fun + depth or Normal + depth: A fish symbol is displayed and the depth shown beside the fish symbol.

### Fish filter

Use this to select the minimum fish size that will be displayed as a fish symbol and to trigger the Fish alarm. The options are: Small, Medium and Large.

### Fish sensitivity

Selects the minimum strength fish echo that will be displayed as a fish symbol. Higher values will display more fish symbols.

### Digit size

Use this to remove or change the size of the depth window on the sonar displays. There is a choice of: Small, Medium and Large.

### Palette

Use this to select a color palette. Each color within the palette represents a different echo strength, as shown on the sonar displays.

There is a choice of five color palettes: Black, Blue, White, Vivid and 8 color. The first four palettes display more detail, and each color covers a 1.5 dB signal range. The 8 color palette displays less detail, and each color covers a 3 dB signal range.

### Interference filter

- No filter, normal setting.
- Filters the echo signal to remove spiky interference such as engine noise or depth sounders on nearby boats.

### Noise filter

Averages the echo signal to remove rapid changes. Select Medium or High to give a smoother bottom trace—this may help to detect a deeper bottom; however these settings may also remove fish echoes. Select Off for best fishfinding.

### Pulse length

This can be used to specify the length of the transmitted ultrasonic pulse. A short pulse length improves the display detail but contains less energy, therefore it does not penetrate as deeply into the water as a longer pulse.

There is a choice of Auto, Short, Medium or Long. The Auto setting is recommended.

### Pulse power

This can be used to specify the power output of the transmitted ultrasonic pulse. Low power output conserves the battery and produces a clear display in shallow water.

There is a choice of Auto, Low, Medium or High. The Auto setting is recommended.

## 17-4 Setup > GPS

Press **MENU** twice, then select GPS:

GPS	
GPS source	NMEA
DGPS source	WAAS/EGNOS
Restart GPS	
Static navigation	Off
Speed filter	5
Course filter	4

### GPS Source

- **NMEA:** Use the external GPS antenna supplied or an external GPS or DGPS source connected via NMEA (see section 18-10).
- **NavBus:** Use an external GPS or DGPS source connected via NavBus (see section 18-9).

### DGPS Source

Enables or disables the satellite based DGPS correction (see section 7). The options are None or WAAS/EGNOS. Do not enable WAAS/EGNOS outside their coverage areas or the accuracy of the position might be degraded.

WAAS covers all of the USA and most of Canada. To use WAAS, the GPS antenna must have a clear view of the sky towards the equator. EGNOS will cover most of Western Europe when it becomes operational.

### Restart GPS

Restarts the internal GPS receiver for servicing or troubleshooting. The GPS receiver takes up to three minutes to restart. The satellite window

shows the status of the GPS receiver (see section 7). Restart the GPS if the receiver has not been used for some time and is taking a long time to get a GPS fix.

### Static Navigation

When the boat stops or moves very slowly, the calculated GPS speed and course become erratic. Static navigation allows the erratic values to be filtered:

- 0.01 to 99.9: If the boat speed is slower than this, the speed is displayed as zero and the course stays unchanged.
- 0 (Off): The calculated speed and course are always used.

### Speed and Course Filter

Waves and wind cause the boat speed and course to fluctuate slightly. To give stable readings, the 657 calculates these values by taking several measurements and averaging them.

- A lower value averages measurements over a shorter period of time. This gives the most accurate value but has the most fluctuations.
- A higher value averages measurements over a longer period of time. This gives the most stable value but will ignore some [true] sudden speed changes.

Set the Speed and Course filters to the lowest values which give stable readings. The range of each filter is 1 to 60 seconds or Off (0).

## 17-5 Setup > Fuel

### WARNING

Fuel consumption can change drastically depending upon the boat loading and the sea conditions. Always carry adequate fuel for the journey, plus a reserve.

Fuel functions require optional fuel flow sensors to be installed. Press **MENU** twice, then select Fuel:

Fuel	
Source	Gasoline
Num engines	1
Num tanks	1
Setup engines	▶
Setup tanks	▶
Diesel sensors	
Fuel consumption curve	▶
Speed source	Ground speed
Max fuel flow	26 G
Max RPM	3000

## Source

Select the fuel flow sensors to use if the boat has more than one set of fuel sensors. Normally select Auto.

## Num engines

Set the number of engines, or select 0 to disable the fuel functions. If there are two engines they are called port and starboard.

## Num tanks

Set the number of fuel tanks. If there are two tanks they are called port and starboard.

## Setup engines

If the boat has more than one engine, select Engine and select each engine in turn.

For the selected engine, you can enter:

Setup engines	
Engine	Single
From tank	Single
Calibrate	
Flow filter	5
Clear used	
Used	0.0 G

**From tank:** The fuel tank the engine is connected to.

**Flow filter:** Most engines do not draw fuel from the tank at a steady rate. To give a stable fuel flow reading, the TRACKER calculates the flow by taking several measurements and averaging them. Use the Flow filter to set the period over which the fuel flow is averaged.

The Flow filter can be set from 0 to 30 seconds. Use the lowest value which gives a stable flow. Usually a value of 5 to 10 seconds will give a satisfactory result for two-stroke carburettor engines. Fuel injected or four-stroke engines may require a larger value.

This setting affects the Fuel flow and Fuel economy reading on the Fuel window but it does not affect the Fuel used reading.

## Setup tanks

If the boat has more than one tank, select Tank and select each tank in turn.

For the selected tank, you can enter:

Setup tanks	
Tank	Single
Add fuel	
Fill tank	
Set remaining	0 G
Tank alarm	<input type="checkbox"/>
Tank alarm	Off
Tank size	0 G

## Add fuel, Fill tank, Set remaining:

See section 12-3.

**Tank alarm:** See section 12-4.

**Tank size:** The tank capacity. Northstar recommends measuring tank size by draining the fuel tank, filling it to capacity and using the fuel dispenser's reading. Beware of air pockets, especially in underfloor tanks.

## Fuel consumption curve

See section 10-6.

## Speed source

If both water speed and ground speed are available, select which to use for fuel calculations (see section 10-5-1).

## Max fuel flow

The maximum fuel flow from a fuel tank to be displayed on an analog fuel flow gauge (see section 8)

## 17-6 Setup > Track

Press **MENU** twice, then select **Track**:

Track	
<b>Record</b>	<b>1</b>
<b>Display</b>	<b>1</b>
<b>Plotting interval</b>	<b>Distance</b>
<b>Distance</b>	<b>0.1 nm</b>
<b>Time</b>	<b>10 sec</b>
<b>Memory used</b>	<b>0%</b>
<b>Send track</b>	
<b>Delete track</b>	

Tracking records and displays the boat's course on the chart (see section 3-5). Five different tracks can be recorded: track 1 has up to 2000 points and tracks 2, 3, 4 and 5 have up to 500 points each.

### Record

**Off:** The 657 stops recording a track.

**1 to 5** (select a track number): The 657 starts recording the boat's course into the selected track.

### Display

**Off:** No track is shown on the chart.

**1 to 5** (select a track number): The selected track is shown on the chart.

### Plotting Interval

Select the plotting and recording interval. The options are **Distance** or **Time**.

#### Distance

Select the distance plotting interval: 0.01, 0.05, 0.1, 0.5, 1.0, 2.0, 5.0 or 10.0 distance units.

#### Time

Select the time plotting interval: 1, 5, 10 or 30 seconds or 1 minute.

### Memory used

The percentage of memory used in the track being recorded.

**Tip:** Use the user card window to check the number of points recorded in each track (see section 14).

### Send track

This option is included for compatibility with older units. For information, see your Northstar dealer.

### Delete track

The data in the track selected for Record (see above) is deleted.

## 17-7 Setup > AIS

**Note:** This feature requires an AIS receiver.

AIS	
Filter by distance	300 nm
Filter by speed	0 kn
Show dangerous only	<input type="checkbox"/>
Dangerous vessel alarm	<input type="checkbox"/>
TCPA limit	2 min
CPA limit	0.1 nm
Projected course	Off

There are multiple methods to filter AIS vessels that are displayed onto the charts.

### **Filter by distance**

Vessels outside the radius selected from our current position is filtered off the chart. Default value is set to 300 nm allowing all vessels to be displayed onto the chart within that distance.

### **Filter by speed**

Vessels with speed below value selected by user is filtered off the charts. Default is set to 0 kn allowing all vessels to be displayed onto the chart.

## 17-8 Setup > Logs

Press **MENU** twice, then select Logs:

Logs	
Reset trip dist	
Reset total dist	
Reset engine hours	
Trip dist	0.00 nm
Total dist	0.00 nm
Engine hours	0.0 hrs

The values can be reset independently of each other. These log values are saved when the unit is turned off.

### **Show Dangerous Only**

Show vessels that have a TCPA/CPA below the trigger values. This filter will override any other filter option.

### **Dangerous Vessel Alarm**

When enabled an alarm will activate when both the TCPA and CPA is less than the trigger values. Even when this setting is disabled the dangerous vessels will still be indicated on the chart.

### **TCPA Limit**

Set the Time of Closest Point of Approach limit.

### **CPA Limit**

Set the Closest Point of Approach limit.

### **Projected Course**

Show the estimated course of all vessels based on their current SOG and COG.

### **Reset trip dist**

This resets the trip distance to zero.

### **Reset total dist**

This option resets the total distance to zero.

### **Reset engine hours**

Use this option to reset the engine hours to zero. This can be useful after an engine service or to count the engine hours between service intervals.

## 17-9 Setup > Alarms

Press **MENU** twice, then select **Alarms**:



All alarms except **Loss of GPS fix** can be turned on (enabled) or off (disabled).

For all alarms select  to turn the alarm on or select  to turn the alarm off.

For most alarms there is a trigger value. The alarm will sound each time the alarm value equals the trigger value. For example, the **Danger** alarm will sound if the boat comes closer to a danger waypoint than the trigger value and the **Anchor** alarm will sound if the boat moves by more than the trigger value.

Icons for alarms that are on can be displayed in the data header (see section 2-7-3). An alarm icon is normally black and turns red when the alarm sounds.

Symbol	Alarm	Alarm sounds when it is on and the:
	Arrival radius	Boat is closer to the destination or to a waypoint than the alarm trigger value
	Anchor alarm	Boat moves by more than the alarm trigger value
	XTE	Boat moves off course by more than the CDI scale (see section 14-2)
	Danger	Boat comes closer to a danger waypoint than the alarm trigger value
	Loss of DGPS fix	657 can not receive the DGPS signal (beacon, WAAS or EGNOS)
	Loss of GPS fix	657 can not receive the GPS signal (this alarm is always on)
	Loss of AIS receiver communication	657 is no longer receiving communication from the AIS receiver (Alarm is on when AIS is enabled)
	Fish	Echo matches the profile of a fish
	Too shallow	Depth is less than the alarm trigger value
	Too deep	Depth is greater than the alarm trigger value
	Temperature	Temperature equals the alarm trigger value
	Temperature rate	Rate of change of temperature equals the alarm trigger value
	Low battery	Battery voltage is less than the alarm trigger value
	Low fuel	Fuel remaining equals the alarm trigger value

## 17-10 Setup > Units

Press **MENU** twice, then select Units:

Units	
Distance	nm
Distance small	ft
Speed	kn
Depth	ft
Fuel	USGal
Compass	°M
Temperature	°F
Wind	TRUE
Pressure	kPa
Baro	mB

The default units are shown above.

### Distance

nm (nautical miles), mi (miles) or km (kilometres)

### Speed

kn (knots), mph (miles per hour) or kph (kilometres per hour)

### Depth

ft (feet), m (metres) or fa (fathoms)

## 17-11 Setup > Comms

Use this feature when the 657 is connected to other Northstar instruments through NavBus or any compatible NMEA instrument.

Press **MENU** twice, then select Comms:

Comms	
NMEA out	<input type="checkbox"/>
NMEA data	<input type="checkbox"/>
Lat/Lon d.p.'s	3
NavBus	<input checked="" type="checkbox"/>
NavBus group	0

### NMEA out

NMEA is generally used with third party instruments (see section 18-10). Select this to transmit NMEA sentences, for example to an autopilot.

### NMEA data

Use this to specify which NMEA sentences will be transmitted (see section 18-10 and Appendix A).

### Height

ft (feet) or m (metres)

### Fuel

Litres, USGal (US gallons) or ImpGal (Imperial Gallons)

### Compass

°T (True north) or °M (Magnetic north)

### Temperature

°F (Fahrenheit) or °C (Celsius)

### Wind (optional)

Requires a wind instrument: True or App (Apparent)

**Note:** that the units for wind speed are the speed units.

### Pressure

Requires SmartCraft™: kPa or psi

### Baro (Barometric pressure)

Requires a Northstar VHF receiver with barometer connected by NavBus: InHg or mB.

### Lat/lon dps

Select the number of decimal points used for latitude and longitude transmitted in NMEA sentences.

### NavBus

NavBus is the preferred method for connecting the 657 to other Northstar instruments. Select this if the instruments are connected using NavBus.

### NavBus Group

Use this when a group of Northstar instruments are connected together using NavBus, to specify a group of instruments for backlighting, if required. Then, if the backlight setting on one instrument in the group is adjusted, the other instruments change automatically. Otherwise, select 0. See section 18-9.

## 17-12 Setup > Calibrate

Press **MENU** twice, then select Calibrate:

Calibrate	
<b>Speed</b>	
Speed filter	Off
Temperature	
Temp filter	5 sec
Keel offset	0.0 ft
Speed range	Low

### Speed

This calibrates the speed from a paddlewheel sensor connected to the 657. Calibration may be required because different hull shapes have different flow characteristics. Obtain an accurate measurement of the boat's speed from a GPS receiver; or by following another boat travelling at a known speed; or by making a timed run over a known distance.

**Note:** for accurate calibration:

- The speed from a GPS receiver should be greater than 5 knots.
- The speed from another paddlewheel transducer should be between 5 and 20 knots.
- Best results are achieved in calm conditions where there is minimal current (best at high or low tide).

### Calibrating speed:

- 1 Travel at a constant, known speed.
- 2 In the Calibrate menu, select Speed.
- 3 Press **◀** or **▶** to change the displayed speed to the true value.
- 4 Press **ENT**.

### Speed filter

Waves and wind cause the boat speed from the paddlewheel transducer to fluctuate slightly. To give stable readings, the 657 calculates these values by taking several measurements and averaging them. Set the Speed filter to the lowest value which gives stable readings. The range is 1 to 30 seconds or Off (0).

### Temperature

The factory settings should be sufficiently accurate for normal usage. To calibrate the temperature readout, first measure the water temperature with a thermometer known to be accurate.

Use the cursor keys to display the temperature readout box, then increase or decrease the value to match the measured temperature. The temperature can be set from 32° to 99.9°F (0° to 37.7°C) with a resolution of 0.1° unit.

To change the units between °F (Fahrenheit) or °C (Celsius). (see section 17-10).

### Temperature filter

Water turbulence and currents cause the water temperature to fluctuate slightly. To give stable readings, the 657 calculates these values by taking several measurements and averaging them. Set the Temperature filter to the lowest value which gives stable readings. The range is 1 to 30 seconds or Off (0).



## Keel Offset

A depth transducer measures depths below where the transducer is mounted on the boat, usually the bottom of the boat. The 657 calculates the depths to display by adding the keel offset to all measured depths.

- A Have a zero keel offset to display depths below the transducer.
- B Enter a positive keel offset to increase the displayed depth. For example to display the total depths below the surface, enter the depth of the transducer below the surface.
- C Enter a negative keel offset to decrease the displayed depth. For example, to display the depths of clear water below the boat, enter minus the depth of the deepest part of the boat below the transducer.

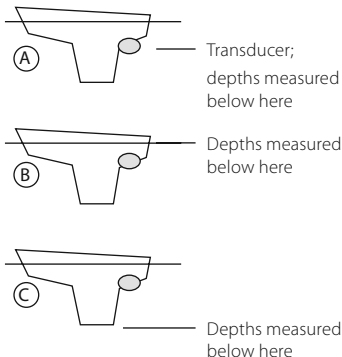

## Speed range

The maximum reading to display on an analog boat speed gauge (see section 10). Choose a range suitable for your boat.

## Fuel

See section 12-7, Calibration.

## 17-13 Setup > Time

Press **MENU** twice, then select Time:

Time	
Local offset	+00:00
Time format	24 hour
Date format	dd/MMM/yy

### Local offset

The difference between local time and UTC (GMT). Change local offset when daylight saving time starts and ends. The range is 0 to  $\pm$  13 hours, in 30 minute steps.

- 1 Select Local offset.
- 2 Press **▲** or **▼** to change the offset, then press **ENT**.

### Time format

The options are 24 hour or 12 hour.

### Date format

The options are dd/MMM/yy, MMM/dd/yy, dd/MM/yy or MM/dd/yy.

## 17-14 Setup > Favorites

Favourites	
Name	
1	Chart + Sonar
2	Chart + Gauges
3	-
4	-
5	-
6	-
<b>MENU</b> for options	

See section 2-7-2

## 17-15 Setup > Simulate

Simulate mode is a way of becoming familiar with the 657 (see section 2-6).

Press **MENU** twice, then select Simulate:

Simulate	
Simulate	<input type="checkbox"/>
Mode	Normal
Speed	1.0 kn
Course	0 °M
Route	

### Simulate

- Turn simulate mode off  
 Turn simulate mode on

### WARNING

Never have simulate mode on when the 657 is navigating on the water.

### Mode

There are two choices for Mode:

### 1 Normal

Simulates the boat moving from the selected start point at the given speed and heading. The options required for Normal are:

**Speed:** The simulated boat speed to use.

**Course:** The simulated course over ground.

**Note:** To select the start point, go to the chart window before starting the simulation. Then:

- To start the simulation from the boat position, press **ESC** to switch to center on boat mode.
- To start the simulation from a different point, move the cursor to that point on the chart.

**Tip:** To calculate a course, use the cursor (see section 3-3).

**Tip:** As the boat moves, vary Course to simulate the boat moving off course.

### 2 Demo

Simulates a boat moving along a route and automatically displays different 657 functions. The options required for Demo are:

**Speed:** The simulated boat speed to use.

**Route:** The route to follow.

## 18 Installation

Correct installation is critical to the performance of the unit. It is vital to read the entire installation section of this manual and the documentation that comes with the antenna and any other units before starting installation.

### WARNING

Ensure that any holes cut are in a safe position and will not weaken the boat's structure. If in doubt, consult a qualified boat builder.

### CAUTION











Do not mount any part where it can be used as a hand hold, where it might be submerged or where it will interfere with the operation, launching or retrieving of the boat.

To help ensure proper operation, do not mount any part or cable within 0.5 m (20") of the plane of a radar antenna or within 1 m (3 ft) of a compass or source of electrical noise, such as engines, fluorescent lights, and power inverters.

When fitting a cable, do not crush or strain the cable. Secure the cable at regular intervals. Ensure no connectors or exposed terminals are in wet area.

If the cables supplied are too long, do not shorten the cable; instead coil the cable. Most cables can be extended with Northstar extension cables. Do not fit more than one extension cable.

## 18-1 Installation: What comes with the 657

657 display unit, with a holder for plug-in cards and blanking cap for fuel connector.	
Dust cover for display unit	
Power cable	
Mounting bracket (screws included)	
GPS connection cable	
Warranty registration card	
Northstar 124 GPS antenna	
Flush mounting kit	
Dual frequency transom sonar transducer (includes cable kit and screws)	
Transom Mount Transducer Installation Manual	
Full Instruction Manual CD	

## 18-2 Installation: Options and Accessories

- Replacement paddle wheel
- C-MAP™ NT-MAX, NT+ or NT chart cards.
- C-MAP™ user cards (3 V) for storing data. (The older 5 volt cards are not supported)
- Northstar carry bag.
- Northstar NavBus junction boxes simplify wiring, particularly if several instruments are connected. For more information, see the *NavBus Installation Manual*.

### Optional sensors and instruments

**External alarms:** Lights or sounders in the boat to sound alarms through the boat (see section 18-4).

**GPS or DGPS antenna:** For GPS navigation (see section 18-5).

**Sonar transducer:** For depth sounding and fish finding (see section 18-6).

**Fuel sensors:** For fuel functions. The 657 can use these optional fuel flow sensors, fitted to one or two engines:

- Northstar petrol/gasoline sensors (see section 18-7)
- SmartCraft™ fuel sensors (see section 18-10)

**DSC VHF radio:** Tracks other boats with GPS receivers and DSC radios and displays barometric pressure (see section 18-8).

**SmartCraft™:** With one or two SmartCraft™ capable Mercury petrol/gasoline engines, the 657 can display engine data and trim and can control troll speed (see section 18-10).

**Other instruments:** The 657 can receive data from other instruments and send data to other instruments by NavBus or NMEA (see sections 18-11 and 18-12).

Please consult your Northstar dealer for more information.

## Connections

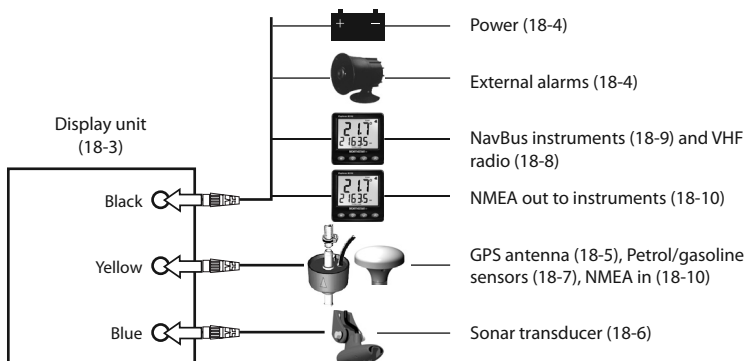

### Power/data cable

Pin	Wire	Function
1	Black	Ground: - power in, NMEA ground. (The cable has two black wires which are connected inside the cable and it does not matter which black wire you use)
2	Brown	Not used
3	White	NMEA out
4	Blue	NavBus-
5	Red	Power in, +10.5 V DC to +30.5 V DC
6	Orange	NavBus+
7	Yellow	Auto power in
8	Green	External alarm out, 30 V DC 200 mA maximum.

### 18-3 Installation: The display unit

Select a position for the display unit:

- At least 4" (100 mm) away from the compass, at least 12" (300 mm) away from any radio transmitter and at least 4 ft (1.2 m) away from any antenna.
- Easy to read and operate. If possible, mount the display unit in front of the navigator or to the right of the navigator because the LCD display is more readable from these positions.
- Not exposed to the direct sun or water and protected from physical damage during rough sea passages.
- Easy to access the power source and convenient to route the transducer cables.

There are two mounting arrangements:

#### 1 Flush Mounting

Requires a solid panel with access behind for wiring and mounting screws. After flush mounting, the display unit cannot be tilted or moved after installation to reduce any unwanted glare or reflections. Carefully select the best viewing position before installation. This would generally be in a shaded area.

- 1 Cut a hole in the bulkhead for the display unit using the flush mount template.
- 2 Drill four holes for the mounting studs using the flush mount template.
- 3 Screw the four studs into the brass inserts in the back of the display unit.
- 4 Sit the display unit in place and fit the washers and nuts to the studs.

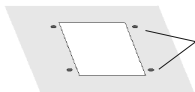

#### 2 Bracket Mounting

Requires a panel for mounting the bracket. Ensure that the panel is not likely to deform and is not subject to excessive vibration. The bracket can be tilted and rotated. The display unit can be removed when it is not in use.

- 1 Hold the bracket in place and mark the screw holes.
- 2 Drill the screw holes and screw the bracket in place. Do not overtighten the screws or the display unit might not rotate.
- 3 Hold the display unit in place on the mounting bracket shaft. Hand tighten the knob on the mounting bracket.



## 18-4 Installation: Power/data cable

The power/data cable has a black locking collar and flying leads.

- 1 Wire the 657 for auto power to have the 657 turn on with the boat's ignition switch or to record engine hours or if the 657 must add up the total fuel used (for example if Northstar petrol/gasoline fuel sensors are installed or if SmartCraft™ is installed without fuel tank level sensors). Otherwise wire for basic power (for more information, see section 2-2).

### Basic power

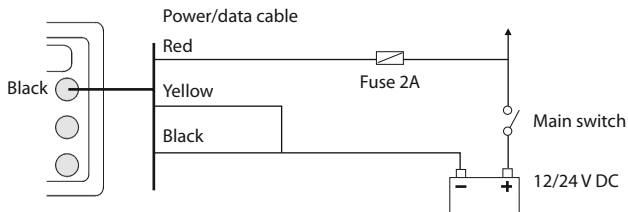

### Auto power

During setup, set up Auto power off (see sections 2-2 and 17-1)

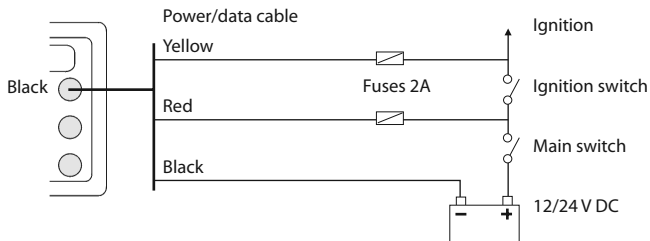

- 2 Wire any external alarm beepers or lights. The alarm output switches to ground to sound the alarm. If the current is more than 200 mA, fit a relay.
- 3 Connect the power/data cable to the black display unit connector; turn the collar to lock the connector.

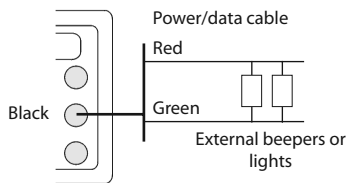

## 18-5 Installation: GPS antenna

### Selecting an antenna

Fit one of these GPS antennas:

- Normally use the GPS antenna supplied.
- An optional differential beacon DGPS antenna to give enhanced accuracy within range of land based differential beacons in areas where WAAS or EGNOS are not available. Such a DGPS antenna has both a GPS receiver and a beacon receiver, and it automatically applies the beacon correction to the GPS position.
- A compatible GPS or DGPS instrument or antenna connected by NavBus (see section 18-9) or NMEA (see section 18-10). In this case, the 657 does not need its own antenna.

#### Note:

- To configure the 657 for different antenna options, see section 17-4.

For more information, contact your Northstar dealer.

#### DGPS Source:

Enables or disables the satellite based DGPS correction (see section 7). The options are **None** or **WAAS/EGNOS**. Do not Enable WAAS/EGNOS outside their coverage areas or the accuracy of the position might be degraded.

WAAS covers all of the USA and most of Canada. To use WAAS, the GPS antenna must have a clear view of the sky towards the equator. EGNOS will cover most of Western Europe.

### Restart GPS:

Restarts the GPS receiver, satellite reception will be lost until the receiver completes its restart and acquires the satellites.



MOB will not work if the Instrument does not have a GPS fix.

Select restart GPS and press **ENT**

### Installing an antenna

If an external antenna is required, install the antenna and fit the antenna cable back to the display unit. Follow the instructions in the manual supplied with the antenna. Fit an optional Northstar extension cable if required.

If a SmartCraft™ system or Northstar petrol/gasoline sensors are fitted as well, fit a AIS cable:

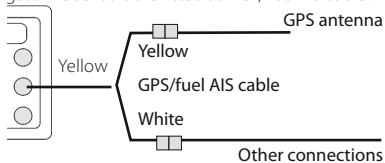

Otherwise:



During setup, configure the 657 for the chosen antenna, see section 17-4.

## 18-6 Installation: Sonar transducer

### **⚠ WARNING**

Do not install plastic through hull transducers in solid wooden hulls. Leakage through the hull may result.

Do not install bronze transducers in metal hulls. This will cause electrolytic corrosion that may result in damage to the hull or transducer.

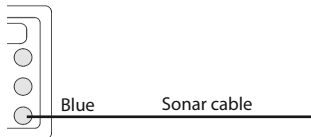

Either:

- Fit the transom mount sonar transducer supplied, following the instructions in the Transom Mount Transducer Installation Manual supplied with the 657.
- For enhanced performance, fit an optional through hull dual frequency sonar transducer and through hull speed/temperature transducer. Contact the nearest Northstar dealer for more information.

Connect the transducer to the blue 657 connector; tighten the locking collar.

During setup

- a set Sonar to  (see section 17-1)
- b set up the sonar options (see section 17-3)

## 18-7 Installation: Northstar petrol/gasoline sensors

Fit the optional petrol/gasoline fuel kit following the instructions supplied with the kit.

Note:

- SmartCraft™ engines have fuel flow sensors, therefore Northstar fuel sensors are not required as well.
- For dual engines, fit two kits.
- Wire the 657 for auto power (see section 18-4).
- An optional GPS/fuel AIS cable is required.

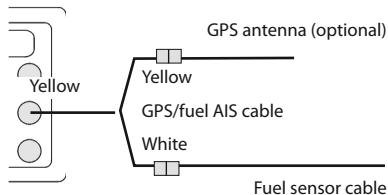

During setup:

- a set up Auto power off (see sections 2-2 and 17-1)
- b set the fuel data (see section 17-5)



## 18-8 Installation: SmartCraft™

If the boat has one or two SmartCraft™ capable Mercury petrol/gasoline engines, connect the 657 to the SmartCraft™ engines with an optional SmartCraft™ gateway. The display unit can display engine data and trim and can control troll speed.

### Note:

- Fit a single gateway for single engines and a dual gateway for dual engines.
- SmartCraft™ engines have fuel flow sensors, therefore Northstar fuel sensors are not required as well.
- An optional GPS/fuel splitter cable is required.
- If the fuel tank does not have SmartCraft™ level sensors, wire for auto power (see section 18-4).

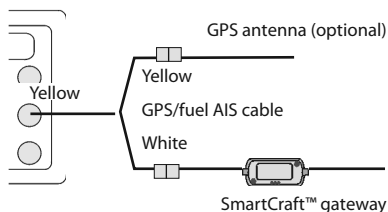

Enter the SmartCraft™ setup data. For information on installing, setting up and using SmartCraft™, see the *SmartCraft™ Gateways Installation and Operation Manual*.

## 18-9 Installation: Other NavBus instruments

NavBus is Northstar's system for connecting instruments together to interchange data and share transducers. When instruments are connected by NavBus:

- If the units, alarms or calibration are changed in one instrument, then the values will automatically change in all other instruments of the same type.
- Each instrument can be assigned to a group of instruments. If the backlight is changed in an instrument in group 1, 2, 3 or 4 then the backlight will automatically change in the other instruments in the same group.  
If the backlight is changed in an instrument in group 0 then no other instruments are affected.
- If an alarm sounds, mute it by clearing the alarm on any instrument which can display that alarm.

### NavBus and the 657

The 657 can:

- Display wind speed and direction from an optional Northstar Wind instrument.
- Receive and display depth from an optional Northstar depth instrument.
- Receive and display boat speed and water temperature from a paddlewheel sensor on an optional Speed instrument.
- Receive data from an optional Northstar VHF radio (with NavBus functionality). The 657 can display:

**Baro:** barometric pressure

**Baro history:** barometer history

**Weather:** a prediction, based on changes in barometric pressure

**Fish forecaster:** a prediction based on changes in barometric pressure

**DSC/Buddy Track:** (see section 16)

- Receive data from an optional GPS or GPS/DGPS source.
- Send data to optional Northstar instruments, for example to a repeater.

During setup for NavBus instruments, set NavBus to  and assign the instrument a NavBus group number (see section 17-11)

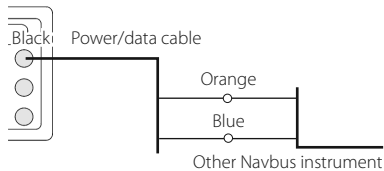

### 18-9-1 Installation: Northstar VHF radio

Fit and set up the optional Northstar VHF radio (with NavBus functionality) following the instructions supplied with the radio.

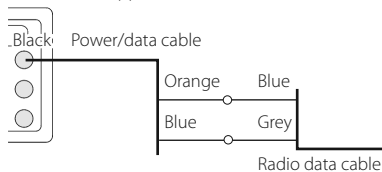

### 18-10 Installation: Other NMEA instruments

NMEA is an industry standard for interconnecting instruments. It is not as flexible or as easy to install as NavBus.

The 657 can:

- Receive and display wind speed and direction from an optional compatible wind instrument.
- Receive and display depth, paddlewheel boat speed and water temperature from an optional compatible instrument.
- Receive data from an optional compatible GPS or GPS/DGPS source.
- Send GPS position and other navigation data to an autopilot or other instrument. An autopilot requires APB, APA and VTG sentences (see section 17-11).
- Receive data from an optional AIS receiver.

For information on sending NMEA data to the 657, see your Northstar dealer.

During setup to send NMEA data to other instruments, set NMEA out to  and specify the NMEA data to send (see section 17-11).

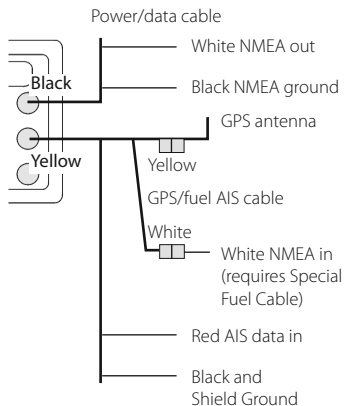

## 18-11 Installation: Setup and test

---

### Setup and test

- 1 Put a blanking cap on any unused connector on the back of the display unit. Ensure all connectors are plugged in and the display unit is in place.
- 2 If the display unit is bracket mounted, adjust tilt and rotation for best viewing and hand tighten the knob.
- 3 Insert any required C-MAP chart card (see section 1-3).
- 4 Turn the instrument on (see section 2-2). When the 657 is turned on for the first time, it displays an installation menu:
  - i Select the language to use.
  - ii Change the data if necessary (see section 2-1)
  - iii When the setup data is correct, press .
- 5 Enter setup data to set up the 657 to your requirements and to set up any optional sensors or instruments (see section 17).
- 6 At the satellite display, check that it picks up GPS satellites. Wait for the GPS receiver to start up and the fix type to change from 'Acquiring' to 'GPS fix'. This should take less than two minutes (see section 7).
- 7 Go on a test run to check that the navigation equipment works correctly, particularly when a radio transmitter or radar is used.

This data can be changed later (see section 17).

## Appendix A - Specifications

### GENERAL

Size: 5.9" H x 6.5" W x 2.6" D  
(150mm H x 164mm W x 65mm D)

**Display:** 127 mm (5") diagonal, TFT color, 480 x 640 pixels.

**Backlight:** Display and keys

#### Supply voltage

10.5 V DC to 30.5 V DC.

**Supply current:** at 13.8 V

350 mA min - no backlighting.  
1 A max - full backlighting.]

**External beeper or light output:** Switched to ground to sound alarm, 30 V DC, 200 mA maximum.

#### Operating temperature

0°C to 50°C (32°F to 122°F)

### ALARMS:

- User set: Arrival radius, anchor, XTE, danger, dangerous AIS vessels, too shallow, too deep, fish, temperature, temperature rate, low battery, low fuel (optional), loss of DGPS fix
- Fixed: Loss of GPS fix

### GPS NAVIGATION

**Chart card:** C-MAP™ NT-MAX, NT+ or NT

**User card:** 3.3 V C-MAP™

**Waypoints:** Up to 3000, with default or user-defined alphanumeric names up to eight characters.

**Routes:** 25 Routes, with up to 50 points each

**Tracks:** By time or distance, one track of 2000 points and four of 500 points.

#### Chart datums

- 121 Chart datums (see next page)
- One user-defined map shift.

**Chart scale:** 0.05 to 4096 nm for chart (chart dependent) down to 0.01 nm in plotter mode.

### SONAR FISHFINDING

#### Depth range:

0.6 m (2 ft) to 1000 m (3300 ft)

#### Sonar output:

- Power: Variable, up to 600 W RMS
- Dual frequency: 50 khz and 200 khz

#### Transom transducer cable length:

10 m (33 ft)

#### Depth acquisition time from startup:

Typically 2 seconds at 30 m (100 ft)

#### Temperature:

- Range 0° to 37.7°C (32° to 99.9°F)
- Resolution of 0.1° unit.

#### Speed (from paddlewheel transducer):

1 to 96.6 kph (57.5 mph, 50 kn).

### FUEL COMPUTER

(Optional fuel sensor(s) required)

#### Engine types:

- Outboard carburetted two stroke and EFI petrol/gasoline engines: 50 to 300 hp.
- Outboard four stroke petrol/gasoline engines: 90 to 300 hp.
- Inboard petrol/gasoline engines: 70 to 400 hp.

#### Flow rate:

- Minimum: 5 litres per hour (1.3 U.S. gallons per hour).
- Maximum: 130 litres per hour (34 U.S. gallons per hour).

### COMMUNICATIONS

#### NavBus

Connection to other Northstar instruments.

#### NMEA

NMEA 0183 ver 2 4800 baud

- Inputs from compatible instruments: BWR, DPT, GGA, GLL, GSA, GSV, HDG, HDM, HDT, MTW, MWW, RMC, VHW, VTG and DBT
- Outputs, for compatible instruments: APA, APB, BWR, DBT, DPT, GGA, GLL, GSA, GSV, RMB, RMC, MTW, VHW, VLW, VTG, XTE

### STANDARDS COMPLIANCE

#### EMC:

- USA: FCC Part 15 Class B.
- Europe: (CE) EN64000-6-1 and EN64000-6-3
- New Zealand and Australia: (C Tick) AS-NZS 3548.

**Environment:** IPx6/IPx7/CFR46 (with card holder and connections in place)

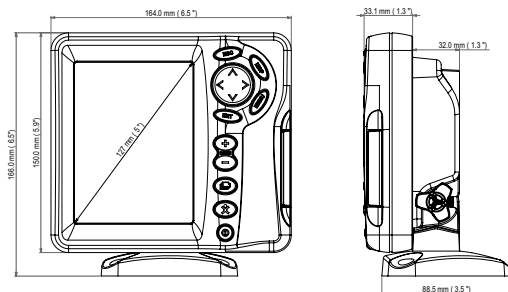

### List of datums

Adindan	Afgooye	AIN EL ABD 1970
American Samoa 1962	Anna 1 Astro 1965	Antigua Island Astro 1943
ARC 1950	ARC 1960	Ascension Island 1958
Astro Beacon 'E' 1945	Astro DOS 71/4	Astro Station 1952
Astro Tern Island (Frig) 1961	Australian Geodetic 1966	Australian Geodetic 1984
Ayabelle Lighthouse	Bellevue (IGN)	Bermuda 1957
Bissau	Bogota Observatory	Bukit Rimpah
Camp Area Astro	Campo Inchauspe 1969	Canton Astro 1966
Cape	Cape Canaveral	Carthage
Chatham Island Astro 1971	Chua Astro	Co-ord. Sys.1937 Estonia
Corrego Alegre	Dabola	Deception Island
Djakarta (Batavia)	DOS 1968	Easter Island 1967
European 1950	European 1979	Fort Thomas 1955
Gan 1970	Geodetic Datum 1949	Graciosa Base Sw 1948
Guam 1963	Gunung Segara	GUX 1 Astro
Herat North	Hermannskogel	Hjorsey 1955
Hong Kong 1963	Hu-Tzu-Shan	Indian
Indian 1954	Indian 1960	Indian 1975
Indonesian 1974	Ireland 1965	ISTS 061 Astro 1968
ISTS 073 Astro 1969	Johnston Island 1961	Kandawala
Kerguelen Island 1949	Kertau 1948	Kusaie Astro 1951
L. C. 5 Astro 1961	Leigon	Liberia 1964
Luzon	M'Poraloko	Mahe 1971
Massawa	Merchich	Midway Astro 1961
Minna	Montserrat Island Astro 1958	Nahrwan Masirah Is. Oman
Nahrwan United Arab Emirates	Nahrwan Saudi Arabia	Naparima, BWI
North American 1927	North American 1983	North Sahara 1959
Observatorio Meteorolog. 1939	Old Egyptian 1907	Old Hawaiian
Oman	Ord. Survey Great Britain 1936	Pico de las Nieves
Pitcairn Astro 1967	Point 58	Pointe Noire 1948
Porto Santo 1936	Provis. South American 1956	Provis. South Chilean 1963
Puerto Rico	Pulkovo 1942	Qatar National
Qornoq	Reunion	Rome 1940
S-42 (Pulkovo 1942)	Santo (DOS) 1965	Sao Braz
Sapper Hill 1943	Schwarzeck	Selvagem Grande 1938
Sierra Leone 1960	S-JTSK	South American 1969
South Asia	Tananarive Observatory 1925	Timbalai 1948
Tokyo	Tristan Astro 1968	Viti Levu 1916
Voirol 1874	Voirol 1960	Wake Island Astro 1952
Wake-Eniwetok 1960	WGS 84	Yacare
Zanderij		

## Appendix B - Troubleshooting

---

This troubleshooting guide is written with the assumption that the user has read and understood the relevant sections in this manual. It is possible in many cases to solve difficulties without having to send the display unit back to the manufacturer for repair. Please follow this troubleshooting section before contacting the nearest Northstar dealer.

There are no user serviceable parts. Specialized methods and testing equipment are required to ensure that the display unit is reassembled correctly and is waterproof. Users who service the product themselves will void the warranty.

Repairs to the product may only be carried out by a service center approved by Northstar. If the product must be sent into a service center for repair, it is essential to send in the transducer(s) at the same time.

More information can be found on our website: [www.northstarnav.com](http://www.northstarnav.com).

### B-1 General problems

---

#### 1-1 The 657 won't turn on:

- a The 657 is designed to operate on a 12/24 volt battery system, where the voltage may vary from 10.5 to 30.5 volts. If an excessive voltage is supplied, a fuse will be tripped, turning the display unit off. Check the fuse.
- b Check that the power cable connector at the back of the display unit is securely plugged in and the collar is locked in place. The collar must be secure for watertight connection.
- c Measure the battery voltage while the battery is under load - turn on some lights, radio or other electrical equipment connected to the battery. If the voltage is less than 10 volts:
  - the battery terminals or wiring on the terminals may be corroded.
  - the battery may not be charging correctly or may need replacing.
- d Inspect the power cable from end to end for damage such as cuts, breaks, squashed or trapped sections.
- e Check power wiring (see section 18-4).
- f Check for corrosion on the power cable connector and clean or replace if required.
- g Check fuses that are placed in line with the power cable. A fuse can be blown despite appearing to be good or the fuse may be corroded. Test the fuse or replace it with a fuse known to be good.

#### 1-2 The 657 won't turn off:

The 657 may have been wired for Auto power. In this case, the 657 cannot be turned off while the ignition power is on (see section 2-2).

#### 1-3 If the 657 beeps when turned on but nothing is displayed:

The 657 may be operating, but the backlight settings may have been set too low (see section 2-3).

#### 1-4 The wrong language is displayed:

See section 17-1.

## B-2 GPS navigation problems

---

### 2-1 No GPS fix or long time to get fix at startup:

- a May occur occasionally if the antenna does not have a clear view of the sky. The satellite positions are constantly changing.
- b Antenna cable not connected to display unit.

### 2-2 657 GPS position different from true position by more than 10 m (33 ft):

- a 657 in simulate mode. Turn simulate mode off (see section 17-15).
- b The normal error in GPS position will exceed 10 m (33 ft) for about 5% of the time.
- c Under special circumstances the US Department of Defence may introduce a deliberate and changing error in the GPS positions of up to 300 m (1000 ft).

### 2-3 657 position different from same position on local charts:

- a 657 in simulate mode. Turn simulate mode off (see section 17-15).
- b Incorrect chart datum. Select the correct chart datum (see section 17-2).
- c Map shift has been applied wrongly. Clear map shift, then reapply if necessary (see section 17-2).

### 2-4 Can not see boat on chart:

- Press **ESC** to switch to center on boat mode (see section 3-2-1).

### 2-5 The time or date on satellite window is wrong or off:

- a No GPS fix.
- b In simulate mode. Turn simulate mode off (see section 17-15).
- c Local time offset is wrong (see section 17-13). The Local Time Offset must be changed when daylight saving time starts or ends.

### 2-6 Autopilot not responding to 657; no NMEA output:

- a NMEA output disabled or the required NMEA sentences are not turned on. Check NMEA settings (see section 17-10).
- b Check that the instrument is connected correctly.

### 2-7 No DGPS fix or loss of DGPS fix:

- a To receive a DGPS fix, WAAS/EGNOS must be enabled or an optional DGPS antenna fitted (see section 7).
- b With WAAS/EGNOS: Boat out of coverage area (see section 7).
- c With WAAS: GPS antenna does not have a clear view of the horizon towards the equator.
- b With beacon DGPS: boat out of range of a DGPS beacon.

## B-3 Fuel consumption problems

---

### 3-1 Fuel used or remaining seem inaccurate:

- a 657 is not wired for auto power (see section 18-4).
- b In rough seas, fuel may surge back and forth through the fuel transducer, resulting in incorrect readings. Try installing a one-way valve between the fuel transducer and the fuel tank.
- c The Set remaining fuel value must be reset after every refuelling (see section 12-1).
- d The fuel tank may not refill to the same capacity each time due to air pockets.

This is particularly noticeable with underfloor tanks.

- e Fuel transducers wear out over time and should be replaced after every 5000 litres of fuel.

### 3-2 Flow indicates no fuel or low fuel:

- a Check that the number of engines is set to 1 (see section 17-5).
- b Check that the fuel cable connectors are securely plugged in and the collar is locked in place. The collar must be locked in place to give a watertight connection.

- c A fuel transducer may be clogged. If so, remove the transducer from the fuel line and gently blow through it in the opposite direction to the fuel flow.  
A fuel filter between the fuel transducer and the fuel tank must be installed as per the fuel installation guide. Failure to do so will void the warranty.
- d Inspect the fuel cable from end to end for damage such as cuts, breaks, trapped or squashed sections.
- e Check that the fuel filter is clean.

### 3-3 A twin engine installation shows only one flow rate:

- a Check that the number of engines is set to 2 (see section 17-5).

### 3-4 Erratic Fuel Flow readings:

- a The fuel flow transducer may have been mounted too close to the fuel pump or may be subject to excessive vibration. Refer to the installation instructions supplied with the fuel transducer.
- b Check for leaks in the fuel line or in the fuel pickup in the tank.
- c The `Flow filter` value is not suitable for the engine. Check that the value is not set to zero, then try increasing the value until a steady flow rate is shown (see section 17-5).

### 3-5 There is no reading for fuel economy:

- a The boat must be travelling through the water to generate an `Economy` reading.
- b Check that the paddlewheel on the transducer is spinning freely and that the two magnets in the paddlewheel are still in place.

## B-4 Sonar fishfinding problems

---

### 4-1 The 657 operates erratically:

- a Check that the transducer does not have debris (e.g. weed, plastic bag) caught around it.
- b The transducer may have been damaged during launching, running aground or while underway with debris etc. If the transducer has been impacted, it may have been kicked up on the bracket. If it is not physically damaged, reset the transducer back to its original position. (See the *Transom Transducer Installation Guide*.)
- c When the transducer is less than 2 ft (0.6 m) from the bottom, the depth readings may become inconsistent and erratic.
- d Manual Gain may be set too low, which may cause weak bottom echo or no fish signals. If in Manual Gain, try increasing the Gain.
- e Ensure the back of the bottom surface of the transducer is slightly lower than the front and the front is as deep in the water as possible in order to minimize the generation of bubbles through cavitation. (See the *Transom Transducers Installation Guide*.)
- f Check the transducer and power cable connectors at the back of the display unit

are securely plugged in and the collars are locked in place. The collars must be secure for watertight connection.

- g Inspect the power cable from end to end for damage such as cuts, breaks, squashed or trapped sections.
- h Ensure there is not another fishfinder or depth sounder turned on, which may interfere with this 657.
- i Electrical noise from the boat's engine or an accessory may be interfering with the transducer(s) and/or the 657. This may cause the 657 to automatically decrease the Gain unless using Manual Gain.

The 657 thus eliminates weaker signals such as fish or even the bottom from the display. This may be checked by switching off other instruments, accessories (e.g. bilge pump) and the motor until the offending device is located. To stop problems from electrical noise, try:

- re-routing the power and transducer cable(s) away from the boat's other electrical wiring.
- routing the display unit's power cable directly to the battery with an in-line fuse.



#### **4-2 Bottom is not displayed:**

- a The 657 may have Manual Range selected and the depth may be outside the range value selected. Either change the 657 to Auto Range or select another depth range (see section 8-5).
- b The depth may be outside the 657's range. While in Auto Range, the display unit will display "--" to indicate that there is no bottom detected. A display of the bottom should reappear when in shallower water.

#### **4-3 The bottom is displayed too far up the screen:**

The 657 may have Manual Range selected and the selected Range value is too high for the depth. Either change the 657 to Auto Range or select another depth range (see section 8-5)

#### **4-4 Bottom echo disappears or erratic digital reading while the boat is moving:**

- a Ensure the back of the bottom surface of the transducer is slightly lower than the front and the front is as deep in the water as possible in order to minimise the generation of bubbles through cavitation. (See the *Transom Transducers Installation Guide*, for more information.)
- b The transducer may be in turbulent water. Air bubbles in the water disrupt the echoes returned, interfering with the 657's ability to find the bottom or other targets. This often happens when the boat is reversed. The transducer must be mounted in a smooth flow of water in order for the 657 to work at all boat speeds.
- c Electrical noise from the boat's motor can interfere with the 657. Try some suppression spark plugs.

#### **4-5 There is a double bottom trace displayed:**

- a The boat may be in an area that generates shadows (see section 8-2).
- b In shallow water, the echoes may bounce. Reduce the gain setting (see section 8-6) and/or reduce the sonar pulse power (see section 17-3).
- c Decrease the Range.

## Appendix C - Glossary and navigation data

---

### Glossary

**Attention Area** - An important area on a chart, such as a restricted anchorage or a shallow area (see section 17-2).

**AIS** - Automatic Identification System. A System where vessel information (location, course, speed, etc.) is broadcast by VHF radio, for use by other vessels in navigation and collision avoidance.

**Bathymetric line** - A depth contour line on the chart.

**Chart card** - A plug-in card that stores chart data for a region (see section 1-3).

**C-MAP™ chart card** - See Chart card.

**C-MAP™ user card** - See User card.

**CPA** - Closest Point of Approach. The closest distance two vessels will come to each other based on their current course and speed.

**Cursor** - A  symbol on the display (see section 3-2).

**DGPS** - Differential Global Positioning System. A navigation tool based on GPS with some errors corrected (see section 7).

**DSC** - Digital Selective Calling. A feature of marine radios enabling communication between specific vessels, as well as distress alerts.

**Goto** - A simple way of navigating straight to a waypoint or to the cursor position (see section 3-1).

**GPS** - Global Positioning System. A satellite-based navigation tool (see section 7).

**Leg** - The straight segments of a route between waypoints. A route with four waypoints has three legs.

**MMSI** - Maritime Mobile Service Identity. Unique identification number for a vessel, for use in Digital Selective Calling.

**MOB** - Man overboard.

**MOB function** - Starts navigating back to the place where someone fell overboard (see section 2-4).

**NavBus** - A way of connecting Northstar instruments together to share data (see section 18-9).

**NMEA** - National Marine Electronics Association.

**NMEA 0183** - A standard for interfacing marine electronic devices (see section 18-10).

**Route** - Two or more waypoints linked in sequence to form a course for the boat (see section 6).

**SmartCraft** - A feature of Mercury Marine engines for monitoring engine performance.

**TCPA** - Time to Closest Point of Approach. Time until the closest point of approach for two vessels.

**User card** - A plug-in card that stores waypoints, routes and tracks (see section 1-2).

**UTC** - Universal Time Coordinated or Coordinated Universal Time, which is a standard world time, formerly called Greenwich Mean Time (GMT).

**VHF** - Very High Frequency. The frequency range used by marine radios.

**Waypoint** - A position that you can set on the 657 chart, for example a fishing spot or a point on a route (see section 5).

## Navigation data

The boat is sailing from the start to the destination and has moved off the plotted course from the start to the destination.

**BRG** Bearing to Destination: Bearing to the destination from the boat.

**†BRG** Bearing to cursor: Bearing to cursor from boat (cursor mode, see section 3-2-1 [note the -1 added there])

**CDI** Course Deviation Indicator: When the boat is navigating to a point, the chart and highway windows show a parallel line on either side of the plotted course. These two lines are called the Course Deviation Indicator (CDI) lines. The distance from the plotted course to a CDI line is the CDI scale.

Set the CDI scale (see section 17-2) to the maximum distance that the boat should deviate from the plotted course. The chart and highway windows show the CDI lines, which are like a highway over the water where the boat will move. The windows show how far the boat has deviated from the plotted course and if the boat is approaching a CDI line. If the XTE alarm is enabled (see section 17-9) an alarm will sound if the boat reaches a CDI line.

**COG** Course Over Ground: Direction in which the boat is moving over the ground.

**CTS** Course To Steer: Optimum course to steer to return to the plotted course.

**DTG** Distance To Go: Distance from the boat to the destination.

**ETA** Expected Time of Arrival: At the destination, assuming that SOG and COG remain constant.

**†DST** Distance from boat to cursor (cursor mode, see section 3-2)

**SOG** Speed Over Ground: Current boat speed over the ground. This is not necessarily the same as the boat speed through the water nor the speed at which it is approaching the destination.

**STR** Steering: The difference between COG and CTS.

**TTG** Time To Go: The estimated time to reach the destination.

**XTE** Cross Track Error: The distance from the boat to the nearest point of the plotted course. XTE may have a letter: R means steer to the right to return to the plotted course, L means steer to the left.

**VMG** Velocity Made Good: The speed at which the boat is approaching the destination.

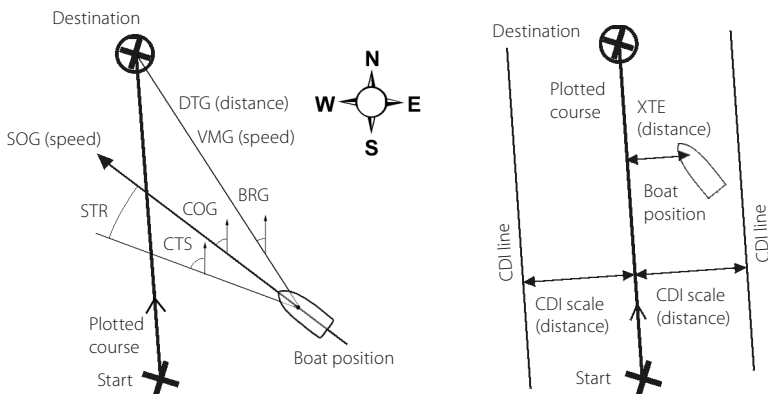

AMERICAS

30 Sudbury Road,  
Acton, MA 01720, USA  
Ph: +1 978.897.6600  
Ph: +1 800.628.4487  
Fax: +1 978.897.7241  
sales@bntmarine.com

EUROPE

Unit 2, Ocean Quay,  
Belvidere Rd, Southampton,  
SO14 5QY, ENGLAND  
Ph: +44 2380 339922  
Fax: +44 2380 330345  
northstaruk@northstarnav.com

AUSTRALIA

PO Box 479,  
Gladesville, NSW 2111,  
AUSTRALIA  
Ph: +61 2 9879 9060  
Fax: +61 2 9879 9009  
northstaraus@northstarnav.com

NEW ZEALAND

PO Box 68 155,  
Newton, Auckland  
Auckland, NEW ZEALAND  
Ph: +64 9 481 0500  
Fax: +64 9 481 0590  
northstarnz@northstarnav.com

[www.northstarnav.com](http://www.northstarnav.com)

**NORTHSTAR** 



Made in New Zealand  
MN000651A-G

## Free Manuals Download Website

<http://myh66.com>

<http://usermanuals.us>

<http://www.somanuals.com>

<http://www.4manuals.cc>

<http://www.manual-lib.com>

<http://www.404manual.com>

<http://www.luxmanual.com>

<http://aubethermostatmanual.com>

Golf course search by state

<http://golfingnear.com>

Email search by domain

<http://emailbydomain.com>

Auto manuals search

<http://auto.somanuals.com>

TV manuals search

<http://tv.somanuals.com>