



Explorer 721US / 721EU





VHF Marine Radio

Operation and Installation Manual

NORTHSTAR

www.northstarnav.com

IMPORTANT SAFETY INFORMATION
Please read carefully before installation and use.

	This is the safety alert symbol. It is used to alert you to potential personal injury hazards, Obey all safety messages that follow this symbol to avoid possible injury or death.
	WARNING indicates a potentially hazardous situation which, if not avoided, could result in death or serious injury
	CAUTION indicates a potentially hazardous situation which, if not avoided, could result in minor or moderate injury.
	CAUTION used without the safety alert symbol indicates a potentially hazardous situation which, if not avoided, may result in property damage.

DISCLAIMER: It is the owner's sole responsibility to install and use the instrument and transducers in a manner that will not cause accidents, personal injury or property damage. The user of this product is solely responsible for observing safe boating practices.

BRUNSWICK NEW TECHNOLOGIES INC. AND ITS SUBSIDIARIES AND AFFILIATES DISCLAIM ALL LIABILITY FOR ANY USE OF THIS PRODUCT IN A WAY THAT MAY CAUSE ACCIDENTS, DAMAGE OR THAT MAY VIOLATE THE LAW.

Governing Language: This statement, any instruction manuals, user guides and other information relating to the product (Documentation) may be translated to, or

has been translated from, another language (Translation). In the event of any conflict between any Translation of the Documentation, the English language version of the Documentation will be the official version of the Documentation.

This manual represents the Explorer 721 as at the time of printing. Brunswick New Technologies Inc. and its subsidiaries and affiliates reserve the right to make changes to specifications without notice.

Copyright © 2006 Brunswick New Technologies Inc. Northstar™ is a registered trademark of Brunswick New Technologies Inc.

FCC Statement

This equipment has been tested and found to comply with the limits for a Class B digital device, pursuant to Part 15 of the FCC Rules. These limits are designed to provide reasonable protection against harmful interference in a normal installation. This equipment generates, uses and can radiate radio frequency energy and, if not installed and used in accordance with the instructions, may cause harmful interference to radio communications. However, there is no guarantee that interference will not occur in a particular installation. If this equipment does cause harmful interference to radio or television reception, which can be determined by turning the equipment off and on, the user is encouraged to try to correct the interference by one or more of the following measures:

- Reorient or relocate the receiving antenna.
- Increase the separation between the equipment and receiver.
- Connect the equipment into an outlet on a circuit different from that to which the receiver is connected.
- Consult the dealer or an experienced technician for help.
- A shielded cable must be used when connecting a peripheral to the serial ports.

Contents

Section 1 - General Information	6
1-1 Features	6
1-2 Customize your Northstar VHF Radio	6
1-3 How to Display and Navigate Menus.....	6
1-4 How to Enter or Change Alphanumeric Data.....	7
1-5 LCD Symbols and Meanings	7
1-6 How the Microphone and Optional Handset Work Together.....	9
1-7 Basic Operation and Key Functions	10
Section 2 - The Radio Menu (MENU)	13
2-1 The Radio Menu Options (MENU)	13
2-2 Show Weather, SNR, or Happy Fish on Handset (INFO DATA)	14
2-3 Maintain Your Buddy List (BUDDY LIST)	15
2-4 Local or Distance Sensitivity (LOCAL/DIST)	16
2-5 Backlighting (BACKLIGHT) and Contrast (CONTRAST).....	16
2-6 GPS Data and Time (GPS/DATA).....	17
2-7 GPS Simulator (GPS SIM).....	20
2-8 Reset to Factory Defaults (RESET).....	20
Section 3 - The Radio Setup Menu (RADIO SETUP)	21
3-1 The Radio Setup Menu Options (RADIO SETUP).....	21
3-2 Select the Channel Bank (UIC).....	21
3-3 Change Channel Names (CH NAME).....	21
3-4 Ring and Beep Volume (RING VOL) and (KEY BEEP)	22
3-5 Internal Speaker Connections (INT SPEAKER)	22
3-6 Set the Priority Channel (WATCH MODE).....	23
3-7 Weather Alert (Wx ALERT)	23
3-8 NMEA or NAVBUS Protocol (COM PORT)	23
3-9 Barometric Displays (BARO SENSOR)	24
3-10 Temperature Display (TEMPERATURE).....	25
Section 4 - The DSC Setup Menu (DSC SETUP)	26
4-1 The DSC Setup Menu Options (DSC SETUP)	26
4-2 Check Your User MMSID (USER MMSID)	26
4-3 Maintain Your Groups (GROUP SETUP).....	26
4-4 Response to Individual Calls (INDIV REPLY)	27
4-5 ATIS MMSID & ATIS Functionality	28
4-6 DSC Functionality (DSC FUNC)	29

4-7 Response Type to LL Polling Calls (LL REPLY)	29
4-8 Mute the Notification Ring Tone (LL RING)	29
Section 5 - Send and Receive DSC Calls	30
5-1 What is DSC?	30
5-2 The DSC Call Menu Options (DSC CALL)	30
5-3 Call an Individual (INDIVIDUAL)	31
5-4 Call the Most Recent Incoming Call (LAST CALL)	32
5-5 Call a Group (GROUP CALL)	32
5-6 Call All Ships (ALL SHIPS)	32
5-7 Call using the Call Log (CALL LOG)	33
5-8 Call using the Distress Log (DIST LOG)	33
5-9 Request the LL Position of a Buddy (LL REQUEST)	34
5-10 Receive an All Ships Call (RCV: ALL SHIPS)	35
5-11 Receive an Individual Call (RCV: INDIV)	35
5-12 Receive a Group Call (RCV: GROUP)	36
5-13 Receive a Geographic Call (RCV: GEOGRAPH)	36
5-14 Receive a Polled Position Call (RCV: POSITION)	36
Section 6 - Distress Calls	37
6-1 Send a Distress Call	37
6-2 Receive a Distress Acknowledgement (DISTRESS ACK)	37
6-3 Receive a Distress Call (RCV: DISTRESS)	38
6-4 Relay a Distress Call (RCV: DISTRESS RELAY)	38
6-5 Relay a Distress Call from the Distress Log (RELAY)	38
Appendix A - Technical Specifications	39
Appendix B - Troubleshooting	41
Appendix C - VHF Marine Channel Charts	42
Appendix D - MMSID and License Information	54
Section 7 - Install the Explorer 721	55
7-1 Installation Options	55
7-2 Location Requirements	55
7-3 Checklist	55
7-4 Gimbal Installation	56
7-5 Change the Viewing Angle	57
7-6 Recessed Installation	57

7-7 Install the Microphone Bulkhead Mount	58
7-8 Connect the Radio Cables	58
7-9 Set Up the Radio.....	59
7-10 Enter Your User MMSID	59
7-11 The Completed Installation (with Optional Handset).....	60

Industry Canada

Operation is subject to the following two conditions: (1) this device may not cause interference, and (2) this device must accept any interference, including interference that may cause undesired operation of the device.

RF Emissions Notice:

This equipment complies with FCC radiation exposure limits set forth for an uncontrolled environment. This device's antenna must be installed in accordance with provided instructions; and it must be operated with minimum 96 cm spacing between the antennas and all person's body (excluding extremities of hands, wrist and feet) during operation. Further, this transmitter must not be co-located or operated in conjunction with any other antenna or transmitter.

IMPORTANT:

1. Some features described in this manual are not available on every model.
2. DSC functions will not operate on the radio until your user MMSID has been entered. See Section 7.9 for details.
3. The radio channels installed into the radio may vary from country to country, depending upon the model, and government or national communications authority regulations.
4. Brunswick New Technologies Inc. recommends that you check the radio operating licensing requirements of your country before using the radio. The operator is solely responsible for observing proper radio installation and usage practices.
5. A DSC warning label is supplied with the 721US. To comply with FCC regulations, this label must be affixed in a location that is clearly visible from the operating controls of this radio. Make sure that the chosen location is clean and dry before applying this label.

Optional Handset

This manual describes the operation and installation procedures for the Northstar Explorer 721US and 721EU base unit and microphone. An optional Northstar 701US or 701EU handset can be purchased and installed to give second station operation and intercom facilities.

Section 1 - General Information

1-1 Features

Congratulations on your purchase of a Northstar VHF Explorer 721US or 721EU marine band radio. Both of these models provide the following useful features:

- Prominent channel display and rotary channel selector knob with PRESS TO ENTER function
- Local/Distance mode to eliminate noise in high traffic areas
- Adjustable contrast settings for the LCD
- Adjustable keypad backlighting for easy night-time use
- Waterproof and submersible to comply with JIS-7
- GPS latitude and longitude (LL) and time display (when connected to a GPS)
- Info key to display barometric data and temperature, or Signal-to-Noise Ratio (SNR)
- Happy Fish symbol that indicates the fishing conditions
- Choice of High or Low (25 W or 1 W) transmission power
- Top centered PTT button for comfortable left- or right-handed use
- Powerful 4 W external audio output
- Access to all currently-available marine VHF channel banks (USA, Canada, International) including weather channels where available
- Special CH16 or CH16/9 key for quick access to the priority (international distress) channel
- Special 3CH key to select your three favorite channels
- PSCAN (similar to dual watch) facility
- DSC (Digital Select Calling) capability that meets USCG SC101 for USA, Class D Standards for EU/Canada Commercial, and Recreational Class S for Canada
- Distress call key to automatically transmit the MMSID and position until an acknowledgement is received
- Easy access to a buddy list of up to 20 favorite people
- MMSID storage for three favorite groups
- Group call and All Ships call facility
- LL position polling information and Track Your Buddy facility
- Weather alert facility. *721US only*
- ATIS facility for inland waterways. *721EU only*
- Alphanumeric microphone for easy, direct channel entry and information editing. *721EU only*
- Useful INTERCOM facility if the optional 701US or 701EU handset is installed.

1-2 Customize your Northstar VHF Radio

You can customize the radio to suit your individual preferences. Some preferences can be set directly through the keys as explained in this section.

Other preferences are set up through the built-in menus and these are explained in the other sections.

1-3 How to Display and Navigate Menus

1. Hold down CALL/MENU to show the radio menu
or
Press CALL/MENU to show the DSC call menu.

- Only four menu items can be displayed at any one time on the LCD. Press CH + or CH - to scroll up and down the menu until the cursor is positioned at the desired option. Press ENT or push the rotary knob to display that option.
- Make any entries or changes as explained in the following section.
- Press ENT or push the rotary knob to confirm changes. Otherwise, press ESC to keep the original entry.
- Press ESC to backup one screen or exit. Any changes are active as soon as you exit the screen.

1-4 How to Enter or Change Alphanumeric Data

If your radio doesn't have an optional alphanumeric microphone, use the + CH - key to enter alphanumeric data as follows:

- Press CH - to count through numbers, or hold down to scroll rapidly to the desired number.
- Press CH + to step through the alphabet, or hold down to scroll rapidly to the desired character.
- If you make an error, press CH - until < is displayed, then press ENT or push the rotary knob to backup and correct the entry.

If your radio has an alphanumeric microphone, use the keypad to enter the cahnnngel numbers and names. Each key has the functionality shown below.

- Use CLR to backup and ENT to confirm, or just wait for the cursor to advance automatically to the next position when entering data (similar to mobile phone operation),

KEY	0	1	2	3	4	5	6	7	8	9
Normal and Menu Mode	0	1	2	3	4	5	6	7	8	9
Edit Mode	0	1	2	3	4	5	6	7	8	9
Push 1										
Push 2	Space	-	A	D	G	J	M	P	T	W
Push 3	(.	B	E	H	K	N	Q	U	X
Push 4)	"	C	F	I	L	O	R	V	Y
Push 5	%	/	?	!	:	#	"	&	Z	

1-5 LCD Symbols and Meanings

The simulation shows the locations of all the following information symbols on the LCD displays.

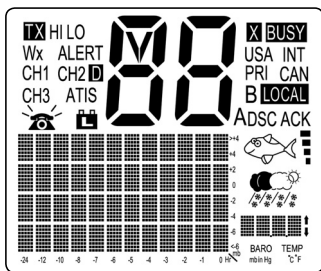



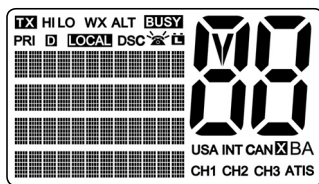

Base unit display

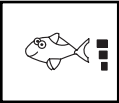

Optional handset display

These symbols may not appear at all or may be shown in a different location on the optional handset.

Symbol	Meaning
TX	Transmitting.
HI LO	Transmission power. High (HI) 25 W or Low (LO) 1 W.
WX	Weather channel.
WX ALT	Weather Alert. Alarm beeps will sound. <i>721US only.</i>
BUSY	Receiver busy with an incoming signal.
PRI	Priority channel is selected.
D	Duplex operation. Otherwise, blank for Simplex operation.
LOCAL	Local calling is selected. Otherwise, blank for distance calling.
DSC	DSC capability is available.
	Indicates an incoming DSC call, or blinks to notify you of any unread Call Log messages
	Low Battery warning (activates at 10.5 V)
88	Channel selected.
USA INT CAN	Selected channel bank for VHF radio operations and regulations.
X	Channel is temporarily deleted from the ALL SCAN operation.
B A	Channel suffix, if applicable.
CH1 CH2 CH3	Shows which of the 3 favorite channels, if any, are selected. Otherwise blank.
ATIS	Enabled for use in European inland waterways. Otherwise blank. <i>721EU only.</i>
DSC	DSC capability is available.
ACK	A message acknowledging your DSC call is being displayed.
	Happy Fish symbol with one to four indicator bars to show the probability of good fishing at your current location, based upon barometric pressure and air temperature. Four bars show that good fishing is likely. High pressure trends are associated with stable conditions and calm seas. Research indicates that best fishing occurs when barometric pressure is rising and between 1010 and 1022 mb. During these opportune conditions, most fish are thought to feed anywhere within the water column. However, low pressure trends bring stormy seas and affect air bladders, and these conditions make fish move to deeper levels and become less active.
	Local weather forecast based on the local temperature and stored barometric pressure data. The icons are indicative only and are more accurate close to land rather than in open sea.
	Digital Readout of the current barometric pressure (in mb or in/Hg) or the current temperature (in °C or °F), depending upon your selection.

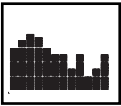

Baro Graph. A histogram of barometric pressure readings over the past 24 hours. The high-resolution histogram centers automatically if the range goes off scale. Readouts are taken even when the engine and radio have been powered down (with typically less than 3mA of current drain).

A typical operational display on base unit LCD:

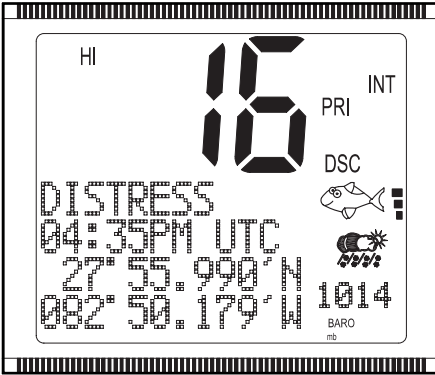

A transmission on Channel 16 is being made at high power using the International channel bank.

Channel 16 is set as the Priority channel.

There is an incoming DSC DISTRESS call so the receiver is busy.

The latitude and longitude of the vessel and UTC time are shown.

3 bars by the Happy Fish indicates rising barometric trends and reasonable fishing conditions.

The weather indicates showery conditions.

A typical operational display on Optional Handset LCD:

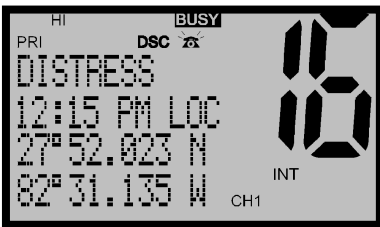

1-6 How the Microphone and Optional Handset Work Together

If you have the optional handset installed, as well as the microphone:

- neither item works when both are ON hook, but you can hear the audio from the handset speaker and adjust the handset volume.
- to use one item when it's OFF hook, the other item must be ON hook.
- if both items are OFF hook, only the microphone works.
- in Intercom mode ONLY, both items work OFF hook.

1-7 Basic Operation and Key Functions

All possible keys on the base unit, the microphone, and the optional handset are listed and their functions are explained.

NOTE: Some keys or functions may not be available on your particular model of base unit, microphone, or optional handset. This example shows the 721US base unit.

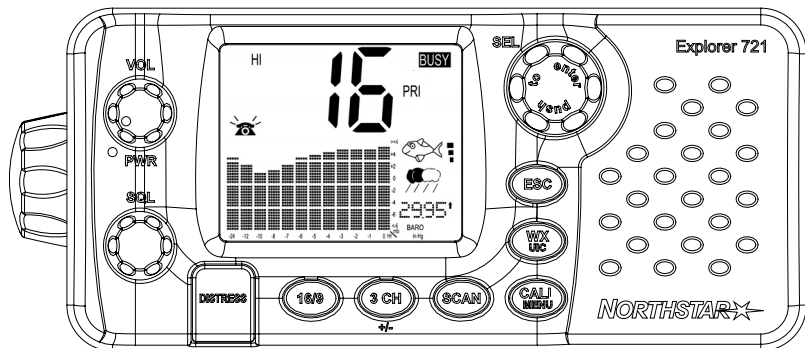

Key	Function
VOL PWR	Volume and Power. Turn clockwise to power on. Continue to turn until a comfortable volume is reached. VOL/PWR will also adjust the settings of an external speaker, if connected.
SQL	Squelch or Threshold Level. Sets the threshold level for the minimum receiver signal. Turn fully counterclockwise until random noise is heard, then turn slowly clockwise until the random noise disappears. Make another 1/4 turn clockwise for best reception in open sea conditions. In areas of high noise (eg close to large cities) reception may improve if sensitivity is reduced. Either turn SQL slowly clockwise or use the LOCAL setting. See section 2.4.
DISTRESS	Send DSC Distress Call. See Section 6.
16/9	Priority Channel. <i>721US only.</i> Press to cancel all other modes and to tune into the priority channel. Press again to return to your original channel. The default is Channel 16. To make Channel 09 the priority channel, hold down 16/9 until a beep sounds and 09 is displayed.
16	Priority Channel. <i>721EU only.</i> Press to cancel all other modes and to tune into the priority channel, Channel 16, on high power. Press again to return to your original channel.
3 CH	Three Favorite Channels. Press to toggle between your favorite channels. The CH1, CH2, or CH3 symbol appears on the LCD to show which favorite channel is selected. To scan only one of your favorite channels, press 3CH then immediately press and release SCAN. If you want to scan all three favorite channels, press 3CH then immediately press and hold SCAN.

To add a favorite channel for the first time, select that channel then hold 3CH to store it in the CH1 location. Repeat the procedure to store two more favorite channels in the CH2 and CH3 locations respectively.

If you try and add another favorite channel it will overwrite the existing CH3. CH1 and CH2 remain unless you delete them.

To delete a favorite channel, select that channel then hold down 3CH until the CH1, CH2 or CH3 symbol disappears off the LCD.

SCAN

Scan. Scanning is not allowed in some European countries. Otherwise, press to scan between your current channel and the priority channel in DUAL or TRI WATCH mode. The weather channel is also scanned if the USA channel bank is selected and the weather alert mode is ON.

Hold down SCAN to enter ALL SCAN mode where the priority channel is checked every 1.5 seconds.

When a signal is received, scanning stops at that channel and BUSY appears on the LCD. If the signal stops for more than 5 seconds, the scan restarts.

Press ENT or push the rotary knob to temporarily skip over (lock out) an "always busy" channel when in ALL SCAN mode and resume the scan. An X is shown on the LCD to designate a skipped channel. It's not possible to skip over the priority channel.

Press SCAN to stop at the current channel.

CALL/MENU

Radio Menu, DSC Set up Menu, Radio Set up Menu and DSC CALL Menu.

Hold down to show the radio menu (see Section 2) and to access the radio set up menu (see Section 3) and the DSC set up menu (see Section 4).

Press to enter the DSC call menu and to make DSC calls (see Section 5).

WX

Weather Channel. *721US only.* In USA and Canadian waters, press to hear the most recently selected weather station. The WX symbol is displayed on the LCD.

Press CH + or CH - to change to a different weather channel. Press WX again to return to the most recent channel.

If the weather alert mode is ON and an alert tone of 1050 Hz is broadcast from the weather station, it's picked up automatically and the alarm sounds. Press any key to hear the weather alert voice message.

IC or H/L IC

Intercom. *Optional 701US or 701EU handset required.* Hold down to enter Intercom mode on USA models. EU models need just a single press and release.. This disables the radio receiver except for incoming DSC calls and the intercom calls the other unit.

Press PTT when invited. When you're finished, press ESC to exit Intercom mode or put the handset back on hook.

ESC

Escape. Use ESC when navigating menus, to clear incorrect entries, to exit from a menu without saving changes, and to back up to the previous screen.

Rotary knob

Channel Select. Turn to select a channel. The current channel is shown on the LCD in BIG digits with an A or B designator suffix (if applicable) in small letters below the channel number. (See Appendix C for a listing of channel frequencies.)

Push to activate the ENTER function.

You can also use the rotary knob for alphanumeric entry if you don't have an alphanumeric microphone. Turn to step through alphanumeric characters one at a time then push to confirm each selection. If you make an error, select the < character then push to backup.

info	<p>Information. Press on the base MIKE to toggle through the INFO display to show the barometric histogram, the barometric readout and temperature, or the Signal-to-Noise Ratio (SNR).</p>
H/L	<p>Transmission Power. High (HI) 25 W or Low (LO) 1 W. Press to toggle between high or low transmission power for the entire channel bank. The HI or LO selection is shown on the LCD.</p> <p>Some channels allow only low power transmissions. Error beeps will sound if the power transmission setting is incorrect.</p> <p>Some channels allow only low power transmissions initially, but can be changed to high power by holding down H/L and PTT at the same time. See Appendix C for a complete listing of channel charts.</p>
+ CH -	<p>Channel Select. Press CH + or CH - to step through the available channels one at a time, or hold down to scroll rapidly through all the available channels. The current channel is shown on the LCD in BIG digits with an A or B designator suffix (if applicable) in small letters below the channel number. (See Appendix C for a listing of channel frequencies.)</p> <p>Press CH + or CH - to scroll the cursor up and down menu options on the LCD when navigating menus.</p> <p>When editing an item containing only numbers, press CH - to step through the numbers or hold down to scroll rapidly.</p> <p>To enter a character, press Ch = to step through the alphabet or hold down to scroll rapidly.</p>
ENT	<p>Enter. Press ENT when navigating menus, to confirm entries and edits.</p>
PTT	<p>Press To Talk. Press PTT to transmit at any time on an allowable channel. This automatically exits you from menu mode and stops scanning.</p> <p>You must release PTT to receive a signal.</p> <p>If PTT sticks, a built-in timer will automatically shut down a transmission after five minutes and sound the error beeps. This timer is required by FCC regulations.</p>

Section 2 - The Radio Menu (MENU)

Hold down CALL/MENU to show the radio menu options.

Sections 1-3 and 1-4 explain how to navigate around the menu and enter, save and change data.

2-1 The Radio Menu Options (MENU)

INFO DATA <i>(Handset only)</i>	Show weather, SNR or Happy Fish information on the handset. See Section 2-2.	
BUDDY LIST LOCAL/DIST	Maintain your buddy list. See Section 2-3.	Set radio sensitivity. See Section 2-4.
BACKLIGHT CONTRAST	Set backlight level. See Section 2-5.	Set contrast level. See Section 2-5.
GPS/DATA	MANUAL SETTING	Set position & UTC manually. See Section 2-6. Set local time and time format. See Section 2-6.
DSC SETUP	USER MMSID GROUP SETUP INDIV REPLY DSC FUNC ATIS MMSID ATIS FUNC <i>(EU only)</i> LL REPLY	DSC SETUP Menu. See Section 4.
RADIO SETUP	UIC <i>(721US only)</i> CH NAME RING VOLUME KEY BEEP INT SPEAKER WATCH MODE WX ALERT <i>(721US only)</i> COM PORT BARO SENSOR TEMPERATURE HAPPY FISH	RADIO SETUP Menu. See Section 3.
GPS SIM RESET <i>(Base unit only)</i>	Turn the GPS Simulator on/off. See Section 2.7.	Reset factory settings. See Section 2.8.

2-2 Show Weather, SNR or Happy Fish on Handset (INFO DATA)

If you have the optional handset installed, you can use INFO DATA to show the local weather forecast (e.g. SUNNY) and a digital readout of the current barometric pressure (mb or in-Hg) and the channel name on the handset LCD.

MENU SELECT
>INFO DATA
BUDDY LIST
LOCAL/DIST

INFO DATA
>ON
OFF

DISTRESS
A BIT CLOUDY
78.4°F
29.99in-Hg

After INFO DATA is selected ON, the following screen appears on the handset with Line #3 able to display 3 items of interest - temperature, Signal To Noise ratio (SNR) or HAPPY FISH quality.

- a digital readout of the current air temperature (°F or °C)
 - the current Signal-to-Noise Ratio (SNR)
 - the Happy Fish symbol with indicator bars.
1. Hold down CALL/MENU to display the radio menu.
 2. The cursor is at INFO DATA. Press ENT then select INFO ON to display the information on the handset LCD, instead of the time and GPS position.
 3. 78.4°F is replaced by SNR bars if handset is OFF HOOK.
 4. Happy Fish symbol replaces TEMP/SNR if triggered after which it times out.

2-3 Maintain Your Buddy List (BUDDY LIST)

```
MENU SELECT
>BUDDY LIST
  LOCAL/DIST
  BACKLIGHT
```

Use the Buddy List to store the names and associated MMSIDs of 20 favorite people. Names are stored in the order of entry, with the most recent entry shown first.

The following sections show to use BUDDY LIST to add, edit, and delete entries in your buddy list.

Section 3 explains how to call a buddy.

2-3-1 Add an Entry

```
BUDDY LIST
> MANUAL NEW
  ALEX
  TOM
```

```
ENTER NAME
-----
ENTER MMSID
-----
```

```
ENTER NAME
BOB
ENTER MMSID
123456789
```

```
BOB
123456789
> STORE
  CANCEL
```

1. Select BUDDY LIST. The cursor is at MANUAL NEW. Press ENT.
2. Enter the buddy name, one character at a time (this may be alphanumeric) then press ENT or push the rotary knob repeatedly until the cursor moves to the MMSID entry line.
3. Enter the MMSID (this must be numeric) associated with that buddy name then press ENT.
4. The new buddy name and MMSID are displayed. Press ENT or push the rotary knob to store the new entry, which is displayed at the top of your buddy list.

NOTE: When the BUDDY LIST is full (20 entries), you can't make a new entry until you have deleted an existing entry.

2-3-2 Edit an Entry

```
BUDDY LIST
> MANUAL NEW
  ALEX
  TOM
```

```
ALEX
> EDIT
  DELETE
```

```
EDIT NAME
ALEX
EDIT MMSID
112233445
```

```
ALEX
111223344
> STORE
  CANCEL
```

1. Select BUDDY LIST. Press ENT or push the rotary knob to display the list of entries.
2. Scroll down (if required) to the incorrect entry and press ENT.
3. Select EDIT. The cursor is at the first character of the name.
4. Edit the buddy name or, to edit only the MMSID, press ENT or push the rotary knob repeatedly until the cursor moves to the MMSID line.
5. When you are finished, press ENT or push the rotary knob (repeatedly if necessary) to display the next screen.
6. Press ENT or push the rotary knob to store the changes. The buddy list is displayed again. If more changes are required, repeat Steps 2 thru 6. Otherwise, press ESC to exit.

2-3-3 Delete an Entry

```
BUDDY LIST
> MANUAL NEW
ALEX
TOM
```

```
BUDDY LIST
> MANUAL NEW
ALEX
TOM
```

```
TOM
> EDIT
DELETE
```

```
DELETE BUDDY
TOM
> YES
NO
```

1. Select BUDDY LIST. Press ENT or push the rotary knob to display the list of entries.
2. Scroll down (if required) to the entry you want to delete and press ENT.
3. Select DELETE then select YES.
4. The entry is deleted immediately and the buddy list is displayed again.

2-4 Local or Distance Sensitivity (LOCAL/DIST)

```
MENU SELECT
INFO DATA
BUDDY LIST
> LOCAL/DIST
```

Use LOCAL/DIST to improve the sensitivity of the receiver either locally (LOCAL) or over distances (DIST).

LOCAL is NOT recommended for use in open sea conditions. It's designed for use in areas of high radio noise; e.g. when you're close to a city.

See also SQL (Squelch Control) in Section 1.6.

2-4-1 Set Distance Sensitivity

```
SENSITIVITY
> DISTANT
LOCAL
```

1. Select LOCAL/DIST then select DIST.
2. Press ENT or push the rotary knob to activate the DIST setting. This disables local sensitivity and the menu is displayed again.

2-4-2 Set Local Sensitivity

```
SENSITIVITY
DISTANT
> LOCAL
```

1. Select LOCAL/DIST then scroll to LOCAL.
2. Press ENT or push the rotary knob to activate the LOCAL setting. This disables distance sensitivity and the menu is displayed again.

LOCAL is displayed on the LCD in reverse video, as a reminder that local sensitivity is selected.

2-5 Backlighting (BACKLIGHT) and Contrast (CONTRAST)

```
MENU SELECT
LOCAL/DIST
> BACKLIGHT
CONTRAST
```

Use BACKLIGHT to set the backlight levels for the LCD at a comfortable level.

The microphone keypad backlighting is either ON or OFF.

The DISTRESS key backlighting can't be switched off.

Use CONTRAST to set the contrast level for the LCD.

2-5-1 Set the Backlighting Level

```
BACKLIGHT
...
LO HI
PRESS ENT
```

1. Select BACKLIGHT.
2. Use CH + or CH - to select a comfortable backlight level.
3. Press ENT or push the rotary knob to confirm the new level and return to the menu.

2-5-2 Set the Contrast Level

```
CONTRAST
...
LO HI
PRESS ENT
```

1. Select CONTRAST.
2. Use CH + or CH - to select a comfortable contrast level.
3. Press ENT or push the rotary knob to confirm the new level and return to the menu.

2-6 GPS Data and Time (GPS/DATA)

```
MENU SELECT
  BACKLIGHT
  CONTRAST
  > GPS/DATA
```

If your vessel has an operational GPS navigation receiver, the radio automatically detects and updates the vessel position and the local time.

However, if the GPS navigation receiver is disconnected or absent, you can specify the vessel position and the local time manually, using the GPS/DATA option.

This information is important because it will be used if you transmit a DSC distress call.

2-6-1 Manually Enter Position and UTC Time (MANUAL)

NOTE: This function is available only when an operational GPS receiver is NOT connected.

```
GPS/DATA
> MANUAL
  SETTING
```

```
MANUAL LL
--'--'----N
--'--'----W
MAN --:--UTC
```

1. Select GPS/DATA, then MANUAL.
2. Enter the latitude, then the longitude, then the UTC.
3. Press ENT or push the rotary knob when all the information is correct.

The vessel's latitude and longitude are shown on the screen, with the UTC time. After entering your manual LL position, the prefix "M" in the normal GPS screen indicates a manual entry. The manual entries are cancelled if a real GPS position is received.

2-6-2 Local Time (TIME OFFSET)

The local time can be set by entering the time offset between UTC and local time as follows.

GPS/DATA
MANUAL
>SETTING

GPS/DATA
> TIME OFFSET
TIME FORMAT
TIME DISPLY

TIME OFFSET
>+01:30

02:30PM LOC

1. Select GPS/DATA, then SETTING.
2. Select TIME OFFSET to enter the difference between UTC and local time. Half hour increments can be used with a maximum offset of ± 13 hours.

In this example, a difference of +1.5 hours has been entered and the local time is displayed with the suffix LOC.

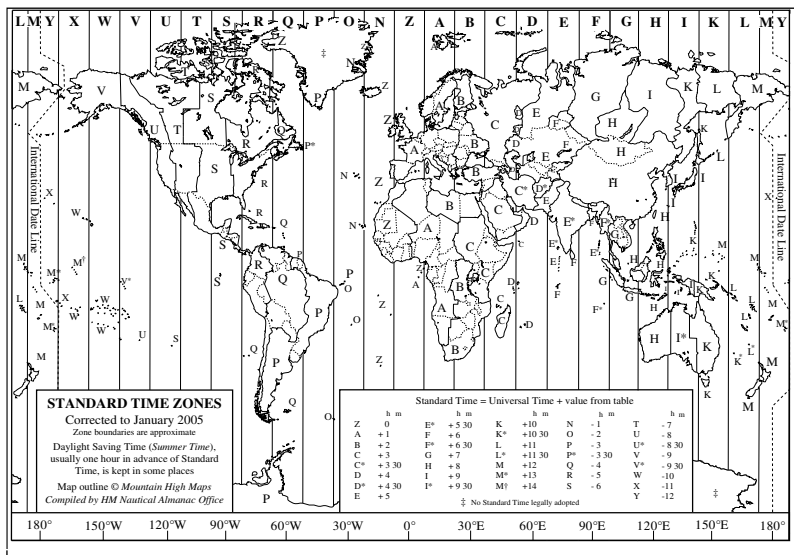

2-6-3 Time Format Options (TIME FORMAT)

Time can be shown in 12 or 24 hour format.

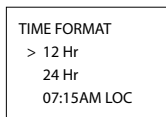
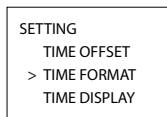
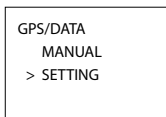

1. Select GPS/DATA, then SETTING.
2. Select TIME FORMAT.
3. Select 12 Hr or 24 Hr as desired. In this example, 12 hour format has been selected so the LCD shows the AM or PM suffix.

2-6-4 Time Display Options (TIME DISPLAY)

If you've entered the time manually as described in the previous sections, the time is shown ALWAYS with the prefix M.

However, if the vessel's position is being updated through a GPS navigation receiver, you can switch the time display ON or OFF as follows:

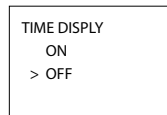
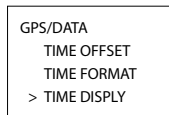

1. Select GPS/DATA, then SETTING.
2. Select TIME DISPLAY.
3. Select ON or OFF as desired. In this example, OFF has been selected and so the LCD no longer shows the time.

If the time display is set ON, course and speed data are NOT displayed on the LCD (see section 2-5-6).

2-6-5 Position Display Options (LL display)

If you've entered the vessel position manually as described in the previous section, the vessel position is shown ALWAYS with the suffix M.

However, if the time is being updated through a GPS navigation receiver, you can switch the vessel position display ON or OFF as follows:

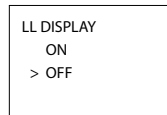
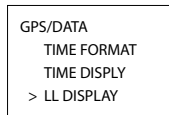

1. Select GPS/DATA, then SETTING.
2. Select LL DISPLAY.
3. Select ON or OFF as desired. In this example, OFF has been selected and the screen no longer shows the vessel position.

2-6-6 Course & Speed Display Options (COG/SOG)

Use this option to display course over ground (COG) and speed over ground (SOG) data on the screen.

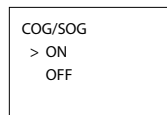
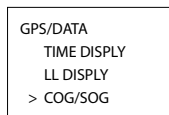

1. Select GPS/DATA, then SETTING.
2. Select COG/SOG.
3. Select ON or OFF as desired. In this example, ON has been selected, so the screen shows the bearing and speed.

If COG/SOG is set ON, the time is NOT displayed on the screen (see section 2-5-4).

2-6-7 GPS Alert Options (ALERT)

The GPS alert is usually set to ON so that if the GPS navigation receiver is disconnected, the alarm sounds.

```
GPS/DATA
  LL DISPLY
  COG/SOG
  > GPS ALERT
```

```
GPS ALERT
  > ON
  OFF
```

1. Select GPS/DATA, then SETTING.
2. Select GPS ALERT.
3. Select ON or OFF as desired.

2-7 GPS Simulator (GPS SIM)

The GPS Simulator is set to OFF whenever the radio is turned ON or whenever real GPS data is available through the COM port. However, if you want to test the GPS Simulator, turn it ON as follows:

```
MENU SELECT
  DSC SETUP
  RADIO SETUP
  > GPS SIM
```

1. Select GPS SIM, then select ON or OFF as desired.

Whenever the GPS Simulator is turned ON, simulated Speed Over Ground (SOG), Course Over Ground (COG), and LL position appear on the screen. This data is updated automatically during the simulation.

IMPORTANT: It's not possible to send a DSC transmission when you're in GPS Simulator mode.

2-8 Reset to Factory Defaults (RESET)

Use RESET to return every setting to the factory defaults EXCEPT all MMSID settings and the entries in your buddy list.

```
MENU SELECT
  RADIO SETUP
  GPS SIM
  > RESET
```

```
RESET RADIO
ARE YOU SURE
  > YES
  NO
```

1. Select RESET. The radio asks for confirmation.
2. Select YES to reset the radio and return to the menu.

Section 3 - Radio Setup Menu (RADIO SETUP)

Hold down CALL/MENU then scroll down and select RADIO SETUP. Press ENT or push the rotary knob to show the RADIO SETUP menu options.

Sections 1-3 and 1-4 explain how to navigate around the menu and enter, save and change data.

3-1 The Radio Setup Menu Options (RADIO SETUP)

UIC (721US only)	Select the channel bank (721US only) See Section 3-2.
CH NAME	Edit or delete channel names. See Section 3-3.
RING VOLUME	Set the volume level of the incoming call notification beeps. See Section 3-4.
KEY BEEP	Set the volume level of the beeps. See Section 3-4.
INT SPEAKER	Turn the radio's internal speakers ON or OFF. See Section 3-5.
WATCH MODE	Select Dual or Tri watch scanning. See Section 3-6.
WX ALERT (721US only)	Turn the WX Alert scanning mode ON or OFF. (721US only) See Section 3-7.
COM PORT	Select NMEA or NAVBUS protocol for communications between the radio and any other instruments. See Section 3-8.
BARO SENSOR	Select the barometric units, calibrate the sensor, turn the display ON or OFF. See Section 3-9.
TEMPERATURE	Select the temperature units, calibrate the sensor. See Section 3-10.
HAPPY FISH	Select the HAPPY FISH alarm to be ON or OFF. See Section 3-11.

3-2 Select the Channel Bank (UIC)

721US only.

There is a choice of three channel banks; USA, International, or Canadian (see Appendix C for details).

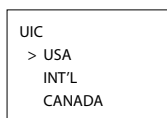
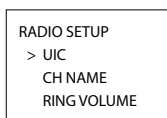

1. Select RADIO SETUP.
2. The cursor is at UIC. Press ENT or push the rotary knob to display the list of channel banks.
3. Select the channel bank to use then press ENT or push the rotary knob to confirm the setting and return to the menu.

3-3 Change Channel Names (CH NAME)

The channel charts are listed in Appendix C with their default name tags. CH NAME gives you the option to edit or delete the channel name tags displayed on the screen.

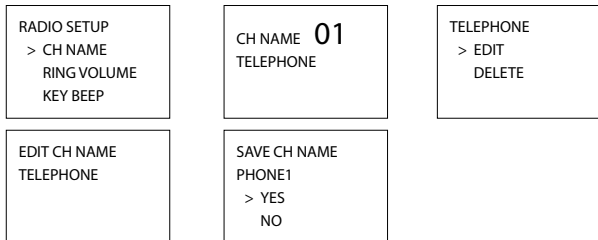

1. Select RADIO SETUP, then CH NAME.
2. Use CH + or CH - to step through the channels with their names until you see the channel name you want to change, then press ENT or push the rotary knob. In this example, the channel name TELEPHONE associated with channel 01 is being changed to PHONE1.
3. Select EDIT and press ENT or push the rotary knob to edit the existing name tag. Enter the new name over the existing name. It can be a maximum of 12 characters.

To delete the channel name, just select DELETE then press ENT or push the rotary knob.

4. Press ENT or push the rotary knob (repeatedly if necessary) to display the YES/NO confirmation.
5. Press ENT or push the rotary knob to confirm the new channel name tag or the deletion, then press ESC to return to the menu.

3-4 Ring and Beep Volume (RING VOLUME) and (KEY BEEP)

Set the volume level of the incoming signal beeps (RING VOLUME) and/or the error and warning beeps (KEY BEEP) as follows:

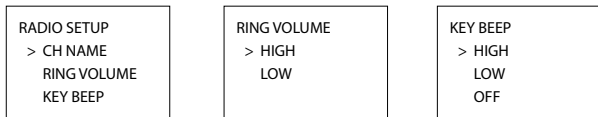

1. Select RADIO SETUP, then RING VOLUME or KEY BEEP as appropriate.
2. Select a HIGH or LOW volume. (You can turn the beeps off completely by selecting KEY BEEP then OFF.)
3. Press ENT or push the rotary knob to confirm the new volume setting and return to the menu.

3-5 Internal Speaker Connections (INT SPEAKER)

Switch the radio's internal speaker ON or OFF. (The external speaker is always ON if a speaker is plugged into the external speaker jack.)

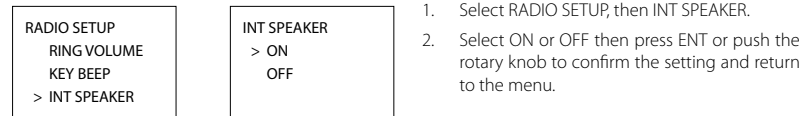

1. Select RADIO SETUP, then INT SPEAKER.
2. Select ON or OFF then press ENT or push the rotary knob to confirm the setting and return to the menu.

3-6 Set the Priority Channel (WATCH MODE)

If you have the 721EU, watch mode is similar to a dual watch, scanning between the priority channel and the working channel. CH16 is the priority channel.

If you have the 721US and are operating on USA or Canadian channel banks, you can set the priority channel to cover both CH16 and CH09 as well as the working channel, as follows:

```
RADIO SETUP
KEY BEEP
INT SPEAKER
> WATCH MODE
```

```
WATCH MODE
> ONLY 16CH
    16CH+9CH
```

1. Select RADIO SETUP, then WATCH MODE.
2. Select ONLY 16CH for dual watch mode, or 16CH+9CH for tri watch mode.

3-7 Weather Alert (WX ALERT)

721US only.

The NOAA provides several weather forecast channels on USA and Canadian channel banks. If severe weather such as storms or hurricanes are forecast, the NOAA broadcasts a weather alert on 1050 Hz. You can set up the radio to pick up weather alerts, as follows:

```
RADIO SETUP
INT SPEAKER
WATCH MODE
> WX ALERT
```

```
WX ALERT
ON
> OFF
```

1. Select RADIO SETUP, then WX ALERT.
2. Select ON then press ENT or push the rotary knob to confirm the setting and return to the menu. (If you select OFF, the alarm won't sound when there's a weather alert.)
3. When a weather alert is broadcast, the alarm will sound. Press any key to hear the weather alert voice message.

3-8 NMEA or NAVBUS protocol (COM PORT)

You can add the radio to a group of instruments using NMEA or NAVBUS protocol.

NAVBUS is automatically activated when present, so that data such as barometric pressure and history, temperature, DSC polling positions and distress data are available to any other Northstar instruments using NAVBUS. However, the barometric and temperature readings from the radio can be turned OFF if you prefer to use the readings from a different instrument.

Select your GPS data source to come from either NMEA or NAVBUS as follows:

3-8-1 NMEA GPS data source (GPS SOURCE)

```
RADIO SETUP
WATCH MODE
WX ALERT
> COM PORT
```

```
COM PORT
NMEA
> GPS SOURCE
    BARO & TEMP
```

```
GPS SOURCE
> NMEA
    NAVBUS
```

```
GPS SOURCE
NMEA
> ON
    OFF
```

```
NMEA
CHECKSUM
> ON
    OFF
```

1. Select RADIO SETUP, then COM PORT.
2. Select GPS source, then select NMEA.
3. The cursor is at ON. Press ENT or push the rotary knob to confirm the setting and show the CHECKSUM option.

4. CHECKSUM ON is the usual setting. The cursor is at ON. Press ENT or push the rotary knob to confirm the setting and return to the menu.

3-8-2 NAVMAN GPS data source (GPS SOURCE)

RADIO SETUP
WATCH MODE
WX ALERT
> COM PORT

COM PORT
NMEA
> GPS SOURCE
BARO & TEMP

GPS SOURCE
NMEA
> NAVBUS

GPS SOURCE
NAVBUS
> ON
OFF

1. Select RADIO SETUP, then COM PORT.
2. Select GPS source, then select NAVBUS.
3. The cursor is at ON. Press ENT or push the rotary knob to confirm the setting and return to the menu.

3-8-3 Use the 721 as barometric pressure and temperature data source (BARO & TEMP)

RADIO SETUP
WATCH MODE
WX ALERT
> COM PORT

COM PORT
NMEA
GPS SOURCE
> BARO & TEMP

BARO & TEMP
> ON
OFF

1. Select RADIO SETUP, then COM PORT.
2. Select BARO & TEMP.
3. The cursor is at ON. Select ON to have the radio provide the barometric and temperature data to other instruments connected. Select OFF to have another instrument to act as the source of this data.

3-9 Barometric Displays (BARO SENSOR)

A barometric sensor in the microphone measures air pressure changes, enabling the radio to provide three useful aids towards weather prediction and fishing conditions, particularly when you're close to large land masses. (See the information on the Happy Fish icon in Section 1.5.) The radio can show:

- a weather icon to indicate five different conditions (SUNNY, PARTLY CLOUDY, CLOUDY, RAINY, SNOW). The local air pressure trends combined with the local temperature determines which weather icon is displayed. (NOTE: In open ocean conditions the weather icon can be less accurate than when close to large land masses.)
- a digital readout of air pressure (in mb or in/Hg).
- a graphical display of barometric pressure changes over the past consecutive 24 hours. Barometric data is maintained even if the radio is switched off.

NOTE: If the vessel Battery Master is turned OFF, the BARO history is erased.

3-9-1 Set the Barometric Units (BARO UNITS)

RADIO SETUP
WX ALERT
COM PORT
> BARO SENSOR

BARO SENSOR
> BARO UNITS
BARO DISPLY
BARO CAL.

BARO UNITS
> MILLIBARS
INCHES

1. Select RADIO SETUP, then BARO SENSOR.
2. The cursor is at BARO UNITS. Press ENT or press the rotary knob.
3. The cursor is at MILLIBARS. Press ENT or press the rotary knob to show barometric pressure in MILLIBARS or select INCHES to show barometric pressure in inches of mercury.

3-9-2 Switch the Barometric Display ON or OFF (BARO DISPLY)

RADIO SETUP
WX ALERT
COM PORT
> BARO SENSOR

BARO SENSOR
BARO UNITS
> BARO DISPLY
BARO CAL.

BARO DISPLY
> LCD OFF
LCD ON

1. Select RADIO SETUP, then BARO SENSOR.
2. Select BARO DISPLY.
3. The cursor is at LCD OFF. Press ENT or press the rotary knob to switch OFF the barometric display on the base unit, or select LCD ON to show the barometric display on the base unit.

IMPORTANT: LCD OFF is the default. This minimises the current drain of the standby vessel battery to about 3mA average. If the barometric display is set to LCD ON the current drain is continuous at about 85mA.

3-9-3 Calibrate the Barometric Sensor (BARO CAL.)

The barometric functions and icons work best when calibrated to local conditions. The operating range is from 960mb to 1060mb.

RADIO SETUP
WX ALERT
COM PORT
> BARO SENSOR

BARO SENSOR
BARO UNITS
BARO DISPLY
> CAL

CAL
MODIFY?
> ± 0.00 In-Hg
PRESS ENT

1. Select RADIO SETUP, then BARO SENSOR.
2. Select BARO CAL. then change the setting to match the reading on an accurate instrument nearby or the reading given by a local weather station.

3-10 Temperature Display (TEMPERATURE)

A temperature sensor in the microphone measures air temperature changes.

3-10-1 Set the Temperature Units (UNITS)

RADIO SETUP
COM PORT
BARO SENSOR
> TEMPERATURE

TEMPERATURE
> UNITS
CAL.

TEMP SENSOR
> °C
°F

1. Select RADIO SETUP, then TEMPERATURE
2. The cursor is at UNITS. Press ENT or press the rotary knob.
3. The cursor is at °C. Press ENT or press the rotary knob to display the temperature in °C (Celsius) or select °F to show the temperature in Fahrenheit.

3-10-2 Calibrate the Temperature Reading (CAL.)

The temperature sensor works best when calibrated to local conditions.

RADIO SETUP
COM PORT
BARO SENSOR
> TEMPERATURE

TEMPERATURE
> UNITS
CAL.

CAL
MODIFY?
> ± 0.00 In-Hg
PRESS ENT

1. Select RADIO SETUP, then TEMPERATURE.
2. Select CAL. then change the setting to match the reading on an accurate instrument nearby or the reading given by a local weather station.

Section 4 - DSC SETUP Menu

A valid user MMSID must be entered to access the DSC functions. If you don't have a user MMSID, see Appendix D.

Hold down CALL/MENU then scroll down and select DSC SETUP. Press ENT or push the rotary knob to show the following DSC SETUP menu options.

Sections 1.3 and 1.4 explain how to navigate around the menu and enter, save and change data.

4-1 DSC SETUP Menu Options

USER MMSID	Check your user MMSID. <i>See section 4.2.</i> To enter your user MMSID for the first time, <i>see Section 7-9.</i>
GROUP SETUP	Enter or change the name and/or details of a group. <i>See section 4.3.</i>
INDIV REPLY	Choose an automatic or manual response to calls (<i>721US only</i>). <i>See section 4.4.</i>
ATIS MMSID	Enter or change your ATIS MMSID (<i>721EU only</i>). <i>See section 4.5.</i>
ATIS FUNC	Enable/disable the ATIS function (<i>VHF 721EU</i>). <i>See section 4.5.</i>
DSC FUNC	Turn the DSC operation ON or OFF. <i>See section 4.6.</i>
LL REPLY	Select the type of response to an LL polling request. <i>See section 4.7.</i>

4-2 Check Your User MMSID (USER MMSID)

You can display and read your user MMSID at any time.

1. Select DSC SETUP.
2. The cursor is at USER MMSID. Press ENT or push the rotary knob.
3. The LCD shows your user name and MMSID.

4-3 Maintain Your Groups (GROUP SETUP)

Use GROUP SETUP to create, edit, or delete 1, 2, or 3 groups of frequently called people stored in alphanumeric order. A group MMSID always starts with 0.

4-3-1 Create a Group (GROUP SETUP)

1. Select DSC SETUP, then GROUP SETUP.
2. If this is the FIRST TIME that you're entering a group name, a line of nine zeros appears. Otherwise, any existing group names are displayed. Press ENT or push the rotary knob to display the input screen.
3. Enter the group name along the dashed line. The group name can be alphanumeric. Press ENT or push the rotary knob to confirm each correct entry and to move to the next digit. When you are finished, press ENT or push the rotary knob repeatedly until the cursor moves to the MMSID line.

```
DSC SETUP
USER MMSID
> GROUP SETUP
INDIV REPLY
```

```
GROUP SETUP
> MANUAL NEW
000000000
```

```
GROUP NAME
-----
GROUP MMSID
0-----
```

```
FISHER1
012345678
> STORE
CANCEL
```

If you make an error, select < and press ENT to backup and correct the entry (721US) or CLR and ENT (721EU).

4. Enter the group MMSID. The first number is always 0. Press ENT or push the rotary knob to confirm the entry.
5. The group name and group MMSID are shown in a confirmation screen. Press ENT or push the rotary knob to store the details and return to the GROUP SETUP screen.

4-3-2 Edit Group Name or Group MMSID

```
GROUP SETUP
MANUAL NEW
> FISHER1
FRIENDS1
```

```
FISHER1
> EDIT
DELETE
```

```
EDIT NAME
> FISHER1
EDIT MMSID
012345678
```

```
FISHER2
012345678
> STORE
CANCEL
```

1. Select DSC SETUP, then GROUP SETUP. The existing group names are displayed. Select the group name that you want to edit.
2. The cursor is at EDIT. Press ENT or push the rotary knob to show the group name details. The cursor is at the first character of the group name.
3. Edit the new name or, to edit only the MMSID, press ENT or push the rotary knob repeatedly until the cursor moves to the MMSID line.
4. When you are finished, press ENT or push the rotary knob (repeatedly if necessary) to display the next screen.
5. Press ENT or push the rotary knob to store the changes and return to the GROUP SETUP screen.

4-3-3 Delete a Group

```
GROUP SETUP
MANUAL NEW
> FISHER2
FRIENDS1
```

```
FISHER2
EDIT
> DELETE
```

```
DELETE GROUP
FISHER2
> YES
NO
```

1. Select DSC SETUP, then GROUP SETUP.
2. Select the group that you want to delete.
3. Select DELETE and press ENT or press the rotary knob. The radio asks for confirmation.
4. Press ENT or push the rotary knob to delete the group and return to the GROUP SETUP screen.

4-4 Response to Individual Calls (INDIV REPLY)

721US only.

You can respond to incoming individual calls with an automatic response or with a manual response. An automatic response sends an acknowledgement then sets the request link channel, ready for a

conversation.

A manual response asks if you want to acknowledge the call, and then asks if you want to converse with the caller.

```
DSC SETUP
USER MMSID
GROUP SETUP
> INDIV REPLY
```

```
INDIV REPLY
> AUTO
MANUAL
```

1. Select DSC SETUP, then select INDIV REPLY.
2. The cursor is at AUTO. Press ENT or press the rotary knob for an automatic response, or select MANUAL for a manual response.

4-5 ATIS MMSID & ATIS Functionality

721EU only.

You MUST enter your ATIS MMSID to access ATIS functionality if you are navigating inland waterways within Europe. ATIS sends a digital message anytime that you release the PTT key. Inland waterways rules require 1 W Tx power on Channels 06, 08, 10, 11, 12, 13, 14, 15, 17, 71, 72, 74, and 77.

4-5-1 Enter or Edit Your ATIS MMSID

```
DSC SETUP
GROUP SETUP
INDIV REPLY
> ATIS MMSID
```

```
INPUT ATIS
MMSID
9-----
```

```
INPUT ATIS
MMSID
> STORE
CANCEL
```

```
INPUT AGAIN
ATIS MMSID
9-----
```

```
ATIS MMSID
923456789
> STORE
CANCEL
```

To enter or edit your ATIS MMSID:

1. Select DSC SETUP, then ATIS MMSID.
2. If this is the FIRST TIME that you are entering your ATIS MMSID, a dashed line appears. Enter your ATIS MMSID along the dashed line. An ATIS MMSID always starts with the number 9. Press ENT or push the rotary knob to confirm each correct entry and to move to the next digit.

If you make an error, press CH - until < appears, then press ENT or push the rotary knob to backup and correct the entry.

If you're editing an existing ATIS MMSID, this will be displayed. Make the required changes.

3. Press ENT or push the rotary knob to store your ATIS MMSID.
4. Enter your ATIS MMSID again as a password check, then press ENT or push the rotary knob to permanently store the ATIS MMSID and return to the menu.

You can view your stored ATIS MMSID at anytime by selecting ATIS MMSID in the main menu.

4-5-2 Enable ATIS Functionality (ATIS FUNC)

721EU only.

ATIS functionality will operate only after the ATIS MMSID has been entered (see previous section).

1. Select DSC SETUP, then ATIS FUNC.
2. The cursor is at ON. Select ENT or push the rotary knob to enable the ATIS functionality and automatically disable DSC functionality. The ATIS annunciator appears on the screen.

```
DSC SETUP
INDIV REPLY
ATIS MMSID
> ATIS FUNC
```

```
ATIS FUNC
> ON
OFF
```

It's not possible to have both ATIS ON and DSC ON simultaneously. When you enable one, the other will turn OFF. If DSC and ATIS are both OFF, you must turn DSC ON for normal DSC operation.

The annunciator on the LCD shows you the current mode: if the DSC annunciator is shown, DSC is operational; if the ATIS annunciator is shown, ATIS is operational.

4-6 DSC Functionality (DSC FUNC)

DSC functionality can be disabled but this is not recommended.

```
DSC SETUP
GROUP SETUP
INDIV REPLY
> DSC FUNC
```

```
DSC FUNC
> ON
OFF
```

1. Select DSC SETUP, then DSC FUNC.
2. The cursor is at ON. Press ENT or push the rotary knob to enable the DSC functionality and automatically disable ATIS functionality. The DSC annunciator appears on the screen.

It's not possible to have both ATIS ON and DSC ON simultaneously. When you enable one, the other will turn OFF. If DSC and ATIS are both OFF, you must turn DSC ON for normal DSC operation.

The annunciator on the LCD shows you the current mode: if the DSC annunciator is shown, DSC is operational; if the ATIS annunciator is shown, ATIS is operational.

4-7 Response Type to LL Polling Calls (LL REPLY)

You can set up the radio to respond to an LL polling request in one of three ways:

AUTO automatically replies to an incoming LL polling request from any of your buddies.

MANUAL reply manually or ignore to each incoming LL polling request from your buddies.

OFF ignores all incoming LL polling requests. from your buddies.

```
DSC SETUP
INDIV REPLY
DSC FUNC
> LL REPLY
```

```
LL REPLY
> MANUAL
AUTO
OFF
```

1. Select DSC SETUP, then LL REPLY.
2. Select your mode of response and press ENT or push the rotary knob to confirm.

Section 5 - Send and Receive DSC Calls

A valid user MMSID must have been entered to access the DSC functions. If you don't have a user MMSID, see Appendix D.

Press CALL/MENU to show the DSC CALL menu. This shows the different types of DSC call that you make.

Sections 1.3 and 1.4 explain how to navigate around the menu and enter, save and change data.

5-1 What is DSC?

DSC (Digital Selective Calling) is a semi-automated method of establishing VHF, MF, and HF radio calls. It has been designated as an international standard by the IMO (International Maritime Organization) and is part of the GMDSS (Global Maritime Distress and Safety System).

Currently, you are required to monitor Distress Channel 16, but DSC will eventually replace listening watches on distress frequencies and will be used to broadcast routine and urgent maritime safety information.

DSC enables you to send and receive calls from any vessel or coast station that is equipped with DSC functionality, and within geographic range. Calls can be categorised as distress, urgency, safety, or routine, and DSC selects a working channel automatically.

5-2 The DSC CALL Menu Options

INDIVIDUAL	ROUTINE SAFETY URGENCY DISTRESS	Make a routine, safety, urgency or distress call to a buddy or another individual. <i>See Section 5-3.</i>
LAST CALL		Show the details of the most recent incoming call. <i>See Section 5-4.</i>
GROUP		Make a call to one of your three groups. <i>See Section 5-5.</i>
ALL SHIPS	URGENCY SAFETY ROUTINE DISTRESS	Make a urgency, safety, routine, or distress call to All Ships, <i>See Section 5-6.</i>
CALL LOG		Show the details of the 20 most recent incoming calls. <i>See Section 5-7.</i>
DIST LOG		Show the details of the 10 most recent distress calls. <i>See Section 5-8.</i>
LL REQUEST		Request the LL position of a buddy. <i>See Section 5-9.</i>

5-3 Call an Individual (INDIVIDUAL)

INDIVIDUAL > ROUTINE SAFETY URGENCY	ROUTINE > MANUAL NEW BUDDY1 BUDDY2	MANUAL MMSID 0-----	012345678 INDIVIDUAL ROUTINE > SET CHANNEL
012345678 INDIVIDUAL ROUTINE > SEND?	12345678 INDIVIDUAL ROUTINE CALLING...	012345678 INDIVIDUAL ROUTINE WAITING ACK	INDIV ACK 012345678 PRESS PTT ESC -> EXIT

You can call anyone who has a radio with DSC functionality. You can set the priority level of the DSC call to routine, safety, urgency, or distress. Choose:

- ROUTINE to make a routine call
 - SAFETY to send safety information
 - URGENCY only when there's a serious situation or problem that could lead to a distress situation
 - DISTRESS only when there's a distress situation.
1. Press CALL/MENU to enter the DSC CALL menu, then select INDIVIDUAL to call another person.
 2. The cursor is at ROUTINE. Press ENT or press the rotary knob to make a routine call or select to another priority level.
 3. The cursor is at MANUAL NEW. Press ENT or press the rotary knob to call a person who's not in your buddy list; otherwise select the name of your buddy.
If you selected MANUAL NEW, enter the user MMSID and then press ENT or push the rotary knob.
 4. Select the working channel and press ENT or press the rotary knob. (NOTE: If you're making a distress call, the radio goes to CH16 automatically.) Duplex channels can't usually be called and are automatically eliminated from the suggested call list. If the call is to a Coast Station, the radio will recognize this and select the correct channel.
 5. The radio summarizes the call details and asks for confirmation to send the call (SEND?). Press ENT or push the rotary knob to send the call. The TX annunciator is displayed on the screen while the DSC call is being sent.
 6. If the call is acknowledged (ACK), press PTT to talk. If there's no reply to a routine call, try again (see Section 5-3-1).

5-3-1 Retry a Routine Call

VHF721 SEND AGAIN? > YES CANCEL
--

1. If there's no reply to your call after one minute (UNABLE TO ACKNOWLEDGE) the radio asks if you want to retry the call (SEND AGAIN?).
2. Select YES and press ENT or push the rotary knob to retry the call. If the call still can't be placed, the radio returns to normal operation.

5-3-2 Acknowledge an Individual Incoming Call

RCV: INDIV 012345678 ENTER -> ACK ESC -> EXIT
--

The Explorer 721EU requires the operator to manually send an acknowledgement to the requesting radio. Press ENT or push the rotary knob to send an acknowledgement or press ESC to cancel.

The Explorer 721US automatically sends an acknowledgement to the requesting radio within 10 seconds of receiving the call.

5-4 Call the Most Recent Caller (LAST CALL)

DSC CALL
INDIVIDUAL
> LAST CALL
GROUP

EXPLORER 721
INDIVIDUAL
ROUTINE
10:22AM LOC

EXPLORER 721
INDIVIDUAL
ROUTINE
> SET CHANNEL

EXPLORER 721
INDIVIDUAL
ROUTINE
> SEND?

This facility is useful and used frequently.

1. Press CALL/MENU to enter the DSC CALL menu. LAST CALL is automatically selected. Press ENT or push the rotary knob to display the contact details of the most recent incoming call.
2. Select the working channel. Duplex channels can't usually be called and are automatically eliminated from the suggested call list. If the call is to a Coast Station, the radio will recognize this and select the correct channel.
3. The radio summarizes the call details and asks for confirmation to send the call (SEND?). Press ENT or push the rotary knob to send the call, and continue as explained in Section 5-3.

5-5 Call a Group (GROUP)

DSC CALL
INDIVIDUAL
LAST CALL
> GROUP

SELECT GROUP
> RD GROUP
GROUP #2
GROUP#3

RD GROUP
055554444
ROUTINE
> SET CHANNEL

EXPLORER 721
INDIVIDUAL
ROUTINE
> SEND?

1. Press CALL/MENU to enter the DSC CALL menu, then select GROUP. The radio displays the names of your groups.
2. Select the group that you want to call (the Group MMSID must be set before making the call). Then set the channel and continue as explained in Section 5-3.

5-6 Call All Ships (ALL SHIPS)

DSC CALL
LAST CALL
GROUP
> ALL SHIPS

ALL SHIPS
> URGENCY
SAFETY
ROUTINE

ALL SHIPS
URGENCY
> YES
NO

1. Press CALL MENU to enter the DSC CALL menu, then select ALL SHIPS.
2. The priority is set automatically to URGENCY, but you can change the priority level of the DSC call to routine, safety, urgency, or distress. Choose:
 - URGENCY only when there's a serious situation or problem that could lead to a distress situation
 - SAFETY to send safety information to all other vessels in range
 - ROUTINE to make a routine call to all vessels (721US only)
 - DISTRESS only when there's a distress situation
3. Select the working channel and press ENT or press the rotary knob. (NOTE: If you're making a distress call, the radio goes to CH16 automatically.) Duplex channels can't usually be called and are automatically eliminated from the suggested call list. If the call is to a Coast Station, the radio will recognize this and

select the correct channel.

- The radio asks for confirmation of the ALL SHIPS call (SEND?). Press ENT or push the rotary knob to select YES and send the call, and continue as explained in Section 5-3.

5-7 Call using the Call Log (CALL LOG)

DSC CALL GROUP ALL SHIPS > CALL LOG	11 VHF721 INDIVIDUAL ROUTINE 10:45PM LOC	VHF721 > CALL BACK DELETE SAVE	VHF721 INDIVIDUAL ROUTINE > SET CHANNEL
VHF721 INDIVIDUAL ROUTINE > SEND?			

The Call Log contains the contact details for the 20 most recent incoming calls, so you can call any of them again quickly.

- Press CALL/MENU to enter the DSC CALL menu, then select CALL LOG.
The radio displays the contact details for the most recent incoming call as the first entry (01) in the call log.
- Select the desired contact details. In this example, the contact details for the 11th most recent call are displayed.
To save this contact in your buddy list, select SAVE and press ENT or push the rotary knob. Enter a name for this contact. The logged MMSID is automatically displayed.
- Press ENT or push the rotary knob to confirm the call back, then set the working channel and press ENT or push the rotary knob to send the call. Continue as explained in Section 5-3.

5-8 Call using the Distress Log (DIST LOG)

The Distress Log contains the data for the 10 most recent relayed distress calls, so that you can call any of them quickly. Always try to make voice contact on CH16 first, as follows:

- Press CALL/MENU to enter the DSC CALL menu, then select DIST LOG.
- The most recently received distress call is the first entry (01) in the Distress Log. Select the entry that you want to call. The details are displayed over two screens that alternate every 1.5 seconds; the first screen shows the location and name or MMSID of the vessel in distress, the second screen shows the nature of the emergency (if specified) and the MMSID of the vessel that relayed the distress call.
- Set the channel and continue as explained in Section 5-3.

DSC CALL ALL SHIPS CALL LOG > DIST LOG	02 10:03 UTC VHF721 (xxx) 82°50. N 27°45. W	DISTRESS RELAY PIRACY 987654321	VHF721 > CALL BACK DELETE SAVE MMSID
VHF721 INDIVIDUAL ROUTINE > SET CHANNEL	VHF721 INDIVIDUAL ROUTINE > SEND?		

5-9 Request the LL Position of a Buddy (LL REQUEST)

```
DSC CALL
CALL LOG
DIST LOG
> LL REQUEST
```

```
LL REQUEST
> SAM
VHF721
BUDDY #3
```

```
SAM
LL REQUEST
> SEND?
```

```
SAM
LL REQUEST
CALLING...
```

```
channel name
SAM
LL REQUEST
AWAITING ACK
```

1. Press CALL/MENU to enter the DSC CALL menu, then select LL REQUEST.
2. Select the buddy whose LL position you want to request then press ENT or push the rotary knob to send the request.
3. The working channel name is displayed while the radio waits for an acknowledgement from your buddy. Continue as explained in Section 5-3-1. If there's no reply after 1 minute the radio asks if you want to retry. Continue as explained in Section 5-3-2.

5-9-1 Track Your Buddy (TRACK BUDDY)

Use the TRACKLIST option to select the buddy (or buddies) whose position you want to track, specify the time interval through the INTERVAL option and then start the track. Alternatively, if the buddy and time are already set to your preference, just start tracking.

Select Your Buddy as follows:

```
DSC CALL
DIST LOG
LL REQUEST
> TRACK BUDDY
```

```
TRACK BUDDY
START TRACK
> SET BUDDY
TRACKLIST
```

```
SET BUDDY
> BUDDY1 OFF
BUDDY2 ON
BUDDY3 OFF
```

```
SET BUDDY
BUDDY1
> ON
OFF
```

1. Press CALL/MENU to enter the DSC CALL menu, then select TRACK BUDDY.
2. Select SET BUDDY then select the buddy you want to track. You can set a maximum of 3 buddies to track.
3. Select ON to track that buddy or OFF to not track that buddy, and press ENT or push the rotary knob to confirm. (Repeat for the other two buddies if necessary.)

To delete a buddy from the tracklist, just scroll to the buddy's name and press ENT or push the rotary knob. Select YES to confirm, then press ENT or push the rotary knob again.

Set the Time Interval as follows:

```
DSC CALL
DIST LOG
LL REQUEST
> TRACK BUDDY
```

```
TRACK BUDDY
> INTERVAL
```

```
INTERVAL
> 15 MINUTES
30 MINUTES
1 HOUR
```

1. Press CALL/MENU to enter the DSC CALL menu, then select TRACK BUDDY.
2. Select INTERVAL, then select the desired time interval. Press ENT or push the rotary knob to confirm.

Start Tracking as follows:

DSC CALL
DIST LOG
LL REQUEST
> TRACK BUDDY

TRACK BUDDY
> START TRACK
SET BUDDY
TRACKLIST

START TRACK
BUDDY1 OFF
BUDDY2 ON
BUDDY3 OFF

START TRACK
> YES
NO
PRESS ENTER

1. Press CALL/MENU to enter the DSC CALL menu, then select TRACK BUDDY.
2. Select START TRACK, then select YES. The START TRACK display changes to STOP TRACK. To stop tracking at any time, just select YES.

As soon as you start tracking, an LL Request is sent immediately on CH70 and your radio waits for acknowledgement of the (first) buddy's LL position to be displayed on your LCD.

Each of the selected buddies is polled for their LL positions at regular time intervals. When information is received, a friendly ringtone is sounded and the position is shown on the LCD. Press any key to cancel the display.

An LL position that is received is not stored in your radio's log, but is broadcast over NAVBUS to the chartplotters. Press any key to acknowledge or wait for the automatic 20 second timeout.

NOTE: The Explorer 721 can receive and display the LL position data at normal or enhanced resolution.

5-10 Receive an All Ships Call (RCV: ALL SHIP)

RCV: ALL SHIP
priority
VHF721
ESC -> EXIT

When you receive notification of an ALL SHIP call, press any key to cancel the alert. The radio automatically selects CH16.

The priority level and the user MMSID are displayed on the LCD. If the radio recognises the user MMSID as one of your buddies, the buddy's name is displayed in place of the user MMSID.

No acknowledgement is required. Press PTT to initiate voice contact on CH16 and then switch to a working channel.

The call data is stored in the Call Log (see Section 5-7).

5-11 Receive an Individual Call (RCV: INDIV)

RCV: INDIV
VHF721
ENTER -> ACK
ESC -> EXIT

INDIV ACK
VHF721
PRESS PTT
ESC -> EXIT

When you receive notification of an INDIV call, press any key to cancel the alert.

The radio automatically selects the channel designated in the incoming call. INDIV calls are almost always routine priority.

If the radio recognises the user MMSID as one of your buddies, the buddy's name is displayed in place of the user MMSID.

The 721US responds automatically but the 721EU prompts you to press ENT or push the rotary knob to acknowledge the incoming call.

The caller should respond to your acknowledgement by making voice contact on the designated channel. If this doesn't happen, you can press PTT to initiate voice contact instead.

The call data is stored in the Call Log (see Section 5-7).

5-12 Receive a Group Call (RCV: GROUP)

RCV: GROUP
GP: RD GROUP
VHF721
ROUTINE

When you receive notification of a GROUP call, press any key to cancel the alert. The radio automatically selects the channel designated in the incoming call.

The priority level is always routine, and the group is identified on the screen. The group will be one of the three groups of frequently called people that you set up earlier (see Section 4-3).

You don't need to send an acknowledgement. If desired, press PTT to initiate voice contact on the designated channel.

The call data is stored in the Call Log (see Section 5-7).

5-13 Receive a Geographic Call (RCV: GEOGRAPH)

RCV: GEOGRAPH
VHF721
10:34 UTC
ESC -> EXIT

A geographic call is sent to all vessels within a specific geographic boundary area.

When you receive notification of a GEOGRAPH call, press any key to cancel the alert. The radio automatically selects the channel designated in the incoming call.

The time and the user MMSID or name are displayed on the screen. If the radio recognizes the user MMSID as one of your buddies, the buddy's name is displayed in place of the user MMSID.

Monitor the working channel for an announcement from the calling vessel.

5-14 Receive a Polled Position Call (RCV: POSITION)

RCV: POSITION
BUDDY3
82°50.003'N
27°45.543'W

When you receive GPS position data from a buddy in response to your LL request (see Section 5-9), you're recommended to make a written note of the position, especially if it's a good fishing position.

If enhanced LL position information is available from your buddy, it's shown on the LCD until the display changes.

Section 6 - Distress Calls

A valid user MMSID must have been entered to access this DSC function. If you don't have a user MMSID, see Appendix D.

IMPORTANT: This Northstar radio is designed to generate a digital maritime distress call to facilitate search and rescue. To be effective as a safety device, this radio must be used only within the geographic range of a shore-based VHF marine Channel 70 distress and safety watch system. The geographic range may vary but under normal conditions is approximately 20 nautical miles.

6-1 Send a Distress Call

DISTRESS CALL
> ABANDONING
PIRACY
OVER BOARD

DISTRESS CALL
> PIRACY
HOLD DISTRESS
2 SECONDS..

DISTRESS CALL
SENT! WAIT..
PRESS ESC
TO CANCEL..

1. Open the red cover labelled DISTRESS.
If time is available to specify the nature of the distress, go to step 2. Otherwise, go directly to step 3.
2. Press the DISTRESS key to display the following categories. Scroll to the category that describes your situation, then press ENT:

UNDEFINED
FIRE
FLOODING
COLLISION
GROUNDING
LISTING
SINKING
ADRIFT
ABANDONING
PIRACY
OVER BOARD

3. Hold down the DISTRESS key for about 3 seconds, until you see the distress call message (DISTRESS CALL SENT!) on the LCD. The whole display starts to flash and beep loudly.

The distress call repeats five times continuously. It then repeats randomly every 3.5 to 4.5 minutes until a distress acknowledgement (DISTRESS ACK) is received from a search and rescue authority or until you cancel the distress call manually.

The radio selects CH16 automatically so that you can hear any incoming voice contacts from search and rescue authorities or other vessels within range.

Press ESC if you need to cancel the distress call. This is the only key that operates in distress mode.

6-2 Receive a Distress Acknowledgement (DISTRESS ACK)

The Coast Guard is the only agency allowed to send a Distress Acknowledgement (DISTRESS ACK).

When a distress acknowledgement is sent from the Coast Guard, your radio automatically cancels the distress mode transmissions and CH16 is selected.

Press PTT to talk with the Coast Guard.

6-2 Receive a Distress Call (RCV: DISTRESS)

RCV: DISTRESS
123456789
FLOODING
ESC → EXIT

RCV: DISTRESS
10:34 UTC
82°50.003'N
27°45.543'W

An alert sounds when a distress call (DISTRESS!) is received. Press any key to cancel the alert. You don't need to send an acknowledgement.

The radio automatically selects CH16 and displays the details of the distress call on the screen. Press PTT to establish voice contact.

The details are displayed over two screens that alternate every 1.5 seconds; the first screen shows the user MMSID and nature of the emergency (if specified), the second screen shows the time and the location (if specified). If the location and time aren't specified, they're replaced with sequences of 9s and 8s respectively.

The radio is capable of receiving enhanced LL position data if the vessel transmitting the distress call is sending this. This provides the position of the distressed vessel to within 60 ft (20 m).

6-3 Receive a Distress Relay (RCV: DISTRESS RELAY)

RCV: DISTRESS
RELAY
123456789
ESC → EXIT

An alert sounds when a distress relay (DISTRESS RELAY) is received from an individual or from an All Ships transmission. Press any key to cancel the alert.

Try to make voice contact with the calling vessel. Maintain a listening watch on CH16 and standby to lend assistance.

6-3 Relay a Distress Call from the Distress Log (RELAY)

You can relay a Distress Call in your Distress Log to an Individual or to All Ships.

VHF721
DELETE
SAVE MMSID
> RELAY

RELAY
> INDIV RELAY
ALL RELAY

INDIV RELAY
> MANUAL NEW
BUDDY1
BUDDY2

1. Press CALL/MENU to enter the DSC CALL menu, then select DIST LOG (see Section 5.8).
2. The most recently received distress call is the first entry (01) in the Distress Log. Select the distress call that you want to relay, then select RELAY.
3. Now select either:
 - INDIV RELAY to relay the distress call to an individual and select MANUAL NEW if the person is not in your buddy list, otherwise scroll to the name of your buddy. Press ENT or push the rotary knob. (If you selected MANUAL NEW, you need to enter the user MMSID then press ENT or push the rotary knob.)
 - ALL RELAY to relay the distress call to All Ships then press ENT or push the rotary knob.
4. The radio automatically selects CH16 and displays the details of the distress call on the screen.
5. Press ENT or push the rotary knob to relay the Distress Call.

Appendix A - Technical Specifications

Northstar Explorer 721US and 721EU

GENERAL

Power Supply:	13.6 V DC.
Current drain: Transmit	6 A at 25 W Tx / 1.5 A at 1 W Tx
Current drain: Receive	Less than 250 mA in standby
Baro sampling (radio off):	Less than 3 mA, 85 mA in active standby
Useable channels:	International, USA, Canada, Weather (country specific)
Mode:	16K0G3E (FM) / 16K0G2B (DSC)
Handset	Works only with optional Explorer 701US or optional Explorer 701EU

PHYSICAL

LCD display (viewing):	40 (H) x 48 (W) mm FSTN 4 x 12 character
Contrast control:	Yes
Backlight control:	Yes
Antenna connector:	SO-239 (50 ohm)
Temperature Range:	-15°C to +50°C
Waterproof:	JIS-7
Dimensions:	161 (W) x 75 (H) x 147 (D) mm - without bracket
Weight:	3.0 lbs (1.36 kg) without microphone
Frequency stability:	+/- 10ppm
Frequency control:	PLL
GPS/NMEA input:	Yes
Comm. port:	4800 baud NMEA, 38400 baud NAVBUS
DSC:	Yes
Rotary channel selector:	Yes

FEATURES

Flush mounting kit:	Yes
Dust cover:	Yes
Local/Distant control:	Yes
Position polling:	Yes
Track Your Buddy:	Yes
Group Call:	Yes
Call logs:	Yes - 20 individual and 10 distress
DSC USCG SC101:	721US
DSC Recreational Class S:	Canada
DSC Class D:	721EU and Canada Commercial
Barometer, Temperature and Happy Fish:	Yes

Channel Naming:	Yes
Tri watch, favorite channel scan:	Yes
All scan:	Yes
User programmable MMSID:	Yes (User MMSID and ATIS (721EU)
MMSID and NAME directory:	Yes - 20 numbers & group

TRANSMITTER

Frequency:	156.025 - 157.425 MHz
Output power:	25 W / 1 W selectable
Transmitter protection:	Open / short circuit of antenna
Max Freq deviation:	+/- 5 kHz
Spurious & harmonics:	better than @ 2.5 W
Modulation distortion:	Less than 4% @ 1 kHz for a +/-3 kHz deviation

RECEIVER

Frequency:	156.025 - 163.275 MHz
12 dB SINAD sensitivity:	0.25 uV (distant) / 2.5 uV (local)
Adjacent CH selectivity:	more than 70 db
Spurious response:	more than 70 db
Intermodulation rejection ratio:	more than 68 db
Residual Noise level:	more than -40 db unscelched
Audio output power:	2 W (with 8 ohm at 10% distortion) 4 W with 4 ohm external speaker
Compass safe distance:	1.5' (0.5 m)

Specifications are subject to change without notice.

Appendix B - Troubleshooting

1. The transceiver will not power up.

A fuse may have blown OR there is no voltage getting to the transceiver.

- a) Check the power cable for cuts, breaks, or squashed sections.
- b) After checking the wiring, replace the 7 Amp fuse (a spare fuse is supplied).
- c) Check the battery voltage. This must be greater than 10.5 V.

2. The transceiver blows the fuse when the power is switched on.

The power wires may have been reversed.

- a) Check that the red wire is connected to the positive battery terminal, and the black wire is connected to the negative battery terminal.

3. The speaker makes popping or whining noises when the engine is running.

Electrical noise may be interfering with the transceiver.

- a) Re-route the power cables away from the engine.
- b) Add a noise suppressor to the power cable.
- c) Use resistive spark plug wires and/or use an alternator whine filter.

4. No sound from the external speaker.

- a) Check that the external speaker cable is physically connected.
- b) Check the soldering of the external speaker cable.

5. Transmissions are always on low power, even when high (HI) power is selected.

The antenna may be faulty.

- a) Test the transceiver with a different antenna.
- b) Have the antenna checked out.

6. Battery symbol is displayed.

The power supply is too low.

- a) Check the battery voltage. This should be at least 10.5 V \pm 0.5 V DC.
- b) Check the alternator on the vessel.

7. No position information is displayed.

The GPS cable may be faulty or the GPS setting may be incorrect.

- a) Check that the GPS cable is physically connected.
- b) Check the polarity of the GPS cable.
- c) Check the baud rate setting of the GPS if applicable. The baud rate setting should be 4800 for NMEA or 38400 for NAVBUS. Parity should be set to NONE.

Appendix C - VHF Marine Channel Charts

C.1 International (EU-DSC ON)

EU countries have special channeling requirements and the radio is cloned to match the market requirements.

NOTE For assistance in understanding the Table, see notes a) to o) below. (WRC-2000)

Channel designator	Notes	Transmitting frequencies MHz		Inter-ship	Port operations and ship movement		Public correspondence
		Ship stations	Coast stations		Single frequency	Two frequency	
60		156,025	160,625			x	x
01		156,050	160,650			x	x
61	m), o)	156,075	160,675		x	x	x
02	m), o)	156,100	160,700		x	x	x
62	m), o)	156,125	160,725		x	x	x
03	m), o)	156,150	160,750		x	x	x
63	m), o)	156,175	160,775		x	x	x
04	m), o)	156,200	160,800		x	x	x
64	m), o)	156,225	160,825		x	x	x
05	m), o)	156,250	160,850		x	x	x
65	m), o)	156,275	160,875		x	x	x
06	f)	156,300		x			
66		156,325	160,925			x	x
07		156,350	160,950			x	x
67	h)	156,375	156,375	x	x		
08		156,400		x			
68		156,425	156,425		x		
09	i)	156,450	156,450	x	x		
69		156,475	156,475	x	x		
10	h)	156,500	156,500	x	x		
70	j)	156,525	156,525	Digital selective calling for distress, safety and calling			
11		156,550	156,550		x		
71		156,575	156,575		x		
12		156,600	156,600		x		
72	i)	156,625		x			
13	k)	156,650	156,650	x	x		
73	h), i)	156,675	156,675	x	x		
14		156,700	156,700		x		
74		156,725	156,725		x		
15	g)	156,750	156,750	x	x		
75	n)	156,775			x		

Channel designator	Notes	Transmitting frequencies MHz		Inter-ship	Port operations and ship movement		Public correspondence
		Ship stations	Coast stations		Single frequency	Two frequency	
16		156,800	156,800		DISTRESS, SAFETY AND CALLING		
76	<i>n)</i>	156,825			x		
17	<i>g)</i>	156,850	156,850	x	x		
77		156,875		x			
18	<i>m)</i>	156,900	161,500		x	x	x
78		156,925	161,525			x	x
19		156,950	161,550			x	x
79		156,975	161,575			x	x
20		157,000	161,600			x	x
80		157,025	161,625			x	x
21		157,050	161,650			x	x
81		157,075	161,675			x	x
22	<i>m)</i>	157,100	161,700		x	x	x
82	<i>m), o)</i>	157,125	161,725		x	x	x
23	<i>m), o)</i>	157,150	161,750		x	x	x
83	<i>m), o)</i>	157,175	161,775		x	x	x
24	<i>m), o)</i>	157,200	161,800		x	x	x
84	<i>m), o)</i>	157,225	161,825		x	x	x
25	<i>m), o)</i>	157,250	161,850		x	x	x
85	<i>m), o)</i>	157,275	161,875		x	x	x
26	<i>m), o)</i>	157,300	161,900		x	x	x
86	<i>m), o)</i>	157,325	161,925		x	x	x
27		157,350	161,950			x	x
87		157,375			x		
28		157,400	162,000			x	x
88		157,425			x		
AIS 1	<i>l)</i>	161,975	161,975				
AIS 2	<i>l)</i>	162,025	162,025				

SPECIAL NOTES ON INTERNATIONAL CHANNEL USAGE

Notes referring to the Table

General notes

The International mode is not legal for use in US or Canada Waters

- Administrations may designate frequencies in the inter-ship, port operations and ship movement services for use by light aircraft and helicopters to communicate with ships or participating coast stations in predominantly maritime support operations under the conditions specified in Nos. 51.69, 51.73, 51.74, 51.75, 51.76, 51.77 and 51.78. However, the use of the channels which are shared with public correspondence shall be subject to prior agreement between interested and affected administrations.
- The channels of the present Annex, with the exception of channels 06, 13, 15, 16, 17, 70, 75 and 76, may also be used for high-speed data and facsimile transmissions, subject to special arrangement between interested and affected administrations.
- The channels of the present Annex, but preferably channel 28 and with the exception of channels 06, 13, 15, 16, 17, 70, 75 and 76, may be used for direct-printing telegraphy and data transmission, subject to special arrangement between interested and affected administrations.

- d. The frequencies in this Table may also be used for radiocommunications on inland waterways in accordance with the conditions specified in No. 5.226. – 56 – 62238 IEC:2003(E)
- e. Administrations having an urgent need to reduce local congestion may apply 12,5 kHz channel interleaving on a non-interference basis to 25 kHz channels, provided:
 - Recommendation ITU-R M.1084-2 shall be taken into account when changing to 12,5 kHz channels;
 - it shall not affect the 25 kHz channels of the present Annex maritime mobile distress and safety frequencies, especially the channels 06, 13, 15, 16, 17, and 70, nor the technical characteristics mentioned in Recommendation ITU-R M.489-2 for those channels;
 - implementation of 12,5 kHz channel interleaving and consequential national requirements shall be subject to prior agreement between the implementing administrations and administrations whose ship stations or services may be affected.

Specific notes

- f. The frequency 156,300 MHz (channel 06) (see No. 51.79 and Appendices 13 and 15) may also be used for communication between ship stations and aircraft stations engaged in coordinated search and rescue operations. Ship stations shall avoid harmful interference to such communications on channel 06 as well as to communications between aircraft stations, ice-breakers and assisted ships during ice seasons.
- g. Channels 15 and 17 may also be used for on-board communications provided the effective radiated power does not exceed 1 W, and subject to the national regulations of the administration concerned when these channels are used in its territorial waters.
- h. Within the European Maritime Area and in Canada, these frequencies (channels 10, 67, 73) may also be used, if so required, by the individual administrations concerned, for communication between ship stations, aircraft stations and participating land stations engaged in coordinated search and rescue and anti-pollution operations in local areas, under the conditions specified in Nos. 51.69, 51.73, 51.74, 51.75, 51.76, 51.77 and 51.78.
- i. The preferred first three frequencies for the purpose indicated in Note a) are 156,450 MHz (channel 09), 156,625 MHz (channel 72) and 156,675 MHz (channel 73).
- j. Channel 70 is to be used exclusively for digital selective calling for distress, safety and calling.
- k. Channel 13 is designated for use on a worldwide basis as a navigation safety communication channel, primarily for intership navigation safety communications. It may also be used for the ship movement and port operations service subject to the national regulations of the administrations concerned.
- l. These channels (AIS 1 and AIS 2) will be used for an automatic ship identification and surveillance system capable of providing worldwide operation on high seas, unless other frequencies are designated on a regional basis for this purpose.
- m. These channels may be operated as single frequency channels, subject to special arrangement between interested or affected administrations. (WRC-2000)
- n. The use of these channels (75 and 76) should be restricted to navigation-related communications only and all precautions should be taken to avoid harmful interference to channel 16, e.g. by limiting the output power to 1 W or by means of geographical separation.
- o. These channels may be used to provide bands for initial testing and the possible future introduction of new technologies, subject to special arrangement between interested or affected administrations. Stations using these channels or bands for the testing and the possible future introduction of new technologies shall not cause harmful interference to, and shall not claim protection from, other stations operating in accordance with Article 5. (WRC-2000)

C.2 USA Channel Chart

CH	SEND (MHz)	RECEIVE (MHz)	TRAFFIC TYPE	SHIP TO SHIP	SHIP TO SHORE	NAME TAG
01A	156.050	156.050	Port Operations, Selected VTS Areas	Yes	Yes	PORT OPS/VTS
03A ⁴	156.150	156.150	US Government, Coast Guard	Yes	Yes	UNAUTHORIZED
05A	156.250	156.250	Port Operations, Selected VTS Areas	Yes	Yes	PORT OPS/VTS
06	156.300	156.300	Inter-ship Safety	Yes	No	SAFETY
07A	156.350	156.350	Commercial	Yes	Yes	COMMERCIAL
08	156.400	156.400	Commercial (inter-ship only)	Yes	No	COMMERCIAL
09	156.450	156.450	Recreational Calling Channel	Yes	Yes	CALLING
10	156.500	156.500	Commercial	Yes	Yes	COMMERCIAL
11	156.550	156.550	Commercial, VTS in Selected Areas	Yes	Yes	VTS
12	156.600	156.600	Port Operations, Selected VTS Areas	Yes	Yes	PORT OPS/VTS
13 ³	156.650	156.650	Intership Navigation Safety (bridge-to-bridge), 1W with Power-up	Yes	No	BRIDGE COM
14	156.700	156.700	Port Operations, Selected VTS Areas	Yes	Yes	PORT OPS/VTS
15 ²	RX Only	156.750	Environmental, RX Only	-----	-----	ENVIROMENTAL
16	156.800	156.800	International Distress, Safety, and Calling	Yes	Yes	DISTRESS
17 ¹	156.850	156.850	State Controlled – 1W Only	Yes	Yes	SAR
18A	156.900	156.900	Commercial	Yes	Yes	COMMERCIAL
19A	156.950	156.950	Commercial	Yes	Yes	COMMERCIAL
20	157.000	161.600	Port Operations, Canadian Coast Guard, Duplex	No	Yes	PORT OPS
20A	157.000	157.000	Port Operations	Yes	Yes	PORT OPS
21A ⁴	157.050	157.050	U.S. Government, Canadian Coast Guard	Yes	Yes	UNAUTHORIZED
22A	157.100	157.100	Coast Guard Liaison	Yes	Yes	COAST GUARD
23A ⁴	157.150	157.150	U.S. Government, Coast Guard	Yes	Yes	UNAUTHORIZED
24	157.200	161.800	Public Correspondence, Marine Operator	No	Yes	TELEPHONE
25	157.250	161.850	Public Correspondence, Marine Operator	No	Yes	TELEPHONE
26	157.300	161.900	Public Correspondence, Marine Operator	No	Yes	TELEPHONE
27	157.350	161.950	Public Correspondence, Marine Operator	No	Yes	TELEPHONE
28	157.400	162.000	Public Correspondence, Marine Operator	No	Yes	TELEPHONE

CH	SEND (MHz)	RECEIVE (MHz)	TRAFFIC TYPE	SHIP TO SHIP	SHIP TO SHORE	NAME TAG
61A ⁴	156.075	156.075	<i>U.S. Government, Canadian Coast Guard</i>	Yes	Yes	UNAUTHORIZED
63A	156.175	156.175	Port Operations, VTS in Selected Areas	Yes	Yes	PORT OPS/VTS
64A ⁴	156.225	156.225	<i>U.S. Government, Canadian Commercial Fishing</i>	Yes	Yes	UNAUTHORIZED
65A	156.275	156.275	Port Operations	Yes	Yes	PORT OPS
66A	156.325	156.325	Port Operations	Yes	Yes	PORT OPS
67 ³	156.375	156.375	Commercial, bridge-to-bridge, 1W with Power-up	Yes	No	BRIDGE COM
68	156.425	156.425	Boat Operations, Recreational	Yes	No	SHIP - SHIP
69	156.475	156.475	Boat Operations, Recreational	Yes	Yes	PLEASURE
70 ⁶	156.525	156.525	Digital Selective Calling - DSC	-----	-----	DSC
71	156.575	156.575	Boat Operations, Recreational	Yes	Yes	PLEASURE
72	156.625	156.625	Boat Operations, Recreational	Yes	No	SHIP - SHIP
73	156.675	156.675	Port Operations	Yes	Yes	PORT OPS
74	156.725	156.725	Port Operations	Yes	Yes	PORT OPS
77 ¹	156.875	156.875	Port Operations –1W Only	Yes	Yes	PORT OPS
78A	156.925	156.925	Boat Operations, Recreational	Yes	No	SHIP - SHIP
79A	156.975	156.975	Commercial	Yes	Yes	COMMERCIAL
80A	157.025	157.025	Commercial	Yes	Yes	COMMERCIAL
81A ⁴	157.075	157.075	<i>U.S. Government, Environmental Protection Agency Operations</i>	Yes	Yes	UNAUTHORIZED
82A ⁴	157.125	157.125	<i>U.S. Government, Canadian Coast Guard</i>	Yes	Yes	UNAUTHORIZED
83A ⁴	157.175	157.175	<i>U.S. Government, Canadian Coast Guard</i>	Yes	Yes	UNAUTHORIZED
84	157.225	161.825	Public Correspondence, Marine Operator	No	Yes	TELEPHONE
85	157.275	161.875	Public Correspondence, Marine Operator	No	Yes	TELEPHONE
86	157.325	161.925	Public Correspondence, Marine Operator	No	Yes	TELEPHONE
87	157.375	161.975	Public Correspondence, Marine Operator	No	Yes	TELEPHONE
88	157.425	162.025	Public Correspondence, Marine Operator	No	Yes	TELEPHONE
88A	157.425	157.425	Commercial, Intership Only	Yes	No	COMMERCIAL

WEATHER		MHz	TRAFFIC TYPE			NAME TAG
Wx01	RX Only	162.550	NOAA WEATHER CHANNEL	-----	-----	NOAA WX
Wx02	RX Only	162.400	NOAA WEATHER CHANNEL	-----	-----	NOAA WX
Wx03	RX Only	162.475	NOAA WEATHER CHANNEL	-----	-----	NOAA WX
Wx04	RX Only	162.425	NOAA WEATHER CHANNEL	-----	-----	NOAA WX
Wx05	RX Only	162.450	NOAA WEATHER CHANNEL	-----	-----	NOAA WX
Wx06	RX Only	162.500	NOAA WEATHER CHANNEL	-----	-----	NOAA WX
Wx07	RX Only	162.525	NOAA WEATHER CHANNEL	-----	-----	NOAA WX
Wx08	RX Only	161.650	CANADIAN WEATHER CHANNEL	-----	-----	CANADA WX
Wx09	RX Only	161.775	CANADIAN WEATHER CHANNEL	-----	-----	CANADA WX
Wx10	RX Only	163.275	NOAA WEATHER CHANNEL	-----	-----	NOAA WX

SPECIAL NOTES ON USA CHANNEL USAGE

1. LOW POWER (1 W) only.
2. Receive Only.
3. LOW POWER (1 W) initially. Override to HIGH POWER by holding down H/L key before transmitting. Used normally in bridge-to-bridge communications.
4. Lightly Shaded Simplex channels 03A, 21A, 23A, 61A, 64A, 81A, 82A, and 83A cannot be lawfully used in U.S. waters unless special authorization is obtained from the U.S. Coast Guard. Not for use by the general public.
5. The letter "A" illuminated by the channel number indicates the USA channel is simplex. This same channel is always duplex when selecting International. There is no "A" reference for International channels. The letter "B" is only used for some Canadian "Receive Only" channels.
6. Channel 70 is designated for use exclusively for Digital Selective Calling (DSC), such as Distress, Safety, and Ship Calls. No voice communication is allowed on CH70.

C-3 CANADA Channel CHART

CH	SEND (MHz)	RECEIVE (MHz)	TRAFFIC TYPE	SHIP TO SHIP	SHIP TO SHORE	NAME TAG
01	156.050	160.650	Public Correspondence, Duplex	No	Yes	TELEPHONE
02	156.100	160.700	Public Correspondence, Duplex	No	Yes	TELEPHONE
03	156.150	160.750	Public Correspondence, Duplex	No	Yes	TELEPHONE
04A	156.200	156.200	Canadian Coast Guard, SAR	Yes	Yes	CANADIAN CG
05A	156.250	156.250	Port Operations, VTS in Selected Areas	Yes	Yes	PORT OPS/VTS
06	156.300	156.300	Inter-ship Safety	Yes	No	SAFETY
07A	156.350	156.350	Commercial	Yes	Yes	COMMERCIAL
08	156.400	156.400	Commercial (inter-ship only)	Yes	No	COMMERCIAL
09	156.450	156.450	Recreational Calling Channel	Yes	Yes	CALLING
10	156.500	156.500	Commercial	Yes	Yes	COMMERCIAL
11	156.550	156.550	Commercial, VTS in Selected Areas	Yes	Yes	VTS
12	156.600	156.600	Port Operations, VTS in Selected Areas	Yes	Yes	PORT OPS/VTS
13 ³	156.650	156.650	Intership Navigation Safety (bridge-to-bridge) 1W with power-up	Yes	No	BRIDGE COM
14	156.700	156.700	Port Operations, VTS in Selected Areas	Yes	Yes	PORT OPS/VTS
15 ¹	156.750	156.750	Commercial – 1W Only	Yes	Yes	COMMERCIAL
16	156.800	156.800	International Distress, Safety, and Calling	Yes	Yes	DISTRESS
17 ¹	156.850	156.850	State Controlled – 1W Only	Yes	Yes	SAR
18A	156.900	156.900	Commercial	Yes	Yes	COMMERCIAL
19A	156.950	156.950	Canadian Coast Guard	Yes	Yes	CANADIAN CG
20 ¹	157.000	161.600	Canadian Coast Guard, Duplex– 1W Only	No	Yes	CANADIAN CG
21	157.050	161.650	Port Operations, Duplex	No	Yes	PORT OPS
21A	157.050	157.050	U.S. Government, Canadian Coast Guard	Yes	Yes	UNAUTHORIZED
21B	RX Only	161.650	Port Operations, RX Only	-----	-----	PORT OPS
22A	157.100	157.100	Canadian Coast Guard Liaison	Yes	Yes	CANADIAN CG
23	157.150	161.750	Public Correspondence, Duplex	No	Yes	TELEPHONE
24	157.200	161.800	Public Correspondence, Duplex	No	Yes	TELEPHONE
25	157.250	161.850	Public Correspondence, Duplex	No	Yes	TELEPHONE
25B	RX Only	161.850	Public Correspondence, RX Only	-----	-----	TELEPHONE
26	157.300	161.900	Public Correspondence, Duplex	No	Yes	TELEPHONE
27	157.350	161.950	Public Correspondence, Duplex	No	Yes	TELEPHONE
28	157.400	162.000	Public Correspondence, Duplex	No	Yes	TELEPHONE

CH	SEND (MHz)	RECEIVE (MHz)	TRAFFIC TYPE	SHIP TO SHIP	SHIP TO SHORE	NAME TAG
28B	RX Only	162.000	Public Correspondence, RX Only	-----	-----	TELEPHONE
60	156.025	160.625	Public Correspondence, Duplex	No	Yes	TELEPHONE
61A ⁴	156.075	156.075	<i>U.S. Government, Canadian Coast Guard</i>	Yes	Yes	<i>UNAUTHORIZED</i>
62A	156.125	156.125	Canadian Coast Guard	Yes	Yes	CANADIAN CG
64	156.225	160.825	Public Correspondence, Duplex	No	Yes	TELEPHONE
64A ⁴	156.225	156.225	<i>U.S. Government, Canadian Commercial Fishing</i>	Yes	Yes	<i>UNAUTHORIZED</i>
65A	156.275	156.275	Port Operations	Yes	Yes	PORT OPS
66A ¹	156.325	156.325	Port Operations – 1W Only	Yes	Yes	PORT OPS
67	156.375	156.375	Commercial, SAR	Yes	No	COMMERCIAL
68	156.425	156.425	Boat Operations, Recreational	Yes	No	SHIP - SHIP
69	156.475	156.475	Commercial Fishing Only	Yes	Yes	COMMERCIAL
70 ⁶	156.525	156.525	Digital Selective Calling - DSC	-----	-----	DSC
71	156.575	156.575	Boat Operations, Recreational	Yes	Yes	PLEASURE
72	156.625	156.625	Intership	Yes	No	SHIP - SHIP
73	156.675	156.675	Commercial Fishing Only	Yes	Yes	COMMERCIAL
74	156.725	156.725	Commercial Fishing Only	Yes	Yes	COMMERCIAL
77 ¹	156.875	156.875	Port Operations – 1W Only	Yes	Yes	PORT OPS
78A	156.925	156.925	Boat Operations, Recreational	Yes	No	SHIP - SHIP
79A	156.975	156.975	Commercial	Yes	Yes	COMMERCIAL
80A	157.025	157.025	Commercial	Yes	Yes	COMMERCIAL
81A ⁴	157.075	157.075	<i>U.S. GovernmENT or push the rotary knob Operations</i>	Yes	Yes	<i>UNAUTHORIZED</i>
82A ⁴	157.125	157.125	<i>U.S. Government, Canadian Coast Guard</i>	Yes	Yes	<i>UNAUTHORIZED</i>
83	157.175	161.775	Canadian Coast Guard	Yes	Yes	CANADIAN CG
83A ⁴	157.175	157.175	<i>U.S. Government, Canadian Coast Guard</i>	Yes	Yes	<i>UNAUTHORIZED</i>
83B	RX Only	161.775	Canadian Coast Guard, RX Only	-----	-----	CANADIAN CG
84	157.225	161.825	Public Correspondence, Marine Operator	No	Yes	TELEPHONE
85	157.275	161.875	Public Correspondence, Marine Operator	No	Yes	TELEPHONE
86	157.325	161.925	Public Correspondence, Marine Operator	No	Yes	TELEPHONE
87	157.375	161.975	Public Correspondence, Marine Operator	No	Yes	TELEPHONE
88	157.425	162.025	Public Correspondence, Marine Operator	No	Yes	TELEPHONE

WEATHER		MHz	TRAFFIC TYPE			NAME TAG
Wx01	RX Only	162.550	NOAA WEATHER CHANNEL	-----	-----	NOAA WX
Wx02	RX Only	162.400	NOAA WEATHER CHANNEL	-----	-----	NOAA WX
Wx03	RX Only	162.475	NOAA WEATHER CHANNEL	-----	-----	NOAA WX
Wx04	RX Only	162.425	NOAA WEATHER CHANNEL	-----	-----	NOAA WX
Wx05	RX Only	162.450	NOAA WEATHER CHANNEL	-----	-----	NOAA WX
Wx06	RX Only	162.500	NOAA WEATHER CHANNEL	-----	-----	NOAA WX
Wx07	RX Only	162.525	NOAA WEATHER CHANNEL	-----	-----	NOAA WX
Wx08	RX Only	161.650	CANADIAN WEATHER CHANNEL	-----	-----	CANADA WX
Wx09	RX Only	161.775	CANADIAN WEATHER CHANNEL	-----	-----	CANADA WX
Wx10	RX Only	163.275	NOAA WEATHER CHANNEL	-----	-----	NOAA WX

SPECIAL NOTES ON CANADA CHANNEL USAGE

1. LOW POWER (1 W) only.
2. Receive Only.
3. LOW POWER (1 W) initially. Override to HIGH POWER by holding down H/L key before transmitting. Used normally in bridge-to-bridge communications.
4. Lightly Shaded Simplex channels 21A, 23A, 61A, 64A, 81A, 82A, and 83A cannot be lawfully used in Canada waters unless special authorization is obtained from the Canadian Coast Guard. Not for use by the general public.
5. The letter "A" illuminated by the channel number indicates the Canada channel is simplex. This same channel is always duplex when selecting International. There is no "A" reference for International channels. The letter "B" is only used for some Canadian "Receive Only" channels.
6. Channel 70 is designated for use exclusively for Digital Selective Calling (DSC), such as Distress, Safety, and Ship Calls. No voice communication is allowed on CH70.
7. The CANADA mode is not legal to use in U.S. waters.

C-4 EU INLAND WATERWAY CHANNELS - Country Specific

For specific channel information for your country, please refer to local authorities.

CH	SPECIFIC FOOTNOTES	TRANSMITTING FREQUENCY (MHZ)		SHIP-TO-SHIP	SHIP-TOPORT	NAUT.INFORM
		SHIP	LAND			
60	a)	156.025	160.625			x
1	a)	156.05	160.65			x
61	a)	156.075	160.675			x
2	a)	156.1	160.7			x
62	a)	156.125	160.725			x
3	a)	156.15	160.75			x
63	a)	156.175	160.775			x
4	a)	156.2	160.8			x
64	a)	156.225	160.825			x
5	a)	156.25	160.85			x
65	a)	156.275	160.875			x
6	a) b)	156.3	156.3	x		
66	a)	156.325	160.925			x
7	a)	156.35	160.95			x
67	a) c)	156.375	156.375			x
8	a) q)	156.4	156.4	x		
68	a)	156.425	156.425			x
9	a) b) c)	156.45	156.45			x
69	a)	156.475	156.475			x
10	e)	156.5	156.5	x		
70	a)	156.525	156.525	Digital selective calling for distress, safety and calling		
11		156.55	156.55		x	
71		156.575	156.575		x	
12		156.6	156.6		x	
72	a) r)	156.625	156.625	x		
13	f)	156.65	156.65	x		
73	f) g)	156.675	156.675			x
14	q)	156.7	156.7		x	
74	a)	156.725	156.725		x	
15	h)	156.75	156.75			x
75	o)	156.775	156.775		x	
16	i)	156.8	156.8			x
76	j) d) o)	156.825	156.825			x

17	h)	156.85	156.85			x
77	a) k)	156.875	156.875	x		
18		156.9	161.5			x
78		156.925	161.525			x
19		156.95	161.55			x
79	a)	156.975	161.575			x
20		157	161.6			x
80		157.025	161.625			x
21	a)	157.05	161.65			x
81	a)	157.075	161.675			x
22		157.1	161.7			x
82	l) m)	157.125	161.725			x
23	m)	157.15	161.75			x
83	a) m)	157.175	161.775			x
24	m)	157.2	161.8			x
84	m)	157.225	161.825			x
25	m)	157.25	161.85			x
85	a) m)	157.275	161.875			x
26	m)	157.3	161.9			x
86	a) m)	157.325	161.925			x
27	m)	157.35	161.95			x
87	a) d)	157.375	157.375			x
28	m)	157.4	162			x
88	a) p)	157.425	157.425			x
AIS 1	a) n)	161.975	161.975			
AIS 2	a) n)	162.025	162.025			

1.1 General remarks to frequency table 1

- 1.1.1 The channels for service categories ship-to-ship and nautical information may also be used for vessel traffic-systems by traffic centres.
- 1.1.2 In some countries, frequencies certain channels are used for another service category or other radio services. These countries are Austria, Bulgaria, Croatia, the Federal Republic of Yugoslavia, Hungary, Moldova, Romania, the Russian Federation, the Slovak Republic, the Czech Republic (with exemption of channels 08, 09, 72, 74 and 86), Ukraine and the Federal Republic of Yugoslavia. The Administrations concerned should make any possible attempt to make these frequencies channels as soon as possible available for the radiotelephone service on Inland Waterways and/or the required service category.

1.2 Explanation of specific footnotes in frequency table 1

- a. In the countries mentioned under 1.1.2, it is strictly prohibited to use this channel.
- b. This channel is not allowed to be used between Rhine km 150 and km 350.
- c. In the Netherlands, this channel is used by its on-scene communications during safety operations on the North Sea, IJsselmeer, Waddenzee, Ooster- and Westerschelde.
- d. This channel may also be used for piloting, mooring, tugging and for other nautical purposes.
- e. This channel is the first ship-to-ship channel, unless the competent authority has designated another channel.
In the countries mentioned under 1.1.2, it is allowed that the output power is set to a value between 6 and 25 W until 1 January 2005.
- f. In the countries mentioned under 1.1.2, this channel is used for service category ship-to-port authorities.
- g. In the Netherlands, this channel is used by its national coastguard for communications during oil pollution operations on the North Sea and for safety messages for the North Sea, Waddenzee, IJsselmeer, Ooster- and Westerschelde.
- h. This channel may be used only for service category on-board on board communications.
- i. This channel may be used only for communications between seagoing vessels and participating land stations in case of distress and safety communications within the maritime sea-areas.
In the countries mentioned under 1.1.2, this channel may be used only for distress, safety and calling.
- j. The output power shall be reduced automatically to a value between 0.5 and 1 W.
- k. This channel may be used for communications with a social character.
- l. In the Netherlands and Belgium, this channel may be used for transmitting messages concerning bunkering and victualling. The output power has to be reduced manually to a value between 0.5 and- 1 W.
- m. This channel may also be used for public correspondence.
- n. This channel will be used for an automatic ship identification and surveillance system (AIS) capable of providing worldwide operating on seas and Inland Waterways.
- o. The availability of this channel is on a voluntary basis. All existing equipment shall be capable to of operating on this channel within a ten-year period after the entry into force of this Arrangement.
- p. After permission of the competent authority, this channel may be used only for special events on a temporary basis.
- q. In the Czech Republic this channel is used for service category nautical information.
- r. In the Czech Republic this channel is used for service category ship-to-port authorities.

Appendix D - MMSID and License Information

You must obtain a user MMSID (Marine Mobile Service Identity) and enter it into your radio in order to use the DSC functions. Contact the appropriate authorities in your country. If you're unsure who to contact, consult your Northstar dealer.

The user MMSID is a unique nine digit number, similar to a personal telephone number. It is used on marine transceivers that are capable of using DSC (Digital Select Calling).

Depending upon your location, you may need a radio station license for the VHF 721. You may also need an individual operator's license.

Brunswick New Technologies Inc. recommends that you check the requirements of your national radio communications authorities before operating DSC functions.

Section 7 - Install the Explorer 721

7-1 Installation Options

There are two ways to install the radio. You can choose:

- *a deck or overhead mounted gimbal installation.* The reversible mounting gimbal is fixed to a suitable site and the radio is placed into it. The radio can be removed for storage and the viewing angle can be adjusted.
- *a recessed installation.* The radio is recessed into a cavity cut into a bulkhead. The radio fixture is permanent and the viewing angle cannot be adjusted.

NOTE: An optional handset with a 9.8' (3 m) docking cable included can be purchased and connected to your Explorer 721 base unit to give second station operation and intercom capability. The optional 701US handset (for the Explorer 721US) and the optional 701EU handset (for the Explorer 721EU) are shown on the front cover.

7-2 Location Requirements

Please check these BEFORE doing any cutting or drilling.

Whichever installation method you choose, ensure that the chosen location:

- is at least 3' (1 m) from the antenna
- allows easy connection to (at least) a 10 Amp fused 13.6 V DC electrical source and the antenna
- is at least 1.5' (45 cms) from the compass to avoid creating magnetic deviation of the compass during radio operation
- has a suitable space close by for installing the microphone bulkhead mount
- provides easy access to the controls on the front panel
- provides reasonable access to the wiring at the back of the radio
- provides enough room to fix the DSC warning label (*721US only*).

7-3 Checklist

The following items should be supplied in the box. Check before starting the installation and contact your dealer if an item is missing.

NOTE: An antenna is NOT provided. Consult your Northstar dealer for advice if necessary.

1. Mounting gimbal for the VHF radio
2. Power supply cable with inbuilt 7 Amp fuse
3. External speaker connection cable with white (+) wire and black (-) wire
4. GPS connection cable
5. Two mounting knobs
6. Microphone bulkhead mount
7. Four self-tapping screws for the mounting gimbal
8. Four flat screws for the mounting gimbal
9. Four spring washers for the mounting gimbal
10. Four plain washers for the mounting gimbal
11. Four nuts for the mounting gimbal
12. Two self-tapping screws for the microphone bulkhead mount

13. Two flat screws for the microphone bulkhead mount
14. Two spring washers for the microphone bulkhead mount
15. Two plain washers for the microphone bulkhead mount
16. Two nuts for the microphone bulkhead mount
17. Two flush-mount brackets for recessed installation
18. Two M5x32 screws for recessed installation
19. Two M5x10 screws for recessed installation
20. Two plastic stoppers for the recessed installation (not pictured)
21. Installation template (not pictured)
22. One 7 Amp spare fuse (not pictured) in case of accidental reverse of battery polarity
23. Explorer 721 base unit and microphone (not pictured)
24. Explorer 721 protective cover (not pictured)

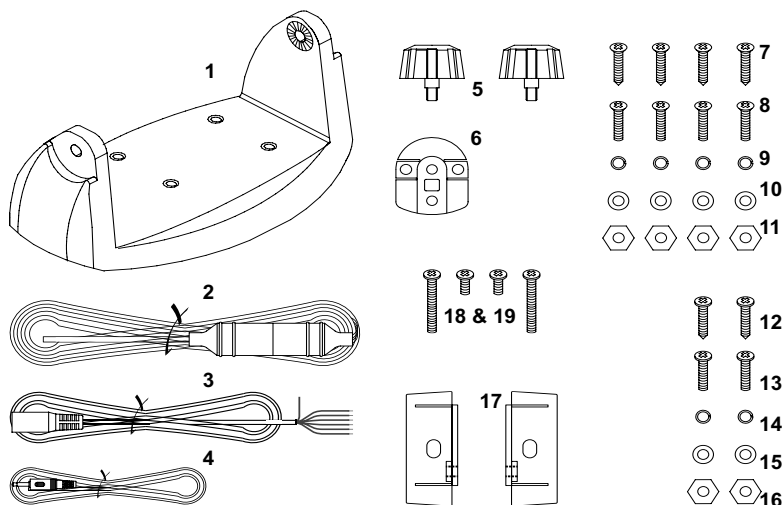

7-4 Gimbal Installation

1. Hold the mounting gimbal at the chosen location and use a soft pencil to mark the screw hole positions onto the mounting surface.
2. If you can't reach behind the mounting surface to attach the nuts, use the self-tapping screws instead of the flat screws shown in the picture. If you're drilling into fiberglass, use a drill bit smaller than 3/16" (5mm) to drill the pilot holes.
Otherwise, drill the four screw holes where marked, using a 3/16" (5mm) drill bit. Drill completely through the mounting surface.
3. Use a Phillips screwdriver and the set of four flat screws, spring washers, plain washers, and nuts to attach the mounting gimbal to the location site.

- Slide the radio into the mounting gimbal.
- Insert the two mounting knobs through the holes and tighten them sufficiently to hold the radio at the desired viewing angle.

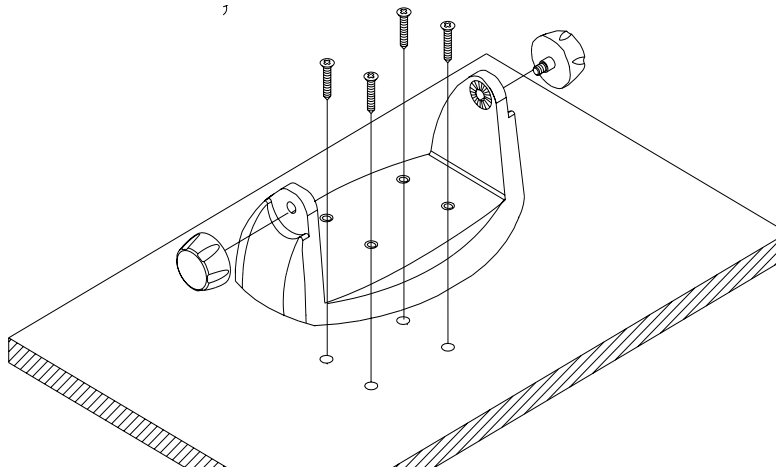

7-5 Change the Viewing Angle

The viewing angle on the gimbal mount has a 20° tilt range. To change the current viewing angle on the gimbal mount:

- Support the radio, then cautiously loosen the mounting knobs until the radio can be moved.
- Re-position the radio then tighten the mounting knobs again.

7-6 Recessed Installation

- Tape the installation template onto the chosen location site.
- Cut out the area marked by the solid dark line. (The dashed line indicates the total area that will be covered by the radio fascia after installation.)
- Remove the installation template and slide the radio into the cavity.
- Working from the rear of the bulkhead, align the ratched outstand on each side of the radio with the central hole in each mounting bracket.
- Use the two short M5x10 screws to screw the mounting brackets to the sides of the radio.
- Screw each M5x32 screw through the screw hole in the mounting bracket, then attach the stopper. If your bulkhead exceeds 0.51" (13mm), the stopper can be discarded if necessary.
- Tighten the M5x32 screws until the radio is held firmly against the rear of the bulkhead.

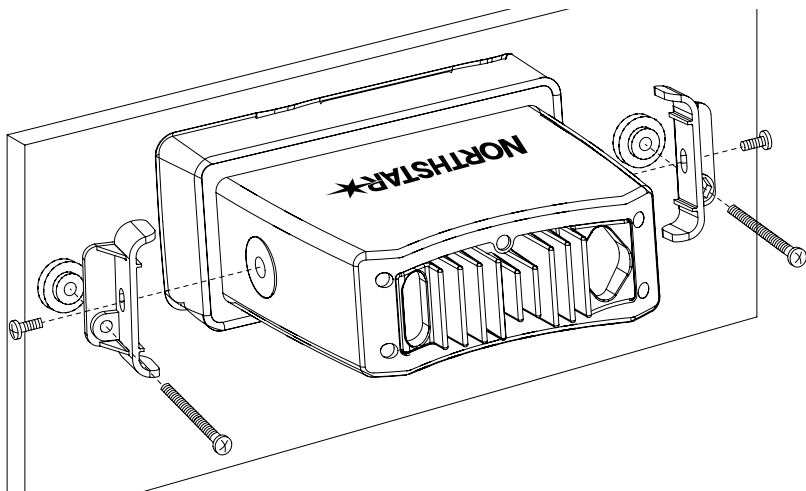

7-7 Install the Microphone Bulkhead Mount

1. Hold the microphone bulkhead mount at the chosen location and use a soft pencil to mark the screw hole positions on the mounting surface.

Ensure that the microphone curly cable will comfortably reach this location BEFORE you drill.

2. Drill the two pilot screw holes where marked.
3. Use a short length Phillips screwdriver and the set of two flat screws, spring washers, plain washers, and nuts to secure the microphone bulkhead mount at the location site.
4. Hang the microphone on its mount.

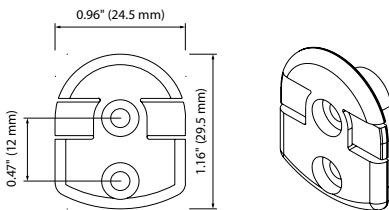

NOTE: This mic clip has a special magnet glued in the rear of the clip to sense ON/OFF HOOK. Other mic hangers cannot be used.

7-8 Connect the Radio Cables

The connectors are on the rear of the base unit, as follows:

1. **GPS connector.** Plug the GPS cable jack into the connector. (If you're not using this, be sure to put the protective cap securely over the connector to protect it from moisture and dust.)
2. **Docking Cable connector** for optional Handset. Plug the docking cable jack into the connector. (If you're not using this, be sure to put the protective cap securely over the connector to protect it from moisture and dust.)
3. **External Speaker connector.** Plug the external speaker cable jack into the connector BEFORE powering on the radio. Use a 4 Ohm 4 Watt external speaker.

- BLACK Power wire.** Connect this to the NEGATIVE (-) battery terminal.
- RED Power wire.** Connect this to the POSITIVE (+) battery terminal. Check that a 10 Amp fuse is installed on this power cable close to the battery.
- ANT.** A radio antenna is not supplied. A suitable radio antenna must be mounted and connected before operating the Explorer 721 radio. Consult your dealer for advice if necessary.
- GND.** A ground connection is not usually required..

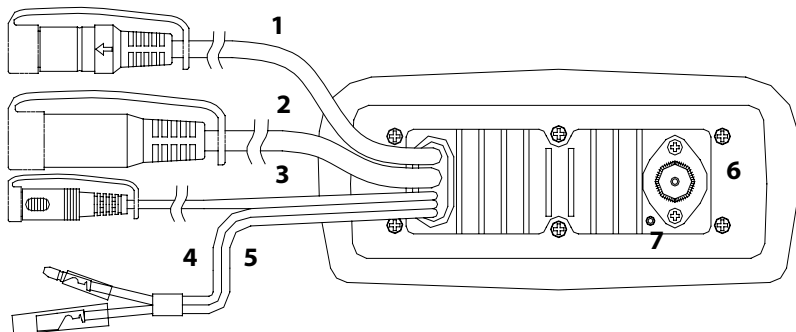

7-9 Set Up the Radio

IMPORTANT: You can't make any DSC transmissions until you've obtained a user MMSID and entered it into your Explorer 721.

The user MMSID is a unique nine digit number, similar to a personal telephone number. It is used on marine transceivers that are capable of using DSC (Digital Select Calling).

If you don't have a user MMSID contact the appropriate authorities in your country. If you're unsure who to contact, consult your Northstar dealer.

7-10 Enter Your User MMSID

WARNING: This is a *once-only operation*.

DSC SETUP > USER MMSID GROUP SETUP INDIV REPLY	INPUT USER MMSID -----	187654321 MMSID > STORE CANCEL	USER MMSID INPUT AGAIN -----
---	------------------------------	---	------------------------------------

- Select DSC SETUP, then USER MMSID. A dashed line appears.
Enter your user MMSID along the dashed line. Press ENT or push the rotary knob to confirm each correct entry and to move to the next digit.
If you make an error, press CH - until < appears, then press ENT or push the rotary knob to backup and correct the entry.
- Press ENT or push the rotary knob to store your user MMSID.
- Enter your user MMSID again as a password check, then press ENT or push the rotary knob to permanently store the user MMSID and return to the menu.

You can view your stored user MMSID at anytime by selecting USER MMSID in the main menu.

7-11 The Completed Installation (with Optional Handset)

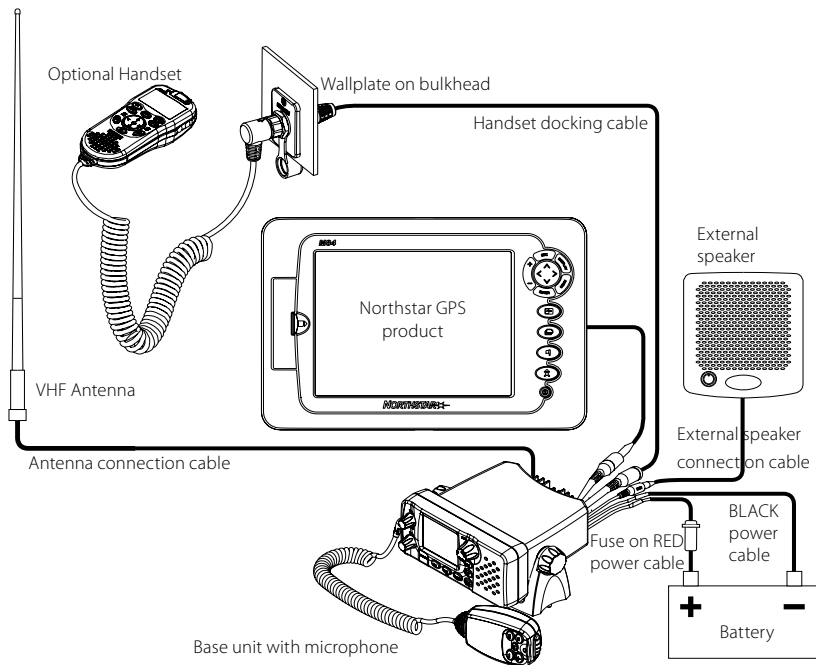

UNITED STATES

30 Sudbury Road,
Acton, MA 01720,
United States
Ph: +1 978.897.6600
Fax: +1 978.897.7241
sales@bntmarine.com

EUROPE

Unit 2, Ocean Quay,
Belvidere Rd, Southampton,
SO14 5QY, England
Ph: +44 2380 339922
Fax: +44 2380 330345
northstaruk@northstarnav.com

AUSTRALIA

PO Box 479,
Gladesville, NSW 2111,
Australia
Ph: +61 2 9879 9000
Fax: +61 2 9879 9001
northstaraus@northstarnav.com

NEW ZEALAND

PO Box 68 155,
Newton, Auckland,
New Zealand
Ph: +64 9 481 0500
Fax: +64 9 481 0590
northstarnz@northstarnav.com

www.northstarnav.com

NORTHSTAR 



Industry
Canada

Industrie
Canada



CE 0560 

Free Manuals Download Website

<http://myh66.com>

<http://usermanuals.us>

<http://www.somanuals.com>

<http://www.4manuals.cc>

<http://www.manual-lib.com>

<http://www.404manual.com>

<http://www.luxmanual.com>

<http://aubethermostatmanual.com>

Golf course search by state

<http://golfingnear.com>

Email search by domain

<http://emailbydomain.com>

Auto manuals search

<http://auto.somanuals.com>

TV manuals search

<http://tv.somanuals.com>