

# OLYMPUS®

## DIGITAL CAMERA

# E-PL1

## Instruction Manual

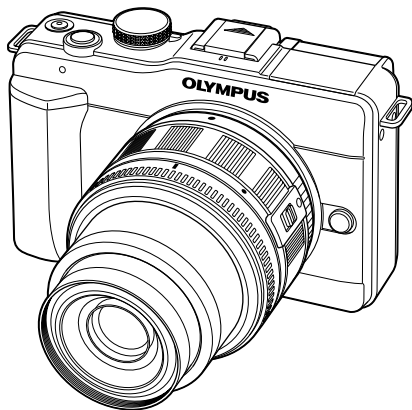

### Basic guide

#### Quick task index

#### Table of Contents

1. Basic photography and useful functions

2. Other shooting options and advanced settings

3. Flash shooting

4. Shooting and viewing movies

5. Playback options

6. Camera setup

7. Customizing camera settings

8. Printing pictures

9. Connecting the camera to a computer

10. Shooting tips and maintenance

11. Information

■ Thank you for purchasing an Olympus digital camera. Before you start to use your new camera, please read these instructions carefully to enjoy optimum performance and a longer service life. Keep this manual in a safe place for future reference.

■ We recommend that you take test shots to get accustomed to your camera before taking important photographs.

■ The screen and camera illustrations shown in this manual were produced during the development stages and may differ from the actual product.

■ The contents in this manual are based on firmware version 1.0 for this camera. If there are additions and/or modifications of functions due to firmware update for the camera, the contents will differ. For the latest information, please visit the Olympus website.

## Unpack the box contents

The following items are included with the camera.  
If anything is missing or damaged, contact the dealer from whom you purchased the camera.

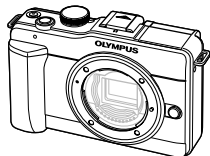

Camera



Body cap



Strap

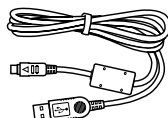

USB cable  
CB-USB6

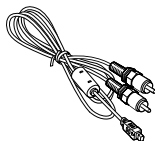

AV cable  
(Monaural)  
CB-AVC3



PS-BLS1(BLS-1)  
Lithium ion battery

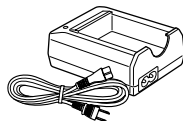

PS-BCS1(BCS-1)  
Lithium ion charger

- Computer software (ib)  
CD-ROM
- Instruction manual
- Warranty card

### Attaching the strap

**1** Thread the strap in the direction of the arrows.

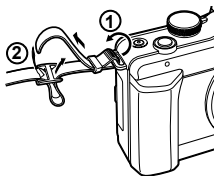



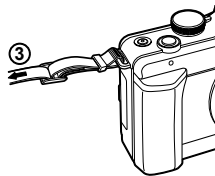

**2** Lastly, pull the strap tight making sure that it is fastened securely.



- Attach the other end of the strap to the other eyelet in the same way.

### Indications used in this manual

The following symbols are used throughout this manual.

 <b>Caution</b>	Important information on factors which may lead to a malfunction or operational problems. Also warns of operations that should be absolutely avoided.
 <b>Notes</b>	Points to note when using the camera.
 <b>Tips</b>	Useful information and hints that will help you get the most out of your camera.
	Reference pages describing details or related information.

# Charging and inserting the battery

## 1 Charging the battery.

### charging indicator

Amber light: Charging in progress

Blue light: Charging complete  
(Charging time: Up to approximately 3 hours 30 minutes)

Amber blinking: Charging error

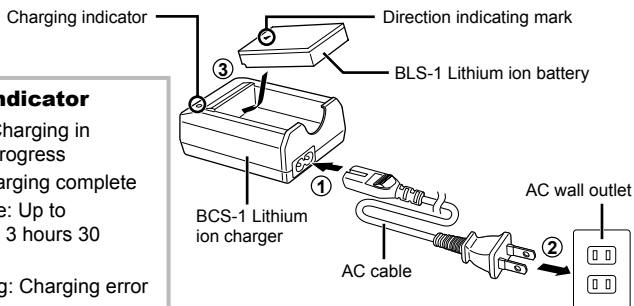

## 2 Loading the battery.

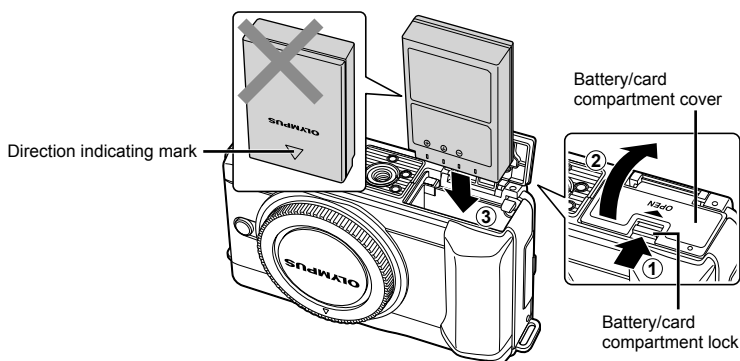

### Removing the battery

Turn off the camera before opening or closing the battery/card compartment cover.

To remove the battery, first push the battery lock knob in the direction of the arrow and then remove.

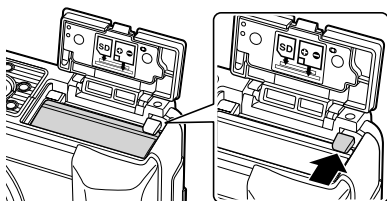

### Notes

- It is recommended to set aside a backup battery for prolonged shooting in case the battery in use drains.

# Inserting and removing cards

## 1 Loading the card.

- Insert the SD/SDHC card (referred to as “card” in these instructions) until it locks in place.

👉 “Card basics” (P. 95)

### ! Caution

- Turn off the camera before loading or removing the card.

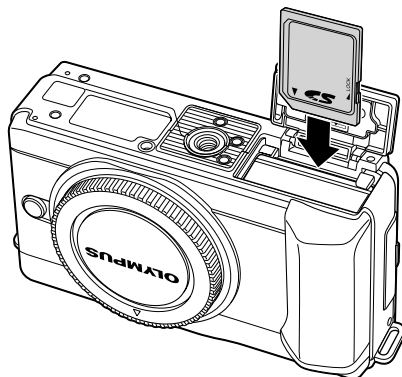

## Removing the card

Press the inserted card lightly and it will be ejected. Pull out the card.

### ! Caution

- Do not remove the battery or card while the card write indicator (P. 22) is displayed.

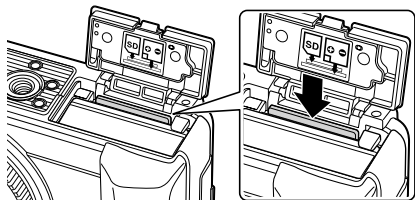

## 2 Closing the battery/card compartment cover.

- Close the cover until you hear a click.

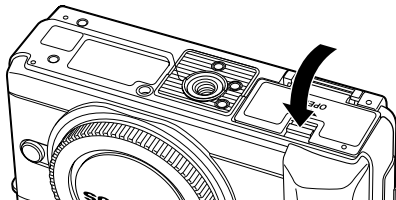

### ! Caution

- Close the battery/card compartment cover when using the camera.
- Do not remove the battery or card while the card write indicator (P. 22) is displayed. Failure to observe this precaution could result in the loss not only of the images being recorded but also of existing images.

# Attaching a lens to the camera

- 1 Remove the body cap from the camera and the rear cap from the lens.

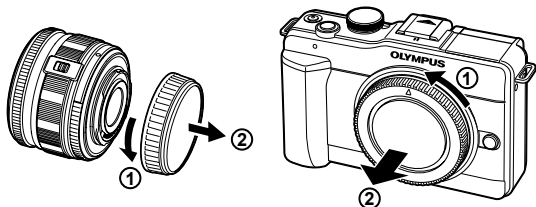

- 2 Attach a lens to the camera.

- Align the lens attachment mark (red) on the camera with the alignment mark (red) on the lens, then insert the lens into the camera's body.
- Rotate the lens in the direction indicated by the arrow until you hear it click.

Lens attachment mark

Alignment mark

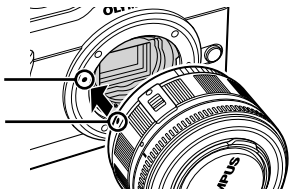

## ! Caution

- Make sure the camera is turned off.
- Do not press the lens release button.
- Do not touch internal portions of the camera.

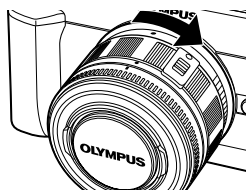

- 3 Remove the lens cap.

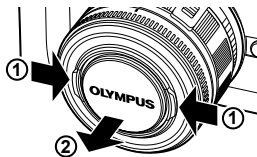

## Removing the lens from the camera

While pressing the lens release button, rotate the lens in the direction of the arrow.

 "Interchangeable lenses" (P. 97)



# Power on

- 1 Press the **ON/OFF** button to turn on the camera.
  - When the camera is turned on, the (blue) power lamp will light and the monitor will turn on.
  - To turn off the power, press the **ON/OFF** button again.
- 2 Set the mode dial to **FAUTO**.

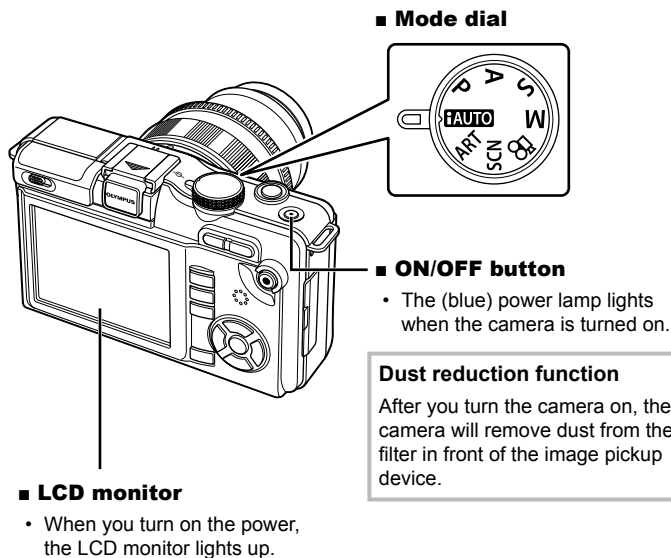

## Dust reduction function

After you turn the camera on, the camera will remove dust from the filter in front of the image pickup device.

## Battery level

- ▣ (green): Camera ready to shoot
- ▣ (green): Low battery
- ▣ (blinks red): Charge the battery

# Setting the date/time

Date and time information is recorded on the card together with the images. The file name is also included with the date and time information. Be sure to set the correct date and time before using the camera.

## 1 Display the menus.

- Press the **MENU** button to display the menus.

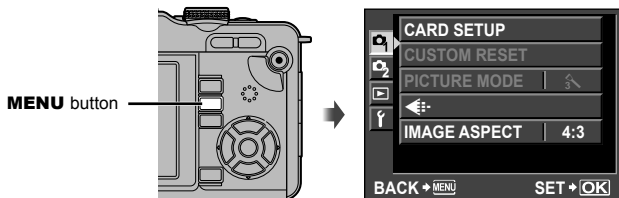

## 2 Select [⌚] in the [f] (setup) tab.

- Use  $\Delta$   $\nabla$  to select [f] and press  $\triangleright$ .

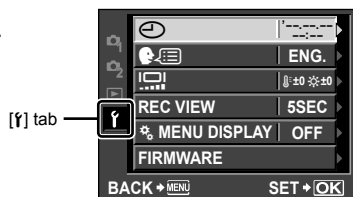

## 3 Set the date and time.

- Use  $\triangleleft$   $\triangleright$  to select items.
- Use  $\Delta$   $\nabla$  to change the selected item.
- Use  $\Delta$   $\nabla$  to select the date format.

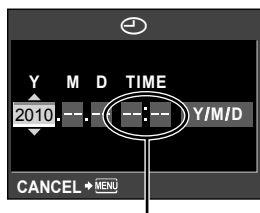

The time is displayed using a 24-hour clock.

## 4 Save settings and exit.

- Press  $\text{Ⓞ}$  to set the camera clock and exit to the main menu.
- Press the **MENU** button to exit the menus.

# Names of parts and functions

## Camera

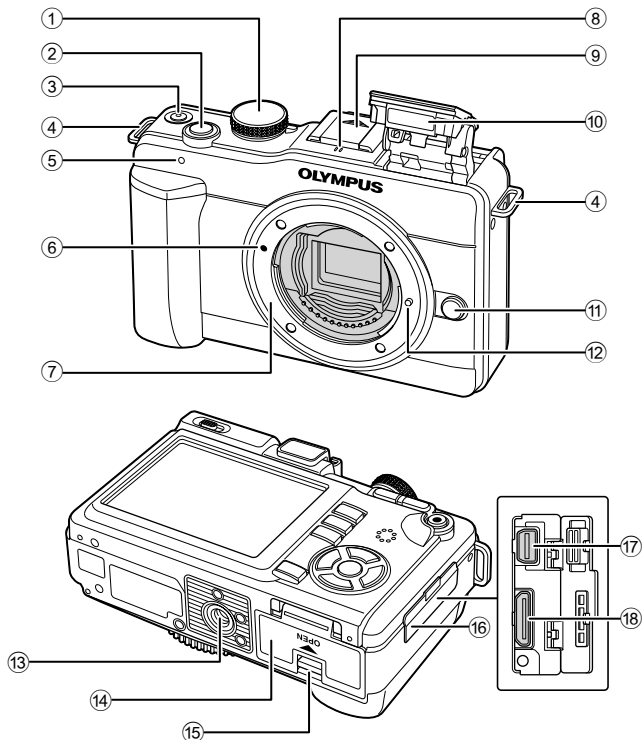

- |   |   |
|---|---|
| ① Mode dial.....P. 6, 10                                    | ⑩ Built-in flash.....P. 54                    |
| ② Shutter button ..... P. 11, 12, 46                        | ⑪ Lens release button .....P. 5               |
| ③ ON/OFF button.....P. 6                                    | ⑫ Lens lock pin                               |
| ④ Strap eyelet.....P. 2                                     | ⑬ Tripod socket                               |
| ⑤ Self-timer lamp.....P. 30                                 | ⑭ Battery/card compartment cover<br>.....P. 3 |
| ⑥ Lens attachment mark .....P. 5                            | ⑮ Battery/card compartment lock ....P. 3      |
| ⑦ Mount (Remove the body cap before<br>attaching the lens.) | ⑯ Connector cover                             |
| ⑧ Microphone .....P. 57, 65                                 | ⑰ Multi-connector.....P. 67, 84, 87           |
| ⑨ Hot shoe cover  | ⑱ HDMI mini-connector (type C)....P. 67       |



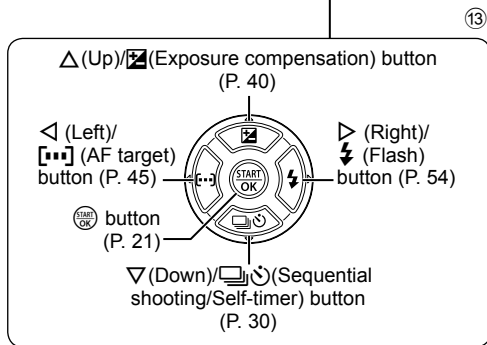
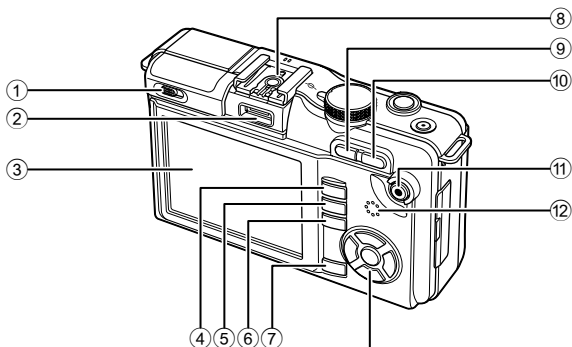

- |   |  |
|---|--|
| ① Flash switch ..... P. 54  | ⑧ Hot shoe ..... P. 100  |
| ② Accessory port  | ⑨ Fn/☒ button ..... P. 80/P. 59, 60                                  |
| ③ LCD monitor ..... P. 22, 23                                     | ⑩ Q button ..... P. 59, 60, 62                                       |
| ④ [▶] (Playback) button ..... P. 14, 59                           | ⑪ [MOVIE] / [LOCK] (Protect) button<br>..... P. 11, 13, 56/P. 59, 65 |
| ⑤ <b>MENU</b> button ..... P. 21                                  | ⑫ Speaker  |
| ⑥ <b>INFO</b> (Information display)<br>button ..... P. 22, 33, 61 | ⑬ Arrow pad  |
| ⑦ [ERASE] (Erase) button ..... P. 15, 59, 66                      |  |

# Names of parts and functions

## Mode dial

Use the mode dial to select the shooting mode. After choosing the shooting mode, use the shutter button to take photographs and the  (movie) button to shoot movies.

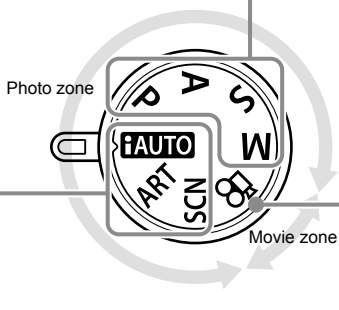
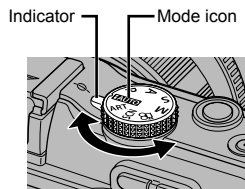

### ■ Advanced shooting modes

<b>P</b>	Program shooting (P. 36)
<b>A</b>	Aperture priority shooting (P. 37)
<b>S</b>	Shutter priority shooting (P. 38)
<b>M</b>	Manual shooting (P. 39)

- For more advanced shooting and greater creative control, you can set the aperture value and shutter speed.
- The settings made in the advanced shooting modes are retained even if the camera is turned off.

### ■ Movie mode

	Movie (P. 56)
---	---------------

### ■ Easy shooting modes



<b>iAUTO</b>	iAUTO (P. 6)
<b>ART</b>	Art filter (P. 16)
<b>SCN</b>	Scene (P. 17)



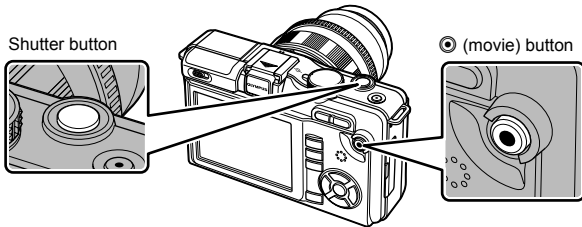

- Select according to the shooting scene. The camera sets the appropriate shooting conditions automatically.
- When rotating the mode dial or turning off the power in the easy shooting modes, functions with changes made to their settings are restored to the factory default settings.

### Tips

- Resetting camera settings:  "Resetting the camera settings" (P. 70)



Mode	Photos: shutter button	Movies:  (movie) button
<b>P</b>	<ul style="list-style-type: none"> <li>Aperture and shutter speed are automatically adjusted for optimal results.</li> </ul>	<ul style="list-style-type: none"> <li>The camera adjusts aperture and shutter speed automatically.</li> </ul>
<b>A</b>	<ul style="list-style-type: none"> <li>You control aperture.</li> </ul>	
<b>S</b>	<ul style="list-style-type: none"> <li>You control shutter speed.</li> </ul>	
<b>M</b>	<ul style="list-style-type: none"> <li>You control aperture and shutter speed.</li> </ul>	
<b>iAUTO</b>	<ul style="list-style-type: none"> <li>A full auto mode in which the camera automatically optimizes settings for the current scene.</li> </ul>	
<b>ART</b>	<ul style="list-style-type: none"> <li>Select an art filter.</li> </ul>	
<b>SCN</b>	<ul style="list-style-type: none"> <li>Select a scene.</li> </ul>	
	<ul style="list-style-type: none"> <li>Photographs are recorded at the settings selected for movies.</li> </ul>	<ul style="list-style-type: none"> <li>Shoot movies using art filter or aperture and shutter speed effects.</li> </ul>

- To take a photograph during movie recording, press the shutter button. Three files will be recorded to the memory card: the movie footage preceding the photograph, the photograph itself, and the movie footage following the photograph. Press the  (movie) button to end recording.
- Only one photograph can be taken at a time during movie recording; the self-timer and flash can not be used.
- Pressing the  (movie) button during sequential shooting ends shooting. A movie is not recorded.
- Image size and quality for photographs are independent of movie frame size.
- The autofocus and metering used in movie mode may differ from that used to take photographs.
- Pressing the  (movie) button during any of the following will end shooting without recording a movie:  
Sequential shooting/PANORAMA/multiple exposure/bracketing, etc
- The  (movie) button can not be used to record movies in the following instances:  
BULB/shutter button pressed halfway/playback zoom/PANORAMA, etc

# Taking photographs/shooting movies

## 1 Frame the shot.

- Keep your fingers and the strap away from the lens.

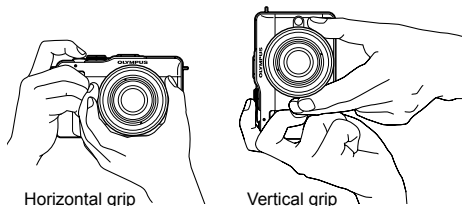

### Using lenses with an UNLOCK switch

Retractable lenses with an UNLOCK switch can not be used while retracted.

Turn the zoom ring in the direction of arrow (1) to extend the lens (2).

To store, turn the zoom ring in the direction of arrow (4) while sliding the UNLOCK switch (3).

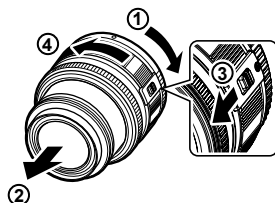

## 2 Adjust the focus.

- Lightly press the shutter button down to the first position (press the shutter button halfway).

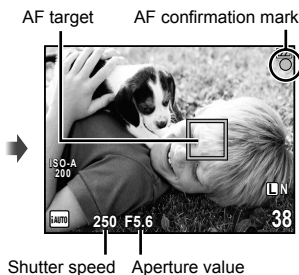
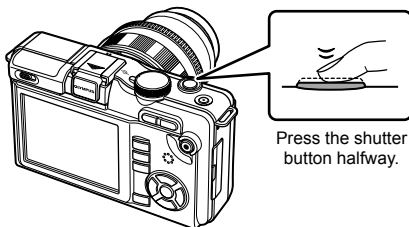

- Focus will lock, the AF confirmation mark (● or ○) will light, and an AF target will be briefly displayed to show the focus position.

●	Lenses that supports Hi-Speed Imager AF*
○	Lenses with other Four Thirds mounts

\* Visit our website for more information.

- The shutter speed and aperture value that have been set automatically by the camera are displayed.

### Pressing the shutter button halfway and all the way down

The shutter button has two positions. The act of lightly pressing the shutter button to the first position and holding it there is called “pressing the shutter button halfway,” that of pressing it all the way down to the second position “pressing the shutter button all (or the rest of) the way down.”



## 3 Release the shutter.

### Taking photographs

Press the shutter button all the way (fully).

- The shutter sounds and the picture is taken.

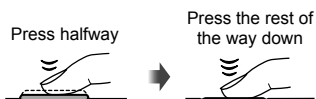



### Recording movies

Press the  (movie) button to begin recording.

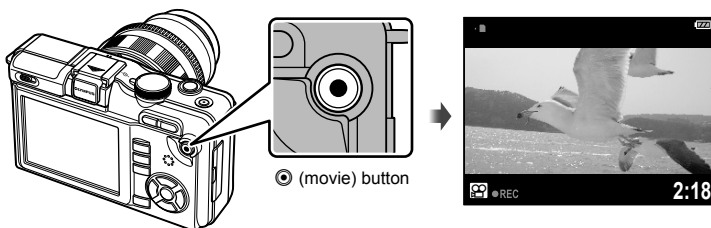
Press the  (movie) button again to end recording.



### Tips

- If no operations are performed for about 8 seconds, the monitor will dim. If no operations are performed for approximately another minute, the camera will enter “sleep” (stand-by) mode and all operations will be suspended. The camera activates again when you touch any button (the shutter button,  button, etc.).
- If no operations are performed for about 5 minutes after the camera enters sleep mode, the camera will turn off automatically.  “SLEEP” (P. 74)

### Caution

- Bright light sources appear black when framed in the monitor but are recorded normally in the final picture.
- If the camera is used for extended periods, the temperature of the image pickup device will rise and noise and colored fog may appear in images recorded at high ISO sensitivities. Choose a lower ISO sensitivity or turn the camera off for a short period.

# Playback/Erasing

## Single-frame playback

Press the  button to display your most recent photograph or movie.

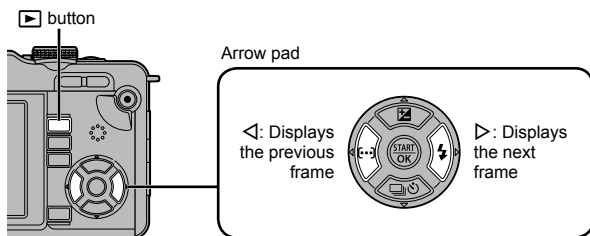



Still image





Movie

### ■ Close-up playback

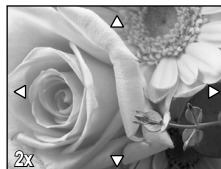
- To zoom in on the image currently displayed in single-frame playback, press the  button. Keep pressing the button to zoom in up to 14x. Press  to return to single-frame playback.



### ■ Index display

- To view multiple pictures, press the  button.
- Press the  button to view the currently selected picture full frame.





## Movie playback

Display a movie in single-frame playback and press  to display the playback menu. Select [MOVIE PLAY] and press  to begin playback.

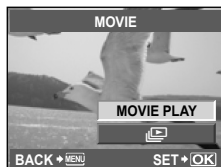
- To interrupt movie playback, press **MENU**.



## Erasing images

Display a image you want to delete and press . Select [YES] and press .

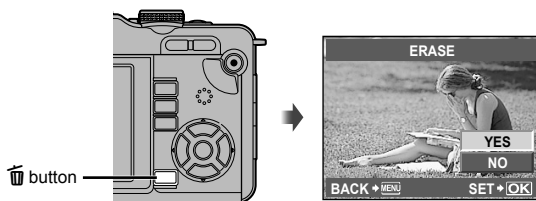

# Using art filters

## 1 Rotate the mode dial to **ART**.

- A menu of art filters will be displayed. Select a filter using  $\Delta$   $\nabla$ .



- Press  $\text{START/OK}$  or press the shutter button halfway to display the view through the lens in the monitor. Press  $\text{START/OK}$  to return to the art filter menu.

## 2 Shoot.

### ■ Types of art filters

POP ART	PIN HOLE
SOFT FOCUS	DIORAMA
GRAINY FILM	GENTLE SEPIA

### ! Caution

- Art filters are not applied to RAW images.
- If RAW is selected for the record mode when the camera enters art filter mode, the record mode will automatically be set to **L/N+RAW**.
- The grainy appearance of the picture may be emphasized depending on the type of art filter.

### 💡 Tips

- Camera settings can be adjusted using the menus (P. 21) and buttons (P. 9).
- You can also configure the camera so that the live control (P. 20) and super control panel (P. 81) can be used. "📷CONTROL SETTING" (P. 74)



# Shooting in scene mode

## 1 Rotate the mode dial to **SCN**.

- A menu of scene menu will be displayed. Select a scene using  $\Delta$   $\nabla$ .



- Press  $\text{START OK}$  or press the shutter button halfway to display the view through the lens in the monitor. Press  $\text{START OK}$  to return to the scene menu.

## 2 Shoot.

### ■ Types of scene modes

PORTRAIT	DIS MODE
e-PORTRAIT	MACRO
LANDSCAPE	NATURE MACRO
LANDSCAPE+PORTRAIT	CANDLE
SPORT	SUNSET
NIGHT SCENE	DOCUMENTS
NIGHT+PORTRAIT	PANORAMA (P. 35)
CHILDREN	FIREWORKS
HIGH KEY	BEACH & SNOW
LOW KEY	

### ! Caution

- [e-PORTRAIT] can not be applied to RAW images.
- When RAW or RAW+JPEG photos are taken using [e-PORTRAIT], two images will be recorded: a RAW image and an  $\text{M}$ -quality (2560×1920) JPEG to which effects have been applied.
- When JPEG is set in [e-PORTRAIT], two images are saved, one from before application of the effect (with set picture quality) and the other from after application of the effect ( $\text{M}$  (2560×1920)).

## Using the iAUTO mode live guides



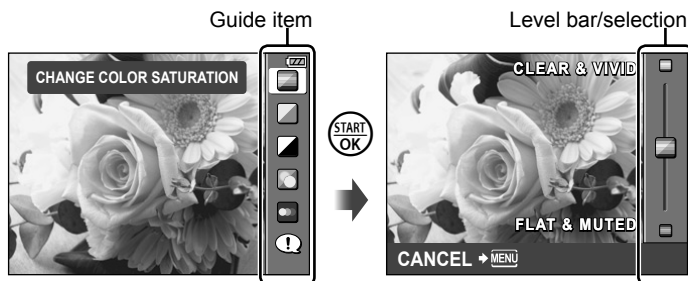

Although iAUTO (iAUTO) mode is a full auto mode, a “live guide” is available to guide you through creative adjustments to settings controlling such elements as vividness, hue, brightness, focus, and motion using simple operations and easy-to-understand instructions displayed over the view through the lens in the monitor.





Guide item	Level bar/selection	Affects <sup>*2</sup>
CHANGE COLOR SATURATION <sup>*1</sup>	CLEAR & VIVID ↔ FLAT & MUTED	Saturation, contrast, gradation, etc.
CHANGE COLOR IMAGE <sup>*1</sup>	WARM ↔ COOL	Color temperature, gradation, etc.
CHANGE BRIGHTNESS <sup>*1</sup>	BRIGHT ↔ DARK	Exposure compensation, gradation, etc.
BLUR BACKGROUND <sup>*1</sup>	BLUR ↔ SHARP	Aperture, live preview, etc.
EXPRESS MOTIONS <sup>*1</sup>	BLURRED MOTION ↔ STOP MOTION	Shutter speed (1/2 s – fastest speed), frame rate, etc.
SHOOTING TIPS	<ul style="list-style-type: none"> <li>• TIPS FOR CHILD PHOTO</li> <li>• TIPS FOR PET PHOTO</li> <li>• TIPS FOR FLOWER PHOTO</li> <li>• TIPS FOR CUISINE PHOTO</li> <li>• TIPS FOR FRAMING</li> </ul>	—

\*1 Monitor frame rate slows.

\*2 For reference only. The items listed do not correspond directly to parameters that can be adjusted in other shooting modes.

- 1 After pressing  to display the live guide, use the   buttons on the arrow pad to highlight an item and press  to select.



- 2 Position the cursor using the   buttons on the arrow pad and check the effect or read the description.

- Press the shutter button halfway to select.
- Although the camera exits from preview to live view when [BLUR BACKGROUND] or [EXPRESS MOTIONS] is selected, the selected effect still applies.

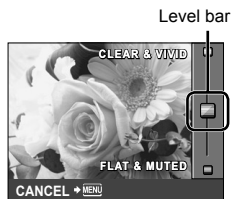

### 3 Shoot.

- Press the shutter button to shoot.
- To clear the live guide from the display, press the **MENU** button.

#### **Caution**

- Selecting RAW in the live guide sets the record mode to N+RAW.
- Live guide settings are not applied to the RAW copy.
- Pictures may appear grainy at some live guide setting levels.
- Changes to live guide setting levels may not be visible in the monitor.
- The flash can not be used with the live guide.
- Changes to live guide options cancel previous changes.
- Choosing live guide settings that exceed the limits of the camera exposure meters may result in pictures that are over- or under-exposed.

# Using live control

Using live control allows you to preview the effects of different settings in the monitor.



## ■ Settings that can be modified using live control

Picture mode <sup>1</sup> .....	P. 52	Record mode .....	P. 31
Scene mode <sup>2</sup> .....	P. 17	Flash mode <sup>1,2</sup> .....	P. 54
Art filter mode <sup>2</sup> .....	P. 16	Flash intensity control <sup>1,2</sup> .....	P. 55
☞ mode <sup>3</sup> .....	P. 56	Metering mode <sup>1,2</sup> .....	P. 47
White balance .....	P. 41	AF mode .....	P. 44
Sequential shooting/self-timer .....	P. 30	Face detection <sup>1,2</sup> .....	P. 32
Image stabilizer .....	P. 50	Movie sound record <sup>3</sup> .....	P. 57
Aspect ratio <sup>1,2</sup> .....	P. 32	ISO sensitivity .....	P. 41

\*1 **P**, **A**, **S**, **M** and **▶AUTO** modes only.

\*2 **ART** and **SCN** only.

\*3 ☞ mode only.

**1** Press to display the live control.

- To hide the live control, press again.

**2** Use the buttons on the arrow pad to select settings, use to change the selected setting, and press .

- The selected settings take effect automatically if no operations are performed for about 8 seconds.

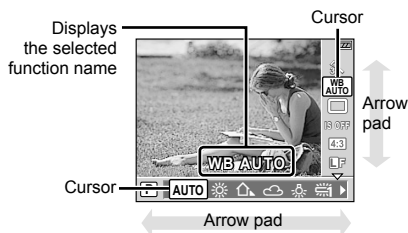

### **Caution**

- Some items are not available in some shooting modes.

### **Tips**

- For information on displaying or hiding the live control: "CAMERA CONTROL SETTING" (P. 74)

# Using the menus

- 1 Press the **MENU** button to display the menus.

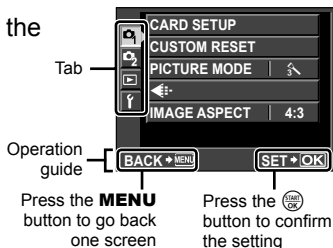

- 2 Use  $\Delta$   $\nabla$  to select a tab and press **START/OK**.
- 3 Select an item using  $\Delta$   $\nabla$  and press **START/OK** to display options for the selected item.

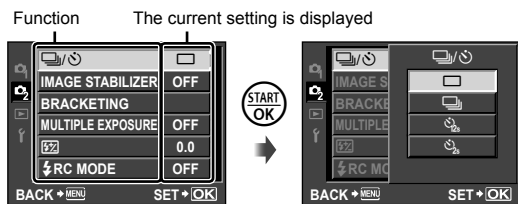

- 4 Press the **START/OK** button to confirm the setting.
  - Press the **MENU** button repeatedly to exit the menu.

## Notes

- For details on the functions that can be set with the menu, refer to “Menu directory” (P. 106).

## Tips

- Camera settings can be customized to your shooting style: “Customizing camera settings” (P. 71)

The settings on the Custom Menu are for customizing the camera to suit your personal preferences or needs. They are not suited to frequent changing. The initial menu is more than adequate for setting both simple and advanced shooting functions. Normally, there is no need to display the Custom Menu.

# Information displayed in the monitor

## Shooting

You can switch the monitor display using the **INFO** button.

☞ “Switching the information display” (P. 33)

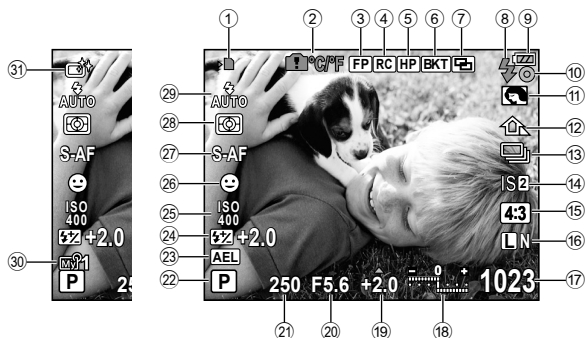

- |   |   |
|---|---|
| ① Card write indicator ..... P. 4   | ⑮ Aspect ratio ..... P. 32                            |
| ② Internal temperature warning<br>☞ °C/F ..... P. 92                                    | ⑯ Record mode..... P. 31                              |
| ③ Super FP flash <b>FP</b> ..... P. 103   | ⑰ Number of storable still pictures<br>..... P. 105   |
| ④ RC mode..... P. 103   | Available recording time                              |
| ⑤ Home position <b>HP</b> ..... P. 45   | ⑱ Top: Flash intensity<br>control ..... P. 55         |
| ⑥ Auto bracket <b>BKT</b> ..... P. 48   | Bottom: Exposure compensation<br>indicator..... P. 40 |
| ⑦ Multiple exposure <b>ME</b> ..... P. 51   | ⑲ Exposure compensation value... P. 40                |
| ⑧ Flash ..... P. 54<br>(blinks: charging in progress,<br>lights up: charging completed) | ⑳ Aperture value..... P. 36–39                        |
| ⑨ Battery check   | ㉑ Shutter speed..... P. 36–39                         |
| ☑ Lit up (green) (ready for use)  | ㉒ Shooting mode..... P. 10, 36–39                     |
| ☑ Lit up (green) (Battery is<br>running low)  | ㉓ AE Lock <b>AEL</b> ..... P. 47                      |
| ☑ Blinks (red) (charging required)  | ㉔ Flash intensity control ..... P. 55                 |
| ⑩ AF confirmation mark..... P. 12, 46   | ㉕ ISO sensitivity ..... P. 41                         |
| ⑪ Art filter..... P. 16   | ㉖ Face detection <b>FD</b> ..... P. 32, 74            |
| Scene mode..... P. 17   | ㉗ AF mode..... P. 44                                  |
| Picture mode ..... P. 52  | ㉘ Metering mode ..... P. 47                           |
| ⑫ White balance ..... P. 41   | ㉙ Flash mode ..... P. 54                              |
| ⑬ Sequential shooting/self-timer.... P. 30  | ⑳ My Mode ..... P. 73                                 |
| ⑭ Image stabilizer <b>IS1</b> <b>IS2</b> <b>IS3</b> ..... P. 50                         | ㉑ Picture mode..... P. 52                             |

## Playback

You can switch the monitor display using the **INFO** button.

 “Information display” (P. 61)

Simplified display

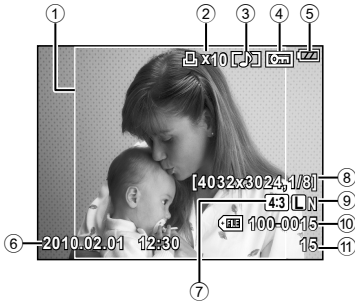

Overall display

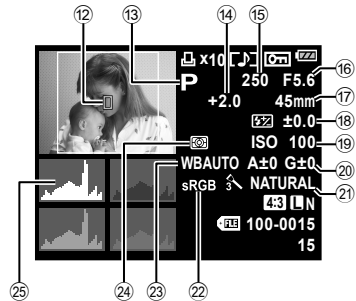

- ① Aspect border ..... P. 32
- ② Print reservation  
Number of prints..... P. 82
- ③ Sound record ..... P. 65
- ④ Protect..... P. 65
- ⑤ Battery check ..... P. 6
- ⑥ Date and time..... P. 7
- ⑦ Aspect ratio ..... P. 32, 63
- ⑧ Pixel count, compression rate .... P. 31
- ⑨ Record mode..... P. 31
- ⑩ File number ..... P. 82
- ⑪ Frame number..... P. 82
- ⑫ AF target ..... P. 45
- ⑬ Shooting mode ..... P. 10, 36–39

- ⑭ Exposure compensation ..... P. 40
- ⑮ Shutter speed..... P. 36–39
- ⑯ Aperture value..... P. 36–39
- ⑰ Focal length ..... P. 97  
(The focal length is displayed in 1 mm units.)
- ⑱ Flash intensity control ..... P. 55
- ⑲ ISO sensitivity ..... P. 41
- ⑳ White balance compensation .... P. 42
- ㉑ Picture mode..... P. 52
- ㉒ Color space..... P. 76
- ㉓ White balance ..... P. 41
- ㉔ Metering mode ..... P. 47
- ㉕ Histogram..... P. 33

# Quick task index

Use this index to quickly find the page describing the task you want to perform or the function you want to know more about.

## Shooting

Taking pictures with automatic settings	▶ iAUTO ( <b>IAUTO</b> )	11
Easy photography with special effects	▶ Art filter ( <b>ART</b> )	16
Easy photography suited to the scene	▶ Scene ( <b>SCN</b> )	17
Focus	▶ Focus lock	46
	▶ AF target	45
Focusing on one area	▶ AF target	45
	▶ MF (manual focus)	44
	▶ Multi view display	33, 40
Checking set effect before taking a picture	▶ Preview function	37
	▶ TEST PICTURE	80
	▶ SLEEP	74
Extending the useful life of the battery	▶ SLEEP	74
Increasing the number of pictures that can be taken	▶ Record mode	31
Taking pictures in low light situations without using the flash	▶ ISO	41
Taking pictures without white subjects appearing too white or black subjects appearing too dark	▶ Histogram	33
	▶ Exposure compensation	40
	▶ SHADOW ADJ	63
	▶ PICTURE MODE	52
Taking monotone pictures	▶ Art filter ( <b>ART</b> )	16
Taking pictures of a subject against backlight	▶ Flash shooting	54
	▶ GRADATION	53
Taking pictures with a blurred background	▶ Live guide	18
	▶ Aperture priority shooting	37
Taking pictures that stop the subject in motion or convey a sense of motion	▶ Live guide	18
	▶ Shutter priority shooting	38
Taking pictures with the correct color	▶ White balance	41
	▶ WB bracketing	49



Taking pictures so that whites come out white and blacks come out black	▶ Live guide	18
	▶ Exposure compensation	40
	▶ HIGH KEY/LOW KEY	53
Reducing image noise (mottling)	▶ NOISE REDUCT.	76
Optimizing the LCD monitor	▶ Monitor brightness adjustment	69
	▶ LIVE VIEW BOOST	74
Reducing camera shake	▶ IMAGE STABILIZER	50
	▶ DIS MODE	17
	▶ ISO	41, 75
	▶ Self-timer	30
Taking pictures while checking the level of the camera	▶ 	33, 74
Choosing an aspect ratio	▶ Aspect ratio	32
Displaying guides to aid composition	▶ Framing grid selection	74

## Playback

Displaying the image after the picture is taken	▶ REC VIEW	69
Checking whether the subject is in focus	▶ Close-up playback	14, 60
Quickly searching for the desired image	▶ Index display/Calendar display	14, 60
Viewing images on a TV	▶ Playback on TV	67
Brightening a dark backlit image	▶ JPEG EDIT	63

## Camera Settings

Saving the settings	▶ CUSTOM RESET	70
	▶ MY MODE SETUP	73, 104
Changing the menu display language	▶ 	69

# Table of Contents

<b>Basic guide</b>	<b>3</b>	<b>Image quality (record mode) .....</b>	<b>31</b>
<b>Preparations for shooting .....</b>	<b>3</b>	Choosing a record mode .....	31
Charging and inserting the battery .....	3	<b>Setting the image aspect .....</b>	<b>32</b>
Inserting and removing cards .....	4	<b>Using face detection .....</b>	<b>32</b>
Attaching a lens to the camera .....	5	Turning [☺ FACE DETECT] on .....	32
Power on .....	6	Taking pictures using face detection .....	32
Setting the date/time .....	7	<b>Switching the information display .....</b>	<b>33</b>
<b>Names of parts and functions .....</b>	<b>8</b>	<b>Display magnification .....</b>	<b>34</b>
Camera .....	8	<b>Panoramas .....</b>	<b>35</b>
Mode dial .....	10	Taking pictures for a panorama .....	35
<b>Basic operations .....</b>	<b>12</b>	<b>Other shooting options and advanced settings</b> <b>36</b>	
Taking photographs/shooting movies .....	12	<b>“Point-and-shoot” photography   (P program mode) .....</b>	<b>36</b>
Playback/Erasing .....	14	<b>Choosing aperture   (A aperture-priority mode) .....</b>	<b>37</b>
Single-frame playback	14	<b>Choosing shutter speed   (S shutter-priority mode) .....</b>	<b>38</b>
Close-up playback		<b>Choosing aperture and shutter   speed (M manual mode) .....</b>	<b>39</b>
Index display		Choosing when the exposure ends (bulb) .....	39
Movie playback	15	<b>Controlling exposure   (exposure compensation) .....</b>	<b>40</b>
Erasing images	15	Previewing the effects of exposure compensation and white balance .....	40
Using art filters .....	16	<b>ISO sensitivity .....</b>	<b>41</b>
Shooting in scene mode .....	17	<b>Adjusting color   (white balance) .....</b>	<b>41</b>
Using the iAUTO mode live guides .....	18	White balance compensation ...	42
Using live control .....	20	One-touch white balance .....	43
Using the menus .....	21		
<b>Information displayed in the   monitor .....</b>	<b>22</b>		
Shooting .....	22		
Playback .....	23		
<b>Quick task index</b>	<b>24</b>		
<b>Basic photography and useful functions</b>	<b>30</b>		
<b>Sequential shooting/   using the self timer .....</b>	<b>30</b>		

<ul style="list-style-type: none"> <li> <ul style="list-style-type: none"> <li>Choosing a focus mode (AF mode).....44</li> <li>Choosing a focus target (AF target).....45               <ul style="list-style-type: none"> <li>Using a saved AF target.....45</li> <li>Focus lock.....46</li> </ul> </li> <li>Zoom frame AF.....46</li> <li>Measuring subject brightness (metering).....47</li> <li>Exposure lock (AE lock).....47</li> <li>Varying settings over a series of photographs (bracketing).....48</li> <li>Reducing camera shake (the image stabilizer).....50</li> <li>Recording multiple exposures in a single image (multiple exposure).....51</li> <li>Processing options (picture mode).....52</li> </ul> </li> </ul>	
<b>Flash shooting</b>	<b>54</b>
<ul style="list-style-type: none"> <li>Using a flash (flash photography).....54</li> <li>Flash intensity control.....55</li> <li>Using external flash units designated for use with this camera.....55</li> <li>Other external flash units.....55</li> </ul>	
<b>Shooting and viewing movies</b>	<b>56</b>
<ul style="list-style-type: none"> <li>Changing the settings for movie recording.....56           <ul style="list-style-type: none"> <li>Adding effects to a movie.....56</li> <li>Record mode.....57</li> <li>Recording sound.....57</li> </ul> </li> <li>Recording movies with the shutter button.....57           <ul style="list-style-type: none"> <li>Taking a photograph when recording ends.....58</li> </ul> </li> </ul>	
<b>Viewing movies</b>	<b>58</b>
<b>Playback options</b>	<b>59</b>
<ul style="list-style-type: none"> <li>Single-frame playback.....59</li> <li>Close-up playback.....60</li> <li>Index display/ calendar display.....60</li> <li>Information display.....61</li> <li>Slideshow.....62</li> <li>Editing still images.....63</li> <li>Rotate.....64</li> <li>Image overlay.....64</li> <li>Audio recording.....65</li> <li>Protecting images.....65           <ul style="list-style-type: none"> <li>Protecting selected frames.....66</li> <li>Canceling all protections.....66</li> </ul> </li> <li>Erasing images.....66           <ul style="list-style-type: none"> <li>Erasing selected frames.....66</li> <li>All-frame erase.....66</li> </ul> </li> <li>Playback on TV.....67</li> </ul>	
<b>Camera setup</b>	<b>69</b>
<ul style="list-style-type: none"> <li>Setup Menu.....69           <ul style="list-style-type: none"> <li> (Date/time setting).....69</li> <li> (Changing the display language).....69</li> <li> (Monitor brightness adjustment).....69</li> <li>REC VIEW.....69</li> <li> MENU DISPLAY.....69</li> <li>FIRMWARE.....69</li> </ul> </li> <li>Resetting the camera settings.....70</li> </ul>	

# Table of Contents

Registering [RESET1]/ [RESET2] .....	70
Using reset settings .....	70

## Customizing camera settings 71

### ■ Custom Menu.....71

### ■ Custom Menu options.....72

AF/MF .....	72
AF MODE .....	72
AF AREA .....	72
RESET LENS .....	72
BULB FOCUSING .....	72
FOCUS RING .....	72
MF ASSIST .....	72
[] SET HOME .....	72
BUTTON .....	72
AEL/AFL .....	72
AEL/AFL MEMO .....	72
FUNCTION .....	72
FUNCTION .....	72
MY MODE SETUP .....	73
BUTTON TIMER .....	73
RELEASE .....	73
RLS PRIORITY S .....	73
RLS PRIORITY C .....	73
DISP//PC.....	73
HDMI .....	73
VIDEO OUT .....	73
SLEEP .....	74
LIVE VIEW BOOST .....	74
FACE DETECT .....	74
/INFO SETTING .....	74
CONTROL SETTING .....	74
HISTOGRAM SETTING .....	74
EVF ADJUST .....	74
BACKLIT LCD .....	74
MODE GUIDE .....	74
CLOSEUP MODE .....	74
(Beep sound) .....	75
VOLUME .....	75

USB MODE .....	75
EXP//ISO .....	75
EV STEP .....	75
METERING .....	75
AEL Metering .....	75
ISO .....	75
ISO STEP .....	75
ISO-AUTO SET .....	75
ISO-AUTO .....	75
BULB TIMER .....	75
ANTI-SHOCK [] .....	75
CUSTOM.....	75
X-SYNC. .....	75
SLOW LIMIT .....	75
+ .....	75
-/COLOR/WB.....	76
NOISE REDUCT. .....	76
NOISE FILTER .....	76
WB .....	76
ALL  .....	76
COLOR SPACE .....	76
SHADING COMP. .....	76
SET .....	76
PIXEL COUNT .....	77
RECORD/ERASE .....	77
QUICK ERASE .....	77
RAW+JPEG ERASE .....	77
FILE NAME .....	77
EDIT FILENAME .....	77
PRIORITY SET .....	78
dpi SETTING .....	78
MOVIE .....	78
MODE .....	78
MOVIE+STILL .....	78
MOVIE  .....	78
UTILITY .....	78
PIXEL MAPPING .....	78
EXPOSURE SHIFT .....	78
WARNING LEVEL .....	78

### ■ Using the super control panel.....81

<b>Printing pictures</b>	<b>82</b>	<b>Using your charger abroad</b> .....	<b>96</b>
<b>Print reservation (DPOF)</b> .....	<b>82</b>	<b>Interchangeable lenses</b> .....	<b>97</b>
Creating a print order.....	82	M.ZUIKO DIGITAL	
Resetting the print reservation		interchangeable lenses .....	97
data .....	83	M.ZUIKO DIGITAL lens	
<b>Direct printing (PictBridge)</b> .....	<b>83</b>	specifications.....	98
Connecting the camera to		Four Thirds Adapter.....	99
a printer .....	84	<b>Using electronic view finder</b>	
Easy printing.....	84	<b>(sold separately)</b> .....	<b>100</b>
Custom printing .....	85	<b>Program line diagram</b>	
<b>Connecting the camera to a</b>		<b>(P mode)</b> .....	<b>101</b>
<b>computer</b>	<b>87</b>	<b>Exposure warning display</b> .....	<b>101</b>
<b>Connecting the camera to</b>		<b>Flash synchronization and</b>	
<b>a computer</b> .....	<b>87</b>	<b>shutter speed</b> .....	<b>102</b>
<b>Installing the supplied</b>		<b>Flash modes that can be set</b>	
<b>computer software (ib)</b> .....	<b>88</b>	<b>by shooting mode</b> .....	<b>102</b>
<b>Shooting tips and</b>		<b>Focal lengths that can be</b>	
<b>maintenance</b>	<b>89</b>	<b>set</b> .....	<b>102</b>
<b>Shooting tips and</b>		<b>External flash shooting</b> .....	<b>103</b>
<b>information</b> .....	<b>89</b>	<b>Wireless remote control</b>	
<b>Error codes</b> .....	<b>91</b>	<b>flash photography</b> .....	<b>103</b>
<b>Cleaning and storing the</b>		<b>Functions that can be</b>	
<b>camera</b> .....	<b>93</b>	<b>registered with My Mode and</b>	
Cleaning the camera .....	93	<b>Custom Reset Setting</b> .....	<b>104</b>
Storage .....	93	<b>Record mode and file size/</b>	
Cleaning and checking		<b>number of storable still</b>	
the image pickup device.....	93	<b>pictures</b> .....	<b>105</b>
Pixel mapping - Checking the		<b>Menu directory</b> .....	<b>106</b>
image processing functions...	94	<b>Specifications</b> .....	<b>109</b>
<b>Information</b>	<b>95</b>	<b>SAFETY PRECAUTIONS</b> .....	<b>111</b>
<b>Card basics</b> .....	<b>95</b>	<b>Index</b> .....	<b>118</b>
Usable cards.....	95		
Formatting the card .....	95		
<b>Battery and charger</b> .....	<b>96</b>		



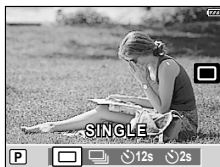

## Sequential shooting/using the self timer

The camera will take photos at a rate of about 3 frames per second (fps) while the shutter button is pressed all the way down. Alternatively, the self-timer can be used for self- or group-portraits or to reduce camera shake when the camera is mounted on a tripod or otherwise fixed in place.

- 1 Press the  button ( $\nabla$ ) to display the direct menu.



- 2 Select an option using  $\triangleleft$  and  $\triangleright$  and press .

 <b>Single-frame shooting</b>	Shoots 1 frame at a time when the shutter button is pressed (normal shooting mode).
 <b>Sequential shooting</b>	Shoots at approximately 3 frames/sec. for as long as the shutter button is pressed (S-AF or MF selected for [AF MODE] (P. 44)).
 <b>Self-timer 12 SEC</b>	Press the shutter button halfway to focus, the rest of the way down to start the timer. First, the self-timer lamp lights up for approximately 10 seconds, then it blinks for approximately 2 seconds and the picture is taken.
 <b>Self-timer 2 SEC</b>	Press the shutter button halfway to focus, the rest of the way down to start the timer. The self-timer lamp blinks for approximately 2 seconds, and then the picture is taken.

### Notes

- To cancel the activated self-timer, press the  button.
- During sequential shooting, focus, exposure, and white balance are locked at the first frame (during S-AF, MF).

### Caution

- During sequential shooting, if the battery check blinks due to low battery, the camera stops shooting and starts saving the pictures you have taken on the card. The camera may not save all of the pictures depending on how much battery power remains.
- Fix the camera securely on a tripod for self-timer shooting.
- If you stand in front of the camera to press the shutter button halfway when using the self-timer, the photograph may be out of focus.

## Image quality (record mode)

Adjust image quality (record mode). Choose a mode according to how the picture will be used: printed, retouched on a computer, displayed on the web, or used for some other purpose. **L**N, a flexible JPEG mode, is recommended in most situations.

### Choosing a record mode

**1** Display the live control (P. 20) and select the record mode item using  $\Delta \nabla$ .

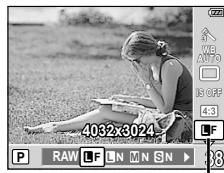

Record mode

**2** Select an option using  $\triangleleft \triangleright$  and press **START/OK**.

- The selected option is displayed in the monitor.

#### Supported record modes

Choose from RAW and four JPEG modes. The four JPEG modes (**L**F, **L**N, **M**N, and **S**N) shown in the table are the options available at camera default settings. Choose a RAW+JPEG option to record both a RAW and a JPEG image with each shot.

#### Image size and recording options

JPEG modes combine image size (**L**, **M**, and **S**) and compression ratio (SF, F, N, and B).

Image size	Compression rate				Pixel count	Application
	SF (Super Fine)	F (Fine)	N (Normal)	B (Basic)		
<b>L</b> (Large)	<b>L</b> SF	<b>L</b> F*	<b>L</b> N*	<b>L</b> B	4032×3024	Select for the print size
<b>M</b> (Middle)	<b>M</b> SF	<b>M</b> F	<b>M</b> N*	<b>M</b> B	3200×2400	
					2560×1920	
					1600×1200	
<b>S</b> (Small)	<b>S</b> SF	<b>S</b> F	<b>S</b> N*	<b>S</b> B	1280×960	
					1024×768	
					640×480	
						For small prints and use on a web site

\* Default.

- You can choose the four JPEG modes available. "◀-SET" (P. 76)
- You can change the dimensions of **M** and **S** images. "PIXEL COUNT" (P. 77)

#### RAW image data

RAW image data are raw data that have yet to be processed to create a photograph. RAW files are generally used when you wish to modify the pictures after shooting or to save the unmodified data for later use. RAW images have the file extension ".ORF" and can not be displayed on cameras made by other manufacturers, viewed in general-purpose software, or selected for printing. The camera can be used to edit RAW data and create JPEG copies. "Editing still images" (P. 63)

## Setting the image aspect

You can change the aspect ratio (horizontal-to-vertical ratio) when taking pictures using live view. Depending on your preference, you can set the aspect ratio to [4:3] (standard), [16:9], [3:2], or [6:6].

- 1 Display the live control (P. 20) and select the aspect ratio item using  $\Delta \nabla$ .
- 2 Use  $\triangleleft \triangleright$  to select an aspect ratio and press  $\text{START OK}$ .

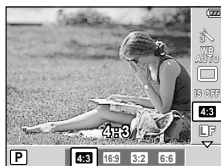

### ! Caution

- JPEG images are cropped to the selected aspect ratio; RAW images, however, are not cropped but are instead saved with information on the selected aspect ratio.
- When RAW images are played back, the selected aspect ratio is shown by a frame.

### 💡 Tips

- For information on cropping existing photographs or changing their aspect ratio, see:  $\text{START OK}$  "Editing still images" (P. 63)

## Using face detection

If [ON] is selected, faces detected when [M] (Digital ESP metering) (P. 47) is chosen for metering or [ALL] (ALL TARGETS) (P. 45) is chosen for AF target selection are indicated by a white frame and used to set exposure and focus.

### Turning [FACE DETECT] on

- 1 Display the live control (P. 20) and select [FACE DETECT] using  $\Delta \nabla$ .
- 2 Use  $\triangleleft \triangleright$  to select [ON] and press  $\text{START OK}$ .



### Taking pictures using face detection

- 1 Frame your subject in the monitor. Faces detected by the camera are indicated by white borders.
- 2 Press the shutter button halfway to focus.
- 3 Press the shutter button the rest of the way down to shoot.









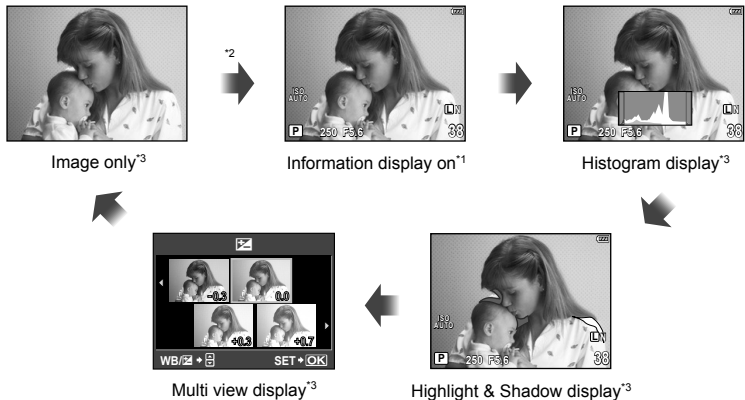

## ! Caution

- During sequential shooting, face detection will work only at the first shot.
- Depending on the subject, the camera may not be able to correctly detect the face.
- If [ [ · ] ] (SINGLE TARGET) is chosen for AF target selection, the camera will focus on the subject in the selected focus target.
- In metering modes other than [  ] (Digital ESP metering), the camera will meter exposure for the selected position.

## Switching the information display

You can switch the information displayed on the monitor by pressing **INFO** button repeatedly.



\*1 With [  /INFO SETTING] (P. 74), you can also select [  ]/[  ]/[  ]/[  ] for the ruled line display.

\*2 During multiple exposure shooting (P. 51), the information display then switches to "Multiple exposure display".

\*3 Can be hidden with [  /INFO SETTING] (P. 74).

## Histograms

Histograms show how pixels of different brightnesses are distributed and are used as a guide to exposure. The horizontal axis shows brightness, the vertical axis the number of pixels of each brightness in the image. Brightnesses that exceed a specified upper limit are shown in red, those under a specified lower limit in blue. The green portion shows the distribution in the spot metering area.

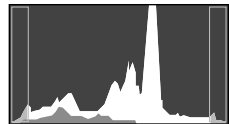

## Display magnification

Press **Q** in the shooting display to display the zoom frame. To exit, press **START/OK**.

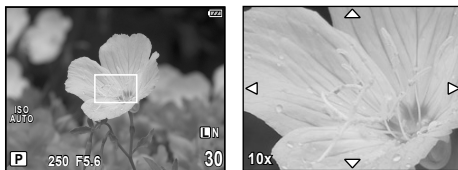

<b>△/▽/◀/▶</b>	Position the zoom frame. To return the zoom frame to the default position, press and hold <b>START/OK</b> .
Press the shutter button halfway	Press the shutter button halfway to override the currently selected focus target and focus on the subject in the zoom frame.
<b>Q</b>	Zoom in. Press <b>Q</b> again to zoom out.
<b>INFO</b>	Display a menu of zoom ratios. Press <b>△/▽</b> to select the zoom ratio (7×/10×/14×). Press <b>START/OK</b> or <b>INFO</b> to exit.

### **!** Caution

- The **Q** button does not zoom the lens in or out. The **Q** button can be used to zoom in on the image displayed in the monitor and check focus when taking photographs, but not for zoom photography. Press **START/OK** to return to shooting mode.

## Panoramas

If you have installed the supplied computer software (ib), you can use it to join pictures together to form a panorama.  "Installing the supplied computer software (ib)" (P. 88)

### Taking pictures for a panorama

**1** Rotate the mode dial to **SCN**.

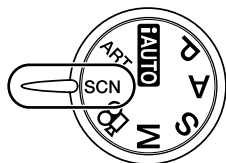

**2** Select [PANORAMA] and press .

**3** Use  $\Delta$   $\nabla$   $\triangleleft$   $\triangleright$  to choose a pan direction.





**4** Take a picture, using the guides to frame the shot.

- Focus, exposure, and other settings are fixed at the values for the first shot.

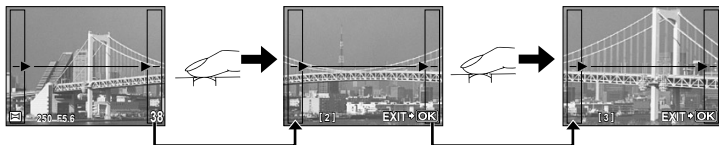
**5** Take the remaining images, framing each shot so that the guides overlap with the previous picture.





- A panorama may include up to 10 images. A warning indicator () is displayed after the tenth shot.

**6** After taking the last shot, press .

#### **Caution**

- During panorama shooting, the image previously taken for position alignment will not be retained. With the frames or other markers for display in the images as a guide, set the composition such that the edges of the overlapping images overlap within the frames.

#### **Notes**

- Pressing the  button before shooting the first frame returns to the scene mode selection menu. Pressing the  button in the midst of shooting ends the sequence of panorama shooting, and allows you to continue with the next one.

## “Point-and-shoot” photography (P program mode)

In mode **P**, the camera automatically adjusts shutter speed and aperture in response to subject brightness.

- 1 Set the mode dial to **P**.

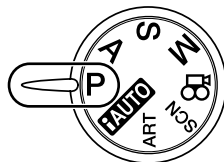

- 2 Take pictures.

- The optimal shutter speed and aperture are displayed in the monitor.

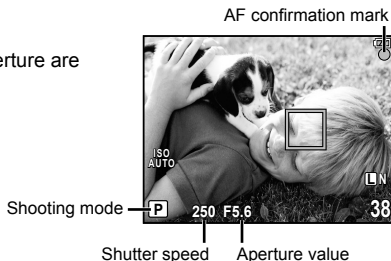

### Program shift (Ps)

In mode **P**, you can choose different combinations of aperture and shutter speed without changing exposure by pressing the  button ( $\Delta$ ) on the arrow pad. This is known as “program shift.” The shooting mode changes to **Ps**. To exit, press  $\Delta \nabla$  until the shooting mode changes from **Ps** to **P** or turn the camera off and then on again.

#### ! Caution

- Program shift is not available when you are using a flash.

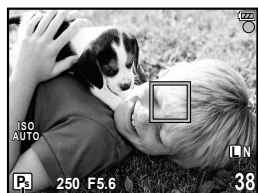

Program shift

#### 💡 Tips

- The shutter speed and aperture displays flash if the camera is unable to achieve optimal exposure. See “Exposure warning display” (P. 101).

## Choosing aperture (A aperture-priority mode)

In mode **A**, you choose the aperture and let the camera automatically adjust shutter speed for optimal exposure.

**1** Rotate the mode dial to **A**.

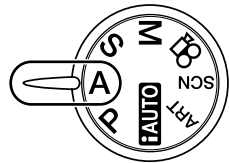

**2** After pressing the  button ( $\Delta$ ), use  $\Delta$ / $\nabla$  to choose the aperture.



Aperture value

**3** Take pictures.





- Larger apertures (lower f-numbers) decrease depth of field (the area in front of or behind the focus point that appears to be in focus), softening background details. Smaller apertures (higher f-numbers) increase depth of field.

When the aperture value (f-number) is decreased



When the aperture value (f-number) is increased

### Preview function

If [PREVIEW] (P. 80) is assigned to the **Fn** or  (movie) button, pressing the **Fn** or  (movie) button stops aperture down to the selected value, allowing you to preview depth of field in the monitor.  "Fn" FUNCTION,  "FUNCTION" (P. 80)

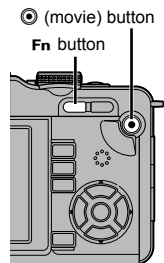

## Choosing shutter speed (S shutter-priority mode)

In mode **S**, you choose the shutter speed and let the camera automatically adjust aperture for optimal exposure.

**1** Rotate the mode dial to **S**.

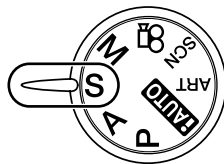

**2** After pressing the  button ( $\Delta$ ), use  $\Delta$   $\nabla$  to choose the shutter speed.



Shutter speed

**3** Take pictures.

- A fast shutter speed can freeze a fast action scene without any blur. A slow shutter speed will blur a fast action scene. This blurring will give the impression of dynamic motion.

Fast shutter speed



Slow shutter speed



## Choosing aperture and shutter speed (M manual mode)

In mode **M**, you choose both the aperture and the shutter speed. At a speed of **BULB**, the shutter remains open while the shutter button is pressed.

- 1 Rotate the mode dial to **M**.
- 2 After pressing the  button ( $\Delta$ ), use  $\triangleleft$ / $\triangleright$  to choose the aperture and  $\Delta$ / $\nabla$  to choose the shutter speed.
  - The range of aperture values available varies with the lens type.
  - The shutter speed can be set to 1/2000–60 sec. or [BULB].
- 3 Take pictures.

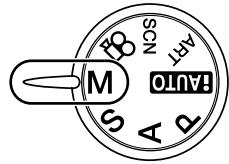

### Noise in images

While shooting at slow shutter speeds, noise may appear on-screen. These phenomena are caused when current is generated in those sections of the image pickup device that are not normally exposed to light, resulting in a rise in temperature in the image pickup device or image pickup device drive circuit. This can also occur when shooting with a high ISO setting in a high-temperature environment. To reduce this noise, the camera activates the noise reduction function.  "NOISE REDUCT." (P. 76)

### Caution



- Exposure compensation is not available in **M** mode.

## Choosing when the exposure ends (bulb)

You can take a picture with a bulb exposure time in which the shutter stays open as long as you hold down the shutter button. Time the end of the exposure to suit the subject. Use for landscapes and fireworks. In **M** mode, set the shutter speed to [BULB].

- [BULB] is displayed on the LCD monitor.

### Tips

- To automatically end bulb shooting after a specified period of time:  "BULB TIMER" (P. 75)
- To fix the focus during manual focus shooting:  "BULB FOCUSING" (P. 72)

### Caution

- For bulb photography, we recommend that you mount the camera on a tripod or rest it on a level, stable surface.
- The following functions are not available during bulb shooting:  
Sequential shooting/self-timer shooting/AE bracket shooting/image stabilizer/flash bracketing

## Controlling exposure (exposure compensation)

Press the  button ( $\Delta$ ) and use  $\triangleleft \triangleright$  to adjust exposure compensation. Choose positive (“+”) values to make pictures brighter, negative (“-”) values to make pictures darker. Exposure can be adjusted by  $\pm 3$  EV.

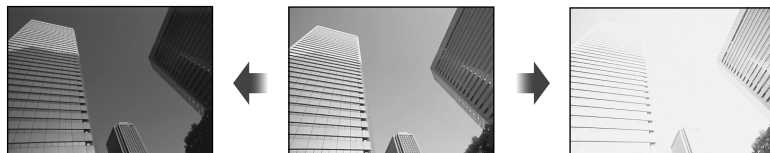

Negative (-)

No compensation (0)

Positive (+)

### **Tips**

- To change the exposure adjustment interval:  “EV STEP” (P. 75)

### **Caution**

- Exposure compensation is not available in **FAUTO**, **M**, or **SCN** modes.
- Changing the default exposure restricts the range of exposure compensation values available.

## Previewing the effects of exposure compensation and white balance

You can check the effects of exposure compensation and white balance on a 4-split screen.

**1** Press the **INFO** button repeatedly to display the multi view display.

 “Switching the information display” (P. 33)

- Use  $\Delta \nabla$  to switch between exposure compensation and white balance.



**2** Use  $\triangleleft \triangleright$  to select the desired value and press .

- You can take the picture using the set value.

### **Caution**

- This function cannot be used in **FAUTO**, **ART**, **SCN**,  or **M** modes.



## ISO sensitivity

Increasing ISO sensitivity increases noise (graininess) but allows photographs to be taken when lighting is poor. The setting recommended in most situations is [AUTO], which starts at ISO 200 — a value that balances noise and dynamic range — and then adjusts ISO sensitivity according to shooting conditions. Choose ISO 100 when reducing noise is more important than enhancing dynamic range.

- 1 Display the live control (P. 20) and select the ISO sensitivity item using  $\Delta \nabla$ .
- 2 Select an option using  $\triangleleft \triangleright$  and press  $\text{START/OK}$ .
  - The selected option is displayed in the monitor.



<b>AUTO</b>	The sensitivity is set automatically according to the shooting conditions.
<b>100–3200</b>	Sensitivity is set to the selected value.

### Tips

- The default value and upper limit for auto ISO sensitivity can be selected using [ISO-AUTO SET] (P. 75).
- The options available for ISO sensitivity can be selected using [ISO STEP] (P. 75).
- Auto sensitivity can be enabled in **M** mode using [ISO-AUTO] (P. 75).

## Adjusting color (white balance)

White balance (WB) ensures that white objects in images recorded by the camera appear white. [AUTO] is suitable in most circumstances, but other values can be selected according to the light source when [AUTO] fails to produce the desired results or you wish to introduce a deliberate color cast into your images.

- 1 Display the live control (P. 20) and select the white balance item using  $\Delta \nabla$ .
- 2 Select an option using  $\triangleleft \triangleright$  and press  $\text{START/OK}$ .
  - The selected option is displayed in the monitor.



WB mode		Color temperature	Light conditions
<b>Auto white balance</b>	<b>AUTO</b>	—	Used for most light conditions (when there is a white portion framed on the LCD monitor). Use this mode for general use.
<b>Preset white balance</b>		5300K	For shooting outdoors on a clear day, or to capture the reds in a sunset or the colors in a fireworks display
		7500K	For shooting outdoors in the shadows on a clear day
		6000K	For shooting outdoors on a cloudy day
		3000K	For shooting under a tungsten light
		4000K	For shooting under white fluorescent lighting
		4500K	For shooting under a neutral white fluorescent lamp
		6600K	For shooting under a daylight fluorescent lamp
		5500K	For flash shooting
<b>One-touch white balance</b> (P. 43)		Color temperature set by one-touch WB.	Choose when a white or gray subject can be used to measure white balance and the subject is under mixed lighting or lit by an unknown type of flash or other light source.
<b>Custom white balance</b>	<b>CWB</b>	2000K – 14000K	After pressing the <b>INFO</b> button, use   buttons to select a color temperature and then press

### White balance color temperature

As their temperature increases, objects first start to shine red and then to shine blue as the temperature rises further. Color temperature expresses the color of light in this way using absolute temperatures in degrees K (kelvin).

- Fluorescent light sources indicated by white dots in the accompanying figure have colors that differ slightly from those on the color temperature scale; the values shown in the figure have been converted to color temperatures for illustrative purposes.

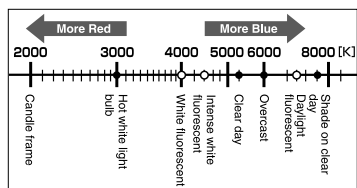

### White balance compensation

This function lets you make fine changes to the auto WB and preset WB settings.

- Select [WB] in Custom Menu (P. 71) tab .
- Select the option to be modified and press .
- Select a slider with and use to choose the amount.

### Adjusting the white balance in the A direction (Amber-Blue)

Depending on the original WB conditions, the image will become more amber when adjusted toward +, and bluer when adjusted toward –.

### Adjusting the white balance in the G direction (Green-Magenta)

Depending on the original WB conditions, the image will become greener when adjusted toward +, and magenta when adjusted toward –.

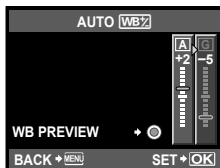

- Choose from values between –7 and +7.



## 4 Press to save settings and exit.



### Tips

- After setting the compensation value, point the camera at the subject to take test shots. When the  (movie) button is pressed, sample images that have been taken with the current WB settings are displayed.
- Adjusting all WB mode settings at once:  “ALL **WB7**” (P. 76)

## One-touch white balance

Measure white balance by framing a piece of paper or other white object under the lighting that will be used in the final photograph. This is useful when shooting a subject under natural light, as well as under various light sources with different color temperatures.

### 1 After selecting [ (One-touch white balance)] (P. 42) , press the **INFO** button.

### 2 Frame a white object in the display.

- Frame the object so that it fills the display and no shadows fall it.

### 3 Press the shutter button all the way down.

- The one-touch white balance screen appears.

### 4 Select [YES] and press the button.

- The new value is saved as a preset white balance option.
- The new value is stored until one-touch white balance is measured again. Turning the power off does not erase the data.



### Tips

- If the subject is too bright or too dark or visibly tinted, the message “WB NG RETRY” will be displayed and no value will be recorded. Correct the problem and repeat the process from Step 1.
- Paper that is a neutral gray color rather than white can also be used.

## Choosing a focus mode (AF mode)

Select a focusing method (focus mode).

**1** Display the live control (P. 20) and select the AF mode item using  $\Delta$   $\nabla$ .

**2** Select an option with  $\triangleleft$   $\triangleright$  and press the  button.

- The selected AF mode is displayed on the LCD monitor.

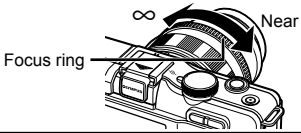

<b>S-AF</b> (single AF)	<p>The camera focuses once when the shutter button is pressed halfway. When the focus is locked, a beep sounds, and the AF confirmation mark and the AF target mark light up. This mode is suitable for taking pictures of still subjects or subjects with limited movement.</p>
<b>C-AF</b> (continuous AF)	<p>The camera repeats focusing while the shutter button remains pressed halfway. When the subject is in focus, the AF confirmation mark lights up on the LCD monitor and the beep sounds when the focus is locked at the first and second time. Even if the subject moves or you change the composition of the picture, the camera continues trying to focus.</p> <ul style="list-style-type: none"> <li>The AF target does not light up, even when the subject is in focus.</li> <li>Four Thirds system lenses focus using S-AF.</li> </ul>
<b>MF</b> (manual focus)	<p>This function allows you to manually focus on any subject.</p> 
<b>S-AF+MF</b> (Simultaneous use of S-AF mode and MF mode)	<p>After pressing the shutter button halfway to focus in S-AF mode, you can turn the focus ring to fine-adjust focus manually.</p>
<b>C-AF+TR</b> (AF Tracking)	<p>Press the shutter button halfway to focus; the camera then tracks and maintains focus on the current subject while the shutter button is held in this position.</p> <ul style="list-style-type: none"> <li>The AF target is displayed in red if the camera can no longer track the subject. Release the shutter button and then frame the subject again and press the shutter button halfway.</li> <li>Instances in which focus tracking is not available are listed below. S-AF will be used instead.</li> </ul> <p>Four Thirds system lenses</p>

### Tips

- The [RLS PRIORITY S] (P. 73) and [RLS PRIORITY C] (P. 73) options can be used to choose whether the shutter can be released when the camera is unable to focus.
- [MF ASSIST] (P. 72) can be used to enable automatic zoom display when the lens focus ring is rotated.
- [FOCUS RING] (P. 72) allows you to change the rotational direction of the focus ring.

Download from [Www.Somanuals.com](http://Www.Somanuals.com). All Manuals Search And Download.

## Choosing a focus target (AF target)

This camera has 11 AF targets for focusing on the subject with auto focus. [AF AREA] options allows you to select the AF target according to the subject or the composition.

- 1 Press the **[•••]** button (◀) to display options.
- 2 Select an AF target with ◀▶ and press the **START/OK** button.

### If all targets are surrounded by a green frame ([••••]) ALL TARGETS

- The camera automatically selects from the 11 focus targets.

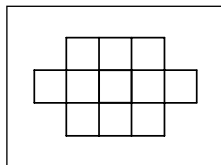

### If one target is surrounded by a green frame ([•]) SINGLE TARGET

- The camera will focus on the subject in the selected focus target.

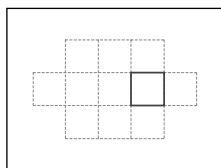

## Using a saved AF target

- 1 Assign **[•••] HOME** to the **Fn** or **⦿** (movie) button.
    - 👉 “**[•••] HOME**” (P. 80)
  - 2 Choose the AF target that will be used as the home position.
    - The home position is saved when the button is pressed. 👉 “**[•••] SET HOME**” (P. 72)
  - 3 During shooting, press the **Fn** or **⦿** (movie) button.
    - The camera will focus on the subject in the saved AF target.
- ! Caution**
- The menus can be used to select the AF target but not to store the home position.

## Focus lock

Focus lock is suitable when selecting a composition where the subject is outside of the AF targets or when shooting a subject which is difficult to focus on with auto focus.

- 1** Position the AF target over your subject and press the shutter button halfway.
  - Make sure that the AF confirmation mark is lighting up.
- 2** While pressing the shutter button halfway, change the composition as necessary.
  - While pressing the shutter button halfway, the focus is locked.
  - Do not change the distance between the camera and the subject while pressing the shutter button halfway.
- 3** Press the shutter button all the way to take a picture.

### **Caution**

- If the contrast of the subject is weak, such as when the lighting is insufficient or the subject cannot be seen clearly because of fog, the focus may not be achieved.

## Zoom frame AF

Pressing the **Q** button displays a zoom frame; to focus on the area shown by the zoom frame, press the shutter button halfway.

- 1** Press **Q**.
  - The zoom frame will be displayed. Use  $\Delta \nabla \triangleleft \triangleright$  to position the zoom frame.
  - Press **INFO** and use  $\Delta \nabla$  to choose the zoom ratio.
- 2** Press the shutter button halfway to initiate autofocus.
- 3** Press **Q** again to zoom in on the selected area.
  - Press **Q** to toggle between the zoom frame and zoom displays. The photograph can be taken at any time.
  - Press  to exit.







## Measuring subject brightness (metering)

Choose how the camera meters subject brightness.

- 1 Display the live control (P. 20) and select the metering item using  $\Delta \nabla$ .

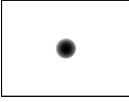

- 2 Select an option with  $\triangleleft \triangleright$  and press  $\text{START/OK}$ .

 <b>Digital ESP metering</b>	The camera meters exposure in 324 areas of the frame and optimizes exposure for the current scene or (if face detection is on) portrait subject. This mode is recommended for general use.	
 <b>Center weighted averaging metering</b>	This metering mode provides the average metering between the subject and the background lighting, placing more weight on the subject at the center.	
 <b>Spot metering</b>	Choose this option to meter a small area (about 2% of the frame) with the camera pointed at the object you wish to meter. Exposure will be adjusted according to the brightness at the metered point.	
 <b>Spot metering - highlight control</b>	Increases spot metering exposure. Ensures bright subjects appear bright.	
 <b>Spot metering - shadow control</b>	Lowers spot metering exposure. Ensures dark subjects appear dark.	

- 3 Press the shutter button halfway.

- Normally, the camera will start metering when the shutter button is pressed halfway and lock exposure while the shutter button is held in this position.

## Exposure lock (AE lock)

If AEL/AFL is assigned to the **Fn** or  $\text{MOVIE}$  (movie) button, the button in question can be used to lock exposure at the metered value (AE lock). Use when you want to set exposure using a composition different from that which will be used in the final photograph. Normally, the shutter button is pressed halfway to lock both focus (AF) and exposure (AE); to lock exposure and not focus, press the **Fn** or  $\text{MOVIE}$  button.

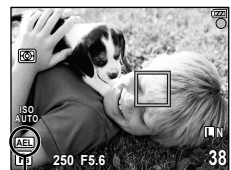



AE lock

Pressing the **Fn** or  $\text{MOVIE}$  (movie) button locks exposure at the value metered for the current subject. While the button is pressed, exposure will remain locked, and photographs can be taken by pressing the shutter button.

- To end AE lock, release the **Fn** or  $\text{MOVIE}$  (movie) button.

## Tips

- To lock the exposure:  "AEL/AFL MEMO" (P. 72)
- To activate AE lock with a set metering mode:  "AEL Metering" (P. 75)

## Varying settings over a series of photographs (bracketing)

The camera automatically varies exposure, white balance, flash level, or sensitivity over a series of exposures, "bracketing" the current setting. Bracketing is available in **P**, **A**, **S**, and **M** modes.

- 1 Select [BRACKETING] in shooting menu  (P. 106).

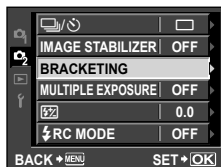

- 2 Choose a bracketing type.
  - **BKT** is displayed in the monitor.

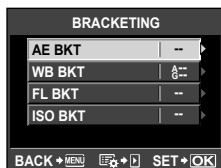

### AE BKT (AE bracketing)

The camera varies exposure by 0.3EV, 0.7EV, or 1.0EV over three shots (no modification on the first shot, negative on the second, and positive on the third). In single-frame shooting, one shot is taken each time the shutter button is pressed; in sequential shooting, all shots are taken while the shutter button is pressed.

- The **BKT** indicator turns green during bracketing.
- The camera modifies exposure by varying aperture and shutter speed (mode **P**), shutter speed (modes **A** and **M**), or aperture (mode **S**).
- The camera brackets the value currently selected for exposure compensation.
- The size of the bracketing increment changes with the value selected for [EV STEP] (P. 75).

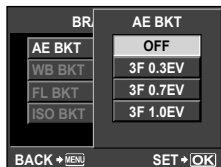



### **WB BKT (WB bracketing)**

Three images with different white balances (adjusted in specified color directions) are automatically created from one shot, starting with the value currently selected for white balance.

- White balance can be varied by 2, 4, or 6 steps on each of the A–B (Amber–Blue) and G–M (Green–Magenta) axes.
- The camera brackets the value currently selected for white balance compensation.
- No pictures will be taken during WB bracketing if there is not enough memory on the card for the selected number of frames.

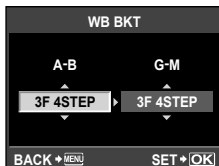

### **FL BKT (FL bracketing)**

The camera varies flash level over three shots (no modification on the first shot, negative on the second, and positive on the third). In single-frame shooting, one shot is taken each time the shutter button is pressed; in sequential shooting, all shots are taken while the shutter button is pressed.

- The **BKT** indicator turns green during bracketing.
- The size of the bracketing increment changes with the value selected for [EV STEP] (P. 75).

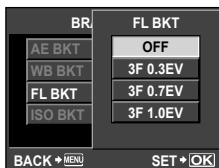

### **ISO BKT (ISO bracketing)**

The camera varies sensitivity by 0.3 EV, 0.7 EV, or 1.0 EV over three shots (no modification on the first shot, negative on the second, and positive on the third), bracketing the current sensitivity setting (or if auto sensitivity is selected, the optimal sensitivity setting) while keeping shutter speed and aperture fixed. In single-frame shooting, one shot is taken each time the shutter button is pressed; in sequential shooting, all shots are taken while the shutter button is pressed.

- The size of the bracketing increment does not change with the value selected for [ISO STEP] (P. 75).
- Bracketing is performed regardless of the upper limit set with [ISO-AUTO SET] (P. 75).

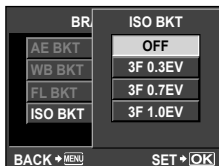

## Reducing camera shake (the image stabilizer)

You can reduce the amount of camera shake that can occur when shooting in low light situations or shooting with high magnification.

- 1 Display the live control (P. 20) and select the image stabilizer item using  $\Delta \nabla$ .



- 2 Select an option with  $\triangleleft \triangleright$  and press  $\text{START OK}$ .

OFF	Image stabilizer is off.
I.S. 1	Image stabilizer is on.
I.S. 2	Image stabilization applies only to vertical ( $\text{I.S. 2}$ ) camera shake. Use when panning the camera horizontally.
I.S. 3	Image stabilization applies only to horizontal ( $\text{I.S. 3}$ ) camera shake. Use when panning the camera horizontally with the camera held in portrait orientation.

### ■ Setting the focal length

Use focal length information to reduce camera shake when shooting with lenses that are not Micro Four Thirds or Four Thirds system lenses.

- 1 Press the **INFO** button when the image stabilizer is turned on.



- 2 Use  $\triangleleft \triangleright$  to choose a focus distance and press  $\text{START OK}$ .
  - Choose a focal length between 8 mm and 1000 mm.  $\text{INFO}$  "Focal lengths that can be set" (P. 102)
  - Choose the value that most closely matches to the one that is printed on the lens.

### ! Caution

- The image stabilizer cannot correct excessive camera shake or camera shake that occurs when the shutter speed is set to the slowest speed. In these cases, it is recommended that you use a tripod.
- When using a tripod, set [IMAGE STABILIZER] to [OFF].
- When using a lens with an image stabilization function, turn off the image stabilizer function of either the lens or the camera.
- If [IMAGE STABILIZER] is set to [I.S. 1], [I.S. 2] or [I.S. 3] and you turn off the camera, the camera will vibrate. This is due to the camera initializing the image stabilizer mechanism. Without this initialization, the image stabilizer may not be able to achieve the proper effect.
- You may notice an operating sound or vibration when the image stabilizer is activated.
- The image stabilizer will not activate at shutter speeds of over 2 seconds.
- If the internal temperature of the camera exceeds the specified temperature, the image stabilizer is deactivated and the image stabilizer icon lights red on the monitor. A blinking icon indicates a malfunction; consult an Olympus Authorized Service Center.

## Recording multiple exposures in a single image (multiple exposure)

A multiple exposure is created by overlaying a series of shots to create a single image. The image is saved with the record mode set at the time the image is saved.



**1** Select [MULTIPLE EXPOSURE] in shooting menu  (P. 106).

**2** Adjust settings.

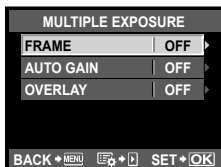
<b>FRAME</b>	Select [2F].
<b>AUTO GAIN</b>	When set to [ON], the brightness of each frame is set to 1/2 and the images are overlaid. When set to [OFF], the images are overlaid with the original brightness of each frame.
<b>OVERLAY</b>	When set to [ON], a RAW image recorded on a card can be overlaid with multiple exposures and stored as a separate image. The number of pictures taken is one.



**3** Take pictures.

- When multiple exposure is set,  is displayed on the LCD monitor.  is displayed in green when shooting starts.
- Press  to delete the last shot.
- The previous shot is superimposed on the view through the lens as a guide to framing the next shot.



### Tips

- To overlay 3 or more frames: To overlay 3 or more frames, save the image as a RAW file and use [OVERLAY] to repeat the multiple exposure shooting.
- For more information on overlaying RAW images:  "Image overlay" (P. 64)

### Caution

- When multiple exposure is set, [SLEEP] is set to [OFF] automatically.
- RAW images taken with another camera cannot be used for the overlay image.
- When [OVERLAY] is set to [ON], the images displayed when a RAW image is selected are developed with the settings at the time of shooting.
- To set the shooting functions, cancel multiple exposure shooting first. Some functions cannot be set.
- Multiple exposure is cancelled automatically from the first picture in the following situations.
  - The camera is turned off/The  button is pressed/The **MENU** button is pressed/
  - The shooting mode is set to a mode other than **P, A, S, M**/The battery power runs out/The USB cable, AV cable and/or HDMI mini-cable is inserted/You switch between the monitor and electronic view finder
- The information for the first frame during multiple exposure shooting is displayed as the shooting information.

- When a RAW image is selected using [OVERLAY], the JPEG image for the image recorded in JPEG+RAW is displayed.
- When shooting multiple exposures using bracketing, priority is given to multiple exposure shooting. While the overlay image is being saved, bracketing is reset to the factory default setting.





## Processing options (picture mode)

You can select image tone to create unique image effects. You can also fine-adjust image parameters such as contrast and sharpness for each mode. The adjusted parameters are recorded in each picture effect mode.

- 1 Select [PICTURE MODE] in shooting menu  (P. 106)



- 2 Select an option with   and press .

 <b>i-ENHANCE</b>	Produces more impressive-looking pictures matched to the scene mode.
 <b>VIVID</b>	Produces vivid colors.
 <b>NATURAL</b>	Produces natural colors.
 <b>MUTED</b>	Produces flat tones.
 <b>PORTRAIT</b>	Produces beautiful skin tones.
<b>MONOTONE</b>	Produces black and white tone.
<b>CUSTOM</b>	Select one picture mode, set the parameters, and register the setting.

### 3 Press $\triangleright$ to display settings for the selected option.

<b>CONTRAST</b>	Distinction between light and dark	✓	✓	✓	✓
<b>SHARPNESS</b>	Sharpness of the image	✓	✓	✓	✓
<b>GRADATION</b>	Adjust tone (gradation).				
<b>AUTO</b>	Divides the image into detailed regions and adjusts the brightness separately for each region. This is effective for images with areas of large contrast in which the whites appear too bright or the blacks appear too dark.	✓	✓	✓	✓
<b>NORMAL</b>	Use [NORMAL] mode for general uses.				
<b>HIGH KEY</b>	Gradation for a bright subject.				
<b>LOW KEY</b>	Gradation for a dark subject.				
<b>SATURATION</b>	Vividness of the color	✓	✓	—	✓
<b>EFFECT (i-ENHANCE)</b>	Sets the extent that the effect will be applied.	✓	—	—	✓
<b>B&amp;W FILTER (MONOTONE)</b>	Creates a black and white image. The filter color is brightened and the complementary color is darkened.				
<b>N:NEUTRAL</b>	Creates a normal black and white image.				
<b>Ye:YELLOW</b>	Reproduces clearly defined white cloud with natural blue sky.	—	—	✓	✓
<b>Or:ORANGE</b>	Slightly emphasizes colors in blue skies and sunsets.				
<b>R:RED</b>	Strongly emphasizes colors in blue skies and brightness of crimson foliage.				
<b>G:GREEN</b>	Strongly emphasizes colors in red lips and green leaves.				
<b>PICT. TONE (MONOTONE)</b>	Colors the black and white image.				
<b>N:NEUTRAL</b>	Creates a normal black and white image.				
<b>S:SEPIA</b>	Sepia	—	—	✓	✓
<b>B:BLUE</b>	Bluish				
<b>P:PURPLE</b>	Purplish				
<b>G:GREEN</b>	Greenish				







#### **Caution**











- Changes to contrast have no effect at settings other than [NORMAL].

# 3 Flash shooting

To raise the built-in flash for use, slide the flash switch. The built-in flash can be used for flash photography in a variety of shooting conditions.

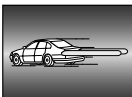
## Using a flash (flash photography)

- 1 Raise the flash.
  - 2 Press the  button () to display the current flash mode.
  - 3 Use   to choose a flash mode and press .
- The options available and the order in which they are displayed vary depending on the shooting mode.  "Flash modes that can be set by shooting mode" (P. 102)



	<b>Auto flash</b>	The flash fires automatically in low light or backlight conditions.
	<b>Fill-in flash</b>	The flash fires regardless of the light conditions.
	<b>Flash off</b>	The flash does not fire.*1
	<b>Red-eye reduction flash</b>	This function allows you to reduce the red-eye phenomenon. In <b>S</b> and <b>M</b> mode, the flash always fires.
	<b>Slow synchronization (1st curtain)</b>	Slow shutter speeds are used to brighten dimly-lit backgrounds.
	<b>Slow synchronization (1st curtain)/Red-eye reduction flash</b>	Combines slow synchronization with red-eye reduction.
	<b>Slow synchronization (2nd curtain)</b>	The flash fires just before the shutter closes to create trails of light behind moving light sources. 
	<b>Manual (FULL)<sup>*2</sup></b>	The flash fires at full power.
	<b>Manual (1/4)<sup>*2</sup></b>	The flash fires at 1/4 power.
	<b>Manual (1/16)<sup>*2</sup></b>	The flash fires at 1/16 power.
	<b>Manual (1/64)<sup>*2</sup></b>	The flash fires at 1/64 power.

\*1 Both the built-in flash and optional external flash units turn off.

\*2 Built-in flash only.

- 4 Press the shutter button all the way.

### **Caution**

- In [ (Red-eye reduction flash)], after the pre-flashes, it takes about 1 second before the shutter is released. Hold the camera firmly to avoid camera shake.
- [ (Red-eye reduction flash)] may not work effectively under some shooting conditions.
- When the flash fires, the shutter speed is set to 1/160 sec. or slower. When shooting a subject against a bright background with the fill-in flash, the background may be overexposed.

## Flash intensity control

The flash intensity can be adjusted between [+3] and [-3]. It is useful to adjust the exposure balance between the subject and the background when the subject is small or far from the background. It is also useful when you intend to increase the contrast (distinction between light and dark) of images to make the images more vivid.

**1** Display the live control (P. 20) and select the Flash intensity control item using  $\Delta \nabla$ .

**2** Choose the compensation value with  $\triangleleft \triangleright$  and press the  $\text{START OK}$  button.



### Tips

- For information on flash bracketing:  "FL BKT (FL bracketing)" (P. 49)

### Caution

- This does not work when the flash control mode on the electronic flash is set to MANUAL.
- If flash intensity is adjusted on the electronic flash, it will be combined with the camera's flash intensity setting.
- When  $[\text{FL} + \text{X}]$  is set to [ON], the flash intensity value will be added to the exposure compensation value.  " $[\text{FL} + \text{X}]$ " (P. 75)

## Using external flash units designated for use with this camera

Optional external flash units designated for use with this camera support a wide variety of options for flash photography, including automatic flash control, super FP, and wireless flash control (P. 103).

## Other external flash units

Observe the following precautions when mounting an external flash unit not designated for use with this camera on the camera hot shoe:

- Using obsolete flash units that apply currents of more than about 5V to the camera hot shoe X-contact will damage the camera.
- Connecting flash units with signal contacts that do not conform to Olympus specifications may damage the camera.
- Use only with the camera in shooting mode **M** at shutter speeds slower than 1/160s and at ISO settings other than [AUTO].
- Flash control can only be performed by manually setting the flash to the ISO sensitivity and aperture values selected with the camera. Flash brightness can be adjusted by adjusting either ISO sensitivity or aperture.
- Use a flash with an angle of illumination suited to the lens. Angle of illumination is usually expressed using 35-mm format equivalent focal lengths.

# 4 Shooting and viewing movies

Use the  (movie) button to record High Definition (HD) movies with sound.

 “Taking photographs/shooting movies” (P. 12)



In movie mode, you can create movies that take advantage of the effects available in modes **A** and **M**. You can also customize camera settings to allow the shutter button to be used to record movies (P. 80).

## Caution

- When recording a movie, you cannot change the settings for exposure compensation and aperture value, and shutter speed.
- If [IMAGE STABILIZER] is activated while recording a movie, the recorded image is enlarged slightly. Even if [I.S. 2] or [I.S. 3] is selected, the setting for [I.S. 1] is applied.
- Stabilization is not possible when the camera shake is excessive.
- When using a lens with the image stabilizer function, turn off the image stabilizer function of either the lens or the camera.
- You cannot use [ FACE DETECT] in movie mode.
- The size of each movie file is limited to 2GB. With some types of media, shooting may be interrupted unexpectedly before reaching the end of available recording time.
- When the inside of the camera becomes hot, shooting is automatically stopped to protect the camera.
- Shooting can not be resumed while the camera displays a message stating that recording is in progress.
- With some art filters, [C-AF] operation is limited.
- It is recommended to use a SD speed class 6 compatible card for movie shooting.





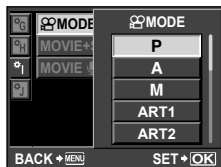

## Changing the settings for movie recording

### Adding effects to a movie

- 1 Select [ MODE] in  Custom Menu (P. 71) tab .



- 2 Select an option and press the  button.

<b>P</b>	Optimal aperture is set automatically according to the brightness of the subject.
<b>A</b>	Depiction of background is changed by setting the aperture. Use   to set aperture.
<b>M</b>	You control both aperture and shutter speed. Use   to choose the aperture,   to select the shutter speed from values between 1/60 s and 1/2000 s. Sensitivity can be set manually to values between ISO 200 and 1600; auto ISO sensitivity control is not available.
<b>ART1– ART6</b>	Movie can be recorded with effects of art filter mode.  “Using art filters” (P. 16)



## ! Caution

- The camera may not correctly display the recording time in art filter mode. Movies recorded in [ART5] (DIORAMA) mode play back at high speed; during recording, the recording time is adjusted to reflect the playback time and advances more slowly than usual.



## Record mode

- 1 Display the live control (P. 20) and select the record mode item using  $\Delta \nabla$ .
- 2 Select a movie record mode using  $\triangleleft \triangleright$  and press the  button.



HD	The number of pixels is 1280 × 720. You can record high-definition movies.
SD	The number of pixels is 640 × 480.

## Recording sound

- 1 Display the live control (P. 20) and select [MOVIE \Delta \nabla.
- 2 Switch ON/OFF using  $\triangleleft \triangleright$  and press the  button.

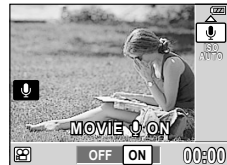

## ! Caution

- When recording sound in a movie, the sound made by the lens and camera operating may be recorded. If desired, you can reduce these sounds by shooting with [AF MODE] set to [S-AF], or by limiting the amount of times you press the buttons.
- No sound is recorded in [ART5] (DIORAMA) mode.

## Recording movies with the shutter button

If movie recording has not been assigned to the **Fn** or  (movie) button, you can record movies using the shutter button.

- 1 Set the mode dial to .
- 2 Press the shutter button halfway down and focus on what you wish record.
  - When the subject is in focus, the AF confirmation mark lights up.



**3** Press the shutter button all the way to begin recording.

- **REC** lights up while both movie and sound are recorded simultaneously.

**4** Press the shutter button all the way to end recording.



Lights up in red during recording

Total recording time

**Tips**

- Recording silent movies: "Recording sound" (P. 57)

## Taking a photograph when recording ends

Select [ON] for [MOVIE+STILL] to take a still picture when movie recording is finished. This feature is useful when you want to record a still picture as well as the movie.

**1** Select [MOVIE+STILL] in Custom Menu (P. 71) tab .

**2** Select [ON] and press the button.



**Caution**

- This option is only available when the shutter button is used to record movies.

## Viewing movies

**1** Display a movie in single-frame playback and press the button.

**2** Select [MOVIE PLAY] using and press the button to begin playback.

- The following operations can be performed during movie playback:

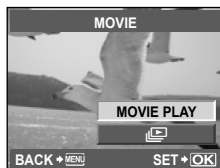



	<p>Pause or resume playback.</p> <ul style="list-style-type: none"> <li>- While playback is paused, press  to display the first frame and press  to display the last frame. Press   to rewind or advance one frame. Press and hold the button to rewind or advance in succession.</li> </ul>	
	<p>Advance or rewind a movie.</p>	
	<p>Adjust volume.</p>	

Elapsed time/Total recording time











# 5 Playback options

## Single-frame playback

To view pictures full frame, press the  button in shooting mode.

- To exit to shooting mode, press  again or press the shutter button halfway.

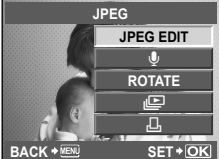

	View other pictures.	
	Erase the current picture (P. 15). • See “Erasing selected frames” (P. 66) for information on erasing multiple selected pictures, “All-frame erase” (P. 66) for information on erasing all pictures.	
	Press the Q button to zoom in on pictures (P. 60).	
	Press the  button to view multiple pictures (P. 60).	
<b>INFO</b>	View information on the current picture (P. 61).	
	Protect the current picture (P. 65).	
	Display a menu of options, including [JPEG EDIT] (P. 63), [RAW DATA EDIT] (P. 63), [MUTE] (P. 65), [ROTATE] (P. 64), [COPY] (P. 62), [IMAGE OVERLAY] (P. 64), [PRINT] (P. 82). The options available vary with the image displayed.	

## Close-up playback

Press the **Q** button to display a zoom frame in single-frame playback.

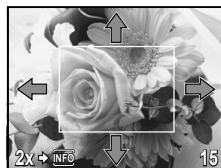

	Position the zoom frame.
	View the portion of the image visible in the zoom frame at the selected zoom ratio. <ul style="list-style-type: none"> <li>Press <b>Δ</b> <b>▽</b> <b>◀</b> <b>▶</b> to scroll to other areas of the image.</li> <li>Press <b>INFO</b> and use <b>Δ</b> <b>▽</b> to zoom in or out.</li> <li>Press <b>Q</b> and use <b>◀</b> <b>▶</b> to view other images at the same zoom ratio.</li> </ul>
	Exit to single-frame playback.

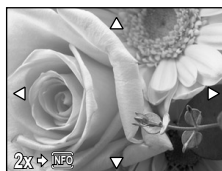

## Index display/calendar display

To view multiple pictures, press the button during single-frame playback.



	Press  to increase the number of images displayed from 4 to 9, 25, or 100. To view the calendar display, press  again when 100 images are displayed. Only items for which [ON] is selected for information settings will be displayed (P. 74).
	Press <b>Q</b> to decrease the number of images displayed from 100 to 25, 9, or 4. To view the current image full frame, press <b>Q</b> again when 4 images are displayed. Only items for which [ON] is selected for information settings will be displayed (P. 74).
	Select a picture.
	Protect the selected picture (P. 65).
	Select the highlighted picture for protection or deletion. Selected pictures are indicated by a  (P. 66).

## ■ Calendar display

With the calendar, you can display images recorded on the card by date. If more than one image was taken on a single date, the image shot first on that date is displayed. Use  $\Delta$   $\nabla$   $\triangleleft$   $\triangleright$  to select a date and press the  $\text{START OK}$  button to play back images for the selected date in single-frame display.



## Information display

This allows you to display detailed information about the image. The information displayed changes each time the **INFO** button is pressed.

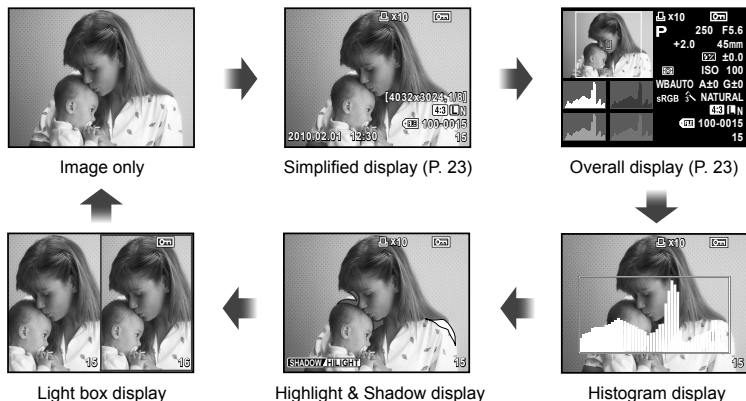

## ■ Histogram display

Display a histogram showing the distribution of brightness in the image.

## ■ Highlight & Shadow display

Overexposed areas (highlights) are shown in red, underexposed areas (shadows) in blue.

## ■ Light box display

- Compare two images side-by-side. Press  $\text{START OK}$  to select the image on the opposite side of the display.
- The current image is shown on the left, the next image on the right at the current playback zoom ratio. Press  $\text{START OK}$  to select the image on the right as the current image and display it on the left.

- Press **Q** to zoom in on the current image.

Use  $\Delta \nabla \langle \rangle$  to scroll current image.

Scroll both images.

Show selected images on opposite sides of the display.



- While the images are zoomed in, press **INFO** and use  $\Delta \nabla$  to change the zoom ratio. Press **INFO** again to exit.



### Tips

- Use **[INFO/SETTING]** to choose the information available for display (P. 74).

## Slideshow

This function displays images stored on the card one after another.

- 1 Press **[START/OK]** during playback and select the slideshow option.

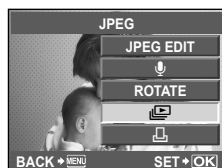

- 2 Adjust settings.

<b>START</b>	Start the slideshow. Images are displayed in order, starting with the current picture.
<b>BGM</b>	Set BGM (3 types) or turn BGM [OFF].
<b>SLIDE</b>	Set type of slideshow to execute.
<b>SLIDE INTERVAL</b>	Choose the length of time each slide is displayed from 2 to 10 seconds.
<b>MOVIE INTERVAL</b>	Select [FULL] to include full-length movie clips in the slide show, [SHORT] to include only the opening portion of each clip.



- 3 Select [START] and press the **[START/OK]** button.

- The slideshow will start.
- Press the **[START/OK]** button to stop the slideshow.

### Volume

Press  $\Delta \nabla$  during the slide show to adjust the overall volume of the camera speaker. Press  $\langle \rangle$  to adjust the balance between the background music and the sound recorded with photographs or movies.

## Tips

- A slideshow option is also available in the playback menu (P. 106).

## Caution

- If the slideshow is left running for about 30 minutes, the camera will turn off automatically.









## Editing still images

Recorded images can be edited and saved as new images.

### 1 Display the image to be edited and press .



- [RAW DATA EDIT] is displayed if the picture is a RAW image, [JPEG EDIT] if it is a JPEG image. If the image was recorded at a setting of [RAW+JPEG], you will be prompted to choose the format you wish to edit.

### 2 Select [RAW DATA EDIT] or [JPEG EDIT] and press .

<b>RAW DATA EDIT</b>	Create a JPEG copy of the RAW image using current camera settings. Adjust camera settings before choosing this option.
<b>JPEG EDIT</b>	Choose from the following options: [SHADOW ADJ]: Brightens a dark backlit subject. [REDEYE FIX]: Reduces the red-eye phenomenon during flash shooting. [  ]: Choose the size of the crop using  or  and use     to position the crop. 
	[ASPECT]: Changes the aspect ratio of images from 4:3 (standard) to [3:2], [16:9], or [6:6]. After changing the aspect ratio, use the arrow pad to specify the trimming position. [BLACK & WHITE]: Creates black and white images. [SEPIA]: Creates sepia-toned images. [SATURATION]: Sets the color depth. Adjust the color saturation checking the picture on the screen. [  ]: Converts the image file size to 1280 × 960, 640 × 480, or 320 × 240. Images with an aspect ratio other than 4:3 (standard) are converted to the closest image file size. [e-PORTRAIT]: Makes skin look smooth and translucent. <ul style="list-style-type: none"><li>• You may not be able to compensate depending on the image if face detection fails.</li></ul>



## Caution

- You cannot edit movies.

- Red-eye correction may not work depending on the image.
- Editing of a JPEG image is not possible in the following cases:  
When an image is recorded in RAW, when an image is processed on a PC, when there is not enough space in the card memory, when an image is recorded on another camera.
- When resizing ([) an image, you cannot select a larger number of pixels than was originally recorded.
- [) and [ASPECT] can only be used to edit images with an aspect ratio of 4:3 (standard).

## Rotate

Choose whether to rotate photographs.



- 1 Play the photograph back and press .
- 2 Select [ROTATE] and press .
- 3 Press  $\Delta$  to rotate the image counterclockwise,  $\nabla$  to rotate it clockwise. The image rotates each time either button is pressed.
  - Press  to save settings and exit.

### ! Caution

- The rotated image is saved in its current orientation.
- Movies and protected images can not be rotated.

## Image overlay

Up to 3 frames of RAW images taken with the camera can be overlaid and saved as a separate image. The image is saved with the record mode set at the time the image is saved.

- 1 With a RAW image displayed during playback, press  and select [IMAGE OVERLAY].
- 2 Select the number of images in the overlay and press .
- 3 Use  $\Delta$   $\nabla$   $\triangleleft$   $\triangleright$  to select the RAW images that will be used in the overlay and press  to select.
- 4 When you have selected the number of images specified in Step 2, the overlay will be displayed.
- 5 Adjust gain.
  - Use  $\triangleleft$   $\triangleright$  to select an image and use  $\Delta$   $\nabla$  to adjust gain.

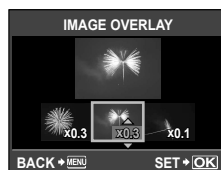



- Gain can be adjusted in the range 0.1–2.0. Check the results in the monitor.

**6** Press . A confirmation dialog will be displayed; select [YES] and press .

### Tips

- To overlay 4 or more frames, save the overlay image as a RAW file and use [IMAGE OVERLAY] repeatedly.

### Caution

- When the record mode is set to [RAW], the overlay image is saved as [L]N+RAW].

## Audio recording

Add an audio recording (up to 30 sec. long) to the current photograph.

**1** Display the image to which you want to add an audio recording and press .

**2** Select and press .

- To exit without adding a recording, select [NO].

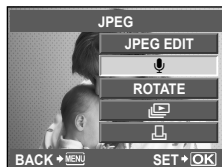

**3** Select START] and press to begin recording.

- To stop recording part-way through, press the button.

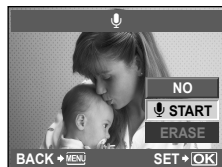

**4** Press to end recording.

- Images with audio recordings are indicated by a icon.
- To delete a recording, select [ERASE] in Step 2.

### Caution

- You cannot record sound for protected images.

### Notes

- Audio recording can also be accessed from the playback menu.

## Protecting images

Protect important images from deletion. Protected images can not be deleted in single-frame playback and are not deleted when all frames are erased. To protect the current picture in single-frame or index playback, press the button.

- Protected images are indicated by a icon.



- Press the **LOCK** button again to remove protection.

### **!** Caution

- Formatting the card erases all images even if they have been protected.

## Protecting selected frames

During index display you can select multiple images and protect them all at the same time.

- 1 In the index display, select an image you want to protect using  $\Delta \nabla \triangleleft \triangleright$  and press



- Selected images are shown by a **✓**.
- To cancel your selection, press the button again.



- 2 Press the **LOCK** button.

## Canceling all protections

This function lets you cancel the protection of several images at one time.

- 1 Select [RESET PROTECT] in the (playback) menu (P. 106).

- 2 Select [YES] and press .

## Erasing images

### Erasing selected frames

Erase multiple selected frames.

- 1 In the index display, select an image you want to protect using  $\Delta \nabla \triangleleft \triangleright$  and press



- Selected images are shown by a **✓**.
- To cancel your selection, press the button again.

- 2 Press the button.

- 3 Select [YES] and press .

- The selected images will be erased.



### All-frame erase

Erase all images on the memory card.

- 1 Select [CARD SETUP] in shooting menu (P. 106).

- 2 Select [ALL ERASE] and press .

- 3 Select [YES] and press .

- All frames will be erased.

## Playback on TV

Use the AV cable provided with the camera to playback recorded images on your TV. You can playback high-definition images on a high-definition TV by connecting it to the camera using a commercially available HDMI mini-cable.

### ■ Connection via AV cable

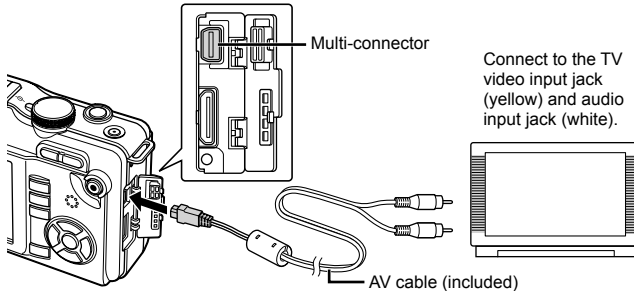

- 1 Connect the TV and camera.
- 2 Use the camera to select the video signal format that matches that of the connected TV ([NTSC]/[PAL]).
  - "VIDEO OUT" (P. 73)
- 3 Turn on the TV, and change "INPUT" to "VIDEO" (an input jack connected to the camera).

### ! Caution

- The camera's monitor turns off automatically when the AV cable is connected to the camera.
- Press the button when connecting via an AV cable.
- For details on changing the input source of the TV, refer to the TV's instruction manual.
- Depending on the TV's settings, the displayed images and information may become cropped.

### ■ Connection via HDMI mini-cable

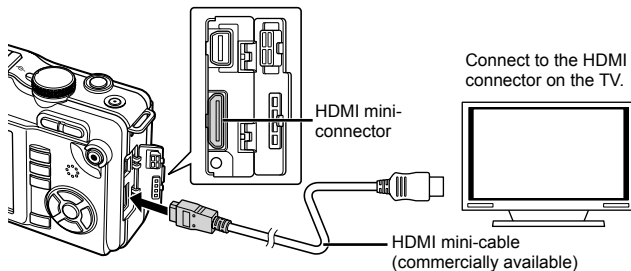



- 1 Connect the HDMI mini-cable to the HDMI connector of the TV.
- 2 Connect the HDMI mini-cable to the HDMI connector of the camera.
- 3 Turn on the TV and switch "INPUT" to "HDMI INPUT".
- 4 Turn on the camera.

#### **!** Caution

- For details on changing the input source of the TV, refer to the TV's instruction manual.
- Use an HDMI mini-cable that matches the HDMI mini connector on the camera and the HDMI connector on the TV.
- When the camera and TV are connected by both an AV cable and an HDMI mini-cable, HDMI will take priority.
- Depending on the TV's settings, the displayed images and information may become cropped.
- When you connect to a TV via an HDMI mini-cable, you can select the format of the digital video signal.  "HDMI" (P. 73)
- You cannot shoot pictures or movies when the HDMI cable is connected.
- Do not connect the camera to other HDMI output devices. Doing so may damage the camera.
- HDMI output is not performed while connected via USB to a computer or printer.

#### **Using the TV remote control**

The camera can be operated by a TV remote control when connected to a TV that supports HDMI control.

- 1 Select [HDMI] in  Custom Menu (P. 71) tab .
- 2 Select [HDMI CONTROL] and choose [ON].
- 3 Operate the camera by using the TV remote control.
  - You can operate the camera by following the operation guide displayed on the TV.
  - During single-frame playback, you can display or hide the information display by pressing the "Red" button, and display or hide the index display by pressing the "Green" button.
  - Some functions may be unavailable, even if displayed, depending on the TV.

# 6 Camera setup

## Setup Menu

Use the Setup Menu to set the basic camera functions. For details on using the menu lists, see “Using the menus” (P. 21).

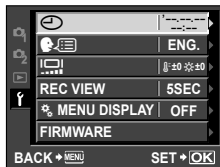



Option	Description	
(Date/ time setting)	Set the camera clock.	P. 7
(Changing the display language)	You can change the language used for the on-screen display and error messages from ENGLISH to another language.	—
(Monitor brightness adjustment)	<p>You can adjust the brightness and color temperature of the monitor. Color temperature adjustment will affect only the LCD monitor display during playback.</p> <p>Use   to switch between  (color temperature) and  (brightness), and use   to adjust the value between [+7]–[-7].</p> <p>For information on adjusting the brightness and color temperature of the electronic view finder, see “EVF ADJUST” (P. 74).</p>	
REC VIEW	<p>Choose whether pictures are displayed immediately after shooting and for how long. This is useful for making a brief check of the picture you have just taken. Pressing the shutter button halfway while checking the picture lets you resume shooting immediately.</p> <p>[1SEC]–[20SEC]: Selects the number of seconds to display each picture. Can be set in units of 1 second.</p> <p>[OFF]: The picture being recorded to the card is not displayed.</p> <p>[AUTO ]: Displays the image being recorded, and then switches to playback mode. This is useful for erasing a picture after checking it.</p>	—
MENU DISPLAY	Choose whether to display the Custom Menu.	P. 71
FIRMWARE	Your product's firmware version will be displayed. When you make inquiries about your camera or accessories or when you want to download software, you will need to state which version of each of the products you are using.	—

## Resetting the camera settings

In **P**, **A**, **S**, or **M** mode, current camera settings (including any changes you have made) are retained when the power is turned off. To reset the camera to the factory default settings, set [RESET]. You can register settings in advance to [RESET1] and [RESET2].





The camera settings at that time are registered in [RESET1] and [RESET2]. For details on the registered functions, refer to “Functions that can be registered with My Mode and Custom Reset Setting” (P. 104).

### Registering [RESET1]/[RESET2]

- 1 Select [CUSTOM RESET] in shooting menu  (P. 106).
- 2 Select either [RESET1]/[RESET2] to register and press .
  - If settings have already been registered, [SET] is displayed next to [RESET1]/[RESET2]. Selecting [SET] again overwrites the registered setting.
  - To cancel the registration, select [RESET].
- 3 Select [SET] and press the  button.





### Using reset settings

This resets the camera to the factory default settings. You can also reset the camera to the [RESET1] or [RESET2] setting.

- 1 Select [CUSTOM RESET] in shooting menu  (P. 106).
- 2 Select [RESET], [RESET1], or [RESET2] and press the  button.
  - [RESET]: Resets to the factory default settings. For the default settings, see “Menu directory” (P. 106).
  - [RESET1]/[RESET2]: Resets to the registered settings.
- 3 Use   to select [YES], then press the  button.



#### Caution

- The following settings are unaffected. For defaults, see “Menu directory” (P. 106).  
RESET1, RESET2 (CUSTOM RESET)/PICTURE MODE////!...!/MY MODE SETUP/VIDEO OUT/ISO-AUTO/WB/EDIT FILENAME/dpi SETTING/EXPOSURE SHIFT/WARNING LEVEL

# 7 Customizing camera settings

## Custom Menu

Use the Custom Menu to customize camera settings.

### ■ Menu categories

Settings in the Custom Menu are divided into the following 10 categories:

	<b>AF/MF</b>	(P. 72)
	<b>BUTTON</b>	(P. 72)
	<b>RELEASE</b>	(P. 73)
	<b>DISP/PC</b>	(P. 73)
	<b>EXP/ISO</b>	(P. 75)

	<b>CUSTOM</b>	(P. 75)
	<b>←/COLOR/WB</b>	(P. 76)
	<b>RECORD/ERASE</b>	(P. 77)
	<b>MOVIE</b>	(P. 78)
	<b>UTILITY</b>	(P. 78)

### ■ Displaying the Custom Menu

Before changing settings in the Custom Menu, display the [] (Custom Menu) tab by selecting [ON] for the [ MENU DISPLAY] option in the setup menu.

**1** Press the **MENU** button to display the menus.

**2** Select the setup menu tab (P. 69) using  $\Delta$   $\nabla$  and press  $\triangleright$ .

**3** Select [ MENU DISPLAY] using  $\Delta$   $\nabla$  and press  $\triangleright$ .



**4** Select [ON] using  $\Delta$   $\nabla$  and press the button.

- The [] tab is displayed.

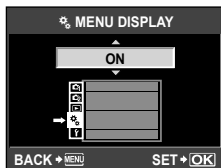

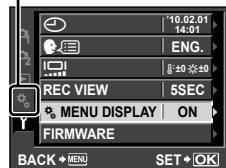

[] tab





## Custom Menu options



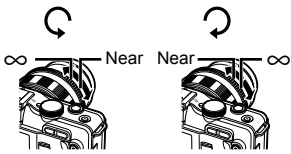







### AF/MF

MENU →  → 

Option	Description	
<b>AF MODE</b>	Choose the AF mode.	P. 44
<b>AF AREA</b>	Choose the AF target mode.	P. 45
<b>RESET LENS</b>	When set to [ON], this resets the focus of the lens (infinity) each time the power is turned off.	—
<b>BULB FOCUSING</b>	Normally focus locks during the exposure when manual focus (MF) is selected. Select [ON] to allow focusing using the focus ring.	—
<b>FOCUS RING</b>	You can customize how the lens adjusts to the focal point by selecting the rotational direction of the focus ring. <div style="text-align: center;">  </div>	—
<b>MF ASSIST</b>	Select [ON] to automatically magnify the image for precise focus when the focus ring is rotated in manual focus mode.	—
<b>[••] SET HOME</b>	Choose the AF target position that will be saved as the home position. [HP] appears in the AF target selection display while you choose a home position.	—

### BUTTON

MENU →  → 

Option	Description	
<b>AEL/AFL</b>	Assign focus or AE lock to the <b>Fn</b> or  (movie) button.	P. 79
<b>AEL/AFL MEMO</b>	If [ON] is selected, exposure will remain locked after the <b>Fn</b> or  (movie) is released. Exposure lock ends when the button is pressed a second time.	—
<b> FUNCTION</b>	Following functions can be assigned to the <b>Fn</b> or  (movie) button:	P. 80
<b> FUNCTION</b>	<b>Fn</b> FACE DETECT, PREVIEW,  [••] HOME, MF, RAW  , TEST PICTURE, MY MODE,  /  , AEL/AFL,  REC, BACKLIT LCD	



**Fn BUTTON**

 MENU → ⚙️ → **Fn**

Option	Description	
<b>MY MODE SETUP</b>	<p>When [MY MODE] (P. 80) is assigned to the <b>Fn</b> button, frequently-used settings can be recalled by pressing the <b>Fn</b> button. See page 104 for information on the settings that can be saved using My Mode.</p> <p><b>Saving My Mode Settings</b></p> <ol style="list-style-type: none"> <li>1) Select [MY MODE1] or [MY MODE2] and press .</li> <li>2) Select [SET] and press the .</li> </ol> <p><b>Recalling My Mode Settings</b></p> <ol style="list-style-type: none"> <li>1) Select [MY MODE1] or [MY MODE2] and press the .</li> <li>2) Select [YES] and press the .                     <ul style="list-style-type: none"> <li>• The selected My Mode is set.</li> <li>• When shooting, press the shutter button while holding down the <b>Fn</b> button.</li> </ul> </li> </ol>	—
<b>BUTTON TIMER</b>	<p>If [3 SEC], [5 SEC], or [8 SEC] is selected, settings can be adjusted for 3, 5, or 8 seconds after the , , , or  button is released. If [HOLD] is selected, settings can be adjusted until the button is pressed a second time.</p>	—

**Fn RELEASE**

 MENU → ⚙️ → **Fn**

Option	Description	
<b>RLS PRIORITY S</b>	<p>If [ON] is selected, the shutter can be released even when the camera is not in focus. This option can be set separately for S-AF (P. 44) and C-AF (P. 44) modes.</p>	—
<b>RLS PRIORITY C</b>		

**Fn DISP/([ ])/PC**

 MENU → ⚙️ → **Fn**

Option	Description	
<b>HDMI</b>	<p>Selecting the digital video signal format for connecting to a TV via an HDMI mini-cable. Choose [1080i] or [720p] to automatically select 1080i or 720p output where supported. Select [480p/576p] for 480p/576p output; note however that when [PAL] is selected for [VIDEO OUT] pictures will be displayed in 576p only. Choose a setting that matches the television video input setting.</p>	P. 67
<b>VIDEO OUT</b>	<p>You can select [NTSC] or [PAL] according to your TV's video signal type.</p>	P. 67

Option	Description	
<b>SLEEP</b>	The camera will enter sleep (standby) mode to reduce the drain on the battery if no operations are performed for the specified period. [OFF] cancels the sleep mode. Pressing a button such as the shutter button reactivates the camera.	—
<b>LIVE VIEW BOOST</b>	If [ON] is selected, the camera will adjust display brightness automatically. Changes to exposure compensation are not reflected in the monitor.	—
<b>FACE DETECT</b>	When set to [ON], the camera will detect people's faces and automatically adjust the focus there. The camera will automatically zoom in on faces detected during playback.	P. 32
<b>INFO SETTING</b>	[▶]INFO]: Choose the information displayed when the <b>INFO</b> button is pressed in playback mode. [LV-INFO]: Choose the information displayed when the <b>INFO</b> button is pressed during live view. To choose a framing guide from [■], [■], [■], or [■], select [DISPLAYED GRID] and press ▶. [■] SETTING]: Choose whether index and calendar playback can be accessed by pressing [■].	P. 33, 60
<b>CONTROL SETTING</b>	[iAUTO]: Choose the information displayed when the mode dial is rotated to <b>AUTO</b> from live guide (P. 18), live control (P. 20), super control panel (P. 81), or none. [P/A/S/M]: Choose the information displayed when the mode dial is rotated to <b>P</b> , <b>A</b> , <b>S</b> , or <b>M</b> from live control (P. 20), super control panel (P. 81), or none. [ART/SCN]: Choose the information displayed when the mode dial is rotated to <b>ART</b> or <b>SCN</b> from live control (P. 20), super control panel (P. 81), or none.	—
<b>HISTOGRAM SETTING</b>	[HIGHLIGHT]: Choose the tone range indicated by a red highlight (overexposure) warning display when the highlight and shadow display is selected in playback mode. [SHADOW]: Choose the tone range indicated by a blue shadow (underexposure) warning display when the highlight and shadow display is selected in playback mode.	P. 61
<b>EVF ADJUST</b>	[☺]: Adjust the color temperature of the electronic view finder display. [☼]: Adjust the brightness of the electronic view finder display.	P. 100
<b>BACKLIT LCD</b>	Choose how long the backlight remains lit. Choose [HOLD] to prevent the backlight from turning off automatically.	—
<b>MODE GUIDE</b>	Choose [ON] to display help for the selected mode when the mode dial is rotated to a new setting.	P. 10
<b>CLOSEUP MODE</b>	[mode1]: Press Q to zoom in (to a maximum of 14 ×) and press [■] to zoom out. Use the arrow pad to view other areas of the image after zooming in. [mode2]: Press the Q button to display a zoom frame.	P. 14, 60

Option	Description	
(Beep sound)	When set to [OFF], you can turn off the beep sound that is emitted when the focus locks by pressing the shutter button.	—
VOLUME	Adjust speaker volume.	P. 58, 62
USB MODE	Choose a mode for connecting the camera to a computer or printer.	P. 84, 87

Option	Description	
EV STEP	Choose the size of the increments used when selecting shutter speed, aperture, exposure compensation, and other exposure parameters.	P. 40, 48–49
METERING	Choose a metering mode according to the scene. In the cases of center-weighted and spot metering, the metered area is indicated by a frame.	P. 47
AEL Metering	Choose the metering mode used when the Fn or (movie) button is pressed to lock exposure. Choose [AUTO] to use the mode selected for [METERING].	P. 80
ISO	Set ISO sensitivity.	P. 41
ISO STEP	Select the increments available for choosing ISO sensitivity.	P. 41
ISO-AUTO SET	Choose the upper limit and default value used for ISO sensitivity when [AUTO] is selected for [ISO]. [HIGH LIMIT]: Choose the upper limit for auto ISO sensitivity selection. [DEFAULT]: Choose the default value for auto ISO sensitivity selection.	P. 41
ISO-AUTO	You can set the shooting mode in which the ISO [AUTO] is activated. [P/A/S]: Auto ISO sensitivity selection is available in all modes except M. ISO sensitivity is fixed at ISO 200 in mode M. [ALL]: Auto ISO sensitivity selection is available in all modes.	P. 41
BULB TIMER	You can set the maximum time for bulb shooting.	P. 39
ANTI-SHOCK [↕]	Choose the delay between the shutter button being pressed and the shutter being released. This diminishes camera shake caused by vibrations. This feature is useful in situations such as microscope photography and astrophotography. It is also useful for sequential shooting (P. 30) and self timer photography (P. 30).	—

Option	Description	
X-SYNC.	Choose the shutter speed used when the flash fires.	P. 102
SLOW LIMIT	Choose the slowest shutter speed available when a flash is used.	P. 102
+ +	When set to [ON], it will be added to the exposure compensation value and flash intensity control will be performed.	P. 40, 55

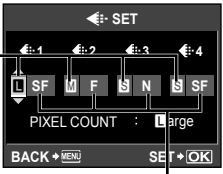
Option	Description	P. 39
<b>NOISE REDUCT.</b>	This function reduces the noise that is generated during long exposures. [AUTO]: Long exposure noise reduction activates automatically at slow shutter speeds. [ON]: Noise reduction is performed with every shot. [OFF]: Noise reduction off. <ul style="list-style-type: none"> <li>• When active, noise reduction approximately doubles shooting times.</li> <li>• Noise reduction turns off automatically during sequential shooting.</li> <li>• This function may not work effectively with some shooting conditions or subjects.</li> </ul>	P. 39
<b>NOISE FILTER</b>	Choose the amount of noise reduction performed at high ISO sensitivities.	—
<b>WB</b>	Choose the white balance mode.	P. 42
<b>ALL</b> <span style="border: 1px solid black; padding: 1px;">WB?</span>	[ALL SET]: Use the same white balance compensation in all modes except [CWB]. [ALL RESET]: Set white balance compensation for all modes except [CWB] to 0.	P. 42
<b>COLOR SPACE</b>	You can select how colors are reproduced on the monitor or printer.	—
<b>SHADING COMP.</b>	Choose [ON] to correct peripheral illumination according to the type of lens. This is particularly effective with wide angle lenses. <ul style="list-style-type: none"> <li>• Compensation is not available for teleconverters or extension tubes.</li> <li>• Noise may be visible at the edges of photographs taken at high ISO sensitivities.</li> </ul>	—
⚙️ <b>SET</b>	The record mode for JPEG photographs can be selected from four combinations of image size and compression rate. The camera offers a choice of three sizes and four compression rates for each combination. You can also choose the pixel count for <b>M</b> - and <b>S</b> -size images (P. 77). <div style="border: 1px solid gray; padding: 10px; margin-top: 10px;"> <p><b>Modifying JPEG record modes</b></p> <ol style="list-style-type: none"> <li>1) Use <b>&lt;&gt;</b> to select a combination (<b>&lt;</b>1-<b>&gt;</b>4) and use <b>Δ</b>/<b>▽</b> to change.</li> <li>2) Press <b>START/OK</b>.</li> </ol> <div style="text-align: center;">  </div> <p>Number of pixels      Compression rate</p> </div>	P. 31

Option	Description	
<b>PIXEL COUNT</b>	<p>Choose the pixel count for <b>M</b>- and <b>S</b>-size images.</p> <p><b>Choosing a pixel count</b></p> <ol style="list-style-type: none"> <li>1) Select [PIXEL COUNT] in the  Custom Menu (P. 71)  tab.</li> <li>2) Select <b>M</b> or <b>S</b> and press .</li> <li>3) Choose a pixel count and press .</li> </ol>	P. 31

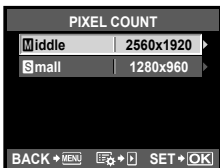

Option	Description	
<b>QUICK ERASE</b>	If [ON] is selected, pressing the  button in the playback display will immediately delete the current image.	P. 15
<b>RAW+JPEG ERASE</b>	<p>Choose the action performed when a photograph recorded at a setting of RAW+JPEG is erased in single-frame playback (P. 15).</p> <p>[JPEG]: Only the JPEG copy is erased.                      [RAW]: Only the RAW copy is erased.                      [RAW+JPEG]: Both copies are erased.</p> <ul style="list-style-type: none"> <li>• [ALL ERASE] (P. 66) and [ERASE SELECTED] (P. 66) delete both RAW and JPEG copies.</li> </ul>	P. 31
<b>FILE NAME</b>	<p>[AUTO]: Even when a new card is inserted, the file numbers are retained from the previous card. File numbering continues from the last number used or from the highest number available on the card.</p> <p>[RESET]: When you insert a new card, the folder numbers starts at 100 and the file name starts at 0001. If a card containing images is inserted, the file numbers start at the number following the highest file number on the card.</p>	—
<b>EDIT FILENAME</b>	Edit the file name.	—

**RECORD/ERASE**

MENU → → →

Option	Description	
<b>PRIORITY SET</b>	Choose the default selection ([YES] or [NO]) for confirmation dialogs.	—
<b>dpi SETTING</b>	Choose the print resolution. [AUTO]: Print resolution is selected automatically according to image size. [CUSTOM]: Choose a custom print resolution. Press  to display the setting screen.	—

**MOVIE**

MENU → → →

Option	Description	
<b>MODE</b>	Choose a movie record mode.	P. 56
<b>MOVIE+STILL</b>	Choose [ON] to record a photograph when movie recording ends.	P. 58
<b>MOVIE</b>	Choose [OFF] to record silent movies.	P. 57

**UTILITY**

MENU → → →

Option	Description	
<b>PIXEL MAPPING</b>	The pixel mapping feature allows the camera to check and adjust the image pickup device and image processing functions.	P. 94
<b>EXPOSURE SHIFT</b>	Adjust optimal exposure separately for each metering mode. <ul style="list-style-type: none"> <li>Optimal exposure can be adjusted by up to <math>\pm 1/3</math> EV. The range of exposures available in the selected direction (positive or negative) will be correspondingly reduced.</li> <li>The effects of exposure shift are not visible in the monitor. To make normal adjustments to the exposure, perform exposure compensation (P. 40).</li> </ul>	—
<b>WARNING LEVEL</b>	Choose when the low battery indicator () is displayed. <ul style="list-style-type: none"> <li>Charge the battery when the  indicator blinks.</li> </ul>	P. 6

## ■ AEL/AFL

MENU → → → [AEL/AFL]

If [AEL/AFL] is selected for [[Fn] FUNCTION] (P. 80) or [⊙ FUNCTION] (P. 80), the **Fn** or **⊙** (movie) button can be used to set focus or exposure instead of the shutter button.

Select the function of the button to match the operation when the shutter button is pressed. Choose an operating mode ([mode1]–[mode3], or in C-AF mode [mode1]–[mode4]) for the different focus modes.

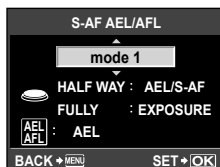









Mode		Shutter button function				Fn button or ⊙ (movie) button function	
		Half-press		Full press		When holding down AEL/AFL	
		Focus	Exposure	Focus	Exposure	Focus	Exposure
S-AF	mode1	S-AF	Locked	–	–	–	Locked
	mode2	S-AF	–	–	Locked	–	Locked
	mode3	–	Locked	–	–	S-AF	–
C-AF	mode1	C-AF start	Locked	Locked	–	–	Locked
	mode2	C-AF start	–	Locked	Locked	–	Locked
	mode3	–	Locked	Locked	–	C-AF start	–
	mode4	–	–	Locked	Locked	C-AF start	–
MF	mode1	–	Locked	–	–	–	Locked
	mode2	–	–	–	Locked	–	Locked
	mode3	–	Locked	–	–	S-AF	–

## ■ **Fn** FUNCTION, **MOVIE** FUNCTION

MENU →  →  → [**Fn**FUNCTION]/[**MOVIE**FUNCTION]

The following functions can be assigned to the **Fn** or **MOVIE** (movie) button:

<b>Fn FACE DETECT</b>	Pressing the <b>Fn</b> or <b>MOVIE</b> (movie) button selects [ON] for [  FACE DETECT]; press the <b>Fn</b> or <b>MOVIE</b> (movie) button again to turn it off (P. 32, 74).
<b>PREVIEW (electronic)</b>	Press and hold the <b>Fn</b> or <b>MOVIE</b> (movie) button to stop aperture down to the selected value and preview depth of field (P. 37).
	Press the <b>Fn</b> or <b>MOVIE</b> (movie) button to measure white balance (P. 43).
<b>[HOME] HOME</b>	Press the <b>Fn</b> or <b>MOVIE</b> (movie) button to select the home AF target position saved with [  ] SET HOME (P. 72). The home AF target position is indicated by a [  ] icon. Press the button again to return to AF target mode. If the camera is turned off when the home position is selected, the home position will be reset.
<b>MF</b>	Press the <b>Fn</b> or <b>MOVIE</b> (movie) button to select [MF] for AF mode. Press the button again to restore the previously selected AF mode.
<b>RAW</b> 	Press the <b>Fn</b> or <b>MOVIE</b> (movie) button to toggle between JPEG and RAW+JPEG record modes.
<b>TEST PICTURE</b>	To take a photograph and display it in the monitor without recording it to the card, press the shutter button while the <b>Fn</b> or <b>MOVIE</b> (movie) button is pressed.
<b>MY MODE</b>	Pictures taken while the <b>Fn</b> or <b>MOVIE</b> (movie) button is pressed will be shot at the settings selected for [MY MODE SETUP] (P. 73).
	Press the <b>Fn</b> or <b>MOVIE</b> (movie) button to toggle between  and  when the waterproof protector is attached.
<b>AEL/AFL</b>	Press the <b>Fn</b> or <b>MOVIE</b> (movie) button to lock focus and exposure.
<b>MOVIE REC</b>	Press the <b>Fn</b> or <b>MOVIE</b> (movie) button to record a movie. If this option has not been assigned to either button, movies can be recording using the shutter button.
<b>BACKLIT LCD</b>	Press the <b>Fn</b> or <b>MOVIE</b> (movie) button to turn the monitor off. This is useful when you are using the electronic view finder. Press the button again to turn the monitor on.
<b>OFF</b>	No function is assigned to the <b>Fn</b> or <b>MOVIE</b> (movie) button.



## Using the super control panel

The term “super control panel” refers to the display shown below, which lists shooting settings together with the option currently selected for each.

To use the super control panel, select [ON] for [CONTROL SETTING] > [SCP] (P. 74). To choose between the live control, super control panel, and other displays, press the **START/OK** button while the camera is in shooting mode and press the **INFO** button to cycle through the different displays

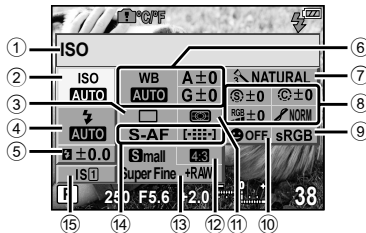

### ■ Settings that can be modified using super control panel

- |  |                                  |       |
|--|----------------------------------|-------|
| ① Currently selected option                | Gradation                        | P. 53 |
| ② ISO sensitivity ..... P. 41              | B&W Filter                       | P. 53 |
| ③ Sequential shooting/self-timer.... P. 30 | Picture tone                     | P. 53 |
| ④ Flash mode ..... P. 54                   | ⑨ Color space..... P. 76         |       |
| ⑤ Flash intensity control ..... P. 55      | ⑩ Face detection ..... P. 32, 74 |       |
| ⑥ White balance ..... P. 41                | ⑪ Metering mode ..... P. 47      |       |
| ⑦ White balance compensation.... P. 42     | ⑫ Aspect ratio ..... P. 32       |       |
| ⑧ Sharpness                                | ⑬ Record mode..... P. 31         |       |
| Contrast                                   | ⑭ AF mode..... P. 44             |       |
| Saturation                                 | AF target ..... P. 45            |       |
|  | ⑮ Image stabilizer..... P. 50    |       |

### ⚠ Caution

- Movie record mode is not displayed.

**1** While the super control panel is displayed, use  $\Delta$   $\nabla$   $\leftarrow$   $\rightarrow$  to select the desired setting.

**2** Change the highlighted setting using the **START/OK** button.

- Repeat steps 1 and 2 as necessary.
- The selected settings take effect automatically if no operations are performed for a few seconds.

**3** Press the shutter button halfway to return to shooting mode.

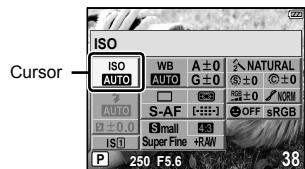

# 8 Printing pictures

## Print reservation (DPOF)

You can save digital “print orders” to the memory card listing the pictures to be printed and the number of copies of each print. You can then have the pictures printed at a print shop that supports DPOF or print the pictures yourself by connecting the camera directly to a DPOF printer. A memory card is required when creating a print order.

### ⚠ Caution

- The camera can not be used to modify print orders created with other devices. Creating a new print order deletes any existing print orders created with other devices.
- Not all functions may be available on all printers or at all photo labs.
- Print orders can not include RAW images or movies.
- When requesting prints without a digital print order, specify the file number. Requesting prints by frame number may result in the wrong pictures being printed.

### DPOF

DPOF (Digital Print Order Format) is a standard for recording the data that a printer or print service requires to automatically print pictures.

## 8

## Creating a print order

- 1 Press during playback and select .
- 2 Select or and press .
- 3 Add pictures to the print order.

### Individual pictures

Press to select the frame that you want to set as print reservation, then press to set the number of prints.

- To set print reservation for several pictures, repeat this step.

### All pictures

Select and press the .

- 4 Press the when you have finished.
- 5 Select the date and time format and press the .

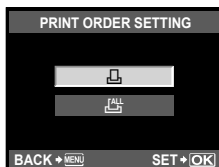

<b>NO</b>	The pictures are printed without the date and time.
<b>DATE</b>	The pictures are printed with the shooting date.
<b>TIME</b>	The pictures are printed with the shooting time.



**6** Select [SET] and press the button.

## Resetting the print reservation data

You can reset all print reservation data or just the data for selected pictures.

- 1** Press during playback and select [□].
- 2** Select [□] and press .
- 3** Select [KEEP] and press the button.
  - To remove all pictures from the print order, select [RESET] and press .
- 4** Use ◀▶ to select the frame with print reservation data you want to reset, then press ▽ to set the number of prints to 0.
- 5** Press the button when you have finished.
- 6** Select the date and time format and press the button.
  - This setting is applied to all frames with print reservation data.
- 7** Select [SET] and press the button.

## Direct printing (PictBridge)

By connecting the camera to a PictBridge-compatible printer with the USB cable, you can print out recorded pictures directly. To find out if your printer is compatible with PictBridge, refer to the printer's manual.

### PictBridge

The standard that enables digital cameras and printers made by different manufacturers to be connected, and also allows pictures to be printed directly from the camera.

### STANDARD

All printers that support PictBridge have standard print settings. By selecting [STANDARD] on the settings screens (P. 85), you can print pictures according to these settings. For details on your printer's standard settings, refer to the printer's manual or contact the printer manufacturer.

### **Caution**

- Use a fully charged battery for printing.

- Images recorded in RAW data cannot be printed.
- You cannot print movie images.
- The camera will not enter sleep mode while it is connected to the USB cable.

## Connecting the camera to a printer

Use the provided USB cable to connect the camera to a PictBridge-compatible printer.

**1** Turn the printer on and connect the camera's multi-connector to the printer's USB port with the USB cable.

- For details on how to turn the printer on and the position of the USB port, refer to the printer's manual.

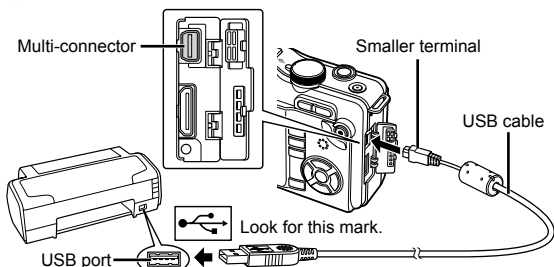

**2** Turn on the camera.

- The selection screen for the USB connection is displayed.

**3** Use  $\Delta$   $\nabla$  to select [PRINT].

- [ONE MOMENT] is displayed and the camera and printer are connected. Go to "Custom printing" (P. 85).

### ! Caution

- If the screen is not displayed after a few minutes, disconnect the USB Cable and start again from Step 1.

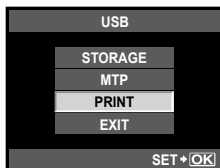

## Easy printing

**1** Use  $\triangleleft$   $\triangleright$  to display the pictures you want to print on the camera.

- Display the image you want to print on the camera and connect the camera with a printer using a USB cable.

**2** Press  $\triangleright$ .

- The picture selection screen appears when printing is completed. To print another picture, use  $\triangleleft$   $\triangleright$  to select the image and press the  $\text{OK}$  button.
- To exit, unplug the USB cable from the camera while the picture selection screen is displayed.

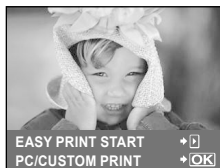

## Custom printing

**1** Follow the operation guide to set a print option.

### Selecting the print mode

Select the type of printing (print mode). The available print modes are as shown below.

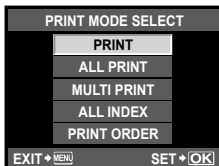

<b>PRINT</b>	Prints selected pictures.
<b>ALL PRINT</b>	Prints all the pictures stored in the card and makes one print for each picture.
<b>MULTI PRINT</b>	Prints multiple copies of one image in separate frames on a single sheet.
<b>ALL INDEX</b>	Prints an index of all the pictures stored in the card.
<b>PRINT ORDER</b>	Prints according to the print reservation you made. If there is no picture with print reservation, this is not available.

### Setting the print paper items

This setting varies with the type of printer. If only the printer's STANDARD setting is available, you cannot change the setting.

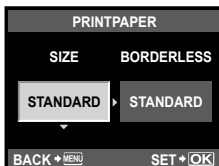

<b>SIZE</b>	Sets the paper size that the printer supports.
<b>BORDERLESS</b>	Selects whether the picture is printed on the entire page or inside a blank frame.
<b>PICS/SHEET</b>	Selects the number of pictures per sheet. Displayed when you have selected [MULTI PRINT].

## Selecting pictures you want to print

Select pictures you want to print. The selected pictures can be printed later (single-frame reservation) or the picture you are displaying can be printed right away.



<b>PRINT</b> [OK]	Prints the currently displayed picture. If there is a picture that [SINGLE PRINT] reservation has already been applied to, only that reserved picture will be printed.
<b>SINGLE PRINT</b> [OK]	Applies print reservation to the currently displayed picture. If you want to apply reservation to other pictures after applying [SINGLE PRINT], use <Left><Right> to select them.
<b>MORE</b> [OK]	Sets the number of prints and other items for the currently displayed picture, and whether or not to print it. For operation, refer to "Setting printing data" in the next section.

## Setting printing data

Select whether to print printing data such as the date and time or file name on the picture when printing. When the print mode is set to [ALL PRINT] and [OPTION SET] is selected, the following options appears.

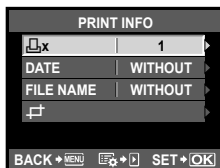

[x]	Sets the number of prints.
<b>DATE</b>	Prints the date and time recorded on the picture.
<b>FILE NAME</b>	Prints the file name recorded on the picture.
[Trim Icon]	Trims the picture for printing. Set the trimming size with the Q or [Trim Icon] button and the trimming position with Δ ∇ <Left><Right>.

**2** Once you have set the pictures for printing and printing data, select [PRINT], then press the [START/OK] button.

- To stop and cancel printing, press the [START/OK] button. To resume printing, select [CONTINUE].

## ■ Cancelling printing

To cancel printing, highlight [CANCEL] and press [START/OK]. Note that any changes to the print order will be lost; to cancel printing and return to the previous step, where you can make changes to the current print order, press **MENU**.

Your camera supports the USB Mass Storage Class. You can transfer images to a computer by connecting the camera to the computer with the provided USB cable. The following operating systems are compatible with the USB connection:

**Windows:** Windows 2000 Professional/Windows XP Home Edition/  
Windows XP Professional/Windows Vista/Windows 7

**Macintosh:** Mac OS X version 10.3 or later

## Connecting the camera to a computer

### 1 Turn the camera off and connect it to the computer.

- The location of the USB port varies with the computer. For details, refer to your computer's manual.

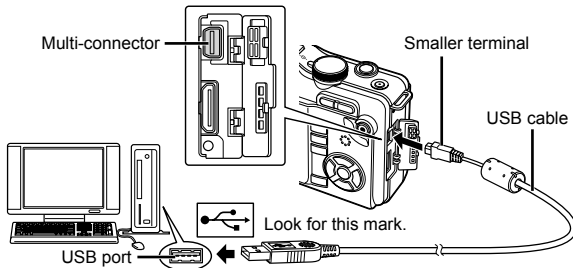

### 2 Turn on the camera.

- The selection screen for the USB connection is displayed.

### 3 Press $\Delta$ $\nabla$ to select [STORAGE]. Press the $\text{START/OK}$ button.

### 4 The computer recognizes the camera as a new device.

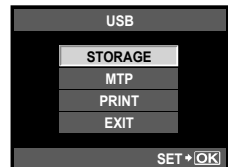

### ⚠ Caution

- If your computer is running Windows Vista, select [MTP] in Step 3 to use Windows Photo Gallery.
- Data transfer is not guaranteed in the following environments, even if your computer is equipped with a USB port.
  - Computers with a USB port added by means of an extension card, etc.
  - Computers without a factory-installed OS and home-built computers
- When the camera is connected to the computer, none of the camera buttons are functional.

## Installing the supplied computer software (ib)

After checking the system requirements, follow the instructions below to connect the camera to a computer and install the supplied computer software (ib). For information on using the computer software (ib), see the software's online help.

**System requirements:** **Windows XP (Service Pack 2 or later)/  
Windows Vista/Windows 7**

**1** Insert the supplied CD in a CD-ROM drive.

- A setup screen will appear on the computer monitor.

**!** **Caution**

- If the setup window is not displayed, select "My Computer" (Windows XP) or "Computer" (Windows Vista/Windows 7) from the start menu. Double-click the icon for the CD-ROM drive to open the setup CD window and then double-click "CameraInitialSetup.exe".

**2** Connect the camera to the computer.

**3** Follow the on-screen instructions on your computer.



## Shooting tips and information

### The camera does not turn on even when a battery is loaded

#### The battery is not fully charged

- Charge the battery with the charger.

#### The battery is temporarily unable to function because of the cold

- Battery performance declines in low temperatures, and the charge may not be sufficient to turn on the camera. Remove the battery and warm it by putting it in your pocket for a while.

### No picture is taken when the shutter button is pressed

#### The camera has turned off automatically

- To save battery power, if there is no operation, the camera goes into sleep mode after a fixed period of time and the camera stops operating. The camera activates again when you touch the shutter button or any other button.  "SLEEP" (P. 74)  
After a further fixed period of time has elapsed, the camera power turns off.

#### The flash is charging

- On the LCD monitor, the  mark blinks when charging is in progress. Wait for the blinking to stop, then press the shutter button.

#### Unable to focus

- When the AF confirmation mark on the LCD monitor is blinking, it indicates that the camera is unable to focus using AF. Press the shutter button again.

#### Noise reduction is activated

- When shooting night scenes, shutter speeds are slower and noise tends to appear in images. The camera activates the noise-reduction process after shooting at slow shutter speeds. During which, shooting is not allowed. You can set [NOISE REDUCT.] to [OFF].  "NOISE REDUCT." (P. 76)

### The date and time has not been set

#### The camera is used with the settings at the time of purchase

- The date and time of the camera is not set when purchased. Set the date and time before using the camera.  "Setting the date/time" (P. 7)

#### The battery has been removed from the camera

- The date and time settings will be returned to the factory default settings if the camera is left without the battery for approximately 1 day. The settings will be cancelled more quickly if the battery was only loaded in the camera for a short time before being removed. Before taking important pictures, check that the date and time settings are correct.

## Subjects that are difficult to focus on

It may be difficult to focus with auto focus in the following situations.

AF confirmation mark is blinking. These subjects are not focused.

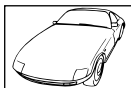

Subject with low contrast



Excessively bright light in center of frame

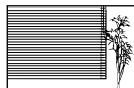

Subject with repeated patterns

AF confirmation mark lights up but the subject is not focused.



Subjects at different distances

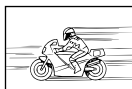

Fast-moving subject



Subject not inside AF area

In any situation, focus on something with high contrast that is at the same distance as the subject, determine the composition and shoot the picture. 📖 “Focus lock” (P. 46)

## Image taken appears whitish

This may occur when the picture is taken in backlight or semi-backlight conditions. This is due to a phenomenon called flare or ghosting. As far as possible, consider a composition where strong light source is not taken in the picture. Flare may occur even when a light source is not present in the picture. Use a lens hood to shade the lens from the light source. If a lens hood does not have effect, use your hand to shade the lens from the light. 📖 “Interchangeable lenses” (P. 97)

## Unknown bright dot(s) appear on the subject in the picture taken

This may be due to stuck pixel(s) on the image pickup device. Perform [PIXEL MAPPING]. If the problem persists, repeat pixel mapping a few times. 📖 “Pixel mapping - Checking the image processing functions” (P. 94)

## Functions that cannot be selected from menus

Some items may not be selectable from the menus when using the arrow pad.

- Items that cannot be set with the current shooting mode
- Items that cannot be set because of an item that has already been set: Combination of [📷] and [NOISE REDUCT.], etc.











## Camera vibration when the power is turned off









This is due to the camera initializing the image stabilizer mechanism. Without this initialization, the image stabilizer may not be able to achieve the proper effect.

## Set functions are restored to their factory default settings

When you rotate the mode dial or turn off the power in a shooting mode other than **P**, **A**, **S**, or **M**, functions with changes made to their settings are restored to the factory default settings.

## Error codes

Monitor indication	Possible cause	Corrective action
 NO CARD	The card is not inserted, or it cannot be recognized.	Insert a card or insert a different card.
 CARD ERROR	There is a problem with the card.	Insert the card again. If the problem persists, format the card. If the card cannot be formatted, it cannot be used.
 WRITE PROTECT	Writing to the card is prohibited.	The card write-protect switch is set to the "LOCK" side. Release the switch. (P. 95)
 CARD FULL	<ul style="list-style-type: none"> <li>The card is full. No more pictures can be taken or no more information such as print reservation can be recorded.</li> <li>There is no space in the card and print reservation or new images cannot be recorded.</li> </ul>	Replace the card or erase unwanted pictures. Before erasing, download important images to a PC.
	Card cannot be read. Card may not have been formatted.	<ul style="list-style-type: none"> <li>Select [CLEAN CARD], press the  button and turn off the camera. Remove the card and wipe dry the metallic surface with a soft, dry cloth.</li> <li>Select [FORMAT] ▶ [YES], and then press the  button to format the card. Formatting the card erases all data on the card.</li> </ul>
 NO PICTURE	There are no pictures on the card.	The card contains no pictures. Record pictures and play back.
 PICTURE ERROR	The selected picture cannot be displayed for playback due to a problem with this picture. Or the picture cannot be used for playback on this camera.	Use image processing software to view the picture on a PC. If that cannot be done, the image file is damaged.
 THE IMAGE CANNOT BE EDITED	Pictures taken with another camera cannot be edited on this camera.	Use image processing software to edit the picture.

Monitor indication	Possible cause	Corrective action
		Turn off the camera and wait for the internal temperature to cool.
 Internal camera temperature is too high. Please wait for cooling before camera use.	The internal temperature of the camera has risen due to sequential shooting.	Wait a moment for the camera to turn off automatically. Allow the internal temperature of the camera to cool before resuming operations.
 BATTERY EMPTY	The battery is drained.	Charge the battery.
 NO CONNECTION	The camera is not connected to the computer or printer correctly.	Disconnect the camera and connect it again correctly.
 NO PAPER	There is no paper in the printer.	Load some paper in the printer.
 NO INK	The printer has run out of ink.	Replace the ink cartridge in the printer.
 JAMMED	The paper is jammed.	Remove the jammed paper.
SETTINGS CHANGED	The printer's paper cassette has been removed or the printer has been manipulated while making settings on the camera.	Do not manipulate the printer while making settings on the camera.
 PRINT ERROR	There is a problem with the printer and/or camera.	Turn off camera and printer. Check the printer and remedy any problems before turning the power on again.
 CANNOT PRINT	Pictures recorded on other cameras may not be printed on this camera.	Use a personal computer to print.
The lens is locked. Please extend the lens.	The lens of the retractable lens stays retracted.	Extend the lens.
Please check the status of a lens.	An abnormality has occurred between the camera and the lens.	Turn off the camera, check the connection with the lens, and turn the power on again.

## Cleaning and storing the camera

### Cleaning the camera

Turn off the camera and remove the battery before cleaning the camera.

#### Exterior:

- Wipe gently with a soft cloth. If the camera is very dirty, soak the cloth in mild soapy water and wring well. Wipe the camera with the damp cloth and then dry it with a dry cloth. If you have used the camera at the beach, use a cloth soaked in clean water and well wrung.

#### LCD monitor:

- Wipe gently with a soft cloth.

#### Lens:

- Blow dust off the lens with a commercially available blower. For the lens, wipe gently with a lens cleaning paper.

### Storage

- When not using the camera for a prolonged period, remove the battery and card. Store the camera in a cool, dry place that is well ventilated.
- Insert the battery periodically and test the camera's functions.

### Cleaning and checking the image pickup device

This camera incorporates a dust reduction function to keep dust from getting on the image pickup device and to remove any dust or dirt from the image pickup device surface with ultrasonic vibrations. The dust reduction function operates when the camera is turned on.



The dust reduction function operates at the same time as the pixel mapping, which checks the image pickup device and image processing circuitry. Since dust reduction is activated every time the camera's power is turned on, the camera should be held upright for the dust reduction function to be effective.



#### **Caution**

- Do not use strong solvents such as benzene or alcohol, or a chemically treated cloth.
- Avoid storing the camera in places where chemicals are treated, in order to protect the camera from corrosion.
- Mold may form on the lens surface if the lens is left dirty.
- Check each part of the camera before use if it has not been used for a long time. Before taking important pictures, be sure to take a test shot and check that the camera works properly.

## Pixel mapping - Checking the image processing functions

The pixel mapping feature allows the camera to check and adjust the image pickup device and image processing functions. After using the monitor or taking continuous shots, wait for at least one minute before using the pixel mapping function to ensure that it operates correctly.

**1** Select [PIXEL MAPPING] in  Custom Menu (P. 71) tab .

**2** Press , then press the  button.

- The [BUSY] bar is displayed when pixel mapping is in progress. When pixel mapping is finished, the menu is restored.

### **Caution**

- If you accidentally turn the camera off during pixel mapping, start again from Step 1.

## Card basics

### Usable cards

“Card” in this manual refers to a recording medium. The only cards usable with this camera are SD memory cards and SDHC memory cards (sold separately) which conform to the SD standard. For the latest information, please visit the Olympus website.



#### SD card write protect switch

The SD card body has a write protect switch. If you set the switch to the “LOCK” side, you will not be able to write to the card, delete data or format. Return the switch to enable writing.





#### ⚠ Caution

- The data in the card will not be erased completely even after formatting the card or deleting the data. When discarding, destroy the card to prevent leakage of personal information.

### Formatting the card

Cards formatted on a computer or other camera must be formatted with the camera before they can be used.

All data stored on the card, including protected images, is erased when the card is formatted. When formatting a used card, confirm there are no images that you still want to keep on the card.

- 1 Select [CARD SETUP] in shooting menu  (P. 106).
  - 2 Select [FORMAT].
  - 3 Select [YES] and press .
- Formatting is performed.

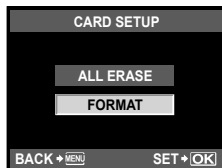

## Battery and charger

- Use the single Olympus lithium-ion battery (BLS-1). Other batteries cannot be used.
- The camera's power consumption varies widely with usage and other conditions.
- As the following consume a lot of power even without shooting, the battery will be drained quickly.
  - Performing auto focus repeatedly by pressing the shutter button halfway in shooting mode.
  - Displaying images on the LCD monitor for a prolonged period.
  - When connected to a computer or printer.
- When using a drained battery, the camera may turn off without the low battery warning being displayed.
- The battery will not be fully charged at the time of purchase. Charge the battery using the provided charger (BCS-1) before use.
- The normal charging time using the provided charger is approximately 3 hours 30 minutes (estimated).
- Do not use chargers other than the one designated.

### **Caution**

- There is a risk of explosion if the battery is replaced with the incorrect battery type. Dispose of the used battery following the instructions. "Battery Handling Precautions" (P. 112)

## Using your charger abroad

- The charger can be used in most home electrical sources within the range of 100 V to 240 V AC (50/60 Hz) around the world. However, depending on the country or area you are in, the AC wall outlet may be shaped differently and the charger may require a plug adapter to match the wall outlet. For details, ask at your local electrical shop or travel agent.
- Do not use commercially available travel adaptors as the charger may malfunction.



## Interchangeable lenses

Select the lens that you want to shoot with.

Use a specified lens (Micro Four Thirds mount). To use the “Four Thirds System Lens”, an adapter (sold separately) is required. An adapter to allow use of an OM system lens is also available (sold separately).

### M.ZUIKO DIGITAL interchangeable lenses

This is an interchangeable lens specifically for use with the “Micro Four Thirds system” which is a smaller, thinner version of the “Four Thirds system”.

#### Focal length and depth of field of Micro Four Thirds system lenses

When compared to 35-mm cameras, Micro Four Thirds system cameras achieve different effects at the same focal length and aperture.

##### Focal length

At the same focal length of a 35-mm camera, a Four Thirds system camera can achieve a focal length equivalent to twice that of a 35-mm camera. This enables the design of compact telephoto lenses. For instance, a Micro Four Thirds system lens 14–42 mm is equivalent to a 28–84 mm lens for a 35-mm camera.

- When the image angle of a Micro Four Thirds system lens is converted to that of a 35-mm camera, the perspective is the same as that of a 35-mm camera.

##### Depth of Field

A Micro Four Thirds system camera can achieve a depth of field equivalent to two times deeper than that of a 35-mm camera. A Micro Four Thirds system lens with f/2.8 brightness, for example, is equivalent to f/5.6 when converted to the aperture of a 35-mm camera.

- You can achieve the same amount of background blur as if you were using a 35-mm camera.

#### **Caution**

- When you attach or remove the body cap and lens from the camera, keep the lens mount on the camera pointed downward. This helps prevent dust and other foreign matter from getting inside the camera.
- Do not remove the body cap or attach the lens in dusty places.
- Do not point the lens attached to the camera toward the sun. This may cause the camera to malfunction or even ignite due to the magnifying effect of sunlight focusing through the lens.
- Be careful not to lose the body cap and rear cap.
- Attach the body cap to the camera to prevent dust from getting inside when no lens is attached.

## M.ZUIKO DIGITAL lens specifications

### Names of parts

- ① Filter mount thread
- ② Zoom ring
- ③ Focus ring
- ④ Mount index
- ⑤ Electrical contacts
- ⑥ Front cap
- ⑦ Rear cap

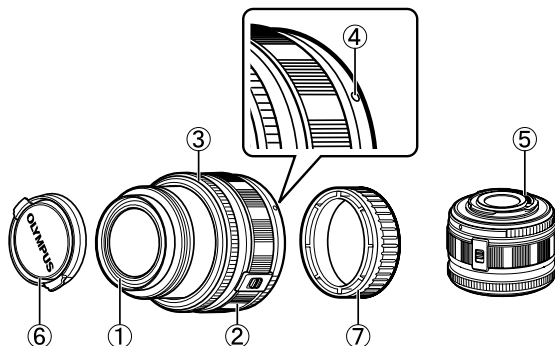

### Lens and camera combinations

Lens	Camera	Attachment	AF	Metering
Micro Four Thirds system lens	Micro Four Thirds system camera	Yes	Yes	Yes
Four Thirds system lens		Attachment possible with mount adapter	Yes <sup>*1</sup>	Yes
OM System lenses			No	Yes <sup>*2</sup>
Micro Four Thirds system lens	Four Thirds System Camera	No	No	No

\*1 [C-AF] and [C-AF+TR] of [AF MODE] cannot be used.

\*2 Accurate metering not possible.

Micro Four Thirds system lenses and Micro Four Thirds system cameras have the mark shown to the right.



### Main Specifications

Items	14–42 mm L	17 mm	40–150 mm
Mount	Micro Four Thirds mount		Four Thirds mount
Focal length	14–42 mm	17 mm	40–150 mm
Max. aperture	f/3.5–5.6	f/2.8	f/4–5.6
Image angle	75.4°–28.9°	64.9°	30°–8.2°
Lens configuration	8 groups, 9 lenses	4 groups, 6 lenses	9 groups, 12 lenses
	Multilayer film coating		Multilayer film coating (partially single layered)
Iris control	f/3.5–22	f/2.8–22	f/4–22
Shooting range	0.25 m–∞	0.2 m–∞	0.9 m–∞
Focus adjustment	AF/MF switching		
Weight (excluding hood and cap)	133 g	71 g	220 g
Dimensions (Max. diameter × overall length)	ø62×43.5 mm	ø57×22 mm	ø65.5×72 mm
Filter mount thread diameter	40.5 mm	37 mm	58 mm

## ■ Storage Precautions

- Clean the lens after use. Remove dust and dirt on the surface of the lens with a blower brush or brush. Use commercially available lens cleaning paper to remove the dirt on the lens. Do not use organic solvents.
- Always cap the lens and store it when it is not used.
- Do not store in an area with insect repellent.

## ! Caution

- Edges of pictures may be cut off if more than one filter is used or if a thick filter is used.

## Four Thirds Adapter

### ■ Names of parts

- ① Front cap
- ② Rear cap
- ③ Lens release button
- ④ Mount index
- ⑤ Electrical contacts

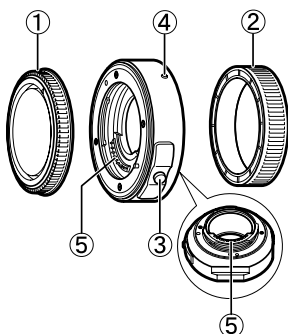

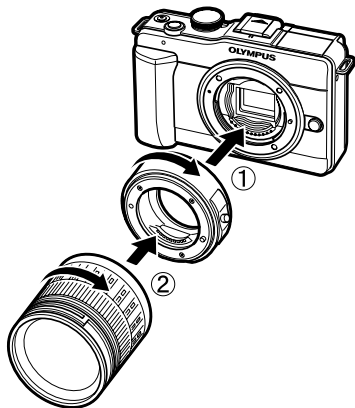

### ■ Mounting



## Using electronic view finder (sold separately)

If you use the electronic view finder (sold separately: VF-2), you can view the shooting screen in the finder. This is convenient when you are in a very bright location, such as under direct sunlight, where it is difficult to view the monitor, or are using the camera at a low angle. Also refer to the electronic view finder's manual.

- 1 Turn off the camera.
- 2 Slide off the hot shoe cover.
  - Keep the shoe cover in a safe place to avoid losing it.
- 3 Remove the connector cover from the electronic view finder.
- 4 Align the electronic view finder with the hot shoe on the camera body, and slide it in until it stops.
  - Insert the electronic view finder by pushing on its lower part.
- 5 Turn on the camera.
- 6 Each press of the  button switches between the monitor display and electronic view finder display.
  - You can adjust the brightness and color temperature of the electronic view finder.  "EVF ADJUST" (P. 74)

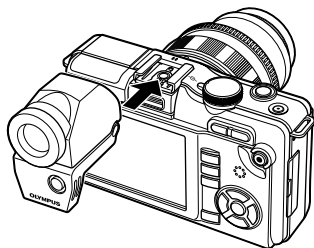

- 7 Turn the diopter adjustment ring to a position where the image on the viewfinder can be seen clearly.

- Adjust the electronic view finder to your preferred angle (up to 90 degrees).

### **Caution**

- You cannot use an external flash and the electronic view finder at the same time.
- When carrying the camera, do not hold it by the electronic view finder. The camera may separate from the electronic view finder and drop.
- Do not leave the camera with the electronic view finder attached in a location subject to direct sunlight.

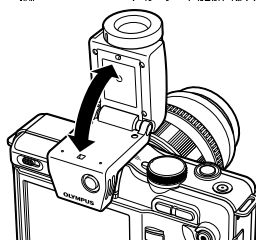
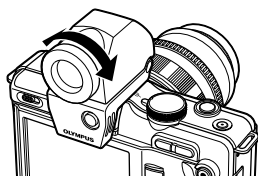

## Program line diagram (P mode)

In the **P** mode, the camera is programmed such that the aperture value and shutter speed are automatically selected according to the subject's brightness as shown below. The program line diagram varies with the type of lens mounted.

— When using the  
(14–42 mm F3.5–5.6)  
zoom lens  
(focal length: 14 mm)

— Program shift

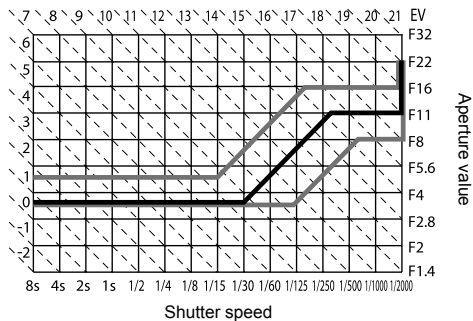

## Exposure warning display

If the optimum exposure cannot be obtained when pressing the shutter button halfway, the display will blink on the LCD monitor.

Shooting mode	Warning display example (blinking)	Status	Action
<b>P</b>		The subject is too dark.	<ul style="list-style-type: none"> <li>• Increase the ISO sensitivity.</li> <li>• Use the flash.</li> </ul>
		The subject is too bright.	<ul style="list-style-type: none"> <li>• Decrease the ISO sensitivity.</li> <li>• Use a commercially available ND filter (for adjusting the amount of light).</li> </ul>
<b>A</b>		The subject is underexposed.	<ul style="list-style-type: none"> <li>• Decrease the aperture value.</li> <li>• Increase the ISO sensitivity.</li> </ul>
		The subject is overexposed.	<ul style="list-style-type: none"> <li>• Increase the aperture value.</li> <li>• Decrease the ISO sensitivity or use a commercially available ND filter (for adjusting the amount of light).</li> </ul>
<b>S</b>		The subject is underexposed.	<ul style="list-style-type: none"> <li>• Set the shutter speed slower.</li> <li>• Increase the ISO sensitivity.</li> </ul>
		The subject is overexposed.	<ul style="list-style-type: none"> <li>• Set the shutter speed faster.</li> <li>• Decrease the ISO sensitivity or use a commercially available ND filter (for adjusting the amount of light).</li> </ul>

- The aperture value at the moment when its indication blinks varies with the lens type and focal length of the lens.

## Flash synchronization and shutter speed

Shooting mode	Flash timing	Upper limit of synchronization timing* <sup>1</sup>	Fixed timing when flash fires* <sup>2</sup>
<b>P</b>	1/ (lens focal length × 2) or synchronization timing, whichever is slower	1/160	1/60
<b>A</b>			—
<b>S</b>	The set shutter speed	1/160	—
<b>M</b>			—

\*1 Can be changed using menu: 1/60–1/160 "⚡X-SYNC." (P. 75)

\*2 Can be changed using menu: 1/30–1/160 "⚡SLOW LIMIT" (P. 75)

## Flash modes that can be set by shooting mode

Shooting Mode	Super control panel	Flash Mode	Flash timing	Conditions for firing the flash	Shutter speed limit
<b>P/A</b>		Auto flash	1st curtain	Fires automatically in dark/backlit* <sup>1</sup> conditions	1/30 sec.–1/160 sec.
		Auto flash (red-eye reduction)			
		Fill-in flash			
		Flash off	—	—	—
		Slow synchronization (red-eye reduction)	1st curtain	Fires automatically in dark/backlit* <sup>1</sup> conditions	60 sec.–1/160 sec.
		Slow synchronization (1st curtain)			
	Slow synchronization (2nd curtain)	2nd curtain			
<b>S/M</b>		Fill-in flash	1st curtain	Always fires	60 sec.–1/160 sec.
		Fill-in flash (red-eye reduction)			
		Flash off	—	—	—
	2nd CURTAIN	Fill-in flash/Slow synchronization (2nd curtain)	2nd curtain	Always fires	60 sec.–1/160 sec.

\*1 When the flash is set to the Super FP mode, it detects backlight with longer duration than for normal flash before emitting light.

- **AUTO**, can be set in **AUTO** mode.

## Focal lengths that can be set

8 mm	10 mm	12 mm	16 mm	18 mm	21 mm	24 mm	28 mm	30 mm
35 mm	40 mm	48 mm	50 mm	55 mm	65 mm	70 mm	75 mm	80 mm
85 mm	90 mm	100 mm	105 mm	120 mm	135 mm	150 mm	180 mm	200 mm
210 mm	250 mm	300 mm	350 mm	400 mm	500 mm	600 mm	800 mm	1000 mm

- Choose the value that most closely matches to the one that is printed on the lens.

## External flash shooting

With this camera, you can use one of the separately sold external flash units to achieve a flash suited to your needs. The external flashes communicate with the camera, allowing you to control the camera's flash modes with various available flash control modes, such as TTL-AUTO and Super FP flash.

An external flash unit specified for use with this camera can be mounted on the camera by attaching it to the camera's hot shoe. You can also attach the flash to the flash bracket on the camera using the bracket cable (optional). Refer to the documentation provided with the external flash units as well.

### Functions available with external flash units

Optional flash	FL-50R	FL-36R	FL-20	FL-14	RF-11	TF-22
Flash control mode	TTL-AUTO, AUTO, MANUAL, FP TTL AUTO, FP MANUAL		TTL-AUTO, AUTO, MANUAL		TTL-AUTO, MANUAL	
GN (Guide number) (ISO100)	GN50 (85mm*) GN28 (24mm*)	GN36 (85mm*) GN20 (24mm*)	GN20 (35mm*)	GN14 (28mm*)	GN11	GN22
RC mode	✓	✓	-	-	-	-

\* The focal length of the lens that can be used (Calculated based on 35 mm film camera).

## Wireless remote control flash photography

External flash units that offer a remote control mode and are designated for use with this camera can be used for wireless flash photography. The built-in flash can control up to three flash units independently. See the documentation provided with the external flash units for details.

### ■ Wireless flash control range

Position the wireless flash units with their remote sensors facing the camera. The following illustration shows the approximate ranges at which the flash units can be positioned. The actual control range varies with local conditions.

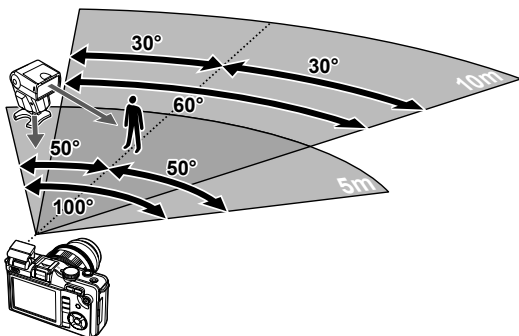

### ⚠ Caution

- If [ON] is selected for [⚡ RC MODE], photographs can only be taken with a wireless flash.

## Functions that can be registered with My Mode and Custom Reset Setting

Function	My Mode registration	Custom reset setting registration	Function	My Mode registration	Custom reset setting registration
IMAGE STABILIZER	✓	✓	HISTOGRAM SETTING	—	—
FLASH MODE	✓	✓	EVF ADJUST	—	—
PICTURE MODE	✓	✓	BACKLIT LCD	—	—
STILL	✓	✓	MODE GUIDE	—	—
PICTURE	✓	✓	CLOSEUP MODE	—	—
MOVIE	✓	✓	VOLUME	—	✓
IMAGE ASPECT	✓	✓	USB MODE	—	—
IMAGE ASPECT	✓	✓	EV STEP	✓	✓
AE BKT	✓	✓	METERING	✓	✓
WB BKT	✓	✓	AEL Metering	—	✓
FL BKT	✓	✓	ISO	✓	✓
ISO BKT	✓	✓	ISO STEP	✓	✓
MULTIPLE EXPOSURE	—	—	ISO-AUTO SET	—	✓
BULB TIMER	—	—	ISO-AUTO	—	✓
ANTI-SHOCK [▲]	—	—	BULB TIMER	—	✓
REC VIEW	—	✓	ANTI-SHOCK [▲]	✓	✓
MENU DISPLAY	—	—	X-SYNC.	✓	✓
FIRMWARE	—	—	SLOW LIMIT	✓	✓
AF MODE	✓	✓	SLOW LIMIT	—	✓
AF AREA	✓	✓	NOISE REDUCT.	✓	✓
RESET LENS	—	—	NOISE FILTER	✓	✓
BULB FOCUSING	—	—	WB	✓	✓
FOCUS RING	—	✓	ALL  WB	—	—
MF ASSIST	—	✓	COLOR SPACE	✓	✓
SET HOME	—	—	SHADING COMP.	✓	✓
AEL/AFL	—	✓	SET	—	✓
AEL/AFL MEMO	—	✓	PIXEL COUNT	—	✓
FUNCTION	—	✓	QUICK ERASE	—	✓
FUNCTION	—	✓	RAW+JPEG ERASE	—	✓
MY MODE SETUP	—	—	FILE NAME	—	✓
BUTTON TIMER	—	—	EDIT FILENAME	—	—
RLS PRIORITY S	✓	✓	PRIORITY SET	—	—
RLS PRIORITY C	✓	✓	dpi SETTING	—	—
HDMI	—	—	MODE	—	—
VIDEO OUT	—	—	MOVIE+STILL	—	✓
SLEEP	—	✓	MOVIE	—	✓
LIVE VIEW BOOST	—	✓	PIXEL MAPPING	—	✓
FACE DETECT	—	—	EXPOSURE SHIFT	—	✓
INFO SETTING	—	✓	WARNING LEVEL	—	—
CONTROL SETTING	—	—			

✓ : Can be registered.

— : Cannot be registered.

\* Includes anti-shock.



## Record mode and file size/number of storable still pictures

The file size in the table is approximate for files with a 4:3 aspect ratio.

Record mode	Number of pixels (PIXEL COUNT)	Compression	File format	File size (MB)	Number of storable still picture*1
RAW	4032×3024	Loss-less compression	ORF	Approx. 14	54
L <sup>SF</sup>		1/2.7		Approx. 8.4	101
L <sup>F</sup>		1/4		Approx. 5.9	145
L <sup>N</sup>		1/8		Approx. 2.7	320
L <sup>B</sup>		1/12		Approx. 1.8	477
M <sup>SF</sup>	3200×2400	1/2.7	JPEG	Approx. 5.6	154
M <sup>F</sup>		1/4		Approx. 3.4	255
M <sup>N</sup>		1/8		Approx. 1.7	504
M <sup>B</sup>		1/12		Approx. 1.2	747
M <sup>SF</sup>	2560×1920	1/2.7	JPEG	Approx. 3.2	269
M <sup>F</sup>		1/4		Approx. 2.2	395
M <sup>N</sup>		1/8		Approx. 1.1	776
M <sup>B</sup>		1/12		Approx. 0.8	1143
M <sup>SF</sup>	1600×1200	1/2.7	JPEG	Approx. 1.3	673
M <sup>F</sup>		1/4		Approx. 0.9	993
M <sup>N</sup>		1/8		Approx. 0.5	1893
M <sup>B</sup>		1/12		Approx. 0.4	2753
S <sup>SF</sup>	1280×960	1/2.7	JPEG	Approx. 0.9	1044
S <sup>F</sup>		1/4		Approx. 0.6	1514
S <sup>N</sup>		1/8		Approx. 0.3	2884
S <sup>B</sup>		1/12		Approx. 0.3	4038
S <sup>SF</sup>	1024×768	1/2.7	JPEG	Approx. 0.6	1594
S <sup>F</sup>		1/4		Approx. 0.4	2243
S <sup>N</sup>		1/8		Approx. 0.3	4038
S <sup>B</sup>		1/12		Approx. 0.2	5507
S <sup>SF</sup>	640×480	1/2.7	JPEG	Approx. 0.3	3563
S <sup>F</sup>		1/4		Approx. 0.2	5048
S <sup>N</sup>		1/8		Approx. 0.2	8654
S <sup>B</sup>		1/12		Approx. 0.1	10096











\*1 Assumes a 1GB SD card.

### ! Caution





- The number of remaining pictures may change according to the subject, whether or not print reservations have been made, and other factors. In certain instances, the number of remaining pictures displayed on the LCD monitor will not change even when you take pictures or erase stored images.
- The actual file size varies according to the subject.
- The maximum number of storable still pictures displayed on the monitor is 9999.
- For the available recording time for movies, see the Olympus website.

## Menu directory









### Shooting Menu

Tab	Function	Default			
	CARD SETUP	—	P. 66, 95		
	CUSTOM RESET	—	P. 70		
	PICTURE MODE	 NATURAL	P. 52		
		STILL PICTURE	 N	P. 31	
		MOVIE	HD		
	IMAGE ASPECT	4:3	P. 32		
			P. 30		
	IMAGE STABILIZER	OFF	P. 50		
	BRACKETING	AE BKT	OFF	P. 48	
		WB BKT	A-B	OFF	P. 49
			G-M		
		FL BKT	OFF	P. 49	
	ISO BKT	OFF	P. 49		
	MULTIPLE EXPOSURE	FRAME	OFF	P. 51	
		AUTO GAIN	OFF		
		OVERLAY	OFF		
		±0	P. 55		
	RC mode	OFF	P. 103		

### Playback Menu

Tab	Function	Default		
	START	—	P. 62	
	BGM	MELANCHOLY		
	SLIDE	ALL		
	SLIDE INTERVAL	3 SEC		
	MOVIE INTERVAL	SHORT		
EDIT	SEL. IMAGE	RAW DATA EDIT	—	P. 63
		JPEG EDIT	—	P. 63
		—	—	P. 65
		IMAGE OVERLAY	—	P. 64
		—	P. 82	
RESET PROTECT		—	P. 66	

### Setup Menu

Tab	Function	Default		
		—	P. 7	
	 *	—	P. 69	
		 ±0,  ±0	—	P. 69
	REC VIEW	5 SEC	—	P. 69
	 MENU DISPLAY	OFF	—	P. 71
	FIRMWARE	—	—	P. 69

\*1 Settings differ depending on the region where the camera is purchased.

## ⚙️ Custom Menu

Tab	Function	Default	📖
⚙️	AF/MF		P. 72
	AF MODE	STILL PICTURE MOVIE	S-AF P. 44
	AF AREA	[⋮]	P. 45
	RESET LENS	ON	P. 72
	BULB FOCUSING	ON	P. 72
	FOCUS RING	🔄	P. 72
	MF ASSIST	OFF	P. 72
	SET HOME	[⋮]	P. 72
	BUTTON		P. 72
	AEL/AFL	S-AF mode1 C-AF mode2 MF mode1	P. 79
	AEL/AFL MEMO	ON	P. 72
	FUNCTION	Fn FACE DETECT	P. 80
	FUNCTION	📺 REC	P. 80
	MY MODE SETUP	—	P. 73
	BUTTON TIMER	8 SEC	P. 73
	RELEASE		P. 73
	RLS PRIORITY S	OFF	P. 73
	RLS PRIORITY C	ON	P. 73
	DISP/PC		P. 73
	HDMI	HDMI OUT 1080i HDMI CONTROL OFF	P. 73
	VIDEO OUT	NTSC	P. 73
	SLEEP	1MIN	P. 74
	LIVE VIEW BOOST	OFF	P. 74
	FACE DETECT	ON	P. 32, 74
	/INFO SETTING	INFO IMAGE ONLY, OVERALL LV-INFO IMAGE ONLY,	P. 74
	SETTING  25, CALENDAR		
CONTROL SETTING	iAUTO LIVE GUIDE P/A/S/M LIVE CONTROL ART/SCN LIVE CONTROL	P. 74	
HISTOGRAM SETTING	HIGHLIGHT 255 SHADOW 0	P. 74	
EVF ADJUST	📏 ±0, ⚙️ ±0	P. 74	
BACKLIT LCD	8 SEC	P. 74	
MODE GUIDE	ON	P. 74	
CLOSEUP MODE	mode1	P. 60, 74	
	ON	P. 75	
VOLUME	3	P. 75	
USB MODE	AUTO	P. 75	

Tab	Function	Default	Icon	
☰	EXP//ISO		P. 75	
	EV STEP	1/3EV	P. 75	
	METERING		P. 47	
	AEL Metering	AUTO	P. 75	
	ISO	AUTO	P. 41	
	ISO STEP	1/3EV	P. 75	
	ISO-AUTO SET	HIGH LIMIT: 1600 DEFAULT: 200	P. 75	
	ISO-AUTO	P/A/S	P. 75	
	BULB TIMER	8 MIN	P. 75	
	ANTI-SHOCK []	OFF	P. 75	
	⚡	⚡ CUSTOM		P. 75
		⚡ X-SYNC.	1/160	P. 75
		⚡ SLOW LIMIT	1/60	P. 75
		+	OFF	P. 75
	🎨	←/COLOR/WB		P. 76
NOISE REDUCT.		AUTO	P. 76	
NOISE FILTER		STANDARD	P. 76	
WB		AUTO	A -7-+7, G -7-+7	P. 41
ALL		ALL SET	—	P. 76
		ALL RESET	—	P. 76
COLOR SPACE		sRGB	P. 76	
SHADING COMP.		OFF	P. 76	
← SET		—	P. 76	
PIXEL COUNT		Middle	2560×1920	P. 77
	Small	1280×960		
📄	RECORD/ERASE		P. 77	
	QUICK ERASE	OFF	P. 77	
	RAW+JPEG ERASE	RAW+JPEG	P. 77	
	FILE NAME	AUTO	P. 77	
	EDIT FILENAME	OFF	P. 77	
	PRIORITY SET	NO	P. 78	
	dpi SETTING	AUTO	P. 78	
🎬	MOVIE		P. 78	
	MODE	<b>P</b>	P. 56	
	MOVIE+STILL	OFF	P. 58	
	MOVIE	ON	P. 57	
🔧	📷 UTILITY		P. 78	
	PIXEL MAPPING	—	P. 94	
	EXPOSURE SHIFT		±0	P. 78
WARNING LEVEL		±0	P. 78	

# Specifications

## Camera

<b>Product type</b>	
Product type	Digital camera with interchangeable lens system
Lens	M.Zuiko Digital, Micro Four Thirds System Lens
Lens mount	Micro Four Thirds mount
Equivalent focal length on a 35 mm film camera	Approx. twice the focal length of the lens
<b>Image pickup device</b>	
Product type	4/3" Live MOS sensor
No. of total pixels	Approx. 13,060,000 pixels
No. of effective pixels	Approx. 12,300,000 pixels
Screen size	17.3 mm (H) × 13.0 mm (V)
Aspect ratio	1.33 (4:3)
<b>Live view</b>	
Sensor	Uses Live MOS sensor
Field of view	100%
<b>LCD monitor</b>	
Product type	2.7" TFT color LCD
Total no. of pixels	Approx. 230,000 dots
<b>Shutter</b>	
Product type	Computerized focal-plane shutter
Shutter	1/2000–60 sec., Bulb shooting
<b>Auto focus</b>	
Product type	Imager contrast detection system
Focusing points	11 points
Selection of focusing point	Auto, Optional
<b>Exposure control</b>	
Metering system	TTL metering system (imager metering) Digital ESP metering/Center weighted averaging metering/Spot metering
Metered range	EV 0–18 (Digital ESP metering/Center weighted averaging metering/Spot metering)
Shooting modes	<b>AUTO</b> : iAUTO/ <b>P</b> : Program AE (Program shift can be performed)/ <b>A</b> : Aperture priority AE/ <b>S</b> : Shutter priority AE/ <b>M</b> : Manual/ <b>ART</b> : Art filter/ <b>SCN</b> : Scene/ <b>MOV</b> : Movie
ISO sensitivity	100–3200 (1/3, 1 EV step)
Exposure compensation	±3EV (1/3, 1/2, 1 EV step)
<b>White balance</b>	
Product type	Image pickup device
Mode setting	Auto/Presets WB (8 settings)/Customized WB/One-touch WB
<b>Recording</b>	
Memory	SD memory card/SDHC memory card
Recording system	Digital recording, JPEG (in accordance with Design rule for Camera File system (DCF)), RAW Data
Applicable standards	Exif 2.2, Digital Print Order Format (DPOF), PRINT Image Matching III, PictBridge
Sound with still pictures	Wave format
Movie	AVI Motion JPEG
Audio	PCM 44.1 kHz
<b>Playback</b>	
Display format	Single-frame playback/Close-up playback/Index display/Calendar display
<b>Drive</b>	
Drive mode	Single-frame shooting/Sequential shooting/Self-timer
Sequential shooting	3 frames/sec.
Self-timer	Operation time: 12 sec., 2 sec.

<b>External flash</b>	
Synchronization	Synchronized with the camera at 1/160 sec. or less
Flash control mode	TTL-AUTO (TTL pre-flash mode)/AUTO/MANUAL
Flash attachment	Hot shoe
<b>External connector</b>	
Multi-connector (USB connector, AV connector)/HDMI mini connector (Type C)/Accessory port	
<b>Power supply</b>	
Battery	Li-ion Battery (BLS-1) × 1
<b>Dimensions/weight</b>	
Dimensions	114.6 mm (W) × 72.2 mm (H) × 41.5 mm (D) (4.5" × 2.8" × 1.6") (excluding protrusions)
Weight	Approx. 344 g (0.8 lb.) (including battery and memory card)
<b>Operating environment</b>	
Temperature	0 °C–40 °C (32 °F–104 °F) (operation)/–20 °C–60 °C (–4 °F–140 °F) (storage)
Humidity	30%–90% (operation)/10%–90% (storage)

HDMI, the HDMI logo and High-Definition Multimedia Interface are trademarks or registered trademarks of HDMI Licensing LLC.



## Battery/charger

### ■ BLS-1 Lithium ion battery

MODEL NO.	PS-BLS1
Product type	Rechargeable Lithium ion battery
Nominal voltage	DC 7.2 V
Nominal capacity	1150 mAh
No. of charge and discharge times	Approx. 500 times (varies with usage conditions)
Ambient temperature	0 °C–40 °C (32 °F–104 °F) (charging) –10 °C–60 °C (14 °F–140 °F) (operation) –20 °C–35 °C (–4 °F–95 °F) (storage)
Dimensions	Approx. 35.5 mm (W) × 55 mm (D) × 12.8 mm (H) (1.4" × 2.2" × 0.5")
Weight	Approx. 46 g (0.1 lb.)

### ■ BCS-1 Lithium ion charger

MODEL NO.	PS-BCS1
Rated input	AC 100V–240V (50/60Hz)
Rated output	DC 8.35V, 400mA
Charging time	Approx. 3 hours 30 minutes (room temperature if using BLS-1)
Ambient temperature	0 °C–40 °C (32 °F–104 °F) (operation)/ –20 °C–60 °C (–4 °F–140 °F) (storage)
Dimensions	Approx. 62 mm (W) × 83 mm (D) × 38 mm (H) (2.4" × 3.3" × 1.5")
Weight	Approx. 72 g (0.2 lb.) (without AC cable)

SPECIFICATIONS ARE SUBJECT TO CHANGE WITHOUT ANY NOTICE OR OBLIGATION ON THE PART OF THE MANUFACTURER.

# SAFETY PRECAUTIONS



**CAUTION**  
RISK OF ELECTRIC SHOCK  
DO NOT OPEN



**CAUTION: TO REDUCE THE RISK OF ELECTRICAL SHOCK, DO NOT REMOVE COVER (OR BACK). NO USER-SERVICEABLE PARTS INSIDE. REFER SERVICING TO QUALIFIED OLYMPUS SERVICE PERSONNEL.**



An exclamation mark enclosed in a triangle alerts you to important operating and maintenance instructions in the documentation provided with the product.



#### DANGER

If the product is used without observing the information given under this symbol, serious injury or death may result.



#### WARNING

If the product is used without observing the information given under this symbol, injury or death may result.



#### CAUTION

If the product is used without observing the information given under this symbol, minor personal injury, damage to the equipment, or loss of valuable data may result.

#### WARNING!

TO AVOID THE RISK OF FIRE OR ELECTRICAL SHOCK, NEVER DISASSEMBLE, EXPOSE THIS PRODUCT TO WATER OR OPERATE IN A HIGH HUMIDITY ENVIRONMENT.

## General Precautions

**Read All Instructions** — Before you use the product, read all operating instructions. Save all manuals and documentation for future reference.

**Cleaning** — Always unplug this product from the wall outlet before cleaning. Use only a damp cloth for cleaning. Never use any type of liquid or aerosol cleaner, or any type of organic solvent to clean this product.

**Attachments** — For your safety, and to avoid damaging the product, use only accessories recommended by Olympus.

**Water and Moisture** — For precautions on products with weatherproof designs, read the weatherproofing sections.

**Location** — To avoid damage to the product, mount the product securely on a stable tripod, stand, or bracket.

**Power Source** — Connect this product only to the power source described on the product label.

**Foreign Objects** — To avoid personal injury, never insert a metal object into the product.

**Heat** — Never use or store this product near any heat source such as a radiator, heat register, stove, or any type of equipment or appliance that generates heat, including stereo amplifiers.

## Product Handling Precautions

### **WARNING**

- Do not use the camera near flammable or explosive gases.
- Do not use the flash and LED on people (infants, small children, etc.) at close range.

You must be at least 1 m (3 ft.) away from the faces of your subjects. Firing the flash too close to the subject's eyes could cause a momentary loss of vision.

- Keep young children and infants away from the camera.

Always use and store the camera out of the reach of young children and infants to prevent the following dangerous situations which could cause serious injury:

- Becoming entangled in the camera strap, causing strangulation.

- Accidentally swallowing the battery, cards or other small parts.
- Accidentally firing the flash into their own eyes or those of another child.
- Accidentally being injured by the moving parts of the camera.

- **Do not look at the sun or strong lights with the camera.**
- **Do not use or store the camera in dusty or humid places.**
- **Do not cover the flash with a hand while firing.**

### CAUTION

- **Stop using the camera immediately if you notice any unusual odors, noise, or smoke around it.**

Never remove the batteries with bare hands, which may cause a fire or burn your hands.

- **Never hold or operate the camera with wet hands.**
- **Do not leave the camera in places where it may be subject to extremely high temperatures.**

Doing so may cause parts to deteriorate and, in some circumstances, cause the camera to catch fire.

Do not use the charger if it is covered (such as a blanket). This could cause overheating, resulting in fire.

- **Handle the camera with care to avoid getting a low-temperature burn.**

When the camera contains metal parts, overheating can result in a low-temperature burn. Pay attention to the following:

- When used for a long period, the camera will get hot. If you hold on to the camera in this state, a low temperature burn may be caused.
- In places subject to extremely cold temperatures, the temperature of the camera's body may be lower than the environmental temperature. If possible, wear gloves when handling the camera in cold temperatures.
- **Be careful with the strap.**

Be careful with the strap when you carry the camera. It could easily catch on stray objects - and cause serious damage.

## Battery Handling Precautions

Follow these important guidelines to prevent batteries from leaking, overheating, burning, exploding, or causing electrical shocks or burns.

### DANGER

- The camera uses a lithium ion battery specified by Olympus. Charge the battery with the specified charger. Do not use any other chargers.
- Never heat or incinerate batteries.
- Take precautions when carrying or storing batteries to prevent them from coming into contact with any metal objects such as jewelry, pins, fasteners, etc.
- Never store batteries where they will be exposed to direct sunlight, or subjected to high temperatures in a hot vehicle, near a heat source, etc.
- To prevent causing battery leaks or damaging their terminals, carefully follow all instructions regarding the use of batteries. Never attempt to disassemble a battery or modify it in any way, by soldering, etc.
- If battery fluid gets into your eyes, flush your eyes immediately with clear, cold running water and seek medical attention immediately.
- Always store batteries out of the reach of small children. If a child accidentally swallows a battery, seek medical attention immediately.

### WARNING

- Keep batteries dry at all times.
- To prevent batteries from leaking, overheating, or causing a fire or explosion, use only batteries recommended for use with this product.
- Insert the battery carefully as described in the operating instructions.
- If rechargeable batteries have not been recharged within the specified time, stop charging them and do not use them.
- Do not use a battery if it is cracked or broken.
- If a battery leaks, becomes discolored or deformed, or becomes abnormal in any other way during operation, stop using the camera.
- If a battery leaks fluid onto your clothing or skin, remove the clothing and flush the affected area with clean, running cold water immediately.



If the fluid burns your skin, seek medical attention immediately.

- Never subject batteries to strong shocks or continuous vibration.

## **⚠ CAUTION**

- Before loading, always inspect the battery carefully for leaks, discoloration, warping, or any other abnormality.
- The battery may become hot during prolonged use. To avoid minor burns, do not remove it immediately after using the camera.
- Always unload the battery from the camera before storing the camera for a long period.
- This camera uses a lithium ion battery specified by Olympus. Do not use any other type of battery. For safe and proper use, read the battery's instruction manual carefully before using it.
- If the battery's terminals get wet or greasy, camera contact failure may result. Wipe the battery well with a dry cloth before use.
- Always charge a battery when using it for the first time, or if it has not been used for a long period.
- When operating the camera with battery power at low temperatures, try to keep the camera and spare battery as warm as possible. A battery that has run down at low temperatures may be restored after it is warmed at room temperature.
- The number of pictures you can take may vary depending on the shooting conditions or battery.
- Before going on a long trip, and especially before traveling abroad, purchase extra batteries. A recommended battery may be difficult to obtain while traveling.
- Please recycle batteries to help save our planet's resources. When you throw away dead batteries, be sure to cover their terminals and always observe local laws and regulations.

## **Caution for Usage Environment**

- To protect the high-precision technology contained in this product, never leave the camera in the places listed below, no matter if in use or storage:
  - Places where temperatures and/or humidity are high or go through extreme changes.  
Direct sunlight, beaches, locked cars, or near other heat sources (stove, radiator, etc.) or humidifiers.
  - In sandy or dusty environments.

- Near flammable items or explosives.
- In wet places, such as bathrooms or in the rain. When using products with weatherproof designs, read their manuals as well.
- In places prone to strong vibrations.

- Never drop the camera or subject it to severe shocks or vibrations.
- When mounted on a tripod, adjust the position of the camera with the tripod head. Do not twist the camera.
- Do not leave the camera pointed directly at the sun. This may cause lens or shutter curtain damage, color failure, ghosting on the image pickup device, or may possibly cause fires.
- Do not touch electric contacts on cameras and interchangeable lenses. Remember to attach the body cap when removing the lens.
- Before storing the camera for a long period, remove the battery. Select a cool, dry location for storage to prevent condensation or mold from forming inside the camera. After storage, test the camera by turning it on and pressing the shutter release button to make sure that it is operating normally.
- Always observe the operating environment restrictions described in the camera's manual.
- Do not directly touch or wipe the image pickup device of the camera.

## **LCD Monitor**

- Do not push the monitor forcibly; otherwise the image may become vague, resulting in a playback mode failure or damage to the monitor.
- A strip of light may appear on the top/bottom of the monitor, but this is not a malfunction.
- When a subject is viewed diagonally in the camera, the edges may appear zigzagged on the monitor. This is not a malfunction; it will be less noticeable in playback mode.
- In places subject to low temperatures, the LCD monitor may take a long time to turn on or its color may change temporarily. When using the camera in extremely cold places, it is a good idea to occasionally place it in a warm place. An LCD monitor exhibiting poor performance due to low temperatures will recover in normal temperatures.
- The LCD used for the monitor is made with high-precision technology. However, black spots or bright spots of light may appear constantly on the LCD Monitor.

Due to its characteristics or the angle at which you are viewing the monitor, the spot may not be uniform in color and brightness. This is not a malfunction.

## Lens

- Do not immerse in water or splash with water.
- Do not drop or exert strong force on the lens.
- Do not hold at the moving part of the lens.
- Do not touch the lens surface directly.
- Do not touch the contact points directly.
- Do not subject to abrupt temperature changes.
- The operating temperature range is  $-10^{\circ}\text{C}$   $-40^{\circ}\text{C}$  ( $14^{\circ}\text{F}$ – $104^{\circ}\text{F}$ ). Always use within this temperature range.

## Legal and Other Notices

- Olympus makes no representations or warranties regarding any damages, or benefit expected by using this unit lawfully, or any request from a third person, which are caused by the inappropriate use of this product.
- Olympus makes no representations or warranties regarding any damages or any benefit expected by using this unit lawfully which are caused by erasing picture data.

## Disclaimer of Warranty

- Olympus makes no representations or warranties, either expressed or implied, by or concerning any content of these written materials or software, and in no event shall be liable for any implied warranty of merchantability or fitness for any particular purpose or for any consequential, incidental or indirect damages (including but not limited to damages for loss of business profits, business interruption and loss of business information) arising from the use or inability to use these written materials or software or equipment. Some countries do not allow the exclusion or limitation of liability for consequential or incidental damages, so the above limitations may not apply to you.
- Olympus reserves all rights to this manual.

## Warning

Unauthorized photographing or use of copyrighted material may violate applicable copyright laws. Olympus assumes no responsibility for unauthorized photographing, use or other acts that infringe upon the rights of copyright owners.

## Copyright Notice

All rights reserved. No part of these written materials or this software may be reproduced or used in any form or by any means, electronic or mechanical, including photocopying and recording or the use of any type of information storage and retrieval system, without the prior written permission of Olympus. No liability is assumed with respect to the use of the information contained in these written materials or software, or for damages resulting from the use of the information contained therein. Olympus reserves the right to alter the features and contents of this publication or software without obligation or advance notice.

## FCC Notice

- **Radio and Television Interference**  
Changes or modifications not expressly approved by the manufacturer may void the user's authority to operate this equipment. This equipment has been tested and found to comply with the limits for a Class B digital device, pursuant to Part 15 of the FCC Rules. These limits are designed to provide reasonable protection against harmful interference in a residential installation. This equipment generates, uses, and can radiate radio frequency energy and, if not installed and used in accordance with the instructions, may cause harmful interference to radio communications. However, there is no guarantee that interference will not occur in a particular installation. If this equipment does cause harmful interference to radio or television reception, which can be determined by turning the equipment off and on, the user is encouraged to try to correct the interference by one or more of the following measures:
  - Adjust or relocate the receiving antenna.
  - Increase the distance between the camera and receiver.
  - Connect the equipment to an outlet on a circuit different from that to which the receiver is connected.
  - Consult your dealer or an experienced radio/TV technician for help. Only the OLYMPUS-supplied USB cable should be used to connect the camera to USB enabled personal computers (PC).

Any unauthorized changes or modifications to this equipment would void the user's authority to operate it.

## Use Only Dedicated Rechargeable Battery and Battery Charger

We strongly recommend that you use only the genuine Olympus dedicated rechargeable battery and battery charger with this camera. Using a non-genuine rechargeable battery

and/or battery charger may result in fire or personal injury due to leakage, heating, ignition or damage to the battery. Olympus does not assume any liability for accidents or damage that may result from the use of a battery and/or battery charger that are not genuine Olympus accessories.

## For customers in North and South America

### For customers in USA

Declaration of Conformity

Model Number : E-PL1

Trade Name : OLYMPUS

Responsible Party : **OLYMPUS IMAGING AMERICA INC.**

Address : 3500 Corporate Parkway, P. O. Box 610, Center Valley, PA 18034-0610, USA

Telephone Number : 484-896-5000

Tested To Comply With FCC Standards

FOR HOME OR OFFICE USE

This device complies with Part 15 of the FCC rules. Operation is subject to the following two conditions:

- (1) This device may not cause harmful interference.
- (2) This device must accept any interference received, including interference that may cause undesired operation.

### For customers in Canada

This Class B digital apparatus meets all requirements of the Canadian Interference-Causing Equipment Regulations.

## For customers in Europe



"CE" mark indicates that this product complies with the European requirements for safety, health, environment and customer protection. "CE" mark cameras are intended for sales in Europe.



This symbol [crossed-out wheeled bin WEEE Annex IV] indicates separate collection of waste electrical and electronic equipment in the EU countries. Please do not throw the equipment into the domestic refuse. Please use the return and collection systems available in your country for the disposal of this product.



This symbol [crossed-out wheeled bin Directive 2006/66/EC Annex II] indicates separate collection of waste batteries in the EU countries. Please do not throw the batteries into the domestic refuse. Please use the return and collection systems available in your country for the disposal of the waste batteries.

### Provisions of warranty

- 1 If this product proves to be defective, although it has been used properly (in accordance with the written Handling Care and Operating instructions supplied with it), during the applicable national warranty period and has been purchased from an authorized Olympus distributor within the business area of Olympus Europa Holding GmbH as stipulated on the website: <http://www.olympus.com> this product will be repaired, or at Olympus's option replaced, free of charge. To claim under this warranty the customer must take the product before the end of the applicable national warranty period to the dealer where the product was purchased or any other Olympus service station within the business area of Olympus Europa Holding GmbH as stipulated on the website: <http://www.olympus.com>. During the one year period of the World Wide Guarantee the customer may turn the product in at any Olympus service station. Please notice that not in all countries such Olympus service station exists.

- 2 The customer shall transport the product to the dealer or Olympus authorized service station at his own risk and shall be responsible for any costs incurred in transporting the product.

### Provisions of Guarantee

- 1 "OLYMPUS IMAGING CORP., Shinjuku Monolith, 2-3-1 Nishi-Shinjuku, Shinjuku-ku, Tokyo 163-0914, Japan grants a one year World Wide Guarantee. This worldwide Guarantee must be presented at an Olympus authorized repair service station before any repair can be made under conditions of this Guarantee. This Guarantee is valid only if the Guarantee Certificate and proof of purchase are presented at the Olympus repair service station. Please note that this Guarantee is in addition to and does not affect the customer's legal warranty rights under the applicable national legislation governing the sale of consumer goods mentioned above.
- 2 This Guarantee does not cover the following and the customer will be required to pay repair charge, even for defects occurring within the Guarantee period referred to above.
  - (a) Any defect that occurs due to mishandling (such as an operation performed that is not mentioned in the Handling Care or other sections of the instructions, etc.)
  - (b) Any defect that occurs due to repair, modification, cleaning, etc. performed by anyone other than Olympus or an Olympus authorized service station.
  - (c) Any defect or damage that occurs due to transport, a fall, shock, etc. after purchase of the product.
  - (d) Any defect or damage that occurs due to fire, earthquake, flood damage, thunderbolt, other natural disasters, environmental pollution and irregular voltage sources.
  - (e) Any defect that occurs due to careless or improper storage (such as keeping the product under conditions of high temperature and humidity, near insect repellents such as naphthalene or harmful drugs, etc.), improper maintenance, etc.
  - (f) Any defect that occurs due to exhausted batteries, etc.
  - (g) Any defect that occurs due to sand, mud, etc. entering the inside of the product casing.
  - (h) When the Guarantee Certificate is not returned with the product.
  - (i) When any alterations whatsoever are made to the Guarantee Certificate regarding the year, month and date of purchase, the customer's name, the dealer's name, and the serial number.
  - (j) When proof of purchase is not presented with this Guarantee Certificate.
- 3 This Guarantee applies to the product only; the Guarantee does not apply to any other accessory equipment, such as the case, strap, lens cap and batteries.
- 4 Olympus's sole liability under this Guarantee shall be limited to repairing or replacing the product. Any liability under the Guarantee for indirect or consequential loss or damage of any kind incurred or suffered by the customer due to a defect of the product, and in particular any loss or damage caused to any lenses, films, other equipment or accessories used with the product or for any loss resulting from a delay in repair or loss of data, is excluded. Compelling regulations by law remain unaffected by this.

### Notes regarding Guarantee maintenance

- 1 This Guarantee will only be valid if the Guarantee Certificate is duly completed by Olympus or an authorized dealer or other documents contain sufficient proof. Therefore, please make sure that your name, the name of the dealer, the serial number and the year, month and date of purchase are all completed or the original invoice or the sales receipt (indicating the dealer's name, the date of purchase and product type) is attached to this Guarantee Certificate. Olympus reserves the right to refuse free-of-charge service if neither Guarantee Certificate is completed nor the above document is attached or if the information contained in it is incomplete or illegible.
- 2 Since this Guarantee Certificate will not be re-issued, keep it in a safe place.
  - Please refer to the list on the web site: [http:// www.olympus.com](http://www.olympus.com) for the authorized international Olympus service network.

## Trademarks

---

- IBM is a registered trademark of International Business Machines Corporation.
- Microsoft and Windows are registered trademarks of Microsoft Corporation.
- Macintosh is a trademark of Apple Inc.
- SDHC logo is a trademark.
- "Shadow Adjustment Technology" function contains patented technologies from Apical Limited.
- All other company and product names are registered trademarks and/or trademarks of their respective owners.
- Micro Four Thirds and the Micro Four Thirds logo are trademarks or registered trademarks of OLYMPUS IMAGING Corporation in Japan, the United States, the countries of the European Union, and other countries.
- The standards for camera file systems referred to in this manual are the "Design Rule for Camera File System/DCF" standards stipulated by the Japan Electronics and Information Technology Industries Association (JEITA).



# Index

## Symbols

Shooting Menu 1 .....	106
Shooting Menu 2 .....	106
Playback Menu .....	106
Setup Menu .....	69, 106
Custom Menu .....	71, 107
AF/MF .....	72
BUTTON .....	72
RELEASE .....	73
DISP/PC .....	73
EXP/ISO .....	75
CUSTOM .....	75
COLOR/WB .....	76
RECORD/ERASE .....	77
MOVIE .....	78
UTILITY .....	78
(Large) .....	31
(Middle) .....	31, 77
(Small) .....	31, 77
RC MODE .....	103
(Language selection) .....	69
MENU DISPLAY .....	69, 71
SET HOME .....	72
FUNCTION .....	80
FUNCTION .....	80
HOME .....	80
EYE .....	80
REC .....	80
FACE DETECT .....	32, 74
INFO SETTING .....	74
CONTROL SETTING .....	74
CLOSE UP MODE .....	74
(Beep sound) .....	75
SLOW LIMIT .....	75
X-SYNC .....	75
.....	75
SET .....	76
MODE .....	56
WARNING LEVEL .....	78

## A

























Adding sound to still pictures	65
AE BKT .....	48
AE bracketing .....	48
AE lock .....	47
AEL Metering .....	75
AEL/AFL .....	72, 80
AEL/AFL MEMO .....	72
AF AREA .....	45
AF MODE .....	44, 72
AF target	12, 45
ALL	76
ALL ERASE .....	66
ALL TARGETS	45
ANTI-SHOCK	75
Aperture priority shooting <b>A</b> .....	37
Aperture value .....	12, 37, 39
Art filter mode <b>ART</b> .....	16
ASPECT .....	32, 63
Auto flash .....	54
Auto focus .....	45, 90
Auto white balance .....	42

## B

B (Basic) .....	31
B&W FILTER .....	53
BACKLIT LCD .....	74
Battery .....	3, 6, 96
BEACH & SNOW	17
BGM .....	62
BLACK & WHITE .....	63
BRACKETING .....	48
BULB FOCUSING .....	72
Bulb shooting .....	39
BULB TIMER .....	75
BUTTON TIMER .....	73

## C

C-AF (continuous AF) .....	44
C-AF+TR (AF Tracking) .....	44
Calendar display .....	61

CANDLE 	17	FIRMWARE.....	69
Card.....	4, 95	FL BKT.....	49
CARD SETUP.....	66, 95	Flash.....	54
Center weighted averaging metering 	47	Flash bracketing.....	49
CHILDREN 	17	Flash intensity control 	55
Close-up playback 	14, 60	Flash mode 	54
COLOR SPACE.....	76	Flash off 	54
Color temperature.....	42	Fn FACE DETECT.....	80
Compression rate.....	31	Focus lock.....	46
Continuous AF (C-AF).....	44	FOCUS RING.....	72
CONTRAST.....	53	FORMAT.....	95
CUSTOM 	52	Four Thirds system lenses.....	97
CUSTOM RESET.....	70		
Custom white balance <b>CWB</b> .....	42	<b>G</b>	
		GENTLE SEPIA 	16
<b>D</b>		GRADATION.....	53
Date/time setting 	7	GRAINY FILM 	16
Digital ESP metering 	47		
DIORAMA 	16	<b>H</b>	
Direct print.....	83	HD.....	57
DIS MODE 	17	HDMI.....	67, 73
DOCUMENTS 	17	HIGH KEY 	17, 53
dpi SETTING.....	78	Histogram.....	33, 61
DPOF.....	82	HISTOGRAM SETTING.....	74
Dust reduction.....	6, 93	Home position 	45, 72
<b>E</b>		<b>I</b>	
Easy printing.....	84	iAUTO shooting 	11, 18
Easy shooting modes.....	10	ib.....	88
EDIT FILENAME.....	77	i-ENHANCE 	52
EFFECT.....	53	IMAGE ASPECT.....	32
Electronic view finder.....	100	IMAGE OVERLAY.....	64
e-PORTRAIT 	17, 63	Image size.....	31
ERASE SELECTED.....	66	IMAGE STABILIZER IS.....	50
EV STEP.....	75	Index display 	14, 60
EVF ADJUST.....	74	Information display.....	33, 61
Exposure compensation 	40	<b>IS (Image stabilizer)</b> .....	50
EXPOSURE SHIFT.....	78	ISO.....	41, 75
		ISO BKT.....	49
<b>F</b>		ISO bracketing.....	49
F (Fine).....	31	ISO STEP.....	75
FILE NAME.....	77	ISO-AUTO.....	75
Fill-in flash 	54	ISO-AUTO SET.....	75
FIREWORKS 	17		

<b>J</b>	
JPEG	31
JPEG EDIT	63
<b>L</b>	
LANDSCAPE	17
LANDSCAPE+PORTRAIT	17
Lens	5, 97
Lithium ion battery	3, 96
Lithium ion charger	3, 96
Live control	20
LIVE GUIDE	18
LIVE VIEW BOOST	74
LOW KEY	17, 53
<b>M</b>	
M.ZUIKO DIGITAL interchangeable lens	97
MACRO	17
Manual focus (MF)	44
Manual shooting <b>M</b>	39
METERING	47, 75
MF (manual focus)	44, 80
MF ASSIST	72
Micro Four Thirds system lenses	97
MODE GUIDE	74
Monitor brightness adjustment	69
MONOTONE	52
MOVIE PLAY	58
MOVIE	57, 78
Movie shooting	12, 56
MOVIE+STILL	58, 78
MTP	87
Multi view display	33, 40
MULTIPLE EXPOSURE	51
MUTED	52
MY MODE	80
MY MODE SETUP	73
<b>N</b>	
N (Normal)	31
NATURAL	52
NATURE MACRO	17
NIGHT SCENE	17

NIGHT+PORTRAIT	17
NOISE FILTER	76
NOISE REDUCT.	76
NTSC	67, 73

<b>O</b>	
One-touch white balance	43, 80

<b>P</b>	
PAL	67, 73
PANORAMA	17, 35
PICT. TONE	53
PictBridge	83
PICTURE MODE	52
PIN HOLE	16
PIXEL COUNT	31, 77
PIXEL MAPPING	94
Playback on TV	67
POP ART	16
PORTRAIT	52
PORTRAIT	17
Preset white balance	42
PREVIEW	37
PRINT	84
Print reservation	82
PRIORITY SET	78
Program shift <b>Ps</b>	36
Program shooting <b>P</b>	36
Protecting <b>On</b>	65











<b>Q</b>	
QUICK ERASE	77

<b>R</b>	
RAW	31
RAW DATA EDIT	63
RAW	80
RAW+JPEG ERASE	77
REC VIEW	69
Record mode	31, 57, 105
REDEYE FIX	63
Red-eye reduction flash	54
RESET LENS	72
RESET PROTECT	66
Resizing	63



RLS PRIORITY C .....	73
RLS PRIORITY S .....	73
ROTATE .....	64

## S

S-AF (single AF) .....	44
S-AF+MF .....	44
SATURATION .....	53, 63
Scene mode <b>SCN</b> .....	17
SD .....	57
SD/SDHC card .....	4, 95
Self-timer  .....	30
SEPIA .....	63
Sequential shooting  .....	30
SF (Super Fine) .....	31
SHADING COMP. ....	76
SHADOW ADJ. ....	63
SHARPNESS .....	53
Shutter priority shooting <b>S</b> .....	38
Shutter speed .....	12, 38, 39
Single AF (S-AF) .....	44
SINGLE TARGET [ . ] .....	45
Single-frame erase  .....	15
Single-frame playback .....	59
Single-frame protect .....	65
Single-frame shooting  .....	30
SLEEP .....	74
SLIDE .....	62
Slideshow  .....	62
Slow synchronization (1st curtain) ⚡ SLOW .....	54
Slow synchronization (1st curtain/ Red-eye reduction flash  SLOW .....	54
Slow synchronization (2nd curtain) ⚡ SLOW/2nd CURTAIN .....	54
SOFT FOCUS  .....	16
SPORT  .....	17
Spot metering - highlight control  HI .....	47
Spot metering - shadow control  SH .....	47
Spot metering  .....	47
STORAGE .....	87
Strap .....	2

SUNSET  .....	17
Super control panel .....	81
Super FP flash .....	103

## T

TEST PICTURE .....	80
Trimming  .....	63, 86

## U

USB MODE .....	75
----------------	----

## V

VIDEO OUT .....	73
VIVID  .....	52
VOLUME .....	75

## W

WB .....	41, 76
WB BKT .....	49
WB bracketing .....	49
White balance compensation  .....	42
White balance <b>WB</b> .....	41

## Z

Zoom display .....	34
Zoom frame AF .....	46







<http://www.olympus.com/>

## OLYMPUS IMAGING CORP.

Shinjuku Monolith, 3-1 Nishi-Shinjuku 2-chome, Shinjuku-ku, Tokyo, Japan

## OLYMPUS IMAGING AMERICA INC.

3500 Corporate Parkway, P.O. Box 610, Center Valley, PA 18034-0610, U.S.A. Tel. 484-896-5000

### Technical Support (U.S.A.)

24/7 online automated help: <http://www.olympusamerica.com/DSLR>

Phone customer support: Tel. 1-800-260-1625 (Toll-free)

Our phone customer support is available from 9am to 9pm (Monday to Friday) ET

E-Mail: [e-slrpro@olympus.com](mailto:e-slrpro@olympus.com)

Olympus software updates can be obtained at: <http://www.olympusamerica.com/digital>

To find the nearest Service Centers, please visit: <http://www.olympusamerica.com/digital>, and click on the Worldwide Warranty icon at the bottom of the page.

### Service Centers

#### U.S.A.:

##### California

**Olympus Imaging America Inc.**

10805 Holder Street Suite 170

Cypress, CA 90630-5145

Tel: (800) 260-1625

FAX: (714) 229-1652

##### New York

**Olympus Imaging America Inc.**

400 Rabro Drive

Hauppauge, NY 11788-4258

Tel: (800) 260-1625

FAX: (631) 881-6510

#### Canada:

##### Ontario

**Olympus Canada Inc.**

Consumer Products Group

151 Telson Road

Markham, Ontario Canada L3R 1E7

Tel: (800) 260-1625

Fax: (905) 969-3291

#### Mexico:

**Olympus Imaging de Mexico S.A. de C.V.**

WTC Mexico, Montecito

No.38 - planta baja local 12

Col. Napoles, Mexico D.F. 03810

Tel: (01800) 900-1280/900-1281

## Free Manuals Download Website

<http://myh66.com>

<http://usermanuals.us>

<http://www.somanuals.com>

<http://www.4manuals.cc>

<http://www.manual-lib.com>

<http://www.404manual.com>

<http://www.luxmanual.com>

<http://aubethermostatmanual.com>

Golf course search by state

<http://golfingnear.com>

Email search by domain

<http://emailbydomain.com>

Auto manuals search

<http://auto.somanuals.com>

TV manuals search

<http://tv.somanuals.com>