

DIGITAL CAMERA

OLYMPUS[®]

FE-290/X-825

Instruction Manual

Quick Start Guide

Get started using your camera right away.

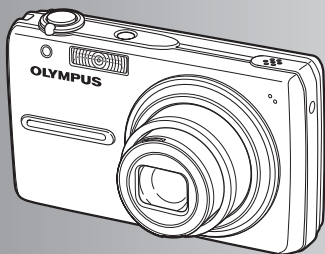

Button operations

Menu operations

Printing pictures

Using OLYMPUS Master

Getting to know your camera better

Appendix

- Thank you for purchasing an Olympus digital camera. Before you start to use your new camera, please read these instructions carefully to enjoy optimum performance and a longer service life. Keep this manual in a safe place for future reference.
- We recommend that you take test shots to get accustomed to your camera before taking important photographs.
- In the interest of continually improving products, Olympus reserves the right to update or modify information contained in this manual.
- The screen and camera illustrations shown in this manual were produced during the development stages and may differ from the actual product.

Download from [Www.Somanuals.com](http://www.Somanuals.com). All Manuals Search And Download.

Quick Start Guide P. 3

Button operations P. 11

Test out the functions of the camera buttons by following along with the illustrations.

Menu operations P. 16

Learn about the menus that control the functions and settings for basic operation.

Printing pictures P. 27

Learn how to print pictures you have taken.

Using OLYMPUS Master P. 33

Learn how to transfer and save pictures to a computer.

Getting to know your camera better P. 40

Find out more about camera operations and how to take better pictures.

Appendix P. 48

Read about convenient functions and safety precautions to use your camera more effectively.

Gather these items (box contents)



Digital Camera



Strap

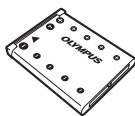

Lithium Ion Battery
(LI-42B)



Battery Charger
(LI-40C)

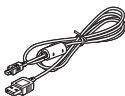

USB Cable

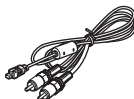

AV Cable



OLYMPUS Master 2
CD-ROM

Items not shown: Instruction Manual (this manual), warranty card. Contents may vary depending on purchase location.

Attach the strap

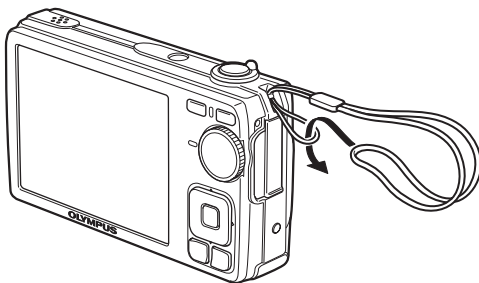

- Pull the strap tight so that it does not come loose.

Prepare the camera

a. Charge the battery.

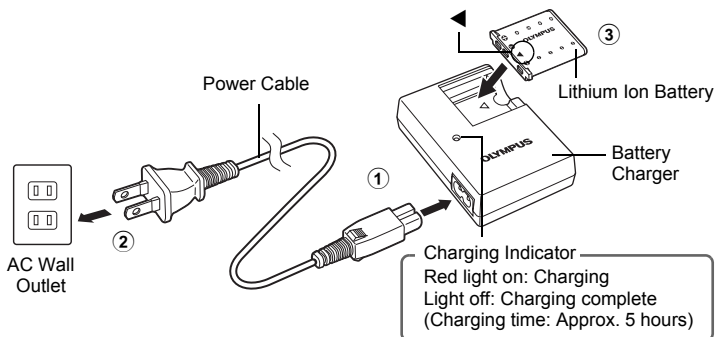

- Battery comes partially charged.

b. Insert the battery and the xD-Picture Card (optional) into the camera.

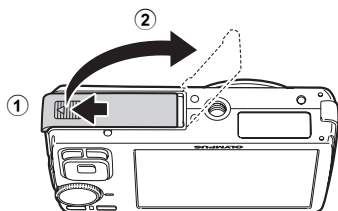

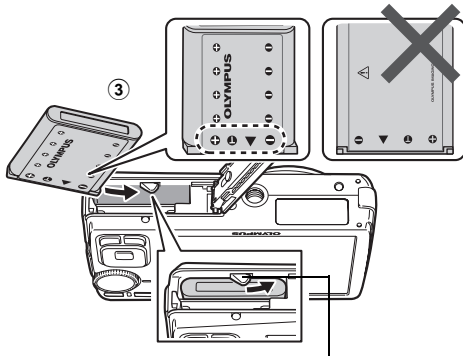

- Insert the battery by putting in the ▼ marked side first, with the + marks toward the end of the camera, the - marks toward the center of the camera.

If you insert the battery incorrectly, you may not be able to remove it. Do not use force. Contact authorized distributors/service centers. Damage to the battery exterior (scratches, etc.) may produce heat or an explosion.

Battery lock knob

- To remove the battery, press the battery lock knob in the direction of the arrow.

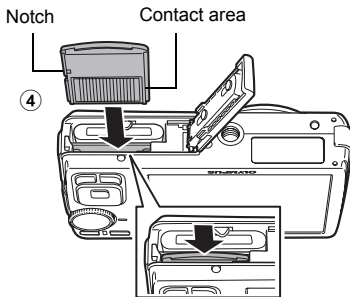

- Orient the card, and insert the card straight in. Insert the card until it clicks into place.

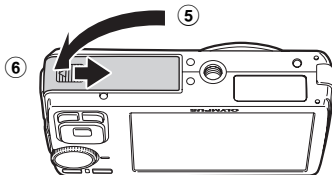

- To remove the card, push the card all the way in, release slowly, grasp the card and remove it.

- With this camera, you can take pictures without inserting the optional xD-Picture Card™ (hereinafter referred to as “the card”). If you take pictures without inserting the card, the pictures will be stored in the internal memory. For details on the card, please refer to “The card” (P. 50).



Turn the camera on

This explains how to turn on the camera in shooting mode.

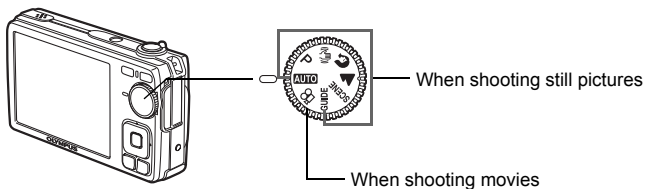
a. Set the mode dial to **AUTO**.



Still picture shooting modes

| | |
|---|--|
| AUTO | The camera determines the optimum settings for shooting pictures. |
| P | The camera automatically sets the optimum aperture value and shutter speed. |
|  | This function reduces the blur incurred by a moving subject, or camera shake when taking pictures. |
|  | Suitable for taking pictures of people. |
|  | Suitable for taking pictures of a landscape. |
| SCENE | Select from 11 available scene modes, according to the shooting conditions. |
| GUIDE | Use the shooting guide displayed on the screen to shoot pictures according to the situation. |

b. Press the **POWER** button.

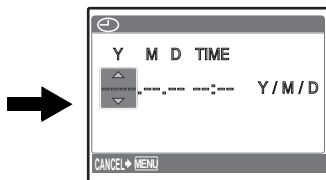
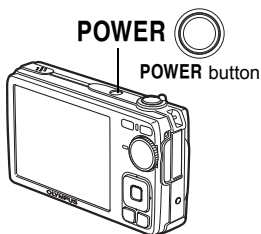

● This screen is displayed if the date and time are not set.

● To turn off the camera, press the **POWER** button once again.

Hint

The directions of the arrow pad is indicated with $\Delta \nabla \leftarrow \rightarrow$ in the supplied instruction manual.

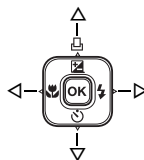

Set the date and time

About the date and time setting screen

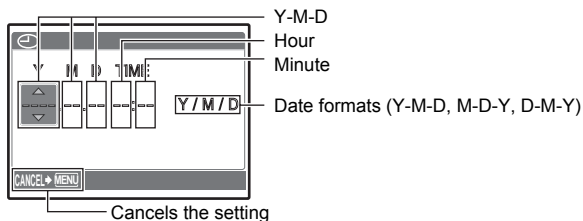

a. Press the and buttons to select [Y].

- The first two digits of the year are fixed.

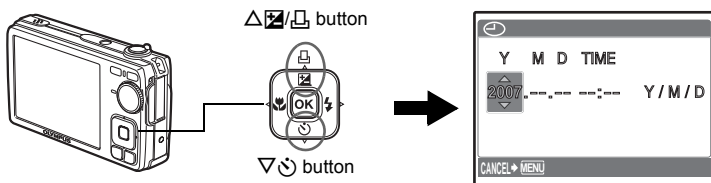

b. Press the button.

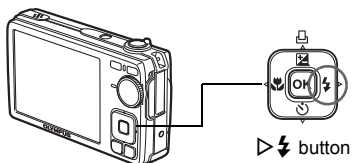

c. Press the and buttons to select [M].

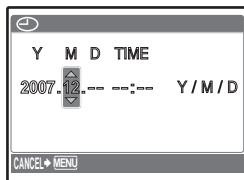

Set the date and time

- d. Press the button.
e. Press the and buttons to select [D].

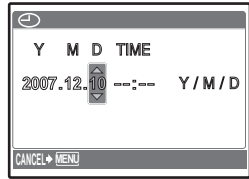

- f. Press the button.
g. Press the and buttons to select the hours and minutes.
• The time is displayed in the 24-hour format.

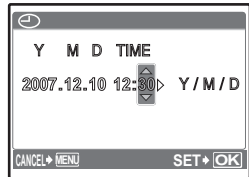

- h. Press the button.
i. Press the and buttons to select [Y/M/D].

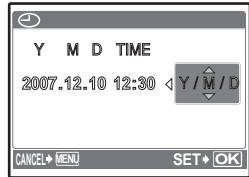

- j. After all settings have been set, press .
• For a more accurate setting, press when the time signal hits 00 seconds.

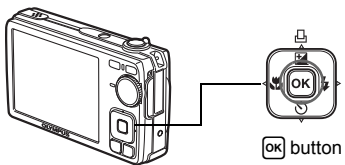

Take a picture

a. Hold the camera.

Horizontal grip

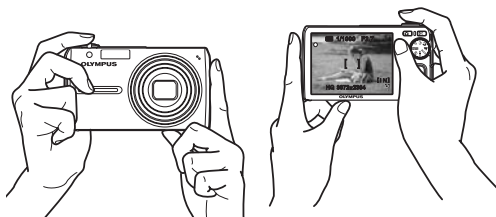

Vertical grip



b. Focus.

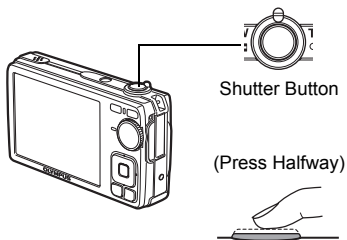

Place this mark over your subject.



The number of pictures that can be taken is displayed.

When the focus and exposure are locked, the green lamp lights up, and the shutter speed and aperture value are displayed.

c. Shoot.

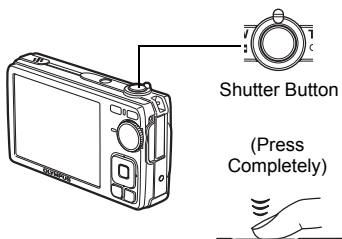

The card access lamp blinks.

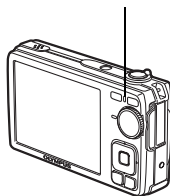

Review your pictures

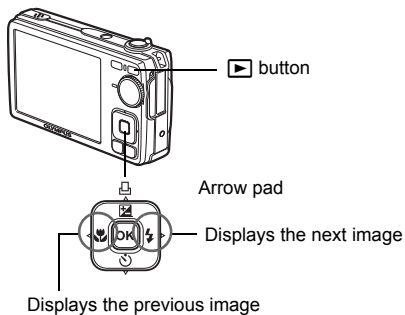

- a. Press the  button.

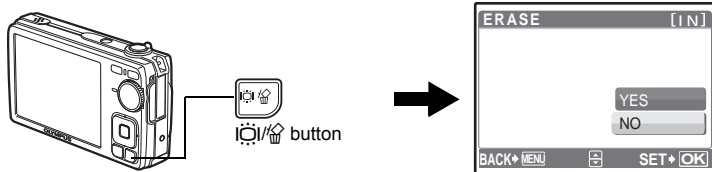

Erase pictures

- a. Press the  and  buttons to display the picture you want to erase.
- b. Press the  button.



- c. Press the  button, select [YES], and press .

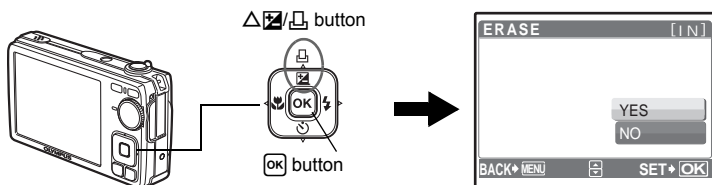

Button operations

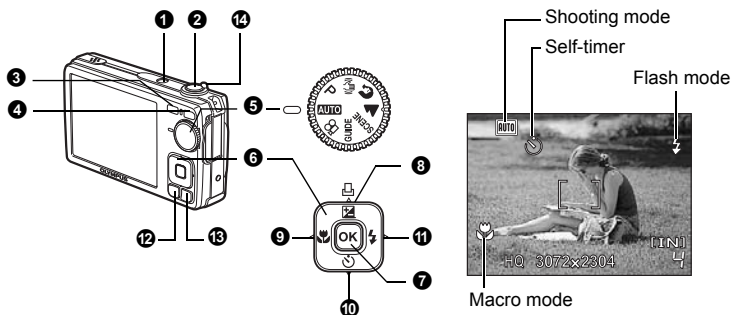

1 POWER button

Turning the camera on and off

Power on: Camera turns on in shooting mode.

- Lens extends
- Monitor turns on

2 Shutter button

Shooting pictures/movies

Shooting still pictures

Set the mode dial to a setting other than and lightly press the shutter button (halfway). The green lamp lights when the focus and exposure are locked (focus lock), and the shutter speed and aperture value are displayed (only when the mode dial is set to **AUTO**, **P**,). Now press the shutter button all the way (completely) to shoot a picture.

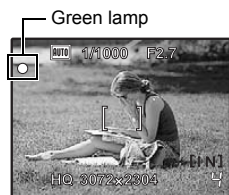

Locking the focus and then composing the shot (focus lock)

Compose your picture with the focus locked, and then completely press the shutter button to shoot a picture.

- When the green lamp blinks, the focus is not adjusted properly. Try locking the focus again.

Recording movies

Set the mode dial to , and lightly press the shutter button to lock the focus, and then press the shutter button completely to start recording. Press the shutter button again to stop recording.

3 button (Shooting)

Selecting shooting mode/Turning the camera on

Shooting mode is selected.

This function is used to set the camera to turn on in shooting mode when is pressed with the camera off.





“/ Turning on the camera with the or button” (P. 25)

4  **button (Playback)****Selecting playback mode/Turning the camera on**

The last picture taken is displayed.

- Press the arrow pad to view other pictures.
- Use the zoom lever to switch between close-up playback and index display.
- Press **[OK]** to delete the information display shown for 3 seconds during single-frame playback.

This function is used to set the camera to turn on in playback mode when  is pressed with the camera off.

 “/ Turning on the camera with the  or  button” (P. 25)

 Movie playback “MOVIE PLAY Playing back movies” (P. 21)

5 **Mode dial****Switching shooting modes**

Set the mode dial to the desired shooting mode.

- Press **[OK]** to delete the mode information display shown for 3 seconds when the mode dial is set to modes other than **SCENE** or **GUIDE**.

AUTO **Shooting pictures with automatic settings**

The camera determines the optimum settings for shooting pictures. [CAMERA MENU] settings such as ISO sensitivity cannot be changed.

P **Set the optimum aperture value and shutter speed**

The camera automatically sets the optimum aperture value and shutter speed for the brightness of the subject. [CAMERA MENU] settings such as ISO sensitivity can be changed.

 **Shooting pictures using digital image stabilization**

This function reduces the blur incurred by a moving subject, or camera shake when taking pictures.

  **Shooting pictures according to the situation**

Use PORTRAIT and LANDSCAPE to shoot pictures with the optimal settings.

SCENE **Shooting pictures by selecting a scene mode according to the situation**

Select from 11 available scene modes, according to the shooting conditions.

Press **[OK]** to set.

 NIGHT+PORTRAIT /  SPORT /  INDOOR /  CANDLE

 SELF PORTRAIT /  SUNSET /  FIREWORKS /  BEHIND GLASS

 CUISINE /  DOCUMENTS /  AUCTION

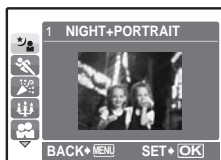

- The scene selection screen displays sample images and the shooting mode to best suit the situation.
- To switch to a different scene mode after a scene mode has been selected, press **MENU** to select [SCENE] from the top menu and display the scene selection screen.
- By switching to another scene, most settings will be changed to the default settings of each scene.

GUIDE Follow the shooting guide for setting

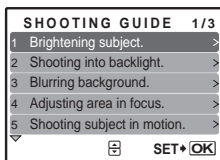

Follow the shooting guide displayed on the screen to set the target items.

- Press **MENU** to display the shooting guide again.
- To change the setting without using the shooting guide, set the shooting mode to another one.
- The content set using the shooting guide will change to the default setting by pressing **MENU** or changing the mode using the mode dial.

Recording movies

Audio is recorded with the movie.

- During audio recording, only the digital zoom can be used. To record the movie with the optical zoom, set [U] (movie) to [OFF].

👉 “U (movie) Recording movies with or without sound” (P. 19)



This lights red during movie recording.

The remaining recording time is displayed. When the remaining recording time reaches 0, recording stops.

6 Arrow pad (Δ ∇ ◀ ▶)

Use the arrow pad to select scenes, items on the menus, and to play back pictures.

7 OK button

This button is used to confirm your selection.

8 Δ [] / [] button

Changing picture brightness (Exposure compensation)/
Printing pictures

Shooting mode: Changing picture brightness

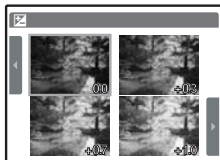

Press Δ [] / [] in shooting mode, choose the preferred brightness with ◀ ▶, and press [OK].



- Adjustable from -2.0 EV to +2.0 EV



Playback mode: Printing pictures

Display a picture to print out in playback mode, connect the camera to the printer, and then press Δ [] / [] to print the picture.

👉 “Direct printing (PictBridge)” (P. 27)

9  **button****Shooting pictures close to the subject (Macro mode)**

Press  in shooting mode to select the macro mode. Press  for setting.

| | | |
|---|-------------|--|
| OFF | Macro off | Cancels macro mode. |
|  | Macro on | This mode lets you shoot from as close as 20 cm/7.9 in. (when the zoom is set for the zoom-out angle) and as close as 35 cm/13.8 in. (when the zoom is set for the zoom-in angle) to your subject. |
|  | Super macro | This mode lets you shoot from as close as 5 cm/2.0 in. to your subject. The zoom position is fixed automatically and cannot be changed. |

10  **button****Self-timer shooting**

Press  in shooting mode to select on or off for the self-timer.

Press  for setting.



| | | |
|---|----------------|------------------------|
| OFF | Self-timer off | Cancel the self-timer. |
|  | Self-timer on | Set the self-timer. |

- After setting the self-timer, press the shutter button completely. Then, the self-timer lamp lights for approximately 10 seconds, blinks for approximately 2 seconds, and the shutter is released.
- To cancel the self-timer, press .
- Self-timer shooting is automatically canceled after one shot.

11  **button****Flash shooting**

Press  in shooting mode to select the flash mode.

Press  for setting.

| | | |
|---|------------|---|
| AUTO | Flash auto | The flash fires automatically in low light or backlight conditions. |
|  | Red-eye | This emits pre-flashes for red-eye reduction. |
|  | Fill-in | The flash fires regardless of the available light. |
|  | Flash off | The flash does not fire. |

12 **MENU** button**Displaying the top menu**

Displays the top menu.

13  **button****Increasing the brightness of the monitor (Backlight boost)/
Erasing pictures**** Increasing the brightness of the monitor (Backlight boost)**

The monitor lights brighter when  is pressed in shooting mode. If there is no operation for 10 seconds, it dims back to the original brightness.

- When [BRIGHT] is selected in , the monitor brightness does not change.

 Erasing pictures

In playback mode, select the picture you want to erase, and press .

- Once erased, pictures cannot be restored. Check each picture before erasing to avoid accidentally erasing pictures you want to keep.

Shooting mode: Zooming in on your subject

Optical zoom: 4×

Digital zoom: 4× (optical zoom × digital zoom: Max. 16×)

Zoom out:

Turn the zoom lever to the W-side.

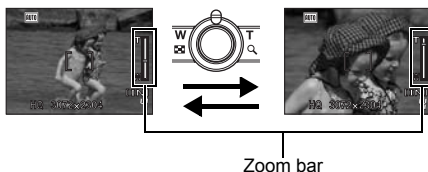
**Zoom in:**

Turn the zoom lever to the T-side.

Zoom bar

The white area is the optical zoom area. The red area is the digital zoom area. When the slider enters the red area, the digital zoom activates and the image is further enlarged.

Playback mode: Switching the picture display**Single-frame playback**

- Use the arrow pad to browse pictures.

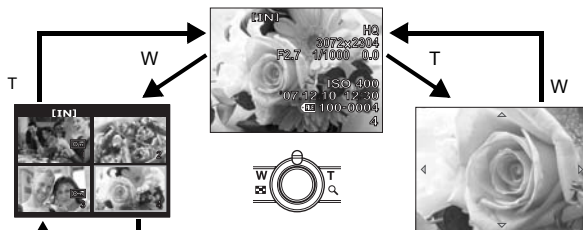
**Index display**

- Use the arrow pad to select a picture for playback, and press **[OK]** to play back the single-frame of the picture selected.

Close-up playback

- Turn and hold the zoom lever to the T-side to incrementally zoom in (up to 10 times the original size), and to the W-side to zoom out.
- Press the arrow pad during close-up playback to scroll the picture in the indicated direction.
- When returning to the single-frame playback, press **[OK]**.

Menu operations

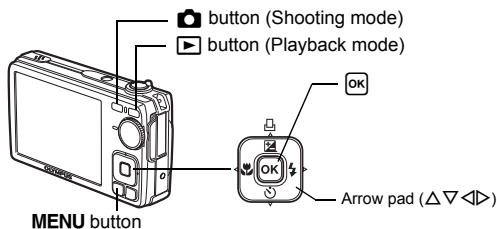

About the menus

Press **MENU** to display the top menu on the monitor.

- The contents displayed on the top menu differ according to the mode.

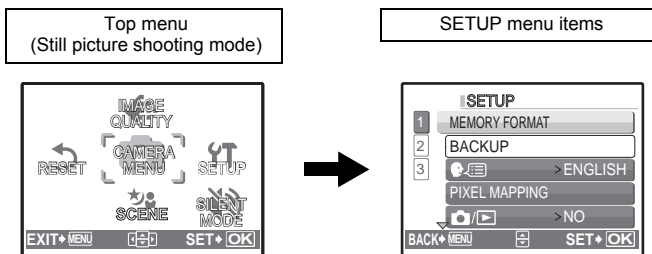

- Select [CAMERA MENU], [PLAYBACK MENU] or [SETUP] and press **OK**. The screen for selecting the menu item is then displayed.
- When the mode dial is set to **GUIDE** and the settings are made by following the shooting guide, press **MENU** to display the shooting guide screen.

Operation guide

During menu operations, the buttons and their respective functions are displayed at the bottom of the screen. Follow these guides to navigate the menus.

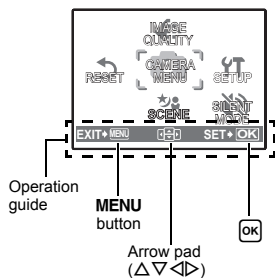

BACK → **MENU** : Moves back one menu.

EXIT → **MENU** : Exits the menu.

Δ ∇ ◀ ▶ : Press the arrow pad (Δ ∇ ◀ ▶) to select an item.

SET → **OK** : Sets the selected item.

Using the menus

This explains how to use the menu with the [●●]) (warning sound) setting as an example.

1 Set the mode dial to a setting other than **GUIDE**.

2 Press **MENU** to display the top menu. Press **▷** to select **[SETUP]**, and press **[OK]**.

- [●●]) is on a menu in [SETUP].

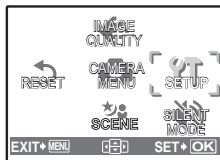

3 Press **△▽** to select **[●●])**, and press **[OK]**.

- Unavailable settings cannot be selected.
- Press **◀** on this screen to move the cursor to the page display. Press **△▽** to change the page. To return to the item selection screen, press **▷** or **[OK]**.

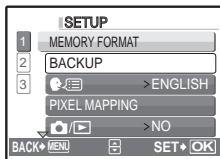

Page display: _____
This mark is displayed when there are more menu items on the next page.

The selected item is displayed in a different color.

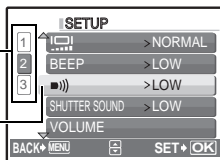

4 Press **△▽** to select **[OFF]**, **[LOW]** or **[HIGH]**, and press **[OK]**.

- The menu item is set and the previous menu is displayed. Press **MENU** repeatedly to exit the menu.
- To cancel any changes and continue operating the menus, press **MENU** without pressing **[OK]**.

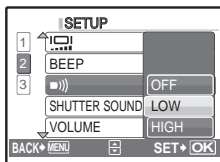

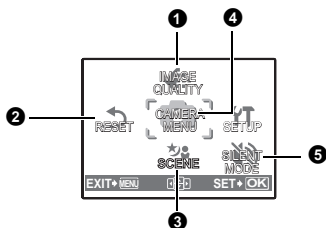

4 CAMERA MENU

ISO
 (still picture)
 (movie)
 PANORAMA*

* An Olympus xD-Picture Card is required.

- Some functions are not available according to the selected mode.
- ☞ “Functions available in shooting modes and scenes” (P. 47)
- ☞ “SETUP menus” (P. 24)
- The factory default settings are displayed in gray ().

1 IMAGE QUALITY

Changing the image quality

Still picture image quality and their applications

| Image quality/Image size | Compression | Application |
|--------------------------|----------------------|--|
| SHQ 3072 × 2304 | Low compression | <ul style="list-style-type: none"> • This is useful for printing large images on full-size paper. |
| HQ 3072 × 2304 | Standard compression | <ul style="list-style-type: none"> • This is useful for performing computer image processing, such as contrast adjustment and red-eye correction. |
| SQ1 2048 × 1536 | Standard compression | <ul style="list-style-type: none"> • This is useful for A4 (11.7×8.5 in./) postcard-size prints. • This is useful for computer editing such as rotating or adding text to a picture. |
| SQ2 640 × 480 | Standard compression | <ul style="list-style-type: none"> • This is useful for sending as e-mail attachments. |
| 16:9 1920 × 1080 | Standard compression | <ul style="list-style-type: none"> • This is useful for expressing the broadness of a subject such as landscapes and for viewing pictures on a wide-screen television. • [PANORAMA] cannot be set. |

Movie image quality







| Image quality/Image size |
|--------------------------|
| SHQ 640 × 480 |
| HQ 320 × 240 |

2 RESET

Changing the shooting functions back to default settings

NO YES Restore shooting functions back to default settings.

Functions for returning the settings to the original when the reset function is executed

| Function | Factory default setting | Ref. Page |
|---|--|-----------|
|  | AUTO | P. 14 |
|  | OFF | P. 14 |
|  | 0.0 | P. 13 |
|  | OFF | P. 14 |
| IMAGE QUALITY | HQ | P. 18 |
| SCENE |  NIGHT+PORTRAIT | P. 12 |
| ISO | AUTO | P. 19 |
|  (still picture) | OFF | P. 19 |
|  (movie) | ON | P. 19 |

3 SCENE (Scene) Shooting pictures by selecting a scene according to the situation

The scene selection screen displays sample images and the shooting mode to best suit the situation. This can be set only when the mode dial is set to **SCENE**.

- By switching to another scene, most settings will be changed to the default settings of each scene.

 “SCENE Shooting pictures by selecting a scene mode according to the situation” (P. 12)

4 CAMERA MENU

ISO **Changing the ISO sensitivity**

| | |
|------------------------|--|
| AUTO | Sensitivity is automatically adjusted according to the conditions of the subject. |
| 64/100/200/400/ 800 | A low value lowers the sensitivity for daylight shooting of clear, sharp pictures. The higher the value, the better the camera's light sensitivity and ability to shoot with a fast shutter speed and in low light conditions. However, high sensitivity introduces noise into the resulting picture, which may give it a grainy appearance. |

 **(still picture)** **Recording sound with still pictures**

OFF ON When activated [ON], the camera will record about 4 seconds of audio after the picture is taken.
When recording, aim the camera microphone at the source of the sound you want to record.

 **(movie)** **Recording movies with or without sound**

OFF ON When [ON] (sound is recorded) is selected, the optical zoom cannot be used during movie recording. Only the digital zoom can be used.

PANORAMA..... Creating a panoramic picture

Panorama shooting lets you create a panoramic picture, using the OLYMPUS Master software on the provided CD-ROM. An Olympus xD-Picture Card is required for panorama shooting.

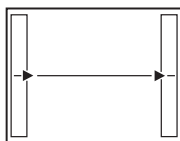

Connects pictures from left to right

- ▷: The next picture is connected at the right edge.
- ◁: The next picture is connected at the left edge.

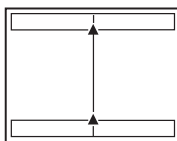

Connects pictures from bottom to top

- △: The next picture is connected at the top.
- ▽: The next picture is connected at the bottom.

Use the arrow pad to specify at which edge you want to connect the pictures; and then compose your shots so that the edges of the pictures overlap. The part of the previous picture where it will be joined to the next picture does not remain in the frame. You have to remember what the part in the frame looked like and take the next picture so it overlaps.



- Press **OK** to exit.
- Panorama shooting is possible for up to 10 pictures. The warning mark (⚠) is displayed after 10 pictures have been taken.

5 SILENT MODE Muting operational sounds

OFF / ON

This function allows you to mute operational sounds during shooting and playback (e.g. warning beeps, shutter sounds, etc.).

Playback mode menu



When a still picture is selected

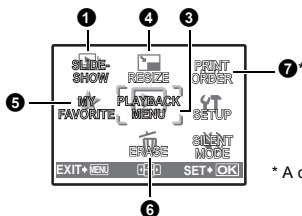

When a movie is selected

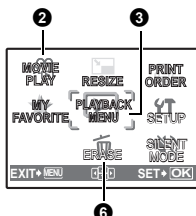

* A card is required.

☞ "SETUP menu" (P. 24)

☞ "SILENT MODE Muting operational sounds" (P. 20)

- The factory default settings are displayed in gray ().

1 SLIDESHOW

Playing back pictures automatically

Press **OK** to start the slideshow.

- Only the first frame of each movie is displayed.
- To cancel the slideshow, press **OK** or **MENU**.

2 MOVIE PLAY

Playing back movies



Select [MOVIE PLAY] from the top menu, and press **OK** to play back the movie. Another option is to select a picture with the movie icon () and press **OK** to play back the movie.

Operations during movie playback



 : Fast forwards playback when pressed and held.

 : Rewinds playback when pressed and held.

Playing time/Total recording time

 : Increases the volume.

 : Reduces the volume.

- Press **OK** to pause the playback.

Operations during pause



 : Plays when pressed and held.

 : Plays the movie in reverse when pressed and held.

 : Displays the first frame.

 : Displays the last frame.

- To resume the movie, press **OK**.
- To cancel the playback of the movie in the middle of it or during pause, press **MENU**.



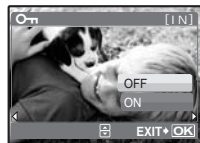

3 PLAYBACK MENU

Off Protecting pictures

OFF / ON



Protected pictures cannot be erased using [ERASE], [SEL. IMAGE] or [ALL ERASE], but they are all erased by formatting.

- Select the picture with , and protect it by selecting [ON] with  . You can protect several frames in succession. When a picture is protected,  will be displayed on the monitor.



Rotating pictures

+90° / 0° / -90°

Pictures taken with the camera held vertically are displayed horizontally. This function lets you turn such pictures so that they are displayed vertically. New picture orientations are saved even when the power is turned off.

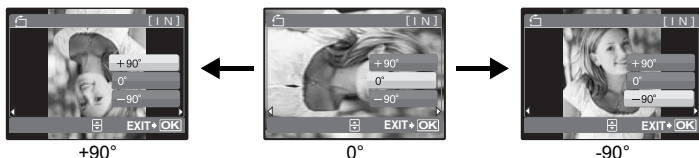

Select a picture with $\leftarrow \rightarrow$, and select [+90°]/[0°]/[-90°] with $\Delta \nabla$ to rotate pictures. You can rotate several frames in succession.



Adding sound to still pictures

YES /NO

Sound is recorded for about 4 seconds.



- Use the arrow pad $\leftarrow \rightarrow$ to select a picture, and select [YES] with $\Delta \nabla$ to begin recording.
- The [BUSY] bar will be temporarily displayed.

4 RESIZE

Changing the size of pictures

640 × 480 /320 × 240

This changes the image size of a picture and saves it as a new file.

5 MY FAVORITE

Viewing and registering pictures in My Favorite

Registers and plays back your favorite still pictures as new ones in the internal memory. Up to 9 pictures can be registered.

- Registered pictures will not be erased even if the internal memory is formatted.

"Erasing pictures registered in MY FAVORITE" (P. 23)



Note

- Registered pictures cannot be edited, printed, copied to a card, transferred to a computer, or viewed on a computer.

VIEW FAVORITE **Viewing registered pictures**

- Select [VIEW FAVORITE] to display pictures registered in MY FAVORITE. Use the arrow pad to browse pictures.
- Press **MENU** to select [ADD FAVORITE] or [SLIDESHOW].

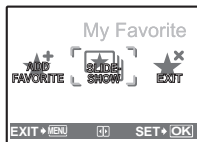

| | |
|--------------|--|
| ADD FAVORITE | Adds pictures to My Favorite. • Select a picture with <D>, and press [OK]. |
| SLIDESHOW | Plays back registered pictures automatically. • Press [OK] to exit the slideshow. |
| EXIT | Reverts to normal playback mode. |

Erasing pictures registered in MY FAVORITE

YES/ NO

- Use the arrow pad to select the picture to be erased, and press . Select [YES], and press [OK].
- Even if pictures registered in MY FAVORITE are erased, original pictures in the internal memory or the card may not be erased.

SET **Registering favorite pictures**

- Select a picture with <D>, and press [OK].

6 ERASE**Erasing selected pictures/Erasing all pictures**

Protected pictures cannot be erased. Cancel protection before erasing protected pictures. Once erased, pictures cannot be restored. Check each picture before erasing to avoid accidentally erasing pictures you want to keep.

- When erasing pictures in the internal memory, do not insert the card into the camera.
- When erasing pictures from the card, insert the card into the camera in advance.

SEL. IMAGE **Erasing by selecting the single-frame**

- Use the arrow pad to select the picture, and press [OK] to mark on your selection.
- To cancel the selection, press [OK] again.
- When the selection is completed, press .
- Select [YES], and press [OK].

ALL ERASE **Erasing all the pictures in the internal memory or on the card**

- Select [YES], and press [OK].

This function allows you to save printing data (the number of prints and the date and time information) with the pictures stored on the card.

☞ "Print settings (DPOF)" (P. 30)

SETUP menus

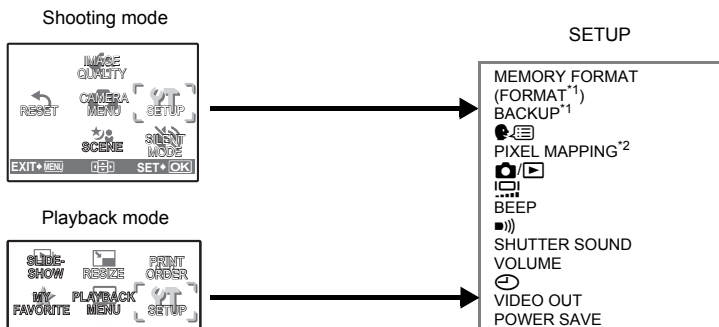

*1 A card is required.

*2 You cannot select this item in playback mode.

MEMORY FORMAT (FORMAT) Formatting the internal memory or card

All existing data, including protected pictures, are erased when the internal memory or card is formatted (images registered to "My Favorite" are not erased). Make sure that you save or transfer important data to a computer before formatting.

- Make sure there is no card inserted in the camera when formatting the internal memory.
- Be sure that the card is inserted in the camera when formatting the card.
- Before using non-Olympus cards or cards which have been formatted on a computer, you must format them with this camera.

BACKUP Copying pictures in the internal memory to the card

Insert the optional card into the camera. Copying data does not erase the picture in the internal memory.

- It takes some time to back up data. Check that the battery is not empty before starting the copy, or use the AC adapter.

☞ Selecting a display language

You can select a language for on-screen display. Available languages vary depending on the area where you purchased this camera.

You can add other languages to your camera with the provided OLYMPUS Master software.

PIXEL MAPPING..... Adjusting the image processing function

The pixel mapping feature allows the camera to check and adjust the CCD and image processing functions. It is not necessary to operate this function frequently. Approximately once a year is recommended. Wait at least one minute after taking or viewing pictures to allow the pixel mapping function to perform properly. If you turn the camera off during pixel mapping, start again.

Select [PIXEL MAPPING]. When [START] is displayed, press **[OK]**.

[CAMERA/PLAY]..... Turning on the camera with the **[CAMERA]** or **[PLAY]** button

YES Pressing **[CAMERA]** turns on the camera and starts the camera in the shooting mode.
Pressing **[PLAY]** turns on the camera and starts the camera in the playback mode.

NO The power is not turned on. To turn on the camera, press **POWER**.

[MONITOR]..... Adjusting the monitor brightness

BRIGHT/ NORMAL

BEEP..... Adjusting the volume of operation sound when the buttons are pressed

OFF (No sound)/ LOW /HIGH

[WARNING]..... Adjusting the volume of camera warning sound

OFF (No sound)/ LOW / HIGH

SHUTTER SOUND..... Adjusting the volume of the shutter button

OFF (No sound)/ LOW / HIGH

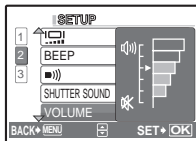
VOLUME..... Adjusting the volume during playback

- Press **△▽** to adjust the volume.
- You can adjust the volume to one of five levels or mute the volume.

..... **Setting the date and time**

The date and time is saved with each image, and is used in the file name. If the date and time are not set, the  screen is displayed each time the camera is turned on.

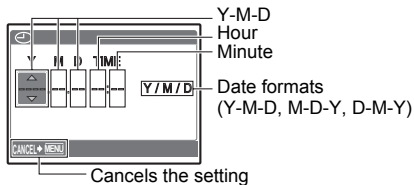

- The first two digits of [Y] are fixed.
- The time is displayed in the 24-hour format.
- To set the time precisely, with the cursor on either "Minute" or "Y/M/D", press **OK** as the time signal strikes 00 seconds.

VIDEO OUT **Playing back pictures on a TV**

NTSC /PAL The factory default settings differ according to the region where the camera is sold.

To play back camera images on a TV, set the video output according to your TV's video signal type.

- TV video signal types differ by country/region. Check the video signal type before connecting the camera to the TV.

NTSC: North America, Taiwan, Korea, Japan

PAL: European countries, China

Playing back pictures on a TV

Turn off the camera and the TV before connecting.

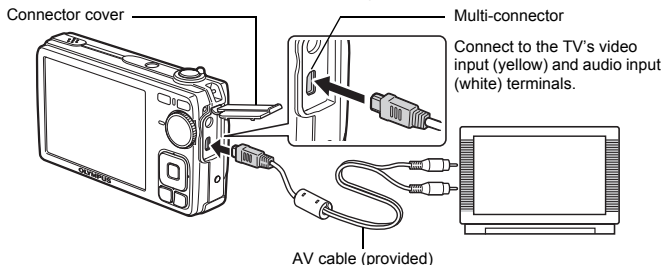

Settings on the camera

Turn the camera on and press  to select the playback mode.

- The last picture taken is displayed on the TV. Use the arrow pad to select the picture you want to display.

Settings on the TV

Turn the TV on, and set it to video input mode.

- For details of switching to video input, refer to your TV's instruction manual.
- Images and the information displayed on the screen may be cropped depending on the TV's settings.

POWER SAVE..... **Setting the camera to the power save mode**

OFF /ON When no operation has been performed for approximately 10 seconds while in shooting mode, the monitor automatically shuts off. Pressing the zoom lever or other buttons restores the camera from power save mode.

Printing pictures

Direct printing (PictBridge)

Using the direct printing function

By connecting the camera to a PictBridge-compatible printer, you can print out pictures directly. Select the pictures you want to print and the number of prints on the camera's monitor.

To find out if your printer is compatible with PictBridge, refer to the printer's instruction manual.

What is PictBridge?

A standard for connecting digital cameras and printers of different makers and printing out pictures directly.

- Available printing modes, paper sizes, etc. vary depending on the printer you use. Refer to the instruction manual for your printer.
- For details of printing paper types, ink cassettes, etc., refer to the printer's instruction manual.

EASY PRINT

[EASY PRINT] can be used to print out the picture displayed on the monitor.

The selected picture is printed using the standard settings of your printer. The date and file name are not printed.

STANDARD

All printers that support PictBridge have standard print settings. If [STANDARD] is selected on the settings screens (P. 29), pictures are printed according to these settings. Refer to the printer's instruction manual for its standard settings or contact the printer manufacturer.

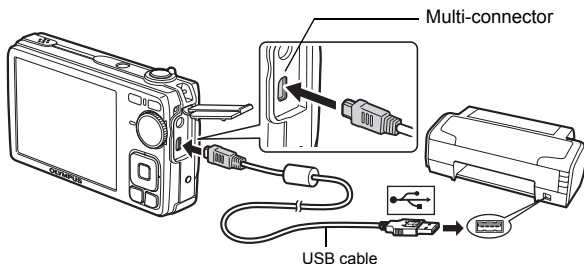

- 1 Display the picture you want to print out on the monitor in playback mode.**
- 2 Turn the printer on and plug the USB cable provided with the camera into the multi-connector of the camera and the printer's USB port.**



- The [EASY PRINT START] screen is displayed.
- For details of how to turn the printer on and the position of the USB port, refer to the printer's instruction manual.

3 Press Δ .

- Printing starts.

- When printing is finished, the picture selection screen is displayed. To print another picture, press \triangleleft \triangleright to select a picture, and press Δ  .
- When you are finished, disconnect the USB cable from the camera with the picture selection screen displayed.

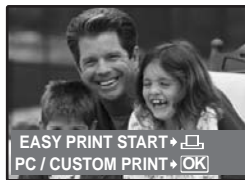

4 Disconnect the USB cable from the camera.

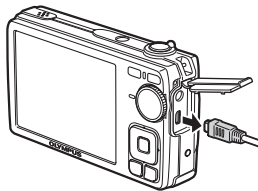

5 Disconnect the USB cable from the printer.

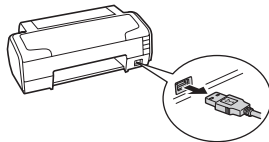



You can use [EASY PRINT] even when the camera is turned off or in shooting mode. With the camera turned off or in shooting mode, connect the USB cable. The selection screen for the USB connection is displayed. Select [EASY PRINT].

 "EASY PRINT" Step 3 (P. 28), "Other print modes and print settings" Step 2 (P. 28)

Other print modes and print settings (CUSTOM PRINT)

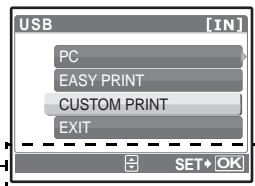
- 1 Display the screen according to Steps 1 and 2 on P. 27, and press .
- 2 Select [CUSTOM PRINT], and press .



Operation guide 

- 3 Make the print settings according to the operation guide.

Selecting a print mode

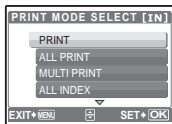

| | |
|--------------------|--|
| PRINT | Prints the selected picture. |
| ALL PRINT | Prints all the pictures stored in the internal memory or on the card. |
| MULTI PRINT | Prints one picture in multiple layout format. |
| ALL INDEX | Prints an index of all the pictures stored in the internal memory or on the card. |
| PRINT ORDER | Prints the pictures according to the print reservation data on the card. If no print reservations have been made, this option is not available. "Print settings (DPOF)" (P. 30) |

Setting the print paper

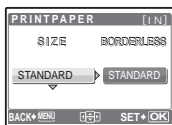

| | |
|---|---|
| SIZE | Choose from the available paper sizes on your printer. |
| BORDERLESS | Select framed or unframed. In [MULTI PRINT] mode, you cannot select the frame. |
| OFF (<input type="checkbox"/>) | The picture is printed inside a blank frame. |
| ON (<input type="checkbox"/>) | The picture is printed filling the entire page. |
| PICS/SHEET | Available in [MULTI PRINT] mode only. The number of prints that can be printed varies depending on the printer. |

! Note

- If the [PRINT PAPER] screen is not displayed, [SIZE], [BORDERLESS] and [PICS/SHEET] are set to [STANDARD].

Selecting the picture to print



| | |
|---------------------|--|
| PRINT | Prints one copy of the displayed picture. When [SINGLE PRINT] or [MORE] has been selected, a single copy or more copies are printed. |
| SINGLE PRINT | Makes a print reservation for the displayed picture. |
| MORE | Sets the number of prints and data to be printed for the displayed picture. |

Press \triangleleft to select the picture you want to print. You can also turn the zoom lever and select a picture from the index display.

Setting the number of prints and data to be printed

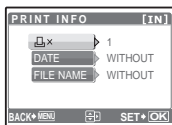

| | |
|--------------------------------|--|
| x | Sets the number of prints. You can select up to 10 prints. |
| DATE (\odot) | If you select [WITH], pictures are printed with the date. |
| FILE NAME (\square) | If you select [WITH], pictures are printed with the file name. |

4 Select [PRINT], and press **OK**.

- Printing starts.
- When printing is finished, the [PRINT MODE SELECT] screen is displayed.

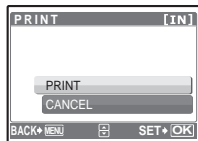

To cancel printing

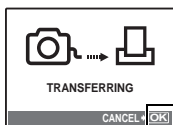

Screen during data transfer

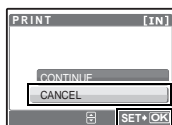

Select [CANCEL], and press **OK**.

5 In the [PRINT MODE SELECT] screen, press **MENU**.

- A message is displayed.

6 Disconnect the USB cable from the camera.

7 Disconnect the USB cable from the printer.

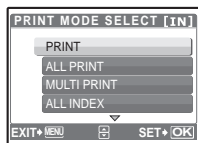

Print settings (DPOF)

How to make print reservations

Print reservations allow you to save printing data (the number of prints and the date and time information) with the pictures stored on the card.

With print reservation, you can print out pictures easily either at home using a personal DPOF-compatible printer or at a photo store that supports DPOF. DPOF is a standard format used to record automatic print information from digital cameras.

Only the images stored on the card can be reserved to print. Insert a card with recorded pictures into the camera before making print reservations.

Pictures with print reservations can be printed using the following procedures:

Printing using a DPOF-compatible photo store

You can print pictures using the print reservation data.

Printing using a DPOF-compatible printer

Printing is possible directly from a card containing print reservation data, without using a computer. For more details, refer to the printer's instruction manual. A PC card adapter may also be necessary.

! Note

- DPOF reservations set by another device cannot be changed by this camera. Make changes using the original device. If a card contains DPOF reservations set by another device, entering reservations using this camera may overwrite the previous reservations.
- You can make DPOF print reservations for up to 999 images per card.
- Not all functions may be available on all printers or at all photo stores.

To use print services without using DPOF

- Pictures stored in the internal memory cannot be printed at a photo store. The pictures need to be copied to a card before taking them.
-  "BACKUP Copying pictures in the internal memory to the card" (P. 24)

Single-frame reservation

Follow the operation guide to make a print reservation for a selected picture.

1 Press **MENU** in the playback mode and display the top menu.

2 Select **[PRINT ORDER]** ▶ , and press **OK**.

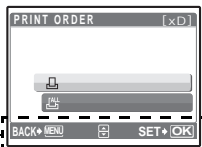

3 Press **<>** to select the frames for print reservations, and then press **△▽** to set the number of prints.

- You cannot make print reservations for pictures with .
- Repeat Step 3 to make print reservations for other pictures.

Operation guide →



4 When you finish making print reservations, press **OK**.

5 Select the date and time setting, and press **OK**.

NO The pictures are printed without the date and time.

DATE The selected pictures are printed with the shooting date.

TIME The selected pictures are printed with the shooting time.

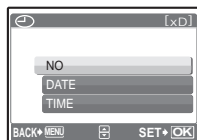

6 Select **[SET]**, and press **OK**.

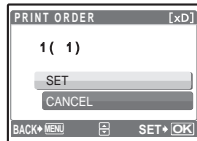

All-frame reservation

Reserves all the pictures stored on the card. The number of prints is set at one print per picture.

- 1 Press **MENU** in the playback mode and display the top menu.
- 2 Select **[PRINT ORDER]** ▶ **[ALL]**, and press **[OK]**.
- 3 Select the date and time setting, and press **[OK]**.
NO The pictures are printed without the date and time.
DATE All pictures are printed with the shooting date.
TIME All pictures are printed with the shooting time.
- 4 Select **[SET]**, and press **[OK]**.

Resetting print reservation data

You can reset all the print reservation data or just for selected pictures.

- 1 Select top menu ▶ **[PRINT ORDER]**, and press **[OK]**.

To reset the print reservation data for all the pictures

- 2 Select **[ALL]** or **[ALL]**, and press **[OK]**.
- 3 Select **[RESET]**, and press **[OK]**.

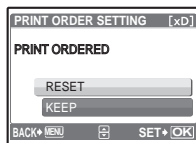

To reset the print reservation data for a selected picture

- 2 Select **[ALL]**, and press **[OK]**.
- 3 Select **[KEEP]**, and press **[OK]**.
- 4 Press **<|>** to select the picture with the print reservations you want to cancel, and press **∇** to decrease the number of prints to 0.
 - Repeat Step 4 to cancel print reservations for other pictures.
- 5 When you are finished canceling print reservations, press **[OK]**.
- 6 Select the date and time setting, and press **[OK]**.
 - The setting is applied to the remaining pictures with print reservations.
- 7 Select **[SET]**, and press **[OK]**.

Using OLYMPUS Master

Overview

Using the USB cable provided with your camera, you can connect the camera and computer and download (transfer) the images to your computer using the OLYMPUS Master software, also provided with the camera.

Prepare the following items before starting.



OLYMPUS Master 2
CD-ROM



USB cable



Computer that fulfills the operating environment (P. 34)

Install the OLYMPUS Master software P. 34



Connect the camera to the computer using the USB cable P. 36



Start up the OLYMPUS Master software P. 36



Download image files to the computer P. 37



Disconnect the camera from the computer P. 37

Using OLYMPUS Master

What is OLYMPUS Master?

OLYMPUS Master is a software application for managing your digital images on your computer. Installing it on your computer lets you do the following:

● **Download images from the camera or other media**

- You can run a slideshow and play back sound.

● **Manage images**

- Manage images in an album or folder.
- Downloaded images are automatically sorted by date, allowing you to search for images quickly.

● **Edit images**

- You can rotate images, trim them and change the size.

● **Edit images with the filter and correction functions**

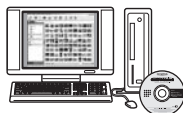

● **Print images**

- You can easily print images.

● **Make panoramic images**

- You can make panoramic images using pictures taken in panorama mode.

● **Update the version of your camera's firmware.**

For details of other functions and operations, refer to the "Help" guide in the OLYMPUS Master reference manual.

Install the OLYMPUS Master software

Before installing the OLYMPUS Master software, please confirm that your computer is compatible with the following system requirements.

For newer operating systems, please refer to the Olympus web site as shown on the back cover of this manual.

Operating environment

Windows

| | |
|--------------------|--|
| OS | Windows 2000 Professional/XP Home Edition/XP Professional/Vista |
| CPU | Pentium III 500 MHz or later |
| RAM | 256 MB or more |
| Hard disk capacity | 500 MB or more |
| Monitor | 1,024 × 768 pixels or more 65,536 colors or more (16.77 million colors or more recommended) |
| Other | USB port or IEEE 1394 port Internet Explorer 6 or later QuickTime 7 or later recommended DirectX 9 or later recommended |

Note

- **Windows 98/98SE/Me are not supported.**
- Use a computer with a pre-installed operating system. Operations are not guaranteed on home-built computers or computers with an updated operating system.
- Operations are not guaranteed when using an added USB port or IEEE 1394 port.
- To install the software, you must log on as a user with administrators' privileges.

Macintosh

| | |
|--------------------|---|
| OS | Mac OS X v10.3 or later |
| CPU | Power PC G3 500 MHz or later Intel Core Solo/Duo 1.5 GHz or later |
| RAM | 256 MB or more |
| Hard disk capacity | 500 MB or more |
| Monitor | 1,024 × 768 pixels or more 32,000 colors or more (16.77 million colors or more recommended) |
| Other | USB port or IEEE 1394 port (FireWire) Safari 1.0 or later (1.3 or later recommended) QuickTime 6 or later |

Note

- **Mac versions earlier than OS X 10.3 are not supported.**
- Operations are not guaranteed when using an added USB or IEEE 1394 (FireWire) port.
- To install the software, you must log on as a user with administrators' privileges.
- Be sure to remove the media (drag & drop onto the trash icon) before performing the following operations. Failure to do so could result in unstable computer operation and the need to reboot.
 - Disconnect the cable connecting the camera to the computer
 - Turn off the camera
 - Open the camera's battery/card compartment cover

Windows

1 Insert the CD-ROM into the CD-ROM drive.

- The OLYMPUS Master setup screen is displayed.
- If the screen is not displayed, double-click the "My Computer" icon and click the CD-ROM icon.

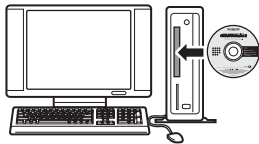

2 Select the display language and click the "OLYMPUS Master 2" button.

- When the component installation screen is displayed, click "OK".



3 Click "Next" and follow the on-screen instructions.

- When the OLYMPUS Master licensing agreement is displayed, read the agreement and click "Yes" to proceed with the installation.

4 When the user information screen is displayed, enter your "Name", select your "Region" and click "Next".



5 When the setup type selection screen is displayed, click "Install".

- To select the components to install, select "Custom".
- The installation begins. The screen confirming that setup is completed is displayed. Click "Close".
- Next, the screen confirming whether to install OLYMPUS muvee theaterPack Trial Version is displayed. To install this software, click "Install".

Macintosh

1 Insert the CD-ROM into the CD-ROM drive.

- The CD-ROM window is displayed.
- If the CD-ROM window is not displayed, double-click the CD-ROM icon on the desktop.

2 Double-click the "Setup" icon on the desktop.

- The OLYMPUS Master installation screen is displayed.
- Follow the on-screen instructions.
- When the OLYMPUS Master licensing agreement is displayed, read the agreement and click "Continue" and then "Continue" to proceed with the installation.
- The screen confirming that installation is completed is displayed.
- You must restart your computer before using OLYMPUS Master.



Connecting the camera to a computer

- 1 Make sure the camera is turned off.**
 - The monitor is off.
 - The lens is retracted.
- 2 Connect the multi-connector on the camera to the USB port on the computer using the provided USB cable.**

- Refer to your computer's instruction manual to locate the position of the USB port.
- The camera turns on automatically.
- The monitor turns on and the selection screen for the USB connection is displayed.

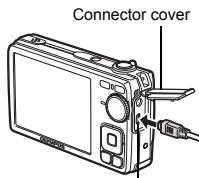

Multi-connector

- 3 Select [PC], and press [OK].**
- 4 The camera is recognized by the computer.**

• Windows

When you connect the camera to your computer for the first time, the computer attempts to recognize the camera. Click "OK" to exit the message that is displayed. The camera is recognized as a "Removable Disk".

• Macintosh

The iPhoto program is the default application for managing digital images. When you connect your digital camera for the first time, the iPhoto application starts automatically, so close this application and start OLYMPUS Master.

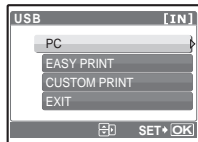

! Note

- The camera functions are disabled while the camera is connected to a computer.
- Connecting the camera to a computer via a USB hub may cause unstable operation. In this case, do not use a hub, but connect the camera directly to the computer.
- Images cannot be transferred to your computer with OLYMPUS Master if [PC] is selected in Step 3, > is pressed and [MTP] is selected.

Start up the OLYMPUS Master software

Windows

- 1 Double-click the "OLYMPUS Master 2" icon  on the desktop.**

Macintosh

- 1 Double-click the "OLYMPUS Master 2" icon  in the "OLYMPUS Master 2" folder.**



- The browse window is displayed.
- When OLYMPUS Master is started up for the first time after installation, the OLYMPUS Master initial setting screen and user registration screen are displayed before the browse window. Follow the on-screen instructions.

To exit OLYMPUS Master

- 1 Click "Exit"  on any window.**
 - OLYMPUS Master is exited.

Displaying camera images on a computer

Downloading and saving images

- 1 Click "Transfer Images"  on the browse window, and then click "From Camera" .**
 - The window for selecting the pictures you want to transfer from the camera is displayed. All the images in the camera are displayed.
- 2 Select "New Album" and enter an album name.**
- 3 Select the image files and click "Transfer Images".**
 - A window indicating that the download is complete is displayed.
- 4 Click "Browse images now".**
 - The downloaded images are displayed in the browse window.



To disconnect the camera

- 1 Make sure that the card access lamp has stopped blinking.**

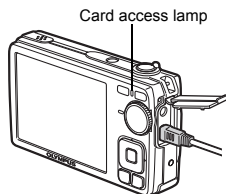

- 2 Make the following preparations for disconnecting the USB cable.**

Windows

- Click the "Unplug or Eject Hardware" icon  in the system tray.
- Click the message that is displayed.
- When a message is displayed saying that the hardware can be ejected safely, click "OK".

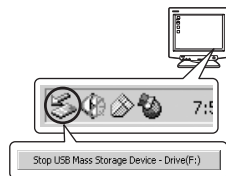

Macintosh

- The trash icon changes to the eject icon when the "Untitled" or "NO_NAME" icon on the desktop is dragged. Drag and drop it on the eject icon.



- 3 Disconnect the USB cable from the camera.**

Note

- Windows: When you click "Unplug or Eject Hardware", a warning message may be displayed. Make sure that image data is not being downloaded from the camera and that all applications are closed. Click the "Unplug or Eject Hardware" icon again and disconnect the cable.

Viewing still pictures and movies

- 1 Click the “Album” tab on the browse window and select the album that you want to view.**
 - The selected album image is displayed in the thumbnail area.
- 2 Double-click the still picture thumbnail that you want to view.**
 - OLYMPUS Master switches to the image edit window and the picture is enlarged.
 - Click “Back”  to return to the browse window.



To view a movie

- 1 Double-click the movie thumbnail that you want to see in the browse window.**
 - OLYMPUS Master switches to the edit window and the first frame of the movie is displayed.
- 2 To play back the movie, click “Play”  at the bottom of the screen.**



To download and save images to a computer without using OLYMPUS Master

This camera is compatible with USB mass storage. You can connect the camera to your computer using the USB cable provided with the camera to download and save images without using OLYMPUS Master. The following environment is required to use the USB cable to connect the camera to your computer.

Windows: Windows 2000 Professional/XP Home Edition/XP Professional/Vista



Macintosh: Mac OS X v10.3 or later

Note

- If your computer is running Windows Vista, you can select [PC] in Step 3 on P. 36, press , and select [MTP] to use Windows Photo Gallery.
- Data transfer is not guaranteed in the following environments, even if your computer is equipped with a USB port.
 - Computers with a USB port added by means of an extension card, etc.
 - Computers without a factory-installed OS and home-built computers

To increase the number of languages

Please take care that your battery is fully charged!

- 1 Make sure that your computer is connected to the Internet.**
- 2 Plug the USB cable into the USB port on the computer.**
- 3 Plug the other end of the USB cable into the camera's USB connector.**
 - The camera turns on automatically.
 - The monitor turns on and the selection screen for the USB connection is displayed.
- 4 Select [PC], and press .**
- 5 In the browse window, select "Camera", then "Update Camera/Add Display Language".**
 - The confirmation window for updating is displayed.
- 6 Click "OK".**
 - The updating the camera window is displayed.
- 7 Click "Add Language" in the updating camera display.**
 - The "Add Display Language of Camera" window is displayed.
- 8 Click  and select a language.**
- 9 Click "Add".**
 - The new language is downloaded to your camera.
Please do not remove any cable or the battery while the camera is processing.
- 10 After the download procedure the camera display will show "OK". You can remove the cables and turn power off. After restarting the camera you will be able to choose the new language from [SET UP].**



Getting to know your camera better

Shooting tips and information

Tips before you start taking pictures

The camera does not turn on even when a battery is loaded

The battery is not charged

- Charge the battery with the charger.

The battery is temporarily unable to function because of the cold

- Battery performance declines in low temperatures, and the charge may not be sufficient to turn on the camera. Remove the battery and warm it by putting it in your pocket for a while.

The card cannot be used

Sometimes when the contact area of the card is dirty, the camera cannot recognize the card, and the [CARD SETUP] screen will be displayed. In this case, select [xD CARD CLEAN] and after pressing **OK**, take out the card, and wipe the contact area with a soft, dry cloth.

No picture is taken when the shutter button is pressed

The camera is in sleep mode

- To save battery power, the camera automatically goes into sleep mode and the monitor turns off if there is no operation for 3 minutes when the camera is turned on. No picture is taken even if the shutter button is fully pressed in this mode. Operate the zoom lever or other buttons to restore the camera from sleep mode before taking a picture. If the camera is left for another 12 minutes, it automatically turns off. Press **POWER** to turn the camera on.

The mode dial is in the position of GUIDE

- No pictures can be taken when the shooting guide is being displayed. Take pictures after selecting the settings by following the shooting guide, or turn the mode dial and set it to a shooting mode other than **GUIDE**.

The flash is charging

- Wait until the  (flash charge) mark stops blinking before taking the picture.

The date and time have not been set

The camera has been used in the same condition from the time of purchase

- No date and time have been set in the camera at the time of purchase. Set the date and time before using the camera.

 "Set the date and time" (P. 7),  "Setting the date and time" (P. 26)

The battery has been removed from the camera

- The date and time settings will be returned to the factory default settings if the camera is left without the battery for approximately 1 day. If the battery is in the camera for a short period of time, the date and time setting will be reset earlier than this. Before taking important pictures, check that the date and time settings are correct.

Shooting tips

Focusing on the subject

There are several ways to focus, depending on the subject.

When the subject is not in the center of the frame

- Place the subject in the center of the frame, lock the focus on the subject, and then recompose your picture.

 "Shutter button Shooting pictures/movies" (P. 11)

The subject is moving quickly

- Focus the camera on a point roughly the same distance away as the subject you want to shoot (by pressing the shutter button halfway); and then recompose your picture and wait for the subject to enter the frame.

Subjects that are difficult to focus on

- Under certain types of conditions, it is difficult to focus using auto focus. The green lamp on the monitor lights, allowing you to check if the focus is locked.

The green lamp blinks.
The subject cannot be brought into focus.



Subject with low contrast



Subject with an extremely bright area in the center of the frame

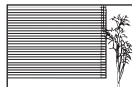

Subject without vertical lines

The green lamp lights,
but the subject cannot be brought into focus.



Subjects at different distances

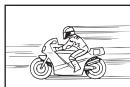

Fast-moving subject



The subject is not in the center of the frame

In these cases, focus (focus lock) on an object with high contrast at the same distance as the intended subject, recompose your shot and then take the picture. If the subject has no vertical lines, hold the camera vertically and focus the camera using the focus lock function by pressing the shutter button halfway, and then return the camera to the horizontal position while keeping the button pressed halfway and take the picture.

Taking pictures without blurring

Hold the camera correctly and press the shutter button gently to shoot the picture. In addition, blurring is reduced when taking pictures in the  mode.

 "Shooting pictures using digital image stabilization" (P. 12)

The factors that can cause the picture to blur are as follows:

- When you zoom at a high magnification to shoot the picture
- When the shutter speed is set low to shoot a dark subject
- When the flash cannot be used or a low shutter speed set shooting mode is selected.

Taking pictures without the flash

The flash fires automatically when insufficient light is available and may cause your image to be blurry.

When taking pictures in low lights without the flash, set the flash mode to  (flash off).

 "Button Flash shooting" (P. 14)

The picture is too grainy

There are several factors that can cause the picture to appear grainy.

Using the digital zoom to take close-up pictures

- With the digital zoom, part of the image is cropped and enlarged. The greater the magnification, the grainier the picture appears.

Increasing the ISO sensitivity

- When you increase the [ISO] setting, "noise", which appears as spots of unwanted color or unevenness in the color, can be introduced and give the picture a grainy appearance. This camera is equipped with a function to allow shooting at high sensitivity while suppressing noise; however, increasing the ISO sensitivity can result in some noise, depending on the shooting conditions.

 "ISO Changing the ISO sensitivity" (P. 19)



Taking pictures with the SCENE mode set to , , or

- When taking pictures of dark subjects using the above scene modes, the picture may appear grainy.



 "SCENE Shooting pictures by selecting a scene mode according to the situation" (P. 12)



Taking pictures of a white beach or snow scene

- Often, bright subjects (such as snow) turn out darker than their natural colors. Adjusting  toward [+] makes the subject closer to their real shades. Conversely, when you are shooting dark subjects, it can be effective to adjust toward [-]. Sometimes, using the flash may not produce the brightness (exposure) that was intended.



 "/  button Changing picture brightness (Exposure compensation)/ Printing pictures" (P. 13)

Taking pictures of a subject against backlight

- Set the flash to  (fill-in) to activate fill-in-flash. You can shoot a subject against backlight without the face of the subject appearing dark.  is effective not only for shooting against backlight, but also for shooting under fluorescent and other artificial lighting.

 ">  button Flash shooting" (P. 14)

- Setting  to [+] is effective when shooting against backlight.

 "/  button Changing picture brightness (Exposure compensation)/ Printing pictures" (P. 13)

Additional shooting tips and information

Increasing the number of pictures that can be taken

There are two ways to record the pictures you take with this camera.

Recording pictures to the internal memory

- Pictures are recorded to the internal memory, and when the number of storable still pictures reaches 0, you connect the camera to a computer to download the pictures; and then erase the pictures from the internal memory.

Using a card (xD-Picture Card) (optional)

- Pictures are recorded to the card when inserted in the camera. When the card is full, you download the pictures to a computer and then either erase the pictures from the card or use a new card.
- Pictures are not recorded to the internal memory when a card is inserted in the camera. Pictures in the internal memory can be copied to the card using the [BACKUP] function.

 "BACKUP Copying pictures in the internal memory to the card" (P. 24)
"The card" (P. 50)

Number of storable still pictures and recording length of movies

Still pictures

| Image quality | Image size | Number of storable still pictures | | | |
|---------------|-------------|-----------------------------------|---------------|-------------------|---------------|
| | | Internal memory | | Using a 1 GB card | |
| | | With sound | Without sound | With sound | Without sound |
| SHQ | 3072 × 2304 | 1 | 1 | 254 | 256 |
| HQ | 3072 × 2304 | 3 | 3 | 503 | 511 |
| SQ1 | 2048 × 1536 | 7 | 7 | 1102 | 1142 |
| SQ2 | 640 × 480 | 31 | 39 | 4568 | 5814 |
| 16:9 | 1920 × 1080 | 8 | 8 | 1230 | 1305 |

Movies

| Image quality | Image size | Length of continuous recordable time | | | |
|---------------|-------------------------------|--------------------------------------|---------------|--------------------|--------------------|
| | | Internal memory | | Using a 1 GB card | |
| | | With sound | Without sound | With sound | Without sound |
| SHQ | 640 × 480 (15 frames/sec.) | 7 sec. | 7 sec. | 17 min. 48 sec. | 18 min. 11 sec. |
| HQ | 320 × 240 (15 frames/sec.) | 18 sec. | 20 sec. | 29 min. | 29 min. |

Using a new card

- If you use a non-Olympus card or a card used for another application, such as a computer, use the [FORMAT] function to format the card.

 "MEMORY FORMAT (FORMAT) Formatting the internal memory or card" (P. 24)

Lamp indicators

This camera uses several lamps to indicate the camera status.

| Lamp | Status |
|---------------------------|---|
| Self-timer lamp | The lamp lights for approximately 10 seconds, blinks for approximately 2 seconds, and then the picture is taken. |
| Card access lamp | Lit (red): Shooting mode Lit (green): Playback mode Unlit: Power is off. Blinking (red): A picture is being recorded, the camera is reading a movie, or images are being downloaded (when connected to a computer). <ul style="list-style-type: none"> Do not do any of the following while the card access lamp is blinking. Doing so may prevent the image data from being saved and render the internal memory or card unusable. <ul style="list-style-type: none"> Open the battery/card compartment cover Remove the battery and card Connect or disconnect the AC adapter |
| Green lamp of the monitor | Lit: The focus and exposure are locked. Blinking: The focus is not locked. <ul style="list-style-type: none"> Release your finger from the shutter button, re-position the AF target mark on the subject and press the shutter button halfway again. |

Extending the useful life of the battery

- Performing any of the following operations when not actually taking pictures can deplete the battery power.
 - Repeatedly pressing the shutter button halfway
 - Repeatedly using the zoom
 - To save battery power, set [POWER SAVE] to [ON], or turn off the camera whenever it is not in use.
-  "POWER SAVE Setting the camera to the power save mode" (P. 26)

Functions that cannot be selected from menus

- Some items may not be selectable from the menus when using the arrow pad.
 - Items that cannot be set with the current shooting mode
 - Items that cannot be set because of an item that has already been set: [S/M] and [L], etc.
- Some functions cannot be used when there is no card in the camera.
 - [PANORAMA]/[PRINT ORDER]/[FORMAT]/[BACKUP]

Selecting the optimal image quality

A record mode expresses a combination of desired image size and compression level. Use the following examples to help determine the optimal image quality when shooting.

To print large images on full-size paper/To edit and process images on a computer

- [SHQ] or [HQ]

To print A4 (11.7×8.5 in./)postcard-size images

- [SQ1]

To send as an e-mail attachment or post on a web site

- [SQ2]

To express the broadness of a subject such as landscapes/To view pictures on a wide-screen television.

- [16:9]

 "IMAGE QUALITY Changing the image quality" (P. 18)

To return the settings of functions to default settings

- To return the changed shooting settings to default settings while shooting, set [RESET] to [YES].
- ☞ "RESET Changing the shooting functions back to default settings" (P. 19)
- All shooting settings except for **P** mode, [IMAGE QUALITY] and the selected scene mode return to default settings when the camera is turned off.

Playback tips

Playing back pictures in the internal memory

- When a card has been inserted in the camera, the pictures in the internal memory cannot be played back. Pull out the card before operating the camera.

Quickly displaying a desired picture

- Press the zoom lever to the W-side to display the pictures as thumbnails (index display).
- ☞ "Zoom lever Zooming while shooting/Close-up playback" (P. 15)

Erasing sound recorded to still pictures

- Once sound is added to a picture, it is not possible to erase the sound. In this case, make a re-recording with silence.
- ☞ "Adding sound to still pictures" (P. 22)

Viewing pictures on a computer

Viewing the entire picture on a computer screen

The size of the picture displayed on a computer screen changes depending on the computer settings. When the monitor setting is 1,024 × 768 and you are using Internet Explorer to view a picture with an image size of 2,048 × 1,536 at 100%; the entire picture cannot be viewed without scrolling. There are several ways you can view the entire picture on the computer screen.



View the picture using image browsing software











- Install the OLYMPUS Master 2 software from the provided CD-ROM.

Change the monitor setting

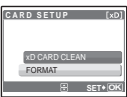
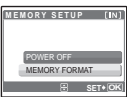
- The icons on the computer desktop may be rearranged. For details of changing the settings on your computer, refer to the computer's instruction manual.

When you get an error message on the camera...















| Monitor indication | Possible cause | Corrective action |
|--|--|---|
|  CARD ERROR | There is a problem with the card. | This card cannot be used. Insert a new card. |
|  WRITE PROTECT | Writing to the card is prohibited. | The recorded image has been protected (read-only) on a computer. Download the image to a computer and cancel the read-only setting. |
|  MEMORY FULL | The internal memory has no available memory and cannot store any new data. | Insert a card or erase unwanted data. Before erasing, backup the data of important pictures using the card or download such pictures to a computer. |

| Monitor indication | Possible cause | Corrective action |
|--|---|--|
|  CARD FULL | The card has no available memory and cannot store any new data. | Replace the card or erase unwanted data. Before erasing, download important pictures to a computer. |
|  NO PICTURE | There are no pictures in the internal memory or on the card. | The internal memory or the card contains no pictures. Record pictures. |
|  PICTURE ERROR | There is a problem with the selected picture and it cannot be played back on this camera. | Use image processing software to view the picture on a computer. If that cannot be done, the image file is damaged. |
|  CARD-COVER OPEN | The battery/card compartment cover is open. | Close the battery/card compartment cover. |
|  BATTERY EMPTY | The battery is empty. | Charge the battery. |
|  | The card is not being recognized by the camera. Or, the card is not formatted. | <ul style="list-style-type: none"> Select [xD CARD CLEAN], and press [OK]. Take out the card and wipe the contact area with a soft, dry cloth. Select [FORMAT] ► [YES] and press [OK]. All data on the card is erased. |
|  | There is an error in the internal memory. | Select [MEMORY FORMAT] ► [YES] and press [OK] . All data in the internal memory is erased. |
|  NO CONNECTION | The camera is not connected to the computer or the printer correctly. | Disconnect the camera and connect it again correctly. |
|  NO PAPER | There is no paper in the printer. | Load some paper into the printer. |
|  NO INK | The printer has run out of ink. | Replace the ink cartridge in the printer. |
|  JAMMED | The paper is jammed. | Remove the jammed paper. |
| SETTINGS CHANGED | The printer's paper tray has been removed or the printer has been operated while changing settings on the camera. | Do not operate the printer while changing settings on the camera. |
|  PRINT ERROR | There is a problem with the printer and/or camera. | Turn off the camera and printer. Check the printer and remedy any problems before turning the power on again. |
|  CANNOT PRINT | Pictures recorded on other cameras may not be printed on this camera. | Use a computer to print. |

Functions available in shooting modes and scenes

Some functions cannot be set in certain shooting modes. For more details, refer to the table below.

Functions available in shooting modes

| Function | Shooting mode | | | | | | SCENE | | | | | | Ref. Page |
|---|---------------|---|---|---|---|---|---|---|---|---|---|-------|-----------|
| | AUTO | P |  |  |  | |  |  |  |  |  | | |
|  | ✓ | ✓ | ✓ | – | ✓ | – | ✓ | ✓ | – | – | *1 | P. 14 | |
| s  | ✓ | ✓ | ✓ | – | ✓ | – | ✓ | ✓ | – | – | – | P. 14 | |
|  | ✓ | ✓ | ✓ | ✓ | ✓ | ✓ | ✓ | ✓ | ✓ | ✓ | ✓ | P. 14 | |
|  | ✓ | ✓ | ✓ | ✓ | – | ✓ | ✓ | – | ✓ | – | – | P. 14 | |
| Zoom | ✓ | ✓ | ✓ | ✓ | ✓ | ✓ | ✓ | ✓ | – | ✓ | ✓ | P. 15 | |
|  | ✓ | ✓ | ✓ | ✓ | ✓ | ✓ | ✓ | ✓ | ✓ | ✓ | ✓ | P. 13 | |
| IMAGE QUALITY | ✓ | ✓ | ✓ | ✓ | ✓ | ✓ | ✓ | ✓ | ✓ | ✓ | *2 | P. 18 | |
| ISO | – | ✓ | – | – | – | – | – | – | – | – | – | P. 19 | |
|  (still picture) | – | – | ✓ | ✓ | – | ✓ | ✓ | ✓ | ✓ | ✓ | – | P. 19 | |
|  (movie) | – | – | – | – | ✓ | – | – | – | – | – | – | P. 19 | |
| PANORAMA | – | ✓ | ✓ | ✓ | – | ✓ | ✓ | ✓ | ✓ | ✓ | – | P. 20 | |

*1 Shooting mode is fixed at .

*2 [IMAGE QUALITY] is fixed at [640 × 480].

Camera care

Cleaning the camera

Exterior:

- Wipe gently with a soft cloth. If the camera is very dirty, soak the cloth in mild soapy water and wring well. Wipe the camera with the damp cloth and then dry it with a dry cloth. If you have used the camera at the beach, use a cloth soaked in clean water and wrung well.

Monitor:

- Wipe gently with a soft cloth.

Lens:

- Blow dust off the lens with a commercial blower, then wipe gently with a lens cleaner.

Battery/Charger:

- Wipe gently with a soft, dry cloth.



Note

- Do not use strong solvents such as benzene or alcohol, or chemically treated cloth.
- Mold may form on the lens surface if the lens is left dirty.

Storage

- When storing the camera for extended periods, remove the battery, AC adapter and card, and keep in a cool, dry place that is well ventilated.
- Periodically, insert the battery and test the camera functions.



Note

- Avoid leaving the camera in places where chemical products are handled since this may result in corrosion.

Battery and charger

- This camera uses one Olympus lithium ion battery (LI-42B/LI-40B). No other type of batteries can be used.
- Power consumption by the camera varies depending on which functions are used.
- During the conditions described below, power is consumed continuously and the battery becomes exhausted quickly.
 - The zoom is used repeatedly.
 - The shutter button is pressed halfway repeatedly in shooting mode, activating the auto focus.
 - A picture is displayed on the monitor for an extended period of time.
 - The camera is connected to a computer or printer.
- Using an exhausted battery may cause the camera to turn off without displaying the battery level warning.
- The rechargeable battery is not fully charged at the time of purchase. Charge the battery fully with the LI-40C charger before use.
- The provided rechargeable battery usually takes approximately 5 hours to charge.
- This camera uses a charger specified by Olympus. Do not use any other type of charger.

Using your charger and AC adapter abroad

- The charger and AC adapter can be used in most home electrical sources within the range of 100 V to 240 V AC (50/60Hz) around the world. However, depending on the country or area you are in, the AC wall outlet may be shaped differently and the charger and AC adapter may require a plug adapter to match the wall outlet. For details, ask at your local electrical shop or travel agent.
- Do not use travel voltage converters as they could damage your charger and AC adapter.

Representative plug of power supply cord of countries/regions around the world



A Type

(American Type)



B Type

(British Type)



BF Type

(British Type)



B3 Type

(British Type)



C Type

(CEE Type)



SE Type

(CEE Type)



O Type

(Oceania Type)

The representative supply voltage and plug type are described in this chart. Depending on the area, different types of plugs and supply voltages are used.

Attention: Power cord meeting demands from each country shall be used.

- For only the United States

Use a UL Listed, 1.8 - 3 m (6 - 10 ft), Type SPT-2 or NISPT-2, AWG no. 18 power supply cord, rated for 125 V 7 A, with a non-polarized NEMA 1-15P plug rated for 125 V 15 A".

Europe

| Countries/Regions | Voltage | Frequency (Hz) | Plug type |
|-------------------|---------|----------------|-----------|
| Austria | 230 | 50 | C |
| Belgium | 230 | 50 | C |
| Czech | 220 | 50 | C |
| Denmark | 230 | 50 | C |
| Finland | 230 | 50 | C |
| France | 230 | 50 | C |
| Germany | 230 | 50 | C |
| Greece | 220 | 50 | C |
| Hungary | 220 | 50 | C |
| Iceland | 230 | 50 | C |
| Ireland | 230 | 50 | C/BF |
| Italy | 220 | 50 | C |
| Luxemburg | 230 | 50 | C |
| Netherlands | 230 | 50 | C |
| Norway | 230 | 50 | C |
| Poland | 220 | 50 | C |
| Portugal | 230 | 50 | C |
| Romania | 220 | 50 | C |
| Russia | 220 | 50 | C |
| Slovak | 220 | 50 | C |
| Spain | 127/230 | 50 | C |
| Sweden | 230 | 50 | C |
| Switzerland | 230 | 50 | C |
| UK | 240 | 50 | BF |

Asia

| Countries/Regions | Voltage | Frequency (Hz) | Plug type |
|-------------------|---------|----------------|-----------|
| China | 220 | 50 | A |
| Hong Kong | 200/220 | 50 | BF |
| India | 230/240 | 50 | C |
| Indonesia | 127/230 | 50 | C |
| Japan | 100 | 50/60 | A |
| Korea (rep) | 220 | 60 | C |
| Malaysia | 240 | 50 | BF |
| Philippines | 220/230 | 60 | A/C |
| Singapore | 230 | 50 | BF |
| Taiwan | 110 | 60 | A |
| Thailand | 220 | 50 | C/BF |
| Vietnam | 220 | 50 | A/C |

Oceania

| Countries/Regions | Voltage | Frequency (Hz) | Plug type |
|-------------------|---------|----------------|-----------|
| Australia | 240 | 50 | O |
| New Zealand | 230/240 | 50 | O |

North America

| Countries/Regions | Voltage | Frequency (Hz) | Plug type |
|-------------------|---------|----------------|-----------|
| Canada | 120 | 60 | A |
| USA | 120 | 60 | A |

Central America

| Countries/Regions | Voltage | Frequency (Hz) | Plug type |
|-------------------|---------|----------------|-----------|
| Bahamas | 120/240 | 60 | A |
| Costa Rica | 110 | 60 | A |
| Cuba | 110/220 | 60 | A/C |
| Dominican (rep) | 110 | 60 | A |
| El Salvador | 110 | 60 | A |
| Guatemala | 120 | 60 | A |
| Honduras | 110 | 60 | A |
| Jamaica | 110 | 50 | A |
| Mexico | 120/127 | 60 | A |
| Nicaragua | 120/240 | 60 | A |
| Panama | 110/220 | 60 | A |

South America

| Countries/Regions | Voltage | Frequency (Hz) | Plug type |
|-------------------|---------|----------------|-----------|
| Argentina | 220 | 50 | C/BF/O |
| Brazil | 127/220 | 60 | A/C |
| Chile | 220 | 50 | C |
| Colombia | 120 | 60 | A |
| Peru | 220 | 60 | A/C |
| Venezuela | 120 | 60 | A |

Middle East

| Countries/Regions | Voltage | Frequency (Hz) | Plug type |
|-------------------|---------|----------------|-----------|
| Iran | 220 | 50 | C/BF |
| Iraq | 220 | 50 | C/BF |
| Israel | 230 | 50 | C |
| Saudi Arabia | 127/220 | 50 | A/C/BF |
| Turkey | 220 | 50 | C |
| UAE | 240 | 50 | C/BF |

Africa

| Countries/Regions | Voltage | Frequency (Hz) | Plug type |
|-------------------|---------|----------------|-----------|
| Algeria | 127/220 | 50 | C |
| Congo (dem) | 220 | 50 | C |
| Egypt | 220 | 50 | C |
| Ethiopia | 220 | 50 | C |
| Kenya | 240 | 50 | C/BF |
| Nigeria | 230 | 50 | C/BF |
| South Africa | 220/230 | 50 | C/BF |
| Tanzania | 230 | 50 | C/BF |
| Tunisia | 220 | 50 | C |

Useful use of the accessories

The card

Pictures can be recorded on the optional card.

The internal memory and card are the camera's media for recording pictures, similar to film in a film camera. Pictures recorded to the internal memory or card can be easily erased on the camera or processed using a computer.

Unlike portable storage media, the internal memory cannot be removed or exchanged.

The number of recordable pictures can be increased by using a card with a larger capacity.

- ① Index area
You can use this space to write the contents of the card.
- ② Contact area
The part where the data transferred from the camera enters the card.
Do not touch this area directly.

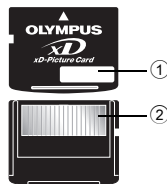

Compatible cards

xD-Picture Card (16MB – 2GB) (Type H/M, Standard)

Using the internal memory or card

You can confirm on the monitor whether the internal memory or card is being used during shooting and playback operations.

Shooting mode



Playback mode

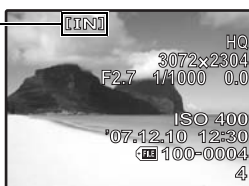

Memory indicator
[IN]: Internal memory
[xD]: Card

! Note

- Do not open the battery/card compartment cover while the card access lamp is blinking, as the lamp is indicating that it is reading or writing data. Doing so may damage the data in the internal memory or the card and render the internal memory or card unusable.

AC adapter

An AC adapter is useful for time-consuming tasks such as image downloads to a computer or when running a slideshow for a long period of time.

Do not use any other AC adapter with this camera.

! Note

- Do not remove or load the battery or connect or disconnect the AC adapter while the camera is on or the camera is connected to the other equipment. Doing so could affect the camera's internal settings or functions.
- Be sure to read the instruction manual for the AC adapter.

SAFETY PRECAUTIONS



CAUTION
RISK OF ELECTRIC SHOCK
DO NOT OPEN



CAUTION: TO REDUCE THE RISK OF ELECTRICAL SHOCK, DO NOT REMOVE COVER (OR BACK). NO USER-SERVICEABLE PARTS INSIDE. REFER SERVICING TO QUALIFIED OLYMPUS SERVICE PERSONNEL.



An exclamation mark enclosed in a triangle alerts you to important operating and maintenance instructions in the documentation provided with the product.



DANGER

If the product is used without observing the information given under this symbol, serious injury or death may result.



WARNING

If the product is used without observing the information given under this symbol, injury or death may result.



CAUTION

If the product is used without observing the information given under this symbol, minor personal injury, damage to the equipment, or loss of valuable data may result.

WARNING!
TO AVOID THE RISK OF FIRE OR ELECTRICAL SHOCK, NEVER DISASSEMBLE, EXPOSE THIS PRODUCT TO WATER OR OPERATE IN A HIGH HUMIDITY ENVIRONMENT.

General Precautions

Read All Instructions — Before you use the product, read all operating instructions. Save all manuals and documentation for future reference.

Cleaning — Always unplug this product from the wall outlet before cleaning. Use only a damp cloth for cleaning. Never use any type of liquid or aerosol cleaner, or any type of organic solvent to clean this product.

Attachments — For your safety, and to avoid damaging the product, use only accessories recommended by Olympus.

Water and Moisture — For precautions on products with weatherproof designs, read the weatherproofing sections.

Location — To avoid damage to the product, mount the product securely on a stable tripod, stand, or bracket.

Power Source — Connect this product only to the power source described on the product label.

Lightning — If a lightning storm occurs while using an AC adapter, remove it from the wall outlet immediately.

Foreign Objects — To avoid personal injury, never insert a metal object into the product.

Heat — Never use or store this product near any heat source such as a radiator, heat register, stove, or any type of equipment or appliance that generates heat, including stereo amplifiers.

Handling the Camera



WARNING

- **Do not use the camera near flammable or explosive gases.**
- **Do not use the flash and LED on people (infants, small children, etc.) at close range.**
 - You must be at least 1 m (3 ft.) away from the faces of your subjects. Firing the flash too close to the subject's eyes could cause a momentary loss of vision.
- **Keep young children and infants away from the camera.**
 - Always use and store the camera out of the reach of young children and infants to prevent the following dangerous situations which could cause serious injury:
 - Becoming entangled in the camera strap, causing strangulation.
 - Accidentally swallowing the battery, cards or other small parts.
 - Accidentally firing the flash into their own eyes or those of another child.
 - Accidentally being injured by the moving parts of the camera.
- **Do not look at the sun or strong lights with the camera.**
- **Do not use or store the camera in dusty or humid places.**
- **Do not cover the flash with a hand while firing.**



CAUTION

- **Stop using the camera immediately if you notice any unusual odors, noise, or smoke around it.**
 - Never remove the batteries with bare hands, which may cause a fire or burn your hands.
- **Never hold or operate the camera with wet hands.**
- **Do not leave the camera in places where it may be subject to extremely high temperatures.**
 - Doing so may cause parts to deteriorate and, in some circumstances, cause the camera to catch fire. Do not use the charger or AC adapter if it is covered (such as a blanket). This could cause overheating, resulting in fire.
- **Handle the camera with care to avoid getting a low-temperature burn.**
 - When the camera contains metal parts, overheating can result in a low-temperature burn. Pay attention to the following:
 - When used for a long period, the camera will get hot. If you hold on to the camera in this state, a low-temperature burn may be caused.
 - In places subject to extremely cold temperatures, the temperature of the camera's body may be lower than the environmental temperature. If possible, wear gloves when handling the camera in cold temperatures.
- **Be careful with the strap.**
 - Be careful with the strap when you carry the camera. It could easily catch on stray objects - and cause serious damage.

Battery Handling Precautions

Follow these important guidelines to prevent batteries from leaking, overheating, burning, exploding, or causing electrical shocks or burns.



DANGER

- The camera uses a lithium ion battery specified by Olympus. Charge the battery with the specified charger. Do not use any other chargers.
- Never heat or incinerate batteries.
- Take precautions when carrying or storing batteries to prevent them from coming into contact with any metal objects such as jewelry, pins, fasteners, etc.

- Never store batteries where they will be exposed to direct sunlight, or subjected to high temperatures in a hot vehicle, near a heat source, etc.
- To prevent causing battery leaks or damaging their terminals, carefully follow all instructions regarding the use of batteries. Never attempt to disassemble a battery or modify it in any way, by soldering, etc.
- If battery fluid gets into your eyes, flush your eyes immediately with clear, cold running water and seek medical attention immediately.
- Always store batteries out of the reach of small children. If a child accidentally swallows a battery, seek medical attention immediately.



WARNING

- Keep batteries dry at all times.
- To prevent batteries from leaking, overheating, or causing a fire or explosion, use only batteries recommended for use with this product.
- Insert the battery carefully as described in the operating instructions.
- If rechargeable batteries have not been recharged within the specified time, stop charging them and do not use them.
- Do not use a battery if it is cracked or broken.
- If a battery leaks, becomes discolored or deformed, or becomes abnormal in any other way during operation, stop using the camera.
- If a battery leaks fluid onto your clothing or skin, remove the clothing and flush the affected area with clean, running cold water immediately. If the fluid burns your skin, seek medical attention immediately.
- Never subject batteries to strong shocks or continuous vibration.



CAUTION

- Before loading, always inspect the battery carefully for leaks, discoloration, warping, or any other abnormality.
- The battery may become hot during prolonged use. To avoid minor burns, do not remove it immediately after using the camera.
- Always unload the battery from the camera before storing the camera for a long period.

Caution for Usage Environment

- To protect the high-precision technology contained in this product, never leave the camera in the places listed below, no matter if in use or storage:
 - Places where temperatures and/or humidity are high or go through extreme changes. Direct sunlight, beaches, locked cars, or near other heat sources (stove, radiator, etc.) or humidifiers.
 - In sandy or dusty environments.
 - Near flammable items or explosives.
 - In wet places, such as bathrooms or in the rain. When using products with weatherproof designs, read their manuals as well.
 - In places prone to strong vibrations.
- Never drop the camera or subject it to severe shocks or vibrations.
- When mounted on a tripod, adjust the position of the camera with the tripod head. Do not twist the camera.
- Do not touch electric contacts on cameras.
- Do not leave the camera pointed directly at the sun. This may cause lens or shutter curtain damage, color failure, ghosting on the CCD, or may possibly cause fires.
- Do not push or pull severely on the lens.
- Before storing the camera for a long period, remove the battery. Select a cool, dry location for storage to prevent condensation or mold from forming inside the camera. After storage, test the camera by turning it on and pressing the shutter release button to make sure that it is operating normally.
- Always observe the operating environment restrictions described in the camera's manual.

Battery Handling Precautions

- This camera uses a lithium ion battery specified by Olympus. Do not use any other type of battery. For safe and proper use, read the battery's instruction manual carefully before using it.
- If the battery's terminals get wet or greasy, camera contact failure may result. Wipe the battery well with a dry cloth before use.
- Always charge a battery when using it for the first time, or if it has not been used for a long period.
- When operating the camera with battery power at low temperatures, try to keep the camera and spare battery as warm as possible. A battery that has run down at low temperatures may be restored after it is warmed at room temperature.
- The number of pictures you can take may vary depending on the shooting conditions or battery.
- Before going on a long trip, and especially before traveling abroad, purchase extra batteries. A recommended battery may be difficult to obtain while traveling.
- Please recycle batteries to help save our planet's resources. When you throw away dead batteries, be sure to cover their terminals and always observe local laws and regulations.

LCD Monitor

- Do not push the monitor forcibly; otherwise the image may become vague, resulting in a playback mode failure or damage to the LCD monitor.
- A strip of light may appear on the top/bottom of the monitor, but this is not a malfunction.
- When a subject is viewed diagonally in the camera, the edges may appear zigzagged on the monitor. This is not a malfunction; it will be less noticeable in playback mode.
- In places subject to low temperatures, the LCD monitor may take a long time to turn on or its color may change temporarily. When using the camera in extremely cold places, it is a good idea to occasionally place it in a warm place. An LCD monitor exhibiting poor performance due to low temperatures will recover in normal temperatures.
- The LCD used for the monitor is made with high-precision technology. However, black spots or bright spots of light may appear constantly on the LCD monitor. Due to its characteristics or the angle at which you are viewing the monitor, the spot may not be uniform in color and brightness. This is not a malfunction.

Legal and Other Notices

- Olympus makes no representations or warranties regarding any damages, or benefit expected by using this unit lawfully, or any request from a third person, which are caused by the inappropriate use of this product.
- Olympus makes no representations or warranties regarding any damages or any benefit expected by using this unit lawfully which are caused by erasing picture data.

Disclaimer of Warranty

- Olympus makes no representations or warranties, either expressed or implied, by or concerning any content of these written materials or software, and in no event shall be liable for any implied warranty of merchantability or fitness for any particular purpose or for any consequential, incidental or indirect damages (including but not limited to damages for loss of business profits, business interruption and loss of business information) arising from the use or inability to use these written materials or software or equipment. Some countries do not allow the exclusion or limitation of liability for consequential or incidental damages, so the above limitations may not apply to you.
- Olympus reserves all rights to this manual.

Warning

Unauthorized photographing or use of copyrighted material may violate applicable copyright laws. Olympus assumes no responsibility for unauthorized photographing, use or other acts that infringe upon the rights of copyright owners.

Copyright Notice

All rights reserved. No part of these written materials or this software may be reproduced or used in any form or by any means, electronic or mechanical, including photocopying and recording or the use of any type of information storage and retrieval system, without the prior written permission of Olympus. No liability is assumed with respect to the use of the information contained in these written materials or software, or for damages resulting from the use of the information contained therein. Olympus reserves the right to alter the features and contents of this publication or software without obligation or advance notice.

FCC Notice

• Radio and Television Interference

Changes or modifications not expressly approved by the manufacturer may void the user's authority to operate this equipment. This equipment has been tested and found to comply with the limits for a Class B digital device, pursuant to Part 15 of the FCC Rules. These limits are designed to provide reasonable protection against harmful interference in a residential installation. This equipment generates, uses, and can radiate radio frequency energy and, if not installed and used in accordance with the instructions, may cause harmful interference to radio communications.

However, there is no guarantee that interference will not occur in a particular installation. If this equipment does cause harmful interference to radio or television reception, which can be determined by turning the equipment off and on, the user is encouraged to try to correct the interference by one or more of the following measures:

- Adjust or relocate the receiving antenna.
- Increase the distance between the camera and receiver.
- Connect the equipment to an outlet on a circuit different from that to which the receiver is connected.
- Consult your dealer or an experienced radio/TV technician for help. Only the OLYMPUS-supplied USB cable should be used to connect the camera to USB enabled personal computers (PC).

Any unauthorized changes or modifications to this equipment would void the user's authority to operate it.

For customers in North and South America

For customers in USA

Declaration of Conformity

Model Number : FE-290/X-825

Trade Name : OLYMPUS

Responsible Party : OLYMPUS IMAGING AMERICA INC.

Address : 3500 Corporate Parkway, P.O. Box 610, Center Valley,
PA 18034-0610, U.S.A.

Telephone Number : 484-896-5000

Tested To Comply With FCC Standards

FOR HOME OR OFFICE USE

This device complies with Part 15 of the FCC rules. Operation is subject to the following two conditions:

(1) This device may not cause harmful interference.

(2) This device must accept any interference received, including interference that may cause undesired operation.

For customers in Canada

This Class B digital apparatus meets all requirements of the Canadian Interference-Causing Equipment Regulations.

Trademarks

- IBM is a registered trademark of International Business Machines Corporation.
- Microsoft and Windows are registered trademarks of Microsoft Corporation.
- Macintosh is a trademark of Apple Inc.
- xD-Picture Card™ is a trademark.
- All other company and product names are registered trademarks and/or trademarks of their respective owners.
- The standards for camera file systems referred to in this manual are the "Design Rule for Camera File System/DCF" standards stipulated by the Japan Electronics and Information Technology Industries Association (JEITA).

SPECIFICATIONS

● Camera

| | |
|----------------------------|---|
| Product type | : Digital camera (for shooting and displaying) |
| Recording system | |
| Still pictures | : Digital recording, JPEG (in accordance with Design rule for Camera File system (DCF)) |
| Applicable standards | : Exif 2.2, Digital Print Order Format (DPOF), PRINT Image Matching III, PictBridge |
| Sound with still pictures | : Wave format |
| Movies | : AVI Motion JPEG |
| Memory | : Internal memory xD-Picture Card (16 MB – 2 GB) (Type H/M, Standard) |
| Number of effective pixels | : 7,100,000 pixels |
| Image pickup device | : 1/2.5" CCD (primary color filter), 7,400,000 pixels (gross) |
| Lens | : Olympus lens 4.55 to 18.2 mm, f2.7 to 5.4 (equivalent to 28 to 112 mm on a 35 mm camera) |
| Photometric system | : Center-weighted metering |
| Shutter speed | : 1 to 1/2000 sec. |
| Shooting range | : 0.4 m (1.3 ft.) to ∞ (W), 0.6 m (2.0 ft.) to ∞ (T) (normal) 0.2 m (0.7 ft.) to ∞ (W), 0.35 m (1.1 ft.) to ∞ (T) (macro mode) 0.05 m (0.2 ft.) to ∞ (super macro mode) |
| Monitor | : 3.0" TFT color LCD display, 230,000 pixels |
| Outer connector | : DC-IN jack, USB connector, A/V OUT jack (multi-connector) |
| Automatic calendar system | : 2000 up to 2099 |
| Operating environment | |
| Temperature | : 0°C to 40°C (32°F to 104°F) (operation)/ -20°C to 60°C (-4°F to 140°F) (storage) |
| Humidity | : 30% to 90% (operation)/10% to 90% (storage) |
| Power supply | : One Olympus lithium ion battery (LI-42B/LI-40B) or specified AC adapter |
| Dimensions | : 97.7 mm (W) × 55.7 mm (H) × 26.5 mm (D) (3.8 × 2.2 × 1.0 in.) (excluding protrusions) |
| Weight | : 142 g (5.0 oz) without battery and card |

● **Lithium ion battery (LI-42B)**

| | |
|-----------------------|---|
| Product type | : Lithium ion rechargeable battery |
| Standard voltage | : DC 3.7 V |
| Standard capacity | : 740 mAh |
| Battery life | : Approx. 300 full charges (varies on usage) |
| Operating environment | |
| Temperature | : 0°C to 40°C (32°F to 104°F) (charging)/ -10°C to 60°C (14°F to 140°F) (operation)/ -20°C to 35°C (-4°F to 95°F) (storage) |
| Dimensions | : 31.5 × 39.5 × 6 mm (1.2 × 1.5 × 0.2 in.) |
| Weight | : Approx. 15 g (0.5 oz) |

● **Battery charger (LI-40C)**

| | |
|-----------------------|---|
| Power requirements | : AC 100 to 240 V (50 to 60 Hz) 3.2 VA (100 V) to 5.0 VA (240 V) |
| Output | : DC 4.2 V, 200 mA |
| Charging time | : Approx. 5 hours |
| Operating environment | |
| Temperature | : 0°C to 40°C (32°F to 104°F) (operation)/ -20°C to 60°C (-4°F to 140°F) (storage) |
| Dimensions | : 62 × 23 × 90 mm (2.4 × 0.9 × 3.5 in.) |
| Weight | : Approx. 65 g (2.3 oz) |

Design and specifications subject to change without notice.

Names of Parts

Camera

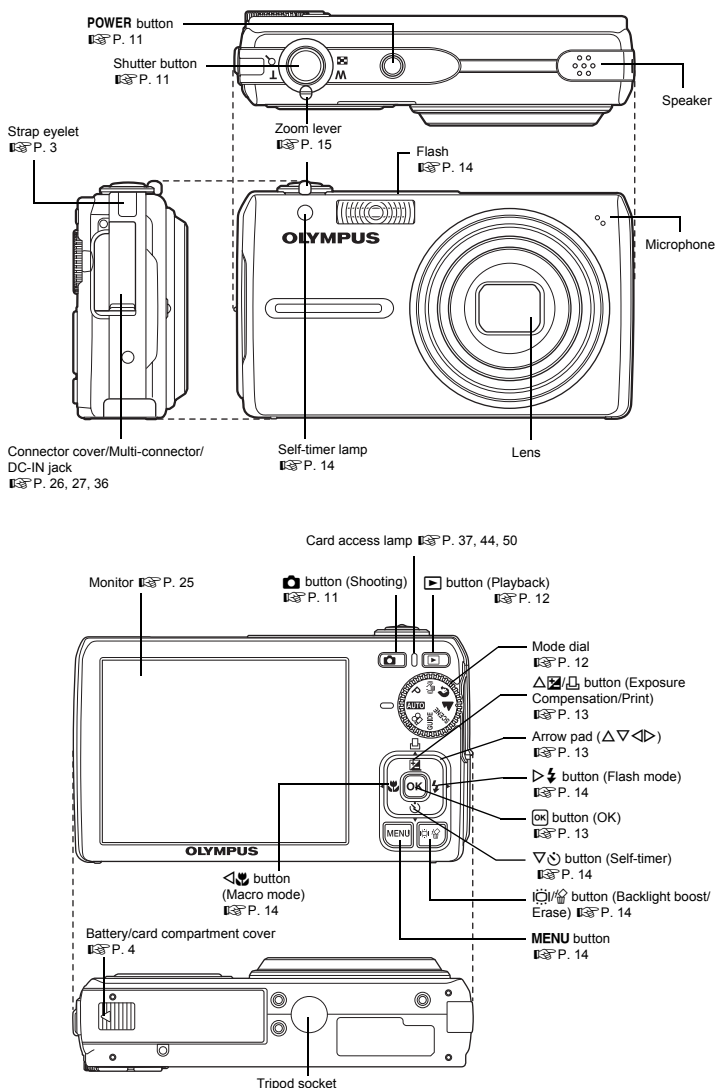

Monitor Symbols & Icons

● Shooting Mode

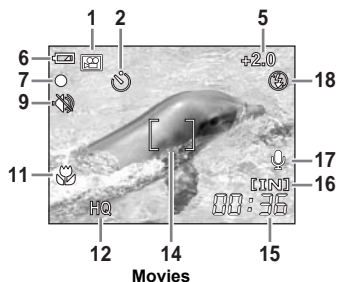
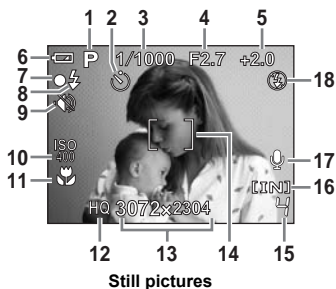

| Item | Indications | Ref. Page |
|---|--|---------------|
| 1 Shooting mode | Auto , P , etc. | P. 11 |
| 2 Self-timer | | P. 14 |
| 3 Shutter speed | 1 – 1/2000 | P. 9 |
| 4 Aperture value | F2.7, etc. | P. 9 |
| 5 Exposure compensation | -2.0 – +2.0 | P. 13 |
| 6 Battery check | = full power, = charge the battery | – |
| 7 Green lamp | ○ = Auto Focus Lock | P. 9, 11 |
| 8 Flash standby Camera movement warning/flash charge | (Lit) (Blinks) | P. 40 |
| 9 Silent mode | | P. 20 |
| 10 ISO | ISO100, ISO400, etc. | P. 19 |
| 11 Macro mode Super macro mode | | P. 14 |
| 12 Image quality | SHQ, HQ, SQ1, SQ2, 16:9 | P. 18 |
| 13 Image size | 3072 × 2304, 2048 × 1536, 640 × 480 etc. | P. 18 |
| 14 AF target mark | [] | P. 9 |
| 15 Number of storable still pictures Remaining recording time | 4 00:36 | P. 9 P. 13 |
| 16 Current memory | [IN] (Recording pictures to the internal memory), [xD] (Recording pictures to the card) | P. 50 |
| 17 Sound record | | P. 19 |
| 18 Flash mode | | P. 14 |

● Playback Mode

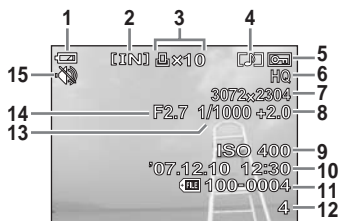

Still pictures



Movies

| | Item | Indications | Ref. Page |
|----|---|--|----------------|
| 1 | Battery check | = full power, = charge the battery | - |
| 2 | Current memory | [IN] (Playing back the picture in the internal memory), [xD] (Playing back the picture in the card) | P. 50 |
| 3 | Print reservation/Number of prints Movie | ×10 | P. 30 P. 21 |
| 4 | Sound record | | P. 19 |
| 5 | Protect | | P. 21 |
| 6 | Image quality | SHQ, HQ, SQ1, SQ2, 16:9 | P. 18 |
| 7 | Image size | 3072 × 2304, 2048 × 1536, 640 × 480 etc. | P. 18 |
| 8 | Exposure compensation | -2.0 – +2.0 | P. 13 |
| 9 | ISO | ISO100, ISO400, etc. | P. 19 |
| 10 | Date and time | '07.12.10 12:30 | P. 26 |
| 11 | File number | 100-0004 | - |
| 12 | Number of frames Elapsed time/Total recording time | 4 00:00/00:36 | - P. 21 |
| 13 | Shutter speed | 1 – 1/2000 | P. 9 |
| 14 | Aperture value | F2.7, etc. | P. 9 |
| 15 | Silent mode | | P. 20 |

Index

| | |
|---|--------|
| | 25 |
| AUTO (AUTO)..... | 6, 12 |
| button (backlight boost/erase)... | 10, 14 |
| button (flash mode)..... | 14 |
| button (macro)..... | 14 |
| OK button (OK)..... | 13, 16 |
| button (Playback mode)..... | 10, 12 |
| button (exposure compensation/print)..... | 13, 28 |
| button (self-timer)..... | 14 |
| button (Shooting mode)..... | 11 |
| (D IMAGE STABILIZATION)..... | 6, 12 |
| (LANDSCAPE)..... | 6, 12 |
| (MOVIE)..... | 11, 13 |
| (movie)..... | 19 |
| (PORTRAIT)..... | 6, 12 |
| (still picture)..... | 19 |
| 16:9..... | 18 |

A

| | |
|------------------------------|-----------|
| ALL ERASE..... | 23 |
| ALL INDEX..... | 29 |
| ALL PRINT..... | 29 |
| All-frame reservation | 32 |
| Aperture value..... | 9, 11 |
| Arrow pad ()..... | 6, 13, 16 |
| AUCTION | 12 |
| AUTO (ISO)..... | 19 |
| Auto flash AUTO | 14 |
| Auto focus..... | 41 |
| AV cable..... | 3, 26 |

B

| | |
|----------------------|-------|
| BACKUP..... | 24 |
| Battery..... | 4, 48 |
| Battery charger..... | 4, 48 |
| Battery check..... | 60 |
| BEEP..... | 25 |
| BEHIND GLASS | 12 |

C

| | |
|-----------------------|------------|
| CAMERA MENU..... | 19 |
| CANDLE | 12 |
| Card..... | 43, 50 |
| Card access lamp..... | 37, 44, 50 |
| Close-up playback | 15 |
| Compression..... | 18 |
| Connector cover..... | 26, 36 |
| CUISINE | 12 |
| CUSTOM PRINT..... | 28 |

D

| | |
|----------------------|-----------|
| Date and time | 7, 26, 40 |
| Digital zoom..... | 13, 15 |
| Direct printing..... | 27 |
| DOCUMENTS | 12 |
| DPOF..... | 30 |

E

| | |
|-----------------|----|
| EASY PRINT..... | 27 |
|-----------------|----|

| | |
|-----------------------|--------|
| ERASE..... | 10, 23 |
| Error messages..... | 45 |
| Exposure compensation | 42 |

F

| | |
|-------------------|---------------|
| File name..... | 26, 29 |
| Fill-in flash | 14 |
| FIREWORKS | 12 |
| Flash..... | 14 |
| Flash charge..... | 40 |
| Flash mode | 14 |
| Flash off | 14 |
| Focus..... | 9, 11, 41, 44 |
| Focus lock..... | 11 |
| Format..... | 24 |
| FORMAT..... | 24 |

G

| | |
|------------------------------------|---------------|
| Green lamp..... | 9, 11, 41, 44 |
| GUIDE (Shooting guide)..... | 6, 13 |

H

| | |
|---------|----|
| HQ..... | 18 |
|---------|----|

I

| | |
|----------------------|----------------|
| IMAGE QUALITY..... | 18, 44 |
| Image size..... | 18 |
| Index display | 15 |
| INDOOR | 12 |
| Internal memory..... | 24, 43, 45, 50 |
| ISO..... | 19 |

L

| | |
|--------------------------|------------|
| Lens..... | 11, 48, 59 |
| Lithium ion battery..... | 3, 4 |
| Low compression..... | 18 |

M





| | |
|-------------------------------|------------|
| Macro mode | 14 |
| MEMORY FORMAT..... | 24 |
| MENU button..... | 14, 16 |
| Menu..... | 16, 17 |
| Microphone..... | 19, 59 |
| Mode dial..... | 6, 12 |
| Monitor..... | 11, 25, 60 |
| Monitor brightness adjustment | 25 |
| MOVIE PLAY..... | 21 |
| MULTI PRINT..... | 29 |
| Multi-connector..... | 26, 27, 36 |
| MY FAVORITE..... | 22 |

N





| | |
|--|----|
| NTSC..... | 26 |
| Number of storable still pictures..... | 43 |

O









| | |
|----------------------|--------|
| OLYMPUS Master..... | 33, 36 |
| Operation guide..... | 16, 28 |
| Optical zoom..... | 13, 15 |

| | |
|---|----------------|
| P | |
| PAL | 6 |
| PANORAMA | 26 |
| PANORAMA | 20 |
| PC | 33, 36 |
| PictBridge | 27 |
| Picture rotation  | 22 |
| PIXEL MAPPING | 25 |
| Playback mode  | 10, 12, 15, 61 |
| Playback mode menu  | 20 |
| Playback on a TV | 26 |
| Playing time/Total recording time | 21 |
| POWER SAVE | 26 |
| POWER button | 6, 11 |
| Press completely | 9 |
| Press halfway | 9 |
| PRINT ORDER | 29 |
| PRINT ORDER  | 24 |
| Print settings | 30 |
| Printing pictures | 27 |
| Protect  | 21 |

R

| | |
|---|--------|
| Recording movies with or without sound  | 19 |
| Recording  | 22 |
| Recording sound with still pictures  | 19 |
| Red-eye reduction flash  | 14 |
| Remaining recording time | 43 |
| RESET | 19, 45 |
| RESIZE | 22 |

S

| | |
|---|----------------|
| SCENE (Scene) | 6, 12, 19 |
| SEL. IMAGE | 23 |
| Selecting a language  | 24 |
| SELF PORTRAIT  | 12 |
| Self-timer lamp | 14, 44 |
| Self-timer  | 14 |
| SETUP menu | 24 |
| Shooting mode | 11, 15, 47, 60 |
| Shooting movies  | 11, 13 |
| Shooting still pictures | 11 |
| SHQ | 18 |
| Shutter button | 9, 11 |
| SHUTTER SOUND | 25 |
| Shutter speed | 9, 11 |
| SILENT MODE  | 19, 20 |
| Single-frame playback | 15 |
| Single-frame reservation  | 31 |
| Sleep mode | 40 |
| SLIDESHOW | 21, 23 |
| Speaker | 59 |
| SPORT  | 12 |
| SQ1 | 18 |
| SQ2 | 18 |
| STANDARD | 27 |
| Standard compression | 18 |
| Strap | 3 |
| SUNSET  | 12 |
| Super macro mode  | 14 |

T

| | |
|----------------------------|----|
| Top menu | 16 |
| Tripod socket | 59 |

U

| | |
|------------------------|---------------|
| USB cable | 3, 27, 33, 37 |
|------------------------|---------------|

V

| | |
|------------------------|--------|
| VIDEO OUT | 26 |
| VOLUME | 21, 25 |

W

| | |
|--|----|
| Warning sound  | 25 |
|--|----|

X

| | |
|------------------------------|--------|
| xD-Picture Card | 20, 50 |
|------------------------------|--------|

Z

| | |
|-------------------------|----|
| Zoom | 15 |
| Zoom lever | 15 |

Memo

Memo

Memo

Memo

OLYMPUS®

<http://www.olympusamerica.com/>

OLYMPUS IMAGING AMERICA INC.

3500 Corporate Parkway, P.O. Box 610, Center Valley, PA 18034-0610, U.S.A. Tel. 484-896-5000

Technical Support (USA)

24/7 online automated help: <http://www.olympusamerica.com/support>
Phone customer support: Tel. 1-888-553-4448 (Toll-free)

Our phone customer support is available from 8 am to 10 pm (Monday to Friday) ET
<http://www.olympusamerica.com/contactus>

Olympus software updates can be obtained at: <http://www.olympusamerica.com/digital>
To find the nearest Service Centers, please visit: <http://www.olympusamerica.com/digital>,
and click on the Worldwide Warranty icon at the bottom of the page.

Service Centers

U.S.A.:

California Olympus Imaging America Inc.
10805 Holder Street Suite 170
Cypress, CA 90630-5145
Tel: (888) 553-4448

New York Olympus Imaging America Inc.
400 Rabro Drive
Hauppauge, NY 11788-4258
Tel: (888) 553-4448

Canada: Olympus Canada Inc.
Consumer Products Group
151 Telson Road
Markham, Ontario Canada L3R 1E7
Tel. (888)553-4448

Mexico: Olympus Imaging de Mexico S.A. de C.V.
WTC Mexico,
Montecito No.38 - Lobby - Office 3
Col. Napolés, Mexico D.F. 03810
Tel. (01800)800-2128
E-mail: oimx@olympus.com

Argentina: Jesus Labrador
Paraguay 755 PB, C1057AAI - Buenos Aires
Tel: (011) 4313-3174 Fax: (011) 4312-5239
E-Mail: olympus@jesuslabrador.com.ar

Jesus Labrador
Bartolome Mitrte 860
C1036AAP - Buenos Aires
Tel: (011) 4331-1227 Fax: (011) 4331-1247
E-mail: service@basr.com.ar

Brazil:

Rio de Janeiro Assistec
Rua Uruguiana, 94-Sobrelaja
Centro-Rio de Janeiro CEP 20050-091
Tel: (021) 2242-3236 Fax: (021) 2242-3236
E-Mail: rio@assistec.com.br

Sao Paulo Assistec
Rua Avanhandava 126, 3 Andar
Consolação, São Paulo
Tel: (011) 3123-3100 Fax: (011) 3214-0706
E-mail: ASSISTECSS@UOL.COM.BR

Assistec
Filial Shopping Eldorado
Av. Rebouças 3970, 1 Subsolo, Loja 1035
Pinheiros, Sao Paulo
Tel: (011) 3815-3054 Fax: (011) 3814-4398
E-mail: ASSISTECSS@UOL.COM.BR

Chile: REIFSCHEIDER S.A.
Camino El Conquistador del Monte 5024
Huechuraba, Santiago
Tel: 56-2-6781200 Fax: 56-2-6781202
E-mail : olympus@reifschneider.cl,
serviciotecnico@reifschneider.cl

Colombia: CV Tronica LTDA
Calle 68 No 12-57, Bogota
Tel: (0571)235-7260/348-1573
Fax: (0571) 348-1574
E-mail: servicio@cvtronica.com
CV Tronica LTDA
Cra 9 No 23-49 Local 215 C.C Intercentro, Bogota
Tel: (0571)284-4365

CV Tronica LTDA
Av. Cra 15 No 105A-22 Piso 2 Local 5, Bogota
Tel: (0571)637-3540

Panama: FOTOSER
Edif. El Paical, Oficina No3, P.A.
Urb. Herbruger, Transistmica
(Detras del S/M Riba Smith),
Tel/Fax: (507) 261-0436
E-mail: rearanda@rocketmail.com

Uruguay: Fotocamara S.R.L.
Rondeau 1470 Montevideo
Tel: (02) 900-2004 Fax: (02) 900-8430
E-mail: FOTOCAM@ADINET.COM.UY

Venezuela: Micron C.A.
4ta. transversal Urb. Horizonte,
Edificio América, Mezanine, Caracas 1070-A
Tel: (0212) 238-3526 Fax: (0212) 239-8598
E-mail: serviciotecnico@micron.com.ve

Free Manuals Download Website

<http://myh66.com>

<http://usermanuals.us>

<http://www.somanuals.com>

<http://www.4manuals.cc>

<http://www.manual-lib.com>

<http://www.404manual.com>

<http://www.luxmanual.com>

<http://aubethermostatmanual.com>

Golf course search by state

<http://golfingnear.com>

Email search by domain

<http://emailbydomain.com>

Auto manuals search

<http://auto.somanuals.com>

TV manuals search

<http://tv.somanuals.com>