

oppo®

DVD PLAYER

DV-983H

USER MANUAL

READ CAREFULLY
BEFORE OPERATION

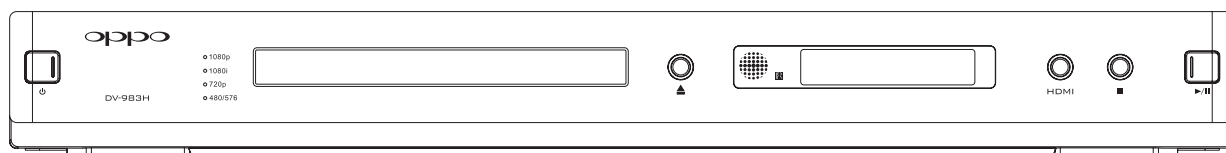

Table of Contents

Important Information	1
Important Safety Instructions	2
Additional Safety Instructions	2
Cautions.....	3
FCC Statement	3
Copyright Protection	4
Trademarks	4
Compatible Disc Types	4
INSTALLATION	5
Front Panel Controls	5
Front Panel Display Window	5
Rear Panel Connectors	6
Remote Control	7
Battery Installation	8
Using the Remote Control	8
Making the Video Connection.....	9
HDMI Connection.....	9
DVI Connection.....	10
Component Video Connection	11
Connecting to an Audio System	12
Connecting to a Receiver/Amplifier with HDMI Input/Output	12
Connecting to a Receiver/Amplifier with 7.1ch Audio Input	13
Connecting to a Receiver/Amplifier with 5.1ch Audio Input	14
Connecting to a Receiver/Amplifier with Dolby Digital or DTS Decoder.....	15
Connecting to a Stereo or Surround Audio System.....	16
Custom Installation Options	17
Infrared Remote (IR) Installation.....	17
RS232 Control	17
Setting Up the Player - Initial Setup.....	18
Use the Setup Menu System	18
Determine Your Display Type.....	20
Select the Best Output Resolution.....	21
Set up Audio Options.....	23
BASIC OPERATIONS	26
Disc Playback	26
DVD Menu Playback	26
Pause Playback	27
OSD (On-Screen Display).....	27

Volume Control	28
Mute.....	28
Audio Language/Channel Selection	29
Subtitle Selection	29
Angle Selection.....	30
ADVANCED OPERATIONS	31
TV System Selection	31
Zooming and Aspect Ratio Control	31
Zoom Levels for HDMI Output	31
Zoom Levels for Component Video Output.....	34
Fast Playback.....	35
Slow Playback.....	35
Repeat, Random and Shuffle Playback.....	35
Repeat the Selected Section	36
Playback by Track Number	37
CD discs.....	37
SACD discs.....	37
Playback from a Specific Location	37
DVD discs	37
CD discs.....	38
Bookmarks	39
Memory and Automatic Resume	39
Viewing Static Pictures on DVD-Audio Discs	40
Disc Information Browser.....	40
Playing Digital Video, Audio and Picture Files	41
Digital Music Play Operations	42
Digital Picture Play Operations	42
Playing a Disc with Both Digital Audio and Picture Files	43
Use of USB Device	43
Audio-Only Mode	44
Customized Background Screen	44
SETUP MENU OPTIONS.....	45
General Setup Page	45
Speaker Setup Page	48
Audio Setup Page.....	52
Video Setup Page.....	55
Preference Page.....	58
REFERENCES	60
Useful Notes.....	60
Troubleshooting	60

Specifications.....	61
Language Code List	62
LIMITED WARRANTY	63
OPPO Digital, Inc. Limited One Year Warranty	63

Important Information



CAUTION:

TO PREVENT ELECTRICAL SHOCK, DO NOT REMOVE THE COVER. NO USER-SERVICEABLE PARTS INSIDE. REFER SERVICING TO QUALIFIED SERVICE PERSONNEL.

WARNING:

TO PREVENT DAMAGE WHICH MAY RESULT IN FIRE OR SHOCK HAZARD, DO NOT EXPOSE THIS APPLIANCE TO RAIN OR MOISTURE.



The lightning flash with arrowhead symbol, within an equilateral triangle, is intended to alert the user to the presence of uninsulated "dangerous voltage" within the product's enclosure that may be of sufficient magnitude to constitute a risk of electric shock to persons.



The exclamation point within an equilateral triangle is intended to alert the user to the presence of important operation and maintenance (servicing) instruction in the literature accompanying the appliance.

WARNING: TO REDUCE THE RISK OF FIRE OR ELECTRIC SHOCK, DO NOT EXPOSE THIS APPLIANCE TO RAIN OR MOISTURE. DANGEROUS HIGH VOLTAGES ARE PRESENT INSIDE THE ENCLOSURE. DO NOT OPEN THE CABINET. REFER SERVICING TO QUALIFIED PERSONNEL ONLY.

WARNING: THE APPARATUS SHALL NOT BE EXPOSED TO DRIPPING OR SPLASHING AND THAT NO OBJECTS FILLED WITH LIQUIDS, SUCH AS VASES SHALL BE PLACED ON THE APPARATUS.



CAUTION: TO PREVENT ELECTRIC SHOCK, MATCH WIDE BLADE OF PLUG TO WIDE SLOT, FULLY INSERT.

CAUTION: THESE SERVICING INSTRUCTIONS ARE FOR USE BY QUALIFIED SERVICE PERSONNEL ONLY. TO REDUCE THE RISK OF ELECTRIC SHOCK DO NOT PERFORM ANY SERVICING OTHER THAN THAT CONTAINED IN THE OPERATING INSTRUCTIONS UNLESS YOU ARE QUALIFIED TO DO SO.

CAUTION: DANGER OF EXPLOSION IF BATTERY IS INCORRECTLY REPLACED. REPLACE ONLY WITH THE SAME OR EQUIVALENT TYPE.

CAUTION: THIS PRODUCT UTILIZES A LASER. USE OF CONTROLS OR ADJUSTMENTS OR PERFORMANCE OF PROCEDURES OTHER THAN THOSE SPECIFIED HEREIN MAY RESULT IN HAZARDOUS RADIATION EXPOSURE. DO NOT OPEN COVERS AND DO NOT REPAIR YOURSELF. REFER SERVICING TO QUALIFIED PERSONNEL.

Important Safety Instructions

- 1) Read these instructions.
- 2) Keep these instructions.
- 3) Heed all warnings.
- 4) Follow all instructions.
- 5) Do not use this apparatus near water.
- 6) Clean only with dry cloth.
- 7) Do not block any ventilation openings. Install in accordance with the manufacturer's instructions.
- 8) Do not install near any heat sources such as radiators, heat registers, stoves, or other apparatus (including amplifiers) that produce heat.
- 9) Do not defeat the safety purpose of the polarized or grounding-type plug. A polarized plug has two blades with one wider than the other. A grounding type plug has two blades and a third grounding prong. The wide blade or the third prong is provided for your safety. If the provided plug does not fit into your outlet, consult an electrician for replacement of the obsolete outlet.
- 10) Protect the power cord from being walked on or pinched, particularly at plug, receptacle, and the point where it exits from the apparatus.
- 11) Only use attachments/accessories specified by the manufacturer.
- 12) Use only with the cart, stand, tripod, bracket, or table specified by the manufacturer, or sold with the apparatus. When a cart is used, use caution when moving the cart/apparatus combination to avoid injury from tip-over.
- 13) Unplug this apparatus during lightning storms or when unused for long periods of time.
- 14) Refer all servicing to qualified service personnel. Servicing is required when the apparatus has been damaged in any way, such as power-supply cord or plug is damaged, liquid has been spilled or objects have fallen into the apparatus, the apparatus has been exposed to rain or moisture, does not operate normally, or has been dropped.



Additional Safety Instructions

- 1) Before connecting the AC power cord to the appliance, make sure the voltage designation of the appliance corresponds to the local electrical supply. If you are unsure of your power supply, ask your local power company.
- 2) To avoid electric shock, never touch the inside components. Only a qualified technician should open the case of the product.
- 3) Do not use this product if power cord is damaged. Do not hang any object on the power cord and do not install the power cord at places where people walk.
- 4) Please hold the power plug when unplugging power. Do not hold the power cord.
- 5) Please do not unplug the power plug when this unit is working well. Turn off the unit before unplugging.
- 6) If this unit is damaged, do not service it yourself and you should contact professional maintenance personnel.
- 7) Please use equipped accessories to ensure proper operation of the product and reduce incidents.
- 8) Please unplug the power cord if you are not going to use the product for a long period.
- 9) High temperature will lead to abnormal operation of this unit. Do not expose this unit and batteries to direct sunlight or near other heating objects.
- 10) To ensure the good ventilation around this product, please do not place this product on a sofa, bed or rug. When installing this product on a wall or bookshelf, you need to leave appropriate space.
- 11) Do not expose this unit in rain or near humid places such as kitchen and swimming pool to avoid electric shock or fire. Prevent this unit from dripping or splashing. Do not place objects full of liquid such as vases on the unit.
- 12) Do not place this product on unstable cart, stand, tripod, bracket and table. Do not clean the LCD screen with ethyl alcohol, toluene, ethyl acid, or methyl.

IMPORTANT INFORMATION

- 13) When smoke, abnormal smell or sound appears from the product, please cut off power immediately and contact your dealer or service center.
- 14) Never insert any metal object into the cabinet. It may create danger of electric shock.
- 15) After service and maintenance, please let the service person do safety check to ensure proper operation of the unit.
- 16) The main plug is used as the device for cutting off power, so make sure the main plug easy to unplug.
- 17) When replacing accessories, please ensure the maintenance person use the accessories and tools appointed by manufacturer.

Cautions

- Ensure that all audio/video cables are properly connected before plugging in the power plug. The player is not disconnected from the AC power source as long as it is connected to the wall outlet, even if the player itself has been turned off.
- The acceptable power input range is AC ~ 100V-240V, 50/60Hz
- Before turning on the power of the player, please adjust the volume level of TVs, audio system speakers and amplifiers to the minimum. Adjust the volume as necessary only after normal playback has started to avoid damage to your hearing and equipments.
- Do not put the player near any high power loudspeakers so as to avoid any interference due to vibration or magnetic fields.
- Before moving the player, take out any discs. Otherwise the disc may be damaged.
- When moving the player from a cold place to a warm one, or vice versa, moisture may condense on the laser pickup unit inside the player. Should this occur, the player may not operate properly. In such a case please turn the power on for 1-2 hours (without disc) until the moisture evaporates.
- Clean the cabinet, panel, and controls only with a soft cloth slightly moistened with water or a mild detergent solution. Never use any type of abrasive pad, scouring powder or solvent such as alcohol or benzene for cleaning.

FCC Statement

This equipment has been tested and found to comply with the limits for a Class B digital device, pursuant to Part 15 of the FCC Rules. These limits are designed to provide reasonable protection against harmful interference in a residential installation. This equipment generates, uses, and can radiate radio frequency energy and, if not installed and used in accordance with the instructions, may cause harmful interference to radio communications. However, there is no guarantee that interference will not occur in a particular installation. If this equipment does cause harmful interference to radio or television reception, which can be determined by turning the equipment off and on, the user is encouraged to try to correct the interference by one or more of the following measures:

- Reorient or relocate the receiving antenna.
- Increase the separation between the equipment and receiver.
- Connect the equipment into an outlet on a circuit different from that to which the receiver is connected.
- Consult the dealer or an experienced radio/TV technician for help.

Any unauthorized changes or modifications to this equipment would void the user's authority to operate this device.

This device complies with Part 15 of the FCC Rules. Operation is subject to the following two conditions: (1) This device may not cause harmful interference, and (2) this device must accept any interference received, including interference that may cause undesired operation.





Copyright Protection

This product incorporates copyright protection technology that is protected by U.S. patents and other intellectual property rights. Use of this copyright protection technology must be authorized by Macrovision Corporation, and is intended for home and other limited viewing uses only unless otherwise authorized by Macrovision Corporation. Reverse engineering or disassembly is prohibited.

Trademarks

- DVD Logo is a trademark of DVD Format/Logo Licensing Corp., registered in the U.S., Japan and other countries.
- Super Audio CD, SACD and the SACD logo are joint trademarks of Sony Corporation and Philips Electronics N.V. Direct Stream Digital (DSD) is a trademark of Sony Corporation.
- Designed for Windows Media, Microsoft, HDCD, and the HDCD logo are trademarks or registered trademarks of Microsoft Corporation in the United States and/or other countries.
- VRS™, Video Reference Series™, Precision De-interlacing™, Precision Video Scaling™, Progressive Cadence Detection™ and AutoCUE-C™ are trademarks of Anchor Bay Technologies Inc. All products bearing the DVDO®, iScan™ and VRS™ trademarks are based upon technologies, architectures, and product designs originally created and developed by the Anchor Bay Team.
- Manufactured under license from Dolby Laboratories. “Dolby” and the double-D symbol are trademarks of Dolby Laboratories. Surround EX is a trademark of Dolby Laboratories.
- “DTS” and “DTS Digital Surround” are trademarks of Digital Theater Systems, Inc.
- HDMI, the HDMI logo and High-Definition Multimedia Interface are trademarks or registered trademarks of HDMI Licensing LLC.
- The 480p/720p/1080i/1080p up-converting arrow logo is a trademark of OPPO Digital, Inc.
- “Precision Track 3” is a trademark of OPPO Digital, Inc.
- All other trademarks are the properties of their respective owners.

Compatible Disc Types

Type	Size	Recorded Contents
	12cm or 8cm	DVD: Compressed digital audio + compressed digital video (dynamic picture)
	12cm or 8cm	DVD-Audio: Multi-channel digital audio + compressed digital video or still pictures
	12cm or 8cm	Super Audio CD: Multi-channel digital audio
	12cm or 8cm	CD-DA: Digital Audio

This manual uses the following icons to indicate items applicable to the compatible disc types:



Applies to DVD discs



Applies to DVD-Audio discs



Applies to Super Audio CD discs



Applies to CD discs

INSTALLATION

Front Panel Controls

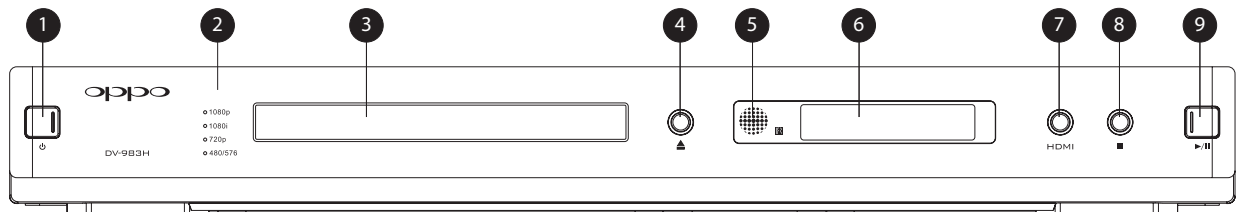

- | | | |
|----------------------|--------------------------|----------------------|
| 1. POWER Button | 2. Resolution Indicators | 3. Disc Tray |
| 4. OPEN/CLOSE Button | 5. IR Remote Sensor | 6. Display Window |
| 7. HDMI Button | 8. STOP Button | 9. PLAY/PAUSE Button |

Front Panel Display Window

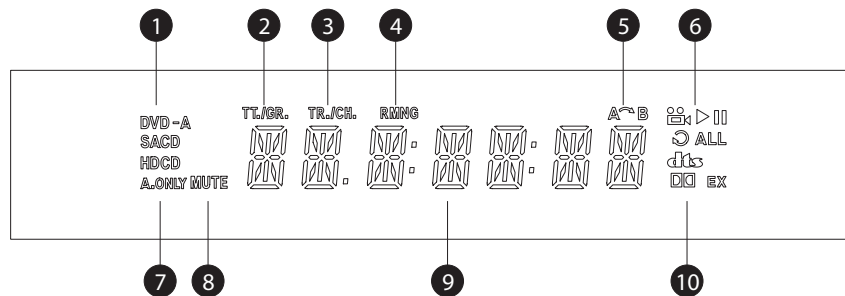

- | | |
|---|--|
| 1. Disc Type Indication – Indicates the currently playing disc type | 2. Title/Group – When illuminated, the displayed time applies to a title or group |
| 3. Track/Chapter – When illuminated, the displayed time applies to a track or chapter | 4. Remaining – When illuminated, the displayed time is the remaining play time |
| 5. A – B Repeat – Indicates that the A – B Repeat function is engaged | 6. Playback Status – Indicates playback status such as Play, Pause, Repeat and Angle |
| 7. Audio Only – Indicates that the Audio Only mode is engaged | 8. Mute – Indicates that the audio is muted |
| 9. Time and Message Display – Displays playback time and various messages | 10. Sound Track – Indicates the currently playing sound track type |

Rear Panel Connectors

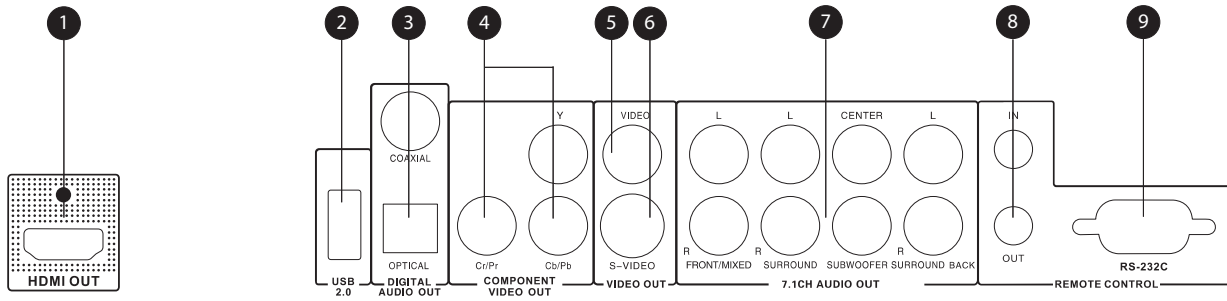

1. HDMI Output

2. USB 2.0 Port

3. Coaxial and Optical Digital Audio Output

4. Component Video Output

5. Composite Video Output

6. S-Video Output

7. 7.1CH Audio Output

8. IR IN and OUT Ports

9. RS-232 Port

In addition to the above connectors, the AC power inlet is also located on the rear panel. The inlet is the IEC60-320 C18 type. Only the included AC power cord or an approved power cord with an IEC60-320 C17 type plug should be used.

Remote Control

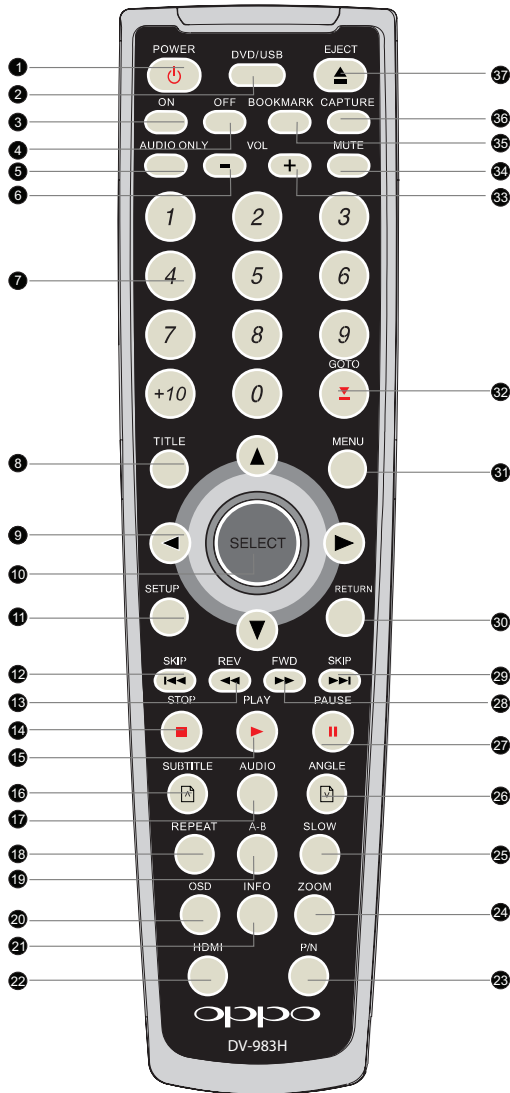

1. **POWER** Button: Toggle power STANDBY and ON
2. **DVD/USB** Button: Select DVD or USB device as content source
3. **ON** Button: Turn power ON
4. **OFF** Button: Turn power OFF
5. **AUDIO ONLY** Button: Turn off/on video
6. **VOLUME -** : Decrease volume
7. **NUMBER** Buttons: Enter numeric values
8. **TITLE** Button: Show DVD title menu
9. **ARROW** Buttons: Navigate menu selection
10. **SELECT** Button: Confirm menu selection
11. **SETUP** Button: Enter the DVD player setup menu
12. **PREV** Button: Skip previous
13. **REV** Button: Fast reverse play
14. **STOP** Button: Stop playback
15. **PLAY** Button: Start playback
16. **SUBTITLE** Button: Change subtitle language / **PREV PAGE** Button: Show previous page (DVD-Audio)
17. **AUDIO** Button: Change the audio language or channel
18. **REPEAT** Button: Repeat play
19. **A-B** Button: Repeat play the selected section
20. **OSD** Button: Show/hide On-Screen Display
21. **INFO** Button: Display disc info browser
22. **HDMI** Button: Switch HDMI output resolution
23. **P/N** Button: Switch output TV system: NTSC, PAL or AUTO
24. **ZOOM** Button: Zoom in/out the display
25. **SLOW** Button: Slow play
26. **ANGLE** Button: Change camera angles / **NEXT PAGE** Button: Show next page (DVD-Audio)
27. **PAUSE** Button: Pause play
28. **FWD** Button: Fast forward play
29. **NEXT** Button: Skip next
30. **RETURN** Button: Return to the previous menu / Clear input numbers
31. **MENU** Button: Show DVD menu
32. **GOTO** Button: Play from a specified location
33. **VOLUME +** : Increase volume
34. **MUTE** Button: Mute audio
35. **BOOKMARK** Button: Bookmark playing point or retrieve bookmarks
36. **CAPTURE** Button: Capture background image
37. **EJECT** Button: Open/close the disc tray

Battery Installation

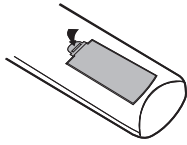

1. Remove the battery compartment cover

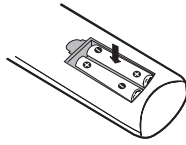

2. Insert batteries

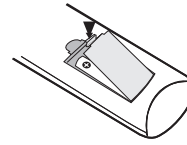

3. Replace the battery compartment cover

Using the Remote Control

When using the remote control, the front window of the remote control should be pointed to the infrared sensor on the front panel within an angle of $\pm 30^\circ$ and a range of about 26 ft.

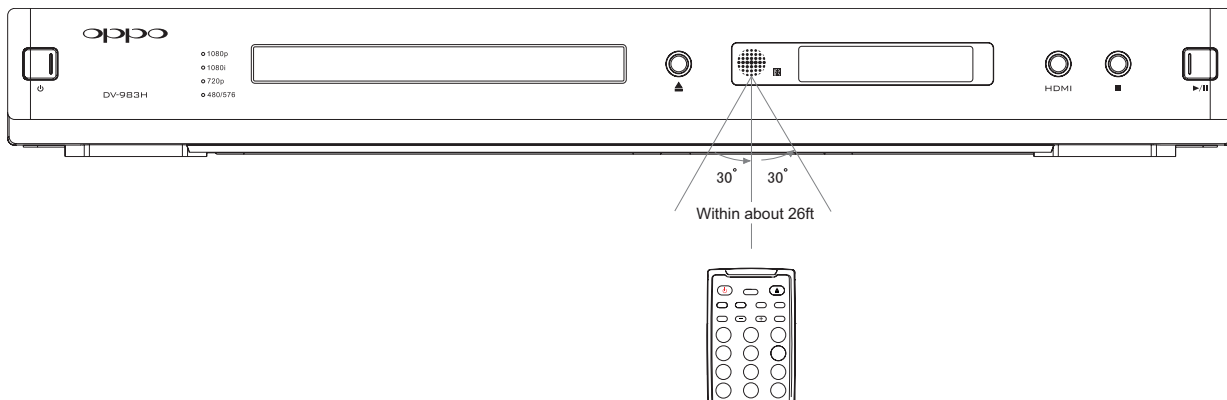

CAUTIONS

- Never drop the remote control or expose it to moisture.
- Never expose the infrared remote sensor on the front panel to direct sunlight or strong light sources.
- Remote may not operate consistently when batteries become low. Replace them if operation deteriorates.
- If the remote control will not be used for a long time, please remove the batteries.

NOTE

When a button is pressed but its function is invalid or unavailable at the moment, the TV screen displays:



Making the Video Connection

HDMI Connection

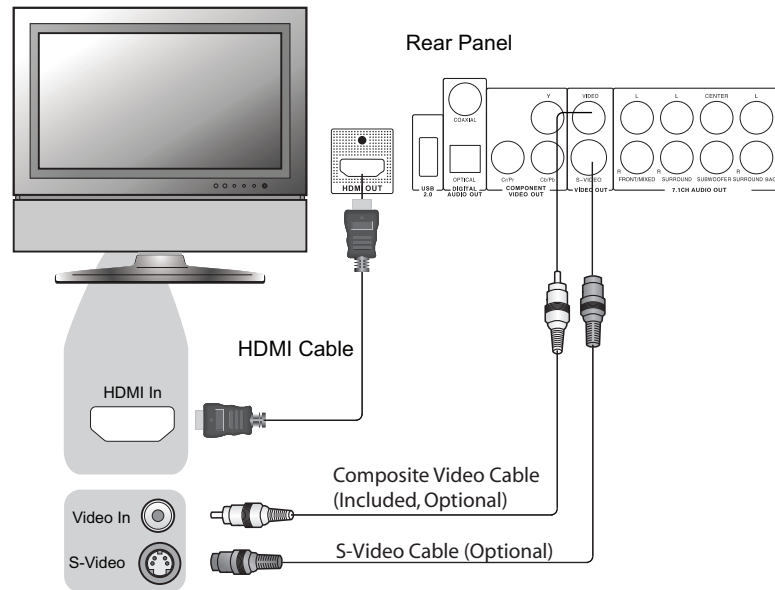

Method 1 – HDMI Connection Directly to TV

- If your TV has an HDMI (High-Definition Multimedia Interface) input, you can use the included HDMI cable to connect the DVD player to the TV. This connection method delivers both video and audio in pure digital format via a single cable. The HDMI video output of the DVD player presents the highest possible resolutions and video quality.
- You may connect the composite video or S-Video cable to the TV for trouble-shooting purpose, just in case there is a problem with HDMI. However it is *not recommended* to use the composite video or S-Video as the primary method of video delivery to the TV, because using it will lose the advantage of video up-conversion and you will only get standard definition video.

DVI Connection

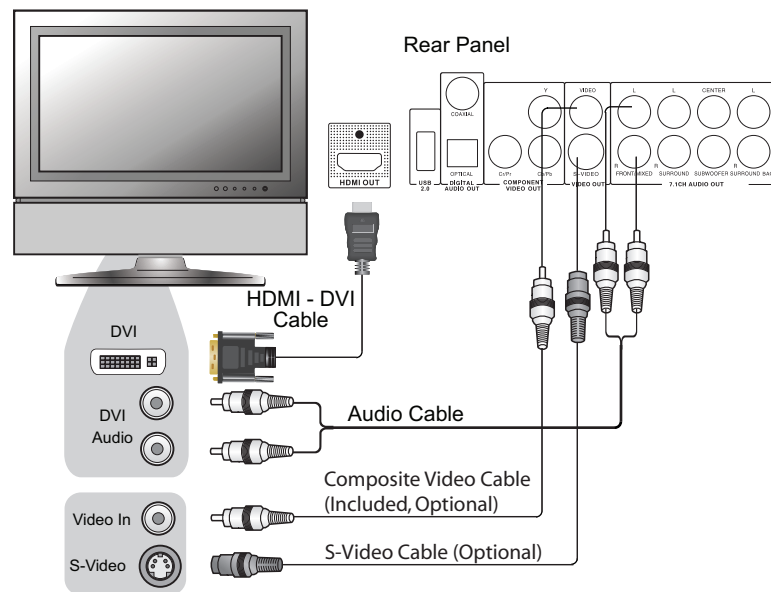

Method 2 – DVI Connection to TV

- If your TV has a DVI input that supports HDCP, you can purchase an HDMI-DVI adapter cable to connect the DVD player to the TV. This connection method delivers digital video to the TV without any signal degradation. The HDMI video output of the OPPO DVD player presents the highest possible resolutions and video quality.
- Please use the Red/White audio cables to connect the FRONT/MIXED audio output of the DVD player to the TV. Make sure the audio cables are connected to the same input terminal group on the TV as the DVI input. Usually the input terminals are marked as “DVI Audio” or “PC Audio”. On some TVs you may need to use an RCA-3.5mm Mini-Jack adapter cable to connect the audio.
- You may connect the composite video or S-Video cable to the TV for trouble-shooting purpose, just in case there is a problem with DVI. However it is *not recommended* to use the composite video or S-Video as the primary method of video delivery to the TV, because using it will lose the advantage of video up-conversion and you will only get standard definition video.

NOTE

HDCP stands for High-bandwidth Digital Content Protection system. The HDMI output of the DVD player follows HDCP to encrypt the digital audio and video content. The TV needs to support HDCP so it can decrypt the content and properly display it.

Component Video Connection

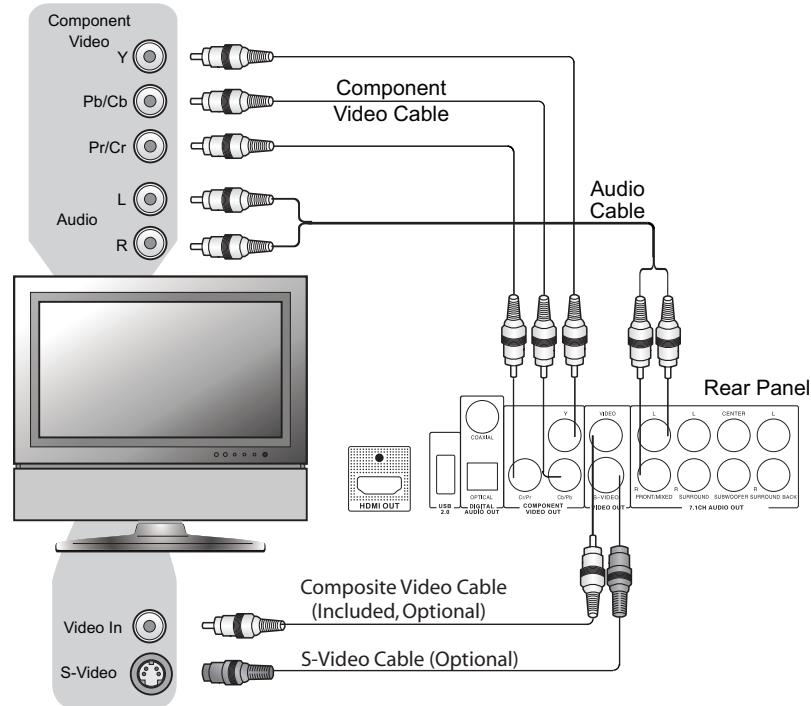

Method 3 – Component Video Connection to TV

- If your TV has no digital video input but has component video inputs, please use a set of component video cable to connect the component video output of the DVD player to the TV. The connectors are color coded, so please make sure the cable connections match on both ends. The component video connection will produce a very clear picture with high color accuracy.
- Please use the Red/White audio cables to connect the FRONT/MIXED audio output of the DVD player to the TV. Make sure the audio cables are connected to the same input terminal group on the TV as the component video input.
- You may connect the composite video or S-Video cable to the TV for trouble-shooting purpose, just in case there is a problem with component video. However it is *not recommended* to use the composite video or S-Video as the primary method of video delivery to the TV, because using it will lose the advantage of video up-conversion and you will only get standard definition video.
- Video up-conversion over the component output is only available for unencrypted discs such as home video and consumer-created contents. Most commercially pressed DVD discs are CSS-encrypted and will be limited to 480i/480p resolution. This restriction applies to the component output only. The HDMI output is protected with HDCP and has no such restriction.
- The component output will only output progressive-scan (480p/576p) and up-converted resolutions (720p/1080i/1080p) when the HDMI output is not in use (The HDMI cable is unplugged and the “**Primary Output**” setup menu item in the “**Video Setup Page**” is set to “**Component**” – see page 55 for details). When the HDMI output is in use, or when “**Primary Output**” is set to “**HDMI**”, the player will output interlaced video (480i/576i) through its component output.

Connecting to an Audio System

Connecting to a Receiver/Amplifier with HDMI Input/Output

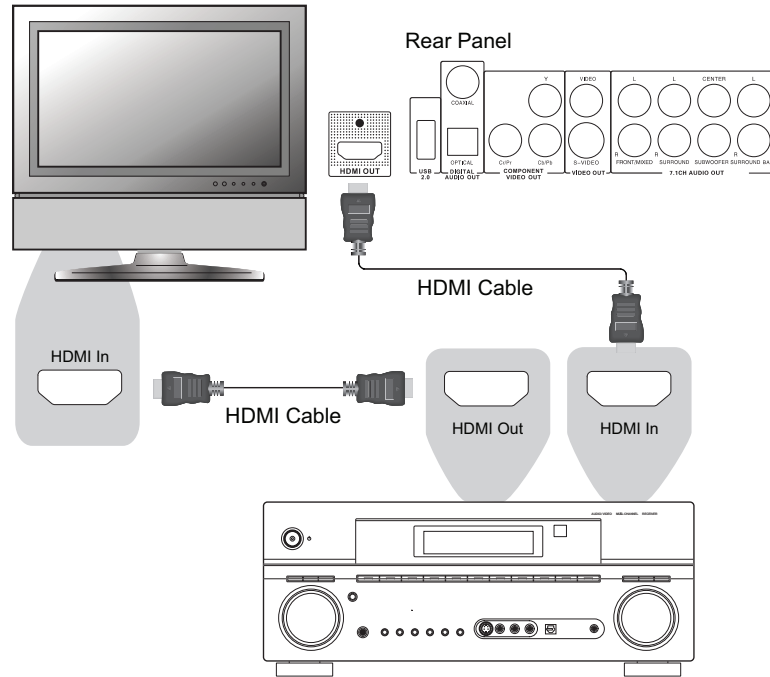

Method 4 – HDMI Connection to Receiver and TV

- HDMI can transmit both audio and video signals over a single cable. If you have an HDMI-capable receiver that can support HDMI audio, you can simply run an HDMI cable from the DVD player to your receiver and enable HDMI audio on the receiver (see your receiver's owners' manual for more information). The receiver usually has an HDMI output that you can connect to your TV to pass the video signal.

Connecting to a Receiver/Amplifier with 7.1ch Audio Input

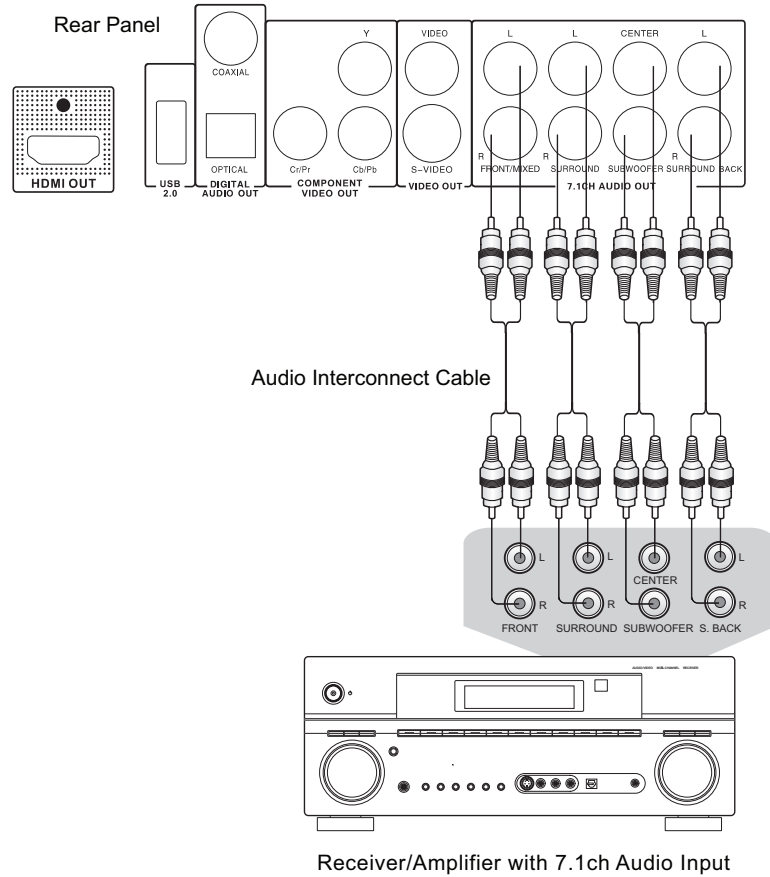

Method 5 – 7.1ch Analog Audio Connection

- Please use 8 RCA-style audio interconnect cables to connect the FRONT/MIXED L/R, SURROUND L/R, CENTER, SUBWOOFER and SURROUND BACK L/R analog outputs of the OPPO DVD player to the corresponding multi-channel analog audio input jacks of your A/V receiver.

Connecting to a Receiver/Amplifier with 5.1ch Audio Input

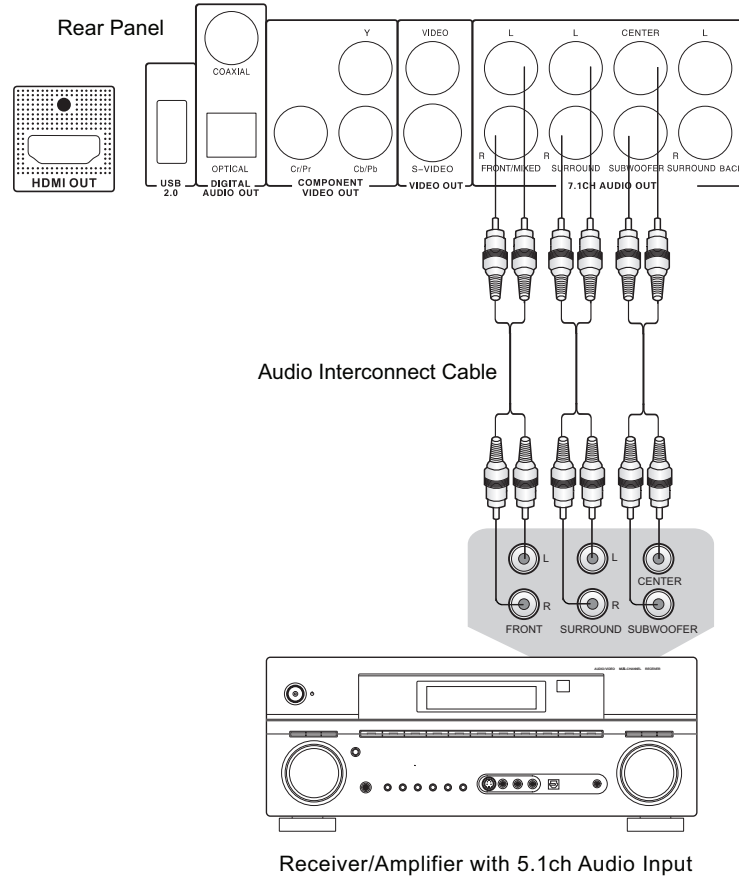

Method 6 – 5.1ch Analog Audio Connection

- Please use 6 RCA-style audio interconnect cables to connect the FRONT/MIXED L/R, SURROUND L/R, CENTER and SUBWOOFER analog outputs of the OPPO DVD player to the corresponding multi-channel analog audio input jacks of your A/V receiver. The SURROUND BACK L/R outputs do not need to be connected.

Connecting to a Receiver/Amplifier with Dolby Digital or DTS Decoder

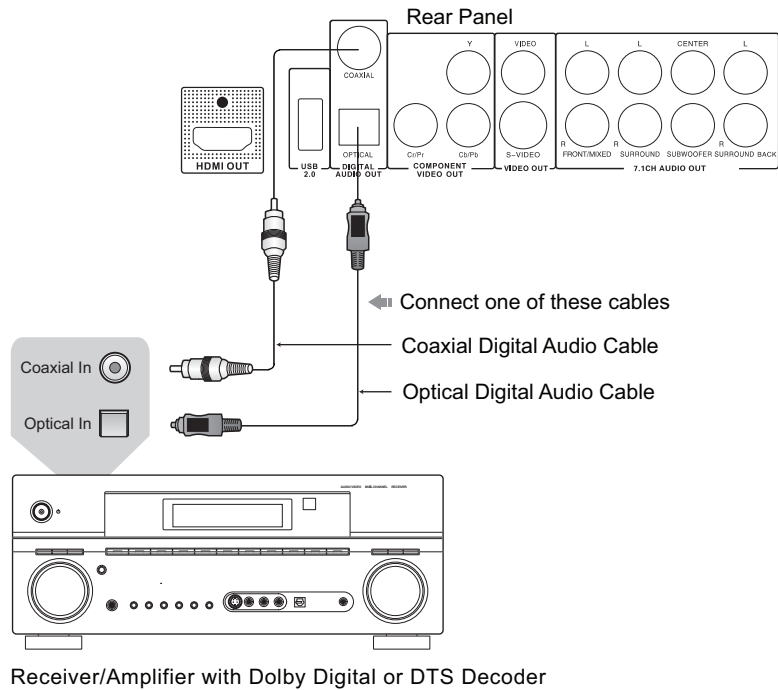

Method 7 – Digital Audio Connection

- Please use either a 75-Ohm coaxial digital audio cable with RCA-style connectors or an S/PDIF optical digital audio cable to connect one of the digital audio outputs to the corresponding input terminal on your A/V receiver.

NOTE

- Manufactured under license from Dolby Laboratories. “Dolby” and the double-D symbol are trademarks of Dolby Laboratories.
- “DTS” and “DTS Digital Surround” are trademarks of Digital Theater Systems, Inc.
- Due to copy-control restrictions and bandwidth limitation, full resolution audio output from DVD-Audio or SACD playback cannot be sent through the coaxial or optical digital audio output. To listen to DVD-Audio or SACD in full resolution, please use HDMI or analog audio connections.

Connecting to a Stereo or Surround Audio System

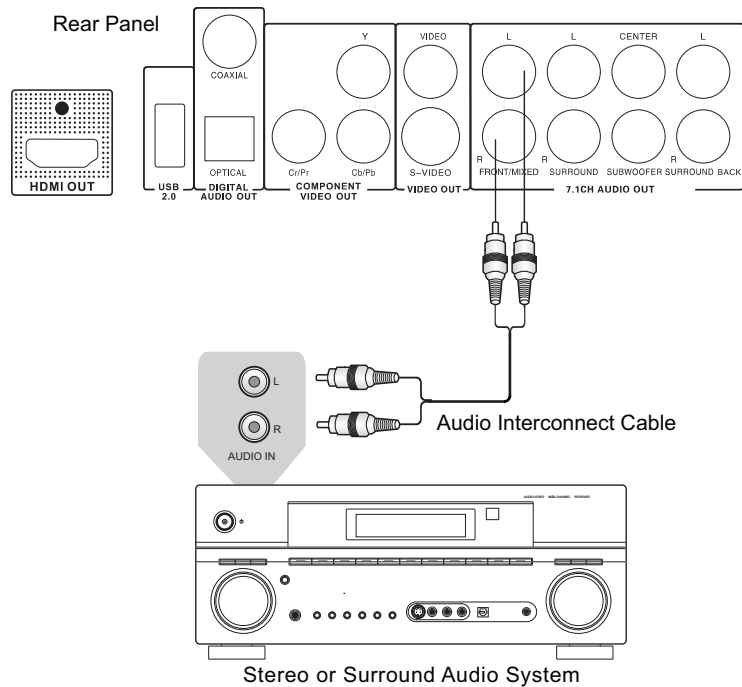

Method 8 – Stereo Analog Audio Connection

- If your audio system only offers stereo audio inputs, you can connect it to the FRONT/MIXED L/R audio outputs of the DVD player using the supplied Red/White audio cables. Depending on the capability of your audio system, you may set up your DVD player with one of the following configurations:
 - If the audio system does not have surround speakers, please set the down-mix mode to **“Stereo”** or **“V. Surround”**.
 - If the audio system has surround speakers and Dolby Pro Logic Surround support, please set the down-mix mode to **“Lt/Rt”**.

(Please refer to page 25 for details.)

Custom Installation Options

Infrared Remote (IR) Installation

The DV-983H features an IR IN and IR OUT ports on its back panel. If the DVD player is to be installed in an equipment cabinet where direct line-of-sight is not available for remote control, your custom home theater installer can purchase an External IR Remote Sensor (OPPO part number IR-ES1) and plug it into the IR IN port. Place the sensor head at a location where there is direct line-of-sight to ensure reliable operation. The External IR Remote Sensor is available from your dealer or directly from OPPO Digital, Inc.

If you have another OPPO device that features an IR IN port, the IR OUT port on the DV-983H can pass through remote control signal to the next OPPO device. For example, if you use an OPPO HM-31 Advanced 3x1 HDMI Switch to expand the HDMI inputs on your TV, the IR IN port of the HM-31 can be connected to the IR OUT port of the DV-983H using a 3.5mm stereo cable.

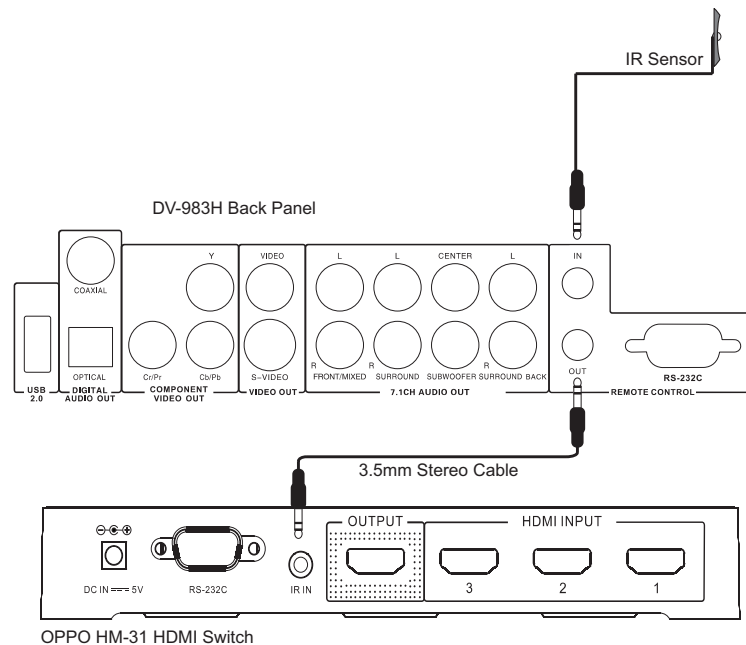

NOTE

- OPPO cannot guarantee that the IR IN and IR OUT ports will be compatible with devices that are not manufactured by OPPO.
- Connecting the IR IN or IR OUT port to an incompatible device may result damage to the connected device or the DVD player.
- Please contact OPPO customer support if you plan to integrate the DVD player into an IR distribution system. Customer support can provide recommendations on how to properly connect the control signal.

RS232 Control

If your home theater system has an integrated control system, please ask your custom installer to contact OPPO for the RS-232C control protocol. The DV-983H has an RS-232C control port and can be integrated into most custom home theater control systems.

Setting Up the Player - Initial Setup

Use the Setup Menu System

In many places of this guide, the DVD player's Setup Menu needs to be adjusted to match your specific audio/video configuration. When asking you to make menu adjustments, we will use the following terminology to indicate the location of the desired function:

Setup Menu Name > Menu Item > Submenu Item (or Selection)

Setup Menu Name is the actual name of the uppermost setup menu level. With the OPPO DV-983H there are exactly five (5) Setup Menu pages or sections, each represented by an icon on the top of the Setup Menu screen. They are: **General Setup Page**, **Speaker Setup Page**, **Audio Setup Page**, **Video Setup Page**, and **Preference Page**.

Menu Item is the parameter to be adjusted which appears below the **Setup Menu Name**. It is the list of items on the left of the current Setup screen.

Submenu Item (or the selection) is the actual numeric or descriptive element that represents the change being made to the selected parameter. It is the item located to the immediate right of its corresponding **Menu Item**.

A **Scroll Icon** appears on the right side of the setup menu when there are more **Menu Items** than what can fit in a screen. You may use the up and down arrow buttons to scroll the display in order to access additional **Menu Items**.

This diagram should give a good description of the various elements and their context. In this screen we could, for example, instruct you to set the **Subwoofer** parameter to **Off** in the **Speaker Setup Page**. To indicate where we were, you would see the following: **Speaker Setup Page > Subwoofer > Off**.

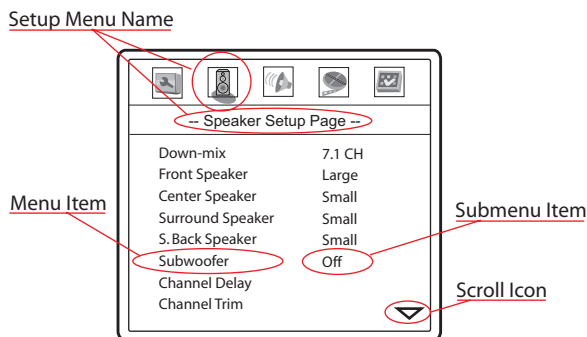

NOTE

It is possible that some setup items are grayed-out and inaccessible. This can be caused by disc still being played back or interlocking with mutually exclusive setup items. Please stop playback or eject the disc before trying to change these setup items. If you still cannot access the setup item, please check for configuration conflicts and consistency. For example, if the audio "Down-mix" mode is set to "Stereo", the center and surround speaker size settings will be grayed-out. Setting the "Down-mix" mode to "5.1CH" will enable the center and surround speaker size settings.

INSTALLATION

To access the DVD player's Setup Menu simply press the **SETUP** button on the remote control. Since some setup menu options can become inaccessible when the player is playing a disc, it is recommended that you operate the setup menu when playback is fully stopped or when there is no disc in the player.

1. Press the **SETUP** button on the remote control, and the TV screen displays:

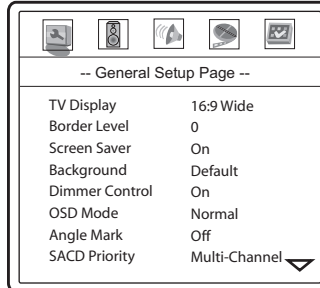

2. Press the left/right **ARROW** buttons to select the setup page. There are 5 pages: **General Setup Page**, **Speaker Setup Page**, **Audio Setup Page**, **Video Setup Page**, and **Preference Page**. Press the **SELECT** button or the **DOWN ARROW** button to enter the selected setup page. The **Preference** page can only be accessed when playback is completely stopped, or when there is no disc in the player.
3. Press the up/down **ARROW** buttons to select the setup item to be changed, and press the **SELECT** button to change the setting. When the scroll icon is shown on the right side of the setup menu, it indicates that there are more menu items that can be accessed by scrolling with the **ARROW** buttons.

For example, in the **General Setup Page**, you may use the up/down **ARROW** buttons to select the "TV Display" setup item, and press the **SELECT** button to change the "TV Display" setting.

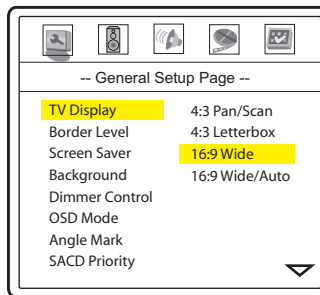

4. To select a value from the list of available settings, press the up/down **ARROW** buttons and then press the **SELECT** button to confirm.

For example, after using the up/down **ARROW** buttons to select "4:3 Letterbox" for "TV Display" and pressing the **SELECT** button, the screen will look like this:

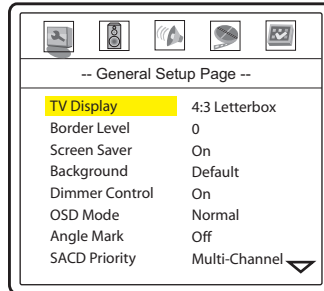

5. To exit the SETUP menu, press the **SETUP** button on the remote control.

Determine Your Display Type



Widescreen, or 16:9 TV



Standard Definition, or 4:3 TV

For best performance, your OPPO DVD player must be correctly configured for playback even before the first disc is inserted. This is done under **General Setup Page > TV Display** in the Setup Menu.

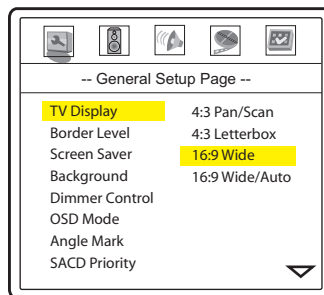

If you have a widescreen (16:9) display as pictured on the left, select one of these options:

- **16:9 Wide** – 16:9 (widescreen) sources will be displayed in their native aspect ratio, and 4:3 sources will be stretched.
- **16:9 Wide/Auto** – 16:9 (widescreen) as well as 4:3 sources will be displayed in their native aspect ratio. Please note that in this mode 4:3 sources will be displayed with black borders on both sides to maintain the correct 4:3 aspect ratio.











NOTE

If you are using a plasma or widescreen CRT display you will want to avoid leaving black bars on the screen for any length of time as you may encounter temporary burn-in where the display retains memory of the “used” part of screen and the unused (black bar) portions are clearly defined on the screen during subsequent viewing sessions. The “**16:9 Wide**” mode is the best choice for these types of displays. On the other hand, if a mode other than “**16:9 Wide**” is used or if you use zoom modes to adjust aspect ratio, bars may appear at the borders of the active video. The “**Border Level**” setting in the “**Video Setup Page**” can

change the brightness level of the bars. If you set it to 3 or 4, the bars become grey instead of black. This setting allows the phosphor in the bar area to be moderately used, and can alleviate the burn-in problem.

If you have a 4:3 or standard definition screen as pictured on the right, select one of these options:

- **4:3 Pan/Scan** – 4:3 TV Pan and Scan. Choose when the display is 4:3. Both sides of a widescreen image are clipped (you lose about 30% of the picture).
- **4:3 Letterbox** – 4:3 TV Letterbox. Choose when the display is 4:3. Widescreen image is displayed in “letterbox” format with black borders on top and bottom (preferred).

DVD Content	TV Screen Appearance			
	4:3		16:9	
	Pan/Scan	Letterbox	Wide	Wide/Auto
4:3 				
16:9 				

Select the Best Output Resolution

One of the major advantages of the OPPO DVD player is its ability to up-convert standard definition video stored on the DVD discs to high definition video signal and output it to the TV through HDMI or component output (Restrictions apply to up-conversion over component output – see notes below for details). The sophisticated video processor inside the player ensures that the resulted video will have the best possible color, detail and motion. The DVD player offers several standard and high definition video output resolutions. To get the best visual result, it is important to select an output resolution that matches your TV or display device.

The rule of thumb when selecting an output resolution is to match the “native resolution” of your TV or display device as closely as possible. The “native resolution” is the resolution of the actual display component in the TV, such as the Plasma panel, LCD panel, or DLP™ chip. The TV may accept input signals with lower or higher resolutions than its native resolution. In such cases the electronics in the TV will up-scale or down-scale the video to fit its display component. Unfortunately many TVs on the market only do an average job scaling the video. On the other hand, if you set the OPPO DVD player to output a resolution that matches or is very close to the native resolution of the TV, you are more likely to get a great picture. For the latest generation of 1080p, “Full HD” or “True HD” displays, the best output resolution will naturally be 1080p. For most flat panels and DLP™, LCD or LCoS (SXR™, D-ILA™) rear projection televisions this will be 720p. For CRT rear projection televisions this will likely be 1080i. For non HD displays (very rare if they have HDMI or DVI) this will be 480p. You may want to try all available output resolutions and select the one that produces the best picture quality on your TV.

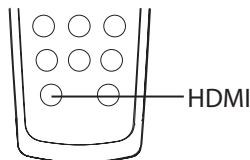

You may use the **HDMI** button on the remote control or the front panel to select the output resolution:

1. Make sure the HDMI cable, HDMI-DVI adapter cable or component video cable is properly connected.
2. Turn on the TV. Adjust the TV to use the proper input (HDMI, DVI or Component).

INSTALLATION

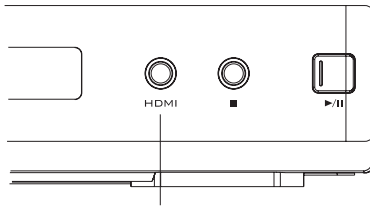

HDMI Button

3. Turn on the DVD player with no disc in its tray, or if the DVD player is already on, make sure that playback is completely stopped.
4. Press the **HDMI** button to show the current output resolution. Each subsequent press of the **HDMI** button switches the output resolution in the following sequence:

NTSC output via HDMI:

480p → 720p 60Hz → 1080i 60Hz → 1080p 60Hz → Back to 480p again

PAL output via HDMI:

576p → 720p 50Hz → 1080i 50Hz → 1080p 50Hz → Back to 576p again

NTSC output via component (HDMI not connected and “**Primary Output**” set to “**Component**”):

480i → 480p → 720p 60Hz → 1080i 60Hz → 1080p 60Hz → Back to 480i again

PAL output via component (HDMI not connected and “**Primary Output**” set to “**Component**”):

576i → 576p → 720p 50Hz → 1080i 50Hz → 1080p 50Hz → Back to 576i again

NTSC output via component (HDMI connected or “**Primary Output**” set to “**HDMI**”):

480i only (The displayed information is for HDMI and does not reflect the component output)

PAL output via component (HDMI connected or “**Primary Output**” set to “**HDMI**”):

576i only (The displayed information is for HDMI and does not reflect the component output)

5. The selected output resolution will be briefly displayed on the upper left corner of the TV screen as well as on the DVD player’s front panel display.
6. The currently selected output resolution is also indicated by the front panel resolution indicators.

NOTE

- Some TV sets do not support one or more output resolutions (particularly 1080p). In this case repeatedly press the HDMI button until a supported resolution is selected. Give your display a second or two to “grab on” to the new signal and attempt to display a picture.
- In case you are not able to get a picture using the HDMI or component output, please connect the DVD player to the TV using either the composite video or S-Video output, and then use the setup menu to adjust the DVD player settings.
- Video up-conversion over the component output is only available for unencrypted discs such as home video and consumer-created contents. Most commercially pressed DVD discs are CSS-encrypted and will be limited to 480i/480p resolution. This restriction applies to the component output only. The HDMI output is protected with HDCP and has no such restriction.
- The Consumer Electronics Association (CEA) has not published a standard for 1080p component video signal yet. There are very few TV models on the market that support 1080p over component. OPPO cannot guarantee that the 1080p component output from the DVD player will be compatible with your TV or display device.

Set up Audio Options

Depending on your specific audio/video connection method, the audio options of the DVD player may need to be adjusted to match your configuration. Please refer to the video and audio connection methods described previously in this guide and the following audio setup guidelines.

Audio Connection Directly to TV

If your DVD player is connected directly to the TV through HDMI (as described in “Method 1” on page 9), through DVI and analog L/R audio cables (as described in “Method 2” on page 10), or through component video and analog L/R audio cables (as described in “Method 3” on page 11), it is recommended that you keep the factory default settings. The factory default settings set **Speaker Setup Page > Down-mix** to “**Stereo**”. In this mode the DVD player will mix the surround and center channels of multi-channel audio contents with the left and right front channels. Since most TVs only come with stereo speakers, this setup will ensure you hear all conversation and background audio from the DVD.

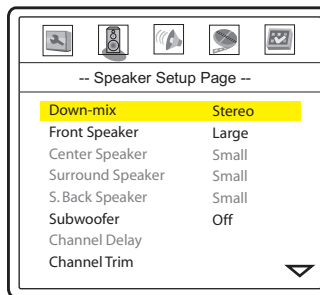

Multi-Channel Digital Audio to Receiver through HDMI

If your DVD player is connected to an AV receiver or processor with HDMI inputs for high resolution multi-channel digital audio, you are in luck! You are now equipped to send all current audio formats to your receiver in pure digital form. The connection method will typically be as described in “Method 4” on page 12 of this guide.

To get the best possible audio via HDMI, you may need to set the following options on the DVD player’s setup menu, depending on your HDMI-capable receiver configuration:

- If your receiver supports HDMI v1.1 Multi-Channel PCM audio, most likely it also support DTS and/or Dolby Digital decoding and has surround speakers. Please set these DVD player options:
 - **Speaker Setup Page > Down-mix** to “**5.1 CH**”
 - **Speaker Setup Page > Front Speaker** to “**Large**”
 - **Speaker Setup Page > Center Speaker** to “**Large**”
 - **Speaker Setup Page > Surround Speaker** to “**Large**”
 - **Speaker Setup Page > Subwoofer** to “**On**”
 - **Audio Setup Page > HDMI Audio** to “**Auto**”
 - **Audio Setup Page > Digital Output** to “**Raw**”

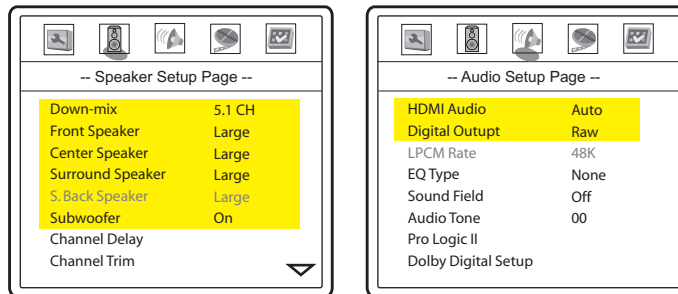

In this configuration you can enjoy all audio formats using the HDMI connection.

NOTE

HDMI is a wonderful thing. A single cable can transport both audio AND video from your DVD player to your display. Be aware, however, that HDMI is an evolving standard, and there could be compatibility issues. A receiver that supports HDMI v1.1 or later is required in order to play multi-channel audio for all formats, including DVD-Video/Audio and SACD (SACD DSD audio converted to multi-channel PCM). If the receiver supports HDMI 1.0 only, DVD-Audio and SACD will NOT be able to be sent via HDMI. To utilize DVD-Audio or SACD, please see next section for multi-channel analogue audio connection.

Multi-Channel Analog Audio to Receiver

If your DVD player is connected to an A/V receiver through the 7.1ch or 5.1ch analog audio jacks using 8 or 6 RCA cables (as described in “Method 5” on page 13 and “Method 6” on page 14), you can play all supported audio formats and listen to it with your A/V receiver and surround systems. The following setup options are recommended:

- Set the **Speaker Setup Page > Down-mix** to “**7.1CH**” or “**5.1CH**”.
- Set the speaker size and subwoofer properly according to your actual audio hardware.
- Enable or select the multi-channel analog inputs on your receiver

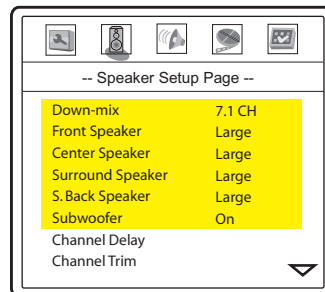

Using the multi-channel analog audio output is necessary for playing DVD-Audio and SACD if your receiver does not support HDMI multi-channel audio. This is absolutely worth it if you haven’t yet upgraded to a receiver with HDMI audio. Truly discrete audio channels are a wondrous thing, so enjoy them if you can.

Coaxial or Optical Digital Audio to Receiver

If your audio connection is as described in “Method 7” on page 15 of this guide, and the A/V receiver support Dolby Digital and DTS decoding, the following setup options are recommended:

- Set the **Audio Setup Page > Digital Output** to **“Raw”**. This will ensure the original Dolby Digital and DTS audio stream will be sent to the receiver for decoding. Stereo audio content will also be sent in digital format.

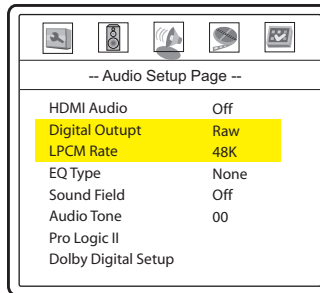

Due to bandwidth limitations of the technology and copyright restrictions, unfortunately it is impossible to send high-resolution multi-channel digital audio from a source like SACD or DVD-Audio to the receiver using this connection method. To enjoy SACD or DVD-Audio in their full resolution, please use the HDMI connection if you have a receiver that handles HDMI audio and use multi-channel outputs if you do not.

Stereo Analog Audio to Receiver

If you primarily listen to stereo contents or your receiver only offers stereo audio connections, please use the analog RCA-style cables to connect the FRONT/MIXED L/R output of the DVD player to your receiver, as described in “Method 8” on page 16 of this guide. Depending on whether the receiver has surround speakers and supports Dolby Pro Logic II decoding, you may use one of the following audio configurations:

- **No Surround Speakers:** If the audio system *does not* have surround speakers, please set the **Speaker Setup Page > Down-mix** to **“Stereo”** or **“V. Surround”**.

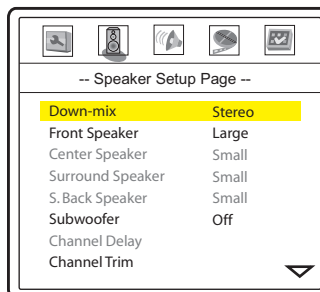

- **Surround Speakers and Dolby Pro Logic II Support:** If the audio system has surround speakers and Dolby Pro Logic II Surround support, please set the **Speaker Setup Page > Down-mix** to **“Lt/Rt”**.

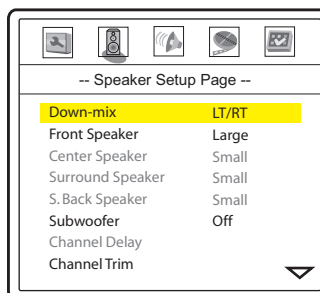

BASIC OPERATIONS

Disc Playback

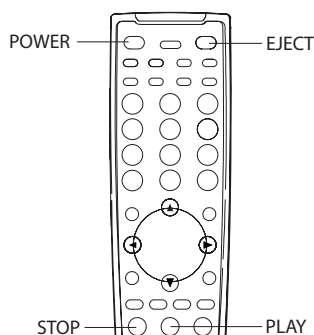
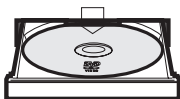

1. Press the **POWER** button to turn on the DVD player.
2. Press the **OPEN/CLOSE (EJECT)** button to eject the disc tray.
3. Place the disc with the label side facing up and the recorded side facing down.
4. Press the **OPEN/CLOSE (EJECT)** button again to retract the tray.
5. The DVD player reads disc information and starts playback.
6. Depending on the content of the disc, a menu or navigation screen may appear. Please use the navigation **ARROW** and **SELECT** buttons to select the content to play.
7. To stop playback, press the **STOP** button.
 - During DVD playback, pressing the **STOP** button for the first time brings the DVD player to a pre-stop mode. You can resume playback from the stopped point by pressing the **PLAY** button. This pre-stop mode allows you to change the player settings and then resume playback.
 - To completely stop playback, press the **STOP** button twice.
8. To turn off the player, press the **POWER** button.
 - This unit consumes a small amount of power even when it is turned off to STANDBY mode. To save power when the unit is not to be used for a long time, unplug it from the household AC outlet.

DVD Menu Playback

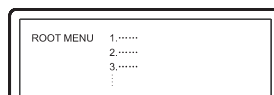
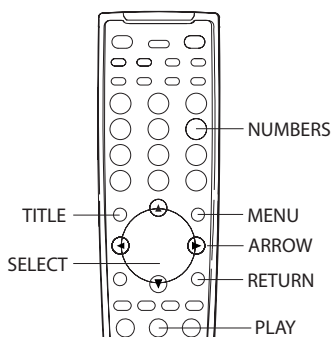

1. Some DVD discs contain title menu or chapter menu functions.
2. Press the **MENU** button on the remote control to display the menu on the TV screen.
3. Make menu selections using the number buttons or navigate the menu using the **ARROW** buttons, and then press the **PLAY** or **SELECT** button to make the selection.

You may also:

- Press the **TITLE** button to return to the disc title menu.
- Press the **MENU** button to return to the initial menu.
- Press the **RETURN** button to return to the previous menu. The return location varies with discs.

Pause Playback



1. During playback, press the **PAUSE** button to temporarily pause the program.
 - In the PAUSE status, the TV screen displays:

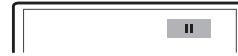
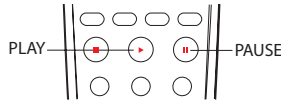

2. Press the **PLAY** button to resume playback.

NOTE

If the screen saver is set to "ON" (please refer to page 45 for details), after pausing for 2 minutes the player will activate the screen saver and stop all video output signal. This is to minimize possible burn-in on plasma or CRT screens caused by displaying a static image for a prolonged period of time. Many projectors and LCD TVs will go into a standby or sleep mode and turn off their projection lamp or LCD backlight lamp, thus save energy and prolong the lamp life. When you press any button on the OPPO remote control or player front panel, the screen saver will be cancelled and video output will be restored. If your TV is already in standby or sleep mode, you may need to wake up the TV by pressing a button on its remote or control panel.

OSD (On-Screen Display)

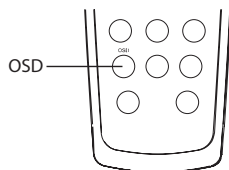

Press the **OSD** button on the remote control to show disc information and operation function hints on the TV screen.

The OSD display includes the followings:

DVD disc:

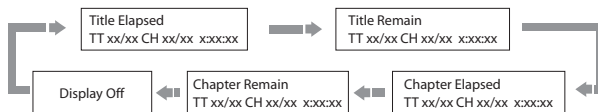

CD disc:

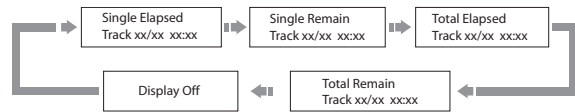

Volume Control

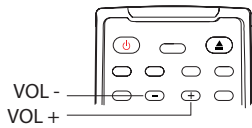

1. For regular audio volume adjustment, it is recommended that you use the volume control on your TV or receiver/amplifier.
2. The **VOL +/-** buttons on the DVD remote control is provided as an alternative way of controlling the audio volume. It is recommended that you use this control to make the audio volume from the DVD player the same as from other sources, such as TV programs or a VCR.
 - Press the **VOL -** button to decrease the volume.
 - Press the **VOL +** button to increase the volume.

NOTE

The volume control does not apply to digital audio output in raw bit stream format. However when the volume is decreased to 0, digital audio output will be muted.

Mute

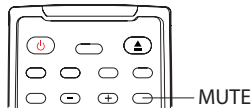

1. Press the **MUTE** button on the remote control during playback to turn off audio output. The TV screen displays "MUTE".



2. Press the **MUTE** button again to resume audio output.



NOTE

Check the MUTE status on the front panel display of the DVD player when there is no audio output. You may also press the **MUTE** button to verify the MUTE status.

Audio Language/Channel Selection

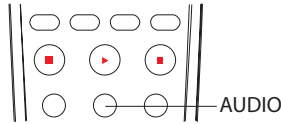

To select the audio language or channel, press the **AUDIO** button on the remote control during playback.

- For DVD or video programs that are encoded with multiple audio languages or channels, you may select the desired language or channel.



- For CD or other stereo audio content, you may select audio output from the LEFT channel only, RIGHT channel only, mix LEFT and RIGHT channels, or STEREO.



- For SACD, pressing the “AUDIO” button to switch among multi-channel surround, 2-channel stereo and CD audio layers. The disc will start from the beginning after switching layers.



NOTE

Availability of languages and audio channels varies with discs.

Subtitle Selection

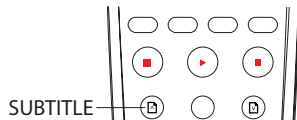

When playing DVD discs or video programs recorded with subtitles, press the **SUBTITLE** button on the remote control to select the desired subtitle.

Each press of **SUBTITLE** button switches one available subtitle in a looping manner:

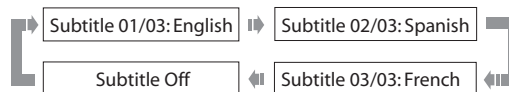

NOTE

Availability of subtitle depends on discs and contents.

Angle Selection

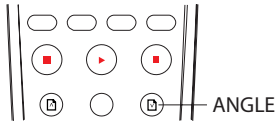

1. When playing DVD discs, an angle mark will be displayed on the screen when the player detects scenes recorded with multiple angles:



The angle mark is also presented on the front panel display.

2. Press the **ANGLE** button on the remote control to select the desired playing angle.

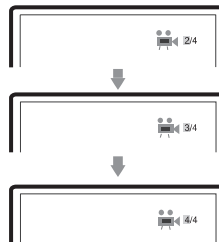

3. To resume normal playback, repeat pressing the **ANGLE** button until the default angle is displayed.

NOTE

- This function is available only when the discs are recorded with multiple angles.
- The angle mark on the screen can be turned off using the setup menu of the DVD player.

ADVANCED OPERATIONS

TV System Selection

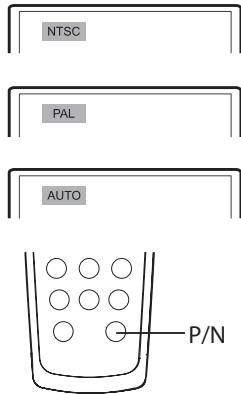

While you will want to set the video output system (NTSC/PAL) to the same as that supported by your TV, realize that the DVD player will convert any content that is not in the format your TV understands. The default output is NTSC for North America.

Press the **P/N** button on the remote control to cycle the video output to PAL, NTSC or AUTO system. The TV screen displays the selected system name.

Some points to keep in mind:

- When the video output is set to PAL or NTSC system, the DVD player will convert the disc content to the selected system if it is different.
- When the video output is set to AUTO, the DVD player will **not** perform system conversion. The AUTO mode is only to be used if your TV supports **both** NTSC and PAL systems.
- Playback must be stopped before switching the system from one setting to another.

NOTE

- Some TV sets only support one of the NTSC or PAL systems. If the wrong output is selected, the TV may not display a picture. In this case repeatedly press the **P/N** button until a supported system is selected.
- The output system selection chosen with the **P/N** button will be reset when the DVD player is turned off. To permanently set the output system, please use the “**TV Type**” setup menu item in the “**Preference**” setup menu page. (Refer to page 58 for details.)

Zooming and Aspect Ratio Control

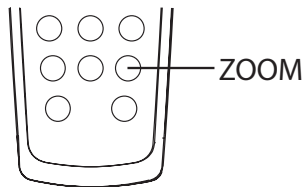

The feature zooms in or out the displayed frame, and changes the aspect ratio (image width vs. height).

To change the zoom level, press the **ZOOM** button on the remote control. Each press of the **ZOOM** button will switch the zoom level in sequence.

Zoom Levels for HDMI Output

The following zoom levels are available when HDMI output is used:

1:1 (No zooming) → Stretch/Pillar Box/Letterbox → Full Screen
→ Under Scan → 1.2 → 1.3 → 1.5 → 2.0 → ½ → Back to 1:1 again

The zoom level is reset to 1:1 when the disc is ejected, or when the player is turned off.

The available zoom level depends on the “**TV Display**” setting in the setup menu and the aspect ratio of the DVD disc. The following zoom levels may be useful for some special applications:

- 1) Playing 16:9 DVD when “**TV Display**” is set to “**16:9 Wide**” or “**16:9 Wide/Auto**”
 - Stretch – The image is vertically stretched by 1.33 times. For movies with 2.35:1 aspect ratio, this zoom level cuts off the black borders at the top and bottom of the image. Users of projector with anamorphic lens may find this mode helpful.

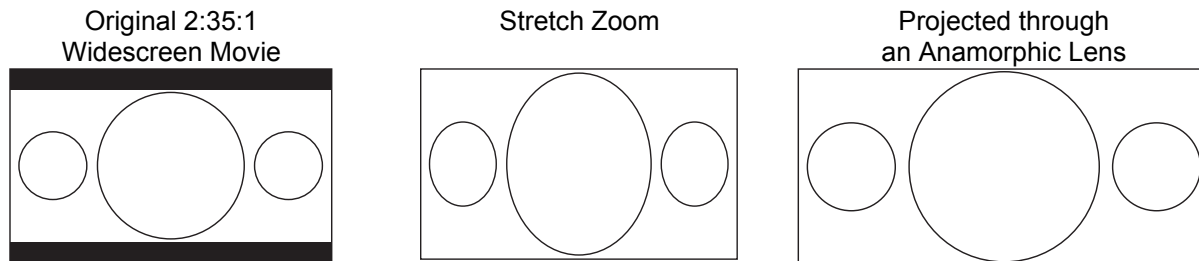

- Full Screen – The image is stretched by 1.33 times on both vertical and horizontal directions. For movies with 2.35:1 aspect ratio, this zoom level cuts off the black borders at the top and bottom of the image while maintaining the correct aspect ratio. The left and right sides of the image are slightly cropped.

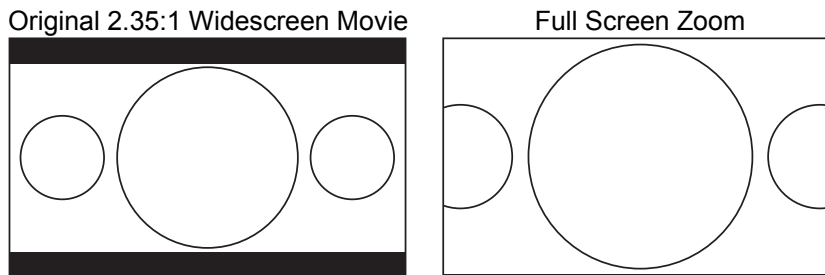

- 2) Playing 4:3 DVD when “**TV Display**” is set to “**16:9 Wide**”

- 1:1 - The image fills up the entire 16:9 screen but is horizontally stretched. Figures may look shorter and wider than they should be.
- Pillar Box – The player maintains the correct 4:3 aspect ratio and adds borders to the left and right sides of the image. The brightness level of the borders can be set by the “**Border Level**” setting in the “**General Setup Page**” of the setup menu.
- Full Screen – This zoom level maintains the correct aspect ratio but crops the top and bottom slightly in order to fit the 4:3 image to the 16:9 screen.

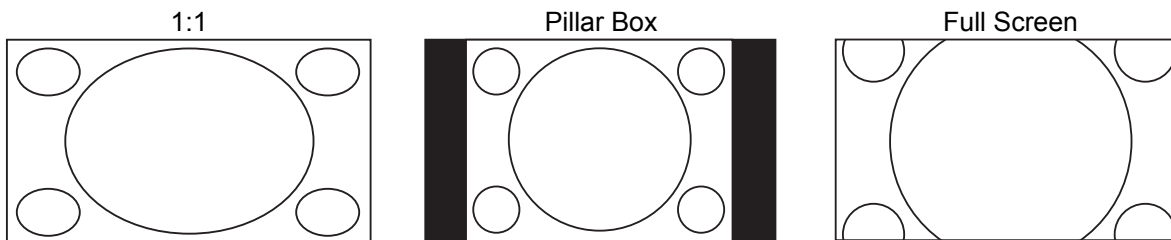

3) Playing 4:3 DVD when "TV Display" is set to "16:9 Wide/Auto"

- 1:1 – The player maintains the correct 4:3 aspect ratio and adds borders to the left and right sides of the image. The brightness level of the borders can be set by the "Border Level" setting in the "Video Setup Page" of the setup menu.
- Stretch – The image is horizontally stretched by 1.33 times. This zoom level fills up the 16:9 screen, but figures may look shorter and wider than they should be.
- Full Screen – This zoom level maintains the correct aspect ratio but crops the top and bottom slightly in order to fit the 4:3 image to the 16:9 screen.

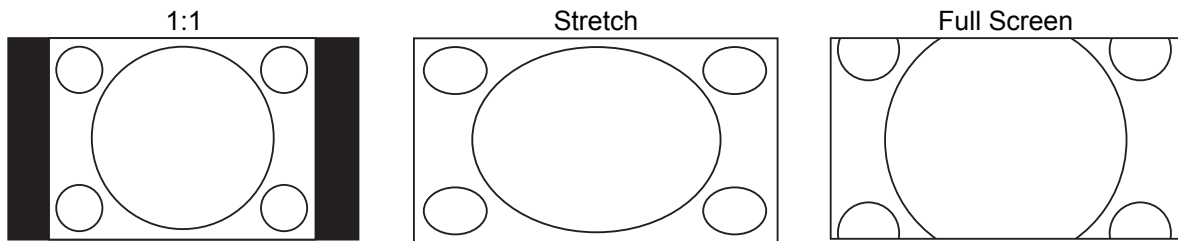

4) Playing 16:9 DVD when "TV Display" is set to "4:3 Pan/Scan"

- 1:1 – The player disregards the aspect ratio and fills the 4:3 screen. Figures may look taller and narrower than they should be.
- Letterbox – The player maintains the correct 16:9 aspect ratio and adds borders to the top and bottom of the image. The brightness level of the borders can be set by the "Border Level" setting in the "Video Setup Page" of the setup menu.
- Full Screen – The player maintains the correct aspect ratio but crops the left and right slightly in order to fit the 16:9 image to the 4:3 screen.

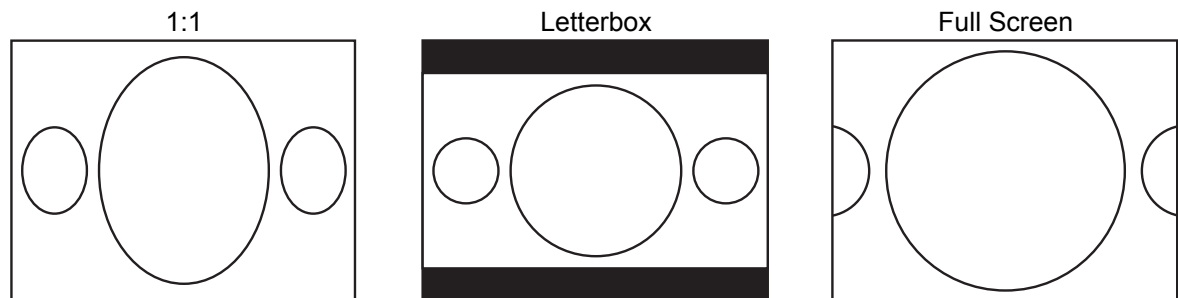

5) Playing 16:9 DVD when “**TV Display**” is set to “**4:3 Letterbox**”

- 1:1 - The player maintains the correct 16:9 aspect ratio and adds borders to the top and bottom of the image. The brightness level of the borders can be set by the “**Border Level**” setting in the “**Video Setup Page**” of the setup menu.
- Stretch – The player disregards the aspect ratio and fills the 4:3 screen. Figures may look taller and narrower than they should be.
- Full Screen – The player maintains the correct aspect ratio but crops the left and right slightly in order to fit the 16:9 image to the 4:3 screen.

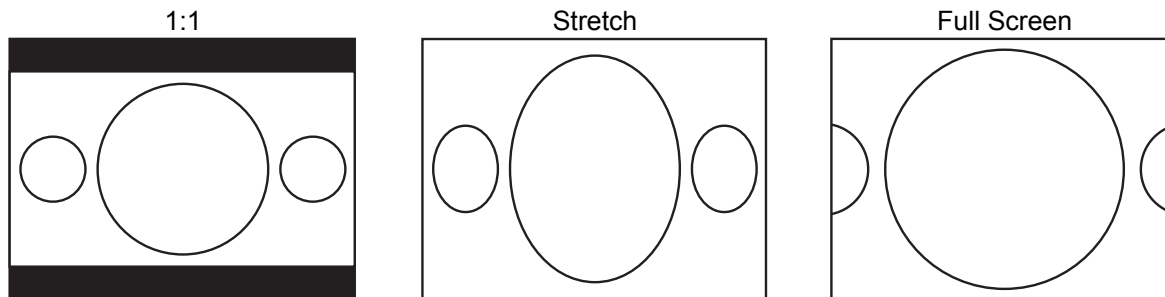

6) Playing 4:3 DVD when “**TV Display**” is set to “**4:3 Pan/Scan**” or “**4:3 Letterbox**”

- Stretch – The image is vertically stretched by 1.33 times. For anamorphic widescreen movies published in 4:3 format, this zoom level cuts off the black borders at the top and bottom of the image. Figures may look taller and narrower than they should be.
- Full Screen - The image is stretched by 1.33 times on both vertical and horizontal directions. For anamorphic widescreen movies published in 4:3 format, this zoom level cuts off the black borders at the top and bottom of the image while maintaining the correct aspect ratio. The left and right sides of the image are slightly cropped.

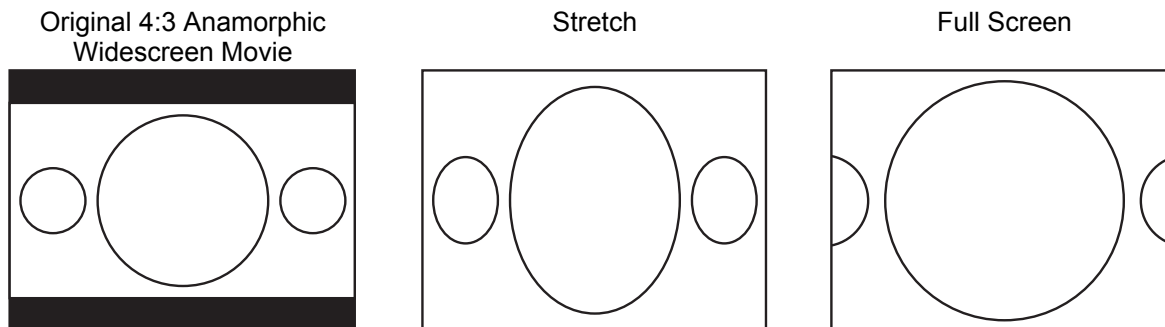

The “Under Scan” zoom level shrinks the image by 5%. This zoom level may be used to compensate for TVs that over scan, so the viewer can see the entire image area on the DVD with no cropping. All other zoom levels are indicated by their respective zoom ratio.

Zoom Levels for Component Video Output

The following zoom levels are available when component video output is in use:

1.0 (No zooming) → 1.2 → 1.5 → 2X → 2.5 → 3X
 → 3.5 → 4X → ½ → ⅓ → ¼ → Back to 1.0 again

Fast Playback



You may fast forward or reverse to search for a certain point during playback.

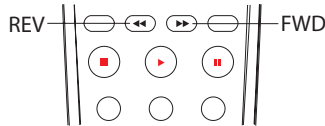

1. Press the **FWD** button on the remote control and the player starts fast forward playback. Each press of the **FWD** button switches the playback speed in the following sequence:



2. Press the **REV** button on the remote control and the player starts fast reverse playback. Each press of the **REV** button switches the playback speed in the following sequence:



Slow Playback

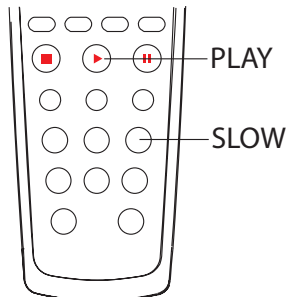

To slow down the playback speed, please use the following steps.

1. Press the **SLOW** button on the remote control and the player starts slow playback. Each press of the **SLOW** button switches the playback speed in the following sequence:



2. Press the **PLAY** button during slow playback to resume normal playback speed.

Repeat, Random and Shuffle Playback

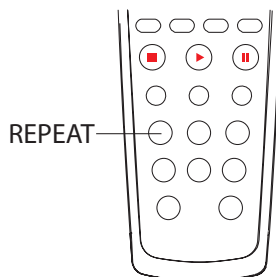

To repeat a certain chapter, title, track or disc, press the **REPEAT** button on the remote control.

Each press of the **REPEAT** button switches the repeat mode in the following sequence:

DVD, DVD-Audio disc:



CD disc:



SACD disc:

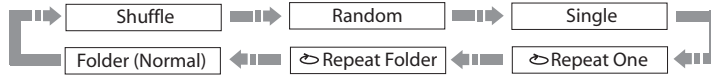

NOTE

In normal playback mode, each track is played back in sequential order. As the name implies, the random playback mode randomly selects a track to play. The shuffle mode also plays back the tracks in random order, but it ensures that each track is played only once.

Repeat the Selected Section



To repeatedly play a specified section, please follow these steps:

1. During normal playback, press the **A-B** button on the remote at the desired beginning point (Point A) for the repeat play.

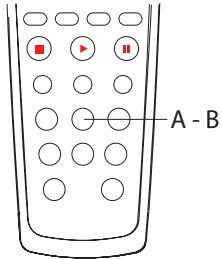

2. When playback reached the desired ending point (Point B) for the repeat play, press the **A-B** button again.



3. The player now repeatedly plays back the specified section (A-B).
4. Press the **A-B** button for the third time to resume normal playback.

NOTE

Not available for all disc formats or contents.

Playback by Track Number



CD discs

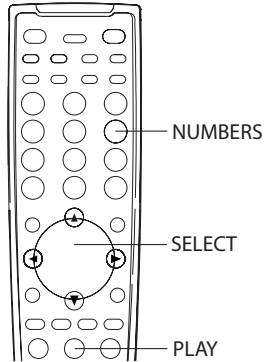

Insert disc. After the player begins reading the disc, press the **NUMBER** buttons on the remote control to select the track for playback.

- Press the **NUMBER** buttons **1-9** to directly select the corresponding chapter/track if the chapter/track number is below 10. For example, to select the seventh track, press the **[7]** button.

⑦

- Press the **+10** button and then the **NUMBER** buttons **0-9** to directly select the corresponding chapter/track if the chapter/track number is above 10 (including 10).
- For example, to select the 16th track, press **[+10]** followed by **[6]**:

¹⁰ + ⁶
Ⓡ Ⓡ

- To select the 25th track, press **[+10]** twice followed by **[5]**.

SACD discs

Insert disc. After the player begins reading the disc, enter the track number directly and press the **SELECT** button to select the track for playback.

Playback from a Specific Location



DVD discs

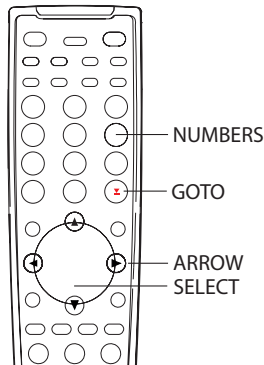

You may specify a point to start playback by entering the title, chapter or time directly. When playing DVD discs, each press of the **GOTO** button switches the search mode in the following sequence:

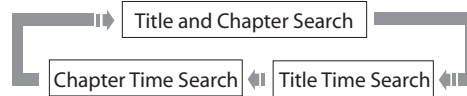

1. **Title and chapter search.** For example, search for Title 6, Chapter 2:

- Press the **GOTO** button on the remote, and the TV screen displays:

Title █/30 Chapter 00/00

(You may need to use the **ARROW** buttons to move the cursor to the "Title" location.)

- Enter the title number **6**. The cursor moves to the “Chapter” location and the TV screen displays:

Title 06/30 Chapter █ /02

- Enter the chapter number **2**. The TV screen displays:

Title 06/30 Chapter 02/02

- Playback starts from the specified title and chapter.

NOTE

To enter a number greater than 9, use the **+10** button.

- Title time search.** For example, search for a specified elapsed time within the currently playing title.

- Repeatedly press the **GOTO** button until the TV screen displays the following picture. Use the **NUMBER** buttons to enter the HOUR, MINUTE and SECOND.

Title 06/30 Time: :-:--

- Chapter time search.** For example, search for a specified elapsed time within the currently playing chapter.

- Repeatedly press the **GOTO** button until the TV screen displays the following picture. Use the **NUMBER** buttons to enter the HOUR, MINUTE and SECOND.

Chapter 02/02 Time: :-:--

CD discs

You may specify a point to start playback by entering the disc elapsed time, track elapsed time or track number directly. When playing CD discs, each press of the **GOTO** button switches the search mode in the following sequence:

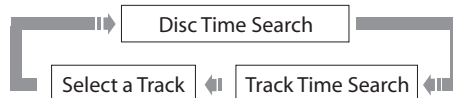

- Disc time search**

- Repeatedly press the **GOTO** button until the TV screen displays the following picture. Use the **NUMBER** buttons to enter the MINUTE and SECOND.

Disc Go To: --:--

- Track time search**

- Repeatedly press the **GOTO** button until the TV screen displays the following picture. Use the **NUMBER** buttons to enter the MINUTE and SECOND.

Track Go To: --:--

- Select a track**

- Repeatedly press the **GOTO** button until the TV screen displays the following picture. Use the **NUMBER** buttons to enter the track number. For track numbers greater than 9, please press the **+10** button first.

Select Track: █ /12

Bookmarks



This function lets you bookmark positions of a disc so you can quickly return to them at a later time.

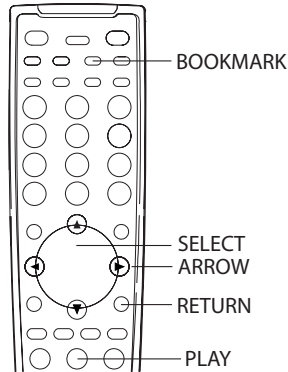

1. Press the **BOOKMARK** button on the remote control to show the bookmark selection box:
2. Press the **ARROW** buttons to highlight an unused bookmark position.
3. When playback reaches the position you want to bookmark, press the **SELECT** button. The title, chapter/track and elapsed time will appear on the screen.
4. You may continue to make more bookmarks or press the **BOOKMARK** button to exit the bookmark selection box.
5. To recall a bookmarked position later, press the **BOOKMARK** button to show the bookmark selection box. Use the **ARROW** buttons to select the desired bookmark, and then press the **SELECT** or **PLAY** button to jump to the marked position.
6. To clear an existing bookmark, show the bookmark selection box and highlight the bookmark to be cleared, and then press the **RETURN** button on the remote control.

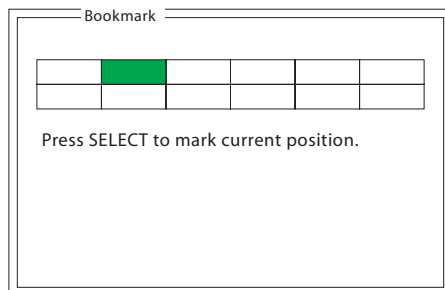

NOTE

All bookmarks are cleared once the disc is ejected or the player is turned off. To memorize a playback position across disc ejection and power cycles, please use the "Memory and Automatic Resume" function.

Memory and Automatic Resume

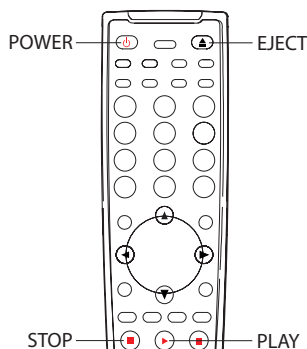

1. The DVD player automatically remembers the current position when playback is interrupted. Operations such as **EJECT**, **STOP** or turning **POWER** off will cause the DVD player to save the current playing position.
2. The position is memorized even after turning off the unit or changing the disc.
3. When the next time the disc with a memorized playing position is played back, the DVD player will recognize the saved playing position. Playback will automatically resume from the saved playing position. However if you wish to cancel the automatic resume and start playback from the beginning, you may press the **STOP** button when prompted.
4. The DVD player can remember playback position for up to 5 discs. When the sixth disc is memorized, the oldest one is replaced.
5. This function applies to DVD discs only.

Viewing Static Pictures on DVD-Audio Discs

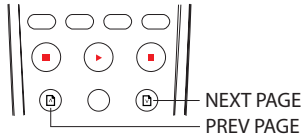

Some DVD-Audio discs contain static pictures, such as photos of the band or narration of the album. When a DVD-Audio track is playing, you may use the **PREV PAGE** button (same as the **SUBTITLE** button) to select the previous picture or the **NEXT PAGE** button (same as the **ANGLE** button) to select the next picture.

Disc Information Browser



The disc information browser enables you to conveniently view the disc information, perform disc navigation, and control playback. The following example shows how to use the disc browser during DVD playback.

1. Press the **INFO** button on the remote control. The TV screen displays the following:



▶ MENU	
	Disc Format D5 DISC
	Video Type NTSC
	Video Scale 4:3
	Title 01/01 ▾
BITRATE 85 ■■■■■■■■■■ TITLE ELAPSED: 0:01:25	

- Video preview in the top half of the screen
- Disc information in the lower half of the screen
- Current bit rate (unit: 100kbps) and playback time at the bottom of the screen

2. Press the up/down **ARROW** buttons to select an item in the disc information display. If the selected item allows modification, press the **SELECT** button to make selections or modifications.



▶ MENU	
	Video Type NTSC
	Video Scale 4:3
	Title 01/01
	Chapter _0/05 ▾
BITRATE 85 ■■■■■■■■■■ TITLE ELAPSED: 0:01:25	

- For example, to navigate to a specific chapter, press the up/down **ARROW** buttons to select the “Chapter” item, and then press the **SELECT** button.



▶ MENU	
	Video Type NTSC
	Video Scale 4:3
	Title 01/01
	Chapter 04/05 ▾
BITRATE 85 ■■■■■■■■■■ TITLE ELAPSED: 0:01:25	

- Press the **NUMBER** buttons to select the desired chapter. To select the 4th chapter, press 0 and 4.

3. To exit the disc browser, press the **INFO** button again.

Playing Digital Video, Audio and Picture Files

The DVD player presents a disc navigation menu for SACD discs and data discs containing digital video (such as XviD), digital audio (such as WMA) or digital picture files. The disc navigation menu contains the following components:



1. Status Window – Displays the current status information
2. Directory Window – Displays the current directory path
3. File Window – Lists the files in the current directory
4. Scroll Bar – Indicates the position of the current file in the directory
5. Preview Window – Picture preview or other file information
6. Information Window – Displays file information or operation prompts

If “**Auto Play Mode**” is turned on in the “**General Setup Page**” of the setup menu (see page 45 for details), the DVD player automatically starts playing the first file/track when a data or SACD disc is inserted. To cancel auto play and see a list of available files on the disc, press the **STOP** or **MENU** button.

You may switch between the file listing mode and directory listing mode using the **ANGLE** button on the remote control. In the file listing mode all files in the disc are listed in a flat view. In the directory listing mode the files are listed according to the directory structure of the disc.

The Status Window contains the following elements:

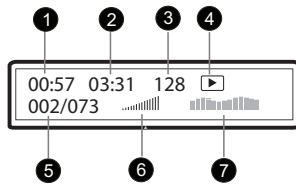

1. Elapsed play time of the current digital audio file
2. Total play time of the current digital audio file
3. The audio bit rate
4. Current playback mode indicator (play/stop/pause)
5. Track indicator
6. Volume indicator
7. Dynamic frequency power spectrum meter

When a disc is first loaded into the player, it may take a few moments to search the compatible files and build the disc navigation menu. Please be patient.

To navigate the disc navigation menu:

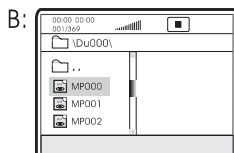
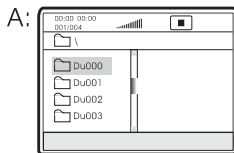

- Press the up/down **ARROW** buttons to select the desired directory and press the **SELECT** button to enter it.
- To return to the previous level of directory, select the [] directory in the first line, or press the left **ARROW** button.
- If a directory contains many files, you may press the **PREV** or **NEXT SKIP** button to jump to the previous or next page of the directory listing.
- Press the up/down **ARROW** buttons to select the digital video, audio or picture file. If a preview image or additional information is available, the preview will appear in the preview window.
- Press the **SELECT** button to play the file. Video files will be decoded and played back. Digital music files will start playing, and pictures will be displayed in full screen slide show mode.

Digital Music Play Operations

When playing digital music files, the following operations are available:

- **Repeat, Shuffle or Random Playback** – Press the **REPEAT** button on the remote control to switch the playback mode.
- **Skip** – While a song is playing, the **SKIP PREV** and **SKIP NEXT** buttons can be used to skip to the previous or next song. You may also use the **ARROW** buttons on the remote control to highlight the song to play, and then press the **SELECT** button. When playback is stopped, the **SKIP PREV** and **SKIP NEXT** buttons are used to move the cursor to the next or previous page of the song list.

Digital Picture Play Operations

When a picture is displayed in full screen slide show mode, the following operations are available:

If the picture is displayed in high definition (“**Photo Mode**” set to “**HD**” in the “**General Setup Page**” of the setup menu), you may:

- Press the **SLOW** button to adjust the speed of the slide show.
- Press the **MENU** button to stop the slide show and return to the disc navigation menu.
- Press the **STOP** button to stop the slide show and display the pictures in thumbnail mode.
 - Press the **PREV** or **NEXT SKIP** button to display the previous or next page of thumbnails;
 - Use the **ARROW** and **SELECT** buttons to select a picture to display;
 - Use the **NUMBER** buttons to directly select a picture to display.

If the picture is displayed in standard definition (“**Photo Mode**” set to “**SD**” in the “**General Setup Page**” of the setup menu), you may:

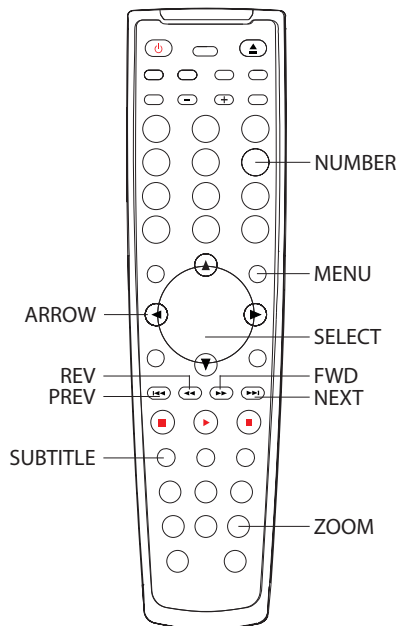

- Press the **SLOW** button to adjust the speed of the slide show.
- Press the **SUBTITLE** button to switch among various picture transition modes.
- Press the **ZOOM** button to start the zoom in/out function. The TV screen displays “Zoom 100%”
 - While in the zoom mode, press the **FWD** or **REV** button to change the zoom ratio. Available zoom ratios are from 50% to 200%.
 - When the picture is magnified larger than the screen, you may use the **ARROW** buttons to move the visible area in the picture frame (Panning).
 - To exit the zoom mode, press the **ZOOM** button again.
- Press the **STOP** button to stop the slide show and display the pictures in thumbnail mode. You may:
 - Press the **PREV** or **NEXT SKIP** button to display the previous or next page of thumbnails;
 - Use the **ARROW** and **SELECT** buttons to select a picture to display;
 - Use the **NUMBER** buttons to directly select a picture to display.

- Press the **MENU** button to stop the slide show and return to the disc navigation menu.

- Press the **ARROW** buttons to rotate or flip the picture:
 - UP: Invert
 - DOWN: Mirror
 - LEFT: Rotate counter-clockwise
 - RIGHT: Rotate clockwise

Playing a Disc with Both Digital Audio and Picture Files

If the disc contains both digital audio and picture files, you can enjoy both of them simultaneously. First navigate to the folder that contains the digital audio files and start the audio playback. Next you can navigate to the folder that contains the digital picture files and start the slide show. The slide show will start with the already playing digital audio as background music.

Use of USB Device

This DVD player is equipped with a USB port on its back panel. You may use the USB port to play digital video, audio and picture files stored on compatible USB drives.

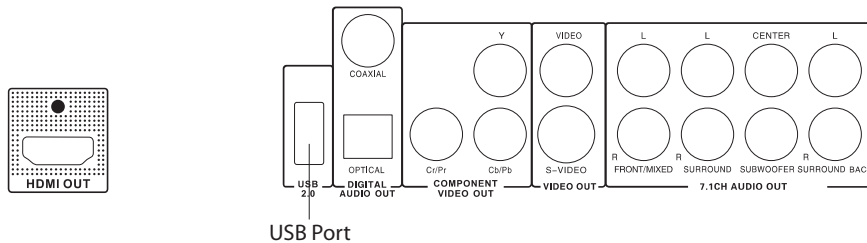

Please connect the USB device to the USB port of this DVD player using a compatible USB cable. Press the **DVD/USB** button on the remote control. A device selection menu will appear.

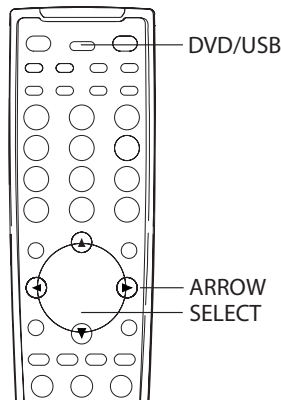

Use the **ARROW** and **SELECT** buttons to select the USB SLOT. The DVD player will start reading the files stored in the USB device and present the disc navigation menu. Please refer to page 41 for detail instructions. The “**Auto Play Mode**” setting in the “**General Setup Page**” of the setup menu does not apply to USB devices. You must start playback manually by selecting a file and press the **PLAY** or **SELECT** button.

NOTE

- This unit supports “USB Mass Storage Class Bulk-Only Transport” devices only. Most USB thumb drives, portable hard disk drives and card readers conform to this device class. Other USB devices such as MP3 players, digital cameras, and mobile phones may not be compatible. It is not possible to connect this unit to a personal computer for USB playback.

- Supported USB drives must be formatted with the FAT (File Allocation Table) or FAT32 file system. Drives formatted with NTFS file system are not supported.
- The play can index approximately 600 file and folder names. Disks containing more than 600 files and folders may not play properly. It may take the player longer time to read the contents of a large disk.
- If the USB drive is incompatible, or the player encounters errors while reading the USB drive or flash memory card, the screen displays “Device Error”. In this case please verify that the USB drive is compatible, and try to unplug the device and re-insert again.
- In some cases, an incompatible USB device may cause the player to stop responding. If this occurs simply turn off the power, remove the USB device, and turn the player back on.
- OPPO cannot guarantee compatibility with all USB devices and assumes no responsibility for any loss of data that may occur when connected to this unit.

Audio-Only Mode



You can enjoy higher quality audio by turning off the video processing and output. The Audio-Only mode reduces interference between the video and audio signals.

1. Press the **AUDIO ONLY** button on the remote control to turn off video and enter Audio-Only mode. After a short delay, video output will be turned off. The “A. ONLY” icon will be illuminated on the front panel of the DVD player. During the short delay before Audio-Only mode is engaged, you may cancel it by pressing the **AUDIO ONLY** button again.
2. Press the **AUDIO ONLY** button again to resume video and cancel Audio-Only mode.

NOTE

Audio-Only mode is cancelled if the unit is switched to STANDBY.

Customized Background Screen

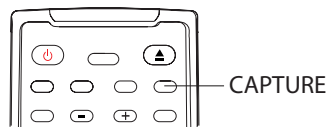

The OPPO DVD player supports customization of the background screen. While playing a movie, you can press the **CAPTURE** button on the remote control to capture a scene as the customized background screen of your DVD player. Once a new background is successfully captured, the DVD player will show the customized background screen instead of the OPPO background screen when playback is stopped.

To restore the original OPPO background screen, please set the “**Background**” item in the “**General Setup Page**” of the DVD player’s setup menu to “**Default**”. Refer to page 45 for details about this setup menu item.

SETUP MENU OPTIONS

The Setup Menu of the DVD player presents many setup and configuration options. For most users, the default configuration works well enough and there is no need to change the settings. However if you need to configure the DVD player to perfectly match your home theater settings and viewing preference, please refer to the following sections for details about each configuration option. The basics of how to operate the setup menu system have already been discussed in the “*Installation*” section of this guide on page 18.

General Setup Page

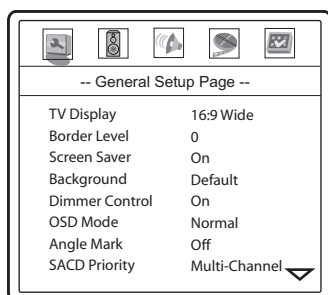

1. **TV Display:** To set the aspect ratio of the player's output image to match your TV. The options are :
 - **4:3 Pan/Scan** – Choose when the display is 4:3. Widescreen image will be stretched.
 - **4:3 Letterbox** – 4:3 TV Letterbox. Choose when the display is 4:3. Widescreen image is displayed in “letterbox” format with black borders on top and bottom.
 - **16:9 Wide** – Choose when the display is 16:9. 16:9 materials will be displayed in its native aspect ratio, and 4:3 materials will be stretched.
 - **16:9 Wide/Auto** – 16:9 TV Wide/Auto Pillarbox Mode. Choose when the display is 16:9. 16:9 materials will be displayed in its native aspect ratio, and 4:3 materials will be displayed with black borders on both sides to maintain 4:3 aspect ratio.
2. **Border Level:** To set the brightness level of the border area when borders are inserted by the DVD player to maintain correct aspect ratio. The default level is 0, which corresponds to total black. If you set it to 3 or 4, the bars become grey instead of black. This setting may be useful for users with Plasma or CRT TVs that are sensitive to “burn-in” issue. A grey border setting allows the phosphor in the bar area to be moderately used, and can alleviate the burn-in problem. The Border Level setting only applies to the HDMI output, and only affects borders inserted by the DVD player. If the borders are encoded in the original video, the border brightness level will not be affected by this setting.
3. **Screen Saver (on/off):** To turn on/off the screen saver function. When the screen saver is on, video output will be turned off after 2 minutes of inactivity. This is designed to minimize the burn-in issue for plasma and CRT display devices. Many projectors and LCD TVs will go into a standby or sleep mode and turn off their projection lamp or LCD backlight lamp, thus save energy and prolong the lamp life. When you press any button on the OPPO remote control or player front panel, the screen saver will be cancelled and video output will be restored. If your TV is already in standby or sleep mode, you may need to wake up the TV by pressing a button on its remote or control panel.

4. **Background:** To select what background screen the DVD player shows when it is not playing a disc. The available options are:
 - **Default** – Show the factory-installed background screen.
 - **Captured** – Use the customer-captured image as the background screen.

5. **Dimmer Control:** To control the display intensity of the Vacuum Fluorescent Display (VFD) information window. In case you feel that the display becomes a distraction to your enjoyment of the video, this option allows you to dim it or turn it off. The available options are:
 - **On** - The VFD window is at normal brightness.
 - **Dim** - The VFD window is at reduced brightness.
 - **Off** – The VFD window is turned off. In this mode the display resumes momentarily when there is any user operation.

6. **OSD Mode:** To select how long the on-screen display information, such as elapsed or remaining time, stays on the TV screen. The available options are:
 - **Normal** – On-screen display information stays on the TV screen until the user cancels it.
 - **Silent** – On-screen display information shows on the TV screen momentarily and then disappears. The front panel display still maintains the selected display information.

7. **Angle Mark (on/off):** To turn on/off the display of angle mark when a DVD disc with multiple available angles is played. Keeping the angle mark off avoids distraction from normal movie watching.

8. **SACD Priority:** To select which audio layers to play for SACD (Super Audio CD). The options are:
 - **Multi-Channel** – Play the multi-channel surround audio
 - **Stereo** – Play the 2-channel stereo audio
 - **CD Mode** – Play the CD layer of a hybrid SACD disc

The SACD Priority setting is changed every time you use the **AUDIO** button to switch layer while playing an SACD disc.

9. **DVD-Audio Mode:** To select which portion of a hybrid DVD-Audio disc to playback. The options are:
 - **DVD-Audio** – Play the DVD-Audio portion of the disc with high-resolution audio
 - **DVD-Video** – Play the DVD-Video portion of the disc with Dolby Digital or DTS audio

10. **Subtitle Font:** To select the subtitle font size for digital video such as XviD. There are three font sizes available. This setting applies only to video files with a text subtitle. Video files with a graphic subtitle do not use the DVD player's built-in font, so the font size cannot be adjusted.

11. **Photo Mode (HD/SD):** To select whether to render digital photo files in high definition (HD) mode or standard definition (SD) mode. HD mode will result in a display with finer details and higher resolution, but special slide show effects such as transition, rotation, and flipping are not available. SD mode displays the image in lower resolution. Special slide show effects can be applied to photos displayed in SD mode. Please refer to page 42 for available operations.

12. **Auto Play Mode (on/off):** To select whether the DVD player shall start playing an audio CD, SACD or a disc containing digital video, audio and picture files automatically. When auto play mode is turn on, these discs will start playing upon insertion into the player. When auto play

mode is turned off, the player will wait for the user to start playback by pressing the **PLAY** or **SELECT** button.

13. **Alt RC Code (on/off):** To turn on or off the DVD player's response to a set of alternative remote control code. The alternative remote control code enables users to program their universal remote controls that comes with TV, Projector or A/V Receiver to operate the DVD player. If the universal remote control has a DVD player control function, please program it with the code for TOSHIBA, PHILIPS, MAGNAVOX, MARANTZ or ZENITH DVD players. Since each brand of remote control may have several sets of codes, you may need to try several times using different codes to get the working one. In case you do not want the DVD player to respond to the alternative remote control code, you may turn off this option.

Speaker Setup Page

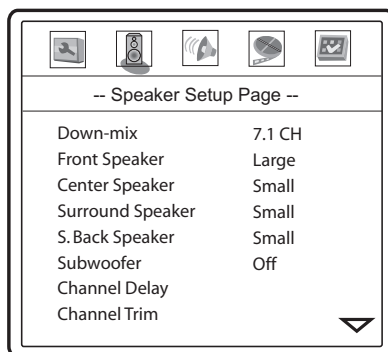

1. **Down-mix Mode:** To set the audio down-mix mode for converting multi-channel audio into two-channel output. This setting affects the analog and HDMI audio outputs. The options are:
 - **Lt/Rt** – Dolby Pro Logic II Left Total/Right Total. This mode is intended for use with two-channel Dolby Pro Logic II receivers. The center and surround channels are mixed into the two front channels according to the Lt/Rt matrix. A Dolby Pro Logic II receiver will decode the two-channel audio into surround audio.
 - **Stereo** - This mode down-mixes decoded multi-channel (5.1ch) audio to 2-channel stereo output. For original stereo content the output will still be stereo. For original multi-channel content the surround and center channels will be mixed with the left and right front channels. Recommended for use with TV sets or stereo receiver/amplifiers.
 - **V. Surround** - Virtual Surround. This mode creates a virtual surround effect from stereo or multi-channel audio contents.
 - **5.1CH** – This mode enables 5.1ch decoded audio output. The number of actual output channels depends on the disc.
 - **7.1CH** – This mode enables 7.1ch decoded audio output. The number of actual output channels depends on the disc. For 6.1ch contents, the left and right surround back speakers will both output the same surround back audio channel. 7.1CH output is available only through the analog audio output jacks.

2. **Front Speaker:** To set the sound filtering control for the front speakers. The options are:
 - **Large** – Choose if the front speakers are large. Bass frequencies are passed to the front speakers.
 - **Small** – Choose if the front speakers are small. Bass frequencies are not passed to the front speakers to reduce possible distortion.

3. **Center Speaker:** To set the sound filtering control for the center speaker. The options are:
 - **Large** – Choose if the center speaker is large. Bass frequencies are passed to the center speaker.
 - **Small** – Choose if the center speaker is small. Bass frequencies are not passed to the center speaker to reduce possible distortion.
 - **Off** – Choose if there is no center speaker.

4. **Surround Speaker:** To set the sound filtering control for the surround speakers. The options are:
 - **Large** – Choose if the surround speakers are large. Bass frequencies are passed to the surround speakers.

SETUP MENU OPTIONS

- **Small** – Choose if the surround speakers are small. Bass frequencies are not passed to the surround speakers to reduce possible distortion.
 - **Off** – Choose if there are no surround speakers.
5. **S. Back Speaker:** To set the sound filtering control for the surround back speakers. The sound filtering control for the surround back speakers always follow the surround speakers. It is not possible to set the surround and surround back speakers to different sizes. You may set the surround back speakers to “**Off**”, however if this is your speaker configuration you should really choose “**5.1CH**” as the “**Down-mix**” mode.
6. **Subwoofer:** To enable/disable the subwoofer output. The options are:
- **On** – Subwoofer output is enabled.
 - **Off** – Subwoofer output is disabled.
7. **Channel Delay:** To set the delay time for the center, surround, surround back speakers and the subwoofer. The delay is to compensate for the audio propagation time difference caused by the placement of speakers.

Channel delay is generally not required since most A/V receivers have the capability to adjust channel delay and compensate for speaker distance differences. However if your receiver does not have such functions, you may adjust channel delay on the DVD player. Channel delay is only applied if the player is decoding multi-channel audio. If you use raw bit-stream audio output to your A/V receiver, the raw bit-stream audio is not adjusted for channel delay.

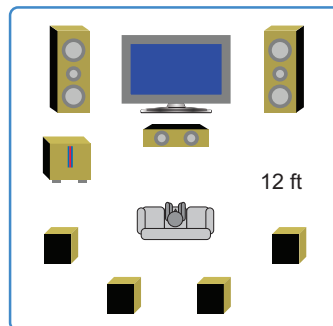

- Press the up/down **ARROW** buttons to select the speaker to set the distance.
- Press the left/right **ARROW** buttons to adjust the distance.
- Press the **SELECT** button to confirm the settings and return to the Speaker Setup Page.

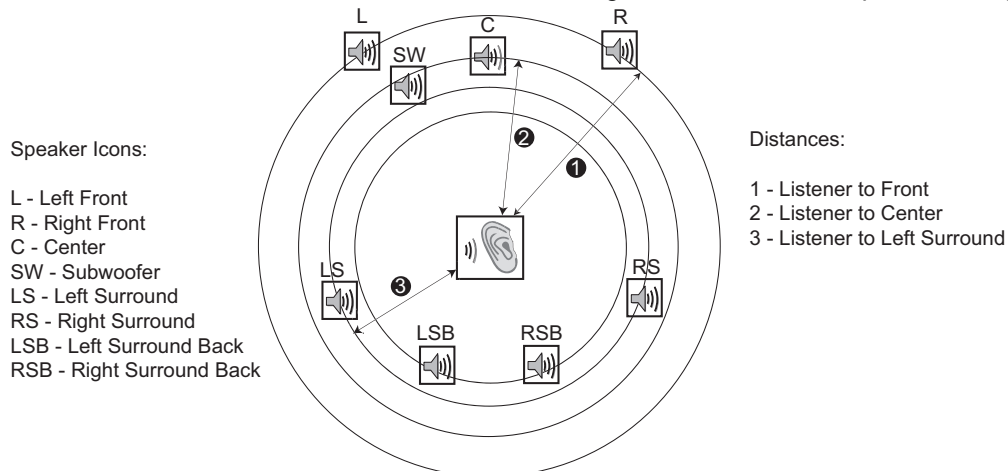

SETUP MENU OPTIONS

For example, in the above diagram, measure the distance (in feet) from the primary listening position to the Front Left or Front Right Speaker. Your Front Right and Left speakers should measure the same distance. If they do not, please adjust them if possible. Enter the distance of the Front Speakers (❶ in the above picture) using the left/right **ARROW** buttons.

Next, measure the distance (in feet) from center speakers (❷) to the listening position. Move the cursor to highlight the Center speaker in the Channel Delay setup page, and enter the distance (as close as possible) in feet using the left/right **ARROW** buttons. Repeat for each speaker in the system (Center, Left Surround, Right Surround, Left Surround Back, Right Surround Back and Subwoofer) as available. The DVD player will insert appropriate delay to the center, subwoofer and surround channels to make sure sound wave from different speakers arrive at the listener at the same time.

Distance between the surround speakers and the listener must be **shorter than or equal** to that between the front speakers and the listener.

In case the channel delay settings cannot match your speaker configuration, please set all distances to the same and use your receiver/amplifier to set the channel delay.

Example Channel Delay Adjustment:

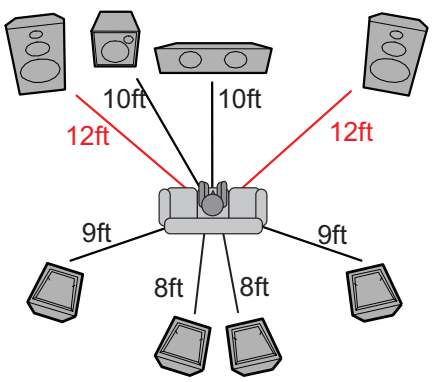
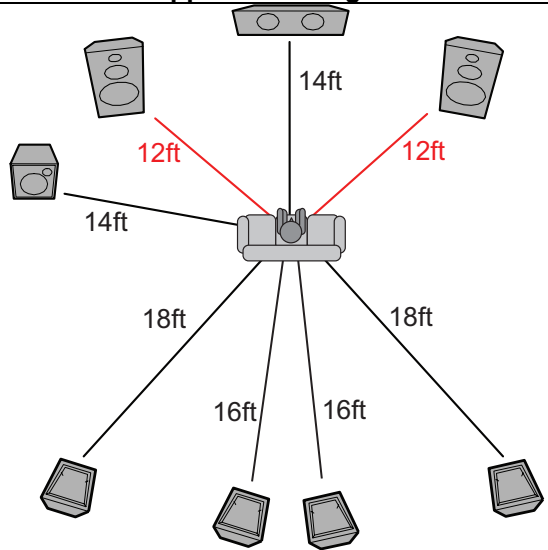
Supported Configuration	Unsupported Configuration
	
<p>Settings: Front Speakers – 12ft Center Speaker – 10ft Subwoofer – 10ft Left Surround – 9ft Right Surround – 9ft Left Surround Back – 8ft Right Surround Back – 8ft</p>	<p>Settings: Front Speakers – 12ft Center Speaker – 12ft Subwoofer – 12ft Left Surround – 12ft Right Surround – 12ft Left Surround Back – 12ft Right Surround Back – 12ft</p>

8. **Channel Trim:** To set the volume of each individual channel.

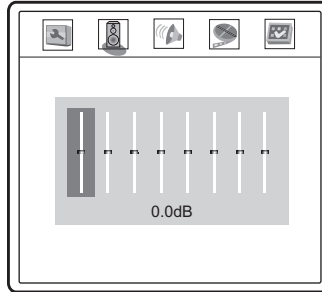

- Press the left/right **ARROW** buttons to select the channel to be adjusted.
- Press the up/down **ARROW** buttons to raise or lower the volume of the selected channel in 0.5dB increments.
- Press the **SELECT** button to confirm the settings and return to the **Audio Setup Page**.

Channel trim is generally not required since most A/V receivers have the capability to adjust channel trim and compensate for speaker sensitivity differences. However if your receiver does not have such functions (many receivers do not support channel trim for their multi-channel analog inputs), you may adjust channel trim on the DVD player. For most accurate results, it is recommended that you use test tones from a calibration disc, such as *AVIA Guide to Home Theater*, and a SPL (Sound Pressure Level) meter.

9. **Audio Delay:** To add delay to analog or PCM digital audio output. If you experience audio/video synchronization problem, you may use this option to add a slight delay to the audio so it is synchronized to the video.
- Press the left/right **ARROW** buttons to adjust delay. The audio delay can be adjusted in 10ms steps.
 - Audio delay does not apply to raw bit stream digital audio output.

Audio Setup Page

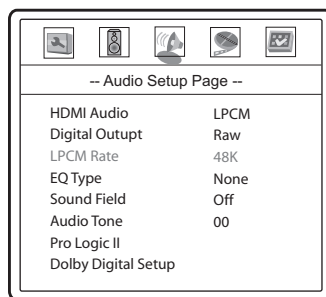

1. **HDMI Audio:** To select digital audio output from the HDMI port. The options are:
 - **LPCM** – Digital audio output via HDMI will be multi-channel Linear PCM format. The Down-mix setting in the “Speaker Setup Page” will affect whether and how multi-channel audio content will be down-mixed to stereo. When this option is selected, compressed audio bit streams will be decoded by the DVD player. This setting is recommended when connecting the HDMI output directly to a TV.
 - **Auto** – Digital audio output via HDMI will be the same as the digital coaxial/optical audio output for CD, Dolby Digital and DTS audio signals. For high resolution stereo or multi-channel audio contents such as DVD-Audio and Super Audio CD, the DVD player will send multi-channel PCM audio signals with the highest available sample frequency and bit numbers. Depending on the original audio content, the format could be 44.1kHz - 192kHz, 2 - 6 channels. This option is recommended when connecting the HDMI output to an A/V receiver or processor with HDMI v1.1 or above audio capabilities.
 - **Off** – No digital audio output via HDMI.

NOTE

If you use HDMI to connect audio to an HDMI A/V receiver or audio processor, it is recommended that you choose 720p or higher HDMI output resolution when playing high resolution audio content (DVD-Audio and SACD). According to the HDMI specification, the bandwidth available for audio is proportional to the total bandwidth used by video. At 480p/576p resolution, the HDMI specification can only support 2 channels of audio with high sample rate (up to 192kHz), or 8 channels of audio with standard sample rate (up to 48kHz). Depending on the capability of your A/V receiver or audio processor, if you play high resolution audio content at 480p/576p resolution, you may get reduced audio resolution, incomplete audio channels, or even no audio/video output at all. Choosing a high HDMI output resolution such as 720p or 1080i allows enough bandwidth for all high sample rate audio channels.

2. **Digital Output:** To set the bit stream type of the digital audio output for use with Dolby Digital and DTS-compatible receivers. The options are:
 - **Raw** – Passes the encoded multi-channel digital audio unaltered. Choose this setting if your receiver/amplifier is capable of decoding Dolby Digital and/or DTS.
 - **PCM** – Forces down-mixed 2-channel digital audio output. Choose this setting if your receiver/amplifier only supports stereo digital (PCM) audio.

3. **LPCM Rate:** To set the maximum Linear PCM output frequency. The options are:
 - **48K** – Supported by most equipment.
 - **96K** – Allows a higher sampling rate and frequency response. It can result in better audio quality. Ensure that the receiver/amplifier can support it.
 - **192K** – Allows the highest sampling rate and frequency response. It can result in the best audio quality. Ensure that the receiver/amplifier can support it.
4. **EQ Type:** To set the equalization pattern type. Available options are: None, Rock, Pop, Live, Dance, Techno, Classic and Soft.
5. **Sound Field:** To set the sound field effect. Available options are: Off, Concert, Living Room, Hall, Bathroom, Cave, Arena and Church.
6. **Audio Tone (+/-16):** This function raises or lowers the tone (key/pitch) of the audio track. This is useful for playing Karaoke discs and should not be used for regular music listening or movies.
 - Press the **SELECT** button to show the tone control window.
 - Press the left/right **ARROW** buttons to lower or raise the tone/pitch.
 - Press the **SELECT** button to confirm the setting.
7. **Pro Logic II:** Taking a step further than most DVD players, the OPPO DVD player allows you to configure Dolby Pro Logic II to expand 2-channel source audio into full 5-channel surround sound. **Note:** Pro Logic II functionality is effective only when **Speaker Setup Page > Down-mix** is set to “**5.1ch**” or “**7.1ch**” and **Digital Output** is set to “**Raw**”.
 - Press the **SELECT** button to enter the “**Pro Logic II Config**” page.
 - Press the left **ARROW** button to exit the “**Pro Logic II Config**” page.

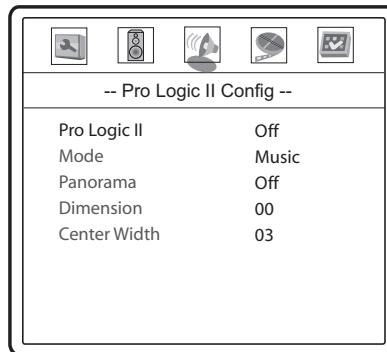

- A. **Pro Logic II:** To turn on or off the Pro Logic II processing. The options are:
 - **On** – Pro Logic II processing is always on
 - **Off** – No Pro Logic II processing
- B. **Mode:** To set the processing mode of Pro Logic II. The options are:
 - **Music** – The surround experience is tailored for multi-channel music playback
 - **Movie** – Emphasis is given to the center channel as two-channel audio is decoded and played back into your 5.1 system
 - **Pro Logic** – This activates decoding and processing of the original Dolby Pro Logic processing with mono-surround channel. We recommend using the Dolby Pro Logic Movie mode in lieu of this 4-channel surround format.
 - **Auto** – Automatically selects processing mode based on the input format

- C. **Panorama (Music mode only):** Turns on/off panorama mode. When turned on, the front stereo audio is partially fed into the surround channels for an enveloping effect.
 - D. **Dimension (Music mode only):** Allows gradual adjustment of the sound field either towards the front or towards the rear. This is useful in setting a more even balance from all speakers with some rooms.
 - E. **Center Width (Music mode only):** To control the width of the center channel sound effect by blending the center speaker to the left and right speakers. As the level number increases, the center channel sound moves toward the left and right speakers.
8. **Dolby Digital Setup:** To configure the Dolby Digital decoder.
- Press the **SELECT** button to enter the Dolby Digital Setup page.
 - Press the left **ARROW** button to exit the Dolby Digital Setup page.

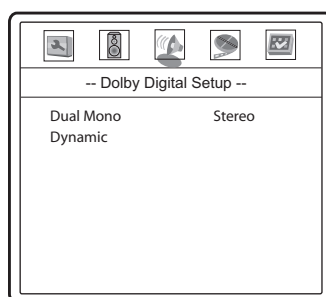

- A. **Dual Mono:** To choose the output for Dolby Digital discs encoded with two independent audio channels, such as bilingual programs. The options are:
- **Stereo** – Stereo output
 - **L-Mono** – Left channel output to both Left and Right speakers.
 - **R-Mono** – Right channel output to both Left and Right speakers.
 - **Mix Mono** – Left and Right channels mixed to both Left and Right speakers.
- B. **Dynamic:** To set the Dynamic Range Compression (DRC). DRC can smooth out the sonic peaks and valleys common with wide-range digital audio. Increasing DRC may make low level audio more audible during low-level listening. Decreasing or turning off DRC restores the sonic energy present in the original recording.

Video Setup Page

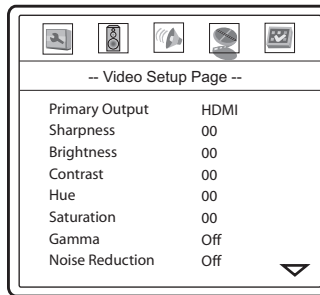

1. **Primary Output:** To select the primary video output port. The options are:

- **HDMI** – Use HDMI as the primary video output port. This setting will ensure that the HDMI output is available all the time. Component video output is limited to 480i/576i resolution when this option is selected.
- **Component** – Use component video as the primary video output port. The component output can support progressive-scan (480p/576p) and up-converted resolutions (720p/1080i/1080p) when the HDMI output is not in use (HDMI cable unplugged). When the HDMI output is in use, the player will output interlaced video (480i/576i) through its component output.

NOTE

When “**Primary Output**” is set to “**Component**”, the HDMI port may have no output signal if the player does not detect an HDMI connection when it is turned on. For example, if you turn on the player first and then turn on the TV or A/V receiver, the player may miss the opportunity to detect and enable the HDMI connection. Should this happen, press the **EJECT** button to eject the disc tray. This will give the player an opportunity to detect and enable the HDMI output.

2. **Sharpness:** To set the sharpness of video output. Sharpness enhancement level can be set between -2 and 5. The default is level 0. Level 0 turns off sharpness enhancement. The negative levels may be used to reduce or eliminate any unwanted edge enhancement, however picture may appear soft. Level 1 through 5 gradually increases the enhancement level. The higher the level, the sharper the video details are. However too high a sharpness level may cause white line etching around objects.

- Press the **SELECT** button to show the Sharpness scale, and then use the left/right **ARROW** buttons to adjust.
- Press the **SELECT** button to confirm the new setting.

NOTE

Sharpness (edge enhancement) is a video processing function that can produce a sharper looking picture but at the same time may cause unwanted artifacts. The DV-983H model utilizes the fine detail and edge enhancement technology from VRS™ by Anchor Bay (Video Reference Series) for its HDMI output. This technology provides fine control to achieve an optimal balance between enhancing sharpness and minimizing unwanted artifacts. We generally recommend level -1, 0 or 1 depending on the content when the HDMI output is used. We recommend level 0 when other video output is used.

3. **Brightness:** To adjust the brightness (black level) of the video output.
4. **Contrast:** To adjust the contrast (white level) of the video output.

NOTE

The ability to set brightness and contrast is no small thing. If you do not have the correct black and white levels then your images can appear washed out or you won't be able to see into the shadows when watching darker scenes in movies. Televisions have brightness (black level) and contrast (white level) controls; however it may take a combination of tweaking both the DVD player and your television to get just the right result. We recommend using a calibration DVD like *AVIA Guide to Home Theater* or *Digital Video Essentials* and setting your display for the best possible picture. Once that is done, see if changing the DVD player settings can get you even closer to the optimal picture.

5. **Hue:** To adjust the hue (tint) of the video output.
6. **Saturation:** To adjust the saturation (color intensity level) of the video output.
7. **Gamma:** To adjust the Gamma (intensity distribution to video signal level) of the video output. The available settings are High, Medium, Low and Off. This setting applies to analog video output only. The HDMI output is not affected by this setting.
8. **Noise Reduction:** To select whether the DVD player shall apply video noise reduction processing. When turned on, the DVD player adjusts the picture quality by reducing the "block noise" (mosaic-like patterns caused by video compression). The noise reduction function is not as effective to reduce the "mosquito noise" (artifacts around the outlines of objects) or "film grain noise" (natural variation of picture intensity caused by film grain). We recommend using the noise reduction function only when you encounter poorly encoded or compressed video that has apparent block noise.
9. **Y/C Delay:** To adjust the time difference between the Luminance (Y) and Chrominance (Pb/Pr or Cb/Cr) channels of the video signal. When there is a significant lag between the channels, image will look "smeared" because the color component is not lining up properly to the black and white luminance component. Adjust the Y/C delay setting only when the TV or projector has a Y/C delay problem. For a display device that normally does not have Y/C alignment problems, keep the Y/C delay setting at its default level 0. The Y/C delay setting applies to the HDMI output only.
10. **CUE-Correction:** To select whether the DVD player should apply chroma filtering to remove Chroma Up-sampling Errors (CUE) and Interlaced Chroma Problem (ICP). CUE is caused by improper decoding and de-interlacing of MPEG encoded video. The DV-983H is free of the CUE problem. ICP is caused by encoding interlaced video so you may encounter it on some DVDs. The CUE-Correction function can detect and filter out the errors. The available options are:
 - **On** – Chroma filtering is always on. Use this setting if the disc is known to have chroma errors.
 - **Off** – No chroma filtering is applied. Use this setting if the disc does not have chroma errors.
 - **Auto (Recommended)** – Automatic chroma error detection and correction. Use this setting when you are not sure if the disc has chroma errors.

The CUE-Correction setting applies to the HDMI output only.

11. **De-interlacing Mode:** To select the type of de-interlacing algorithm that the DVD player should use to convert interlaced video on the DVD discs to progressive output. The DV-983H utilizes the Precision De-interlacing™ technology from VRS™ by Anchor Bay (Video Reference Series) for its HDMI output. A proper de-interlacing mode will ensure the output video match the original contents and free of de-interlacing artifacts. The available options are:
- **Auto** – Source adaptive de-interlacing is on. This is the recommended setting as it sets the DVD player to optimally process a variety of signal types and quality.
 - **Film Bias Mode** – The Film Bias Mode may improve film mode detection in some cases.
 - **Video Mode** – Turn off film mode detection and treat all contents as original video. De-interlacing is done by weaving two video fields into a video frame. Use this setting if you are certain the disc is made from footage originally shot with a video camera, not with a film camera.
 - **2:2 Even** - This mode should be used when the you know that the source is high-quality 2:2 pull-down (i.e. film-based content played back in a country with a 50Hz video standard) and want to avoid any loss of cadence lock while watching that source. This mode weaves two adjacent fields together starting with an even field and combining it with the following odd field. This will provide a higher quality overall signal than the 'Auto' or 'Film Bias Mode' settings, providing that the source really is 2:2 pull-down and does not have bad edits.
 - **2:2 Odd** - This mode is very similar to "2:2 Even" except that this weaves two adjacent fields together starting with an odd field and combining it with the following even field. Only one of the 2:2 de-interlacing settings is correct for any given source and the correct mode can be chosen by simply trying both of them and selecting the one which does not result in combing artifacts.

The de-interlacing mode setting applies to the HDMI output only.

12. **Video Mode:** To select the mode of conversion for video output. The options are:
- **Video 1** – Video 1 mode uses the video decoder chip to perform PAL/NTSC conversion. This mode applies PAL/NTSC conversion to all outputs. However the conversion quality is not as good as the Video 2 mode.
 - **Video 2** – Video 2 mode utilizes the Precision Video Scaling™ and RightRate™ video processing technologies from VRS™ by Anchor Bay (Video Reference Series) to perform PAL/NTSC conversion. If you frequently watch both NTSC and PAL movies, this is the preferred mode. Please note that in Video 2 mode, PAL/NTSC conversion is not performed for the analog video outputs (composite, S-Video and component output). The advanced conversion is available through the HDMI output only.
13. **Color Space:** To select the color space for the HDMI output. The available options are:
- **Auto** – The DVD player check with the display device to automatically determine what color space to use. If the display device supports YCbCr 4:4:4, YCbCr 4:4:4 is used to avoid extra color space conversion. This is the recommended setting.
 - **YCbCr 4:4:4** – The HDMI output uses YCbCr 4:4:4 color space. If you select this option please make sure that your TV is configured to accept YCbCr 4:4:4 signals, otherwise the video color will be incorrect.
 - **RGB Video Level** – The HDMI output uses RGB color space and normal signal range suitable for video displays.
 - **RGB PC Level** – The HDMI output uses RGB color space and expands the signal range. The expanded signal range is suitable for personal computer (PC) displays. Some TVs are designed to be used as a PC monitor, and expect signal in expanded RGB range when the DVI input is selected. For these TVs if the video signal uses the normal RGB range, the black-white contrast will be reduced. You can set the DVD player to use the RGB PC Level output and restore proper contrast.

Preference Page

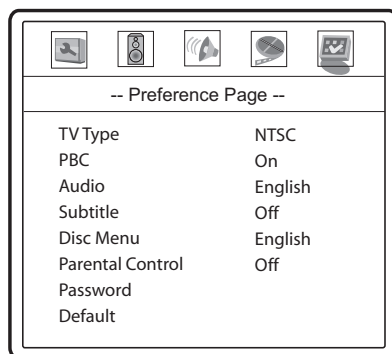

The Preference Page can only be accessed when playback is completely stopped, or when there is no disc in the DVD player.

1. **TV Type:** To set the output video system (PAL/NTSC) to match the type of TV. The options are:
 - **Auto** – No system conversion is performed. The output video system is the same as that encoded on the disc. Requires TV that supports both NTSC and PAL systems.
 - **PAL** – When playing PAL-encoded discs, no system conversion is performed. NTSC-encoded contents are converted to PAL output.
 - **NTSC (default)** – When playing NTSC-encoded discs, no system conversion is performed. PAL-encoded contents are converted to NTSC output.

NOTE

Do not select Auto type if your TV does not support both NTSC and PAL systems. The TV display may become a black screen upon inserting a disc encoded in a different system than your TV supports. Should this happen, you can press the **EJECT** button to eject the disc tray, and then press the **P/N** button repeatedly until the TV displays the background screen. Your DVD player is temporarily switched back to the supported system. You can then use the setup menu to correct the “**TV Type**” setting.

2. **PBC** – Play Back Control: To enable/disable play back control by disc contents. The options are:
 - **On** – If the disc contains Play Back Control, follow the disc instructions.
 - **Off** – Play back the contents by sequence.
3. **Audio:** To set the preferred audio language for DVD. If an audio track of the selected language is available on the disc, the audio track will be played back.
4. **Subtitle:** To set the preferred subtitle language for DVD. If a subtitle of the selected language is available, it will be displayed. When “Auto” is selected, the subtitle display is decided by the disc.

5. **Disc Menu:** To set the preferred language for displaying DVD disc menus. If a disc menu of the selected language is available, the menu will be shown instead of the default disc menu.

NOTE

If your preferred language is not listed in the Audio, Subtitle or Disc Menu options, select "Other" and enter the Language Code found on page 62 of this manual.

6. **Parental Control:** To set parental control ratings in order to prevent minors from watching inappropriate content. This function requires that the disc being properly rated and encoded.
- Press the **SELECT** button to bring up the rating selection menu.
 - Press the up/down **ARROW** buttons to select the rating to allow (G/PG/PG 13/PGR/R/NC17/ADULT). The selected rating and below will be allowed, and any rating above the selected will be blocked.
 - Press the **SELECT** button to confirm the selection. You will be asked for the parental control password. Enter the password (default password: 7890) and press the **SELECT** button.
7. **Password:** To set parental control password. To change the password, enter the old password (default: 7890) and then enter a 4-digit number as the new password. Enter the new password again to confirm, and then press the **SELECT** button.

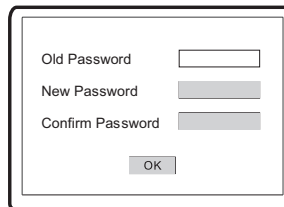

Old Password

New Password

Confirm Password

OK

8. **Default:** To reset all settings to the factory default value. The parental control password will not be reset.

REFERENCES

Useful Notes

- In order to prolong the service life of your DVD player, it is recommended to wait at least 30 seconds before you turn it on again after switching it off.
- Remove disc and turn power off after operation.
- Some functions of the player may not be applicable to certain discs.
- Some discs with special features may not be fully supported by the player. This is not a malfunction of the unit.
- In case of player malfunctioning, please turn it off, wait for 30 seconds and turn it back on. If the problem still exists, please follow the troubleshooting instructions or contact an OPPO service center.

Troubleshooting

Use this chart to help you solve operational problems. If there are any problems that you cannot solve, please contact your OPPO service center.

Symptom	Possible Cause	Solution	Reference Page
No sound	Audio cable is not properly connected	Check audio cable, and then reconnect if necessary.	9 - 16
	Muting is activated	Press the MUTE button to cancel the mute.	28
	SACD is played and the audio connection is coaxial or optical digital audio	This is not supported due to copyright restrictions of SACD. Please use the analog or HDMI audio output.	15
No picture	Video cable is not properly connected	Check video cable, reconnect if necessary.	9 - 10
	TV input is not correctly selected	Select the input to which the DVD player is connected.	
	"Audio-Only" mode engaged	Check the "A. Only" display on the front panel, and press the AUDIO ONLY button to cancel this mode.	44
	Video output format is not support by the TV	When playback is completely stopped, repeatedly press the HDMI button until the picture appears.	21
	Video system is not supported by the TV	When playback is completely stopped, press the P/N button or set the correct TV Type.	31, 58
No color	Video system is not supported by the TV	When playback is completely stopped, press the P/N button or set the correct TV Type	31, 58
	Saturation set too low	Check the saturation setting on TV and DVD player.	55
	Loose or damaged S-Video cable	If using S-Video output, check that the cable is properly plugged in and not damaged.	9
Incorrect color	Incorrect video output port	If using composite video output, check that the cable is not incorrectly plugged into the component video jack.	9
	Incorrect color space setting	If using HDMI for video output, check the color space setting on the TV and DVD player.	55
Incorrect color	Incorrect component video cable connection	If using component video output, check the three component video cables to make sure the signals match on both ends	11
	Picture rolling	Video system is not supported by the TV	When playback is completely stopped, press the P/N button or set the correct TV Type
"No Disc" error	No disc or incompatible disc loaded in player	Eject disc and check.	26
	Disc not properly loaded	Eject disc and make sure the label side is facing up and the record side is facing down.	26
	Condensation on the Laser pick-up head	Turn on the player, eject the disc and leave the player on for about an hour.	2
Remote control failure	Remote control is out of range	Use the remote control within the effective range.	8
	Low battery	Replace the batteries.	8

REFERENCES

Temporary function failure	Scratched or damaged disc is used	Replace the disc.	26
	Some functions are not available during playback	Stop playback completely, then try again.	26
	Interference from other devices	Identify interference by turning off other devices, and then relocate or replace the offending device	3
Some setup menu items are grayed out	Some setup options cannot be changed while a disc is playing. Some setup options may be mutually exclusive with other setup options.	Fully stop playback, eject the disc and try the setup menu again.	18

Specifications

Designs and specifications are subject to change without notice.

Disc Types*	DVD-Video, DVD-Audio, SACD, CD, HDCD, Kodak Picture CD CD-R/RW, DVD±R/RW, DVD±R DL
Output	Analog Audio: 7.1ch, 5.1ch or stereo Digital Audio: Coaxial, Optical HDMI Audio: Stereo or up to 5.1ch high-resolution PCM Analog Video: Composite, S-Video (Y/C), Component Video (Y/Pb/Pr, 480i/480p, 720p/1080i/1080p available for non-encrypted content only) Digital Video: HDMI with HDCP (NTSC: 480p/720p/1080i/1080p, PAL 576p/720p/1080i/1080p)
Video Characteristics	Composite Video Amplitude: 1.0Vp-p (75Ω) S-Video Amplitude: Y: 1.0Vp-p (75Ω), C: 0.286Vp-p (75Ω) Component Video: Y: 1.0Vp-p (75Ω), Pb/Pr: 0.7Vp-p (75Ω)
Audio Characteristics**	Frequency: 20Hz – 20kHz (±1dB) Signal-to-Noise Ratio: >100dB Total Harmonic Distortion: < 0.01%
General Specification	Power Supply: ~ 100V – 240V, 50/60Hz AC Power Consumption: 20W Dimensions: 430mm x 267mm x 53mm, 16 ⁷ / ₈ x 10 ¹ / ₂ x 2 ¹ / ₈ inches Mass: 2.8kg / 6.1 lbs
Operating Temperature	5°C - 35°C 41°F - 95°F
Operating Humidity	15% - 75% No condensation

* Compatibility with user-encoded contents or user-created discs is on a best effort basis with no guarantee due to the variation of media, software and techniques used.

**Nominal specification. Actual performance exceeds the specifications. Please check independent third-party reviews for actual performance indications and measurements.

NOTE:

- Region Management Information: This DVD player is designed and manufactured to respond to the region management information. If the region number of a DVD disc does not correspond to the region number of this DVD player, this DVD player cannot play the disc. The region number for this DVD player is region No.1.
- Design and specifications are subject to change without notice.

Language Code List

Code	Language Name
6565	Afar
6566	Abkhazian
6570	Afrikaans
6577	Ameharic
6582	Arabic
6583	Assamese
6588	Aymara
6590	Azerbaijani
6665	Bashkir
6669	Byelorussian
6671	Bulgarian
6672	Bihari
6678	Bengali, Bangla
6679	Tibetan
6682	Breton
6765	Catalan
6779	Corsican
6783	Czech
6789	Welsh
6865	Danish
6869	German
6890	Bhutani
6976	Greek
6978	English
6979	Esperanto
6983	Spanish
6984	Estonian
6985	Basque
7065	Persian
7073	Finnish
7074	Fiji
7079	Faroese
7082	French
7089	Frisian
7165	Irish
7168	Scots Gaelic
7176	Galician
7178	Guarani
7185	Gujarati
7265	Hausa
7273	Hindi
7282	Croatian

Code	Language Name
7285	Hungarian
7289	Armenian
7365	Interlingua
7378	Indonesian
7383	Icelandic
7384	Italian
7387	Hebrew
7465	Japanese
7473	Yiddish
7487	Javanese
7565	Georgian
7575	Kazakh
7576	Greenlandic
7577	Cambodian
7578	Kannada
7579	Korean
7583	Kashmiri
7585	Kurdish
7589	Kirghiz
7665	Latin
7678	Lingala
7679	Laothian
7684	Lithuanian
7686	Latvian, Lettish
7771	Malagasy
7773	Maori
7775	Macedonian
7776	Malayalam
7778	Mongolian
7779	Moldavian
7782	Marathi
7783	Malay
7784	Maltese
7789	Burmese
7865	Nauru
7869	Nepali
7876	Dutch
7879	Norwegian
7982	Oriya
8065	Panjabi
8076	Polish
8083	Pashto, Pushto

Code	Language Name
8084	Portuguese
8185	Quechua
8277	Rhaeto-Romance
8279	Romanian
8285	Russian
8365	Sanskrit
8368	Sindhi
8372	Serbo-Croatian
8373	Singhalese
8375	Slovak
8376	Slovenian
8377	Samoan
8378	Shona
8379	Somali
8381	Albanian
8382	Serbian
8385	Sundanese
8386	Swedish
8387	Swahili
8465	Tamil
8469	Telugu
8471	Tajik
8472	Thai
8473	Tigrinya
8475	Turkmen
8476	Tagalog
8479	Tonga
8482	Turkish
8484	Tatar
8487	Twi
8575	Ukrainian
8582	Urdu
8590	Uzbek
8673	Vietnamese
8679	Volapuk
8779	Wolof
8872	Xhosa
8979	Yoruba
9072	Chinese
9085	Zulu

LIMITED WARRANTY

OPPO Digital, Inc. Limited One Year Warranty

Your OPPO product has been manufactured to precise standards, and with rigid quality control through every process of manufacturing. It is warranted by OPPO DIGITAL, INC. against defective workmanship or materials for one (1) full year from the original date of purchase. This warranty applies only to OPPO brand products imported or manufactured by OPPO Digital, Inc. and sold to the original consumer purchaser in the U.S.A. or Canada by either OPPO Digital, Inc. or an OPPO authorized reseller. This warranty does not apply to OPPO brand products imported and sold by unauthorized dealers, distributors, or other sellers. This warranty does not apply to products purchased or shipped outside of the U.S.A. and Canada. OPPO Digital, Inc. may at its sole discretion, refuse to honor the warranty of any such unauthorized product that may be presented for service.

Warranty service can only be performed by OPPO Digital, Inc. or an OPPO authorized service center. The original dated bill of sale must be presented upon request as proof of purchase.

OPPO Digital, Inc. will, at its option and at no charge as stipulated herein, repair or replace product which is returned either in person or postpaid and insured to an OPPO service center, with new or reconditioned parts or products. Replacement parts and products assume the remaining original warranty, or ninety (90) days, whichever is longer.

This limited warranty covers noncommercial use of this product, and shall not apply to the following, including, but not limited to: applications and uses for which this product was not intended; altered product or serial numbers; cosmetic damage or exterior finish; batteries and cable accessories; accidents, abuse, neglect, fire, water, lightning or other acts of nature; incorrect electrical line voltage, fluctuations and surges; failure to follow operating or maintenance instructions. OPPO Digital, Inc. does not warrant uninterrupted or error-free operation of the product. This limited warranty shall not extend to anyone other than the original purchaser of the product. It is nontransferable and states your exclusive remedy.

THE FOREGOING WARRANTY IS THE ONLY WARRANTY WITH RESPECT TO THE PRODUCT AND OPPO DIGITAL, INC. MAKES NO OTHER WARRANTY WHATSOEVER, EXPRESS OR IMPLIED, REGARDING THE PRODUCT INCLUDING MERCHANTABILITY AND FITNESS FOR A PARTICULAR PURPOSE. IN NO EVENT WILL OPPO DIGITAL, INC. OR ITS AUTHORIZED RESELLERS BE LIABLE FOR INCIDENTAL, CONSEQUENTIAL OR SPECIAL DAMAGES, EVEN IF SUCH DAMAGES RESULT FROM NEGLIGENCE OR OTHER FAULT.

Some states do not allow limitation on how long an implied warranty lasts, or the exclusion or limitation of incidental or consequential damages, so the above limitations or exclusions may not apply to you. This warranty gives you specific legal rights, and you may also have other rights which vary from state to state.

TO REGISTER YOUR PURCHASE FOR WARRANTY, please visit the following Web site:

<http://www.oppodigital.com/registration.asp>

TO OBTAIN WARRANTY SERVICE, please follow these instructions:

- Contact OPPO customer service via email at service@oppodigital.com or by phone at (650) 961-1118 with details of the defect claimed, product model, serial number, date and place of the original purchase.

LIMITED WARRANTY

- If it is determined that your product needs service, a Return Merchandise Authorization (RMA) number will be issued to you along with return instructions and address of an OPPO service center.
- Pack the product securely, preferably in the original packaging, with your assigned RMA number marked clearly on the outside of the package. Send the package postpaid and insured to the OPPO service center to obtain warranty service.

Thank you for choosing OPPO. Your satisfaction is our highest priority.

OPPO Digital, Inc.
2629 Terminal Blvd, Suite B
Mountain View, CA 94043, U.S.A.

www.oppodigital.com
service@oppodigital.com
(650) 961-1118

5195150

V1.0

Free Manuals Download Website

<http://myh66.com>

<http://usermanuals.us>

<http://www.somanuals.com>

<http://www.4manuals.cc>

<http://www.manual-lib.com>

<http://www.404manual.com>

<http://www.luxmanual.com>

<http://aubethermostatmanual.com>

Golf course search by state

<http://golfingnear.com>

Email search by domain

<http://emailbydomain.com>

Auto manuals search

<http://auto.somanuals.com>

TV manuals search

<http://tv.somanuals.com>