

User's Manual



LMD 1135

Miniature High Speed Laser Fixed Position Scanner

Manual No. 25-ULPNR102-01

March, 2005

(OSE Command Set)



8 Olympic Drive
Orangeburg, NY 10962
Tel 845.365.0090
Fax 845.365.1251
www.OpticonUSA.com

Contents

Section 1 Introduction and Getting Started	1
Product Overview	1
Quick Start-Up Procedure	1
Section 2 Technical Specifications	3
Physical Specifications	3
Symbologies Supported	3
Optical Specification	3
Pitch	4
Skew	4
Tilt (rotation)	5
Curvature	5
Electrical Specification	5
RS232 Communications Specifications	6
Connector Pin Outs	6
Environmental Specifications	7
Ordering Information	7
Section 3 Positioning the Scanner	8
Achieving Optimum Performance	8
Measuring Scanner Performance	10
Tips for Achieving High Throughput	11
Tips for Insuring Highest Data Integrity	11
Tips for Verifying the Presence of a Bar Code	12
Section 4 Configuring the Scanner	13
Configuring the Scanner	13
Default Setting	13
Section 5 Application Engineering Support	14
Common Causes of Poor Performance	14
Section 6 Scanner Labeling	15
Section 7 Scanner Servicing and Maintenance	15
Appendix A How to Program the Scanner	17
Appendix B Computer Programming Commands	19
Appendix C Bar Code Programming Commands	24
Appendix D Dimensional Drawings	67
Appendix E Optical Performance (Typical)	68

Organization of this Manual

This manual provides the necessary instructions for installing and using the Opticon LMD 1135 Fixed Position Scanner. The manual is organized as follows:

- Section 1 Introduction and Getting Started**
Describes the general operation of the LMD 1135 scanner. Also provides a Quick Start-Up Procedure that allows you to begin using the scanner immediately.
 - Section 2 Technical Specifications**
Provides complete specifications, including mechanical details, optical performance, RS232 communications and other technical data.
 - Section 3 Positioning the Scanner for Optimum Performance**
Provides detailed instructions and tips for mounting and positioning the scanning to obtain the best scanning performance. Application Notes describe guidelines for maximizing specific characteristics.
 - Section 4 Configuring the Scanner**
Describes how various parameters can be programmed to customize the scanner for your specific application.
 - Section 5 Application Engineering Support**
Discusses the most common questions and concerns when adapting the LMD 1135 and scanner in your application.
 - Section 6 Scanner Labels**
Discusses the various labels on the product required by CDRH.
 - Section 7 Scanner Servicing and Maintenance**
Discusses maintenance and cleaning procedures.
- Appendix A How to Program the Scanner
 - Appendix B Computer Programming Commands
 - Appendix C Bar Code Programming Commands
 - Appendix D Dimensional Drawing
 - Appendix E Optical Performance

Section 1

Introduction and Getting Started

Product Overview

The LMD 1135 Fixed Position Scanner is a miniature, 100 scan per second, laser bar code reader designed to be easily incorporated into host equipment. The small physical size makes the scanner easy to integrate into any hardware design. Durability and reliability are assured.

Advanced microprocessor technology coupled with Opticon's proven decoding algorithms result in high speed operation with superior accuracy. The scanner is fully programmable allowing the user to customize parameters including changing communication settings, selecting symbologies, adding prefixes and appending suffixes. Programmable settings can be downloaded from the host CPU or computer directly to the scanner.

The scanner is encased in a compact, rugged, yet lightweight-plastic enclosure. The compact size permits installation in the tightest areas allowing great flexibility in mounting and positioning the scanner for optimum performance.

Quick Start-Up Procedure

This section is for those who wish to start using the scanner before reading the complete manual. In only a few steps the scanner will be operable.

Turn off the power to your PC and connect the scanner to an RS232 communications port. Note: You must provide +5 Volt DC power to the scanner. If you are using our standard LPN1137RR1S-050 or have purchased the evaluation kit, you can utilize power supply, P/N 32-00907-01, by plugging its connector directly into the pigtail connector on the scanner. If the power supply is obtained from another source verify that it is identified with the **CE** mark. Turn on the power to the PC.

- 1) Using communications software (e.g., Procom), set the communication parameters: 9600 baud, 1 Start/Stop Bit, 8 Data Bits, No Parity, No Handshaking, No Flow Control
- 2) If you are operating in a **Microsoft Windows 3.1** environment, skip to Step 5.
- 3) If you are operating in a **Microsoft Windows 95/98/ 2000/ XP** environment, you can set the communication parameters using Hyper Terminal as follows:
 - ◆ Open Hyper Terminal. This can be done from Start→Programs→Accessories/Communications
 - ◆ Select Hypertrm.exe to create a New Connection
 - ◆ In the Connection Description dialog screen enter a name for the new file. If desired, select an Icon. Click OK
 - ◆ In the *Connect To (Phone Number)* dialog screen, in the box entitled: *Connect using.* select the communication port, for example, "Direct to Com 1" Click OK
 - ◆ In the *Com 1 Properties* screen, enter the appropriate Port Settings: Bits per second = 9600, Data bits = 8, Parity = None, Stop Character = 1, Handshaking = None, Click OK
 - ◆ The hyper-terminal folder you just created will open. From the File pull-down menu, select *Properties* then click on the *Setting* Tab

- ◆ In the *Properties Settings* dialog screen, Select *Terminal keys* for the Function, arrow and control key; then Select *ANSI* for Emulation; the *Back scroll* buffer line can remain at the default 500
 - ◆ Click on the *ASCII Setup* button. In the ASCII Setup Sending screen, select *Line ends with line feeds* and *Echo typed locally* so that any keyboard commands you input will appear on your screen. In the ASCII Setup Receiving screen, select *Append line feeds to incoming line ends* and *Wrap lines that exceed terminal width*. Click OK. This returns you to the Properties Setting. Click OK
- 4) Your PC and the scanner should now communicate. Skip to Step 6.
- 5) In a Microsoft Windows 3.1 environment, set the communication parameters using the Terminal function of Windows.
- a) From Window's *Program Manager* Main Menu, select *Terminal*.
 - ◆ From the *Terminal* menu, select Settings.
 - ◆ From the *Settings* menu, select Terminal Emulation.
 - ◆ Set the emulation to *TTY (generic)*.
 - ◆ From the *Settings* menu, select Terminal Preferences and select the following Terminal Modes:
 - Line Wrap
 - Local Echo
 - Sound
 - CR /LF: Inbound, Outbound
 - Columns: 80
- From the *Settings* menu, select Communications , select the COM port, and set communication parameters as shown in Step 2, including no flow control
- 6) To verify that the scanner and the PC are communicating properly, send the following command from your PC keyboard which will request software settings to be displayed.
Send the command in four keystrokes: <Escape> Z3 <Carriage Return>
Note: Be sure to use capital letters, e.g. "Z3", not "z3".
A series of software setting should be displayed, indicating that good communications have been established
- 7) A red laser light should be visible. If it is not visible, the scanner may be in a mode that requires a "Trigger" Command from the PC to activate it. You can exit that mode by sending the following command from your PC keyboard:
<Escape> S7 <Carriage Return>
- 8) The "Trigger" mode will now be deactivated and the red laser light will be continuously illuminated.

This Quick Start-Up procedure will get you started. However, to best understand the full capabilities of this scanner, you should read the complete manual.

Section 2

Technical Specifications

Physical Specifications

Case Material	Plastic
Dimensions	2.2 x 1.9 x 1.0 in (WxDxH) (55 x 47.5 x 25.5 mm)
Weight	2.1 oz (60 grams) w/o cable
Cable Length	6.5 Feet (2000 mm)
Connector	9-pin, DB9F-SC connector with power pigtail (evaluation configuration)
Mounting	4 threaded (M-3) mounting holes located on scanner bottom face

Symbologies Supported

- ◆ Codabar (NW-7)
- ◆ Code 39
- ◆ Code 93
- ◆ Code 128
- ◆ Industrial 2 of 5 / Interleaved 2 of 5
- ◆ MSI / Plessey
- ◆ WPC (UPC / EAN / JAN)
- ◆ IATA
- ◆ Telepen
- ◆ TriOptic
- ◆ SCode

Optical Specifications

Scan Rate	100 scans per second $\pm 20\%$
Light source	650 ± 10 nm visible laser diode
Narrow Bar Resolution	5 mil (0.15mm) at 0.9 PCS
Minimum PCS	0.45 (min. background reflectance of 70%)

Reading Distances LMD 1135 (Specification) * (See Typical in Appendix E)

Bar Code Density	Near Distance	Far Distance
40 mil (1.00 mm)	4.3" (110mm)	14.2" (360mm)
20 mil (0.50 mm)	3.1" (80mm)	9.8" (250mm)
10 mil (0.25 mm)	2.4" (60mm)	5.7" (145mm)
6 mil (0.15 mm)	1.8" (45mm)	3.1" (80mm)
5 mil (0.127 mm)	2.2" (55mm)	2.8" (70mm)

* measured from front edge of scanner

Pitch

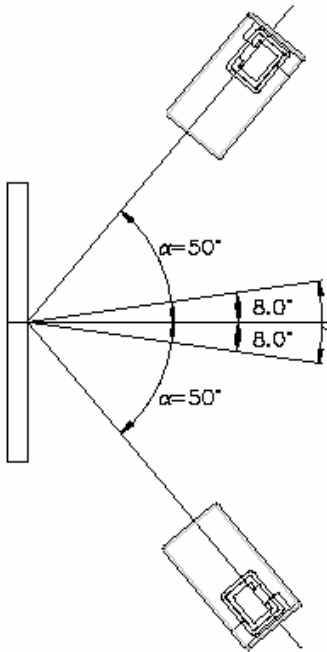

Specified operation (α) at ± 50 degrees or less. (Recommended at ± 13 degrees)

Avoid specular reflection in the dead zone (+/- 8 degrees).

Skew

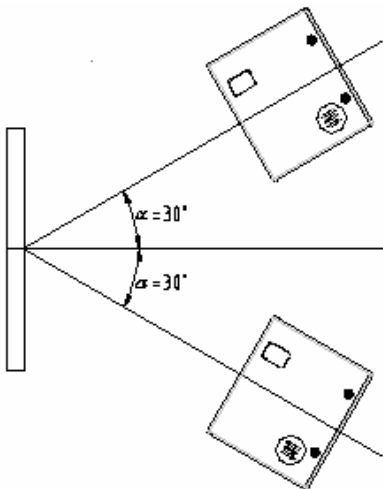

Specified operation (α) ± 30 degrees or less. (Recommended 0 degrees)

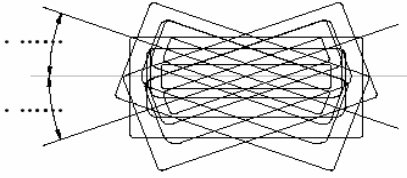
Tilt (Rotation)

Specified operation (θ) \pm 20 degrees or less. (Barcode aspect ratio allowing laser to cover all bars). (Recommended operation at 0 degrees)

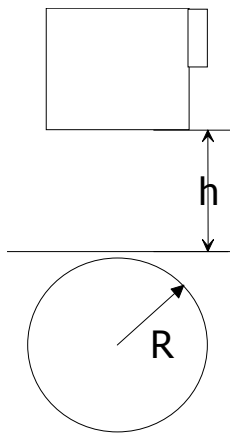
Curvature

EAN-8: R = 15 mm (0.6") or

EAN-13: R = 20 mm (0.8").

Where: PCS 0.9, h = 100 mm,

Pitch=15°, Skew=0°, Tilt=0°

Electrical Specifications

Operating Voltage	+5VDC \pm 10%
Current	
Operating	85mA (typical), 150mA (max)
Idle	55mA (typical), 70mA (max)
Pwr-On Surge	650mA (typical), 1500mA (max)

RS232 Communications Specifications

RS232 Data Transmission Format

<u>Parameter</u>	<u>Default</u>	<u>Optional Settings</u>
Timing	Asynchronous	
No. of Start Bits	1 bit	
No. of Stop Bits	1 bit	1 or 2 bits
No of Data Bits	8 bit	7 or 8 bits
Parity	None	Odd / Even / None
Baud Rate	9600 baud	150 to 38,400 baud
Handshaking	None	Hardware / Software/ None

RS232 Transmit / Receive Character Format

TXD/ RXD	Start Bit	LSB	7 or 8 Data Bits	MSB	Parity Bit	Stop Bit
-------------	--------------	-----	---------------------	-----	---------------	-------------

RS232 Data Format

Transmit	Decoded Data		CR
Receive	ESC	Command	CR
	STX	Command	ETX

RS232 Signal Level

Signal Name	In / Out	Mark/Off	Space/On
TXD	Out	-5 to -15	+5 to +15
RXD	In	-3 to -15	+3 to +15

Connector Pin-outs

9 Pin D-Sub Female Connector (with power stereo jack)

Pin No.	Signal	Direction
1	Frame Ground	
2	TxD	Output
3	RxD	Input
4	NC	
5	Signal Ground	
6	NC	
7	CTS	Input
8	RTS	Output
9	NC	

Scanner/cable snap-in connector pin-out (connector: 3004CA8101 Kinsun)

Pin No.	Signal
1	RTS
2	CTS
3	TxD
4	RxD
5	VCC
6	Ground
7	NC
8	NC
9	NC
10	NC

Environmental Specifications

Temperature

Operating +23 to +113° F (-5° to +45° C)

Storage -4 to +140° F (-20° to +60° C)

Humidity (non- condensing)

Operating 20 to 80% RH

Storage 20 to 90% RH

Ambient Light Fluorescent or incandescent: below 3 kilolux

Ordering Information

Part No.

LPN1137RR1S-050

Model

Front View, 9 Pin D-Sub Female Connector (with power stereo jack)

(standard configuration, other configurations are available upon request)

Developer's Test and Evaluation Kit (LPN-1137R1-SK1) is available which contains all the items needed to install and evaluate the scanner. The kit includes:

- Scanner
- 5V Power Supply (32-00907-01)
- User Manual
- CD ROM (including manual, datasheet and supporting materials)

Section 3

Positioning the Scanner for Optimum Performance

Achieving Optimum Performance

Three items greatly impact performance:

- 1) Distance (from the scan window) to the bar code
- 2) Specular Reflection
- 3) Quality of Bar Code Labels

1) Distance to the Bar Code

The ideal location of the bar code relative to the scanner is in the waist of the laser beam. A bar code located either too near or too far from the scanner relative to the waist may cause the scanner to have difficulty decoding what appears to be fuzzy bars and spaces. For the LMD 1135 fixed position scanner, the waist is approximately 2.5" from the front edge of the scanner

Depth-of-Field

Just as with a camera, the scanner has a depth-of-field. It can read bar codes that are not precisely at the laser beam waist - maybe a little closer, or a little farther away. However, if the bar code label is positioned too far from the waist of the beam, the scanner may not be able to successfully decode it.

The depth-of-field varies based on the density of the bar code, i.e., the thickness of the bars. Very high density bar codes (which have very narrow bars) are readable over a much shorter distance range than low density bar codes with larger bars.

The following table shows the depth-of-field "specifications" (closest to farthest reading distances) for the LMD 1135 scanner. The actual performance may differ slightly from unit to unit. Also, it is important to note that this data was measured under ideal conditions using high quality bar code labels. In a "real world" environment the conditions will not be as ideal. Therefore, the best practice is to position the scanner at the center of the depth-of-field rather than at the extremes of its depth-of-field. Data taken for a "typical" unit randomly drawn from stock is presented in Appendix E.

Depth-of Field LMD 1135 (Specification)*

Bar Code Density	Near Distance	Far Distance
40 mil (1.00 mm)	4.3"	14.2"
20 mil (0.50 mm)	3.1"	9.8"
10 mil (0.25 mm)	2.4"	5.7"
6 mil (0.15 mm)	1.8"	3.1"
5 mil (0.127 mm)	2.2"	2.8"

* measured from front edge of scanner

**Readable Bar Code Width LMD 1135
(Field-of-View Specification Based Upon 40 Degree Sweep)**

Distance from Window	Max. Width
2.0"	2.8"
4.0"	4.2"
8.0"	7.2"
12.0"	10"

The table above shows the field-of-view at various distances from the window. The field-of-view is the maximum width that the scanner is capable of reading. It is the distance from the left edge of the view to the right edge. A bar code label positioned anywhere within this field-of-view can be decoded. The field-of-view is also a measure of the widest bar code label that can be read. *Remember:* The width of a bar code label includes not only the bars and spaces but also the required white space (quiet zone) on each end.

Good design policy is to position the barcode at the midpoint of the scanner's depth-of-field and at the center of the field-of-view. Do not position it near the extremes of the reading range.

2) Avoiding Specular Reflection

Do not position the scanner at an angle that causes the laser light to be reflected directly back into the scanner. This is called specular reflection. Too much reflected light can "blind" the scanner preventing a good decode. The recommended location is ± 13 degrees off the perpendicular for optimal performance.

If the bar code label is located on a flat surface, specular reflectivity occurs between 0 to 8 degrees off perpendicular. (See diagram) If the bar code label is located on a cylindrical surface, such as a test tube, the angle of specular reflection is measured tangent to the curve. If the curved surface is also moving, there may be more than one position causing specular reflection. The following diagram indicates the area to avoid:

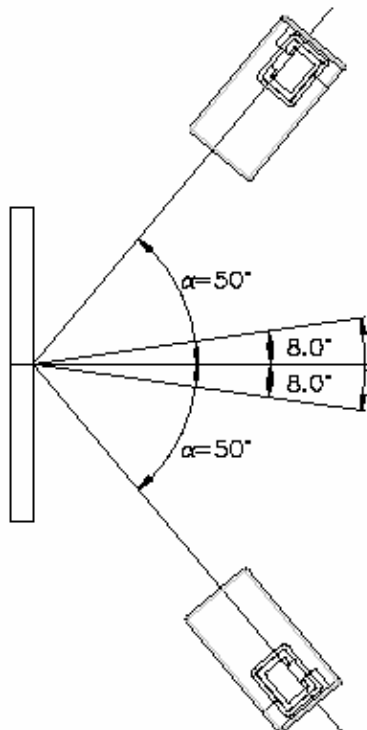

3) Quality Bar Code Labels

The quality of the bar code label can affect the scanning performance. Poor quality labels are more difficult to decode and may result in non-reads or potential misreads. The bar code label should be printed to specifications. This means that the bars are printed within spec, with the correct widths, no ink spread, crisp edges and no voids. There should be a sufficient quiet zone on both end of the bar code label. For best results, the paper or label stock should have a matte finish to diffuse light. The print contrast signal (which is a comparison of the reflectance of the bars and the background stock) should be as high as practical.

Measuring Scanner Performance

A method for properly positioning the unit is to program the scanner for Trigger Disable (S7) and Continuous Read (S2) modes. The scanner will be always on and will continuously read the same bar code. Since the buzzer sounds each time the bar code is read, the sound of the buzzer can be used like a "Geiger counter". As the position of the scanner changes the sound of the buzzer will change. The buzzer sound will be loudest and most continuous at the best reading position.

Application Notes

Tips for Achieving High Throughput

In some applications your primary objective may be to achieve the highest possible throughput rate. The following list identifies the parameters and scanner settings that can maximize scanning and decode throughput speed. Note, by emphasizing maximum throughput, other areas of performance may be affected. For example, the number of non-reads could increase.

If high throughput is critical, consider some or all of these settings:

- ◆ Operate in the Trigger Disabled mode. Operation of the trigger creates delay before decoding begins, slowing down throughput rate.
- ◆ Only enable those symbologies that you will be decoding.
- ◆ Eliminate all suffixes and prefixes to reduce transmission time.
- ◆ Minimize the number of redundant reads required before transmitting data.
- ◆ Transmit the decoded data at the highest baud rate.
- ◆ Disable buzzer functions.

Tips for Insuring Highest Data Integrity

There are several parameters that can enhance your confidence that the correct bar code data is transmitted. Note that by emphasizing the accuracy and security of the data other areas of the scanner operation may be affected, for example, you may not achieve the highest throughput.

If accuracy and data integrity are critical, consider some or all of these settings:

- ◆ Program the scanner to require a high number of redundant decodes prior to transmitting. For example, program the scanner to decode a bar code exactly the same way three consecutive times before transmitting the data. Then decoding the bar code the same way 2 out of 3 times or any 3 out of 4 times is not sufficient. It must obtain three consecutive, identical decodes.
- ◆ Utilize a predetermined, fixed-length of bar code. Program the scanner to only decode a bar code of that length. Bar codes of any other length will be ignored.
- ◆ The quality of the printed bar code must be excellent.
- ◆ Use a bar code symbology that contains an internal check digit and program the scanner to calculate that check digit for validity prior to transmitting.
- ◆ Do not use a symbology with poor internal verification, or subject to partial decodes, such as 2 of 5 or MSI/Plessey.
- ◆ Only enable those symbologies that you will be decoding.
- ◆ Transmit data at low baud rates to minimize communication errors.
- ◆ Enable the "Number of Characters Transmitted". The scanner will calculate and transmit a number indicating the total number of characters it is transmitting. Your host application program can compare this number with the actual number of characters received to verify that the correct amount of data is received.

Tips for Verifying the Presence of a Bar Code

If the scanner is operated in the "trigger enabled" mode and the trigger is activated, one of three conditions may occur:

A bar code is scanned and decoded.	Decoded data is transmitted
A bar code is scanned but is not decoded (e.g., print quality was poor)	No data is transmitted
No bar code is present	No data is transmitted

In some applications, when no data is transmitted, it may be important to know why. Was there a bar code present that could not be decoded, or was no bar code present at all?

This requirement is common in applications such as automated blood analysis equipment. Test tubes containing blood samples from many different people are loaded into a rack for automatic analysis. The bar code on each tube ties that sample and the results back to a specific individual. If no bar code data is transmitted it is critical to understand the reason.

Your Opticon scanner, when operated in the Trigger Enabled mode, can be programmed to transmit an error message indicating whether or not a bar code was present. See Section 33 of Appendix C of this manual for details.

Section 4

Configuring the Scanner

Since the operation of the LMD 1135 scanners are microprocessor controlled, it is possible to modify or program its operation to match your specific application. Changes in parameter settings can be accomplished two ways.

1. The scanner can be programmed by sending software instructions from the host PC to the scanner via the RS232 connection.
2. The second method employs specially designed programming bar codes. Scanning these bar codes instructs the scanner to modify specific parameters.

Programming Menus & Commands

Appendix A contains full instructions on how to configure the scanner as well as a complete listing of the computer commands and programming bar codes that are available to customize the scanner for your application.

Default Settings

When you modify or change any parameters, the scanner can be programmed to retain the new parameter in memory, even if power interrupted or terminated. If for any reason the scanner is instructed to return all parameters to default settings (U2), it will return to the default settings shown in the following table.

Default settings are indicated by a pointing hand symbol () throughout the bar codes menus.

Parameter	Factory Default Setting
RS 232 Communications	9600 baud 8 data bits 1 stop bit No parity No handshaking
Trigger Function	Enabled
Auto-Trigger Function	Enabled
Read Mode	Multiple Read Mode
No. of Redundant Decodes	Read three times before transmitting
UPC-A (12 digits)	No leading zero Enable check digit
UPC-E (7 digits)	No leading zero Enable check digit
Code 39	Do not calculate check digit/Transmit check digit Disable start/stop characters (*.....*)
Codabar	Disable start/stop characters Do not calculate check digit
2 of 5 (Interleaved and Industrial)	Do not calculate check digit
Fixed length of bar code only	Disabled
Buzzer	Enabled
Positive bar codes only	Enabled
Error indications	Do not transmit error code

Section 5

Application Engineering Support

Technical Assistance and Support

Opticon is eager to help you integrate the LMD 1135 scanner into your application. Our technical support staff is available to answer any questions or work with you to adapt the scanner to your specific situation. We are happy to answer your questions, assist in configuring and positioning the scanner for optimum operation, and help resolve any problems you encounter. Call us at 1 (800) 636-0090.

Common Causes of Poor Performance

The most common reasons for poor scanning performance are listed below:

- ◆ Bar codes are not positioned at the focal distance of the scanner.
- ◆ Specular reflection is impacting the scanner. Change the angle/position of the scanner or the bar code.
- ◆ Poor quality of printed bar codes. Bar codes are out of specification.
- ◆ The paper on which the bar code is printed is highly reflective or has a glossy finish causing light to be reflected into the scanner.
- ◆ The distance from the scanner to the bar code is not suitable for the density of the bar code. Or the density of the bar code beyond the scanners capability. If the red illuminating light of the scanner is not on, the scanner may be in the "Trigger Enable" mode expecting a trigger signal.

Modified and/or Customized Scanners

Opticon will work with you to modify or customize scanners to match your requirements. Scanners can be modified in terms of connectors type, pin-outs, cable length, default settings, custom software and many other areas.

Opticon will modify scanners in our factory and ship you scanners that match your specific requirements. By incorporating your modifications directly into production scanners, you receive scanners tailored for your need. They can be used immediately without the need for further modification or rework.

Section 6

Scanner Labeling

IEC 825-1 Class 1 Laser Device

The LMD 1135 has been examined and found to be a Class 1 Laser Device according to the relevant requirements of IEC 825-1 and corresponding EN 60825-1 (1993-11) including amendment 1 (1997-09) and amendment 2 (2001-01).

This scanner also complies with Center for Devices and Radiological Health (CDRH) 21 CFR 1040.10 and 1040.11 except for deviations pursuant to Laser Notice No. 50 dated July 26, 2001.

The LMD 1135 scanner use a low-power visible laser. As with any very bright light source, such as the sun, you should avoid staring into the light beam. Momentary exposure to an IEC 825-1 Class 1 laser is not known to be harmful.

A manufacturer's label, as shown below, indicating the manufacturer, product model, ordering number, serial number, laser class, CE mark and place of manufacture is affixed to each scanner.

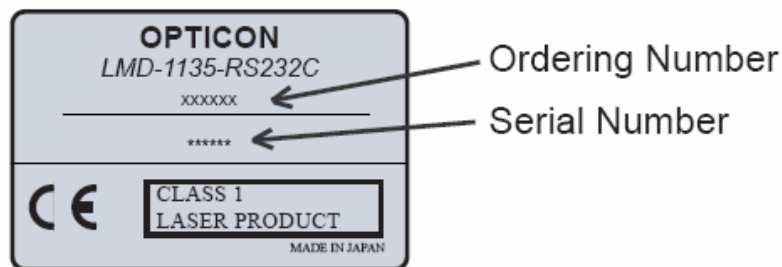

Section 7

Scanner Servicing and Maintenance

⚠ CAUTION: Use of controls or adjustments or performance of procedures other than those specified herein may result in hazardous laser light exposure.

The LMD 1135 scanner contains no user adjustable or serviceable parts in the interior of the scanner. All product service must be performed by the Opticon Service Department in Orangeburg, NY. Opening the scanner will void the warranty and could expose the operator to laser light.

The LMD 1135 is warranted for 1 year including parts and workmanship. If you need warranty or out-of-warranty repair, first **call 1-800-636-0090** to obtain a **Returned Material Authorization (RMA)** number. You will be provided a number and shipping instructions.

There is no scheduled maintenance required for the LMD 1135. The scanner can be cleaned using a water dampened, lint free or lens cloth. Be careful to avoid excessive moisture that would penetrate the housing or obscure the window. While use of cleaning fluids other than water are not recommended, a neutral detergent or ethanol would be preferred if necessary. Do not use bleach at full or diluted strength as damage to the painted case and/or window may result.

Appendices

- Appendix A How to Program the Scanner
- Appendix B Computer Programming Commands
- Appendix C Bar Code Programming Commands
- Appendix D Dimensional Drawing
- Appendix E Optical Performance (typical)

Appendix A

Programming the Scanner

Two different methods can be used to program parameters to configure the scanner:

- a. Programming via Computer Commands
- b. Programming via special Bar Codes from a menu page

Most parameters can be programmed using either of these two methods. However, there are certain parameters that are only programmable via the bar code menu.

a. Programming via Computer Commands

Parameters can be programmed by sending software commands or keyboard strokes from the host computer to the scanner in the following format:

<ESC> Computer Command <CR>

Note:

Only upper case letters are recognized, e.g., "AB" not "ab"
Each command normally consists of two characters
Downloading of software commands cannot be "grouped" together. Each command must be preceded by <ESC> and followed by a <CR>

Parameters programmed by downloaded commands can be stored permanently by transmitting a "<ESC> Z2 <CR>" command. It is not necessary to send a "Z2" command after each parameter is changed. One Z2 command will save all changes

Appendix B lists all of the Computer Commands. In Appendix C, Bar Code Programming Menus, the left-hand column in all menus contains the Computer Command associated with that bar code.

b. Programming via Bar Codes

Use the following steps to program parameters via the bar code menus:

1. Scan the "Start/End" bar code. This instructs the scanner to enter the Programming Mode. While in this mode the scanner will beep intermittently.
2. Scan the bar code(s) associated with the desired parameter(s). The scanner will beep when the bar code is read. Note: because of the close proximity of bar codes on the page, it is important to aim carefully to ensure that only the desired bar code is scanned.
3. Scan the "Start/End" bar code. This instructs the scanner to exit the Programming Mode.

All the parameters that were scanned are retained in memory and are stored permanently (even if the scanner is power down) or until they are changed again.

When the scanner is in the Programming Mode, you can change more than one parameter at a time. However, this may become confusing. Until you become proficient at programming you may prefer to change only a few parameters at one time. We recommend that you keep a record of the changes you have made to the scanner.

What if you make a mistake?

Don't worry. If you are programming the scanner but are unsure of which parameters have been changed, scan the **Reset All Defaults** bar code. This bar code returns the scanner to the default settings that were installed in the factory at the time the product was manufactured. Scanning this bar code erases any change you have made, including any changes that were made during previous programming.

Reset All Defaults U2 Command (U2)

This command will also return all settings to the defaults that were installed in the factory

Appendix B

Computer Programming Commands

All commands must be preceded by an 'ESC' character (ZZ) and be followed by a 'Carriage Return' character (1C). Shaded areas indicate factory default settings.

Enable	Disable	Global Defaults
U2		Enable Factory Default Settings
Z1		Transmit software version
Z2		Save all values set by command
Z3		Display software settings (inc, prefix/suffix).

Only	Add	Symbology Selection
A0		Enable all symbologies
B0		Disable all symbologies
J0		Enable all UPC and EAN
A2	B2	Code 39
A3	B3	Codabar (NW-7)
A4	B4	IATA
A5	B5	Code 93
A6	B6	Code 128 (Inc. EAN-128)
A7	B7	MSI/Plessey
A9	B9	Telepen
J1	R1	UPC (A/E)
J2	R2	UPC (A/E)+2
J3	R3	UPC (A/E)+5
J4	R4	EAN (13/8)
J5	R5	EAN (13/8) +2
J6	R6	EAN (13/8) +5
J7	R7	2 or 5 Industrial
J8	R8	2 or 5 Interleaved

JD	JZ	TriOptic
RA	R9	SCode

Enable	Disable	Options for UPC
E2		UPC-A (13 Digits) Transmit leading zero & CD
E3		UPC-A (12 Digits) No leading zero but transmit CD
E4		UPC-A (12 Digits) Transmit leading zero but No CD
E5		UPC-A (11 Digits) No leading zero & no CD transmitted
E6		UPC-E (8 Digits) Transmit leading zero & CD
E7		UPC-E (7 Digits) No leading zero but transmit CD
E8		UPC-E (7 Digits) Transmit leading zero but no CD
E9		UPC-E (6 Digits) No leading zero & no CD transmitted
6Q		Transmit UPC-E as is
6P		Transmit UPC-E as UPC-A

Enable	Disable	Options for EAN-8 & EAN-13
6K	6J	EAN-13 Transmit CD
6I	6H	EAN-8 Transmit CD
IA	IB	Enable ISBN translation
HO	HN	Enable ISSN translation

Enable	Disable	Options for Code 39
8E		Enable 1 character read
8D		Enable 3 character read
C0	C1	Enable Check Digit calculation
D9	D8*	Transmit Check Digit
D0	D1	Transmit start/stop characters (*.....*)
+L	+M	Concatenation
-Y	-Z	Alternative algorithm

*Only disable if C0 enabled, otherwise truncate last digit.

Enable	Disable	Options for IT Pharmaceutical
D6		IT Pharmaceutical only
DB	DA	Transmit Leading A

Enable	Disable	Options for Codabar (NW-7)
HC		Enable 1 character read minimum
HB		Enable 3 character read minimum
HF		Enable 5 character read minimum
F0		Do not transmit start/stop characters
F1		Transmit start/stop as ABCD/TN*E
F2		Transmit start/stop as abcd/tn*e
F3		Transmit start/stop as ABCD/ABCD
F4		Transmit start/stop as abcd/abcd
H8	H9	Transmit check digit
H6	H7	Calculate check digit
HH	HI	Intercharacter gap check
-Y	-X	Alternative Algorithm

Enable	Disable	Options for 2 of 5 / SCode
G1	G0	Calculate check digit
E0	E1	Transmit check digit
GE		Enable 1 character minimum
GF		Enable 3 characters minimum
GI		Enable 5 characters minimum
GG	GH	Transmit S-Code as Interleaved 2 of 5
-Y	-X	Alternative Algorithm

Enable	Disable	Options for IATA
4H		Do not calculate check digit
4J		Calculate CD (CPN + Form + Serial)
4I		Calculate CD (Form + Serial)
4K		Calculate check digit (all data)
4L	4M	Transmit check digit
-Y	-X	Alternative Algorithm

Enable	Disable	Options Code 128/EAN 128
JF	OF	EAN-128 Only
MO	MP	Concatenation

Enable	Disable	Options for Code 93
+V	+W	Concatenation

	Fixed Number of Digits
H1	Fixation on all symbologies
HK	Fixation on selected symbologies
HL	Minimum length selected symbologies
HM	Maximum length selected symbologies
H0	Disable fixation on all symbologies

Prefix	Suffix	Select Symbology for Prefix/Suffix
RY	RZ	All codes
N1	N6	UPC-A
M0	O0	UPC-A +2 or +5
N2	N7	UPC-E
M1	O1	UPC-E +2 or +5
N3	N8	EAN13
M2	O2	EAN-13 +2 or +5
N4	N9	EAN-8
M3	O3	EAN-8 +2or +5
M4	O4	Code 39
M5	O5	Codabar (NW-7)
M6	O6	Industrial 2 of 5
M7	O7	Interleaved 2 of 5
M8	O8	Code 93
M9	O9	Code 128
I8	I9	IATA
N0	N5	MSI/Plessey
MB	OB	SCode
L8	L9	Telepen

Prefix/Suffix of Numeric Characters	
Q0	0
thru	thru
Q9	9
Prefix/Suffix of Alpha Characters	
0A	A
thru	thru
0Z	Z

Prefix/Suffix of Control Characters	
1B	STX
1C	ETX
1M	Carriage Return
1J	Line Feed

Code ID & Character Length Transmission	
\$2	Code identification
\$3	Code length 2 digits
\$6	Code length 6 digits

Communications Parameters	
K0	150 baud
K1	300 baud
K2	600 baud
K3	1,200 baud
K4	2,400 baud
K5	4,800 baud
K6	9,600 baud
K7	19,200 baud
K8	38,400 baud
L0	7 Data Bits
L1	8 Data Bits
L2	Parity = None
L3	Parity = Even
L4	Parity = Odd
L5	1 Stop bit
L6	2 Stop bits

Handshaking	
I0	Unlimited wait for CTS from terminal
I1	100 mS wait for CTS from terminal
I2	200 ms wait for CTS from terminal
I3	400 mS wait for CTS from terminal
P0	No Handshaking
P1	Busy/Ready
P2	Modem
P3	ACK/NAK (1 second timeout with error buzzer)
P4	ACK/NAK no response (100 ms timeout, terminates with good read buzzer)
ZG	XON/OFF
KA	No intercharacter delay
KB	20 ms intercharacter delay
KC	50 ms intercharacter delay
KD	100 ms intercharacter delay

Buzzer Operation	
T0	Volume = Maximum
T1	Volume = Upper mid-range
T2	Volume = Lower mid-range
T3	Volume = Minimum
W0	Disable Buzzer
W1	Enable buzzer at 3kHz
W2	Enable buzzer at 3kHz with 2.5kHz interval
W3	Enable buzzer at 3kHz with 4kHz interval
W4	Buzzer duration 0.10 sec
W5	Buzzer duration 0.20 sec
W6	Buzzer duration 0.40 sec
W7	Buzzer duration 0.05 sec
W8	Enable buzzer

Positive & Negative Bar Codes	
V2	Positive bar codes only
V3	Only negative bar codes
V4	Both positive and negative bar codes

Setting the Trigger & Auto-Trigger Functions	
S7	Disable the trigger function (Laser On)
S8	Enable the trigger function (Laser OFF until the trigger is activated)
+F	Auto-Trigger Disable
+I	Auto-Trigger Enable
Z	Activate the trigger; turns the laser ON

Selecting the Read Mode	
S0	Single Read Mode (Trigger must be Enabled, S8)
S1	Multiple Read Mode
S2	Continuous Read Mode

Parallel Read Mode	
+6	2 Parallel labels only
+7	3 Parallel labels only
+8	4 Parallel labels only

	Scanner Timeout (Trigger Enabled Mode)
Y1	1 second after triggering
Y2	2 second after triggering
Y3	3 second after triggering
Y4	4 second after triggering
Y5	5 seconds after triggering
Y6	6 second after triggering
Y7	7 seconds after triggering
Y8	8 seconds after triggering
Y9	9 seconds after triggering
YL	Read time x 10
YM	Indefinitely after triggering
XA	Add-on Wait Time - Disable
XB	Add-on Wait Time – 250 msec
XC	Add-on Wait Time – 500 msec
XD	Add-on Wait Time – 750 msec
AH	Multiple Read Reset Time – 50 msec
AI	Multiple Read Reset Time – 100 msec
AJ	Multiple Read Reset Time – 200 msec
AK	Multiple Read Reset Time – 300 msec
AL	Multiple Read Reset Time – 400 msec
AM	Multiple Read Reset Time – 500 msec
AN	Multiple Read Reset Time – 600 msec
AG	Multiple Read Reset Time - Indefinite

	Quiet Zone Options
YN	No margin check
YO	Margin check 1/7 nominal
YP	Margin check 2/7 nominal
YQ	Margin check 3/7 nominal

YR	Margin check 4/7 nominal
YS	Margin check 5/7 nominal
YT	Margin check 6/7 nominal
YU	Margin check normal

	Redundant Decoding
X0	Read bar code once
X1	Read bar code twice before transmitting
X2	Read bar code three times before transmitting
X3	Read bar code four times before transmitting
BS	Read bar code five times before transmitting
BT	Read bar code six times before transmitting
BU	Read bar code seven times before xmitting
BV	Read bar code eight times before xmitting
BW	Read bar code nine times before xmitting

	Xmit Error (Trigger Enabled Mode only)
TH	User defined error message for no label
TI	User defined error message for no decode
TG	Clear error messages for no label, no decode
WD	Response to command - None
WC	Response to command – OK=ACK, ERROR=NAK
WB	Buzzer Control to Command - Disable
WA	Buzzer Control to Command - Enable







	Good Read LED Operation
T4	Disable good read LED (GRL)
T5	GRL ON for 0.20 seconds after decode
T6	GRL ON for 0.40 seconds after decode
T7	GRL ON for 0.80 seconds after decode

Appendix C:

Bar Code Programming Menus & Commands - Index

1. Global Default & Scanner Configurations.....	25
2. Symbology Selection	26
3. Add/Activate Specific Bar Code Symbologies	28
4. Delete/Deactivate Specific Bar Code Symbologies	29
5. Options for UPC.....	30
6. Options for EAN-8 & EAN-13.....	31
7. Options for Code-39 & IT Pharmaceutical)	32
8. Options for Codabar (NW-7).....	34
9. Options for 2 of 5 (Including SCode)	36
10. Options for IATA.....	37
11. Options for Code-128 & EAN-128.....	38
12. Options for Code-93.....	38
13. Fixing the Number of Digits	39
14. Creating a Prefix and/or Suffix	40
15. Setting Prefixes (Identifying the Symbology)	41
16. Setting Suffixes (Identifying the Symbology)	43
17. Direct Input of Numeric Characters	45
18. Direct Input of Alpha Characters	46
19. Direct Input of Alpha Characters (Lower Case).....	47
20. Direct Input of Control Characters	48
21. Direct Input Characters Miscellaneous.....	50
22. Code Identification & Number of Characters/Digits Transmitted	52
23. Communication Parameters	53
24. Handshaking	55
25. Buzzer Operation	57
26. Positive & Negative Bar Codes	58
27. Setting the Trigger & Auto-Trigger Functions	58
28. Selecting the Read Mode	59
29. Parallel Read Mode.....	60
30. Add-on Wait Mode.....	60
31. Scanner Timeout (Trigger Enabled Mode only)	61
32. Multiple Read Reset Time.....	62
33. Quiet Zone Options.....	63
34. Redundant Decoding.....	64
35. Transmitting Error Indications (Trigger Enabled only)	65
36. Good Read LED Operation	66

1. Global Default & Scanner Configurations

Computer Command	Function /Description	Bar Code Command
(ZZ)	START/END Programming Menu	
U2	Return all parameters to Default settings	 
Z1	Transmit software version	
Z2	Save all values set by command (not lost upon power off)	
Z3	Display software settings including prefix/suffix	

Note: Where computer commands appear in parenthesis, bar code commands must be used to start and end manual programming of the scanner.

Note: Scanner default settings are indicated by a pointing hand () symbol throughout the menus to follow.









* Use Z2 (Save all values set by command) after computer command to store settings in memory prior to power off.

2. Symbology Selection

























Computer Command	Function /Description	Bar Code Command
(ZZ)	START/END Programming Menu	
A0	Enable all bar code symbologies	
J0	Enable all UPC and EAN	
A2	Only Code-39	
A3	Only Codabar (NW-7)	
A4	Only IATA	
A5	Only Code-93	
A6	Only Code-128 (Inc. EAN-128)	
A7	Only MSI/Plessey	
A9	Telepen	
J1	Only UPC (A/E)	
J2	Only UPC (A/E)+2	
J3	Only UPC (A/E)+5	

CONTINUED ON NEXT PAGE...

2. Symbology Selection (continued)

Computer Command	Function /Description	Bar Code Command
(ZZ)	START/END Programming Menu	
J4	Only EAN (13/8)	
J5	Only EAN (13/8) +2	
J6	Only EAN (13/8) +5	
J7	Only Industrial 2 of 5	
J8	Only Interleaved 2 of 5	
JD	TriOptic	
RA	SCode	

3. Add/Activate Specific Bar Code Symbologies

Computer Command	Function /Description	Bar Code Command	
(ZZ)	START/END Programming Menu		
B2	Enable Code 39		
B3	Enable Codabar (NW-7)		
B4	Enable IATA		
B5	Enable Code 93		
B6	Enable Code 128		
B7	Enable MSI/Plessey		
B9	Telepen		
R1	Enable UPC (A/E)		
R2	Enable UPC (A/E) +2		
R3	Enable UPC (A/E) +5		
R4	Enable EAN (13/8)		
R5	Enable EAN (13/8) +2		

CONTINUED ON NEXT PAGE...

3. Add/Activate Specific Bar Code Symbologies (continued)

Computer Command	Function /Description	Bar Code Command
(ZZ)	START/END Programming Menu	
R6	Enable EAN (13/8) +5	
R7	Enable Industrial 2 of 5	
R8	Enable Interleaved 2 of 5	
JZ	TriOptic	
R9	SCode	

4. Delete/Deactivate Specific Bar Code Symbologies

Computer Command	Function /Description	Bar Code Command
(ZZ)	START/END Programming Menu	
BO	Disable all symbologies	

5. Options for UPC

Computer Command	Function /Description	Bar Code Command
(ZZ)	START/END Programming Menu	
E2	UPC-A (13 Digits) Add leading zero; Transmit check digit (Translates UPC-A to EAN-13)	
E3	UPC-A (12 Digits) Do not add leading zero; Transmit check digit	
E4	UPC-A (12 Digits) Add leading zero; Do not transmit check digit (Translates UPC-A to EAN-13 w/o CD)	
E5	UPC-A (11 Digits) Do not add leading zero; Do not transmit check digit	
E6	UPC-E (8 Digits) Add leading zero; Transmit check digit (Translates UPC-E to EAN-8)	
E7	UPC-E (7 Digits) Do not add leading zero; Transmit check digit	
E8	UPC-E (7 Digits) Add leading zero; Do not transmit check digit (Translates UPC-E to EAN-8 w/o CD)	
E9	UPC-A (6 Digits) Do not add leading zero; Do not transmit check digit	
6Q	Do not expand UPC-E to UPC-A	
6P	Expand UPC-E to UPC-A	



6. Options for EAN-8 & EAN-13

Computer Command	Function /Description	Bar Code Command
(ZZ)	START/END Programming Menu	
6J	EAN-13 Disable transmit CD	
6K	EAN-13 Enable transmit CD	
6H	EAN-8 Disable transmit CD	
6I	EAN-8 Enable transmit CD	
IB	Disable ISBN translation	
IA	Enable ISBN translation	
HN	Disable ISSN translation	
HO	Enable ISSN translation	



7. Options for Code 39 & IT Pharmaceutical

Computer Command	Function /Description	Bar Code Command
(ZZ)	START/END Programming Menu	
8E	Enable 1 character (3 characters including start/stop characters)	
8D	Enable 3 characters	
C1	Disable check digit calculation	
C0	Enable check digit calculation	
D9	Transmit check digit	
D8	Do not transmit check digit	
D1	Do not transmit start/stop characters (*.....*)	
D0	Transmit start/stop characters (*.....*)	
+M	Disable concatenation	
+L	Enable concatenation	
-Z	Default algorithm	
-Y	Enables alternate decode algorithms. May improve performance on certain I 2 of 5, Code 39, Codabar or MSI/Plessey bar codes. Enable alternative algorithm	

CONTINUED ON NEXT PAGE

7. Options for Code 39 & IT Pharmaceutical (continued)

Computer Command	Function /Description	Bar Code Command
(ZZ)	START/END Programming Menu	
D6	IT Pharmaceutical only	
DB	IT Pharmaceutical, enable transmit of leading A	
DA	IT Pharmaceutical, disable Transmit of leading A	



- 43 Data digits are available: 0 to 9, A to Z (caps only) plus . - \$ / + % and space. If a check digit is present, it will appear as part of the data.
- If the scanner is programmed to calculate the check digit, and the bar code is not printed with a check digit, the bar code will not read.

8. Options for Codabar (NW-7)

Computer Command	Function /Description	Bar Code Command
(ZZ)	START/END Programming Menu	
H4	Enable ABC code only	
HA	Enable Codabar only	
H3	Enable Codabar and ABC code	
HC	Enable 1 character (3 characters including start/stop characters)	
HB	Enable 3 characters	
HF	Enable 5 characters	
F0	Do not transmit start/stop characters	
F1	Transmit start/stop characters as ABCD/TN*E	
F2	Transmit start/stop characters as abcd/tn*e	
F3	Transmit start/stop characters as ABCD/ABCD	
F4	Transmit start/stop characters as abcd/abcd	
H8	Transmit check digit	
H9	Do not transmit check digit	

CONTINUED ON NEXT PAGE

8. Options for Codabar (NW-7) (Continued)

Computer Command	Function /Description	Bar Code Command
(ZZ)	START/END Programming Menu	
H7	Do not calculate check digit	
H6	Calculate check digit	
HI	Inter-character Gap Check – No check	
HH	Inter-character Gap Check	
-X	Default algorithm	
-Y	Enables alternate decode algorithms. May improve performance on certain I 2 of 5, Code 39, Codabar or MSI/Plessey bar codes.	

**Codabar (NW-7) Format**

Start Character	1 to 42 data digits	Check digit	Stop Character
A T
a t
A A
a a

- Codabar (NW-7) has four different start/stop character schemes as shown above. The check digit is optional and, if present, would be the last character.
- If the scanner is programmed to calculate the check digit and the bar code is not printed with a check digit, the bar code will not be read.

9. Options for Interleaved & Industrial 2 of 5

Computer Command	Function /Description	Bar Code Command	
(ZZ)	START/END Programming Menu		
G0	Do not calculate check digit		
G1	Calculate check digit		
E0	Transmit Check digit		
E1	Do not transmit check digit		
GE	Enable 1 character minimum		
GF	Enable 3 character minimum		
GI	Enable 5 character minimum		
GG	Enable transmit SCode as Interleaved 2 of 5		
GH	Disable transmit SCode as Interleaved 2 of 5		
-X	Default Algorithm		
-Y	Enables alternate decode algorithms. May improve performance on certain I 2 of 5, Code 39, Codabar or MSI/Plessey bar codes.		

2 of 5 Format (Standard and Interleaved)

1 to 44 data digits	CD
numeric only (0 to 9)	Check Digit

Opticon strongly recommends that the "Fixing the Number of Digits" featured in Section 13 be employed whenever 2 of 5 bar codes are used.

10. Options for IATA

Computer Command	Function /Description	Bar Code Command
(ZZ)	START/END Programming Menu	
4H	Do not calculate check digit	
4J	Calculate check digit (CPN + Form + Serial)	
4I	Calculate check digit (Form + Serial)	
4K	Calculate check digit (All data)	
4L	Transmit check digit	
4M	Do not transmit check digit	
-X	Default Algorithm	
-Y	Enables alternate decode algorithms. May improve performance on certain I 2 of 5, Code 39, Codabar or MSI/Plessey bar codes.	

The IATA code is a variable length symbology with an optional check digit and non-printable start/stop characters. The following characters are supported: Digits 0 up to 9.

The checksum is calculated as the modulo seven of the data string. IATA is an acronym for International Air Transport Association.

String format	CPN	AC	FC	SN	CD
Meaning of Acronym	Coupon	Airline Code	Form Code	Serial Number	Check Digit
Number of digits (15 total)	1	3	2	8	1

- ◆ Enable check digit check
- ◆ Selection of the check digit calculation
- ◆ Disable transmission of the check digit

Check digit calculation: If the check digit calculation is required, then the appropriate calculation method must be selected.

11. Options for Code-128 / EAN-128







Computer Command	Function /Description	Bar Code Command
(ZZ)	START/END Programming Menu	
OF	Disable EAN-128 only	
JF	Enable EAN-128 only	
MP	Disable concatenation	
MO	Enable concatenation	

**12. Options for Code-93**

Computer Command	Function /Description	Bar Code Command
(ZZ)	START/END Programming Menu	
+W	Disable concatenation	
+V	Enable concatenation	



13. Fixing the Number of Digits

Computer Command	Function /Description	Bar Code Command
(ZZ)	START/END Programming Menu	
H0	Disable fixed length all symbologies	
H1	Enable fixed length all symbologies	
HK	Enable fixed length for selected codes	
HL	Enable minimum length for selected codes	
HM	Enable maximum length for Selected codes	



To avoid truncation errors, the scanner can be programmed to only decode bar codes of one specific length, i.e., containing a specific number of digits. It is also possible to program the scanner to only decode bar codes of either of two specific lengths.

To fix two (2) lengths (or number of digits) of bar code for all symbologies:

1. Scan "START" to enter the programming mode
2. Scan "Enable fixation(H1) for all symbologies" bar code
3. Scan a sample bar code of the desired length
4. Repeat Step #3, re-scanning the sample bar code (this may be the same as the first one)
5. Scan "END" to exit the programming mode

To fix one (1) or two (2) different lengths of bar codes for selected symbologies:

1. Scan "START" to enter the programming mode
2. Scan "Enable fixation(HK) for selected symbologies" bar code
3. Scan a sample bar code of the desired length #1
- 4a. Go to step 5
- or
- 4b. Scan a sample bar code of the desired length #2
5. Scan "END" to exit the programming mode

"Fixing the Number of Digits" can only be applied to Code 39, NW-7, 2 of 5, MSI/Plessey. WPC, Code 93, IATA, Code 128 are not affected.

Setting Minimum/Maximum Length



This option modifies the default minimum length table. To use this option, perform the following steps:

1. Scan "START" to enter the programming mode
2. Scan "Enable minimum length for selected codes" (HL)
3. Scan bar codes of the *required type and length*.
4. Scan "END" to end the programming sequence.

For example, if a Code 39 label of length 2 characters were scanned in Step 3 then only Code 39 labels would be checked for a minimum length of 2 characters. If a second label had been read in Step 3 (immediately following the first), then that particular symbology could have been set to different minimum character length.

In a similar manner, the maximum length for selected codes can be established by using the "Enable maximum length for selected codes" (HM) command.

14. Creating a Prefix and/or Suffix

Computer Command	Function /Description	Bar Code Command
(ZZ)	START/END Programming Menu	
Z3	Display Settings including Prefix/Suffix value and length (expressed in hexadecimal format)	

The Z3 command can be used to instruct the scanner to provide a list of its current software settings including prefixes and suffixes.

The scanner can be programmed to transmit a prefix and/or suffix with the decoded data. A Prefix (or a

Example: To add the alpha character "A" as a Prefix and "B" as a Suffix to UPC-A bar code data:

1. Scan "START/END Programming Mode"
2. Scan N1, representing a Prefix for UPC-A
3. Scan 0A, representing the alpha character "A"
4. Scan N6, representing a Suffix for UPC-A
5. Scan 0B, representing the alpha character "B"
6. Scan "START/END Programming Mode"

Suffix) is composed of up to 4 characters. The following steps are used to establish a Prefix that will be transmitted with the bar code data:









1. Scan Start
2. Scan the bar code representing the symbology to which you wish to add a Prefix
3. Scan the character(s) that will comprise the Prefix. Up to four numeric, alpha or control character(s) may be used.
4. Scan "STOP" to exit the Programming Mode.

15. Setting Prefixes (Identifying the Symbology)

Computer Command	Function /Description	Bar Code Command
(ZZ)	START/END Programming Menu	
RY	All codes	
N1	UPC-A	
M0	UPC-A +2 or +5	
N2	UPC-E	
M1	UPC-E +2 or +5	
N3	EAN-13	
M2	EAN -13 +2 or +5	
N4	EAN-8	
M3	EAN-8 +2 or +5	
M4	Code 39	
M5	Codabar (NW-7)	
M6	Industrial 2 of 5	

CONTINUED ON NEXT PAGE..

15. Setting Prefixes (Identifying the Symbology) (continued)









Computer Command	Function /Description	Bar Code Command
(ZZ)	START/END Programming Menu	
M7	Interleaved 2 of 5	
M8	Code 93	
M9	Code 128	
I8	IATA	
N0	MSI/Plessey	
MB	SCode	
L8	Telepen	

16. Setting Suffixes (Identifying the Symbology)











Computer Command	Function /Description	Bar Code Command
(ZZ)	START/END Programming Menu	
RZ	All Codes	
N6	UPC-A	
O0	UPC-A +2 or +5	
N7	UPC-E	
O1	UPC-E +2 or +5	
N8	EAN-13	
O2	EAN-13 +2 or +5	
N9	EAN-8	
O3	EAN-8 +2 or +5	
O4	Code 39	
O5	Codabar (NW-7)	
O6	Industrial 2 of 5	

CONTINUED ON NEXT PAGE..





























16. Setting Suffixes (Identifying the Symbology) (continued)

Computer Command	Function /Description	Bar Code Command
(ZZ)	START/END Programming Menu	
O7	Interleaved 2 of 5	
O8	Code 93	
O9	Code 128	
I9	IATA	
N5	MSI/Plessey	
OB	SCode	
L9	Telepen	

17. Direct Input of Numeric Characters

Computer Command	Function /Description	Bar Code Command
(ZZ)	START/END Programming Menu	
Q0	0	
Q1	1	
Q2	2	
Q3	3	
Q4	4	
Q5	5	
Q6	6	
Q7	7	
Q8	8	
Q9	9	

18. Direct Input of Alpha Characters

(ZZ)	START/END Program Menu		0N	N	
0A	A		0O	O	
0B	B		0P	P	
0C	C		0Q	Q	
0D	D		0R	R	
0E	E		0S	S	
0F	F		0T	T	
0G	G		0U	U	
0H	H		0V	V	
0I	I		0W	W	
0J	J		0X	X	
0K	K		0Y	Y	
0L	L		0Z	Z	
0M	M		(ZZ)	START/END Program Menu	

19. Direct Input of Alpha Characters (Lower Case)

(ZZ)	START/END Program Menu		\$N	n	
\$A	a		\$O	o	
\$B	b		\$P	p	
\$C	c		\$Q	q	
\$D	d		\$R	r	
\$E	e		\$S	s	
\$F	f		\$T	t	
\$G	g		\$U	u	
\$H	h		\$V	v	
\$I	i		\$W	w	
\$J	j		\$X	x	
\$K	k		\$Y	y	
\$L	l		\$Z	z	
\$M	m		(ZZ)	START/END Program Menu	

20. Direct Input of Control Characters

(ZZ)	START/END Program Menu		1M	^M (CR)	
9G	^@ (null)		1N	^N (SO)	
1A	^A (SCH)		1O	^O (SI)	
1B	^B (STX)		1P	^P (DLE)	
1C	^C (ETX)		1Q	^Q (DC1)	
1D	^D (EOT)		1R	^R (DC2)	
1E	^E (ENQ)		1S	^S (DC3)	
1F	^F (ACK)		1T	^T (DC4)	
1G	^G (BEL)		1U	^U (NAK)	
1H	^H (BS)		1V	^V (SYN)	
1I	^I (HT)		1W	^W (ETB)	
1J	^J (LF)		1X	^X (CAN)	
1K	^K (VT)		1Y	^Y (EM)	
1L	^L (FF)		START/END Program Menu	(ZZ)	

20. Direct Input of Control Characters (Continued)

Computer Command	Function /Description	Bar Code Command
(ZZ)	START/END Programming Menu	
1Z	^Z (SUB)	
9A	^[(ESC)	
9B	^\ (FS)	
9C	^] (GS)	
9D	^^ (RS)	
9E	^_ (US)	
9F	DEL (ASCII 127)	

21. Direct Input Characters Misc.

(ZZ)	START/END Program Menu	
5A	<SPACE>	
5B	!	
5C	"	
5D	#	
5E	\$	
5F	%	
5G	&	
5H	`	
5I	(
5J)	
5K	*	
5L	+	
5M	,	

5N	-	
5O	.	
5P	/	
6A	:	
6B	;	
6C	<	
6D	=	
6E	>	
6F	?	
6G	@	
7A	[
7B	\	
7C]	
START/END Program Menu	(ZZ)	

21. Direct Input Characters Misc. (Continued)

Computer Command	Function /Description	Bar Code Command
(ZZ)	START/END Programming Menu	
7D	^	
7E	-	
7F	`	
9T	{	
9U		
9V	}	
9W	~	

22. Code Identification & Characters/Digits Transmitted

This feature instructs the scanner to use pre-existing code identifiers and/or to calculate/transmit a number indicating the total number of characters that are being transmitted to the host for specific symbologies. This feature allows the host to verify that the correct amount of data was received. This information may be transmitted as either a prefix or suffix.





Code identification using the pre-existing symbology codes can be accomplished using the "Code identification" command as shown in the example below.

Code length is transmitted as 2 or 6 digits depending upon the selection made from the menu below.

These commands can be used together or individually as required.

Example: To set a prefix for "<code identification>:<code length>:" scan the following menu items:

< START/END >	Menu below
<Set Prefix All Codes>	Section 15 (or specific symbology)
<Enable Code Identification>	Menu below (\$2)
<:>	Menu below (6A)
<Enable Code Length 2 or 6>	Menu below (\$3) or (\$6)
<:>	Menu below (6A)
<START/END>	Menu below

Computer Command	Function /Description	Bar Code Command
(ZZ)	START/END Programming Menu	
\$2	Code identification	
\$3	Enable code length 2 digits	
\$6	Enable code length 6 digits	
6A	Direct Input Character ":"	

The Opticon Code Identifiers are the following:

UPC-A	C	EAN-13	B	Code 39	V
UPC-A +2	F	EAN-13 + 2	L	Code 39 (Full ASCII)	W
UPC-A +5	G	EAN-13 +5	M	Italian Pharmaceutical	Y
UPC-E	D	EAN-8	A	Codabar	R
UPC-E +2	H	EAN-8 +2	J	Codabar ABC	S
UPC-E +5	I	EAN-8 +5	K	Industrial 2 of 5	O
IATA	P	Code 128	T	Interleaved 2 of 5	N
MSI/Plessey	Z	EAN 128	T	SCode	g
Telepen	d	Code 93	U		

23. Communication Parameters

Computer Command	Function /Description	Bar Code Command
(ZZ)	START/END Programming Menu	
K0	150 baud	
K1	300 Baud	
K2	600 Baud	
K3	1,200 Baud	
K4	2,400 Baud	
K5	4,800 Baud	
K6	9,600 Baud	



CONTINUED ON NEXT PAGE...

23. Communication Parameters (continued)

Computer Command	Function /Description	Bar Code Command
(ZZ)	START/END Programming Menu	
K7	19,200 Baud	
L0	7 Data Bits	
L1	8 Data bits	
L2	Parity = None	
L3	Parity = Even	
L4	Parity = Odd	
L5	1 Stop Bit	
L6	2 Stop Bits	





24. Handshaking

Computer Command	Function /Description	Bar Code Command
(ZZ)	START/END Programming Menu	
I0	Unlimited wait for CTS from terminal	
I1	100 mS wait for CTS from terminal	
I2	200 mS wait for CTS from terminal	
I3	400 mS for CTS from terminal	
P0	No Handshaking	
P1	Busy/Ready	
P2	Modem	
P3	ACK/NAK (1 sec timeout with error buzzer)	
P4	ACK/NAK no response (100 ms timeout, terminates with good read buzzer)	
ZG	XON/XOFF	
KA	No intercharacter delay	
KB	20 ms intercharacter delay	

CONTINUED ON NEXT PAGE...

24. Handshaking (continued)

Computer Command	Function /Description	Bar Code Command
(ZZ)	START/END Programming Menu	
KC	50 ms intercharacter delay	
KD	100 ms intercharacter delay	

25. Buzzer Operation

Computer Command	Function /Description	Bar Code Command
(ZZ)	START/END Programming Menu	
T0	Volume = Maximum	
T1	Volume = Upper Mid-range	
T2	Volume = Lower Mid-range	
T3	Volume = Minimum	
W0	Disable buzzer	
W1	Enable buzzer at 3kHz	
W2	Enable buzzer at 3kHz with 2.5kHz interval	
W3	Enable buzzer at 3kHz with 4kHz interval	
W4	Buzzer duration 0.10 sec	
W5	Buzzer duration 0.20 sec	
W6	Buzzer duration 0.40 sec	
W7	Buzzer duration 0.05 sec	
W8	Enable buzzer	



26. Positive & Negative Bar Codes

Computer Command	Function /Description	Bar Code Command
(ZZ)	START/END Programming Menu	
V2	Positive bar code only (black bars/white spaces)	
V3	Negative bar codes	
V4	Both positive & negative bar code	



27. Setting the Trigger & Auto-Trigger Functions





Computer Command	Function /Description	Bar Code Command
(ZZ)	START/END Programming Menu	
S7	Disable the trigger function / laser is ON continuously	
S8	Enable the trigger function /laser is OFF until trigger is activated or "pulled"	
+F	Disable Auto-trigger	
+I	Enable Auto-trigger	
Z	Activate the trigger; turns on the laser	Use as Computer Command



The Trigger function is enabled in the default setting. This means that the laser is "OFF" until triggered by command or via the Auto-Trigger which is also enabled in the default setting. For some applications, you may wish the laser to operate continuously, although this is not recommended. This can be done by disabling the Trigger function using the S7 command. Once in the "Trigger Disabled" mode, the laser is on continuously.

The software trigger is actuated by downloading and <ESC> Z <CR> computer command from the host. (See Scanner Timeout to establish the length of time the scanning light remains ON after the trigger is activated.) A hardware trigger is not available with this scanner.

28. Selecting the Read Mode





Computer Command	Function /Description	Bar Code Command
(ZZ)	START/END Programming Menu	
S0	Single Read Mode (Trigger enabled mode only)	
S1	Multiple Read Mode	
S2	Continuous Read Mode	







The operation of the scanner in the various read modes is described in the table below. The "Continuous Read" mode is helpful in positioning the scanner for optimum reading. In "Continuous Read," the scanner's buzzer functions like a Geiger counter, sounding the most active at the position achieving the greatest number of good reads.

Mode	Trigger Function Enabled (S8)	Trigger Function Disabled (S7)
Multiple Read	After receiving a trigger pulse, scanner will read multiple, different bar codes in succession until it times out. (Each read will reset the scanner's time out)	Scanner will read different bar codes in succession if they are presented to the read window.
	Scanner may not read the same bar code twice if they are consecutive. (See Sect. 32)	Scanner may not read the same bar code twice if they are consecutive. (See Sect. 32)
Continuous Read	Scanner will read the same bar code continuously after receiving a trigger pulse until the label is removed, the laser then times out.	Scanner will read the same bar code continuously.
Single Read	Scanner will read only one bar code after receiving a trigger pulse. The scanner time out is terminated on a good read and the laser turns off.	Same as Multiple Read mode, above.

29. Parallel Read Mode

Computer Command	Function /Description	Bar Code Command
(ZZ)	START/END Programming Menu	
+6	2 Parallel labels only	
+7	3 Parallel labels only	
+8	4 Parallel labels only	

30. Add-on Wait Mode (Applies to UPC/EAN only)

Computer Command	Function /Description	Bar Code Command
(ZZ)	START/END Programming Menu	
XA	Disable Add-on wait mode	
XB	Enable Add-on wait mode of 0.25 seconds	
XC	Enable Add-on wait mode of 0.50 seconds	
XD	Enable Add-on wait mode of 0.75 seconds	



These commands are used when UPC/EAN with add-on is enabled. The reader searches within the selected time for a valid add-on code. If a valid add-on code is found, the reader transmits the data immediately. If nothing is found behind the code, the reader will transmit the data without the add-on.

31. Scanner Timeout (Trigger Enabled Mode only)









These commands, which are only applicable in the Trigger Enabled mode, establish the time-out period after the trigger pulse is received. In Single Read Mode, the time out is terminated upon a good read. In Multiple Read and Continuous Read Modes the time out is reset after any good read.

Computer Command	Function /Description	Bar Code Command
(ZZ)	START/END Programming Menu	
Y1	1 Second after triggering	
Y2	2 Seconds after triggering	
Y3	3 Seconds after triggering	
Y4	4 Seconds after triggering	
Y5	5 Seconds after triggering	
Y6	6 Seconds after triggering	
Y7	7 Seconds after triggering	
Y8	8 Seconds after triggering	
Y9	9 Seconds after triggering	
YL	Read time x 10	
YM	Indefinitely after triggering	



32. Multiple Read Reset Time

This option is used in conjunction with the multiple read mode. The selected time sets the period the scanners should be pointed away from a label before that same label can be decoded again. Indefinitely means that the next bar code must always be different during the time the scanner is triggered.

Computer Command	Function /Description	Bar Code Command
(ZZ)	START/END Programming Menu	
AH	Set at 50 msec	
AI	Set at 100 msec	
AJ	Set at 200 msec	
AK	Set at 300 msec	
AL	Set at 400 msec	
AM	Set at 500 msec	
AN	Set at 600 msec	
AG	Set indefinitely	



33. Quiet Zone Options

With this option the scanner can decode bar codes that have smaller quiet zone margins than specified for the symbology. Be careful when using this option as its use may increase the possibility of partial and ghost reads. Do not use smaller margin checks than necessary. If possible, replace the bar codes labels with others that have the correct start and end margins.

Computer Command	Function /Description	Bar Code Command
(ZZ)	START/END Programming Menu	
YN	No margin check	
YO	Margin check 1/7 nominal	
YP	Margin check 2/7 nominal	
YQ	Margin check 3/7 nominal	
YR	Margin check 4/7 nominal	
YS	Margin check 5/7 nominal	
YT	Margin check 6/7 nominal	
YU	Margin check normal	



34. Redundant Decoding

The Number of Redundant Decodes determines how many times the scanner must decode a bar code and obtain the same value before it will transmit the data. For example, if the redundancy is set at three times, the scanner will not transmit data until it has completed three consecutive, identical "good reads". In the case of a poor label which generates an intermediate "no decode" within a sequence of four scans where three of the four have resulted in "good reads", the scanner will transmit the data after the fourth scan. In other words, a "no decode" does not restart the sequence.

Computer Command	Function /Description	Bar Code Command
(ZZ)	START/END Programming Menu	
X0	Read bar code once	
X1	Read bar code twice	
X2	Read bar code three times	
X3	Read bar code four times	
BS	Read bar code five times	
BT	Read bar code six times	
BU	Read bar code seven times	
BV	Read bar code eight times	
BW	Read bar code nine times	



35. Transmitting Error Indications (Trigger Enabled only)

Computer Command	Function /Description	Bar Code Command
(ZZ)	START/END Programming Menu	
TH	Error message no label	
TI	Error message no decode	
TG	Clear error messages for no label and no decode	
WD	Disable response to command	
WC	Enable response to command OK=ACK, ERROR=NAK	
WB	Buzzer Control to Command – Disable	
WA	Buzzer Control to Command – Enable	

Error Messages – No decode / no label





Messages may be user defined for the “no decode” and “no label” error modes independently. Using the “Error message no label” (TH) and “Error message no decode” (TI) menu commands a maximum of 4 characters may be user specified for transmission should these errors occur.

The following process should be followed to designate these error codes:

1. Scan “START” to enter the programming mode.
2. Scan “Error message no label” (TH).
3. Scan bar codes of the desired error message characters (4 max)
4. Scan “END” to end the programming sequence.

In a similar fashion, the “Error message no decode” (TI) can be defined.

36. Good Read LED Operation

Computer Command	Function /Description	Bar Code Command
(ZZ)	START/END Programming Menu	
T4	Good read LED disabled after decode	
T5	Good read LED ON after decode for .20 seconds	
T6	Good read LED ON after decode for .40 seconds	
T7	Good read LED ON after decode for .80 seconds	



Appendix D: Dimensional Drawing

(All dimensions in millimeters)

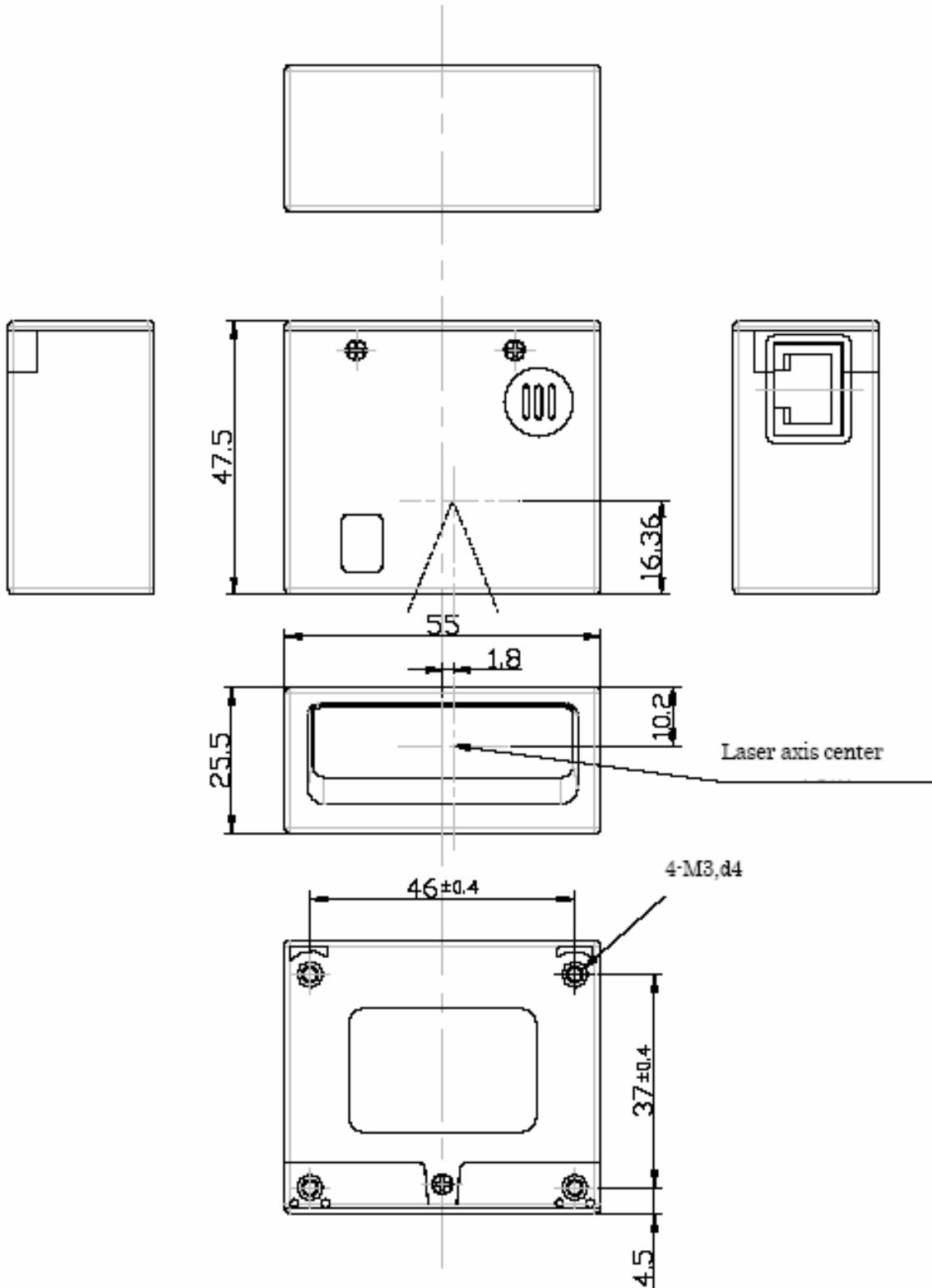

Appendix E: LMD 1135 – Optical Performance (typical unit)

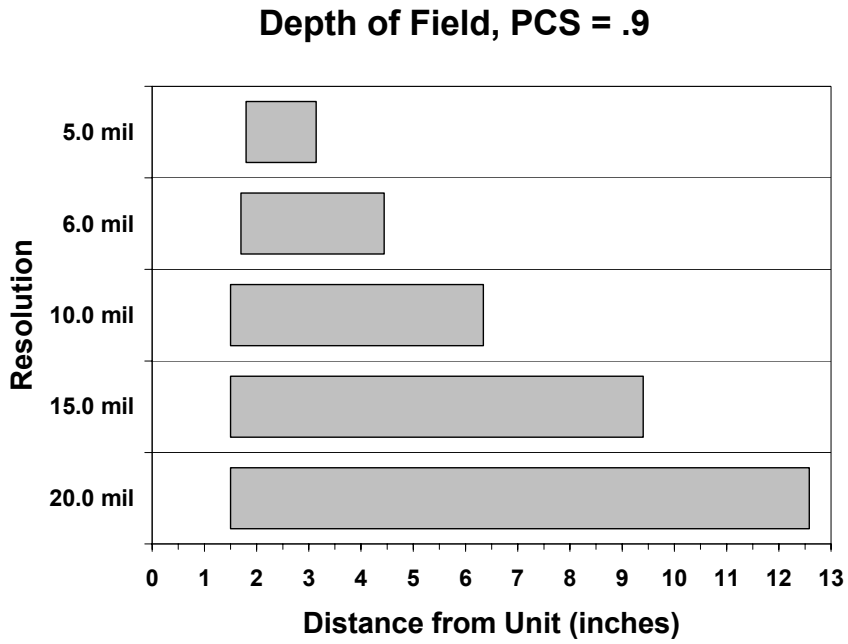

Notes

Free Manuals Download Website

<http://myh66.com>

<http://usermanuals.us>

<http://www.somanuals.com>

<http://www.4manuals.cc>

<http://www.manual-lib.com>

<http://www.404manual.com>

<http://www.luxmanual.com>

<http://aubethermostatmanual.com>

Golf course search by state

<http://golfingnear.com>

Email search by domain

<http://emailbydomain.com>

Auto manuals search

<http://auto.somanuals.com>

TV manuals search

<http://tv.somanuals.com>