

User's Manual



Series NFT 1125/2135
Miniature CCD
Fixed Position Scanners
Manual No. 25-NFT1121-01
Rev. August 1999

8 Olympic Drive
Orangeburg, NY 10962
Tel 845.365.0090
Fax 845.365.1251
www.opticonUSA.com

* This page left intentionally blank for repagination *

Contents

Section 1 Introduction and Getting Started	1
Product Overview	1
Quick Start-Up Procedure	1
Section 2 Technical Specifications	3
Physical Specifications	3
Symbolologies Supported	3
Optical Specifications	3
Electrical Specifications	4
RS232 Communications Specifications	4
Connector Pin-Outs	5
Environmental Specifications	5
Section 3 Positioning the Scanner	7
Getting Optimum Performance	7
Measuring Scanner Performance	10
Application Notes:	11
Tips for Achieving High Throughput	11
Tips for Insuring Highest Data Integrity	11
Tips for Verifying the Presence of a Bar Code	12
Section 4 Configuring the Scanner	13
Programming Menus & Commands	13
Default Settings	13
Section 5 Application Engineering Support	15
Technical Assistance and Support	15
Common Causes of Poor Performance	15
Modified and/or Customized Scanners	15
Appendix A Programming Menus & Commands	17
Appendix B Dimensional Drawings	53
Appendix C Optical Performance Charts	55

* This page left intentionally blank for repagination *

Organization of this Manual

This manual provides the necessary instructions for installation and use of Opticon NFT-1125/2135 Series Fixed Position Scanners. The manual is organized as follows:

Section 1 Introduction and Getting Started

Describes the general operation of a NFT-1125/2135 Series scanner. Also provides a Quick Start-Up Procedure that allows you to begin using the scanner immediately.

Section 2 Technical Specifications

Provides complete specifications, including mechanical details, optical performance, RS232 communications and other technical data.

Section 3 Positioning Scanner for Optimum Performance

Provides detailed instructions and tips for mounting and positioning the scanning to obtain the best scanning performance. Application Notes describe guidelines for maximizing specific characteristics.

Section 4 Configuring the Scanner

Describes how various parameters can be programmed to customize the scanner for your specific application.

Section 5 Application Engineering Support

Discusses the most common questions and concerns when adapting a NFT-1125/2135 Series scanner in your application.

Appendices Detailed Supporting Information

Provides detailed information in specific areas such as the programming commands for configuring various parameters of the NFT-1125/2135 Series scanner.

* This page left intentionally blank for repagination *

Section 1 Introduction and Getting Started

Product Overview

The NFT-1125/2135 Series Fixed Position Scanners are miniature, 100/200 scans per second bar code readers designed to be easily incorporated into host equipment. CCD scanning technology features 100% solid state design with absolutely no moving parts. Durability and reliability are assured.

Advanced 16-bit microprocessor technology coupled with Opticon's proven decoding algorithms result in high speed operation with superior accuracy. The scanners are fully programmable allowing the user to customize parameters including changing communication settings, selecting symbologies, adding prefixes and appending suffixes. Programmable settings can be downloaded from the host CPU or computer directly to the scanner.

The NFT-1125/2135 Series scanners are encased in compact, rugged steel enclosures. The compact size permits installation in the tightest areas. Scanners are available in both front and side view configurations allowing great flexibility in mounting and positioning the scanner for optimum performance.

Quick Start-Up Procedure

This section is for those who wish to start using the scanner before reading the complete manual. In only a few steps the scanner will be operable.

- 1) Turn off the power to your PC and connect the scanner to an RS232 communications port. Note: You must provide +5 Volt DC power to the scanner. This can be accomplished using the power supply and patch cable available from Opticon. Turn on the power to the PC.
- 2) Using communications software (e.g., Procom), set the following communication parameters:

9600 baud, 1 Start / Stop Bit, 8 Data Bits,
No Parity, No Handshaking, No Flow Control
- 3) If you are operating in a Microsoft **Windows 3.1** environment, skip to Step 5.
- 4) If you are operating in a Microsoft **Windows 95** environment, you can set the communication parameters using Hyper Terminal as follows:
 - ◆ Open Hyper Terminal. This can be done from Start→Programs→Accessories
 - ◆ Select **Hypertrm.exe** to create a New Connection
 - ◆ In the **Connection Description** dialog screen enter a name for the new file. If desired, select an Icon. Click OK
 - ◆ In the **Phone Number** dialog screen, in the box entitled: **Connect using**. select the communication port, for example, "Direct to Com 1" Click OK
 - ◆ In the **Com 1 Properties** screen, enter the appropriate Port Settings:

Bits per second = 9600
Data bits = 8
Parity = None
Stop Character = 1
Handshaking = None
...Click OK
 - ◆ The Hyperterminal folder you just created will open. From the File pull-down menu, select **Properties** then click on the **Setting** Tab

- ◆ In the **Properties Settings** dialog screen:
Select Terminal keys for the Function, arrow and control key
Select ANSI for Emulation,
The Backscroll buffer line can remain at the default 500
- ◆ Click on the ASCII Setup button

In the ASCII Setup screen, select Echo typed locally so that any keyboard commands you input will appear on your screen. Click OK. This returns you to the Properties Setting. Click OK.

Your PC and the scanner should now communicate. Skip to Step 6.

- 5) In a Microsoft **Windows 3.1** environment, set the communication parameters using the Terminal function of Windows.
- ◆ From Window's **Program Manager** Main Menu, select **Terminal**
 - ◆ From the **Terminal** menu, select Settings
 - ◆ From the **Settings** menu, select Terminal Emulation
 - ◆ Set the emulation to TTY (generic)
 - ◆ From the **Settings** menu, select Terminal Preferences and select the following:
Terminal Modes: Line Wrap, Local Echo, Sound
CR /LF: Inbound, Outbound
Columns: 80
 - ◆ From the **Settings** menu, select Communications
 - ◆ Select the COM port and set communication parameters as shown in Step 2, including no flow control
- 6) To verify that the scanner and the PC are communicating properly, send the following command from your PC keyboard to activate the scanner's buzzer.
Send the command: <Escape> V5 <Carriage Return>

Note: Be sure to use capital letters, e.g. "V5", not "v5".

The buzzer should sound, indicating that good communications have been established.

- 7) A red scanning light should be visible. If it is not visible, the scanner may be in a mode that requires a "Trigger" Command from the PC to activate it. You can exit that mode by sending the following command from your PC keyboard:
- <Escape> S7 <Carriage Return>

In this "Trigger Disabled" mode, the red scanner light is always illuminated. You are now ready to scan bar codes.

- 8) Position the red light of the scanner over the bar code symbol to be read. When the bar code symbol is decoded, the scanner will beep and transmit the data to the screen of your PC. You may have to move the scanner closer or farther away from the bar code symbol in order to locate the best reading distance.

This Quick Start-Up procedure will get you started. However, in order to best understand the full capabilities of this scanner, you should read the complete manual.

Section 2

Technical Specifications

Physical Specifications

Case Material	Steel, painted dark gray
Dimensions (LxWxH)	
1126/2126 Side View	3.0 x 2.7 x 1.1 in (76 x 68 x 76 mm)
1127/2127 Front View	2.9 x 2.7 x 1.0 in (74 x 68 x 26 mm)
Weight	8.8 ounces (250 grams) without cable
Cable Length	6 ft (2.8m) with DB25 pin female connector
Mounting	6 threaded (M-3) mounting holes. Mounting fasteners should not extend more than 5mm into the case

Symbologies Supported

Codabar
Code 39
Code 93
Code 128
Standard 2 of 5
Interleaved 2 of 5
MSI / Plessey
UPC / EAN / JAN

Optical Specifications

Scan Rate	1126/1127 100 scans per/sec. 2126/2127 200 scans per/sec.
Wavelength of LED Illumination	660 nanometers
Read Sensor	2048 pixel CCD linear array
Focal Distance (nominal)	
1126 Side View	0.5 inches
1127 Front View	0.3 inches
2126 Side View	1.43 inches
2127 Front View	1.28 inches
Skew Angle	0° to 45° (see Avoiding Specular Reflection and notes)
Rotation	±15°
Pitch Angle	±6°
Area of Specular Reflection	+2 to +9° around X axis (see diagram Section 3)
Max. Bar Code Curvature	0.6 inch radius min. for 10.4 mil EAN-8 label 0.8 inches for 10.4 mil EAN-13 label

Electrical Specifications

Operating Voltage +5VDC \pm 10%

Current Consumption

Dynamic 40 mA typical / 80 mA maximum
 Static 15 mA maximum
 Surge 1.5 A maximum, 0.75A/25 μ S

RS232 Communications Specifications

RS232 Data Transmission Format

Parameter	Default	Optional Settings
Timing	Asynchronous	
No. of Start Bits	1 bit	
No. of Stop Bits	1 bit	1 or 2 bits
No of Data Bits	8 bits	7 or 8 bits
Parity	None	Odd / Even / None
Baud Rate	9600 baud	150 to 19200 baud
Handshaking	None	Hardware / Software / None

RS232 Transmit/Receive Character Format

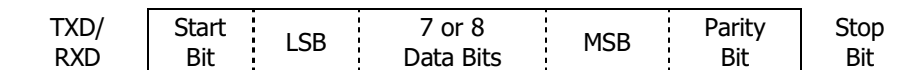

RS232 Data Format

Transmit:

Receive:

RS232 Signal Level

Signal Name	I/O	RS232C Level	
		Mark/Off	Space/On
TXD	Out	-5 to -15	+5 to +15
RXD	In	-3 to -15	+3 to +15

Connector Pin-Outs

DB25 pin Female connector with screws.

Pin	Signal	Color
1	Frame Ground	Black
2	RXD	White
3	TXD	Green
4	CTS	Blue
5	RTS	Gray
7	Signal Ground	Purple
16	Trigger	Brown
25	+5V	Red

Environmental Specifications

Temperature

Operating	+32 to +122° F (0 to 50° C)
Storage	-4 to 140° F (-20 to 60° C)

Humidity (non-condensing)

Operating	20 to 80%
Storage	20 to 95%

* This page left intentionally blank for repagination *

Section 3

Positioning the Scanner

Getting Optimum Performance

Three items greatly impact performance:

1. Distance from the scan window to the bar code
2. Specular Reflection
3. Quality of bar code labels

1) Distance to the Bar Code

The operation of the scanner is similar to a camera. If you photograph an object that is out of focus, the resulting picture will be blurry. The same is true with the scanner. If the bar code label is out of focus, the scanner may have difficulty decoding what appears to be fuzzy bars and spaces.

Focal Distance

Ideally, the distance from the window of the scanner to the bar code label should be equal to the focal distance of the scanner. For the NFT-1125/2135 Series fixed position scanners, the nominal focal distances are:

1126 Side View	0.50 inches (mm)
1127 Front View	0.30 inches (mm)
2126 Side View	1.43 inches (36.5 mm)
2127 Front View	1.28 inches (32.5 mm)

Depth-of-Field

Just as with a camera, the scanner has a depth-of-field. It can read bar codes that are not precisely at the focal distance - maybe a little closer, or a little farther away. However, if the bar code label is positioned too far from the focal distance, the scanner may not be able to successfully decode it.

The depth-of-field varies based on the density of the bar code, i.e., the thickness of the bars. High density bar codes (which have very narrow bars) are readable over a much shorter distance range than low density bar codes with larger bars.

The following table shows the "typical" depth-of-field (closest to farthest reading distances) for the NFT-1125/2135 Series scanners. The actual performance may differ slightly from unit to unit. Also, it is important to note that this data was measured under ideal conditions using high quality bar code labels. In a "real world" environment the conditions will not be as ideal. Therefore, the best practice is to position the scanner at its focal distance rather than at the extremes of its depth-of-field.

**Typical Reading Distance
from Window Depth-of-Field**

Bar Code Density	1127 Front View		1126 Side View		2127 Front View		2126 Side View	
	Min.	Max.	Min.	Max.	Min.	Max.	Min.	Max.
13.0 mil	0.0 in	1.5 in	0.0 in	1.4 in	0.0 in	2.4 in	0.5 in	2.6 in
10.0 mil	0.0 in	1.1 in	0.0 in	1.1 in	0.2 in	1.9 in	0.6 in	2.1 in
7.5 mil	0.0 in	0.9 in	0.0 in	1.0 in	0.4 in	1.7 in	0.7 in	1.9 in
6.0 mil	0.0 in	0.8 in	0.2 in	0.9 in	0.6 in	1.6 in	0.8 in	1.8 in
5.0 mil	0.0 in	0.7 in	0.3 in	0.7 in	1.0 in	1.5 in	0.9 in	1.6 in

Readable Bar Code Width (Field-of-View)

The following table shows the field-of-view at various distances from the window. The field-of-view is the maximum width that the scanner is capable of reading. A bar code label positioned anywhere within this field-of-view can be decoded. The field-of-view is also a measure of the widest bar code label that can be read. Remember: the width of a bar code label includes not only the bars and spaces but also the required white space (quiet zone) on each end.

Distance from Window	Field-of-View (Maximum Readable Bar Code Width)			
	1127 Front View	2127 Front View	1126 Side View	2126 Side View
0.5 in	2.6 in	2.6 in	2.5 in	2.5 in
1.0 in	2.9 in	3.0 in	2.7 in	3.1 in
1.5 in	3.3 in	3.4 in	3.0 in	3.5 in
2.0 in	3.7 in	3.9 in	3.2 in	3.8 in
2.5 in		4.3 in		4.1 in

Good design policy is to position the scanner at its focal distance and at the center of the field-of-view. Do not position it near the extremes of the reading range.

2) Avoiding Specular Reflection

Do not position the scanner at an angle that causes the LED illumination to be reflected directly back into the scanner. This is called specular reflection. Too much reflected light can "blind" the scanner preventing a good decode.

If the bar code label is located on a flat surface, specular reflectivity occurs between 2 to 9 degrees off perpendicular (see diagram). If the bar code label is located on a cylindrical surface, such as a test tube, the angle of specular reflection is measured tangent to the curve. If the curved surface is also moving, there may be more than one position causing specular reflection. The following diagram indicates the area to avoid:

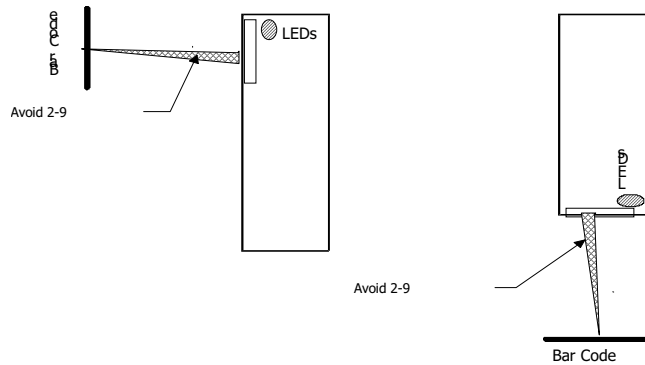

3) Quality Bar Code Labels

The quality of the bar code label can affect the scanning performance. Poor quality labels are more difficult to decode and may result in non-reads or potential misreads. The bar code label should be printed to specifications. This means that the bars are printed within spec, with the correct widths, no ink spread, crisp edges and no voids. There should be a sufficient quiet zone on both end of the bar code label.

For best results the paper or label stock should have a matte finish to diffuse light. The print contrast signal (which is a comparison of the reflectance of the bars and the background stock) should be as high as practical.

Measuring Scanner Performance

Two methods are helpful in determining the optimum position of the scanner. The first method is to program the scanner for Trigger Disable and Continuous Read modes. The scanner will be always on and will continuously read the same bar code. Since the buzzer sounds each time the bar code is read, the sound of the buzzer can be used like a "Geiger counter" (as the position of the scanner changes, the sound of the buzzer will change). The buzzer sound will be loudest and most continuous at the best reading positions.

The Read Rate Test

The second method, the Read Rate Test, provides a mathematical calculation of scanning performance. In this test the scanner scans a bar code 100 times and then calculates the number of those scans that resulted in a good decode. That number, expressed as a percentage, will be transmitted to the host. For example, 93% means that the scanner decoded the bar code symbol 93 times out of the 100 scan attempts. By performing the Read Rate Test with the scanner mounted in various positions you can determine which of those locations results in the best performance.

Here's how to perform the Read Rate Test:

- 1) Program the scanner for Continuous Read (S2) and Trigger Enabled (S8).
- 2) Instruct the scanner to enter the Read Rate Test mode (ZA).
- 3) Locate the scanner in the desired position relative to a test bar code then enter a Z command. The scanner will read the bar code once and store it in memory.
- 4) Enter another Z command. The scanner will scan the bar code 100 times and then transmit the Read Rate Percentage to the host.
- 5) Steps 3 and 4 can be repeated as often as desired, moving the scanner to new locations before each test.
- 6) Exit the Read Rate Test mode (ZG).

Application Notes:

Tips for Achieving High Throughput

In some applications your primary objective may be to achieve the highest possible throughput rate. The following list identifies the parameters and scanner settings that can maximize scanning and decode throughput speed. Note, by emphasizing maximum throughput, other areas of performance may be affected. For example, the number of non-reads could increase.

If high throughput is critical, consider some or all of these settings:

- ◆ Operate in the Trigger Disabled mode. Operation of the trigger can require as much as 200 msec before decoding begins, slowing down throughput rate.
- ◆ Only enable those symbologies that you will be decoding.
- ◆ Eliminate all suffixes and prefixes.
- ◆ Minimize the number of redundant reads required before transmitting data.
- ◆ Transmit the decoded data at the highest baud rate, 19200 baud.
- ◆ Disable both the hardware and software buzzer functions.
- ◆ If you need a buzzer, use the hardware buzzer rather than the software buzzer.

Tips for Insuring Highest Data Integrity

There are several parameters that can enhance your confidence that the correct bar code data is transmitted. Note that by emphasizing the accuracy and security of the data other areas of the scanner operation may be affected, for example, you may not achieve the highest throughput.

If accuracy and data integrity are critical, consider some or all of these settings:

- ◆ Program the scanner to require a high number of redundant decodes prior to transmitting. For example, program the scanner to decode a bar code exactly the same way three consecutive times before transmitting the data. Then decoding the bar code the same way 2 out of 3 times or any 3 out of 4 times is not sufficient. It must obtain three consecutive and identical decodes.
- ◆ Utilize a predetermined, fixed-length of bar code. Program the scanner to only decode a bar code of that length. Bar codes of any other length will be ignored.
- ◆ The quality of the printed bar code must be excellent.
- ◆ Use a bar code symbology that contains an internal check digit and program the scanner to calculate that check digit for validity prior to transmitting.
- ◆ Do not use a symbology with poor internal verification, or subject to partial decodes, such as 2 of 5 or MSI/Plessey.
- ◆ Only enable those symbologies that you will be decoding.
- ◆ Transmit data at low baud rates to minimize communication errors.
- ◆ Enable the "Number of Characters Transmitted." The scanner will calculate and transmit a number indicating the total number of characters it is transmitting. Your host application program can compare this number with the actual number of characters received to verify that the correct amount of data is received.

Tips for Verifying the Presence of a Bar Code

If the scanner is operated in the "trigger enabled" mode and the trigger is activated, one of three conditions may occur:

A bar code is scanned and decoded	Decoded data is transmitted
A bar code is scanned but is not decoded (e.g., print quality was poor)	No data is transmitted
No bar code is present	No data is transmitted

In some applications, when no data is transmitted, it may be important to know why. Was there a bar code present that could not be decoded, or was no bar code present at all?

This requirement is common in applications such as automated blood analysis equipment. Test tubes containing blood samples from many different people are loaded into a rack for automatic analysis. The bar code on each tube ties that sample and the results back to a specific individual. If no bar code data is transmitted it is critical to understand the reason.

Your Opticon scanner, when operated in the Trigger Enabled mode, can be programmed to transmit an error message which indicates whether or not a bar code was present. The following table shows the message that will be transmitted for each condition.

Presence/Absence of bar code	Scanner Transmits
Bar code was present and correctly decoded	Decoded Data
No bar code was present	<STX> "?" <ETX>
Bar code was present but could not be decoded	<STX> ">" <ETX>

Section 4

Configuring the Scanner

Since the operation of the NFT-1125/2135 Series scanner is microprocessor controlled, it is possible to modify or program its operation to match your specific application. Changes in parameter settings can be changed or programmed in two ways. The first method employs specially designed programming bar codes which instruct the scanner to modify specific parameters. The second is to program the scanner by sending software instructions from the host PC to the scanner via the RS232 connection.

Programming Menus & Commands

Appendix A contains full instructions on how to configure the scanner as well as a complete listing of the computer commands and programming bar codes that are available to customize the scanner for your application.

Default Settings

When you modify or change any parameters, the scanner can be programmed to retain the new parameter in memory, even if power interrupted or terminated. If for any reason, however, the scanner is instructed to return all parameters to default settings (U4), it will return to the factory default settings shown in the following table.

Parameter	Factory Default Setting
RS 232 Communications	9600 baud 8 data bits 1 stop bit No parity No handshaking
Trigger Function	Disabled
Read Mode	Multiple Read Mode
No. of Redundant Decodes	Two
Bar Code Symbolologies	All Symbolologies enabled
UPC-A (13 digits)	Add leading zero Enable check digit
UPC-E (7 digits)	Add leading zero Enable check digit
Code 39	Do not calculate check digit Enable start/stop characters (*....*) Disable character length of one
Codabar	Enable start/stop characters as abcd/abcd Do not calculate check digit Disable character length of one
2 of 5	Do not calculate check digit Disable characters length of two
Fixed length of bar code only	Disabled
Software buzzer	Disabled
Positive bar codes only	Enabled
Error indications	Do not transmit error code
Print quality adjustment	Output from Low or High analog gain 1 MHz sampling rate

* This page left intentionally blank for repagination *

Section 5

Application Engineering Support

Technical Assistance and Support

Opticon is eager to help you integrate the NFT-1125/2135 Series scanner into your application. Our technical support staff is available to answer any questions or work with you to adapt the scanner to your specific situation. We are happy to answer your questions, assist in configuring and positioning the scanner for optimum operation, and help resolve any problems you encounter. Call us at 1 (800) 636-0090.

Common Causes of Poor Performance

The most common reasons for poor scanning performance are listed below.

- ◆ Bar codes are not positioned at the focal distance of the scanner.
- ◆ Specular reflection is impacting the scanner. Change the angle/position of the scanner or the bar code.
- ◆ Poor quality of printed bar codes. Bar codes are out of specification.
- ◆ The paper on which the bar code is printed is highly reflective or has a glossy finish causing light to be reflected into the scanner.
- ◆ The distance from the scanner to the bar code is not suitable for the density of the bar code. Or the density of the bar code beyond the scanners capability.
- ◆ If the red illuminating light of the scanner is not on, the scanner may be in the "Trigger Enable" mode expecting a trigger signal.

Modified and/or Customized Scanners

Opticon will work with you to modify or customize scanners to match your requirements. Scanners can be modified in terms of connectors type, pin-outs, cable length, default settings, custom software and many other areas.

Opticon will modify scanners in our factory and ship you scanners that match your specific requirements. By incorporating your modifications directly into production scanners, you receive scanners tailored for your need. They can be used immediately without the need for further modification or rework.

* This page left intentionally blank for repagination *

Appendix A

Programming Menus & Commands

Index

Introduction	18
1. Global Default & Scanner Configurations	20
2. Symbology Selection	21
3. Add/Activate Specific Bar Code Symbologies	22
4. Delete/Deactivate Specific Bar Code Symbologies	24
5. Options for UPC	25
6. Options for Code 39	26
7. Options for Codabar (NW-7)	27
8. Options for 2 of 5	29
9. Options for IATA	30
10. Fixing the Number of Digits	31
11. Creating a Prefix and/or Suffix	32
12. Setting Prefixes (Identifying the Symbology)	33
13. Setting Suffixes (Identifying the Symbology)	34
14. Direct Input of Numeric Characters	36
15. Direct Input of Alpha Characters	37
16. Direct Input of Control Characters	38
17. Enable Number of Characters/Digits Transmitted	38
18. Disable Number of Characters/Digits Transmitted	40
19. Communication Parameters	41
20. Handshaking	43
21. Buzzer Operation	44
22. Positive & Negative Bar Codes	45
23. Setting the Trigger Function	46
24. Selecting the Read Mode	47
25. Scanner Timeout (Trigger Enabled Mode only)	48
26. Redundant Decoding	49
27. Transmitting Error Indications (Trigger Enabled only)	50
28. Print Quality Adjustments	51

Introduction

Two different methods can be used to program parameters to configure the scanner:

- a) Programming via bar codes from a menu page; or
- b) Programming via computer commands

Programming via Bar Codes

Use the following steps to program parameters via the bar code menu:

- 1) Scan the "START/END Programming Menu" bar code. This instructs the scanner to enter the Programming Mode. The scanner will beep intermittently while in this mode.
- 2) Scan the bar code(s) associated with the desire parameter(s). The scanner will beep when the bar code is scanned. Note: Because of the close proximity of bar codes on the menu, approaching the desired bar codes from the side of the page will ensure that only the desired bar code is scanned.
- 3) Scan the "START/END Programming Menu" bar code. This instructs the scanner to exit the Programming Mode.

All the parameters that are programmed via bar codes are retained in non-volatile memory and stored permanently (even if the scanner is powered down) or until they are changed.

Programming via Computer Commands

Various parameters can be programmed by sending software commands or keyboard strokes from the host computer to the scanner in the following format:

<ESC> Computer Command <CR>

Note: Only upper case letters are recognized, e.g. "AB", not "ab." Each command typically consists of two characters. Downloading of software commands cannot be "grouped" together. Each command must be preceded by <ESC> (Escape) and followed by <CR> (Carriage Return).

Note: Where computer commands appear in parenthesis, bar code commands must be used to program the scanner.

Parameters modified by downloading software commands remain in effect only while power is supplied to the scanner. If power is interrupted or terminated, the parameters return to their original settings. However, parameters programmed by downloaded commands can be stored permanently by transmitting a "Z2" computer command to the scanner after the commands are sent. This instructs the scanner to store the changed parameter(s) in non-volatile memory. The scanner will then retain the setting(s) permanently or until changed.

It is not necessary to send a "Z2" command after each parameter is changed. One "Z2" command will save all changes.

Example: If programming the scanner to decode only Code 128 bar code were desired, the following command would be used:

<ESC> A6 <CR>

The scanner will now only decode Code 128 bar codes and will ignore other types of bar code. The scanner will retain this setting until power is interrupted or terminated, and will then revert to its original setting. If retaining this setting permanently is desired, the following command would be used:

**<ESC> A6 <CR>
<ESC> Z2 <CR>**

The "Z2" command stores the modified parameter in non-volatile memory. The scanner will not retain this setting even after power is terminated.

Factory default settings are indicated throughout the following menus by the pointing hand icon ().

1. Global Default & Scanner Configurations

Computer Command	Function /Description	Bar Code Command
(Z7)	START/END Programming Menu	
U4	Return all parameters to Default Settings	
Z2	Save all values set by command (not lost upon power off)	
Z3	Display software settings and version number	
1R	Clear all prefixes; suffix CR	
1S	Clear all prefixes; suffix LF	
1T	Clear all prefixes; suffix CR+LF	
1U	All prefixes STX; suffix ETX	
1V	All prefixes STX; suffix CR+ETX	
1W	All prefixes STX; suffix LF+ETX	
1X	All prefixes STX; suffix CR+LF+ETX	
1Y	Clear all prefixes	
1Z	Clear all suffixes	
Z4	Display prefix/suffix value length (expressed in hexadecimal format)	

2. Symbology Selection

Computer Command	Function /Description	Bar Code Command
(Z7)	START/END Programming Menu	
A0	Enable all bar code symbologies except IATA	
A1	Only WPC (including Addon)	
A2	Only Code 39	
A3	Only Codabar (NW-7)	
A4	Only 2 of 5 (Industrial or Interleaved)	
A5	Only Code 93	
A6	Only Code 128	
A7	Only MSI/Plessey	
A8	Only IATA	
J1	Only UPC (A/E)	
J2	Only UPC (A/E)+2	
J3	Only UPC (A/E)+5	
J4	Only EAN	

CONTINUED ON NEXT PAGE...

2. Symbology Selection (continued)

Computer Command	Function /Description	Bar Code Command
(Z7)	START/END Programming Menu	
J5	Only EAN +2	
J6	Only EAN +5	
J7	Only Industrial 2 of 5	
J8	Only Interleaved 2 of 5	











3. Add/Activate Specific Bar Code Symbologies

Computer Command	Function /Description	Bar Code Command
(Z7)	START/END Programming Menu	
B1	Enable all WPC (including Addon)	
B2	Enable Code 39	
B3	Enable Codabar (NW-7)	
B4	Enable 2 of 5 (Industrial/Interleaved)	
B5	Enable Code 93 (Factory Set)	
B6	Enable Code 128 (Factory Set)	
B7	Enable MSI/Plessey	

















CONTINUED ON NEXT PAGE...

3. Add/Activate Specific Bar Code Symbolgies (continued)

Computer Command	Function /Description	Bar Code Command
(Z7)	START/END Programming Menu	
B8	Enable IATA	
R1	Enable UPC (A/E)	
R2	Enable UPC (A/E) +2	
R3	Enable UPC (A/E) +5	
R4	Enable EAN (13/8)	
R5	Enable EAN (13/8) +2	
R6	Enable EAN (13/8) +5	
R7	Enable Industrial 2 of 5	
R8	Enable Interleaved 2 of 5	

4. Delete/Deactivate Specific Bar Code Symbologies

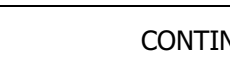
Computer Command	Function /Description	Bar Code Command
(Z7)	START/END Programming Menu	
4A	Disable all WPC (including Addon)	
4B	Disable UPC (A/E)	
4C	Disable UPC (A/E) +2	
4D	Disable UPC (A/E) +5	
4E	Disable EAN (13/8)	
4F	Disable EAN (13/8) +2	
4G	Disable EAN (13/8) +5	
4H	Disable Code 39	
4I	Disable Codabar (NW-7)	
4J	Disable 2 of 5 (Industrial/Interleaved)	
4K	Disable Industrial 2 of 5	
4L	Disable Interleaved 2 of 5	
4M	Disable Code 93	
4N	Disable Code 128	

CONTINUED ON NEXT PAGE...

4. Delete/Deactivate Specific Bar Code Symbologies (continued)

Computer Command	Function /Description	Bar Code Command
(Z7)	START/END Programming Menu	
40	Disable MSI/Plessey	
4P	Disable IATA	

4. Options for UPC

Computer Command	Function /Description	Bar Code Command
(Z7)	START/END Programming Menu	
E2	UPC-A (13 Digits) Add leading zero; Enable check digit	
E3	UPC-A (12 Digits) Do not add leading zero; Enable check digit	
E4	UPC-A (12 Digits) Add leading zero; Disable check digit	
E5	UPC-A (11 Digits) Do not add leading zero; Disable check digit	
E6	UPC-E (8 Digits) Add leading zero; Enable check digit	
E7	UPC-E (7 Digits) Do not add leading zero; Enable check digit	
E8	UPC-E (7 Digits) Add leading zero; Disable check digit	
E9	UPC-A (7 Digits) Do not add leading zero; Disable check digit	



6. Options for Code 39

Computer Command	Function /Description	Bar Code Command
(Z7)	START/END Programming Menu	
H4	Enable 1 character (3 characters including start/stop characters)	
H2	Disable 1 character Code 39 and Codabar (NW-7); Disable 2 characters 2 of 5	
C0	Disable check digit calculation	
C1	Enable check digit calculation	
C2	Transmit check digit	
C3	Do not transmit check digit	
D0	Do not transmit start/stop characters (*.....*)	
D1	Transmit start/stop characters (*.....*)	





- ◆ 43 Data digits are available: 0 to 9, A to Z (caps only) plus . - \$ / + % and space. If a check digit is present, it will appear as part of the data.
- ◆ If the scanner is programmed to calculate the check digit, and the bar code is not printed with a check digit, the bar code will not read.
- ◆ Another option available for Code 39 is to enable the reading of a single character bar code. See the section on Fixing the Digit for this option.

7. Options for Codabar (NW-7)

Computer Command	Function /Description	Bar Code Command
(Z7)	START/END Programming Menu	
H5	Enable 1 character (3 characters including start/stop characters)	
H2	Disable 1 character Code 39 and Codabar (NW-7); Disable 2 characters 2 of 5	
F0	Do not transmit start/stop characters	
F1	Transmit start/stop characters as ABCD/TN*E	
F2	Transmit start/stop characters as abcd/tn*e	
F3	Transmit start/stop characters as ABCD/ABCD	
F4	Transmit start/stop characters as abcd/abcd	
F5	Transmit check digit	
F6	Do not transmit check digit	
F7	Do not calculate check digit	
F8	Calculate check digit (Modulo 10)	
F9	Calculate check digit (Modulo 16) (AIM specifications)	
FB	Calculate check digit (Modulo 7)	

CONTINUED ON NEXT PAGE...

7. Options for Codabar (NW-7) (continued)

Computer Command	Function /Description	Bar Code Command
(Z7)	START/END Programming Menu	
G6	Read normal Codabar	
G7	Read Okitakasaki Codabar	

Codabar Format

Start Character	1 to 42 data digits	Check digit	Stop Character
A T
a t
A A
A a

- ◆ Codabar has four (4) different start/stop character schemes as shown above. The check digit is optional and, if present, would be the last character.
- ◆ If the scanner is programmed to calculate the check digit and the bar code is not printed with a check digit, the bar code will not be read.

8. Options for 2 of 5

Computer Command	Function /Description	Bar Code Command
(Z7)	START/END Programming Menu	
G0	Do not calculate check digit	
G1	Calculate check digit	
G2	Transmit Check digit	
G3	Do not transmit check digit	
H6	Enable 2 characters	
H2	Disable 1 character Code 39 and Codabar (NW-7); Disable 2 characters 2 of 5	



2 of 5 (Standard and Interleaved) Format

1 to 44 data digits	CD
numeric only (0 to 9)	Check Digit

Opticon strongly recommends that the "Fixing the Number of Digits" feature on the next page be employed whenever 2 of 5 bar codes are used.

9. Options for IATA

Computer Command	Function /Description	Bar Code Command
(Z7)	START/END Programming Menu	
D2	Do not calculate check digit	
D3	Calculate check digit (CPN + Form + Serial)	
D4	Calculate check digit (Form + Serial)	
D5	Calculate check digit (All data)	
D6	Transmit check digit	
D7	Do not transmit check digit	

The IATA code is a variable length symbology with an optional check digit and non-printable start/stop characters. The following characters are supported: Digits 0 up to 9.

The checksum is calculated as the modulo seven of the data string. IATA is an acronym for International Air Transport Association.

String format	CPN	AC	FC	SN	CD
Meaning of Acronym	Coupon	Airline Code	Form Code	Serial Number	Check Digit
Number of digits (15 total)	1	3	2	8	1

- ◆ Enable check digit check
- ◆ Selection of the check digit calculation
- ◆ Disable transmission of the check digit

Check digit calculation: If the check digit calculation is required, then the appropriate calculation method must be selected.

10. Fixing the Number of Digits



Computer Command	Function /Description	Bar Code Command
(Z7)	START/END Programming Menu	
(H0)	Disable fixation	
(H1)	Enable fixation	
H2	Disable 1 character Code 39 and Codabar (NW-7); Disable 2 characters 2 of 5	
H3	Enable 1 character Code 39 and Codabar (NW-7); Enable 2 characters 2 of 5	

To avoid truncation errors, the scanner can be programmed to only decode bar codes of one specific length, i.e., containing a specific number of digits. It is also possible to program the scanner to only decode bar codes of either of two specific *lengths.

<p>To fix one (1) length (or number of digits) of bar code:</p> <ol style="list-style-type: none"> 1. Scan "START" to enter the programming mode 2. Scan "Enable fixation" bar code 3. Scan a sample bar code of the desired length 4. Repeat Step #3, re-scanning the sample bar code 5. Scan "STOP" to exit the programming 	<p>To fix two (2) different lengths of bar codes:</p> <ol style="list-style-type: none"> 1. Scan "START" to enter the programming mode 2. Scan "Enable fixation" bar code 3. Scan a sample bar code of the desired length #1 4. Scan a sample bar code of the desired length #2 5. Scan "STOP" to exit the programming mode
--	--

"Fixing the Number of Digits" can only be applied to Code 39, Codabar, 2 or 5 and MSI/Plessey (UPC, Code 93 and Code 128 are not affected).

11. Creating a Prefix and/or Suffix

Computer Command	Function /Description	Bar Code Command
(Z7)	START/END Programming Menu	
1Y	Clear all Prefixes	
Z4	Display Prefix/Suffix value and length (expressed in hexadecimal format)	

The scanner can be programmed to transmit a prefix and/or suffix with the decoded data. A Prefix (or a Suffix) is composed of up to 4 characters. The following steps are used to establish a Prefix that will be transmitted with the bar code data:















1. Scan Start
2. Scan the bar code representing the symbology to which you wish to add a Prefix
3. Scan the character(s) that will comprise the Prefix. Up to four numeric, alpha or control character(s) may be used.
4. Scan "STOP" to exit the Programming Mode.

The same steps are used to establish a Suffix.

Example: To add the alpha character "A" as a Prefix and "B" as a Suffix to UPC-A bar code data:







1. Scan "START/END Programming Mode"
2. Scan N1, representing a Prefix for UPC-A
3. Scan 0A, representing the alpha character "A"
4. Scan N6, representing a Suffix for UPC-A
5. Scan 0B, representing the alpha character "B"
6. Scan "START/END Programming Mode"

12. Setting Prefixes (Identifying the Symbology)







Computer Command	Function /Description	Bar Code Command
(Z7)	START/END Programming Menu	
1Y	Clear all Prefixes	
N1	UPC-A	
M0	UPC-A +2 or +5	
N2	UPC-E	
M1	UPC-E +2 or +5	
N3	EAN-13	
M2	EAN -13 +2 or +5	
N4	EAN-8	
M3	EAN-8 +2 or +5	
M4	Code 39	
M5	Codabar (NW-7)	
M6	Industrial 2 of 5	
M7	Interleaved 2 of 5	

CONTINUED ON NEXT PAGE...

12. Setting Prefixes (Identifying the Symbology) (continued)













Computer Command	Function /Description	Bar Code Command
(Z7)	START/END Programming Menu	
M8	Code 93	
M9	Code 128	
D8	IATA	
N0	MSI/Plessey	
Z4	Display Prefix/Suffix value and length (expressed in hexadecimal format)	

13. Setting Suffixes (Identifying the Symbology)

Computer Command	Function /Description	Bar Code Command
(Z7)	START/END Programming Menu	
1Z	Clear all Suffixes	
N6	UPC-A	
O0	UPC-A +2 or +5	
N7	UPC-E	
O1	UPC-E +2 or +5	
N8	EAN-13	











CONTINUED ON NEXT PAGE...

13. Setting Suffixes (Identifying the Symbology) (continued)





























Computer Command	Function /Description	Bar Code Command
(Z7)	START/END Programming Menu	
O2	EAN-13 +2 or +5	
N9	EAN-8	
O3	EAN-8 +2 or +5	
O4	Code 39	
O5	Codabar (NW-7)	
O6	Industrial 2 of 5	
O7	Interleaved 2 of 5	
O8	Code 93	
O9	Code 128	
D9	IATA	
N5	MSI/Plessey	
Z4	Display Prefix/Suffix value and length (expressed in hexadecimal format)	

NOTE: The global default, also clears all suffixes.





15. Direct Input of Numeric Characters

Computer Command	Function /Description	Bar Code Command
(Z7)	START/END Programming Menu	
Q0	0	
Q1	1	
Q2	2	
Q3	3	
Q4	4	
Q5	5	
Q6	6	
Q7	7	
Q8	8	
Q9	9	

15. Direct Input of Alpha Characters







(Z7)	START Program Menu		0N	N	
0A	A		0O	O	
0B	B		0P	P	
0C	C		0Q	Q	
0D	D		0R	R	
0E	E		0S	S	
0F	F		0T	T	
0G	G		0U	U	
0H	H		0V	V	
0I	I		0W	W	
0J	J		0X	X	
0K	K		0Y	Y	
0L	L		0Z	Z	
0M	M		(Z7)	END Program Menu	

16. Direct Input of Control Characters

Computer Command	Function /Description	Bar Code Command
(Z7)	START/END Programming Menu	
1A	STX	
1B	ETX	
1C	CR	
1D	LF	













17. Enable Number of Characters/Digits Transmitted

This feature instructs the scanner to calculate and transmit a number indicating the total number of characters that are being transmitted to the host. This feature allows the host to verify that the correct amount of data was received.

Computer Command	Function /Description	Bar Code Command
(Z7)	START/END Programming Menu	
3A	UPC-A	
3B	UPC-A +2 or +5	
3C	UPC-E	
3D	UPC-E +2 or +5	
3E	EAN-13	

CONTINUED ON NEXT PAGE...

17. Enable Number of Characters/Digits Transmitted (continued)





(Z7)	START/END Programming Menu	
3F	EAN-13 +2 or +5	
3G	EAN-8	
3H	EAN-8 +2 or +5	
3I	Code 39	
3J	Codabar (NW-7)	
3K	Industrial 2 of 5	
3L	Interleaved 2 of 5	
3M	Code 93	
3N	Code 128	
3O	MSI/Plessey	
3P	IATA	
3Z	Transmit data length (all symbologies)	

18. Disable Number of Characters/Digits Transmitted







Computer Command	Function /Description	Bar Code Command
(Z7)	START/END Programming Menu	
2A	UPC-A	
2B	UPC-A +2 or +5	
2C	UPC-E	
2D	UPC-E +2 or +5	
2E	EAN-13	
2F	EAN-13 +2 or +5	
2G	EAN-8	
2H	EAN-8 +2 or +5	
2I	Code 39	
2J	Codabar (NW-7)	
2K	Industrial 2 of 5	
2L	Interleaved 2 of 5	
2M	Code 93	

CONTINUED ON NEXT PAGE...

18. Disable Number of Characters/Digits Transmitted (continued)

Computer Command	Function /Description	Bar Code Command
(Z7)	START/END Programming Menu	
2N	Code 128	
2O	MSI/Plessey	
2P	IATA	
2Z	Do not transmit data length (all symbologies)	

19. Communication Parameters

Computer Command	Function /Description	Bar Code Command
(Z7)	START/END Programming Menu	
	150 Baud	
	300 Baud *	
	600 Baud *	
	1,200 Baud *	
	2,400 Baud *	
	4,800 Baud *	

* Use Z2 Command after computer command to store settings in memory prior to power off.















CONTINUED ON NEXT PAGE...

19. Communication Parameters (continued)

Computer Command	Function /Description	Bar Code Command
(Z7)	START/END Programming Menu	
(K6)	9,600 Baud	
(K7)	19,200 Baud *	
(L0)	7 Data Bits *	
(L1)	8 Data bits *	
(L2)	Parity = None	
(L3)	Parity = Even *	
(L4)	Parity = Odd *	
(L5)	1 Stop Bit *	
(L6)	2 Stop Bits *	

* Use Z2 Command after computer command to store settings in memory prior to power off.

20. Handshaking

Computer Command	Function /Description	Bar Code Command
(Z7)	START/END Programming Menu	
(I0)	Wait for CTS from terminal = Unlimited	
(I1)	Wait for CTS from terminal = 100 mS	
(I2)	Wait for CTS from terminal = 200 mS	
(I3)	Wait for CTS from terminal = 400 mS	
(I4)	ACK/NAK Delay Time Unlimited	
(I5)	ACK/NAK Delay Time = 100 mS	
(I6)	ACK/NAK Delay Time = 500 mS	
(I7)	ACK/NAK Delay Time = 1000 mS	
(P0)	No Handshaking *	
(P1)	Busy/Ready *	
(P2)	Modem *	
(P3)	ACK/NAK *	
(P4)	ACK or No response NAK *	
(P5)	No ACK/NAK *	



* Use Z2 Computer Command to store in memory prior to power off.

21. Buzzer Operation

Computer Command	Function /Description	Bar Code Command
(Z7)	START/END Programming Menu	
T0	Volume = Maximum	
T1	Volume = Upper Mid-range	
T2	Volume = Lower Mid-range	
T3	Volume = Minimum	
T4	Disable hardware buzzer	
T5	Enable hardware buzzer	
V5	Ring software buzzer once at 3kHz for 200 Ms	Use Computer Command *
V6	Ring software buzzer once at 3kHz, 2kHz interval for 200 mS	Use Computer Command *
V7	Ring software buzzer once at 2kHz, 3kHz interval for 200 mS	Use Computer Command *
W0	Disable software buzzer	
W1	Enable software buzzer at 3kHz	
W2	Enable software buzzer at 3kHz with 2.5kHz interval	

* These commands are useful in verifying that proper communication exists between the scanner and the host. They can be invoked only via computer commands.

CONTINUED ON NEXT PAGE...

21. Buzzer Operation (continued)

Computer Command	Function /Description	Bar Code Command
(Z7)	START/END Programming Menu	
W3	Enable software buzzer at 3kHz with 4kHz interval	
W4	Software buzzer duration 0.10 sec	
W5	Software buzzer duration 0.20 sec	
W6	Software buzzer duration 0.40 sec	
W7	Software buzzer duration 0.05 sec	



22. Positive & Negative Bar Codes

Computer Command	Function /Description	Bar Code Command
(Z7)	START/END Programming Menu	
V2	Positive bar code only (black bars/white spaces)	
V4	Both positive & negative bar code	

23. Setting the Trigger Function





Computer Command	Function /Description	Bar Code Command
(Z7)	START/END Programming Menu	
S7	Disable the trigger function / Red scanning light is ON continuously	
S8	Enable the trigger function /Red scanning light is OFF until trigger is activated or "pulled"	
Z	Activate the trigger; turns on the red scanning light	Use Computer Command



The Trigger function is disabled in the default setting. This means that the red scanning light is "ON" continuously and the scanner is always ready to read. For some applications, you may wish to activate the scanner only at a specific time. This can be done by enabling the Trigger function. Once in the "Trigger Enabled" mode, the red scanning light is OFF until the trigger is activated or "pulled." Either a hardware trigger or a software trigger pulse may be used to activate the scanner.

The hardware trigger is actuated by pulling Pin #16 (on the standard DB25 female connector) LOW. The software trigger is actuated by downloading and <ESC> Z <CR> computer command from the host. (See Scanner Timeout to establish the length of time the scanning light remains ON after the trigger is activated.)

24. Selecting the Read Mode

Computer Command	Function /Description	Bar Code Command
(Z7)	START/END Programming Menu	
S0	Single Read Mode (Trigger enabled mode only)	
S1	Multiple Read Mode	
S2	Continuous Read Mode	



The operation of the scanner in the various read modes is described in the table below. The "Continuous Read" mode is helpful in positioning the scanner for optimum reading. In "Continuous Read," the scanner's buzzer functions like a Geiger counter, sounding the most active at the position achieving the greatest number of good reads.

Mode	Trigger Function Enabled	Trigger Function Disabled
Multiple Read	After receiving a trigger pulse, scanner will read multiple, different bar codes in succession until it times out.	Scanner will read different bar codes in succession if they are presented to the read window.
	Scanner will not read the same bar code twice if they are consecutive.	Scanner will not read the same bar code twice if they are consecutive.
Continuous Read	Scanner will read the same bar code continuously after receiving a trigger pulse until scanner times out.	Scanner will read the same bar code continuously.
Single Read	Scanner will read only one bar code after receiving a trigger pulse.	Same as Multiple Read mode, above.





25. Scanner Timeout (Trigger Enabled Mode only)

These commands, which are only applicable in the Trigger Enabled mode, establish the time-out period after the trigger pulse is received. The Time-out period is the same whether the scanner is operating in Single, Multiple or Continuous Read mode.

Computer Command	Function /Description	Bar Code Command
(Z7)	START/END Programming Menu	
Y0	Trigger remains ON as long as trigger is pulled (hardware trigger only)	
Y1	1 Second after triggering	
Y2	2 Seconds after triggering	
Y3	3 Seconds after triggering	
Y4	4 Seconds after triggering	
Y5	6 Seconds after triggering	
Y6	8 Seconds after triggering	
Y7	10 Seconds after triggering	

26. Redundant Decoding

The Number of Redundant Decodes determines how many times the scanner must decode a bar code and obtain the same value before it will transmit the data. For example, if the redundancy is set at three times, the scanner will not transmit data until it has decoded the bar code and obtained the same values three times in succession. If it obtains the same value twice in a row, but a different value on the third read attempt, it will not transmit. If it gets the same value three out of four times, it will not transmit. It must receive three consecutive, identical reads.

Computer Command	Function /Description	Bar Code Command
(Z7)	START/END Programming Menu	
X0	Read bar code once	
X1	Read bar code twice	
X2	Read bar code three times	
X3	Read bar code four times	











27. Transmitting Error Indications (Trigger Enabled only)

Computer Command	Function /Description	Bar Code Command
(Z7)	START/END Programming Menu	
5A	Wait 30 mS after trigger pulse before sending error code	
5B	Wait 80 mS after trigger pulse before sending error code	
5C	Wait 130 mS after trigger pulse before sending error code	
5D	Wait 220 mS after trigger pulse before sending error code	
5E	Do not transmit error code	
5F	Transmit "BR"<CR> for bad read or no read	
5G	Transmit <STX>">"<ETX> for bad read; <STX>"?"<ETX> for no read	
5H	Transmit ">" <CR> for bad read Transmit "?" <CR> for no read	
5I	Transmit "CAN"<CR> for bad read or no read	
5J	Transmit <STX>"CAN"<ETX> for bad read or no read	
5K	Transmit <STX><CAN><CR> <LF> for bad read or no read	
5L	Transmit <STX><CAN><CR> for bad read or no read	
5M	Transmit "BR"<CR><LF> for bad read or no read	



28. Print Quality Adjustments

Computer Command	Function /Description	Bar Code Command
(Z7)	START/END Programming Menu	
X4	For lower density, poor print quality bar code, e.g., dot matrix with voids (low analog gain)	
X5	For high density, good print quality bar code without voids (high analog gain)	
X6	Output data obtained from Low <u>or</u> High analog gain	
X7	Output data obtained from Low <u>and</u> High analog gain	
G5	Enables alternate decode algorithms. May improve performance on certain I 2 of 5, Code 39, Codabar or MSI/Plessey bar codes	
G4	Disables alternate decoding algorithms	
SB	1 mHz sampling rate for average bar codes	
SC	For high density bar code (activates 8 mHz sampling rate)	



* This page left intentionally blank for repagination *

Appendix B Dimensional Drawings

1126/2126 Side View

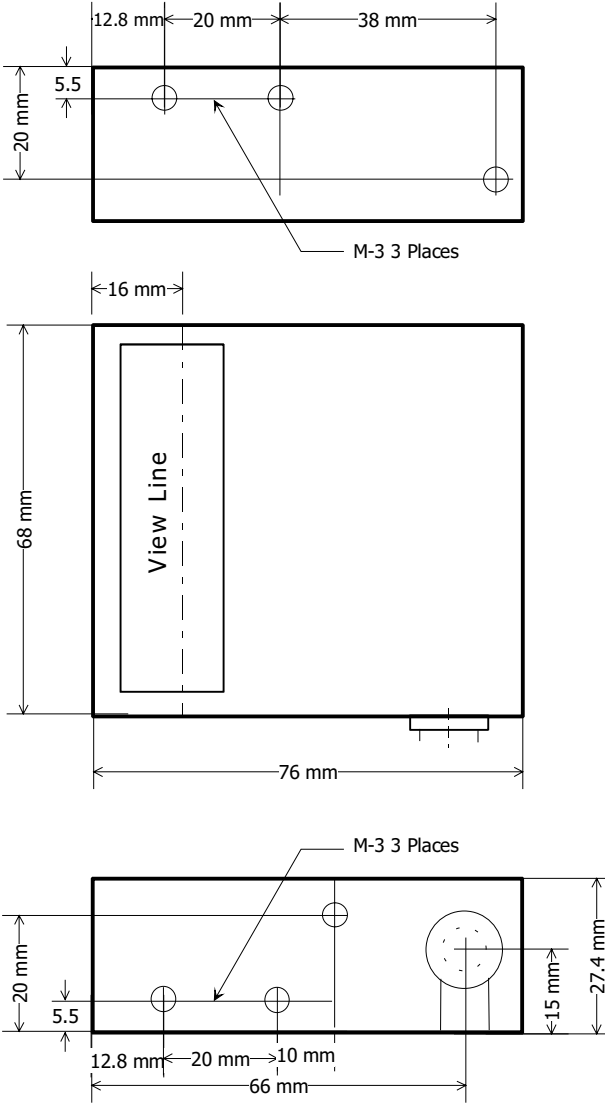

All dimensions in millimeters

1127/2127 Front View

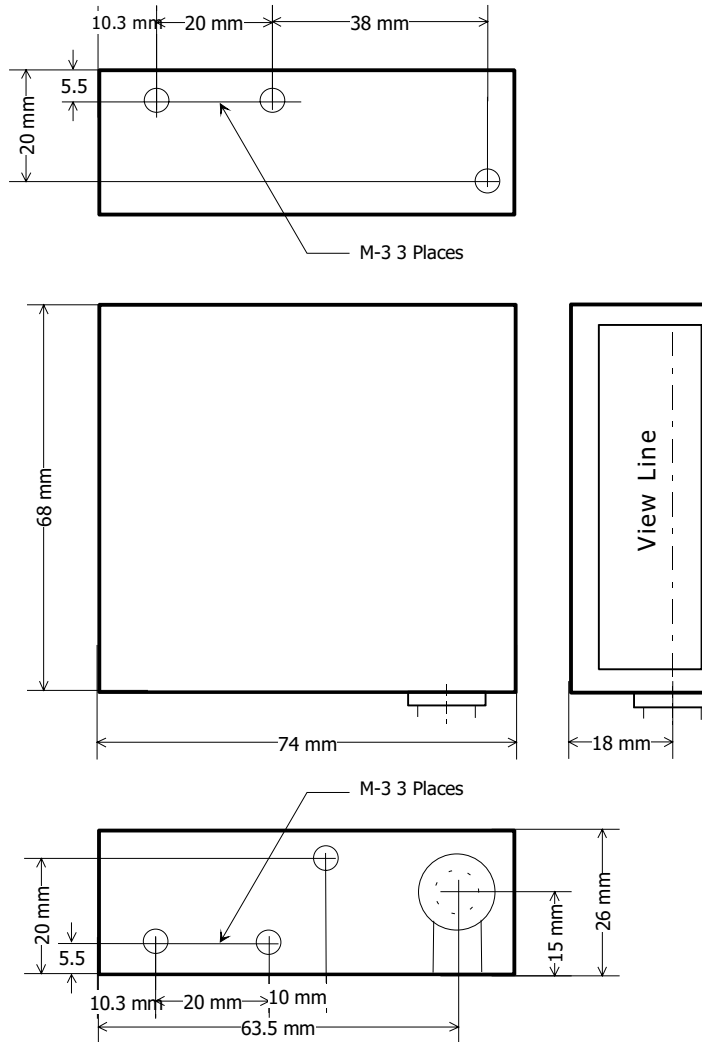

All dimensions in millimeters

Appendix C Optical Performance Charts

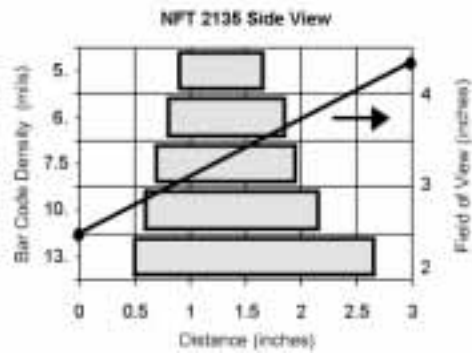
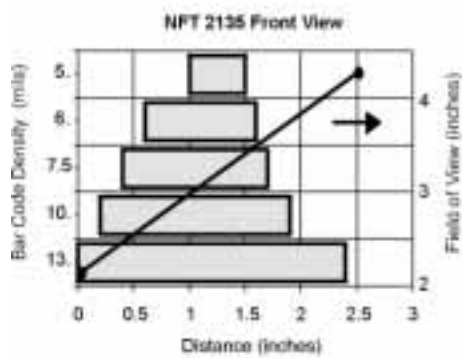
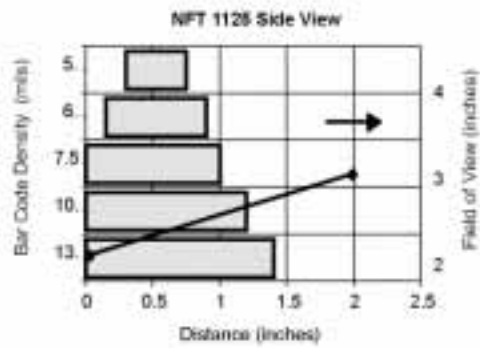
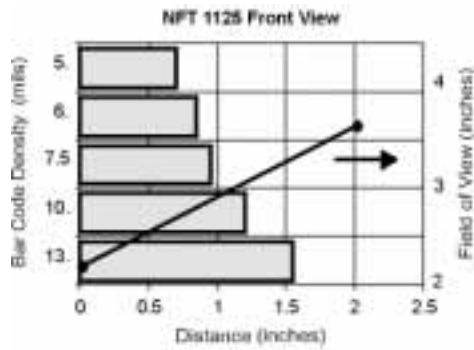

Free Manuals Download Website

<http://myh66.com>

<http://usermanuals.us>

<http://www.somanuals.com>

<http://www.4manuals.cc>

<http://www.manual-lib.com>

<http://www.404manual.com>

<http://www.luxmanual.com>

<http://aubethermostatmanual.com>

Golf course search by state

<http://golfingnear.com>

Email search by domain

<http://emailbydomain.com>

Auto manuals search

<http://auto.somanuals.com>

TV manuals search

<http://tv.somanuals.com>