

Opticon, Inc. | 8 Olympic Drive | Orangeburg, NY 10962  
TOLL FREE: 800-636-0090 | 845-365-0090  
WWW.OPTICONUSA.COM

**OPTICON**  
always scanning for new ID's

## *NFT 2100*

# Miniature High Speed CCD Fixed Position Barcode Scanner



**User's Guide**  
Manual No. 25-ULNFT2100-01

# Contents

<b>Section 1 Introduction and Getting Started</b>	1
Product Overview	1
Quick Start-Up Procedure	1
<b>Section 2 Technical Specifications</b>	3
Physical Specifications	3
Symbolologies Supported	3
Optical Specification	3
Pitch	4
Skew	4
Tilt (rotation)	5
Curvature	5
Electrical Specification	6
RS232 Communications Specifications	6
Connector Pin Outs	7
Environmental Specifications	7
Ordering Information	7
<b>Section 3 Positioning the Scanner</b>	8
Achieving Optimum Performance	8
Measuring Scanner Performance	10
Application Notes	10
Tips for Achieving High Throughput	10
Tips for Insuring Highest Data Integrity	10
Tips for Verifying the Presence of a Bar Code	11
<b>Section 4 Configuring the Scanner</b>	12
Configuring the Scanner	12
Programming Menus & Commands	12
Default Setting	12
<b>Section 5 Application Engineering Support</b>	13
Technical Assistance and Support	13
Common Causes of Poor Performance	13
Modified and/or Customized Scanners	13
<b>Section 6 Scanner Labeling</b>	14
<b>Section 7 Scanner Servicing and Maintenance</b>	14
<b>Appendix A How to Program the Scanner</b>	16
<b>Appendix B Computer Programming Commands</b>	18
<b>Appendix C Bar Code Programming Commands</b>	23
<b>Appendix D Dimensional Drawings</b>	64
<b>Appendix E Optical Performance (Typical)</b>	65
<b>Appendix F Placement Drawings</b>	66
<b>Appendix G Placement Drawings for Test Tubes</b>	67

# Organization of this Manual

This manual provides the necessary instructions for installing and using the Opticon NFT 2100 Fixed Position Scanner. The manual is organized as follows:

- Section 1 Introduction and Getting Started**  
Describes the general operation of the NFT 2100 scanner. Also provides a Quick Start-Up Procedure that allows you to begin using the scanner immediately.
  - Section 2 Technical Specifications**  
Provides complete specifications, including mechanical details, optical performance, RS232 communications and other technical data.
  - Section 3 Positioning the Scanner for Optimum Performance**  
Provides detailed instructions and tips for mounting and positioning the scanning to obtain the best scanning performance. Application Notes describe guidelines for maximizing specific characteristics.
  - Section 4 Configuring the Scanner**  
Describes how various parameters can be programmed to customize the scanner for your specific application.
  - Section 5 Application Engineering Support**  
Discusses the most common questions and concerns when adapting the NFT 2100 and scanner in your application.
  - Section 6 Scanner Compliance**  
Discusses the various labels on the product required by CE.
  - Section 7 Scanner Servicing and Maintenance**  
Discusses maintenance and cleaning procedures.
- Appendix A How to Program the Scanner
  - Appendix B Computer Programming Commands
  - Appendix C Bar Code Programming Commands
  - Appendix D Dimensional Drawing
  - Appendix E Optical Performance

## Section 1

### Introduction and Getting Started

#### Product Overview

The NFT 2100 Fixed Position Scanner is a miniature, 200 scan per second, CCD barcode reader designed to be easily incorporated into host equipment. The small physical size makes the scanner easy to integrate into any hardware design. Durability and reliability are assured.

Advanced microprocessor technology coupled with Opticon's proven decoding algorithms result in high speed operation with superior accuracy. The scanner is fully programmable allowing the user to customize parameters including changing communication settings, selecting symbologies, adding prefixes and appending suffixes. Programmable settings can be downloaded from the host CPU or computer directly to the scanner.

The scanner is encased in a compact, rugged, yet lightweight steel enclosure. The compact size permits installation in the tightest areas allowing great flexibility in mounting and positioning the scanner for optimum performance.

#### Quick Start-Up Procedure

This section is for those who wish to start using the scanner before reading the complete manual. In only a few steps the scanner will be operable.

Turn off the power to your PC and connect the scanner to a RS232 communications port. Note: You must provide +5 Volt DC power to the scanner. If you are using our standard LHA2107RR1S-054, you can utilize power supply, P/N 32-00907-01, by plugging its connector directly into the power jack on the DB9 connector. If the power supply is obtained from another source verify that it is identified with the **CE** mark. Turn on the power to the PC.

- 1) If you are operating in a **Microsoft Windows 95/98/ 2000/ XP** environment, you can set the communication parameters using Hyper Terminal as follows:
  - ◆ Open Hyper Terminal. This can be done from Start→Programs→Accessories/Communications
  - ◆ Select Hypertrm.exe to create a New Connection
  - ◆ In the Connection Description dialog screen enter a name for the new file, like "Opticon". If desired, select an Icon. Click OK
  - ◆ In the *Connect To (Phone Number)* dialog screen, in the box entitled: *Connect using.* select the communication port, for example, "Direct to Com 1" Click OK
  - ◆ In the *Com 1 Properties* screen, enter the appropriate Port Settings: Bits per second = 9600, Data bits = 8, Parity = None, Stop Character = 1, Handshaking = None, Click OK
  - ◆ The hyper-terminal folder you just created will open. From the File pull-down menu, select *Properties* then click on the *Setting* Tab
  - ◆ In the *Properties Settings* dialog screen, Select *Terminal keys* for the Function, arrow and control key; then Select *ANSI* for Emulation; the *Back scroll* buffer line can remain at the default 500

- 
- ◆ Click on the ASCII Setup button. In the ASCII Setup Sending screen, select Line ends with line feeds and Echo typed locally so that any keyboard commands you input will appear on your screen. In the ASCII Setup Receiving screen, select Append line feeds to incoming line ends and Wrap lines that exceed terminal width. Click OK. This returns you to the Properties Setting. Click OK
- 2) Your PC and the scanner should now communicate. To verify that the scanner and the PC are communicating properly, send the following command from your PC keyboard which will request software settings to be displayed.  
Send the command in four keystrokes: <Esc> Z3 <Enter>  
Note: Be sure to use capital letters, e.g. "Z3", not "z3".  
A series of software setting should be displayed, indicating that good communications have been established
  - 3) A red LED light should be visible. If it is not visible, the scanner may be in a mode that requires a "Trigger" Command from the PC to activate it. You can exit that mode by sending the following command from your PC keyboard:  
<Esc> S7 <Enter>
  - 4) The "Trigger" mode will now be deactivated and the red LED light will be continuously illuminated.

This Quick Start-Up procedure will get you started. However, to best understand the full capabilities of this scanner, you should read the complete manual.

Section 2

Technical Specifications

**Physical Specifications**

Case Material	Steel (Black)
Dimensions	2.16 x 1.85 x 0.78 in (WxDxH) (55 x 47 x 20 mm)
Weight	3.5 oz (100 grams) without cable
Cable Length	6.5 Feet (2000 mm)
Connector	9-pin, DB9F-SC connector with power Jack
Mounting	4 threaded (M-3) mounting holes, 2 on each side

**Symbologies Supported**

- ◆ Codabar (NW-7), Codabar ABC, & Codabar CX
- ◆ Code 39
- ◆ Code 93
- ◆ Code 128
- ◆ Industrial 2 of 5 / Interleaved 2 of 5 / Matrix 2 of 5
- ◆ MSI / Plessey, UK / Plessey
- ◆ WPC (UPC / EAN / JAN)
- ◆ IATA
- ◆ Telepen
- ◆ TriOptic
- ◆ SCode

**Optical Specifications**

Scan Rate	200 scans per second $\pm 10\%$
Light source	660 nm, visible red LED
Light receiver	CCD Linear image sensor with 2048 pixels
Focal Distance *	1.4" (35.4 mm)
Field size at focal distance.	3.1" (80 mm)
Narrow Bar Resolution	6 mil (0.15mm) at 0.9 PCS
Minimum PCS	0.45 (min. background reflectance of 70%)

Reading Distances NFT 2100. See Appendix E)

\* measured from front edge of scanner.

**Skew**

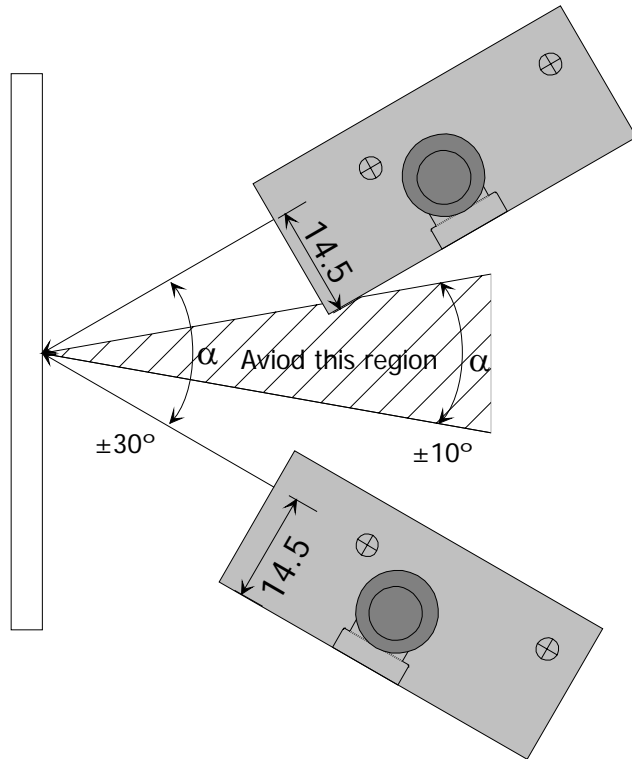

**Specified operation ( $\alpha$ ) at  $\pm 30^\circ$  or less. (Recommended at + or -  $13^\circ$ )**  
Avoid specular reflection in the dead zone ( $\pm 10^\circ$ ).

**Pitch**

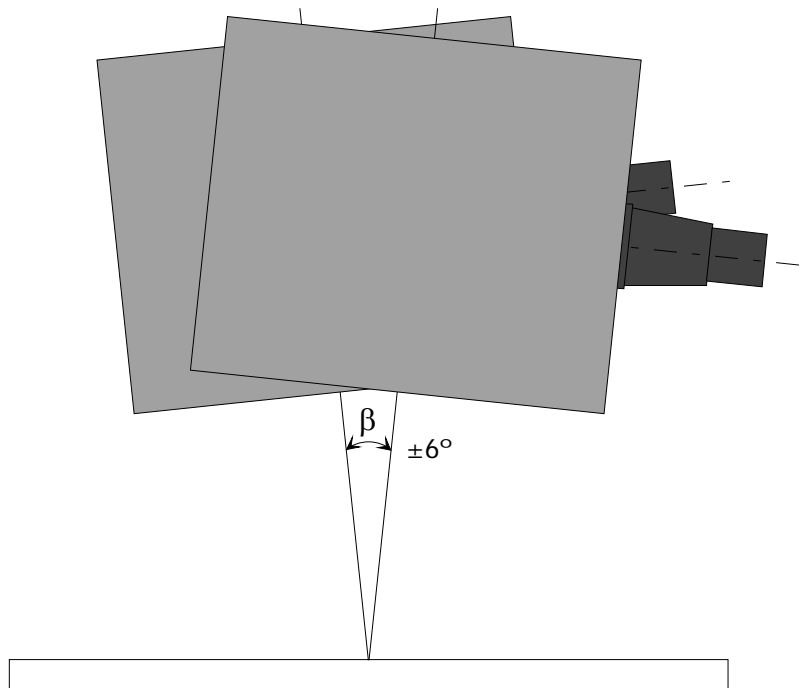

**Specified operation ( $\beta$ ) at  $\pm 6^\circ$  or less. (Recommended at  $0^\circ$ )**

**Tilt (Rotation)**

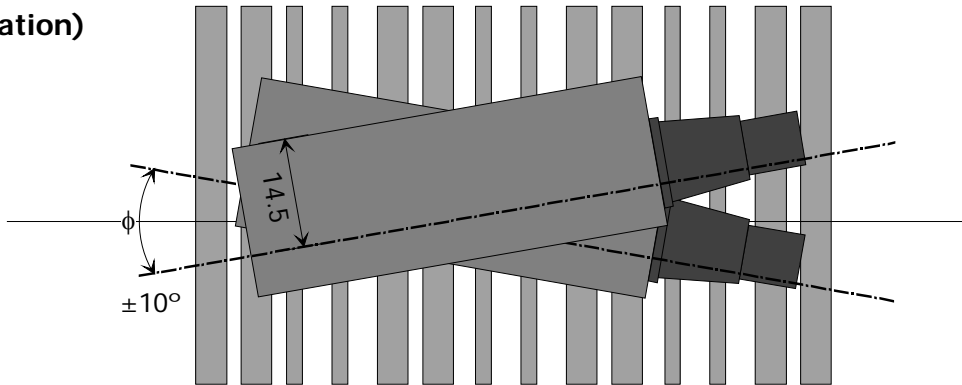

**Specified operation ( $\theta$ )  $\pm 10^\circ$  or less. (Barcode aspect ratio must allow the field of view to cover all bars). (Recommended operation at  $0^\circ$ )**

**Curvature**

EAN-8 / UPC-E:  $R = > 20 \text{ mm (0.8")}$  or  
EAN-13 / UPC-A:  $R = > 30 \text{ mm (1.2")}$ .  
Where: PCS 0.9,  $h = 35.4 \text{ mm (1.4")}$   
Skew= $13^\circ$ , Pitch= $0^\circ$ , Tilt= $0^\circ$

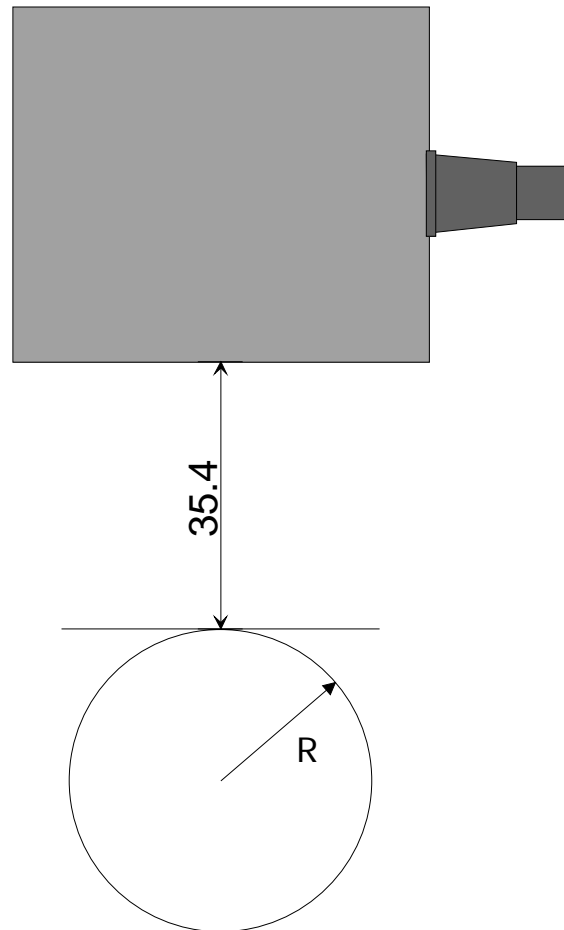



## Electrical Specifications

**Operating Voltage**            **+5VDC ± 5%**

Current

Operating (LEDs are ON)	130mA (max)
Idle (LEDs are OFF)	45mA (max)
Pwr-On Surge	1000mA (max)

## RS232 Communications Specifications

### RS232 Data Transmission Format

<u>Parameter</u>	<u>Default</u>	<u>Optional Settings</u>
Timing	Asynchronous	
No. of Start Bits	1 bit	
No. of Stop Bits	1 bit	1 or 2 bits
No of Data Bits	8 bit	7 or 8 bits
Parity	None	Odd / Even / None
Baud Rate	9600 baud	150 to 38,400 baud
Handshaking	None	Hardware / Software/ None

### RS232 Transmit / Receive Character Format

Start (First)	Data 7 to 8 Bits			Parity	Stop (Last)
1 Bit	LSB	XXXXXX	MSB	1 Bit	1 to 2 Bits

### RS232 Transmit Data Format, Output from Scanner

First to last	Global Prefix	Individual Prefix	Barcode data	Individual Suffix	Global Suffix
Format	0 to 8 characters	0 to 4 characters	1 to 44 characters	0 to 4 characters	0 to 8 characters
Default	0	0	1 to 44	CR	0

### RS232 Receive Data Format, Command inputs to scanner.

First to last	Prefix for all commands	Commands	Suffix for all Commands
Format	ESC or STX	1 or 2 characters	CR or ETX

ESC	Escape	ASCII 27 (x1B)
CR	Carriage Return	ASCII 13 (x0D)
STX	Start of Text	ASCII 2 (x02)
ETX	End of Text	ASCII 3 (x03)

### RS232 Signal Level

Signal Name	In / Out	Mark/Off	Space/On
TXD	Out	-5 to -15	+5 to +15
RXD	In	-3 to -15	+3 to +15

### Connector Pin-outs

9 Pin D-Sub Female Connector (with power stereo jack)

Pin No.	Signal	Direction
1	Frame Ground	
2	TxD	Output
3	RxD	Input
4	NC	
5	Signal Ground	Pwr Return
6	NC	
7	CTS	Input
8	RTS	Output
9	NC when plug is inserted +5V when plug is removed	Pwr Input

Power Plug/Jack	Signal
Tip	NC
Center	+5V
Rear	Signal Ground

### Environmental Specifications

Temperature

Operating	+32 to +113° F (0° to +45° C)
Storage	-14 to +140° F (-10° to +60° C)

Humidity (non-condensing)

Operating	20 to 80% RH
Storage	20 to 90% RH

Ambient Light                      Fluorescent or incandescent: 5,000 lx max

Anti Static                            15KV (non-destructive)

### Ordering Information

<u>Part No.</u>	<u>Description</u>
LHA2107RR1S-054	Front View, 9 Pin D-Sub Female Connector (with power stereo jack) (standard configuration, other configurations are available upon request)
LHA-2107R1-SK1	Developer's Test and Evaluation Kit is available which contains all the items needed to install and evaluate the scanner. The kit includes: <ul style="list-style-type: none"> <li><input type="checkbox"/> Scanner</li> <li><input type="checkbox"/> 5V Power Supply (32-00907-01)</li> <li><input type="checkbox"/> User Manual</li> <li><input type="checkbox"/> CD ROM (including manual, datasheet and supporting materials)</li> </ul>

### Regulatory

EMC	EN55022, EN55024
FCC	Class B

Section 3

Positioning the Scanner for Optimum Performance

**Achieving Optimum Performance**

Four items greatly impact performance:

- 1) Distance (from the scan window) to the bar code
- 2) Field of View
- 3) Specular Reflection
- 4) Quality of Bar Code Labels

**1) Distance to the Bar Code and 'Depth of field'**

The ideal location of the bar code relative to the scanner is at its focal distance, about 1.4" from the front of the unit. A bar code located either too near or too far from the scanner will be out of focus for the scanner camera causing the scanner to have difficulty decoding what appears to be fuzzy bars and spaces.

Just as with any camera, the scanner has a working depth-of-field (DOF). It can read bar codes that are not precisely at its focal distance - maybe a little closer, or a little farther away. The DOF varies based on the density of the bar code, i.e., the thicker the bars and spaces the more DOF. Very high density bar codes (which have very narrow bars) are readable over a much shorter DOF range than low density bar codes with larger bars.

The following table shows the depth-of-field "specifications" (closest to farthest reading distances) for the NFT 2100 scanner. The actual performance may differ slightly from unit to unit. Also, it is important to note that this data was measured under ideal conditions using high quality bar code labels. In a "real world" environment the conditions will not be as ideal. Therefore, the best practice is to position the scanner at the center of the depth-of-field rather than at the extremes of its depth-of-field.

Depth-of Field NFT 2100 (Specification)\*

Density	Min. Distance (inches)	Max Distance (inches)	Range (inches)
6 mil	0.9	1.6	0.7
10 mil	0.8	1.7	0.9
20 mil	0.8	2.0	1.2
40 mil	0.9	2.4	1.5

\* measured from front edge of scanner

**2) Reading width or Field of View of the scanner**

The table below shows the field-of-view (FOV) at various distances from the window. The FOV is the maximum width that the scanner is capable of reading. It is the distance from the left edge of the view to the right edge. For the NFT 2100, the FOV will be 3.1" at its focal distance of 1.4". Any part of a bar code label that is positioned outside of the FOV will make the label unreadable. Good design policy is to position the barcode at the center of the FOV where the camera sees best.

*Remember:* The width of a bar code label includes not only the bars and spaces but also the required white space (quiet zone) on each end.

**Readable Width or Field of View for the NFT 2100  
(Field-of-View Specification Based Upon 69° Degree Sweep)**

Distance from Front of Case	1.0"	Focal Distance 1.4"	1.5	2.0"	2.5"
	25.4mm	35.4mm	38.1mm	50.8mm	63.5mm
Field of View	2.6	3.1"	3.3	4.0	4.7
	66mm	80mm	83mm	101mm	118mm

**3) Avoiding Specular Reflection**

Do not position the scanner at an angle that causes the LED light to be reflected directly back into the scanner. This is called specular reflection. Too much reflected light can "blind" the scanner preventing a good decode. For optimal performance we recommended pitching the scanner  $\pm 13^\circ$  off the perpendicular to the barcode label surface.

If the bar code label is located on a flat surface, specular reflectivity occurs in the region between  $\pm 10$  degrees off perpendicular (See diagram). If the bar code label is located on a cylindrical surface, such as a test tube, the angle of specular reflection is measured tangent to the curve. If the curved surface is also moving, specular reflection may occur at some point along the movement. This is OK, as long as there is sufficient regions on the test tube label where the label is out of the specular angle. The following diagram indicates the region to avoid:

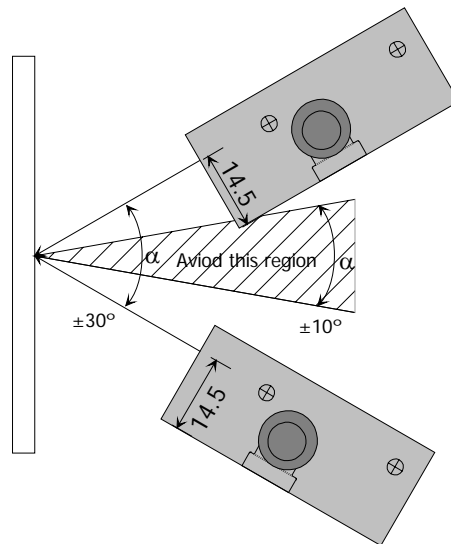

**4) Quality Bar Code Labels**

The quality of the bar code label can affect the scanning performance. Poor quality labels are more difficult to decode and may result in non-reads or potential misreads. The bar code label should be printed to specifications. This means that the bars are printed within spec, with the correct widths, no ink spread, crisps edges and no voids. There should be a sufficient quiet zone on both end of the bar code label. For best results, the paper or label stock should have a matte finish to diffuse light. The print contrast signal (which is a comparison of the reflectance of the bars and the background stock) should be as high as practical.

## Measuring Scanner Performance

A method for properly positioning the unit is to program the scanner for Trigger Disable (S7) and Continuous Read (S2) modes. The scanner will now be always on and will continuously read the same bar code. Since the buzzer sounds each time the bar code is read, the sound of the buzzer can be used like a "Geiger counter". As the position of the scanner changes the sound of the buzzer will change. The buzzer sound will be loudest and most continuous at the best reading position.

## Application Notes

### Tips for Achieving High Throughput

In some applications your primary objective may be to achieve the highest possible throughput rate. The following list identifies the parameters and scanner settings that can maximize scanning and decode throughput speed. Note, by emphasizing maximum throughput, other areas of performance may be affected. For example, the number of non-reads could increase.

If high throughput is critical, consider some or all of these settings:

- ◆ Operate in the Trigger Disabled mode. Operation of the trigger creates delay before decoding begins, slowing down throughput rate.
- ◆ Only enable those symbologies that you will be decoding.
- ◆ Eliminate all suffixes and prefixes to reduce transmission time.
- ◆ Minimize the number of redundant reads required before transmitting data.
- ◆ Transmit the decoded data at the highest baud rate.
- ◆ Disable buzzer functions.

### Tips for Insuring Highest Data Integrity

There are several parameters that can enhance your confidence that the correct bar code data is transmitted. Note that by emphasizing the accuracy and security of the data other areas of the scanner operation may be affected, for example, you may not achieve the highest throughput.

If accuracy and data integrity are critical, consider some or all of these settings:

- ◆ Program the scanner to require a high number of redundant decodes prior to transmitting. For example, program the scanner to decode a bar code exactly the same way three consecutive times before transmitting the data. Then decoding the bar code the same way 2 out of 3 times or any 3 out of 4 times is not sufficient. It must obtain three consecutive, identical decodes.
- ◆ Utilize a predetermined, fixed-length of bar code. Program the scanner to only decode a bar code of that length. Bar codes of any other length will be ignored.
- ◆ The quality of the printed bar code must be excellent.
- ◆ Use a bar code symbology that contains an internal check digit and program the scanner to calculate that check digit for validity prior to transmitting.
- ◆ Do not use a symbology with poor internal verification, or subject to partial decodes, such as 2 of 5 or MSI/Plessey.
- ◆ Only enable those symbologies that you will be decoding.
- ◆ Transmit data at low baud rates to minimize communication errors.

---

### Tips for Verifying the Presence of a Bar Code

If the scanner is operated in the "trigger enabled" mode and the trigger is activated, one of three conditions may occur:

A bar code is scanned and decoded.	Decoded data is transmitted
A bar code is scanned but is not decoded (e.g., print quality was poor)	No data is transmitted
No bar code is present	No data is transmitted

In some applications, when no data is transmitted, it may be important to know why. Was there a bar code present that could not be decoded, or was no bar code present at all?

This requirement is common in applications such as automated blood analysis equipment. Test tubes containing blood samples from many different people are loaded into a rack for automatic analysis. The bar code on each tube ties that sample and the results back to a specific individual. If no bar code data is transmitted it is critical to understand the reason.

Your Opticon scanner, when operated in the Trigger Enabled mode, can be programmed to transmit an error message indicating whether or not a bar code was present. See Section 33 of Appendix C of this manual for details.

## Section 4

### Configuring the Scanner

Since the operation of the NFT 2100 scanners are microprocessor controlled, it is possible to modify or program its operation to match your specific application. Changes in parameter settings can be accomplished two ways.

1. The scanner can be programmed by sending software commands from the host PC to the scanner via the RS232 connection. Most commands will be immediately active, but are not stored into non-volatile memory until the store command, Z2, is sent. A few commands, such as changing the communication parameters will not be active until they are stored via the Z2 command.
2. The second method employs specially designed programming bar codes referred to as menu commands. Scanning these bar codes instructs the scanner to modify specific parameters. These commands are stored into non-volatile memory as soon as the menu command mode is exited. Once stored in non-volatile memory, these settings will remain even after powering the unit OFF and ON.

### Programming Menus & Commands

Appendix A contains full instructions on how to configure the scanner as well as a complete listing of the computer commands and programming bar codes that are available to customize the scanner for your application.

### Default Settings

When you modify or change any parameters, the scanner can be programmed to retain the new parameter in non-volatile memory, even if power is interrupted or terminated. If for any reason the scanner is instructed to return all parameters to default settings (U2), it will return to the default settings shown in the following table.

Default settings are indicated by a pointing hand symbol (  ) throughout the bar codes menus.

Parameter	Factory Default Setting
RS 232 Communications	9600 baud 8 data bits 1 stop bit No parity No handshaking
Trigger Function	Disabled, (scanner is ON)
Read Mode	Multiple Read Mode
No. of Redundant Decodes	Read three times before transmitting
UPC-A (12 digits)	No leading zero transmitted (EAN 1 <sup>st</sup> Position) send check digit
UPC-E (7 digits)	No leading zero transmitted Send check digit
Code 39	Do not calculate check digit/Transmit check digit Disable start/stop characters transmission (*.....*)
Codabar	Disable start/stop characters transmission Do not calculate check digit
2 of 5 (Interleaved & Industrial)	Do not calculate check digit
Min/Max length of bar code only	Disabled
Buzzer	Enabled
Positive bar codes only	Enabled
Error indications	Do not transmit error message
Suffix	Carriage Return

## Section 5

### Application Engineering Support

#### **Technical Assistance and Support**

Opticon is eager to help you integrate the NFT 2100 scanner into your application. Our technical support staff is available to answer any questions or work with you to adapt the scanner to your specific situation. We are happy to answer your questions, assist in configuring and positioning the scanner for optimum operation, and help resolve any problems you encounter. Call us at 1 (800) 636-0090, and ask for technical support.

#### **Common Causes of Poor Performance**

The most common reasons for poor scanning performance are listed below:

- ◆ Bar codes are not positioned at the focal distance of the scanner.
- ◆ Specular reflection is impacting the scanner. Change the angle/position of the scanner or the bar code.
- ◆ Poor quality of printed bar codes. Bar codes are out of specification.
- ◆ The paper on which the bar code is printed is highly reflective or has a glossy finish causing light to be reflected into the scanner.
- ◆ The paper background is not white, but some color like dark blue, causing poor contrast.
- ◆ The distance from the scanner to the bar code is not suitable for the density of the bar code. Or the density of the bar code is beyond the scanners capability. If the red illuminating light of the scanner is not on, the scanner may be in the "Trigger Enable" mode expecting a trigger signal.
- ◆ If the com port setting is set to Handshaking, the scanner will not transmit until the CTS signal (RTS from Host) is activated.

#### **Modified and/or Customized Scanners**

Opticon will work with you to modify or customize scanners to match your requirements. Scanners can be modified in terms of connector type, pin-outs, cable length, default settings, custom software and many other areas.

Opticon will modify scanners in our factory and ship you scanners that match your specific requirements. By incorporating your modifications directly into production scanners, you receive scanners tailored for your need. They can be used immediately without the need for further modification or rework.



## Section 6

### Scanner Labeling

#### IEC 825-1 Class 1 LED Devices

The NFT 2100 has been examined and found to be a CE Class 1 LED Device according to the relevant requirements of IEC 825-1 and corresponding EN 60825-1 (1993-11) including amendment 1 (1997-09) and amendment 2 (2001-01).

The NFT 2100 scanner uses low-power visible LEDs. As with any very bright light source, such as a flashlight, you should avoid staring into the light. Momentary exposure to an IEC 825-1 Class 1 LED is not known to be harmful.

A manufacturer's label, as shown below, indicating the manufacturer, product model, ordering number, serial number, CE mark and place of manufacture is affixed to each scanner.

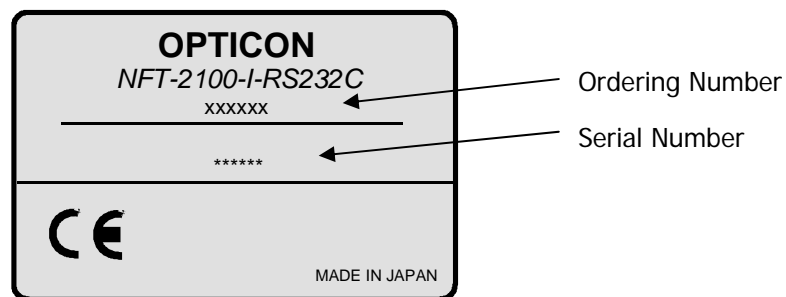

## Section 7

### Scanner Servicing and Maintenance

The NFT 2100 scanner contains no user adjustable or serviceable parts in the interior of the scanner. All product service must be performed by the Opticon Service Department in Orangeburg, NY. Opening the scanner will void the warranty.

The NFT 2100 is warranted for 7 year including parts and workmanship. If you need warranty or out-of-warranty repair, first **call 1-800-636-0090** to obtain a **Returned Material Authorization (RMA)** number. You will be provided a number and shipping instructions.

There is no scheduled maintenance required for the NFT 2100. The scanner can be cleaned using a water dampened, lint free or lens cloth. Be careful to avoid excessive moisture that would penetrate the housing or obscure the window. While use of cleaning fluids other than water are not recommended, a neutral detergent or ethanol would be preferred if necessary. Do not use bleach at full or diluted strength as damage to the painted case and/or window may result.

Appendices

Appendix A	How to Program the Scanner
Appendix B	Computer Programming Commands
Appendix C	Bar Code Programming Commands
Appendix D	Dimensional Drawing
Appendix E	Optical Performance (typical)

## Appendix A

### Programming the Scanner

Two different methods can be used to program parameters to configure the scanner:

- a. Programming via Computer Commands
- b. Programming via special Bar Codes from a menu page

Most parameters can be programmed using either of these two methods. However, there are certain parameters that are only programmable via the bar code menu.

#### a. Programming via Computer Commands

Parameters can be programmed by sending software commands or keyboard strokes from the host computer to the scanner in the following format:

**<ESC> Computer Command <CR>**

Note:

Only upper case letters are recognized, e.g., "AB" not "ab"  
Each command normally consists of two characters  
Downloading of software commands cannot be "grouped" together. Each command must be preceded by <ESC> or <STX> and followed by a <CR> or <ETX>

Parameters programmed by downloaded commands can be stored permanently by transmitting a "<ESC> Z2 <CR>" command. It is not necessary to send a "Z2" command after each parameter that is changed. One Z2 command will save all changes.

Appendix B lists all of the Computer Commands. In Appendix C, Bar Code Programming Menus, the left-hand column in all menus contains the Computer Command associated with that bar code.

#### b. Programming via Bar Codes

Use the following steps to program parameters via the bar code menus:

1. Scan the "Start/End" bar code. This instructs the scanner to enter the Programming Mode. While in this mode the scanner will beep intermittently.
2. Scan the bar code(s) associated with the desired parameter(s). The scanner will beep when the bar code is read. Note: because of the close proximity of bar codes on the page, it is important to aim carefully to ensure that only the desired bar code is scanned.
3. Scan the "Start/End" bar code. This instructs the scanner to exit the Programming Mode.

All the parameters that were scanned are retained in non-volatile memory and are stored permanently (even if the scanners is powered down) or until they are changed again.

When the scanner is in the Programming Mode, you can change more than one parameter at a time. However, this may become confusing. Until you become proficient at programming you may prefer to change only a few parameters at one time. We recommend that you keep a record of the changes you have made to the scanner. Note, while you are in the programming mode the scanner will not read regular bar codes.

### **What if you make a mistake?**

Don't worry. If you are programming the scanner but are unsure of which parameters have been changed, scan the **Reset All Defaults** bar code. This bar code returns the scanner to the default settings that were installed in the factory at the time the product was manufactured. Scanning this bar code erases any changes you have made, including any changes that were made during previous programming.

### **Reset All Defaults U2 Command**

This command will return all settings to the defaults that were installed in the factory

## Appendix B

### Computer Programming Commands

All commands listed below must be preceded by an 'ESC' (x1B) or 'STX' (x02) character and be followed by a 'Carriage Return' (x0D) or 'ETX' (x03) character. Shaded areas indicate factory default settings.

Enable	Disable	Global Defaults
U2		Enable Factory Default Settings
Z1		Transmit software version
Z2		Save all values set by command
Z3		Display software setting flags, prefix/suffix, & min/max lengths.

Only	Add	Symbology Selection
A0		Enable all symbologies
B0		Disable all symbologies
J0		Enable all UPC and EAN plus add-ons
A2	B2	Code 39
A3	B3	Codabar (NW-7)
A4	B4	IATA
A5	B5	Code 93
A6	B6	Code 128 (Inc. EAN-128)
A7	B7	MSI/Plessey
A1	B1	UK/Plessey
A9	B9	Telepen
J1	R1	UPC (A/E)
J2	R2	UPC (A/E)+2
J3	R3	UPC (A/E)+5
J4	R4	EAN (13/8)
J5	R5	EAN (13/8) +2
J6	R6	EAN (13/8) +5
J7	R7	2 or 5 Industrial
J8	R8	2 or 5 Interleaved
JD	JZ	TriOptic
RA	R9	SCode

Enable	Disable	Options for UPC-A and UPC-E
E2		UPC-A as EAN13 (13 Digits) Transmit leading zero & CD
E3		UPC-A (12 Digits) No leading zero but transmit CD
E4		UPC-A as EAN13 (12 Digits) Transmit leading zero but No CD
E5		UPC-A (11 Digits) No leading zero & no CD transmitted
E6		UPC-E (8 Digits) Transmit leading zero & CD
E7		UPC-E (7 Digits) No leading zero but transmit CD
E8		UPC-E (7 Digits) Transmit leading zero but no CD
E9		UPC-E (6 Digits) No leading zero & no CD transmitted
6P	6Q	Transmit UPC-E as UPC-A

Enable	Disable	Options for EAN-8 & EAN-13
6K	6J	EAN-13 Transmit CD
6I	6H	EAN-8 Transmit CD
IA	IB	Enable ISBN translation
HO	HN	Enable ISSN translation

Enable	Disable	Options for Code 39
8E		Enable read of 1 or more character lengths
8D		Enable read of 3 or more character lengths
C0	C1	Enable Check Digit calculation
D9	D8*	Enable Check Digit Transmission
D0	D1	Enable start/stop characters transmission (*.....*)
-Y		Enables primary decode algorithms for Code 39, I & D 2 of

		5, IATA, & Codabar
-Z		Alternate decode algorithm no.1 for Code 39
Enable	Disable	<b>Options for Code 39 (cont.)</b>
.S		Alternate decode algorithm no.2 for Code 39

Enable	Disable	<b>Options for IT Pharmaceutical</b>
D6	D5	IT Pharmaceutical only
D7	D5	IT Pharmaceutical if possible
DB	DA	Transmit Leading A

Enable	Disable	<b>Options for Codabar (NW-7)</b>
HC		Enable 1 character read minimum
HB		Enable 3 character read minimum
HF		Enable 5 character read minimum
F0		Do not transmit start/stop characters
F1		Transmit start/stop as ABCD/TN*E
F2		Transmit start/stop as abcd/tn*e
F3		Transmit start/stop as ABCD/ABCD
F4		Transmit start/stop as abcd/abcd
H8	H9	Transmit check digit
H6	H7	Calculate check digit
H4	HA	Enable ABC Codabar
H5	HA	Enable Cx Codabar
H3	HA	Enable Normal ABC & Cx Codabar
HH	HI	Intercharacter gap check
-Y	-X	Primary/Alternative Algorithm

Enable	Disable	<b>Options for I 2 of 5 / SCode</b>
G1	G0	Calculate check digit
E0	E1	Transmit check digit
GE		Enable 1 character minimum
GF		Enable 3 characters minimum
GI		Enable 5 characters minimum
GG	GH	Transmit S-Code as I 2 of 5
-Y	-X	Primary/Alternative Algorithm

Enable	Disable	<b>Options for IATA</b>
4H		Do not calculate check digit
4J		Calculate CD (CPN + Form + Serial)
4I		Calculate CD (Form + Serial)
4K		Calculate check digit (all data)
4L	4M	Transmit check digit
-Y	-X	Primary/Alternative Algorithm

Enable	Disable	<b>Options Code 128/EAN 128</b>
JF	OF	EAN-128 Only
MO	MP	Concatenation

Enable	Disable	<b>Options for Code 93</b>
+V	+W	Concatenation

	<b>Setting the Number of Digits</b>
H1	length setting all symbologies
HK	Length setting on selected symbologies
HL	Minimum length setting on selected symbologies
HM	Maximum length setting on selected symbologies
H0	Disable length setting on all symbologies

Prefix	Suffix	<b>Select Symbology for prefix/Suffix</b>
RY	RZ	All codes
N1	N6	UPC-A
M0	O0	UPC-A +2 or +5
N2	N7	UPC-E
M1	O1	UPC-E +2 or +5
N3	N8	EAN13
M2	O2	EAN-13 +2 or +5
N4	N9	EAN-8
M3	O3	EAN-8 +2or +5
M4	O4	Code 39

Prefix	Suffix	Select Symbology for prefix/Suffix
M5	O5	Codabar (NW-7)
M6	O6	Industrial 2 of 5

Prefix	Suffix	Select Symbology for prefix/Suffix (cont.)
M7	O7	Interleaved 2 of 5
M8	O8	Code 93
M9	O9	Code 128
I8	I9	IATA
N0	N5	MSI/Plessey
MB	OB	SCode
L8	L9	Telepen
MZ	PS	Preamble/Postamble

Direct Input Alpha/Numeric Characters					
Cmd	Char.	Cmd	Char.	Cmd	Char.
Q0	0	0A	A	\$A	a
thru	thru	thru	thru	thru	thru
Q9	9	0Z	Z	\$Z	z

Direct Input ASCII Control Characters					
Cmd.	Char.	Cmd.	Char.	Cmd	Char.
9G	null	1K	VT	1V	SYN
1A	SOH	1L	FF	1W	ETB
1B	STX	1M	CR	1X	CAN
1C	ETX	1N	SO	1Y	EM
1D	EOT	1O	SI	1Z	SUB
1E	ENQ	1P	DLE	9A	ESC
1F	ACK	1Q	DC1	9B	FS
1G	BEL	1R	DC2	9C	GS
1H	BS	1S	DC3	9D	RS
1I	HT	1T	DC4	9E	US
1J	LF	1U	NAK	9F	DEL

Direct Input Miscellaneous Characters					
Cmd.	Char.	Cmd.	Char.	Cmd	Char.

Direct Input Miscellaneous Characters					
5A	<SPAC E)	5M	,	7A	[
5B	!	5N	-	7B	\
5C	"	5O	.	7C	]
5D	#	5P	/	7D	^
5E	\$	6A	:	7E	_
5G	&	6B	;	7F	'
5H	`	6C	<	9T	{
5I	(	6D	=	9U	
5J	)	6E	>	9V	}
5K	*	6F	?	9W	~
5L	+	6G	@		

Communication Parameters	
K0	150 baud
K1	300 baud
K2	600 baud
K3	1,200 baud
K4	2,400 baud
K5	4,800 baud
K6	9,600 baud
K7	19,200 baud
K8	38,400 baud
L0	7 Data Bits
L1	8 Data Bits
L2	Parity = None
L3	Parity = Even
L4	Parity = Odd
L5	1 Stop bit
L6	2 Stop bits

Communication Handshaking	
I0	Unlimited wait for CTS from terminal
I1	100 mS wait for CTS from terminal
I2	200 ms wait for CTS from terminal
I3	400 mS wait for CTS from terminal
P0	No Handshaking

<b>Communication Handshaking</b>	
P1	Busy/Ready
P2	Modem
P3	ACK/NAK (1 sec timeout with error buzzer)
P4	ACK/NAK no response (100 ms timeout, terminates with good read buzzer)
ZG	XON/OFF

<b>Communication Delays</b>	
KA	No intercharacter delay
KB	20 ms intercharacter delay
KC	50 ms intercharacter delay
KD	100 ms intercharacter delay

<b>Buzzer Operation</b>	
T0	Volume = Maximum
T1	Volume = Upper mid-range
T2	Volume = Lower mid-range
T3	Volume = Minimum
W0	Disable Buzzer
W1	Enable buzzer at 3kHz
W2	Enable buzzer at 3kHz with 2.5kHz interval
W3	Enable buzzer at 3kHz with 4kHz interval
W4	Buzzer duration 0.10 sec
W5	Buzzer duration 0.20 sec
W6	Buzzer duration 0.40 sec
W7	Buzzer duration 0.05 sec
W8	Enable buzzer

<b>Setting the Trigger Functions</b>	
S7	Disable the trigger function (LED On)
S8	Enable the trigger function (LED OFF until the trigger is activated )
Z	Activate the trigger; turns the LEDs ON
Y	Terminate the trigger.

<b>Selecting the Read Mode</b>	
S0	Single Read Mode (Trigger must be Enabled, S8)

S1	Multiple Read Mode
S2	Continuous Read Mode

<b>Scanner Timeout (Trigger Mode)</b>	
Y1	1 second after triggering
Y2	2 second after triggering
Y3	3 second after triggering
Y4	4 second after triggering
Y5	5 seconds after triggering
Y6	6 second after triggering
Y7	7 seconds after triggering
Y8	8 seconds after triggering
Y9	9 seconds after triggering
YL	Read time x 10
Y0	Scan time follows Hardware trigger active time. Can be terminated by sending the Y command
YM	Stays ON indefinitely after triggering. Must be terminated by sending the Y commands.

<b>EAN/UPC Add On Wait Times</b>	
XA	Add-on Wait Time - Disable
XB	Add-on Wait Time – 250 msec
XC	Add-on Wait Time – 500 msec
XD	Add-on Wait Time – 750 msec

<b>S1 Multiple read reset time for same labels</b>	
AH	Multiple Read Reset Time – 50 msec
AI	Multiple Read Reset Time – 100 msec
AJ	Multiple Read Reset Time – 200 msec
AK	Multiple Read Reset Time – 300 msec
AL	Multiple Read Reset Time – 400 msec
AM	Multiple Read Reset Time – 500 msec
AN	Multiple Read Reset Time – 600 msec
AG	Multiple Read Reset Time - Indefinite

<b>Quiet Zone Options</b>	
YN	No margin check



YO	Margin check 1/7 nominal
YP	Margin check 2/7 nominal
YQ	Margin check 3/7 nominal
YR	Margin check 4/7 nominal
YS	Margin check 5/7 nominal
YT	Margin check 6/7 nominal
YU	Margin check normal

T4	Disable good read LED (GRL)
T5	GRL ON for 0.20 seconds after decode
T6	GRL ON for 0.40 seconds after decode
T7	GRL ON for 0.80 seconds after decode

	<b>Redundant Decoding</b>
X2	Read bar code 3 times before transmitting
X3	Read bar code 4 times before transmitting

	<b>Xmit Error (Trigger Enabled Mode only)</b>
TH	User defined error message for no label
TI	User defined error message for no decode
TG	Clear error messages for no label, no decode

	ACK/NAK response to Host transmissions
WD	No response to command
WC	Response to command – OK=ACK, ERROR=NAK

	<b>Good Read LED Operation</b>
--	--------------------------------

## Appendix C:

### Bar Code Programming Menus & Commands - Index

1. Global Default & Scanner Configurations.....	24
2. Symbology Selection.....	25-26
3. Add/Activate Specific Bar Code Symbologies.....	27-28
4. Delete/Deactivate Bar Code Symbologies.....	28
5. Options for UPC.....	29
6. Options for EAN-8 & EAN-13.....	30
7. Options for Code-39 & IT Pharmaceutical).....	31-32
8. Options for Codabar (NW-7).....	32-33
9. Options for 2 of 5 (Including SCode).....	35
10. Options for IATA.....	36
11. Options for Code-128 & EAN-128.....	37
12. Options for Code-93.....	37
13. Setting the Number of Digits.....	38
14. Creating a Prefix and/or Suffix.....	39-40
15. Setting Prefixes (Identifying the Symbology).....	41-42
16. Setting Suffixes (Identifying the Symbology).....	42-44
17. Direct Input of Numeric Characters.....	45
18. Direct Input of Alpha Characters.....	46
19. Direct Input of Alpha Characters (Lower Case).....	47
20. Direct Input of Control Characters.....	48-49
21. Direct Input Characters Miscellaneous.....	50-51
22. Communication Parameters.....	52-53
23. Handshaking.....	53-54
24. Buzzer Operation.....	55
25. Setting the Trigger Functions.....	56
26. Selecting the Read Mode.....	56-57
27. Add-on Wait Mode.....	58
28. Scanner Timeout (Trigger Enabled Mode only).....	59
29. Multiple Read Reset Time.....	60
30. Quiet Zone Options.....	61
31. Redundant Decoding.....	62
32. Transmitting Error Indications (Trigger Enabled only).....	62
33. Programming No Read Error Messages.....	63
34. Good Read LED Operation.....	63

1. Global Default & Scanner Configurations

Computer Command	Function /Description	Bar Code Command
(ZZ)	START/END Programming Menu	
U2	Return all parameters to Default settings	
Z1	Transmit software version	
Z2*	Save all values set by com port commands (not lost upon power off)	
Z3	Display software settings, prefix/suffix, & min/max lengths	



Note: Where computer commands appear in parenthesis, bar code commands must be used to start and end manual programming of the scanner.

Note: Scanner default settings are indicated by a pointing hand (☞) symbol throughout the menus to follow.









\* Use Z2 (Save all values set by command) after sending com port commands to store settings in non-volatile memory prior to power off.

## 2. Symbology Selection

Computer Command	Function /Description	Bar Code Command
(ZZ)	START/END Programming Menu	
A0	Enable all bar code symbologies	
J0	Enable all UPC and EAN	
A2	Only Code-39	
A3	Only Codabar (NW-7)	
A4	Only IATA	
A5	Only Code-93	
A6	Only Code-128 (Inc. EAN-128)	
A7	Only MSI/Plessey	
A1	Only UK/Plessey	
A9	Only Telepen	
J1	Only UPC (A/E)	
J2	Only UPC (A/E)+2	
J3	Only UPC (A/E)+5	

CONTINUED ON NEXT PAGE...

**2. Symbology Selection (continued)**

Computer Command	Function /Description	Bar Code Command
(ZZ)	START/END Programming Menu	
J4	Only EAN (13/8)	
J5	Only EAN (13/8) +2	
J6	Only EAN (13/8) +5	
J7	Only Industrial 2 of 5	
J8	Only Interleaved 2 of 5	
JD	TriOptic	
RA	SCode	

### 3. Add/Activate Specific Bar Code Symbolgies

Computer Command	Function /Description	Bar Code Command	
(ZZ)	START/END Programming Menu		
B2	Enable Code 39		
B3	Enable Codabar (NW-7)		
B4	Enable IATA		
B5	Enable Code 93		
B6	Enable Code 128		
B7	Enable MSI/Plessey		
B1	Enable UK/Plessey		
B9	Enable Telepen		
R1	Enable UPC (A/E)		
R2	Enable UPC (A/E) +2		
R3	Enable UPC (A/E) +5		
R4	Enable EAN (13/8)		
R5	Enable EAN (13/8) +2		

CONTINUED ON NEXT PAGE...

**3. Add/Activate Specific Bar Code Symbolgies (continued)**

Computer Command	Function /Description	Bar Code Command
(ZZ)	START/END Programming Menu	
R6	Enable EAN (13/8) +5	
R7	Enable Industrial 2 of 5	
R8	Enable Interleaved 2 of 5	
JZ	TriOptic	
R9	SCode	



**4. Delete/Deactivate Bar Code Symbolgies**

Computer Command	Function /Description	Bar Code Command
(ZZ)	START/END Programming Menu	
BO	Disable all symbolgies	

### 5. Options for UPC

Computer Command	Function /Description	Bar Code Command
(ZZ)	START/END Programming Menu	
E2	Translate UPC-A to EAN-13 (13 Digits) Add leading zero & Transmit check digit	
E3	UPC-A (12 Digits) Do not add leading zero; Transmit check digit	
E4	Translates UPC-A to EAN-13 (12 Digits) Add leading zero; Do not transmit check digit	
E5	UPC-A (11 Digits) Do not add leading zero; Do not transmit check digit	
E6	UPC-E (8 Digits), Transmit first character & check digit	
E7	UPC-E (7 Digits) Do not transmit first character, do transmit check digit	
E8	UPC-E (7 Digits) Do transmit first character, do not transmit check digit	
E9	UPC-A (6 Digits) Do not transmit first character nor check digit	
6Q	Do not expand UPC-E to UPC-A	
6P	Expand UPC-E to UPC-A	





**6. Options for EAN-8 & EAN-13**

Computer Command	Function /Description	Bar Code Command
(ZZ)	START/END Programming Menu	
6J	EAN-13 Do not transmit CD	
6K	EAN-13 Transmit CD	
6H	EAN-8 Do not transmit CD	
6I	EAN-8 Transmit CD	
IB	Disable ISBN translation	
IA	Enable ISBN translation	
HN	Disable ISSN translation	
HO	Enable ISSN translation	



**7. Options for Code 39 and IT Pharmaceutical**

Computer Command	Function /Description	Bar Code Command
(ZZ)	START/END Programming Menu	
8E	Enable 1 character (3 characters including start/stop characters)	
8D	Enable 3 characters	
C1	Disable check digit calculation	
C0	Enable check digit calculation	
D9	Transmit check digit	
D8	Do not transmit check digit	
D1	Do not transmit start/stop characters (*.....*)	
D0	Transmit start/stop characters (*.....*)	
-Y	Enables primary decode algorithms for Code 39, I & D 2 of 5, IATA, & Codabar	
-Z	Alternate decode algorithm no.1 for Code 39	
.S	Alternate decode algorithm no.2 for Code 39	



CONTINUED ON NEXT PAGE

**7. Options for Code 39 and IT Pharmaceutical (continued)**

Computer Command	Function /Description	Bar Code Command
(ZZ)	START/END Programming Menu	
D5	Disable IT Pharmaceutical & enable code 39	
D6	Enable IT Pharmaceutical & disable code 39	
D7	Enable IT Pharmaceutical if possible	
DB	IT Pharmaceutical, enable transmit of leading A	
DA	IT Pharmaceutical, disable transmit of leading A	

**8. Options for Codabar (NW-7)**

Computer Command	Function /Description	Bar Code Command
(ZZ)	START/END Programming Menu	
HC	Enable 1 character (3 characters including start/stop characters)	
HB	Enable 3 characters	
HF	Enable 5 characters	
F0	Do not transmit start/stop characters	
F1	Transmit start/stop characters as ABCD/TN*E	
F2	Transmit start/stop characters as abcd/tn*e	
F3	Transmit start/stop characters as ABCD/ABCD	

**8. Options for Codabar (NW-7) (continued)**

Computer Command	Function /Description	Bar Code Command
(ZZ)	START/END Programming Menu	
F4	Transmit start/stop characters as abcd/abcd	
HJ	Transmit start/stop as DC1, DC2, DC3, DC4	
H8	Transmit check digit	
H9	Do not transmit check digit	
H7	Do not calculate check digit	
H6	Calculate check digit (MOD 16)	
H4	Enable ABC Codabar	
H5	Enable CX Codabar	
H3	Enable normal, ABC & CX Codabar	
HA	Disable ABC & Cx Codabar	
HI	Disable Inter-character Gap Check	
HH	Enable Inter-character Gap Check	
-Y	Enables primary decode algorithms for Code 39, I & D 2 of 5, IATA, & Codabar	
-X	Alternate decode algorithm for Codabar	



Codabar (NW-7) Format

Start Character	1 to 42 data digits	Check digit	Stop Character
A . . . . .			. . . . . T
a . . . . .			. . . . . t
A . . . . .			. . . . . A
a . . . . .			. . . . . a

- Codabar (NW-7) has four different start/stop character schemes as shown above. The check digit is optional and, if present, would be the last character before the stop character.
- If the scanner is programmed to calculate the check digit and the bar code is not printed with a check digit, the bar code will not be read.

**9. Options for Interleaved & Industrial 2 of 5**

Computer Command	Function /Description	Bar Code Command
(ZZ)	START/END Programming Menu	
G0	Do not calculate check digit	
G1	Calculate check digit	
E0	Do not transmit Check digit	
E1	Transmit check digit	
GE	Enable 1 character minimum	
GF	Enable 3 character minimum	
GI	Enable 5 character minimum	
GG	Enable transmit SCode as Interleaved 2 of 5	
GH	Disable transmit SCode as Interleaved 2 of 5	
-Y	Enables primary decode algorithms for Code 39, I & D 2 of 5, IATA, & Codabar.	
-X	Alternate algorithm for I 2 of 5, D 2 of 5 & IATA	

**2 of 5 Format (Standard (Industrial) and Interleaved)**

1 to 44 data digits	CD
numeric only (0 to 9)	Check Digit

Opticon strongly recommends that the "Setting the Number of Digits" featured in Section 13 be employed whenever 2 of 5 bar codes are used.

### 10. Options for IATA

Computer Command	Function /Description	Bar Code Command
(ZZ)	START/END Programming Menu	
4H	Do not calculate check digit	
4J	Calculate check digit (CPN + Form + Serial)	
4I	Calculate check digit (Form + Serial)	
4K	Calculate check digit (All data)	
4L	Transmit check digit	
4M	Do not transmit check digit	
-Y	Enables primary decode algorithms for Code 39, I & D 2 of 5, IATA, & Codabar.	
-X	Alternate algorithm for I 2 of 5, D 2 of 5, IATA & Codabar	

The IATA code is a variable length symbology with an optional check digit and non-printable start/stop characters. The following characters are supported: Digits 0 up to 9.

The checksum is calculated as modulo seven of the data string. IATA is an acronym for International Air Transport Association.

String format	CPN	AC	FC	SN	CD
Meaning of Acronym	Coupon	Airline Code	Form Code	Serial Number	Check Digit
Number of digits (15 total)	1	3	2	8	1

- ◆ Enable check digit check
- ◆ Selection of the check digit calculation
- ◆ Disable transmission of the check digit

Check digit calculation: If the check digit calculation is required, then the appropriate calculation method must be selected.

### 11. Options for Code-128 / EAN-128

Computer Command	Function /Description	Bar Code Command
(ZZ)	START/END Programming Menu	
OF	Disable EAN-128 only	
JF	Enable EAN-128 only	
MP	Disable concatenation	
MO	Enable concatenation	



### 12. Options for Code-93

Computer Command	Function /Description	Bar Code Command
(ZZ)	START/END Programming Menu	
+W	Disable concatenation	
+V	Enable concatenation	





13. Setting the Character length that is allowed to be read.

Computer Command	Function /Description	Bar Code Command
(ZZ)	START/END Programming Menu	
H0	Disable length setting on all symbologies	
H1	Enable length setting on all symbologies	
HK	Enable length setting for selected codes	
HL	Enable minimum length for selected codes	
HM	Enable maximum length for Selected codes	



To avoid truncation errors, the scanner can be programmed to only decode bar codes of one specific length, i.e., containing a specific number of digits. It is also possible to program the scanner to only decode bar codes of either of two specific lengths.

To set one or two lengths for all symbologies:

1. Scan "START" to enter the programming mode.
2. Scan "Enable length setting (H1) for all symbologies".
3. Scan a sample bar code of the desired length.
4. Repeat Step #3, re-scanning the sample bar code length or a different bar code length to get 2 lengths.
5. Scan "END" to exit the programming mode

To set one or two lengths for selected symbologies:

1. Scan "START" to enter the programming mode
2. Scan "Enable length setting (HK) for selected symbologies".
3. Scan a sample bar code of the desired length #1
4. Repeat Step #3, re-scanning the sample bar code length or a different bar code length to get 2 lengths.
5. Scan "END" to exit the programming mode

"Setting the Number of Digits" can only be applied to Code 39, NW-7, 2 of 5, and MSI/Plessey. WPC, Code 93, IATA, and Code 128 are not affected.

Setting Minimum/Maximum Length



This option modifies the default minimum length table. To use this option, perform the following steps:

1. Scan "START" to enter the programming mode
2. Scan "Enable minimum length for selected codes" (HL)
3. Scan bar codes of the *required type and length*.
4. Scan "END" to end the programming sequence.

For example, if a Code 39 label containing 2 characters were scanned in Step 3 then only Code 39 labels would be checked for a minimum length of 2 characters. If a second label had been read in Step 3 (immediately following the first), then that particular symbology would have been set to its associated minimum character length.

In a similar manner, the maximum length for selected codes can be established by using the "Enable maximum length for selected codes" (HM) command.

#### 14. Creating a Prefix and/or Suffix

Computer Command	Function /Description	Bar Code Command
(ZZ)	START/END Programming Menu	
Z3	Display Settings including Prefix/Suffix value and length (expressed in hexadecimal format)	

The Z3 command can be used to instruct the scanner to provide a list of its current software settings including prefixes and suffixes.

The scanner can be programmed to transmit a prefix and/or suffix with the decoded data. A Prefix (or a Suffix) is composed of up to 4 characters. The following steps are used to establish a Prefix that will be

**Example:** To add the alpha character "A" as a Prefix and "B" as a Suffix to UPC-A bar code data:

1. Scan "START/END Programming Mode"
2. Scan N1, representing a Prefix for UPC-A
3. Scan 0A, representing the alpha character "A"
4. Scan N6, representing a Suffix for UPC-A
5. Scan 0B, representing the alpha character "B"
6. Scan "START/END Programming Mode"

transmitted with the bar code data:

1. Scan Start
2. Scan the bar code representing the symbology to which you wish to add a Prefix/Suffix
3. Scan the character(s) that will comprise the Prefix/Suffix. Up to four numeric, alpha or control character(s) may be used. Scanning no characters will delete the Prefix/Suffix
4. Scan "STOP" to exit the Programming Mode.

In addition, the scanner can be programmed to transmit a preamble and/or postamble with the decoded data. A Preamble and/or postamble can be composed of up to 8 characters each and will apply to all symbologies. The following steps are used to establish a Preamble and/or postamble that will be transmitted with the bar code data:

1. Scan Start
2. Scan the MZ for preamble or PS for Postamble
3. Scan the character(s) that will comprise the Preamble/Postamble. Up to eight characters may be used. Scanning no characters will delete the Preamble/Postamble.
4. Scan "STOP" to exit the Programming Mode.

**Example:** To add the alpha character "A" as a Prefix and "B" as a Suffix to UPC-A bar code data:









7. Scan "START/END Programming Mode"
8. Scan N1, representing a Prefix for UPC-A
9. Scan 0A, representing the alpha character "A"
10. Scan N6, representing a Suffix for UPC-A
11. Scan 0B, representing the alpha character "B"
12. Scan "START/END Programming Mode"

**15. Setting Prefixes (Identifying the Symbology)**

Computer Command	Function /Description	Bar Code Command
(ZZ)	START/END Programming Menu	
RY	All codes	
N1	UPC-A	
M0	UPC-A +2 or +5	
N2	UPC-E	
M1	UPC-E +2 or +5	
N3	EAN-13	
M2	EAN -13 +2 or +5	
N4	EAN-8	
M3	EAN-8 +2 or +5	
M4	Code 39	
M5	Codabar (NW-7)	
M6	Industrial 2 of 5	

CONTINUED ON NEXT PAGE...

**15. Setting Prefixes (Identifying the Symbology) (continued)**

Computer Command	Function /Description	Bar Code Command
(ZZ)	START/END Programming Menu	
M7	Interleaved 2 of 5	
M8	Code 93	
M9	Code 128	
I8	IATA	
N0	MSI/Plessey	
MB	SCode	
L8	Telepen	
MZ	Preamble (all codes)	

### 16. Setting Suffixes (Identifying the Symbology)

Computer Command	Function /Description	Bar Code Command
(ZZ)	START/END Programming Menu	
RZ	All Codes	
N6	UPC-A	
O0	UPC-A +2 or +5	
N7	UPC-E	
O1	UPC-E +2 or +5	
N8	EAN-13	
O2	EAN-13 +2 or +5	
N9	EAN-8	
O3	EAN-8 +2 or +5	
O4	Code 39	
O5	Codabar (NW-7)	
O6	Industrial 2 of 5	

CONTINUED ON NEXT PAGE...

**16. Setting Suffixes (Identifying the Symbology) (continued)**





























Computer Command	Function /Description	Bar Code Command
(ZZ)	START/END Programming Menu	
O7	Interleaved 2 of 5	
O8	Code 93	
O9	Code 128	
I9	IATA	
N5	MSI/Plessey	
OB	SCode	
L9	Telepen	
PS	Postamble (All Codes)	

### 17. Direct Input of Numeric Characters

Computer Command	Function /Description	Bar Code Command
(ZZ)	START/END Programming Menu	
Q0	0	
Q1	1	
Q2	2	
Q3	3	
Q4	4	
Q5	5	
Q6	6	
Q7	7	
Q8	8	
Q9	9	



### 18. Direct Input of Alpha Characters

(ZZ)	START/END Program Menu		0N	N	
0A	A		0O	O	
0B	B		0P	P	
0C	C		0Q	Q	
0D	D		0R	R	
0E	E		0S	S	
0F	F		0T	T	
0G	G		0U	U	
0H	H		0V	V	
0I	I		0W	W	
0J	J		0X	X	
0K	K		0Y	Y	
0L	L		0Z	Z	
0M	M		(ZZ)	START/END Program Menu	

**19. Direct Input of Alpha Characters (Lower Case)**

(ZZ)	START/END Program Menu		\$N	n	
\$A	a		\$O	o	
\$B	b		\$P	p	
\$C	c		\$Q	q	
\$D	d		\$R	r	
\$E	e		\$S	s	
\$F	f		\$T	t	
\$G	g		\$U	u	
\$H	h		\$V	v	
\$I	i		\$W	w	
\$J	j		\$X	x	
\$K	k		\$Y	y	
\$L	l		\$Z	z	
\$M	m		(ZZ)	START/END Program Menu	

## 20. Direct Input of Control Characters

(ZZ)	START/END Program Menu		1M	^M (CR)	
9G	^@ (null)		1N	^N (SO)	
1A	^A (SCH)		1O	^O (SI)	
1B	^B (STX)		1P	^P (DLE)	
1C	^C (ETX)		1Q	^Q (DC1)	
1D	^D (EOT)		1R	^R (DC2)	
1E	^E (ENQ )		1S	^S (DC3)	
1F	^F (ACK)		1T	^T (DC4)	
1G	^G (BEL)		1U	^U (NAK)	
1H	^H (BS)		1V	^V (SYN)	
1I	^I (HT)		1W	^W (ETB)	
1J	^J (LF)		1X	^X (CAN)	
1K	^K (VT)		1Y	^Y (EM)	
1L	^L (FF)		START/END Program Menu	(ZZ)	

**20. Direct Input of Control Characters (Continued)**

Computer Command	Function /Description	Bar Code Command
(ZZ)	START/END Programming Menu	
1Z	^Z (SUB)	
9A	^[ (ESC)	
9B	^\ (FS)	
9C	^] (GS)	
9D	^^ (RS)	
9E	^_ (US)	
9F	DEL (ASCII 127)	

**21. Direct Input Characters Misc.**

(ZZ)	START/END Program Menu		5N	-	
5A	(SPACE)		5O	.	
5B	!		5P	/	
5C	"		6A	:	
5D	#		6B	;	
5E	\$		6C	<	
5F	%		6D	=	
5G	&		6E	>	
5H	`		6F	?	
5I	(		6G	@	
5J	)		7A	[	
5K	*		7B	\	
5L	+		7C	]	
5M	,		START/END Program Menu	(ZZ)	

CONTINUED ON NEXT PAGE...

**21. Direct Input Characters Misc. (Continued)**

Computer Command	Function /Description	Bar Code Command
(ZZ)	START/END Programming Menu	
7D	^	
7E	-	
7F	'	
9T	{	
9U		
9V	}	
9W	~	

**22. Communication Parameters**

Computer Command	Function /Description	Bar Code Command
(ZZ)	START/END Programming Menu	
K0	150 baud	
K1	300 Baud	
K2	600 Baud	
K3	1,200 Baud	
K4	2,400 Baud	
K5	4,800 Baud	
K6	9,600 Baud	
K7	19,200 Baud	
L0	7 Data Bits	
L1	8 Data bits	
L2	Parity = None	
L3	Parity = Even	
L4	Parity = Odd	



CONTINUED ON NEXT PAGE

**22. Communication Parameters. (Continued)**

Computer Command	Function /Description	Bar Code Command
(ZZ)	START/END Programming Menu	
L5	1 Stop Bit	
L6	2 Stop Bits	



**23 Communication Handshaking.**





Computer Command	Function /Description	Bar Code Command
(ZZ)	START/END Programming Menu	
I0	Unlimited wait for CTS from terminal	
I1	100 mS wait for CTS from terminal	
I2	200 mS wait for CTS from terminal	
I3	400 mS for CTS from terminal	
P0	No Handshaking or ACK/NAK	
P1	Busy/Ready	
P2	Modem	
P3	ACK/NAK	
ZG	XON/XOFF	



CONTINUED ON NEXT PAGE...



### 23. Communication Delays

P4	ACK/NAK no response (100 ms timeout, terminates with good read buzzer)	
KA	No intercharacter delay	
KB	20 ms intercharacter delay	
KC	50 ms intercharacter delay	
KD	100 ms intercharacter delay	





**24. Buzzer Operation**

Computer Command	Function /Description	Bar Code Command
(ZZ)	START/END Programming Menu	
T0	Volume = Maximum	
T1	Volume = Upper Mid-range	
T2	Volume = Lower Mid-range	
T3	Volume = Minimum	
W0	Disable buzzer	
W8	Enable buzzer	
W1	Set buzzer at 3kHz	
W2	Set buzzer at 3kHz with 2.5kHz interval	
W3	Set buzzer at 3kHz with 4kHz interval	
W4	Buzzer duration 0.10 sec	
W5	Buzzer duration 0.20 sec	
W6	Buzzer duration 0.40 sec	
W7	Buzzer duration 0.05 sec	



## 25. Setting the Trigger Functions





Computer Command	Function /Description	Bar Code Command
(ZZ)	START/END Programming Menu	
S7	Disable the trigger function /LEDs are ON continuously	
S8	Enable the trigger function /LEDs are OFF until trigger is activated or "pulled"	
Z	Activate the trigger; turns the scanner ON.	Use as Com Port Command
Y	Terminates the trigger 'on time'	Use as Com Port Command



The Trigger function is not enabled in the default setting. This means that the LEDs are "ON" and ready to scan until the trigger mode is set by the S8 command.

Once in the trigger mode, the host can trigger the unit by sending a <ESC> Z <CR> command. (See Scanner Timeout to establish the length of time the scanning light remains ON after the trigger is activated.) A hardware trigger can also be used to turn the scanner ON.

## 26. Selecting the Read Mode





Computer Command	Function /Description	Bar Code Command
(ZZ)	START/END Programming Menu	
S0	Single Read Mode (Trigger enabled mode only)	
S1	Multiple Read Mode. (will read more than 1 label)	
S2	Continuous Read Mode. (will read the same label over and over)	



The operation of the scanner in the various read modes is described in the table below. The "Continuous Read" mode is helpful in positioning the scanner for optimum reading. In "Continuous Read," the scanner's buzzer functions like a Geiger counter, sounding the most active at the position achieving the greatest number of good reads.

Mode	Trigger Function Enabled (S8)	Trigger Function Disabled (S7)
Multiple Read (S1)	After receiving a trigger pulse, scanner will read multiple, different bar codes in succession until it times out. (Each read will reset the scanner's time out)	Scanner will read different bar codes in succession if they are presented to the read window.
	Scanner may not read the same bar code twice if they are consecutive. (See Sect. 32)	Scanner may not read the same bar code twice if they are consecutive. (See Sect. 32)
Continuous Read (S2)	Scanner will read the same bar code continuously after receiving a trigger pulse until the label is removed. The LEDs then time out.	Scanner will read the same bar code continuously.
Single Read (S0)	Scanner will read only one bar code after receiving a trigger pulse. The scanner time out is terminated on a good read.	Same as Multiple Read mode, above.

**27. Add-on Wait Mode (Applies to UPC/EAN only)**

Computer Command	Function /Description	Bar Code Command
(ZZ)	START/END Programming Menu	
XA	Disable Add-on wait mode	
XB	Enable Add-on wait mode of 0.25 seconds	
XC	Enable Add-on wait mode of 0.50 seconds	
XD	Enable Add-on wait mode of 0.75 seconds	



These commands are used when UPC/EAN when add-on is enabled. The reader searches within the selected time for a valid add-on code. If a valid add-on code is found, the reader transmits the data immediately. If nothing is found behind the code, the reader will transmit the data without the add-on.

## 28. Scanner Timeout (Trigger Enabled Mode only)

These commands, which are only applicable in the Trigger Enabled mode, establish the time-out period after the trigger pulse is received. In Single Read Mode, the time out is terminated upon a good read. In Multiple Read and Continuous Read Modes the time out period is restarted after any good read.

Computer Command	Function /Description	Bar Code Command
(ZZ)	START/END Programming Menu	
Y1	1 Second after triggering	
Y2	2 Seconds after triggering	
Y3	3 Seconds after triggering	
Y4	4 Seconds after triggering	
Y5	5 Seconds after triggering	
Y6	6 Seconds after triggering	
Y7	7 Seconds after triggering	
Y8	8 Seconds after triggering	
Y9	9 Seconds after triggering	
YL	Read time x 10	
Y0	On time follows the Hardware trigger active time. Can be terminated by sending the Y command	
YM	Stays ON indefinitely after triggering. Must be terminated by sending the Y commands.	



## 29. Multiple Read Reset Time

This option is used in conjunction with the multiple read mode. The selected time sets the period the scanners should be pointed away from a label before that same label can be decoded again. Indefinitely means that the next bar code must always be different during the time the scanner is triggered.

Computer Command	Function /Description	Bar Code Command
(ZZ)	START/END Programming Menu	
AH	Set at 50 msec	
AI	Set at 100 msec	
AJ	Set at 200 msec	
AK	Set at 300 msec	
AL	Set at 400 msec	
AM	Set at 500 msec	
AN	Set at 600 msec	
AG	Set indefinitely	



### 30. Quiet Zone Options

With this option the scanner can decode bar codes that have smaller quiet zone margins than specified for the symbology. Be careful when using this option as its use may increase the possibility of partial and ghost reads. Do not use smaller margin checks than necessary. If possible, replace the bar codes labels with others that have the correct quiet zone margins.



Computer Command	Function /Description	Bar Code Command
(ZZ)	START/END Programming Menu	
YN	No margin check	
YO	Margin check 1/7 nominal	
YP	Margin check 2/7 nominal	
YQ	Margin check 3/7 nominal	
YR	Margin check 4/7 nominal	
YS	Margin check 5/7 nominal	
YT	Margin check 6/7 nominal	
YU	Margin check normal	







### 31. Redundant Decoding

The Number of Redundant Decodes determines how many times the scanner must decode a bar code and obtain the same value before it will transmit the data. For example, if the redundancy is set at three times, the scanner will not transmit data until it has completed three consecutive, identical "good reads". In the case of a poor label which generates an intermediate "no decode" within a sequence of four scans where three of the four have resulted in "good reads", the scanner will transmit the data after the fourth scan. In other words, a "no decode" does not restart the sequence.

Computer Command	Function /Description	Bar Code Command
(ZZ)	START/END Programming Menu	
X2	Read bar code three times	
X3	Read bar code four times	



### 32. Transmitting Error Indications

Computer Command	Function /Description	Bar Code Command
(ZZ)	START/END Programming Menu	
WD	Disable ACK/NAK response to sent command	
WC	Enable OK=ACK, ERROR=NAK, response to sent command	



### 33. No read error messages.

The scanner can be programmed to transmit an error message when no barcode is read. The unit must be in trigger mode, then, the error message will be sent at the end of a trigger time out. 2 types of messages can be sent. The first type will indicate that no label was present or that nothing was in front of the scanner. The second type will indicated that a barcode was present but could not be decoded.

To program an error message, scan the appropriate command below then scan up to 4 direct input characters. To remove the error message, scan the appropriate command below but do not scan any direct input characters.

### 33. Programming No read Error Messages

Computer Command	Function /Description	Bar Code Command
(ZZ)	START/END Programming Menu	
TH	Program Error message for No label present.	
TI	Program Error message for label present but not decodable.	

### 34. Good Read LED Operation

Computer Command	Function /Description	Bar Code Command
(ZZ)	START/END Programming Menu	
T4	Good read LED disabled after decode	
T5	Good read LED ON after decode for .20 seconds	
T6	Good read LED ON after decode for .40 seconds	
T7	Good read LED ON after decode for .80 seconds	



## Appendix D:

### Dimensional Drawing (All dimensions in millimeters [inches])

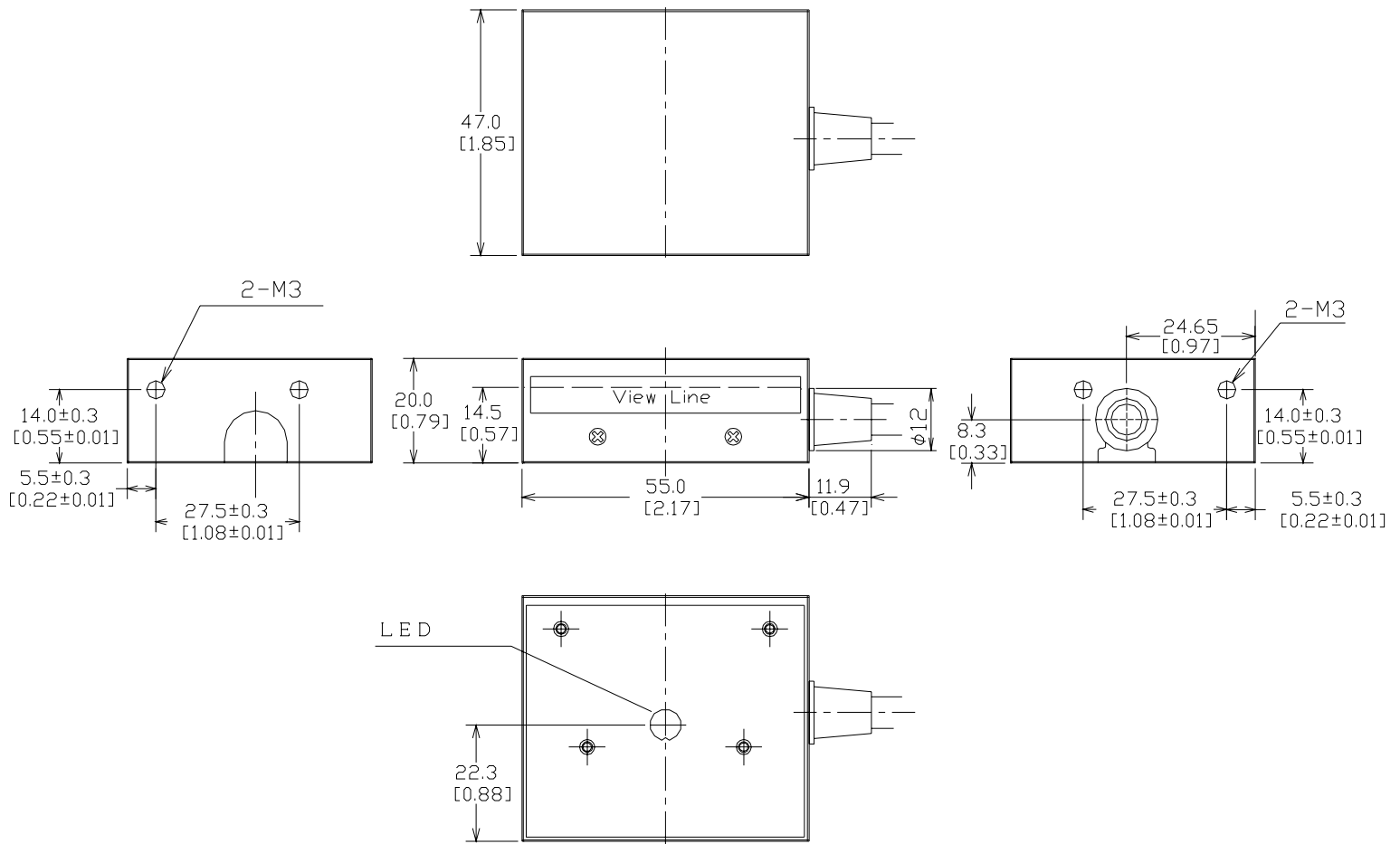

## Appendix E:

NFT 2100 – Optical Performance

### NFT 2100 Depth of Field Table (Grade A Labels)

Density	Min. Distance (inches)	Max Distance (inches)	Range (inches)
6 mil	0.9	1.6	0.7
10 mil	0.8	1.7	0.9
20 mil	0.8	2.0	1.2
40 mil	0.9	2.4	1.5

### NFT 2100 Depth of Field Chart

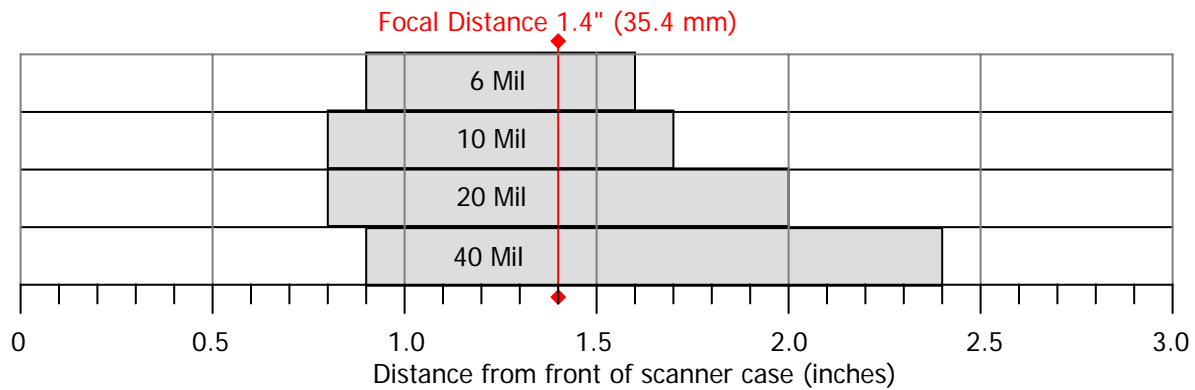

### NFT 2100 Field of View Table

Distance from Front of Case	1.0"	Focal Distance 1.4"	1.5	2.0"	2.5"
	25.4mm	35.4mm	38.1mm	50.8mm	63.5mm
Field of View	2.6	3.1"	3.3	4.0	4.7
	66mm	80mm	83mm	101mm	118mm

## Appendix F:

### Placement Drawing (All dimensions in millimeters [inches])

This Drawing shows one possible placement of the scanner relative to the target label. Other orientations are possible depending on barcode density and barcode length. Please use the optical information provided in appendix E as guidance.

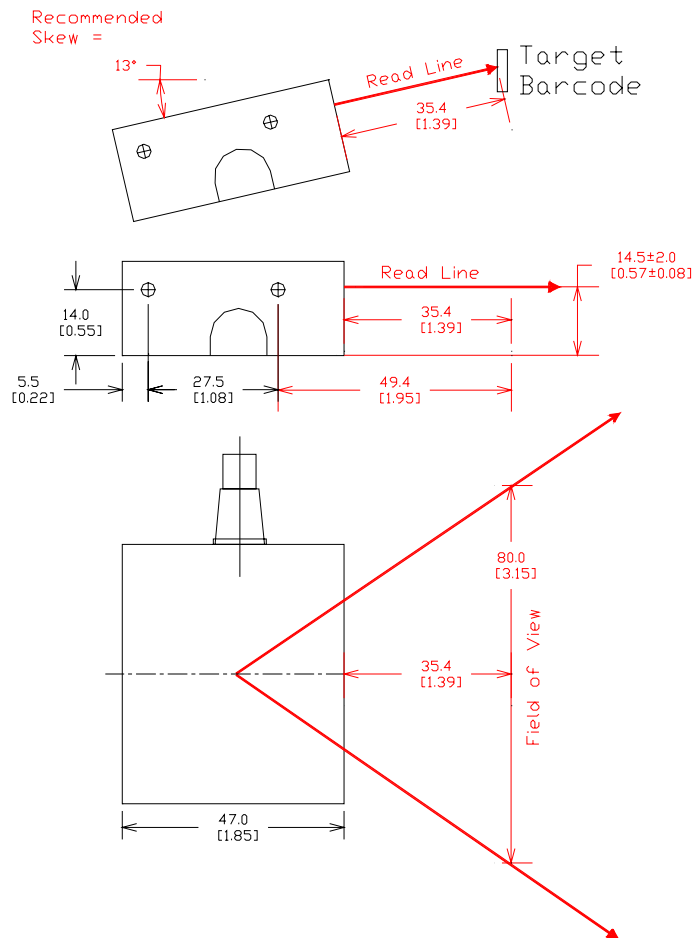

## Appendix G:

### Placement Drawing for test tubes (All dimensions in millimeters [inches])

This Drawing shows one possible placement of the scanner relative to the target label. Other orientations are possible depending on barcode density and barcode length. Please use the optical information provided in appendix E as guidance.

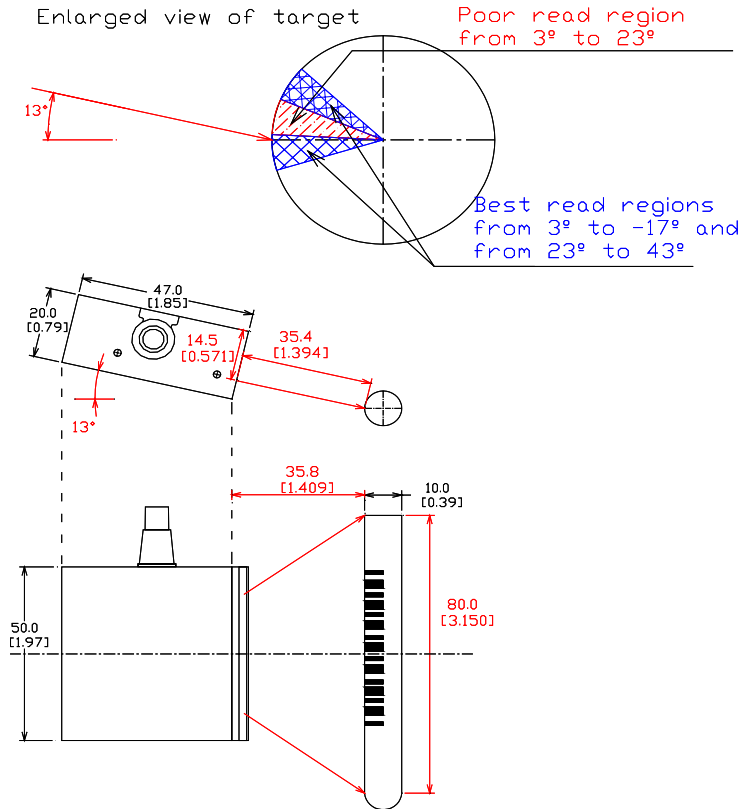

## Notes

## Free Manuals Download Website

<http://myh66.com>

<http://usermanuals.us>

<http://www.somanuals.com>

<http://www.4manuals.cc>

<http://www.manual-lib.com>

<http://www.404manual.com>

<http://www.luxmanual.com>

<http://aubethermostatmanual.com>

Golf course search by state

<http://golfingnear.com>

Email search by domain

<http://emailbydomain.com>

Auto manuals search

<http://auto.somanuals.com>

TV manuals search

<http://tv.somanuals.com>