

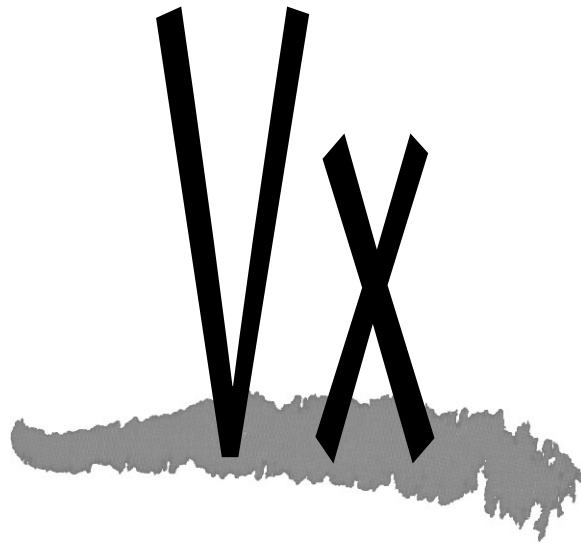

CENTURY SERIES



OWNER'S MANUAL



Congratulations on your purchase of a Century Series console. All of us at Crest Audio in Paramus, New Jersey, USA, support your decision, knowing your console contains the finest combination of design and manufacture in the industry.

While your new Century Series console is one of the most feature-packed available, great effort has been put into making it simple to operate.

This manual explains the functions of your new console, how they operate and how they relate to each other. If properly cared for, your new console will provide you with trouble-free, sonically accurate mixing clear into the next Century and beyond.

















Please keep the following contact information on hand:

Crest Audio Customer Service Dept.
100 Eisenhower Drive
Paramus NJ 07652 USA
TEL 201.909.8700 FAX 201.909.8744
<http://www.crestaudio.com>

Crest Audio Inc.
100 Eisenhower Dr., Paramus NJ 07652 USA
TEL: 201.909.8700 FAX: 201.909.8744
<http://www.crestaudio.com>

Printed in USA

TABLE OF CONTENTS

 Feature Overview	2
A brief description of the Vx design, features and functions.	
 Mixing with VCA's	3
<i>Adapted from "Mixing with VCA's," by Mark Smith, in LIVE SOUND! Magazine.</i>	
 Wiring Conventions	5
Contains diagrams indicating how connectors for Crest consoles are wired.	
 Rear Connections	6
Details the rear panel input and output connections to be made to the Vx console.	
 Power Supply	8
A brief description of the rack-mountable Century Series consoles power supply.	
 Power Connections	9
A brief description of Crest console power connections.	
 Console Cooling	9
A brief description of the dual-fan cooling setup.	
 System Connections	10
Contains diagrams illustrating conventional system connections.	
 Input Module	12
Profiles the Vx input module. The module and rear panel are illustrated, and described.	
 Stereo Input Module	14
Profiles the Vx stereo input module. The module is illustrated, and described.	
 Optional Multi-Input Module	17
Profiles this optional double-module, which provides four stereo inputs, summed together to create a stereo sub-mix.	
 Group Module	19
Profiles the Vx group module. The module is illustrated, and described.	
 Master Section	21
Profiles the Vx master section. The modules are illustrated, and described.	
 Meter Bridge	23
This section profiles the Vx meter bridge. Each type of meter is illustrated and described.	
 Special Facilities	24
This section profiles Vx console expansion and LCR Panning	
 Technical Information	Appendix A
Includes dimensions, specifications, console access details, user options, console block diagram, and rear panel layout.	
 Schematics	Appendix B
Lists available console and power supply schematics.	

Feature Overview

The Century Series has the audio quality, features, and functions demanded by the modern music professional. The Vx is the first Crest Console to use VCA's, includes all of the basic features found in other Century Series consoles and adds an extensive meter bridge and a set of advanced new features to accommodate more demanding applications.

Vx features:

- Mixing flexibility via 8 conventional Audio Groups & 8 VCA Groups, permitting enhanced Mix Integrity, Wet / Dry Blending, and True Post Effect Sends.
- 4 Scene Mutes, designed to mute both pre- and post-fader input channel signals including those Aux sends used as monitors. When muted, PFL circuitry, Peak, Level, and Dynamic Signal Present LED indicators remain fully operational..
- Comprehensive Meter bridge provides signal level metering of LEFT, RIGHT, CENTER/MONO, SOLO LEFT, SOLO RIGHT, and 8 SUBGROUPS. The LEFT, RIGHT, CENTER/MONO and SOLO meters are of a larger size and are centered on the meter bridge. For 64 and 52 positions frames sizes only, metering is also provided for the 8 AUX SENDS. All level meters are of the mechanical moving coil type, are referenced to +4 dBu, and are illuminated by long-life LED's.
- 8 Matrix Outputs Standard, useful for the creation of independent mixes using the main outputs and External Input as signal sources.
- Discreet bus assignments and L-C-R (Left-Center-Right) panning. Input channels and Effects Returns incorporate an uncompromised bus assignment section. Features include true L-C-R panning, standard panning, clean mono bus, discrete bus assigns, and panable stereo bus assigns.
- 8 Discrete Aux Sends, each with On/Off Control & Status LED.
- Variable Hi-Pass filter on input channels allows for precise control over a signal's unwanted low frequency content.
- Channel inserts are implemented using separate 1/4" TRS jacks for send and return. An insert switch with indicator LED allows A/B comparisons and signal processor bypass.
- Switchable Q on Hi Mid and Lo Mid EQ bands adds more flexibility to an EQ circuit that already offers four sweepable bands and selectable peak/shelving on the Hi and Lo bands.
- Each input channel features a five-segment LED array, including a signal present LED, three signal level LEDs and a peak indicator.
- SSM/PMI high-quality preamplifiers on balanced microphone/line inputs for uncompromised audio quality and reliability. All IC's within the audio path are socket mounted for easy upgrade or service.
- 48 Volt switchable phantom power on all microphone inputs.
- Optional transformers available on all microphone inputs and on Group, Left/Right, Mono, Aux, and Matrix outputs.

- Full function SOLO monitoring system with dedicated level meters. User choice of PFL or AFL from any source, both in stereo where appropriate.
- Standard frame sizes include 32, 44, 52, and 64 positions. (20, 32, 40, and 52 inputs respectively). The Master section occupies four positions and Groups occupy eight positions.
- Any frame size may be ordered short loaded for later expansion.
- Direct access to Group Mix buses allows expander mixers to be easily patched into the console.
- Majority of audio Inputs and Outputs balanced on XLR connectors.
- Twin power supply capability with automatic changeover backup for uncompromised reliability. Second power supply optional.
- Optional Stereo Input modules available, useful for remote feeds, effects returns, and other mic or line level signals requiring stereo handling.
- Comprehensive Talkback section allows access to all primary console outputs. Additional access provided to an external location such as an on-stage monitor mixer system. External signals can also be assigned into the talkback system including Oscillator and Pink Noise source inputs.

Mixing with VCA's (adapted from Live Sound! magazine)

An introduction to VCA's

A VCA (voltage controlled amplifier) uses a DC control voltage to attenuate or boost an audio signal. *The VCA DOES NOT have Audio signal present in the fader.* The fader only controls the amount of voltage (level) an input can have to a mix buss or summing amp. To get the input back out of the console, the input needs to be assigned to the Stereo Mix Buss or an Audio Group. Assigning a fader only to a VCA will not allow an input to get out of the console.

Audio Submasters DO have audio signal present in the fader. All inputs assigned to an Audio Submaster are summed, and are useful as line-level returns and sends, and group processing. Audio Submasters are especially useful as effects returns when inputs have been exhausted.

Mix Integrity

VCA's are useful when a mix must be brought up or down without changing the relationship between Subgroups. Depicted below is a typical mix in Mono, with the Audio Subgroups configured as follows:

1-DRUMS	2-PERCUSSION
3-GUITAR	4-BASS
5-KEYS	6-EFFECTS
7-BACKRND VOCALS	8-LEAD VOCAL

Although a suitable mix has been obtained during soundcheck, during the performance the band turns up their level about +10db, and everything will need to be turned down quickly. Typically, the engineer would bring down the master or grab all 8 group faders with both hands and pull everything down. A quick listen, and a look at the relative levels of the Audio Submasters will indicate that the mix has been compromised, and the integrity of the mix will need to be restored.

This all can be easily handled with VCA's. With inputs assigned to VCA's, the entire band mix can be turned up or down with 1 fader. The relationship between the VCA Groups (the 'mix' or the 'blend') will remain the same, without physically moving the Subgroups, and will remain exactly the same at all levels. All that is needed is to move a "Band Master" VCA.

To accomplish this, inputs would be assigned to VCA Groups. The same basic Subgroup assignments shown previously would be used in the Audio Subgroups, but with 2 major differences:

- A) Group #8 is labeled BAND MASTER;
- B) the Lead Vocal is assigned directly to the LEFT & RIGHT MASTERS, and is not assigned to a Group.

The levels of all VCA Subgroups would be set at "0dB" (nominal). This is because "0dB" is where VCA's operate best. It is the "Unity" position. (Indicated by the "Unity" LED).

A stereo mix can be obtained immediately, because the inputs can be assigned directly to the STEREO MASTER. In addition, all "band" input faders must be DOUBLE ASSIGNED to 2 VCA Subgroups. In other words, all Band inputs assigned to

VCA Subgroups 1 thru 5, (not 6 or 7, and you'll see why later) also need to be assigned to VCA Subgroup 8.

What this enables is control over VCA Subgroups 1 thru 5 by using VCA Subgroup 8 as the Band Master. Once set, the entire blend (band mix) can be brought up or down by moving only VCA 8. "Mix Integrity" is now possible. Some term this as 'poor man's automation', because any input assigned to VCA subgroup 8 will electronically "move" as if the faders had been physically moved.

Note that any inputs assigned to two (2) VCA Subgroups are controlled by BOTH VCA Subgroups.

True Post Effect Sends

This section will examine what happens to the effect (Aux) sends when the Audio Subgroups are used as in the example above. In this example, Aux 1 is used for the Main Reverb, Aux 2 for Drum Reverb and Aux 3 for the Delay. A Drum Solo will be employed for the example here. The effects are in Audio Group 6, making it possible to pull the effects down between songs, or if the wet / dry balance needs to be changed.

The band is cooperating at this point and the Audio Submasters are back to the starting point. The drummer is about to take a big solo for the night, and it will be necessary to turn Audio Subgroup 1 up 10dB. At this point, one of two things must be done:

- 1) Turn up Subgroup #6 10db also to keep the reverb at the same relation it was to the "DRY" drum sound before it was turned up; OR
- 2) Turn up all Aux sends on the drum inputs 10dB (not desirable); OR
- 3) Turn up all Drum inputs 10dB on the input faders.

The reason that one of these options must be chosen is because effects busses (aux busses) do not and will never increase or decrease in level when an Audio Submaster is turned up or down. This alone is the most critical aspect of why Audio Submasters are not acceptable for controlling a mix. What has been described here is a drum solo situation; imagine the problems encountered when adding the other Submasters!

A common solution used when using Audio Submasters is to mix on the input faders. This way all effects will "follow" the moves made on the faders in direct proportion. Although it is a painful way to mix, some engineers will always mix on the input faders.

(continued on page 8)

One of the major benefits of VCA's is that any move made on a VCA Subgroup will cause all inputs assigned to that Subgroup to move in direct proportion with it. Inherently, all effects assigned (or turned up) on any input modules that are controlled with VCA's will "follow" any moves made in the exact proportion also. If a subgroup is moved "3db"; then all effects will move "3db". The wet/dry blend always remains the same.

Wet / Dry Blending

The word "blend", is used to describe the relationship between the dry "mix" (all inputs minus the effects) and the wet "mix" (all the effect returns).

There is no such thing as Wet/Dry Blending when using Audio Submasters, unless mixing is done on the inputs. Any time an Audio Subgroup is moved the wet/dry blend is destroyed, as there is no Mix Integrity or True Post Effect Sends. The only true way to change the wet/dry blend would be to adjust the Master Output on any effect send. This is also an undesirable way to adjust a mix.

With VCA's assigned as in the previous example, it is a simple task to adjust the balance between the 'dry' and the 'wet' by simply moving VCA Subgroup 6. Any moves made with the Band Master VCA (Subgroup 8) will cause everything will follow in direct proportion. The same is true for the background vocal mix (on VCA Group 7). If VCA Group 7 is moved up or down, all reverbs and delays turned up on all background vocal inputs will remain in the exact proportion you have established. Therefore, once a wet/dry blend is established, it can never be changed by moving VCA groups.

Now it is possible to mix with 4 faders, or if you will, 4 VCA's: Lead Vocal, Background Vocals, Band and Effects. Of course, there will always be small adjustments that need to be made on the input faders from time to time to tweak a mix.

It has been suggested that when attempting to mix on VCA's for the first time, the operator turn off the sound system and monitor with headphones. All the subtle nuances achieved can then be heard, and the ability to easily control a mix will become obvious. C

This "VCA Mixing" section was adapted from an article entitled "Mixing with VCA's," written by Mark Smith, which appeared in LIVE SOUND! Magazine.

*Anthony McLean is the editor of LIVE SOUND!
You can contact him by Fax at (913) 677.6621,
by e-mail at CIS 75300,3141 or by
snail-mail at:*

*LIVE SOUND! Magazine
4741 Central #222
Country Club Plaza
Kansas City, MO 64412-1533
U.S.A.*

Wiring Conventions

Crest consoles are wired with connectors that are used throughout the professional audio industry. Wiring is as follows:

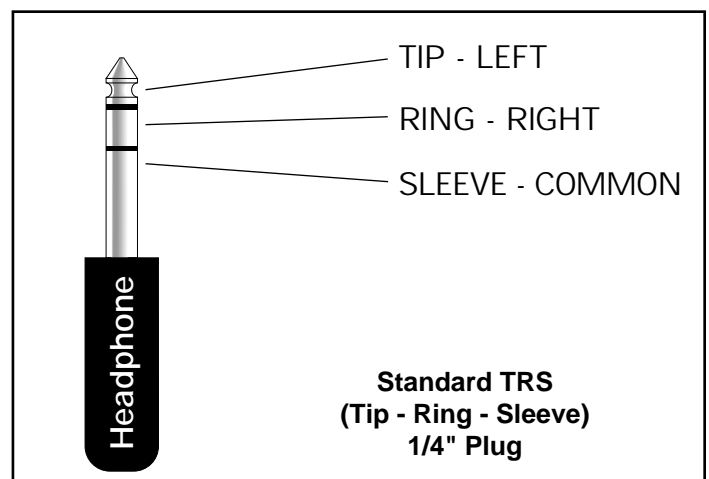
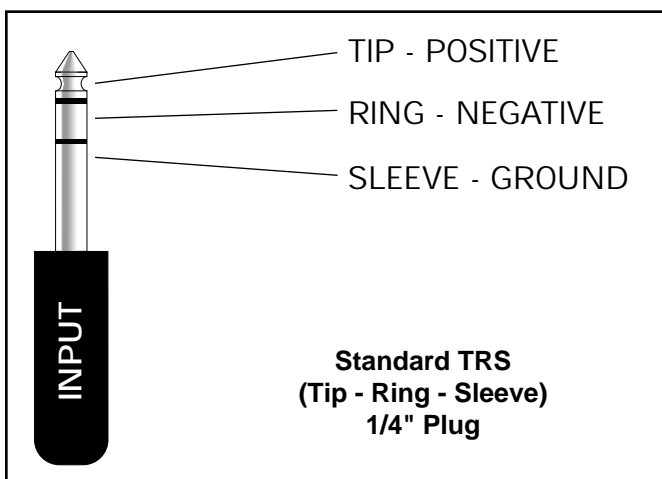
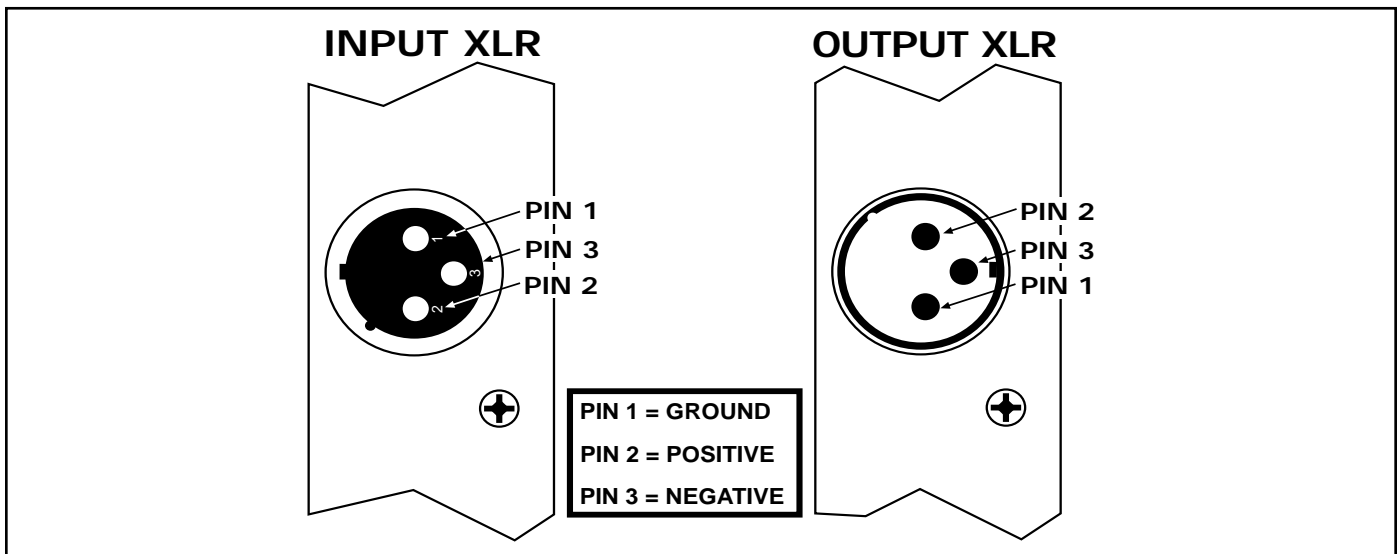

Connections: Bal Input, Bal Output, Direct Out, Insert Send, Bal Insert Return, Tape In

Connector: Headphone Output

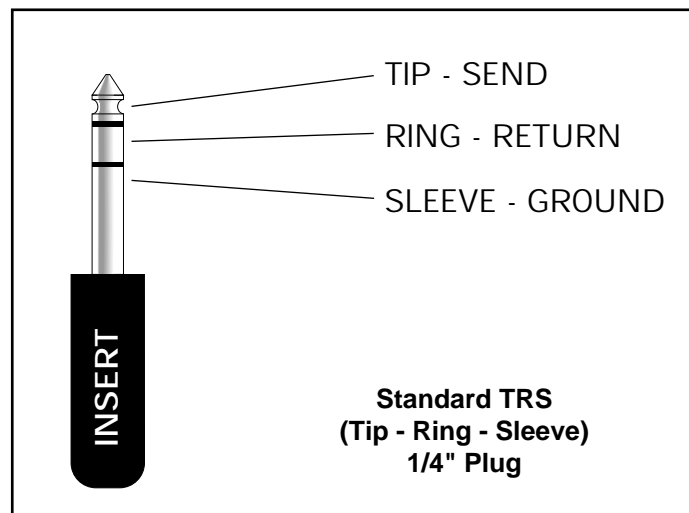

Connector: Stereo Input Module Insert L, Insert R

Rear Connections

The rear connections facilitate the numerous inputs and outputs necessary for successful mixing. Since the console is of little use until it is wired into a whole system, an understanding of what each input and output does is necessary before it can be properly connected. Use the descriptions and diagrams on the next two pages to plan your cabling scheme.

Levels

Unless specified, nominal levels are:

0 VU = +4dBu = 1.23V RMS

Max Level = +28 dBu balanced, +22dBu unbalanced

Impedances

Mic In - 4kΩ

Line In - greater than 10kΩ

Outputs -140Ω

Input Module Connections

Direct Out

This unbalanced 1/4" TRS jack delivers the direct output signal (post fader & post mute) from the associated input channel.

Insert Send

This unbalanced 1/4" TRS jack is used for sending a post-input preamp, post Hi Pass Filter, pre-EQ signal to an outboard processor. The signal at this jack is unbalanced and always active regardless of the Insert Switch setting.

Bal Insert Return

This balanced 1/4" TRS jack receives its signal from an outboard processor. It can also be used to bring a signal into the channel, bypassing the input preamp and gain circuit. The return input is balanced and must be enabled by depressing the channel Insert switch.

Bal Line In

This balanced 1/4" TRS jack accepts a balanced or unbalanced line level input, and delivers it to the input selector switch.

Mic In

This female XLR connector accepts balanced microphone inputs for the associated input channel.

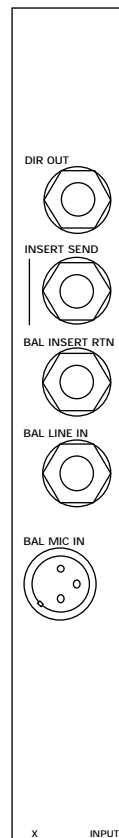

Stereo Input Module

Insert L / Insert R

These 'combined send & return' female TRS jacks are used to insert effects or signal processing into the Left and Right channels of the Stereo Input module. They can also be used to bring a signal into the channel, bypassing the input pre-amp and gain circuit. The return input is enabled by depressing the channel Insert switch.

Bal Line In L / Bal Line In R

These balanced 1/4" TRS jacks accept balanced or unbalanced line level inputs, and delivers them into the associated (Left or Right) selector switch.

Bal Mic In L / Bal Mic in R

These female XLR connectors accept balanced microphone inputs, and deliver them into the associated (Left or Right) selector switch.

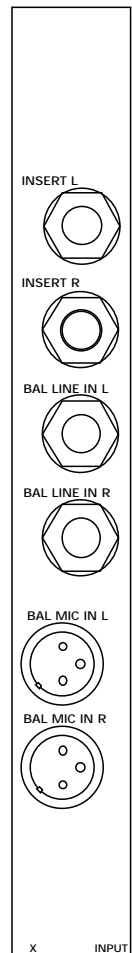

Group Module

Group Bal Out

This male XLR jack carries the post-fader output signal from the associated group module.

Group Ins Send

This balanced 1/4" TRS jack allows for the group signal to be sent to an effect or signal processor.

Bal Ins Return

This balanced 1/4" TRS jack allows for the return of the effected and/or processed group signal back into the associated group.

Bus In

This female XLR connector delivers the connected signal directly to the associated group bus. (Useful for connection of expander mixers)

Matrix Out

This male XLR connector delivers a balanced signal from the associated matrix.

Matrix Ext In

This balanced female XLR connector is designed to accept an external signal that is inserted into the Matrix. This level is controlled by the Matrix Ext Level control.

Aux In A/B Left/Right

These female XLR jacks (on group modules 5-8) accept signals controlled by the Stereo Aux in section (L & R Master Modules).

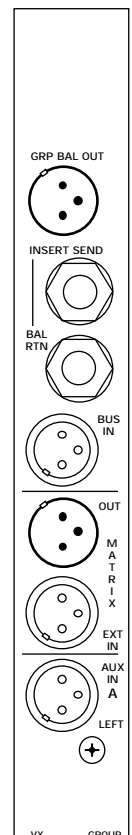

Master Module Connections

Left/Right Bal Out

This male XLR jack delivers a balanced post-fader signal containing all signals assigned to the left and right outputs.

Mono Bal Out

This male XLR jack delivers a balanced post-fader signal containing all signals assigned to the Mono clean bus.

Ext. Talkback Out

This male XLR jack provides an external balanced signal from the selected talkback source.

Insert Send

These balanced 1/4" TRS jacks allow for the right, left, or mono signal to be sent to an effect or signal processor.

Bal Rtn

These balanced 1/4" TRS jacks allow for the return of the effected and/or processed group signal back into the right, left, or mono module.

Ext. Talkback In

This female XLR connector accepts a balanced signal which is assignable to any of the locations in the talkback system.

L - TAPE IN - R

When no plugs are inserted into these balanced 1/4" TRS jacks, the L - STR PGM - R signal is present. This stereo input is controlled by the Tape In section in the Master module.

L - STR PGM - R

These jacks accept external balanced stereo line level signals (Left and Right). This stereo input is controlled by the Stereo Program section in the Master module.

Aux 1-8 Outputs

These eight connections provide the balanced output signals from their respective auxiliary buses.

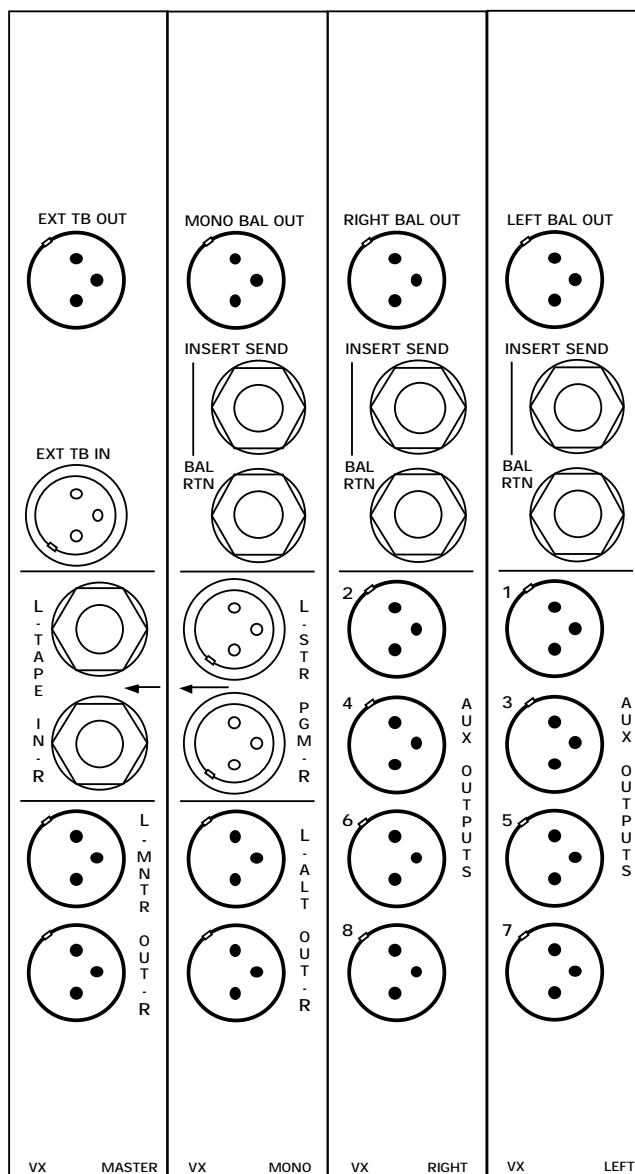

L - ALT OUT - R

These male XLR jacks provide an additional output point for the Left and Right bus signals. This stereo output is controlled by the Alt L/R Out section in the Master module.

L - MNTR OUT - R

These male XLR jacks provide a stereo monitor output, controlled by the Monitor Out section in the Master module.

Century Series Console Power Supply

Century Series consoles use a separate rack-mountable power supply which provides the specific voltages used by each console. Crest Consoles' Century Series makes use of two different power supplies. All chassis sizes (32, 44, 52, 64) of the the model Vx console should only be used with the Model XCVA06 Power Supply.

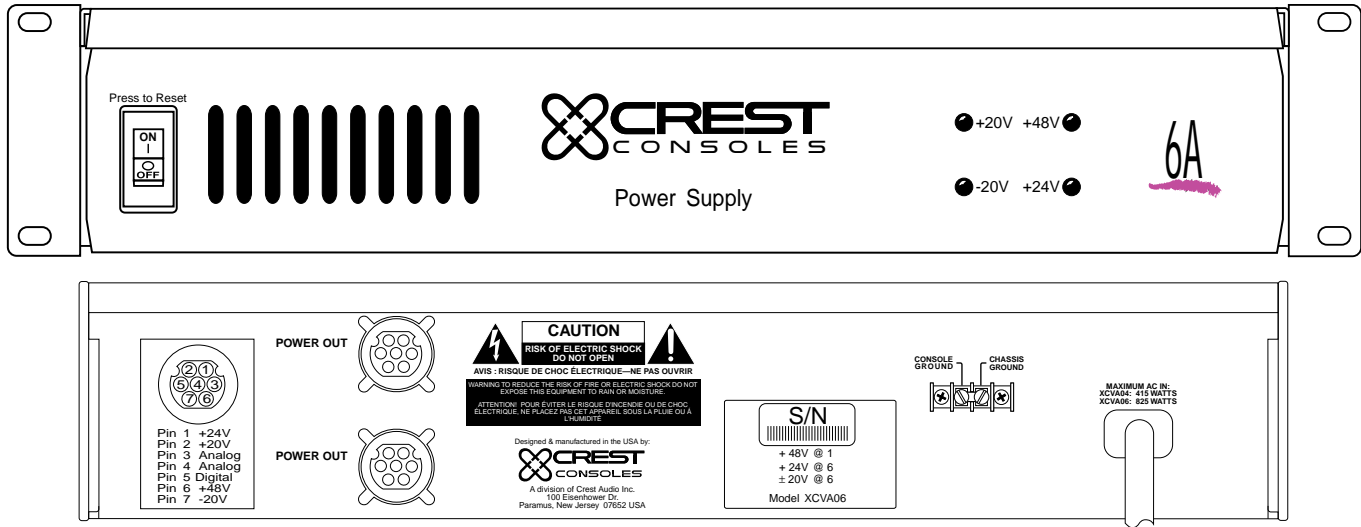

Supply Identification

The type of power supply can be identified by the model number shown on the back of the chassis and panel label.

Power Requirements

The Century Series power supplies have certain electrical requirements to operate properly. If possible the power supply should be connected to a dedicated circuit. Should any other appliance on the same circuit draw enough current to overload the circuit, the breaker or fuse will trip causing loss of power to the console. Note the maximum current draw specifications at right. Be sure that the circuit to which you connect the supply can handle the draw.

The power switch on the supply front panel is also a circuit breaker, there is no power fuse. Should the supply ever shut down, or trip at start up, simply push the switch to the off position and then on again.

Ground Linking



Safety Considerations - Each new power supply is shipped with the AC third wire ground connected to the console chassis ground. The connection is made at the rear of the power supply unit. This is necessary for safety reasons so that exposed metal parts are grounded. In the event of a live conductor making contact with the console chassis or the power supply chassis then the current will flow to ground without a safety hazard arising. Note that when the console is disconnected from the power supply the chassis ground connection to AC third wire ground is broken and safety protection is lost. For uninterruptible grounding, in a fixed installation for example, make a connection directly to the console chassis from the safety ground. Disconnect the ground link on the rear of the power supply. This disconnects console ground from power supply AC third wire ground which would otherwise create a hum-loop.

Twin Supply Operation

When twin supplies are in use for automatic back-up, then the ground links on both supplies should be fitted.

In a situation where the safety ground to the console chassis has been connected and the ground path via the power supply is causing a hum-loop, then disconnect the ground links on BOTH power supplies.

Console and Power Supply Grounding

Console chassis ground is electrically connected to audio ground, pin 1 of XLR connectors and 1/4" sockets and to the terminal 'CONSOLE GROUND' at the rear of the power supply. The AC third wire connection in the power supply cable connects the metal chassis of the power supply to safety ground. This connection should never be disturbed. Hazardous voltages exist inside the power supply which require the case to be grounded. When rack-mounted, the power supply ground may transfer to the rack case thru the front fixing screws, though this connection is not reliable. When a console is configured within a complete sound system the grounding requirements may call for the ground link to be disconnected. This is permissible only when an alternative ground path has been provided. If in doubt seek the advice of an experienced electrical engineer.

Power Supply Model	Max Current Draw @ 120V	Max Current Draw @ 240V
XCVA06	9 Amps	5 Amps

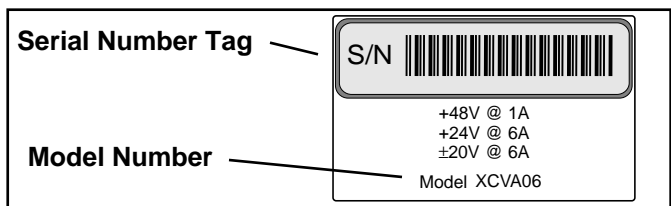

Power Connections

Before setting up the console, always check to make sure the AC voltage marked on the power supply agrees with the local supply. Always connect the console to the power supply before switching on the power supply.

Multiple power supplies can be daisy-chained to provide fail-safe protection in the event of a supply failure. When two or more supplies are used, both power supplies run all the time. In the event of supply failure, the remaining power supply(s) will take over the entire load.

NOTE: Although both of the multi-pin connectors on the back of the power supply are labeled “POWER OUT”, it is necessary (and acceptable) to link two power supplies together as shown in the diagram below.

ADDITIONAL NOTE: The multi-conductor cable used for power supply-to-power supply connection is different than that used for a conventional power supply-to-console connection, and must be specified when the second power supply is ordered.

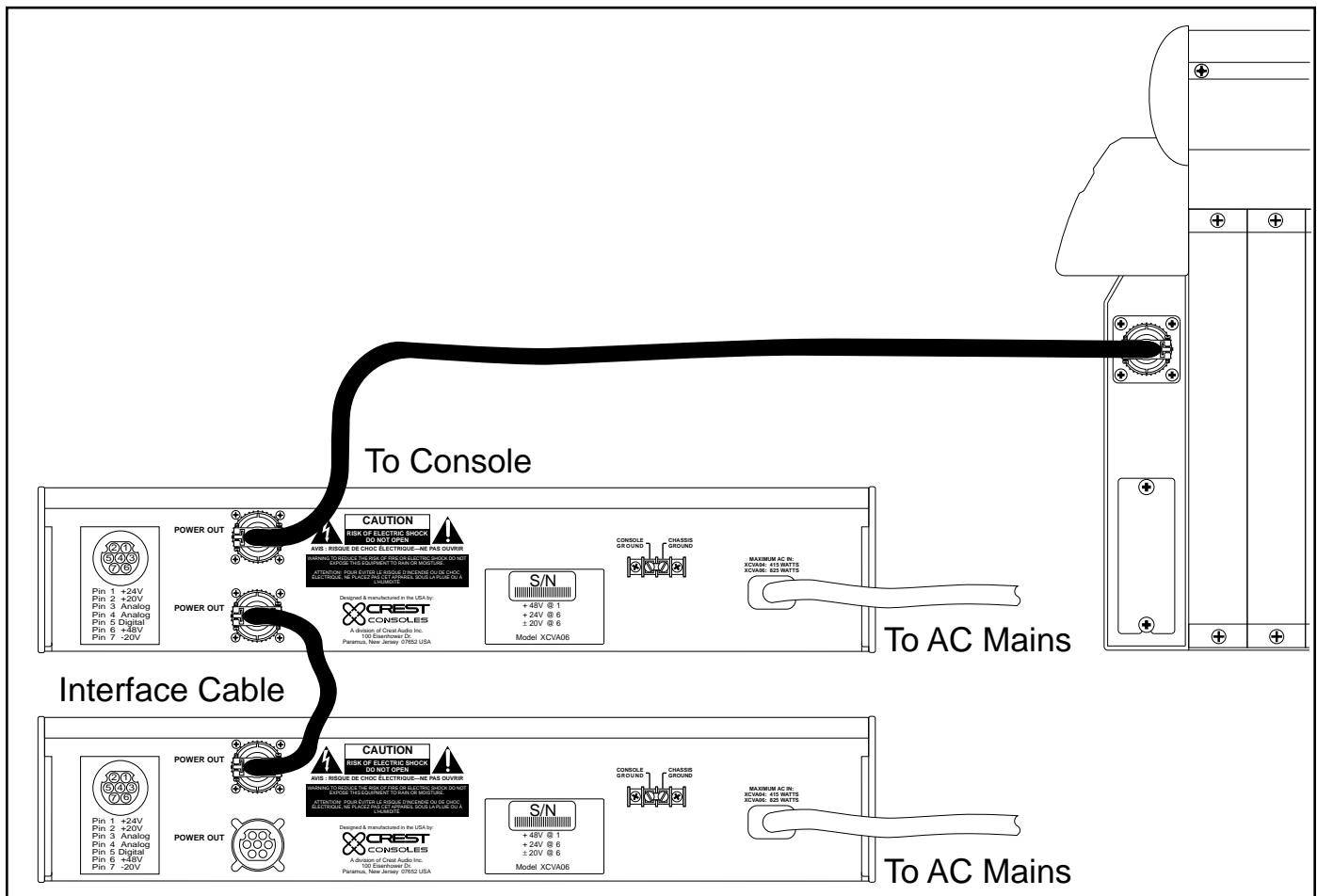

Console Cooling

A dual-fan cooling configuration is included in all Vx consoles. Two fans (one at each end of the console) draw air in through the sides of the chassis (under the sidebars). Air is distributed through the chassis via a “vortex pan”, then proceeds up through the console modules, where the heated air exits the console chassis.

Once the console is powered up, cooling fans remain on. A rear panel switch permits the fans to be set at low, medium or high speeds.

There are no filters to change or clean. As with any console, use in dusty/unclean environments should be avoided.

System Connections

The console is the hub of a sound system. Because it controls most of the variables within a system, proper connection and component relationships are vital to assure accurate operation and results. The following diagrams illustrate conventional system connections.

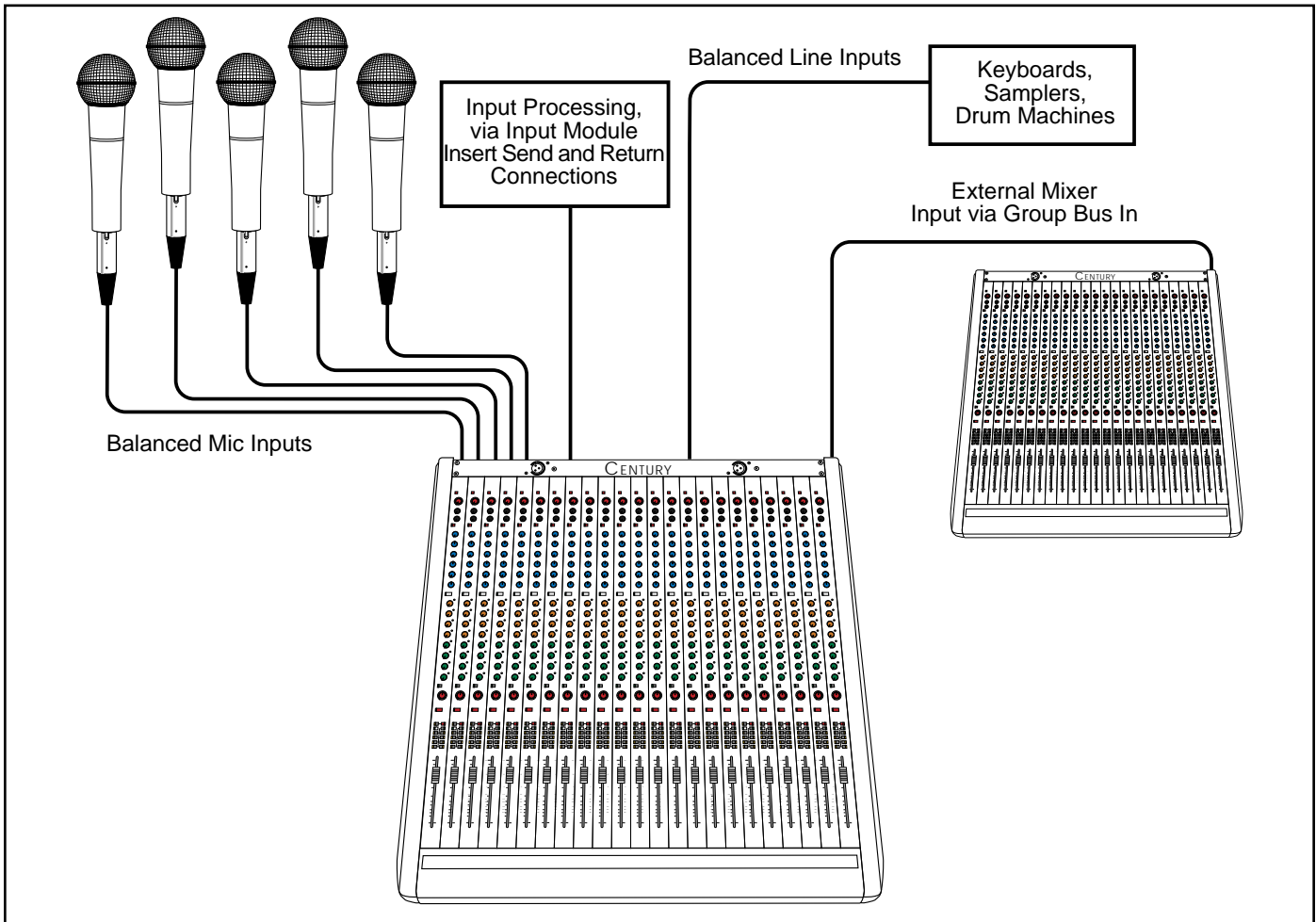

Input Connections

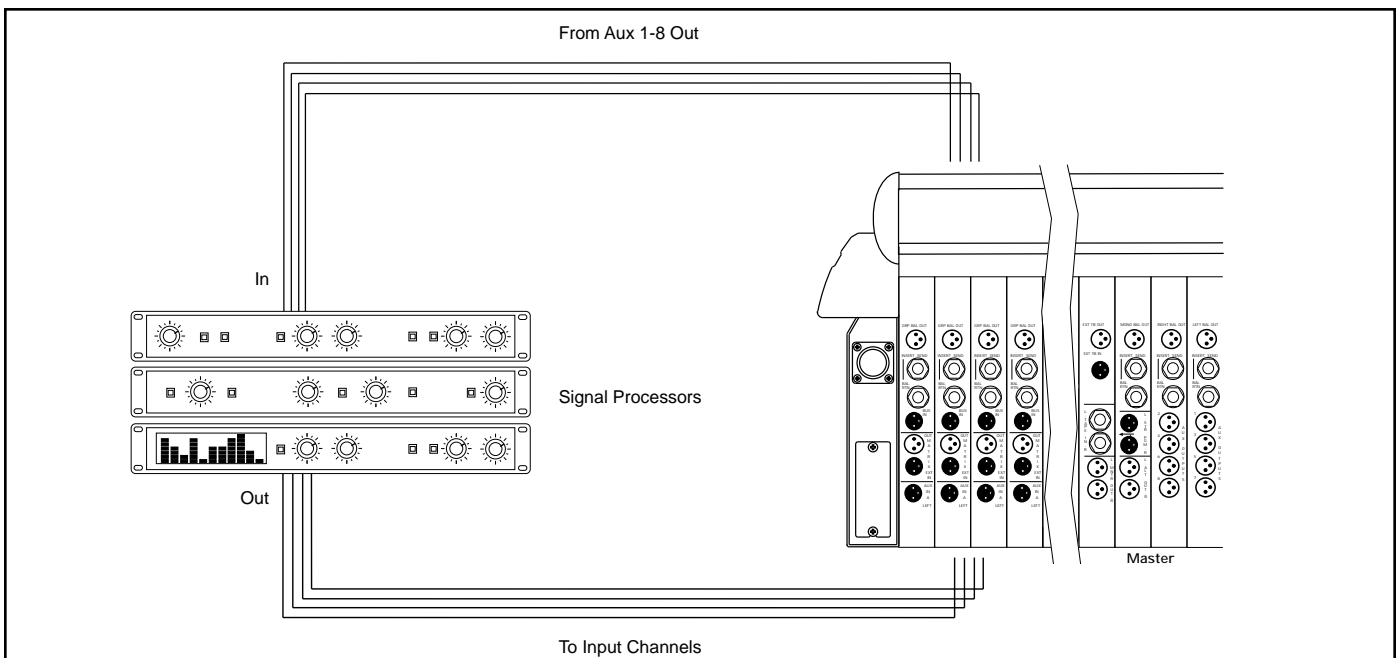

Aux Connections

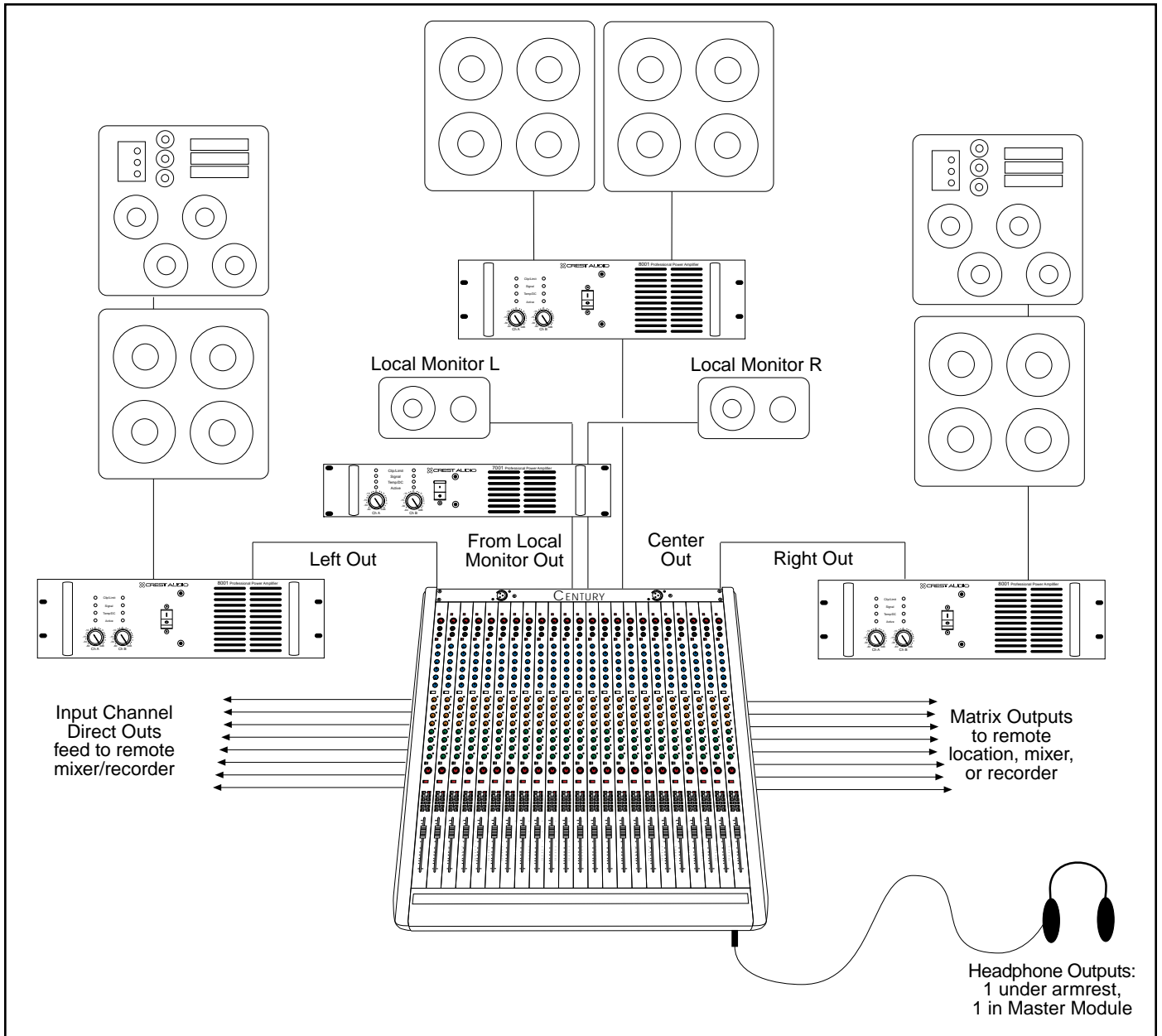

Output Connections

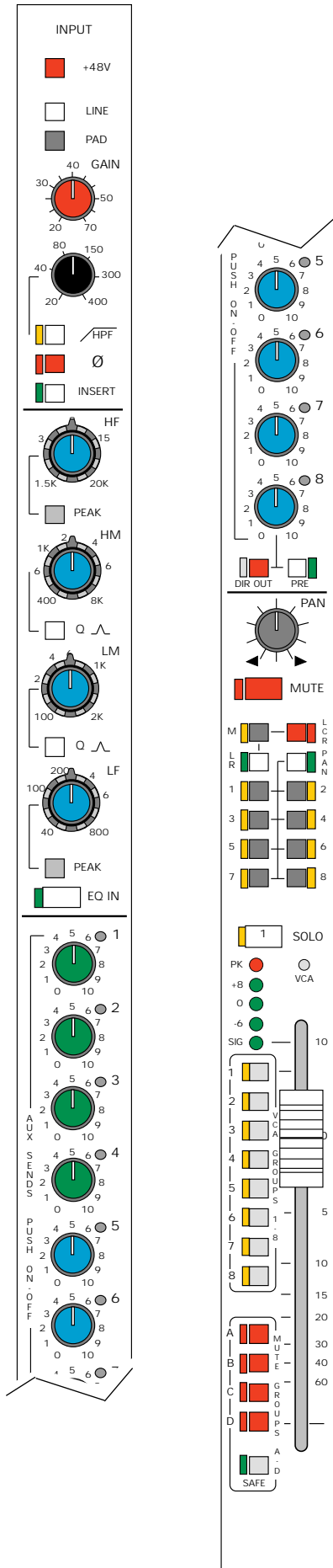

Vx Input Module

The input module is the main method by which input signals are brought into the console. The Vx input module takes the new features introduced with the GTx console and adds a more flexible Aux send/assignment Section and extensive VCA (Voltage Controlled Amplifier) functionality.

48V Phantom Power Switch

Applies 48 Volts DC to pins 2 & 3 of the microphone input XLR jack for microphones requiring phantom power. The XLR input is balanced and accepts high quality microphones, DI boxes and line sources.

LINE Switch

Switches between the balanced female XLR microphone Input connector and the balanced Line Input 1/4" TRS connector.

PAD Switch

Introduces a -15 dB attenuation to the mic input signal, useful when handling high-level signals.

GAIN Control

Adjusts input gain for proper signal level. Maximum gain is 70 dB.

Adjustable High Pass Filter w/LED

Reduces all low frequency content at a -12dB per octave rate adjustable from 20 to 400 Hz (-3dB point). Yellow LED illuminates when switch is down.

Polarity Reverse Switch w/LED

Inverts the polarity of both the microphone and line inputs. The red LED illuminates when switch is down.

INSERT Switch w/LED

Activates the send-return insertion point. The send is always on. Audio from the return is switched into the channel when the switch is pressed.

Four-Band Sweep Equalizer Controls

There are two knobs for each of the four bands. The inner knob controls the boost or cut (15 dB); the outer knob controls the center frequency. Center frequencies are indicated around the outer knob.

PEAK/SHELF HF Switch

Used for switching the high frequency EQ between the normal shelving setting to a peak setting.

SWITCHABLE Q on HI MID and LO MID EQ

Q is switchable between .8 (switch up) and 1.8 (switch down).

PEAK/SHELF LF Switch

Used for switching the low frequency EQ between the normal shelving setting to a peak setting.

EQ IN Switch w/LED

Inserts the EQ section into the input channel (post insert, pre fader). An associated green LED illuminates when the switch is down.

AUX SENDS 1- 8 Individual Level Controls

These Push-On/Push Off pots adjust signal level sent to respective Aux buses. Pushing the switch down turns the send on or off. An associated two color LED indicates status: OFF indicates an 'off' state; GREEN indicates the Aux send is on, and not muted; RED indicates the Aux send is on, but muted. The signal source for these mixes may be selected (by Aux bus) to be pre or post fader by the GLOBAL switches located in the Vx Master section.

Aux 8 DIR OUT Switch w/LED

Removes the Aux 8 signal from the Aux 8 bus, and assigns the signal to the direct out 1/4" connector on the rear panel, instead of the normal post fader Dir Out signal.

AUX 8 PRE Switch w/LED

Switches the Aux 8 signal source between pre and post-fader.

PAN CONTROL

Positions the channel image between left and right or between left-center-right; operates with groups when pan switch is selected. (See L-C-R Switch).

In LCR mode, continuous variation is available between full level to left only (pan full counter-clockwise position) full level to right only (pan full clockwise) and center position (full level to mono/center, no output to left or right).

MUTE Switch w/LED

Turns off the channel audio to outputs. LED on = audio off. Both pre and post fader audio is muted. When pre-fader sends should not mute refer to USER OPTIONS. MUTE responds to the local switch, the Mute Groups, and VCA Group Mute (internal user option).

MONO Bus Assign Switch

Assigns the input signal to the Center / Mono bus. If L-C-R is selected then PAN adjustment will be effective.

L-C-R Switch

Changes the PAN function from normal L-R to L-C-R operation. The mix to the L,R & Mono buses is adjustable with L-C-R PAN. Refer to Special facilities for more information.

PAN Switch / Group Assign Switches (1-8) w/LED's

Group assign switches route the post-fader signal to the Group buses. PAN does not adjust these outputs unless the PAN switch is selected. Then the L & R sides of the control correspond to Odd and Even Group bus numbers.

SOLO Switch w/LED

Operator monitor facility, switches channel audio into the headphones and Solo Meters. Choice of PFL or AFL is made in the center master section. AFL is after fader, after Pan pot, and after mute.

5-Segment LED Array

Dedicated channel level meter connected pre-fader, post EQ (post fader option, refer to User Options). Top red Peak LED responds to audio levels pre EQ, post EQ and post-fader. Normal indication is green on, red flashing only on loud peaks.

Fader

100mm linear VCA level control, adjusts the level to all 'POST' fader outputs, ie auxiliaries 1-8 selected post, AFL, Group assigns 1-8, L, R & Mono output mixes. Local fader movements combine with movements of any VCA Group faders the channel is assigned to. The change in audio level is the sum of the two. If the Group fader is closed no local movements will be heard. If the Group is at -5, local fader settings will be reduced 5dB. Refer also to Expansion and muting.

VCA Group 1-8 selectors

Assign the channel to the VCA group control buses. Puts the channel audio level under the (remote) control of the VCA Group fader along with other channels assigned to the same group. Independent of the Group Audio Assign section above.

VCA LED

Indicates VCA gain (i.e., gain of fader stage) via a two-color LED. Indications are as follows: Green - intensity indicates gain status (gain of fader stage). Red - indicates maximum VCA gain has been reached, approximately 15dB. When the gain LED is red then further requests for increased level, by moving the channel fader or the VCA Group fader up, will produce no response.

Mute Group selectors A-D

Assign input channels to any of the four Scene Mute groups. Mute response occurs only when the group Master has been activated.

Mute Groups Safe Switch w/LED

Bypasses the selected Scene Mute assignments. No Scene Mutes can occur. An associated green LED indicates the channel is in a SAFE (isolated) state.

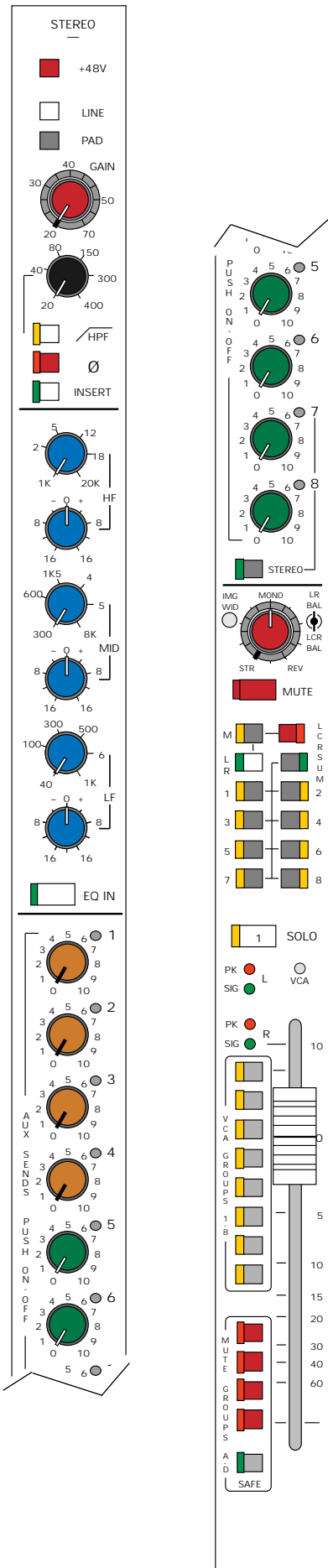

Vx Stereo Input Module

The Vx Stereo Input module is essentially two Vx Input modules packaged to fit into a one-module space. This module is very useful for accepting remote feeds, effects outputs and other signals that require stereo handling.

48V Phantom Power Switch

Applies 48 Volts DC to pins 2 & 3 of the both L and R XLR inputs, for microphones requiring phantom power.

LINE Switch

Switches between the balanced XLR Microphone Input connector and the balanced Line Input 1/4" TRS connector for both L and R channels.

PAD Switch

Introduces a -20 dB attenuation to the mic input signal for both L and R XLR inputs.

L GAIN & R GAIN Controls

These concentric controls adjust input gain for proper signal level for both Left and Right inputs. Maximum gain is 70 dB. Inner knob is for L GAIN, outer knob is for R GAIN.

Adjustable High Pass Filter w/LED

For both Left and Right inputs, reduces all low frequency content at a -12db per octave rate adjustable from 20 to 400 Hz (-3db point). Yellow LED illuminates when switch is down.

Polarity Reverse Switch w/LED

For L&R channels, inverts the polarity of both the microphone and line inputs. An internal jumper selects between Left channel only or both Left & Right channels (default). When this switch is pushed, an associated LED lights.

INSERT Switch w/LED

Activates the insertion point. The send is always on. Audio from the return is switched into the channel when the switch is pressed.

Three-Band Sweep Equalizer Controls

The equalization controls in this module act upon both L and R stereo channels at once. All three EQ bands are set up as sweep EQ's: the lower knob controls the boost or cut (16 dB); while the upper knob controls the center frequency adjusted by the lower knob. Center frequencies are indicated around the upper knob.

EQ IN Switch w/LED

Inserts the EQ section into both L and R input channel signals at once. An associated green LED illuminates when the switch is down.

AUX SENDS 1- 8 indiv. level controls

The Aux Individual Level Controls send a summed (L+R) signal to the AUX outputs. These Push-On/Push Off pots adjust signal level sent to respective Aux buses. Pushing the switch down turns the send on or off. An associated two color LED indicates status: OFF indicates an 'off' state; GREEN indicates the Aux send is on, and not muted; RED indicates the Aux send is on, but muted. The signal source for these mixes may be selected (by Aux bus) to be pre or post fader by GLOBAL switches located in the Vx Master section.

STEREO Switch w/LED

Like the AUX 1-6 controls, AUX 7&8 Individual Level Controls normally send a summed (L+R) signal to the AUX outputs. When the STEREO switch is depressed, AUX 7 and 8 become a send 'left' and 'right' send respectively. This can be used for a stereo effects send.

WIDTH Control / Balance

Dual concentric control pair. Outer control sets image width for the outputs to L, R and Mono. The outputs to Group buses are not affected by Image Width.

STR = normal stereo

MONO = summed L&R in both channels

REV = mirror image of normal

Inner control 'Balance' adjusts image position, extreme L and extreme R setting attenuate the opposite sides about 20dB. When LCR is selected, the Balance control changes function.

Fully clockwise = full level to center, no signal to L&R

Fully counter-clockwise = full level to L&R, none to center

50% rotation = equal levels to L, R & Center outputs.

SUM

combines L&R audio into a mono mix for the assigns to group mixes only.

MUTE Switch w/LED

Mutes the channel and all send functions. Mute also responds to the Mute Group system and to the VCA Group Mute if selected (refer to User Options). The LED illuminates when the channel is muted.

MONO Bus Assign Switch w/LED

Assigns audio to the Mono bus.

LCR Switch with Indicator

Controls the function of the L-R and M assign switches in combination with the Balance control. When LCR is selected, the Balance control provides continuous variation of outputs to the L, R & Mono mixes.

Full clockwise = full level to mono, none to L-R.

Full counter-clockwise = full level to stereo, none to mono.

Refer also to Special facilities.

Bus Assign Switches, L-R & Mono w/LEDs

Connect the post fader stereo audio to the output buses. These outputs are always affected by the Width and Balance controls. Balance provides L-C-R panning function to the three output buses when the LCR switch is selected.

SOLO Switch w/LED

Operator monitor facility, switches channel audio into the headphones and SOLO meters in stereo. Choice of PFL or AFL. Unaffected by mutes.

L&R PEAK & SIG LEDs

Input level metering for the L and R channels. The green signal LEDs turn on at about -30dB and brighten with increasing level. They show the pre-amp output levels.

Red peak LEDs turn on 3dB before overload and show the levels post-fader, pre-fader and at the preamp output.

Fader

100mm VCA fader adjusts the channel stereo audio level. Controls all outputs of the channel except those Aux output sections selected pre-fader.

VCA Group 1-8 selectors

Assign the channel VCA to the VCA group control buses. Puts the channel audio level under the (remote) control of the VCA Group fader along with other channels assigned to the same group. Independent of the Group Audio Assign section above.

VCA LED

Indicates VCA gain (i.e., gain of fader stage) via a two-color LED. Indications are as follows: Green - intensity indicates gain status (gain of fader stage). Red - indicates maximum VCA gain has been reached, approximately 15dB. When the gain LED is red then further requests for increased level, by moving the channel fader or the VCA Group fader up, will produce no response.

Mute Group selectors A-D

Assign input channels to any of the four Scene Mute groups. Mute response occurs only when the group Master has been activated.

Mute Groups Safe Switch w/LED

Bypasses the selected Scene Mute assignments. No Scene Mutes can occur. An associated green LED indicates the channel is in a SAFE (isolated) state.

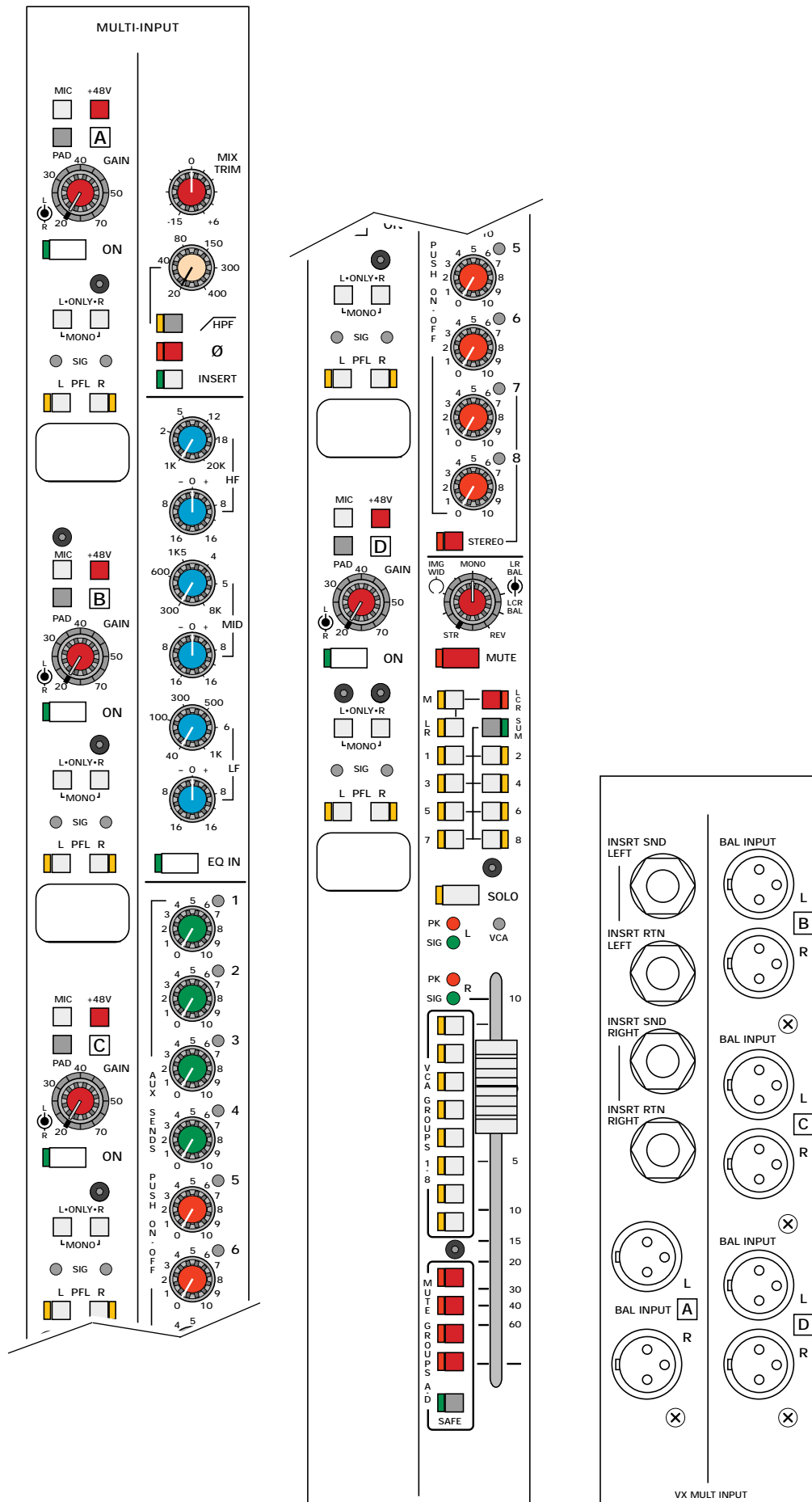

Optional Multi-Input Module

The left side of this double-module provides four stereo inputs which are summed together creating a stereo sub-mix. The right side takes that mix and processes it as a stereo source into the Vx. The right side (called Multi Master) is similar to a regular Vx Stereo Input module, except that the Input Gain pot and switches are replaced by a mix trim stereo level control.

Panel controls (each of four identical inputs)

MIC input selector

for the L & R Input XLRs. The default (with the switch released) is Line Input sensitivity and gain.

+48V phantom power ON-OFF switch
for the input XLRs. Active only when MIC source selected.

PAD switch

for introducing 15dB attenuation between the XLRs and the preamp.

GAIN dual- concentric control pair

for the stereo preamp.

ON-OFF switch with indicator

for the preamp output to the stereo sub-mix.

L & R assign switches

for the preamp output to the stereo sub-mix.

For normal Stereo output release both switches. Use either L or R alone to send one side of the input to both sides of the mix. Select both switches for a mono mix of both inputs to the stereo mix.

SIGNAL indicators

for L & R audio, bi-color indication: normal level = green; overload = red.

PFL switches with indicators

for the L & R inputs.

Rear panel connections

Insrt Snd (Left/Right)

This balanced 1/4" TRS jack allows for the Left and Right multiple input module output signals to be sent to effects or signal processors.

Insrt Rtrn (Left/Right)

This balanced 1/4" TRS jack allows for the return of the effected and/or processed signal back into the multiple input module.

Bal Input (L/R) A, B, C, D

These balanced XLR connectors accept input signals for the A, B, C, and D stereo inputs of the multiple input module.

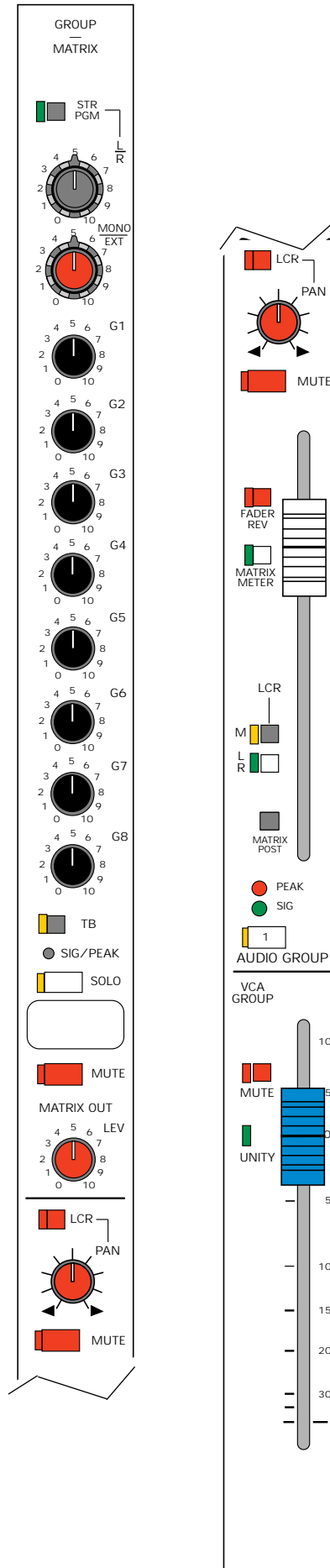

Vx Group Modules

Each Vx Group module has three sections: Matrix, Audio Group, and VCA Group. Fully loaded Vx consoles have eight group modules. Group number is indicated on Solo switch.

Group Meter

Located on the meter bridge, it indicates the post-fader output level of the group.

MATRIX Section

STR PGM Switch w/LED

Normally, the signal sent to the Matrix by the L/R LEVEL TO MATRIX fader is the Left/Right bus signal. This button switches the signal source to the Stereo Program In signal. Green LED indicates selection.

L/R Level to Matrix

Dual control pair. Controls Left & Right level into the Matrix.

Mono/Ext Level to Matrix

Dual control pair. Controls Mono output level and the External Input level added to the Matrix.

Group to Matrix Levels (G1-G8)

Adjusts the level of group signal added to the Matrix.

TB to Matrix w/LED

Enables the Talkback path into the Matrix.mix. Talkback will be heard when it is turned on at the Master ON switch.

PEAK/SIG LED

Indicates signal level of the Matrix.

Green=Signal Present; Red=Peaking Signal

SOLO Switch w/LED

This switch sends the associated Matrix signal to Solo.

MATRIX OUT Level w/LED

This rotary fader controls the master level of the associated Matrix to the rear XLR connector.

GROUP Section

PAN CONTROL

Positions the Group image between left and right or between left-center-right.

L-C-R Switch

Changes the PAN function from normal L-R to L-C-R operation. The mix to the L, R & Mono buses is adjustable with L-C-R PAN. Refer to Special facilities for more information.

MUTE Switch w/LED

Turns off the Group audio to outputs. LED on = audio off.

MONO Bus Assign Switch

Assigns the input signal to the Center / Mono bus. If L-C-R is selected then PAN adjustment will be effective.

Group Fader

100mm linear audio fader. Controls all group signal outputs to the mix and output XLR

MATRIX METER Switch w/LED

Displays Matrix signal on associated Group meter.

FADER REV w/LED

Swaps functions between the Matrix level control and the group fader; one becomes the other.

Group Mono Assign

Assigns the associated Group signal to the Mono bus.

Group L-R Assign

Assigns the Group signal to the Left and Right buses.

Matrix Pre/Post w/LED

Switches the Matrix send between pre and post-fader settings.

Group Peak & Signal LED's

The red LED indicates that the group signal is within 3dB of the clipping point. The green LED constantly displays the level of group signal activity by varying in intensity.

Audio Group Solo w/LED

Allows for monitoring of the Group signal on meter and headphones. Choice of PFL or AFL is made in the Master section. AFL is after the Group fader and mute.

VCA GROUP Section

VCA Group Fader

100mm VCA control fader. Sends a control voltage to any inputs assigned to that VCA group.

VCA Group Mute w/LED

Attenuates any inputs assigned to that VCA. VCA group mute is a fader position change; this is different to input mute. (Can be changed to function as an input mute via an internal jumper.)

UNITY LED

Indicates when VCA control fader is at "Unity Gain", a position where any inputs subsequently assigned to that VCA will not receive any gain change upon assignment. This permits assignment of inputs to VCA's 'on the fly', without affecting the mix at the fader stage.

LEFT AUX
HF, LF, LEV, MUTE, MONO, L·R, STEREO AUX IN A, SOLO, GLOBAL PRE, AUX OUT 1, AUX OUT 2, AUX OUT 3, AUX OUT 5, MUTE, SOLO, LEV

RIGHT AUX
HF, LF, LEV, MUTE, MONO, L·R, STEREO AUX IN B, SOLO, GLOBAL PRE, AUX OUT 2, AUX OUT 4, AUX OUT 6, MUTE, SOLO, LEV

MONO ALT
LAMP DIM, DC POWER IN (+20, -20, +48, +24), GAIN, HF, LF, AUX 1-2, AUX 3-4, AUX 5-6, AUX 7-8, BAL, MONO, L·R, STEREO PROGRAM IN, SIG/PEAK, SOLO, MUTE, SOLO, LEV

MASTER
TB MIC, ADDITIONAL JACKS LOCATED BELOW ARMREST, HEADPHONES, 10KHZ, 1KHZ, 100HZ, FREQ, +5 X2, LEV, TB/OSC ASSIGN (MONO, L·R, GROUPS), AUXES (1-8), EXT TB IN, EXT TB OUT, TALKBACK, TAPE, L·R + CENTER, SOLO DEFEAT, SIG/PEAK, MUTE, MONO, MATRIX POST, LEFT, RIGHT, PEAK, SIG, SOLO, LEV

AUX OUT 5
SOLO, MUTE, LEV, GLOBAL PRE, AUX MUTE ACTIVE, MUTE, MONO, MATRIX POST, LEFT, PEAK, SIG, SOLO

AUX OUT 6
SOLO, MUTE, LEV, GLOBAL PRE, AUX MUTE ACTIVE, MUTE, MONO, MATRIX POST, RIGHT, PEAK, SIG, SOLO

SIG/PEAK
SOLO, MUTE, LEV, PRE, + CENTER, SUM MONO, ALT L/R OUT, MUTE, MONO, MATRIX POST, MONO CENTER, PEAK, SIG, SOLO

MONITOR OUT
TAPE, L·R + CENTER, SOLO DEFEAT, DIM, SUM MONO, MUTE, TAPE, L·R + CENTER, LEV, SOLO DEFEAT, HEADPHONES, SOLO, AFL, PFL, SOLO TYPE, SOLO CONTROL (MUTE GROUP MASTERS: A, B, C, D, AUX)

Vx Master Section

Comprises four modules and is the control center for the Vx console. Stereo Aux In, Monitoring, Solo, Talkback, Stereo Program In, Master Aux & Matrix, internal oscillator & Scene Muting functions are controlled here.

LEFT/RIGHT Modules

Stereo Aux In HF Level

Upper-band fixed frequency (10kHz) EQ that affects the associated Stereo Aux in channel.

Stereo Aux In LF Level

Lower-band fixed frequency (80Hz) EQ that affects the associated Stereo Aux in channel.

Stereo Aux In LEV Control

Controls the level of the Stereo Aux In audio.

Stereo Aux In MUTE Switch w/LED

Turns off the audio assigns to the main mixes

Stereo Aux In MONO Switch

Assigns the audio to the Mono bus.

Stereo Aux In L+R Switch

Assigns the stereo audio to the main L+R mixes, L to L, R to R.

Stereo Aux In SIGNAL LEDs

Bi-color LED lights green at normal output levels, red indicates an overload condition. Responds to audio in both L&R channels, and pre and post level control.

Stereo Aux In SOLO Switch w/LED

Allows SOLO monitoring of the associated Stereo Aux In signal. Choice of PFL or AFL.

Auxiliary Output MUTE w/LED

Mutes the respective auxiliary XLR output. In addition the Aux Scene Mute Master facility allows a number of auxes to be muted at the same time. The mute LED indicates the audio status and responds to both controls. Refer to the Special Facilities section for more about Aux Scene Mute.

Aux Master LEV Control

Controls final output signal level of the auxiliary output.

Aux Master GLOBAL PRE Switch w/LED

This switch changes all Aux sends on input modules for the associated Aux bus to be Pre-Fader or Post-Fader. Up=Pre, Down=Post. The associated LED is green in color.

AUX OUT LED

Bi-color LED lights green at normal output levels, red indicates an overload condition.

Aux SOLO Switch w/LED (green)

Solo monitoring facility for the AUX mix. Choice of PFL or AFL.

AUX MUTE ACTIVE LED

Indicator for the Aux Scene Mute facility. Illuminates when the Aux Scene Mute Master switch has been selected.

L/R/MONO MUTE Switch w/LED

Mute outputs of Left, Right & Mono signals respectively.

MONO Switch w/LED

Assign the Left and Right signals to the Mono output.

MATRIX POST Switch w/LED

Switches the source of Left, Right and Mono matrix feed signals between pre and post-fader.

L/R PEAK/SIG LED's

The red LED lights 3dB before clipping point and responds to pre and post fader levels. The varying intensity of the green LED displays the level of the mix bus audio.

SOLO Switch w/LED

Solo monitoring of the L, R or Mono Output. Choice of PFL or AFL source.

Fader

100mm linear analog fader for control of the output level to XLR, matrix and Solo AFL.

Not Shown:

Left, Right & Mono Insertion points.

Left, Right & Mono Meters.

MONO Module

Lamp Dim Control

Controls the intensity of the lighting devices plugged into the XLR sockets on the back of the meter bridge.

Power Indicators

These four LED's indicate the status of the incoming DC.

Stereo Program In Gain

Adjusts the gain of the Stereo Program In signal.

Stereo Program In EQ

Two-band fixed frequency (10kHz and 80Hz) EQ that affects the Stereo Program

AUX 1&2, 3&4, 5&6, 7&8 Levels

These rotary faders controls the amount of Stereo Program signal sent the respective Aux buses. Normally Left signal is sent to the odd Aux buses, while Right signal is sent to the even Aux buses. Refer to Special facilities for more information.

Stereo Program Balance

Provides adjustment of the image position.

Stereo Program Assignments

Assigns the Stereo Program to the Mono and Left/Right buses.

Stereo Program Mute w/LED

Mutes the output of the Stereo Program.

Stereo Program Level

Controls final output signal level of the Stereo Program.

Stereo Program SIG/PEAK LED

The red LED lights 3dB before clipping point and responds to pre-fader levels. The varying intensity of the green LED displays the level of the audio. Both LEDs respond to the sum of L&R audio.

Stereo Program SOLO Switch w/LED

Solo monitoring facility for the Stereo Program signal. Choice of PFL or AFL in stereo.

Alt L/R Output facility

Stereo output with level control and mute. The source is the main L&R output, either pre or post output faders. The Mono mix may be added, it is automatically sourced pre or post fader in response to the L&R Pre-Post selection. The ALT output may be operated in Mono when required using the SUM MONO switch.

MASTER Module

TB MIC Input

Allows for a microphone to be plugged in for use with the talkback system. Accepts balanced low impedance mics. +48V phantom power is provided. Refer also to User Options.

Headphone Jack

Stereo 1/4" TRS socket for all types of headphones. A second HP socket and TB socket are located beneath the front hand rest.

10kHz/1kHz/100Hz switches

These push buttons select the sine wave frequency generated by the internal Oscillator. Lowest selected frequency takes priority.

Oscillator FREQ Control

This rotary pot adjusts the selected frequency by a minimum factor of 0.2 or maximum factor of 2.0. Used in conjunction with the frequency buttons, tones from 20Hz to 20kHz can be generated.

Oscillator LEV Control

This rotary fader adjusts the Oscillator level between off and +4dB.

PINK NOISE Switch w/LED

This switches the generator to pink noise replacing tone.

Oscillator ON Switch w/LED

Turns on the internal oscillator / pink noise generator.

Talkback Assignment Switches

Assigns the TB/Osc audio to the summing buses for Mono, L,R, Aux 1-8 and Groups 1-8. TB to Matrix is enabled locally at each Matrix section.

Talkback Level Control

Controls the level of the TB/Osc audio.

External Talkback Input Switch w/LED

Selects the External Talkback Input XLR and adds it to the local mic or tone signal. The XLR is balanced and accepts high level audio.

External Talkback Output Switch w/LED

Turns on the external talkback XLR. The output is local mic or tone but not Ext mic.

Talkback On/Off Switch

Turns the talkback/osc output on and off. Press+hold for short message; press+release to lock on, press+release again to lock off. Controls all routes including TB to Matrix.

Monitor Output system

Stereo monitoring system with main Level control, Mute switch and outputs on balanced XLRs. The audio sources are L+R mix or Stereo Tape Input. The Center/Mono mix may be added. Normally SOLO interrupts the source. The SUM MONO switch combines the L&R monitor audio into a mono output.

Stereo Tape Input

The stereo audio from the rear panel jacks connects to the source select switch. If nothing is plugged into these sockets then STEREO PROGRAM INPUT audio is normalised through the switch contacts and reaches the source selector.

Solo Defeat switch

Prevents SOLO interrupting the normal monitor audio. Allows the monitor output to be used as an additional dedicated output circuit when necessary. Included with main and headphone sections.

Dim Switch

This switch introduces a -12 dB attenuation into the local monitor outputs. It is disabled when SOLO defeat is depressed, auto-active when TB is on.

Headphone Monitor system

Stereo output, with two sockets in parallel, and level control. The sources are the same as for the main monitor circuit and may be selected independently.

Solo Active LED

This LED indicates that SOLO is active.

AFL/PFL LED's

These LED's indicate which type of SOLOing has been selected.

SOLO type Switch

This switch changes solo type from PFL (Pre-Fader Listen) to AFL (After-Fader-Listen). Both are available from the majority of sections in the console. Both are stereo capable. This switch chooses one or the other. AFL is after fader, pan and mute.

Mute Group Master Switches+LEDs

All Input channels, including Stereo Inputs are connected with the Mute Group system. Four switches on each channel may be used in any combination to select the channel onto the Mute buses. LEDs on the channels show the selection.

When the Master switch is selected the LED lights and the bus becomes active. All channels on the bus mute.

At any time a channel may be deselected from the bus. If the bus was active it will un-mute immediately. If the bus was inactive the channel mute will not change. When a channel is already locally muted then the mute group confirms the mute. When the local mute is released then the channel remains muted by the mute bus.

The SAFE facility allows a channel to be isolated temporarily from the Mute Groups without disturbing the selection.

Mute Groups are part of the Vx Expansion system. Refer to the Special Facilities section.

Aux Mute Group Switch w/LED

The eight Aux Master Output Mutes are connected to the Aux Group Mute system. Individual Aux Output Mutes may be pre-selected using the local switch next to the Level control. The mute and indicator do not respond directly.

Operation of the Aux Master Mute will mute all Aux Mutes that have been pre-selected, the LEDs turn on, the Aux Mute Active LED turns on and the indicator next to the Aux Master switch turns on.

An individual Aux may be deselected from the Mute Group at any time using the local mute switch again.

Use this system to control sets of Aux outputs at the same time, for example to mute FX sends on the last beat of a song so that reverb tails are heard.

In situations where direct access to Aux mutes is wanted the system may be adapted, refer to User Options.

Vx Meter Bridge - 52 & 64 Frame Models

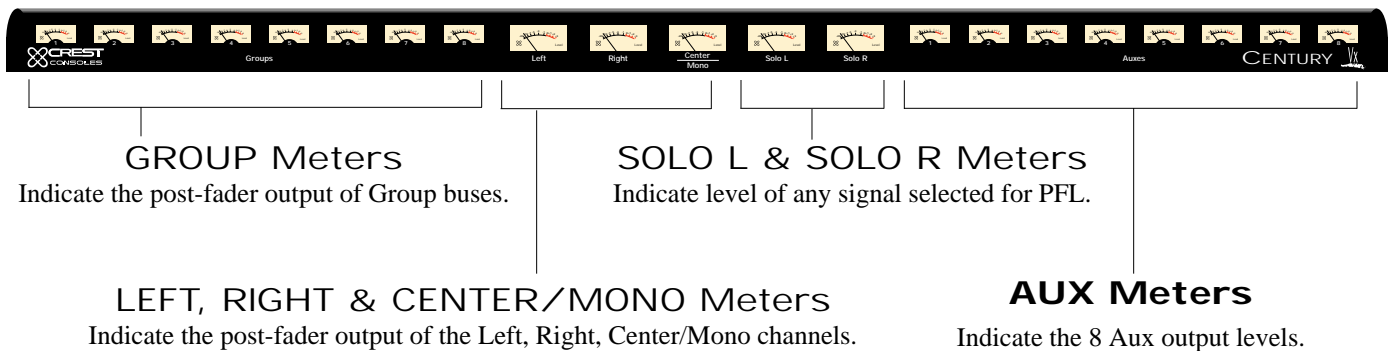

Vx Meter Bridge - 44 Frame Model

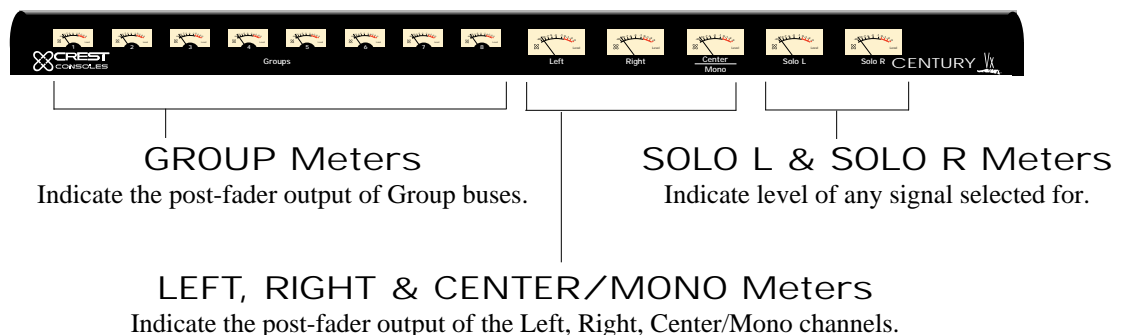

Special Facilities

Century Vx Console Expansion

The Expansion option is available for all Vx models. Two Vx consoles may be linked in a Master-Slave arrangement. Alternatively, a Vx may be linked to a Yamaha PM series model, or other console.

Included Facilities

The facilities included are:

- links for control of VCA Groups 1-8
- links for Left, Right and Mono audio mixes
- links for Scene Mute groups
- links for Solo PFL and AFL audio mixes and Solo control
- mode selection: Master-Off-Slave for all functions

A further option is available with the standard Vx Expansion system. This provides direct access to the Left, Right, Mono and Aux 1-8 audio buses.

Hardware

Active electronics for the Expansion system are located inside the console chassis. The 56-way EDAC Expansion connector is located in the upper chassis cut-out behind Input 1. The Mode switch is located immediately below the Expansion connector. A link cable is required, and is available in two versions, Vx-to-Vx, and Vx-to-PM. Cable length permits consoles to sit side by side or in an "L" arrangement.

When fitted, the 56-way Bus expansion option occupies the second chassis cut-out position.

All audio interfacing is buffered at line level. There are no chassis connections in the link cable.

The audio group mixes of the two consoles remain independent.

(hardware set reference: Vx Expansion 76D2943-00 + 76D2977-00 July 96)

Linked Console Operation

Set up the two consoles as normal. Provide each console with its own power supply and back-ups, then connect the link cable. The Vx-to-Vx cable may be fitted either way around, internal connections cross over inputs to outputs. The Vx-PM cable has different connectors at each end.

Modes

The mode switch may be set with power on or off; the system responds immediately.

Assign the Master console with the Mode switch on the Master console set to MASTER. Assign the slave console with the mode switch on the slave console set to SLAVE. (Note that if both consoles are set to Master then the system rejects both settings, both consoles respond as slaves until one is set to Master mode.)

When independent operation of the Slave console is required, select the "OFF" mode.

VCA Operation - Groups

The Master console VCA group faders affect the levels of any channels assigned to a VCA group on both consoles. VCA group faders on the Slave console are inactive, while the VCA unity gain indicators remain functional.

VCA Operation - Group Mutes

Between Vx consoles, the VCA Group Mute function of the Master console controls all channels assigned to that VCA Group. VCA Group Mutes on the Slave console are inactive.

Between a Vx and a PM console, there is no transfer VCA Group Mute function.

Scene Mute Operation

The Master console Scene Mute Master ON-OFF switches (Vx A-D, PM 1-4) are active for all channels assigned on both consoles. Master switches on the Slave console are inactive. In response to a master mute, the indicator next to the appropriate master mute on the slave console lights.

Between Vx and PM consoles, Scene Mutes 5 thru 8 are not transferred. Some PM models allow independent Master-Slave selection of Scene Mutes 1-4 and 5-8.

Solo Operation

The Solo meters and headphones of the Master console respond to a Solo selection on either console. Solo meters and headphones of the Slave console respond to a Solo selection on the Slave console only.

Audio Linking

The Left Right and Mono audio circuits between consoles are high level ground-free connections. The audio paths connect onto the appropriate summing bus in the Master console and are controlled by the Mode switch.

Outputs

The console expansion link connection includes the Left, Right and Mono outputs. These are derived after the Matrix send Pre/Post switches on the Output sections. The audio outputs are not affected by the Mode switch.

Inputs

The console expansion link input paths to the Left, Right and Mono summing buses are active ONLY when the console is in MASTER mode. In Slave and Off modes the audio circuits are gated off.

Special Facilities (cont'd)

LCR PANNING

Operation of center-cluster sound systems requires panning channels between the Left and Right sides of the main stereo PA and between the stereo PA and the center system. Conventional panning systems allow for L-R panning but the center feed is either all on, full center, or all off, no center. In practice it is necessary to balance the different sound groups between center and sides. This requires LCR panning. Active circuits are combined with a special multi-section pot in the Input, Stereo Input and Group-to-mix pan sections of Vx consoles.

INPUTS and GROUPS

LCR pan sections include an LCR enable selector. When in LCR mode, three outputs (Left, Right and Center) are derived from a single input.

Pan central	100% output to Center only
Pan hard left	100% output to Left only
Pan hard Right	100% output to Right only
Between hard left and center	progressively less left and more center output, no right output.
Between hard right and center	progressively less right and more center output, no left output.

Operation of LCR panning requires the L-R and M (mono or center) assign switches to be selected and the LCR switch selected.

The monitoring section of the console allows the center mix to be added to the stereo mix in headphones for checking purposes.

STEREO CHANNELS

LCR panning is provided by the Balance section of the Width/Balance control.

Select the LCR switch and the L-R and Mono audio assign switches. Now the inner control 'Balance' operates as an LCR panpot:

Fully counter-clockwise = full level to L&R, none to center,

50% rotation = equal levels to L, R & Center outputs,

Fully clockwise = full level to center, no signal to L&R

STEREO PROGRAM INPUT

(located above the MONO Master)

Connections are provided on the rear panel for stereo input to the Mixes, Auxiliaries and Matrix outputs. Use this section for music playback or special return input. Access to the Matrix outputs is direct, bypassing the groups. On each Matrix that requires Stereo input select the switch next to the level control pot 'L-R / STR PGM'.

Stereo Program audio from the rear XLR connectors also passes to switching contacts on the TAPE INPUT 1/4 inch sockets. When nothing is plugged into the TAPE sockets Stereo Program audio passes to the TAPE monitor source switch.

VCA GROUP MUTES

Normally the operation of the VCA Group Mute commands all the channel VCAs in the group to close. The effect is that all output assignments are faded out, also the post-fader effects sends are faded. However pre-fader sends are un-affected. This may be satisfactory, it depends on the effects and monitor mix set-up at the time.

In a situation where a pre-fader send had to be muted with the channel then two possible options are available.

Use the local channel Mute switch to cut the pre-fader send, either individually or as part of a Mute Group.

Alternatively the console can be set so that VCA Group Mute sends a Mute command to the channel audio switch in addition to a fade command to the channel VCA.

This choice is called VCA Group Channel Mute option. It may be set up individually for each VCA Group by selection of an internal jumper link in the Group Output module.

When this is set up, then operation of a VCA Group Mute switch sends Mute commands to the channel mutes of all channels in the VCA group. The result is to turn off the post-fader audio outputs to buses, effects etc, AND to mute the pre-fader sends.

This would be desirable if some of the pre-fader sends were being used for foldback or effects for example.

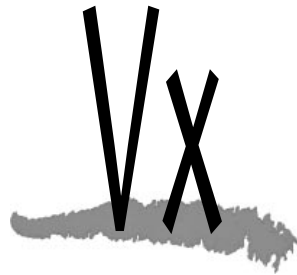

Appendix A

Technical Information

General Specifications - Vx Console

Technical specifications for the Century Vx console.

Available (Eight Bus) Configurations

20 inputs (32 Frame)	32 inputs (44 Frame)
40 inputs (52 Frame)	52 inputs (64 Frame)

All Century Vx consoles are available with stereo input modules.

Frequency Response

+0.0, -0.5dB, 20Hz to 20 kHz (referenced to 1kHz)

Total Harmonic Distortion

Mic input to Group output
20Hz to 20 kHz at +15dBu <0.02%

Phase Response

20Hz to 20 kHz +30°, -20°

Noise (22Hz to 22kHz)

Mic EIN -129 dBu
Mix bus Output Noise (20 ch routed) -80 dBu
Aux bus Output Noise (20 ch routed) -80 dBu

Crosstalk (Measured at 1kHz)

Channel Mute >102 dB
Channel Fader Attenuation >96 dB
Channel Routing >85 dB
Channel Aux Send Attenuation >93 dB

Input/Output Impedances

Mic Input 4kΩ balanced
Line Input >10kΩ balanced
Outputs 140Ω balanced

Input/Output Levels (0VU = +4 dBu, 1.23V RMS)

Mic Input Sensitivity +4 to -62 dBu
Line Input Sensitivity +12 to -38 dBu
Input Insertion Point Level +4 dBu
Output Insertion Point Level -2 dBu
Nominal Output Level +4 dBu
Maximum Balanced Output Level +28 dBu

Net Weights

32 Frame 146 lbs. / 66.3 kg
44 Frame 197 lbs. / 89.5 kg
52 Frame 239 lbs. / 108.5 kg
64 Frame 293 lbs. / 133.0 kg

Configurations

Century Vx Consoles are available in the following configurations:

All Century Vx Consoles are available with optional stereo input modules.

Eight Subgroup - 20, 32, 40, or 52 inputs

Architect's & Engineer's Specifications - Vx Console

The following text should be used when specifying a Century Vx in a bid or proposal.

The Vx live sound console shall be constructed in a modular fashion and be housed in a steel frame of (32, 44, 52, or 64) module positions. Vx Consoles shall include an 8 channel VCA level control system as well as an 8 channel audio subgroup system. The console shall utilize XLR-type lighting device connectors with dimmer system. A meter bridge using mechanical meters with solid state illumination shall be included. Signals to be monitored include Left, Right, Mono (Center), Stereo Solo and 8 Group output signals. On 52 and 64 module position frames, 8 Auxiliary output meters are also provided. The Vx live sound console shall feature a defeatable Left-Center-Right (LCR) panning system on input and group modules. • On each input channel: all microphone inputs shall be electronically balanced and accessed via XLR connectors and have an EIN of -129 dBm. All input channel line inputs shall be electronically balanced and accessed via 1/4" TRS jacks. Input module insert and return points shall be via individual 1/4" jacks and controlled by a front panel switch with LED. Additional input controls include: a +48 volt Phantom Power switch, a -15 dB Pad switch (-20 dB for stereo input channels), adjustable High Pass Filter control (20-400Hz) with on switch and LED, a Polarity Reverse switch with LED, and 4-band sweep EQ (LF- 40-800Hz, LMF- 100Hz-2kHz, HMF- 400Hz-8kHz, HF- 1.5k-20kHz) with Peak/Shelve switches on the high and low EQ bands, switchable bandwidth on low-mid and high-mid bands, and an EQ In switch with LED. Each input channel shall also have a FET-controlled Mute switch with LED, affecting all assigned outputs including Auxiliary sends. The mute system may be defeated to the auxiliary sends by use of an internal jumper system. Assignment switching is provided to the following output sections: Left/Right, Mono, Subgroup 1, 2, 3, 4, 5, 6, 7 and Subgroup 8. An LCR switch shall reconfigure the Left/Right and Mono assignment system to a true Left-Center-Right mix system. A Pan On switch will allow conventional panning between any odd and even subgroup assignment regardless of the position of the LCR configuration switch. A 5-segment Signal level LED indicator will be provided on Mono input modules, including a multiple sample point peak LED to monitor signal levels. Input modules will also include a Solo switch with LED indicator, 8 VCA group assignment switches, 4 Scene Mute preset switches, Scene Mute Safe switch with LED, and a 100mm fader. Each input channel shall have eight Auxiliary send level controls. Each Aux Send shall have the ability to be turned on and off by pressing its associated send knob. A bi-color LED will indicate the status of the send: Green=Aux switched on, Red=Aux switched on but send muted, LED Off=Aux switched off. Signal source of each Aux mix bus is normally post channel fader but may be globally changed to a pre fader source from eight individual switches within the master section. Individual channels may be removed from the global pre/post fader signal source as well as Aux Mute control by a series of internal jumpers on each input module. • The 8 VCA group assignment switches will allow each channel to be controlled by any or all of the VCA group faders. A VCA bi-color LED will show VCA control voltage with increasing green intensity, and will turn red when VCA control limiting is reached. The Aux sends shall be globally switchable pre or post fader with internal jumpers to select pre or post EQ and pre or post mute. There shall be an Aux 8 Direct switch that allows the Aux 8 send knob directly to control the output of the 1/4" direct output connector. There will also be an Aux 8 Pre switch which allows Aux 8 to be switched pre fader independently of the global switch. Optional Stereo input modules with similar features will be available. • Each Group module shall have VCA Group and Audio Group mixing sections, and a Matrix section. The VCA Group section shall have a Mute switch and Unity LED indicator. • The Audio group mix section of the module shall have a Pan control, a Mute switch with LED, Matrix meter switch, assignment switches for Left/Right and Mono with an LCR configuration switch, a Fader Reverse switch with LED that allows the group fader to control the level of the matrix output, a Solo switch, dynamic signal present LED and peak LED, and a 100mm fader. Each Audio Group mix section will have group insert connections. • The Matrix section shall have controls for Group to Matrix Levels (G1-G8), L/R level to Matrix, Mono and External level to Matrix, Talkback to Matrix (w/LED), Peak/Signal level LED. The Matrix section shall also have a Stereo Program switch (w/LED) to switch the L/R signal source to the Stereo Program input, a Solo switch, and a master Matrix Out level control. • The master section shall have the following features: eight Aux master controls with associated Global Pre, Solo and Mute switches, a 100mm fader for each of the Left, Right, and Mono (Center) master outputs with insert connections, an assignable Talkback system, Monitor control system (with balanced XLR output), Stereo Program input section with EQ, and a Scene Mute Master switch section, each with LED. • The power supply shall be housed in a 14 gauge steel chassis and provide ±20V, +24V, and +48V to the console. The power supply shall have the ability to be daisy-chained to additional power supplies to provide a redundant operating environment. Connection of two or more power supplies shall not require additional hardware other than an interface cable. The live sound console shall be: the Crest Audio Century Vx.

Vx Block Diagram

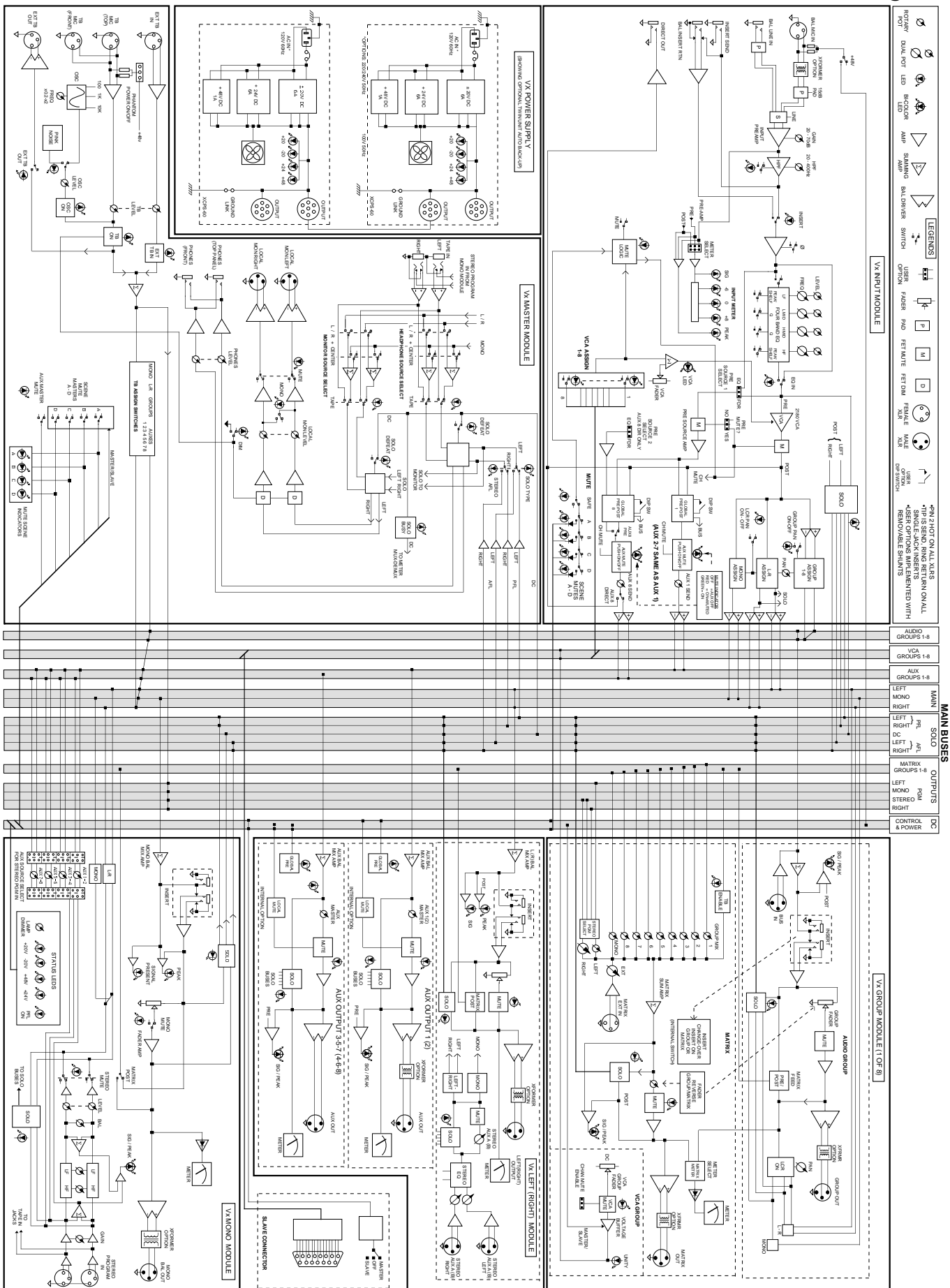

Console Side Dimensions

The following diagram illustrates the depth and height dimensions (from the side) for all Century Vx consoles.

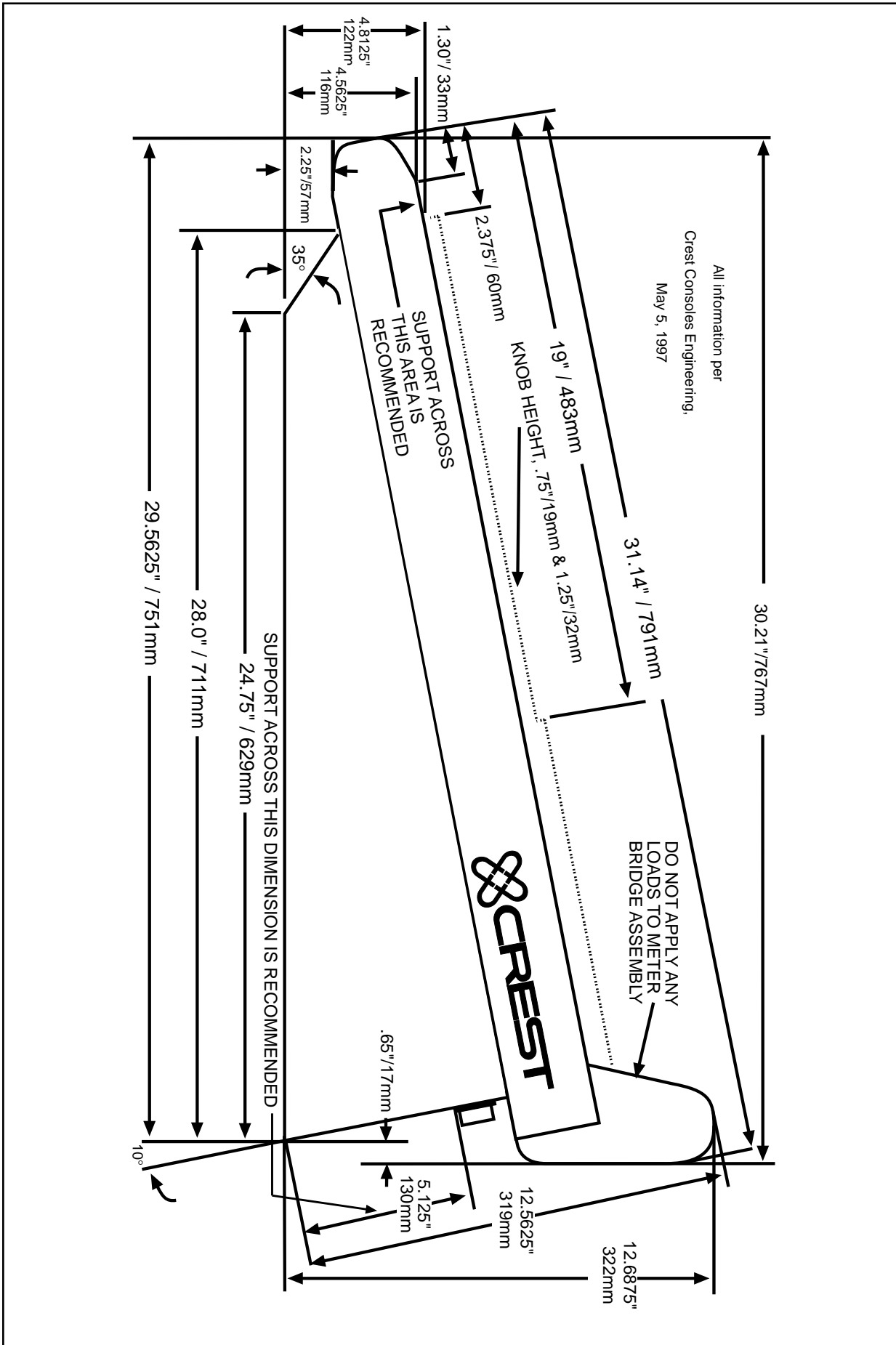

Rear Views & Dimensions

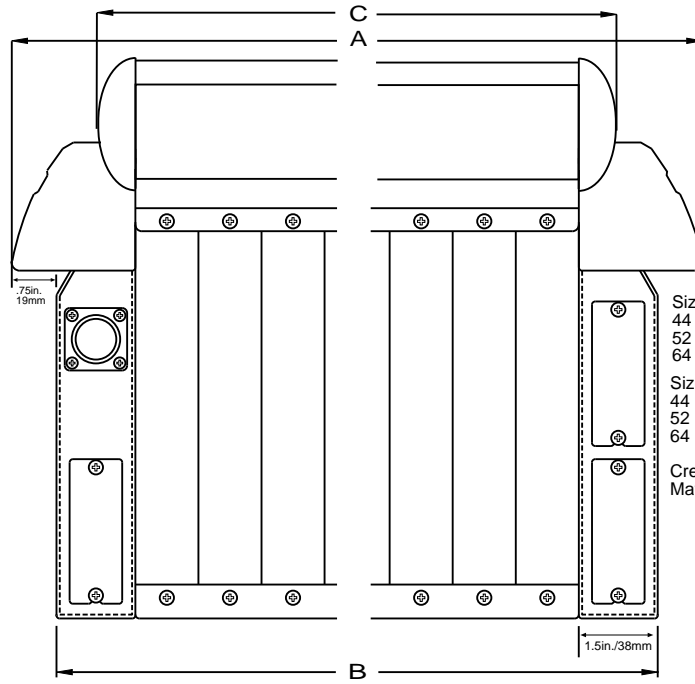
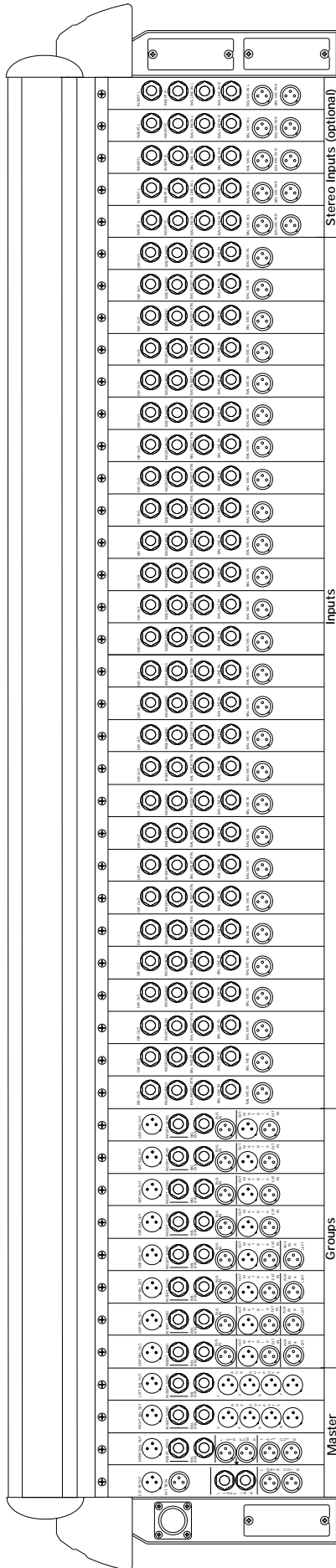

Size	A	B	C
44	57.55"	55.80"	54.25"
52	67.15"	65.40"	63.85"
64	81.55"	79.80"	78.25"

Size	A	B	C
44	1462mm	1417mm	1378mm
52	1706mm	1661mm	1622mm
64	2071mm	2027mm	1988mm

Crest Consoles Engineering,
May 5, 1997

VX User Options

VX consoles are shipped having standard configuration unless specified at time of order. These are ways that the console configuration may be varied after manufacture. The items listed are internal options selected by gold jumper links or pcb DIP switches. DIP switch 'ON' position is down when reading the numbers on the switch body.

Jumper link default is marked with a line on the board and is usually pins 1&2 of the three pin header.

In addition there are links for module function assignment. Take care to not disturb these when using USER OPTION links.

<u>MODULE</u>	<u>LOCATION</u>	<u>OPTION TITLE</u>	<u>FUNCTION</u>
	M=Main board C=Connector		Shipped with option underlined
Inputs	M	J2, Pre Feed 1: Mute ?	Aux sends <u>with Mute</u> or without Mute
	M	J3, Pre Feed 1: Source	Aux sends Pre or <u>Post EQ</u>
	M	DIP switch 1-7	Aux 1-7 override Global Pre (local Pre)
	M	DIP switch 8	Aux 8 Direct Out = Pre Feed 1 or 2
	M	J4, Pre Feed 2 (never mute)	Aux 8 Direct source, <u>Pre EQ</u> or Pre-fader
	M	J5, Input Meter Source	Preamp, <u>Pre-fader</u> , Post-fader
VX Stereo In	C	behind GAIN pot	Phase invert: L only or <u>L+R</u>
	M	J4: Aux Pre Source	<u>with MUTE</u> or without MUTE
	M	J2: Left Pre Source	<u>Pre EQ</u> or <u>Pre Fader</u>
	M	J3: Right Pre Source	<u>Pre EQ</u> or <u>Pre Fader</u>
VX Multi Input		same as Stereo Input	
VX Groups	M	SEL 4: VCA Mute Atten	VCA mute affects Ch Mute; <u>VCA mute affects Ch VCA</u>
	C	Insert: selector switch	<u>Group insert</u> or Matrix insert
VX L & R	C	Connector board SEL 4	feed to ALT (Mono module) Pre or <u>Post</u> insert
	M	SEL 3 Aux local Mute	Link on = Enable, or <u>Link off</u> = Master Mute only
VX Mono	M	SEL1,3,5,7,9,11,13,15	Stereo Prog In: Aux <u>Stereo</u> or Mono
	M	SEL2,4,6,8,10,12,14,16	Stereo Prog In: Aux Send <u>On</u> or Off
VX Master	C	SEL1 TB Phantom Power	<u>On</u> or Off
	C	SEL2 TB Gain select	20, <u>30</u> , 40dB gain



IMPORTANT



Group Modules and Left/Right Modules are pre-assigned at the Crest factory

These modules must always be installed in the correct positions. They are NOT interchangeable without being properly re-assigned. Please contact the Crest Audio Service Department for more information.

Console Disassembly

Though you shouldn't have to disassemble the console, it is necessary to remove modules to change the jumper and switch settings associated with the internally selectable options. The following steps detail the tasks involved when taking the console apart.

ONE • Open the armrest.

To properly remove one or many modules, the black painted armrest must first be opened. To do this, the two thumbscrews (see diagram at right) must be loosened from below. Once these screws are loose, slide both of them a few inches to the side (they will only move in one direction). Once the screws have been moved the armrest will easily roll back exposing the module screws beneath.

TWO • Remove front module screw

Once the armrest has been opened, there will be a single screw at the front edge of the module panel holding each module in place. Remove the screw from the module(s) you want to remove.

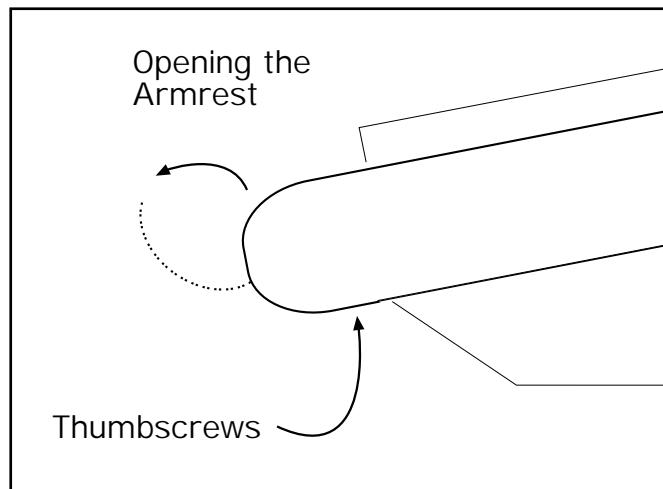

THREE • Remove rear screws

On the back panel of the console there are two screws holding each module in place (see diagram at right) Remove both screws from each module you wish to remove.

FOUR • Lift the module(s) out

As you lift the module out of the chassis three wires must be detached before the module can be completely removed: 2 flat-wires (ribbon cables) and one ground wire.

The flat-wires are removed by flipping the latches on the ends of the connectors. Once the tabs have been flipped the connector should pull off easily.

The ground wire (green) is a spade lug which pulls off.

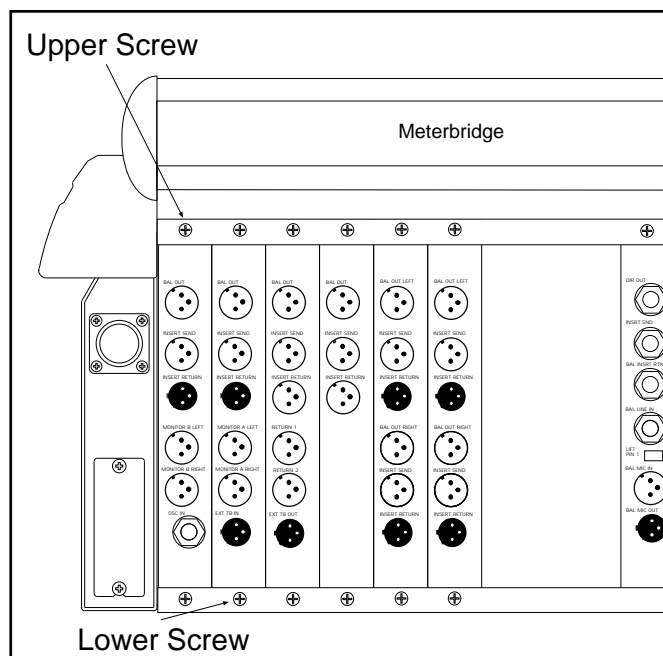

FIVE • Putting it all back together

Re-assembling a Century Series console is as easy as taking it apart, but only if you know where everything goes. If you are going to be removing a number of modules, consider replacing the first before removing the second. Reversing the above steps should result in the console being as well put together as it was when it left the factory.



IMPORTANT



Group Modules and Left/Right Modules are pre-assigned at the Crest factory

These modules must always be installed in the correct positions. They are NOT interchangeable without being properly re-assigned. Please contact the Crest Audio Service Department for more information.



Appendix B - Schematics

<u>SCHEMATIC NAME</u>	<u>#</u>	<u>NOTES</u>
MODULES		
STANDARD INPUT CONNECTOR PCB	1	Vx INPUT CONNECTOR PCB
STANDARD INPUT MAIN PCB	2	Vx INPUT MAIN PCB
LCR SUB PCB	3	LCRSUB01 Vx LCR SUB PCB
STEREO INPUT CONNECTOR PCB	4	Vx STEREO INPUT CONNECTOR PCB
STEREO INPUT MAIN PCB	5	Vx STEREO INPUT MAIN PCB
GROUP CONNECTOR PCB	6	Vx GROUP CONNECTOR PCB
GROUP MAIN PCB	7	Vx GROUP MAIN PCB
L / R CONNECTOR PCB	8	Vx LEFT/RIGHT CONNECTOR PCB
L / R MAIN PCB	9	Vx LEFT/RIGHT MAIN PCB
MONO CONNECTOR PCB	10	Vx MONO CONNECTOR PCB
MONO MAIN PCB	11	Vx MONO MAIN PCB
MASTER CONTROL CONNECTOR PCB	12	Vx MASTER CONNECTOR PCB
MASTER CONTROL MAIN PCB	13	Vx MASTER CONNECTOR PCB
MATRIX CONNECTOR PCB	14	Vx MATRIX CONNECTOR PCB
MATRIX MAIN PCB	15	Vx MATRIX MAIN PCB
METER BRIDGE		Vx/Vx Power-Dimmer-Demux PCB:
DIM-MUX1	16	DIMMER CIRCUIT
DIM-MUX2	17	POWER - DIMMER CIRCUIT
MTRDMUX1	18	METER DEMUX
MTRINTR1	19	METER DRIVER BOARD
GROUP / AUX METER PCB	20	Vx/Vx GROUP/AUX METER LED PCB
MST-LED1	21	Vx/Vx MASTER METERS LED PCB
POWER SUPPLY		
FRONT MODULE / LED PCB	22	PSU1 FRONT MODULE
REAR MODULE PCB	23	PSU2 REAR POWER MODULE PCB
CHASSIS WIRING	24	PSPLYBLK
CENTURY POWER SUPPLY TRANSFORMER	25	WIRING OPTIONS FOR 100/120, 220, 240V



Crest Audio Inc.

100 Eisenhower Dr., Paramus NJ 07652 USA

TEL: 201.909.8700 FAX: 201.909.8744

<http://www.crestaudio.com>

Printed in USA

Vx Owner's Manual
Copyright © 1997 Crest Audio Inc.
v 2.3 11/3/97 D7000004



D7000004

Free Manuals Download Website

<http://myh66.com>

<http://usermanuals.us>

<http://www.somanuals.com>

<http://www.4manuals.cc>

<http://www.manual-lib.com>

<http://www.404manual.com>

<http://www.luxmanual.com>

<http://aubethermostatmanual.com>

Golf course search by state

<http://golfingnear.com>

Email search by domain

<http://emailbydomain.com>

Auto manuals search

<http://auto.somanuals.com>

TV manuals search

<http://tv.somanuals.com>