

IMPORTANT NOTICE

Date January 5, 2008

Manual Affected CM9760-MDA System 9760® Master Distribution Amplifier Installation/Operation Manual, **C573M-D**

Manual Update The connection of a PC to multiple MDA units as illustrated in Figure 40 is not supported. Please disregard Figure 40 and all applicable references.

 **Green** The materials used in the manufacture of this document and its components are compliant to the requirements of Directive 2002/95/EC.

Pelco, the Pelco logo, and System 9760 are registered trademarks of Pelco, Inc.

©Copyright 2008, Pelco, Inc. All rights reserved.



Pelco, Inc. Worldwide Headquarters • 3500 Pelco Way • Clovis, California 93612 USA • www.pelco.com
USA & Canada • Tel: 800/289-9100 • Fax: 800/289-9150
International • Tel: 1-559/292-1981 • Fax: 1-559/348-1120

C1596M

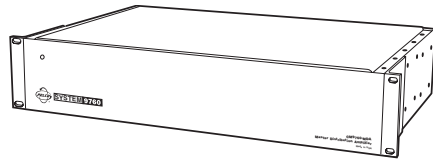

**CM9760-MDA
System 9760®
Master Distribution
Amplifier**

**Installation/
Operation Manual**

C573M-D (11/03)



Pelco World Headquarters • 3500 Pelco Way, Clovis, CA 93612-5699 USA • www.pelco.com

USA & Canada: Tel: 800/289-9100 • Fax: 800/289-9150

International: Tel: 1-559/292-1981 • Fax: 1-559/348-1120

CONTENTS

Section	Page
IMPORTANT SAFEGUARDS AND WARNINGS	4
DESCRIPTION	4
OVERVIEW	4
MODELS	6
MOUNTING	6
HARDWARE SETUP	6
COMMUNICATION	6
COMMUNICATION PORTS SETUP	7
ADDRESS SETUP FOR DAISY CHAINING	8
SETTING UP A UNIT AS THE MASTER CLOCK	9
RESETTING TO FACTORY DEFAULTS	9
CLEARING TITLE/TIME/DATE TEXT DISPLAY ON ALL CHANNELS	10
VIDEO CONNECTIONS	10
DATA CONNECTIONS	11
CONNECTING THE MDA TO A SYSTEM 9740/9760 CONTROLLER	11
CONNECTING THE MDA TO AN EXTERNAL PC	12
CONNECTING THE MDA TO A CM9760-KBD KEYBOARD	13
CONNECTING THE MDA TO A KBD200A OR KBD300A KEYBOARD	13
POWER CONNECTIONS	14
PROGRAMMING	15
TIME AND DATE SETUP	15
PROGRAMMING METHODS	15
PROGRAMMING WITH A KEYBOARD	15
KEYBOARD KEYS AND JOYSTICK	15
ENTERING THE PROGRAMMING MODE WITH THE CM9760-KBD	16
ENTERING THE PROGRAMMING MODE WITH THE KBD200A OR KBD300A KEYBOARD	16
MAIN MENU	17
SET CAMERA TITLE	17
SET CABLE COMPENSATION	18
SET CAMERA DISPLAY	18
SET TIME AND DATE	20
SET PORT	21
RESET MDA	22
PROGRAMMING WITH THE CM9760-MDA SETUP PROGRAM	22
CM9760-MDA SETUP PROGRAM DESCRIPTION	22
SYSTEM REQUIREMENTS	22
INSTALLING THE CM9760-MDA SETUP PROGRAM	23
STARTING THE CM9760-MDA SETUP PROGRAM	24
CM9760-MDA SETUP DIALOG BOX	25
SET PASSWORD	25
SET UNIT ID	26
SET SYSTEM	26
SET TIME AND DATE	28
SET TITLES	29
SET CABLE COMPENSATION	31
SET DISPLAY	32
SET MESSAGE TEXT	34
SEND DATA	40
VIDEO ALPHANUMERIC OVERLAYS	40
TROUBLESHOOTING	41
SPECIFICATIONS	42
APPENDIX A – APPLICATIONS	44
APPENDIX B – SUPPORTED TITLE AND MESSAGE TEXT CHARACTERS	56
APPENDIX C – MESSAGE TEXT INSERTION COMMANDS	57
WARRANTY AND RETURN INFORMATION	60

LIST OF ILLUSTRATIONS

Figure	Page
1	System Configuration (Rear Panel View)..... 5
2	Location of DIP Switches 7
3	DIP Switch 7
4	Connecting the MDA to a System 9760 11
5	PC Connection to CM9760-MDA 12
6	CM9760-KBD Setup for Direct Control 13
7	Keyboard Rear Panel 13
8	CM9760-MDA Keyboard Wiring 14
9	Main Menu 17
10	Set Camera Title Menu 17
11	Set Cable Compensation Menu 18
12	Set Camera Display Menu 18
13	Set Time and Date Menu 20
14	Set Port Menu 21
15	Reset CM9760-MDA Screen 22
16	Login Dialog Box 24
17	CM9760-MDA Setup Dialog Box 24
18	Old Password Dialog Box 25
19	New Password Dialog Box 25
20	Unit ID Dialog Box 26
21	MDA COM 1 Setup Dialog Box 26
22	System Communication Setup Dialog Box 27
23	Set Time and Date Dialog Box 28
24	Setting Titles Using the CM9760-MDA SETUP Dialog Box 29
25	Set Cable Compensation Dialog Box 31
26	Display Dialog Box 32
27	Position Text Dialog Box 33
28	Adjust Brightness Dialog Box 33
29	Output On/Off Dialog Box 33
30	Input On/Off Dialog Box 33
31	Message Text Editing Dialog Box 34
32	Command Data Window 35
33	Sample Display Screen Example 37
34	Sample Command Data Window 38
35	Typical Camera Display With Alphanumerics 40
36	CM9760-MDA Dimension Drawing 43
37	Simple System Configuration 45
38	Master MDA Time and Date Generator for 63 MDA Slave Units (64 Total MDA Units) 46
39	PC Connection to Up to 16 Daisy-Chained MDA Units 47
40	PC Connection to over 16 MDA Units (Maximum of 64 MDA Units) 48
41	CM9760-CC1 Connection to up to 16 Daisy-Chained MDA Units 49
42	CM9760-CC1 Connection to over 16 MDA Units (Maximum of 64 MDA Units) 50
43	MDA Connected to Multiplexers 51
44	Non-Coaxitron System Setup 52
45	Coaxitron with System 9760 Setup 53
46	Coaxitron with System 6800 Setup 54
47	CM9760-MDA Message Text Sent from Third-Party Equipment 55

LIST OF TABLES

Table	Page
A	Port Setup Switch Settings 7
B	Address Switch Settings 8
C	Video Coaxial Cable Wiring Distances 10
D	MDA RJ-45 Connector Pin-Outs 12
E	CM9760-CC1/CM9760-MDA Format Matchup 20
F	CM9760-CC1/CM9760-MDA Compatible Date Styles and Time Formats 29
G	Supported Title and Message Text Character Set 56
H	CM9760-MDA Message Text Insertion Commands 57

IMPORTANT SAFEGUARDS AND WARNINGS

Observe the following WARNINGS before installing and using this product.

1. Installation and servicing should be done by qualified service personnel only and conform to all local codes.
2. Unless the unit meets NEMA Type 3, 3R, 3S, 4, 4X, 6, or 6P standards, it is designed for indoor use only and must not be installed where exposed to rain and moisture.
3. Only use replacement parts Pelco recommends.
4. After replacing/repairing this unit's electrical components, conduct a resistance measurement between line and exposed parts to verify the exposed parts have not been connected to line circuitry.

The product and/or manual may bear the following marks:



This symbol indicates that dangerous voltage constituting a risk of electric shock is present within this unit.



This symbol indicates that there are important operating and maintenance instructions in the literature accompanying this unit.

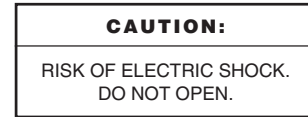

Please thoroughly familiarize yourself with the information in this manual prior to installation and operation.

DESCRIPTION

OVERVIEW

The CM9760 master distribution amplifier (CM9760-MDA), version 2.05 or higher, is a 16-channel video distribution amplifier that distributes video to multiple devices without image degradation. As illustrated in Figure 1, each of the 16 channels (video inputs) has four independent video outputs. Each of the video outputs can be connected to any of the following devices:

- Monitor
- Video printer
- Video cassette recorder (VCR)
- Digital video recorder (DVR)
- Multiplexer
- Matrix switcher

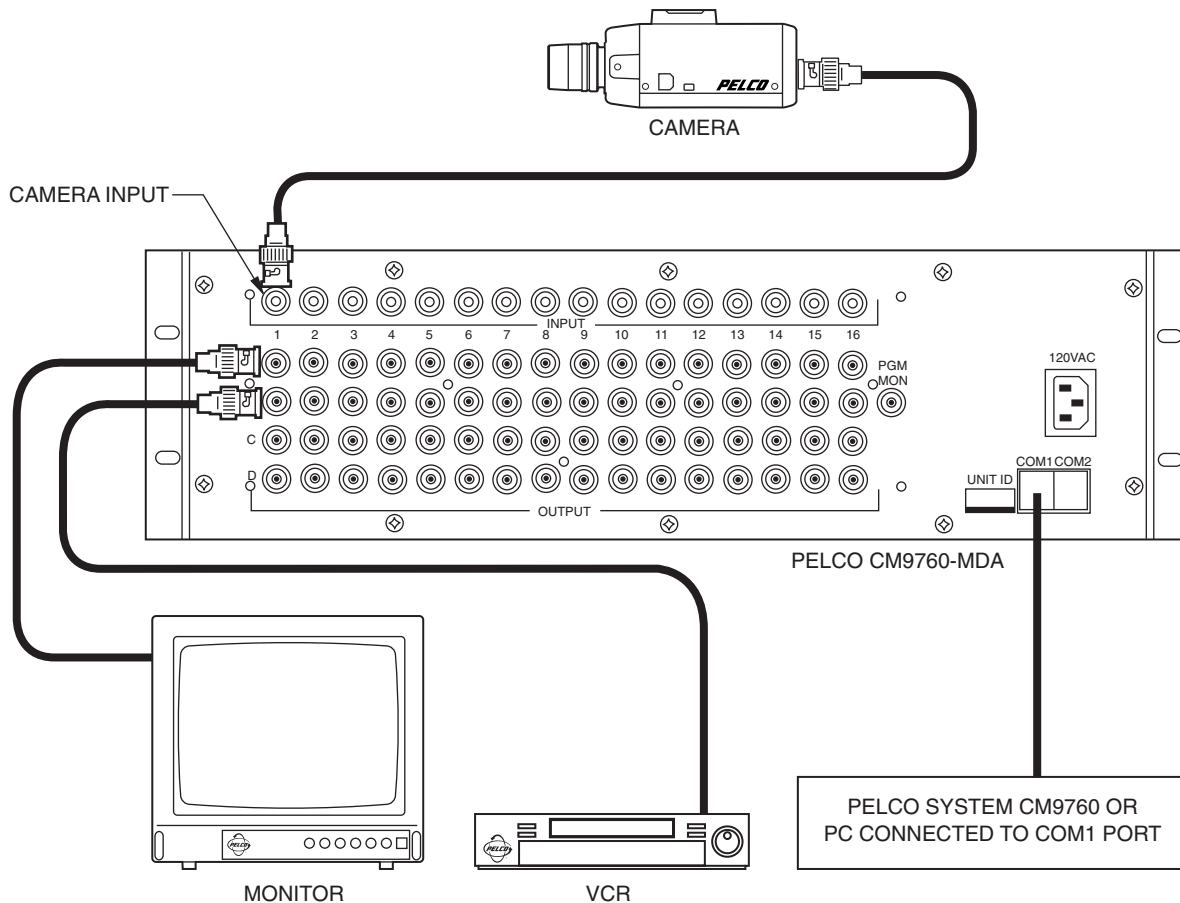

Figure 1. System Configuration (Rear Panel View)

The MDA can be programmed using a PC or a CM9760-KBD, KBD200A, or KBD300A keyboard. Each of the 16 video inputs can be individually programmed to insert time/date and title information on each video output, and each video output is selectable to include or exclude time/date and title generation. Character positions are adjustable horizontally and vertically on-screen with digital brightness control. Programming also includes cable compensation for up to 1,500 feet (457 m) of RG59/U coaxial cable.

The MDA can act as a stand-alone time/date and title generator or can be synchronized to a System 9740™/System 9760® as a matrix time/date and title generator:

- As a stand-alone unit, an MDA can be addressed to provide the master time and date for up to 63 MDA slave units.
- When connected to a System 9740/System 9760 CC1 port, up to 64 MDAs can accept the master time and date from the 9740/9760.

In addition, note the following about the MDA:

- Using the RS-232 or RS-422 communication standard, the MDA can accept text messages from third-party equipment. A message can contain up to 24 characters. Up to five lines of messages can be displayed simultaneously. The messages can be inserted onto any video channel independently. For additional information, refer to the *Set Message Text* section of this manual.
- All video inputs are individually ground isolated to prevent ground loops, eliminating the need for ground loop isolation transformers.
- Battery backup protects programming information for a minimum of one year.
- The MDA does not pass Coaxitron® signals; however, the MDA can be used with Coaxitron products such as the CM6700, CM6800, and the CM9760-CXTA.

NOTE: Up to 16 MDA units can be daisy-chained. If more than 16 MDAs are required, a CM9760-CDU-T must be used.

MODELS

CM9760-MDA	Master distribution amplifier with time and date and title, 120 VAC, 60 Hz (FCC)
CM9760-MDA-X	Same as CM9760-MDA except 230 VAC, 50 Hz (CE)

MOUNTING

VERY IMPORTANT: *If you are going to use RS-232 communication, you must open the case to set the DIP switches—do so BEFORE mounting the MDA unit in the rack. See the section on Communication Ports Setup and the section on Connecting the MDA to an External PC for information.*

Install the MDA in a standard 19-inch (48.26 cm) equipment rack using standard mounting hardware. The MDA occupies 5.25 inches (13.34 cm) of vertical space, or three RU (rack units).

HARDWARE SETUP

The following parts are supplied:

- 1 CM9760 Master Distribution Amplifier
- 1 Power cord
- 1 Data cable (reversed RJ-45 to RJ-45)
- 1 CM9760-MDA Resource CD

COMMUNICATION

Communication between MDA units, System 9760 CC1 (controller), System 9740 CC1 (controller), KBD200A or KBD300A keyboard, or a host PC is accomplished using serial RS-232, RS-422, or RS-485 transceivers that can be configured by DIP switches on the PCB (printed circuit board). The factory default for both COM 1 and COM 2 ports is RS-422.

COMMUNICATION PORTS SETUP

NOTE: COM 1 is configured at the factory for RS-422 communication. To communicate via RS-232, you must open the case and change an internal DIP switch.

There are two sets of DIP switches inside the MDA for selecting the type of interface for the communication ports (COM 1 and COM 2).

The unit comes from the factory configured for RS-422. If your communication scheme is RS-422 and you intend to program the MDA(s) through a CM9760-KBD, KBD200A or KBD300A keyboard, leave the settings alone.

However, if the communication scheme is different than RS-422, or you are going to program the MDA through a PC (which requires RS-232), do the following to change settings. (Generally, programming through a PC is easier than programming through a System 9760 keyboard. For more information, refer to the *Programming* section.)

1. Remove the 10 screws on the top cover and lift it off.
2. Refer to Figure 2 for the location of the switches for COM 1 and COM 2. Refer to Table A for the switch settings.
3. Replace the cover.

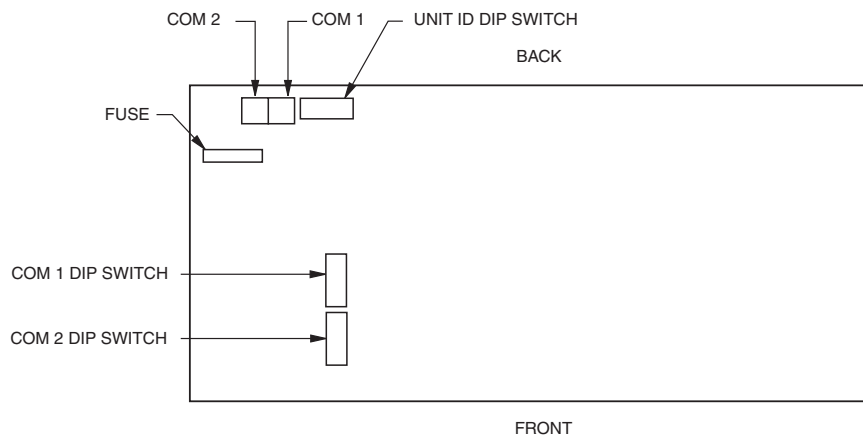

Figure 2. Location of DIP Switches

Table A. Port Setup Switch Settings

SWITCH SETTINGS								PORT SETUP SELECTED
1	2	3	4	5	6	7	8	
OFF	OFF	OFF	OFF	ON	ON	OFF	OFF	RS-232 Operation
ON	ON	ON	ON	OFF	OFF	OFF	OFF	RS-422 Operation*
ON	ON	ON	ON	OFF	OFF	ON	OFF	RS-485 Operation

* Factory default setting



Figure 3. DIP Switch

ADDRESS SETUP FOR DAISY CHAINING

NOTE: When upgrading CM9760-MDA units in a daisy chain to version 2.xx, version 2.xx units must be the first units in the daisy chain. Any CM9760-MDA version 1.xx units must be connected in the chain following all version 2.xx units.



CAUTION: Switch 7 clears all entered data from memory.

Table B. Address Switch Settings

ID	SWITCH SETTINGS						CAMERA RANGE SELECTED
	1	2	3	4	5	6	
1	OFF	OFF	OFF	OFF	OFF	OFF	Cameras 1-16
2	ON	OFF	OFF	OFF	OFF	OFF	Cameras 17-32
3	OFF	ON	OFF	OFF	OFF	OFF	Cameras 33-48
4	ON	ON	OFF	OFF	OFF	OFF	Cameras 49-64
5	OFF	OFF	ON	OFF	OFF	OFF	Cameras 65-80
6	ON	OFF	ON	OFF	OFF	OFF	Cameras 81-96
7	OFF	ON	ON	OFF	OFF	OFF	Cameras 97-112
8	ON	ON	ON	OFF	OFF	OFF	Cameras 113-128
9	OFF	OFF	OFF	ON	OFF	OFF	Cameras 129-144
10	ON	OFF	OFF	ON	OFF	OFF	Cameras 145-160
11	OFF	ON	OFF	ON	OFF	OFF	Cameras 161-176
12	ON	ON	OFF	ON	OFF	OFF	Cameras 177-192
13	OFF	OFF	ON	ON	OFF	OFF	Cameras 193-208
14	ON	OFF	ON	ON	OFF	OFF	Cameras 209-224
15	OFF	ON	ON	ON	OFF	OFF	Cameras 225-240
16	ON	ON	ON	ON	OFF	OFF	Cameras 241-256
17	OFF	OFF	OFF	OFF	ON	OFF	Cameras 257-272
18	ON	OFF	OFF	OFF	ON	OFF	Cameras 273-288
19	OFF	ON	OFF	OFF	ON	OFF	Cameras 289-304
20	ON	ON	OFF	OFF	ON	OFF	Cameras 305-320
21	OFF	OFF	ON	OFF	ON	OFF	Cameras 321-336
22	ON	OFF	ON	OFF	ON	OFF	Cameras 337-352
23	OFF	ON	ON	OFF	ON	OFF	Cameras 353-368
24	ON	ON	ON	OFF	ON	OFF	Cameras 369-384
25	OFF	OFF	OFF	ON	ON	OFF	Cameras 385-400
26	ON	OFF	OFF	ON	ON	OFF	Cameras 401-416
27	OFF	ON	OFF	ON	ON	OFF	Cameras 417-432
28	ON	ON	OFF	ON	ON	OFF	Cameras 433-448
29	OFF	OFF	ON	ON	ON	OFF	Cameras 449-464
30	ON	OFF	ON	ON	ON	OFF	Cameras 465-480
31	OFF	ON	ON	ON	ON	OFF	Cameras 481-496
32	ON	ON	ON	ON	ON	OFF	Cameras 497-512
33	OFF	OFF	OFF	OFF	OFF	ON	Cameras 513-528
34	ON	OFF	OFF	OFF	OFF	ON	Cameras 529-544
35	OFF	ON	OFF	OFF	OFF	ON	Cameras 545-560
36	ON	ON	OFF	OFF	OFF	ON	Cameras 561-576
37	OFF	OFF	ON	OFF	OFF	ON	Cameras 577-592
38	ON	OFF	ON	OFF	OFF	ON	Cameras 593-608
39	OFF	ON	ON	OFF	OFF	ON	Cameras 609-624
40	ON	ON	ON	OFF	OFF	ON	Cameras 625-640

(Continued on next page)

Table B. Address Switch Settings (Continued)

ID	SWITCH SETTINGS						CAMERA RANGE SELECTED
	1	2	3	4	5	6	
41	OFF	OFF	OFF	ON	OFF	ON	Cameras 641-656
42	ON	OFF	OFF	ON	OFF	ON	Cameras 657-672
43	OFF	ON	OFF	ON	OFF	ON	Cameras 673-688
44	ON	ON	OFF	ON	OFF	ON	Cameras 689-704
45	OFF	OFF	ON	ON	OFF	ON	Cameras 705-720
46	ON	OFF	ON	ON	OFF	ON	Cameras 721-736
47	OFF	ON	ON	ON	OFF	ON	Cameras 737-752
48	ON	ON	ON	ON	OFF	ON	Cameras 753-768
49	OFF	OFF	OFF	OFF	ON	ON	Cameras 769-784
50	ON	OFF	OFF	OFF	ON	ON	Cameras 785-800
51	OFF	ON	OFF	OFF	ON	ON	Cameras 801-816
52	ON	ON	OFF	OFF	ON	ON	Cameras 817-832
53	OFF	OFF	ON	OFF	ON	ON	Cameras 833-848
54	ON	OFF	ON	OFF	ON	ON	Cameras 849-864
55	OFF	ON	ON	OFF	ON	ON	Cameras 865-880
56	ON	ON	ON	OFF	ON	ON	Cameras 881-896
57	OFF	OFF	OFF	ON	ON	ON	Cameras 897-912
58	ON	OFF	OFF	ON	ON	ON	Cameras 913-928
59	OFF	ON	OFF	ON	ON	ON	Cameras 929-944
60	ON	ON	OFF	ON	ON	ON	Cameras 945-960
61	OFF	OFF	ON	ON	ON	ON	Cameras 961-976
62	ON	OFF	ON	ON	ON	ON	Cameras 977-992
63	OFF	ON	ON	ON	ON	ON	Cameras 993-1008
64	ON	ON	ON	ON	ON	ON	Cameras 1009-1024

SETTING UP A UNIT AS THE MASTER CLOCK

You can synchronize several CM9760-MDAs even when connecting them without a CM9760 switching system. The master clock can be any unit ID as long as it is the first unit of the chain. Make it the master clock by turning on switch 8 of the unit ID DIP switch on the rear panel. This unit will synchronize the time and date of all units connected to it. Only one unit can be a master clock. The remaining units are the slave units (unit ID DIP switch 8 is in the OFF position, which is the default setting). A single MDA unit can provide the master time and date for up to 63 slave units.



CAUTION:

Switch 7 clears all entered data from memory.

DO NOT turn off the MDA before the reset process finishes. *This can lock up the MDA and render it useless. The length of time to leave power on can vary from a few seconds to several minutes (for systems with a lot of equipment). To determine when the process finishes, look at the monitor outputs as resetting puts everything back to default status.*

RESETTING TO FACTORY DEFAULTS

You can reset the CM9760-MDA to factory defaults by turning on switch 7 of the UNIT ID DIP switch located on the rear panel. Do this before powering up the unit. Now, turn on the CM9760-MDA. This will clear all data stored in memory, such as titles and port configurations and resets them to the defaults as shipped from the factory. Then turn off the CM9760-MDA and turn switch 7 off.

CLEARING TITLE/TIME/DATE TEXT DISPLAY ON ALL CHANNELS

You can clear title/time/date text on all CM9760-MDA channels using a DIP switch method. To do so, proceed as follows:

1. Turn off the MDA.
2. Set the MDA to unit ID 33:
 - a. Set DIP switches 1, 2, 3, 4, and 5 to the OFF position.
 - b. Set DIP switch 6 to the ON position.
3. Turn on the MDA.

A 30-second timer starts.

4. Before the 30 seconds elapses, change the unit ID to a setting other than unit ID 33 using the appropriate DIP switch settings.

After 30 seconds have elapsed, the MDA checks whether the unit ID is different from the initial setting of 33. If the unit ID has changed, the MDA title/time/date text display is cleared.

Note the following:

- The title/time/date text can be programmed again using the PC or a CM9760-KBD, KBD200A, or KBD300A keyboard.
- If the MDA must be set back to unit ID 33, set the unit ID after the title/time/date text has cleared.

VIDEO CONNECTIONS

Table C. Video Coaxial Cable Wiring Distances

Cable Type*	Maximum Distance
RG59/U	750 ft (229 m)
RG6/U	1,000 ft (305 m)
RG11/U	1,500 ft (457 m)

*Minimum cable requirements:

- 75 ohms impedance
- All-copper center conductor
- All-copper braided shield with 95% braid coverage

1. Connect the remote video sources to the input BNC connectors on the rear panel of the MDA (refer to Figure 33). Refer to Table C for video coaxial wiring distances. (Note that when wiring inputs it is good installation practice to label each video input in case troubleshooting is required.)
2. Connect cables from the output BNC connectors on the MDA's rear panel to the input connectors of monitors, VCRs, switchers, etc. (refer to Figure 33). Refer to Table C for video coaxial wiring distances.

Although the MDA does not pass Coaxitron signals, it can be used with Coaxitron products—such as the CM6700, CM6800, and CM9760-CXTA—by installing the MDA **after** the Coaxitron equipment (refer to Figure 45 and to Figure 46).

DATA CONNECTIONS

The MDA can be connected to an external device via RS-232/422/485 standards. The distance at which it can be installed away from another device depends on the communication type and the wire size of the cable. Maximum cable distance for RS-232 serial data for 18-24 AWG is 50 feet (15.24 m) while the maximum for RS-422 and RS-485 with 24-gauge wire is 4,000 feet (1,219 m). For longer distances, junction boxes and heavier cable can be used. Pelco recommends using shielded twisted pair, such as Belden 9843 or similar cable, meeting or exceeding the basic requirements for EIA RS-422/485 applications. Decide where the MDA will be located and follow the mounting and connection instructions.

CONNECTING THE MDA TO A SYSTEM 9740/9760 CONTROLLER

The rear panel of the MDA contains two RJ-45 modular connectors for external data communication using RS-232, RS-422, or RS-485 standards. Connect the COM 1 port on the MDA's rear panel to the next available RJ-45 output connector on the System 9740/9760 controller (refer to Figure 4 for an illustration of MDA connection to a System 9760 controller.) The System 9740/9760 controller port to which the MDA is connected must be programmed for proper communication with an MDA. Refer to the System CM9760-CC1 manual or to the System CM9740-CC1 manual for information about selecting and configuring the RJ-45 ports on the System 9740/9760 controller.

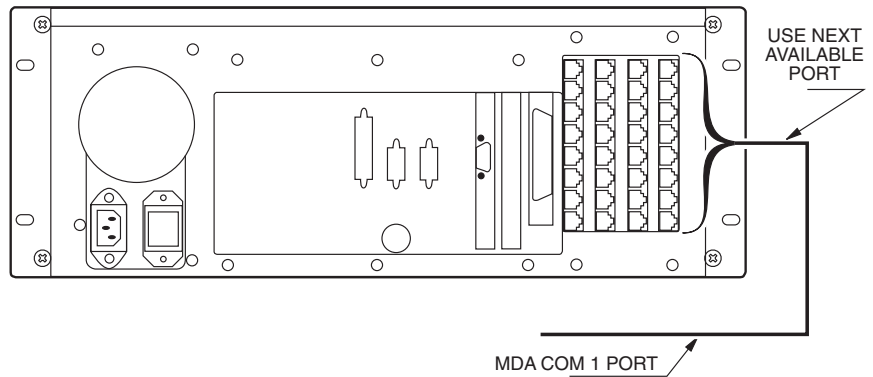

Figure 4. Connecting the MDA to a System 9760

Refer to Figure 37 and to Figure 38 for illustrations of connecting multiple MDA units to a System 9760 controller.

NOTE: The CM9760-MDA is configured at the factory for RS-422 communication. To communicate via RS-232, an internal DIP switch must be changed. Refer to the Communication Ports Setup section.

CONNECTING THE MDA TO AN EXTERNAL PC

Perform this step if you are going to program your CM9760-MDA unit using a PC (personal computer).

Refer to Figure 5 and make a cable to connect the MDA to the PC. The figure shows a typical nine-pin sub "D" connector for the PC's COM 1/COM 2 serial port. Computers may differ regarding connector types and pin-outs. Therefore, always refer to the computer's manual to determine proper pin-outs.

If more than one MDA is to be programmed using a PC, note the following:

- A maximum of 16 MDA units can be daisy-chained. To daisy-chain up to 16 MDA units, connect the RS-422 output of the first MDA unit to the RS-422 input of the second MDA unit and continue this method until the last MDA unit is connected (refer to Table D and to Figure 39).
- If more than 16 MDAs are to be connected to a PC, a CM9760-CDU-T must be used. Refer to Figure 40 for an example of connecting over 16 MDAs to a PC. Note that a maximum of 64 MDA units can be connected to a PC for programming.

Table D. MDA RJ-45 Connector Pin-Outs

Pin Out	RS-232 Function	RS-422 Function	RS-485 Function
1	Transmit	Transmit +	Transmit +
2	No Connection	Transmit -	Transmit -
3	No Connection	No Connection	No Connection
4	Ground	Ground	Ground
5	Ground	Ground	Ground
6	No Connection	No Connection	No Connection
7	No Connection	Receive -	Receive -
8	Receive	Receive +	Receive +

NOTE: The pin numbering of the wall block shown in Figure 5 applies to the Pelco RJ-45 wall block. A wall block purchased from a supplier other than Pelco may have a different pin numbering scheme.

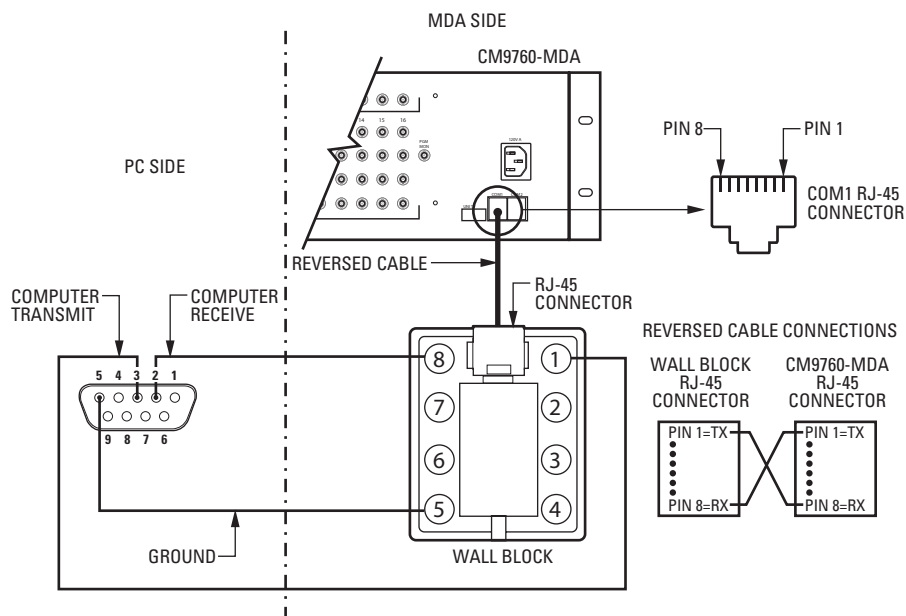

Figure 5. PC Connection to CM9760-MDA

CONNECTING THE MDA TO A CM9760-KBD KEYBOARD

(Refer to Figure 6). Perform this step if you are going to program your CM9760-MDA unit using the CM9760-KBD keyboard. Connect the serial port of your keyboard to the COM 1 port on the MDA unit. To do more than one MDA unit, each time you will need to unhook the keyboard from the MDA unit you just programmed and hook the keyboard to the next MDA unit.

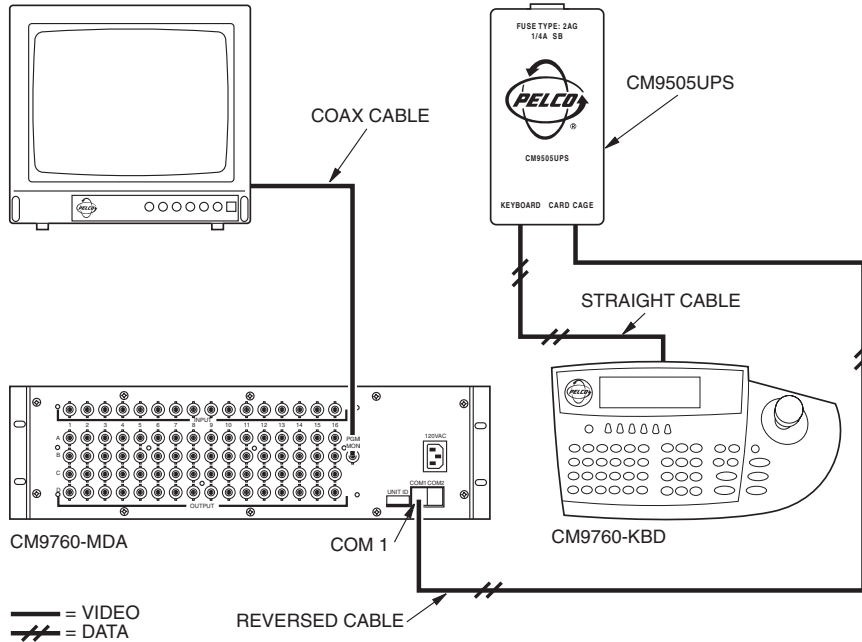

Figure 6. CM9760-KBD Setup for Direct Control

NOTE: You need two keyboard data cables for this connection. You must modify one cable as explained in Keyboard Wiring on the next page.

CONNECTING THE MDA TO A KBD200A OR KBD300A KEYBOARD

A single KBD200A or KBD300A keyboard can be used to program the CM9760-MDA Master Distribution Amplifier. The keyboard is connected to the COM 1 port of the distribution amplifier through a KBDKIT (120 VAC) or KBDKIT-X (230 VAC) wall block and a specially modified keyboard data cable. Connect your monitor as shown in Figure 6.

Switch Settings

To set the switches in the keyboard (refer to Figure 7):

1. Remove the two screws and the DIP switch cover plate from the rear of the keyboard.
2. Place switches 5 and 8 in the ON position. This selects the CM9760-MDA mode of operation.
3. Replace the cover plate.

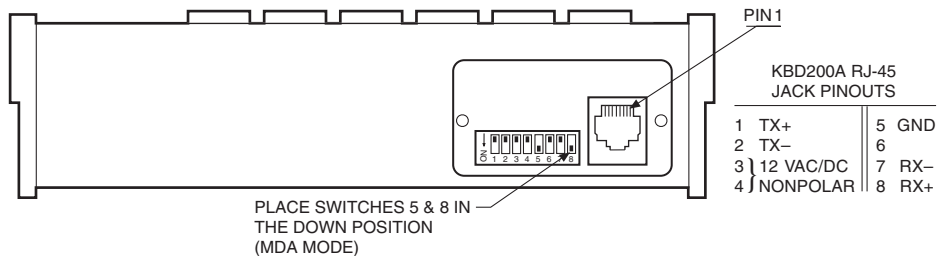

Figure 7. Keyboard Rear Panel

Keyboard Wiring

Refer to Figure 8.

1. Use the supplied keyboard data cable to connect the keyboard to the RJ-45 jack on the wall block.
2. Remove the RJ-45 plug from one end of a second keyboard data cable and strip the cable jacket back 2 inches (5 cm).
3. Hold up the end of the cable that has the RJ-45 plug still attached and examine the wire colors going to each pin. (Refer to the "check wire colors" detail in Figure 8.) Make note of the colors going to pins 7 and 8.
4. Connect the stripped wires to the wall block as follows:
 - Wire from RJ-45 pin 8 to wall block terminal 1;
 - Wire from RJ-45 pin 7 to wall block terminal 2;
 - Cut the unused wires back to the cable jacket.
5. Plug the RJ-45 end of the second (modified) keyboard data cable into the COM1 port on the master distribution amplifier.
6. Plug the KBDKIT or KBDKIT-X into a suitable outlet.

POWER CONNECTIONS

NOTE: Always replace blown fuses with fuses of the same rating. Failure to do so could result in serious damage to the unit.

The MDA's rear panel contains a three-pronged 120 VAC receptacle. Use the supplied power cord to connect the MDA to a power source.

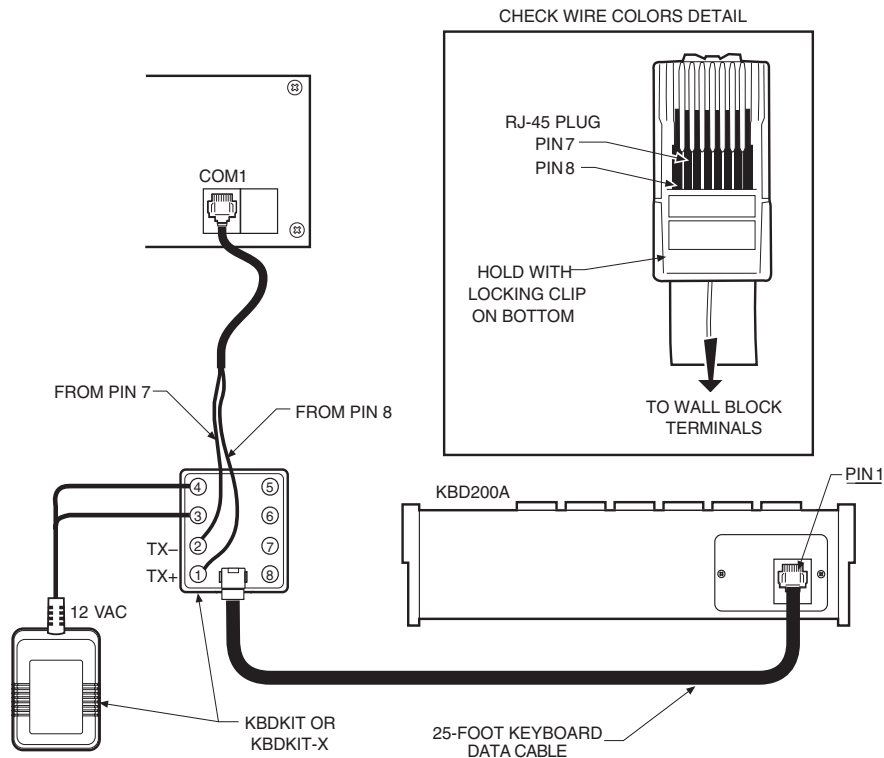

Figure 8. CM9760-MDA Keyboard Wiring

PROGRAMMING

TIME AND DATE SETUP

You can apply a single time and date and camera title to each input channel, which will appear on all four output channels. You can also select whether the channel will display:

- Time, date, and title
- Time and date only
- Title only
- No added text

In addition, you can select:

- Time and date format, and set the title to be displayed
- Character brightness
- On-screen location for time, date, and title

PROGRAMMING METHODS

NOTE: *The CM9760-MDA Setup program provides an interface that supports the message text feature of the MDA. (For additional information, refer to the Set Message Text section of this manual.) The CM9760-KBD, KBD200A, and KBD300A keyboards do not provide an interface that supports message text.*

The MDA unit is password protected and can be programmed by using a CM9760-KBD, KBD200A, or KBD300A keyboard or by using a PC.

There are two DIP switches to select the input and output port formats, and one to identify the MDA unit. See the *Communication Ports Setup* and *Address Setup for Daisy Chaining* sections for information on the DIP switches.

You can program the unit in two ways.

- The first method uses a CM9760-KBD, KBD200A, or KBD300A keyboard and the programming monitor output. See the *Programming with a Keyboard* section for instructions.
- The second method requires a PC running Microsoft® Windows® and the CM9760-MDA Setup program. See the *Programming with the CM9760-MDA Setup Program* section for instructions.

PROGRAMMING WITH A KEYBOARD

The KBD200A uses keys for pan/tilt, while the CM9760-KBD and KBD300A use a joystick.

KEYBOARD KEYS AND JOYSTICK

Use the keyboard and the programming video output to manually program the CM9760-MDA.

Any joystick motion or pan/tilt key activates the Main Menu. Use the joystick or pan/tilt keys to navigate menus. Use the following keyboard keys to program the MDA.

Open	Use this key to move down through selections in program mode.
Close	Use this key to move up through selections in program mode.
Near	Use this key to quickly exit a menu and return to the Main Menu from any submenu or to exit program mode without having to select EXIT on the Main Menu.
Pan/Tilt Controls	The pan/tilt keys or joystick controls the cursor's position. Moving the joystick up and down or pressing the up/down keys maneuvers through the menu selection. Moving the joystick left and right or pressing the left/right keys positions the cursor horizontally when a menu has more than one item on a line. Moving the cursor to the right on RETURN on a menu, or on any item in the Main Menu, selects the item.
Blue Buttons	(Not applicable to the KBD200A/300A keyboards.) The line of blue buttons directly below the CM9760-KBD keyboard screen corresponds to the line of icons on the bottom of the screen. To select one of the icons, press the blue button directly beneath it.

NOTE: You need a password to enter setup mode on the CM9760-KBD keyboard. The default, as set from the factory, is 1234.

ENTERING THE PROGRAMMING MODE WITH THE CM9760-KBD

Use the CM9760-KBD keyboard to program the titles, time, date, and setup of the ports.

1. To enter programming mode from the keyboard, you must first enter the setup mode for the keyboard. Attach a straight power cable from COM 1 on the rear of keyboard to the power supply. (The LCD displays the keyboard offline message.)
2. Set DIP switch 2 (on the underside of the CM9760-KBD) to ON.
3. You are prompted to enter the setup PIN. (The factory default is 1234.) Do so, and the main setup mode menu appears.
4. Press the blue button beneath the ADV icon. The Advance Setup 1 screen appears.
5. You have to set the KBD in direct mode. To do so, cycle the host type by pressing the blue buttons below the left and right arrow icons (<= and =>) until the LCD shows "HOST DIRECT CAM CTRL."
6. Press the blue button beneath the Step Forward icon (hand that points down) to go to the next line. Change the baud rate from 4800 to 9600 by pressing the blue button beneath the right arrow icon.
7. Press the blue button beneath the SAVE icon.
8. Press the blue button beneath the exit icon (an open door).
9. Press the blue button beneath the camera icon.
10. Press the blue button beneath the Step Forward icon (hand pointing down) four times.
11. You need to define a camera. You are currently on physical 0, logical 0. You need to change the logical to 1.
 - a. Press the blue button beneath the DEF NUM icon (this reverses videos).
 - b. Press 1.
 - c. Press the blue button beneath the DEF NUM icon. Physical 0 should now have a logical 1.
 - d. Press the blue button beneath the SAVE icon.
12. Press the blue button beneath the exit icon (an open door) twice.
13. You are prompted to turn off DIP switch 2. Do so.
14. Connect a reversed cable from the power supply to COM 1 on the rear of the MDA.
15. Access the main programming menu by moving the joystick in any direction (see Figure 9, Main Menu). You can now begin programming.
16. When you finish programming, select EXIT from the Main Menu. Then disconnect the keyboard to exit programming mode.

ENTERING THE PROGRAMMING MODE WITH THE KBD200A OR KBD300A KEYBOARD

1. Access the main programming menu by moving the joystick in any direction (KBD300A) or by pressing any pan/tilt key (KBD200A) (see Figure 9, Main Menu). You can now begin programming.
2. When you finish programming, select EXIT from the Main Menu. Then disconnect the keyboard to fully exit the programming mode.

MAIN MENU

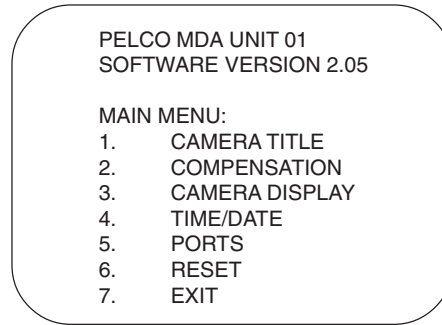

Figure 9. Main Menu

The fields in the Main Menu (Figure 9) are defined as follows:

NOTE: If you are using a KBD200A keyboard, use the appropriate pan/tilt key (up, down, right, left) in place of moving the joystick.

PELCO MDA UNIT	The first line is the title line. It contains the Unit ID as set from the MDA unit's rear panel.
SOFTWARE VERSION	This field shows the version of software being used.
MAIN MENU	This field instructs you to pick an item to set from the six selections listed or to exit the setup program.

A number precedes each of the seven selections. It flashes when the cursor is positioned on it. To select an item, move the keyboard's joystick up or down to position the cursor on the item you desire, then press the joystick to the right.

Selecting items 1 through 6 will display another menu. When you finish programming, select EXIT and press the joystick right, or exit by pressing the NEAR key.

SET CAMERA TITLE

If you choose item 1 on the Main Menu, the program displays the following menu:

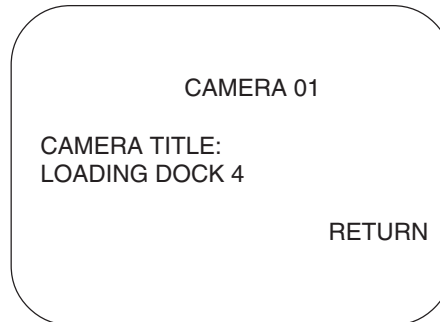

Figure 10. Set Camera Title Menu

Use this menu to enter a camera title. When the program displays this menu, the camera number flashes on the menu's top line.

- If you want to edit the information for the camera number displayed, press the OPEN key.
- If you want a different camera, press the joystick to the right to bring up the next camera.

The title already programmed for the selected camera is displayed.

Use the joystick to access the title. Move the joystick left and right to position the cursor over a character in the title. Use the OPEN/CLOSE key to access a character. Pressing the joystick right places the cursor on the next character to program.

When you finish programming the title, press the joystick down to move the cursor to RETURN on the menu and then press the joystick to the right. This returns you to the Main Menu.

SET CABLE COMPENSATION

If you choose item 2 on the Main Menu, the program displays the following menu:

CABLE COMPENSATION					
CAM	CMP	CAM	CMP	CAM	CMP
1	1	7	1	12	1
2	1	8	1	13	2
3	1	9	1	14	3
4	1	10	1	15	4
5	1	11	1	16	1
6	1	12	1		
RETURN					

Figure 11. Set Cable Compensation Menu

Transmitting video signals over long distances can adversely affect video images. However, compensation can be used to adjust for video signal degradation.

When the system displays the menu, the cursor flashes on the compensation setting for camera 1.

To change the compensation (CMP) entry, use the joystick to move to the input (1-16) for which you want to change the compensation. For example, moving the joystick down positions the cursor at the entry for camera 2. Press the OPEN key to toggle through the settings. The settings are numbered 1-4. Setting 1 is for no compensation, setting 2 is for a video input that is 500 feet (152 m) from the CM9760-MDA, setting 3 is for 1,000 feet (304 m), and setting 4 is for 1,500 feet (457 m).

To exit the menu, position the cursor on the R in RETURN and press the joystick right.

SET CAMERA DISPLAY

If you choose item 3 on the Main Menu, the program displays the following menu:

CAMERA 01 DISPLAY				
1. POSITION DISPLAY				
BRIGHTNESS:			8	
ENABLE TITLES:			ON	
ENABLE TIME DATE:			ON	
ENABLE VIDEO DISPLAY				
OUTPUT:	A	B	C	D
	ON	OFF	ON	OFF
RETURN				

Figure 12. Set Camera Display Menu

This menu contains setup information for how the camera display will look. You can turn the camera display for each output on or off. You can also adjust and set the characters' brightness and position. These two settings are universal for all cameras.

When the program displays this menu, the camera number on the top line flashes. Press the joystick right to select the next camera if you do not want to program output, brightness, or text position for the current camera. Use the OPEN key to select the three items to be adjusted on this menu.

NOTE: *At least one output display must be turned on and you must use this output on a monitor to see its position.*

The fields (or items to be set) are defined as follows:

- POSITION DISPLAY** The first item to set is the display position, which is digitally selected and controlled by the keyboard. To move the output display, position the cursor at item 1. The "1" flashes. Press the joystick right to choose the item. Press the joystick up/down and left/right to position the display on the monitor. See Figure 35 for the output display. At least one output display must be on and you must use this output on a monitor to see its position. To return to the Camera Display Menu after setting the position display, press the OPEN or CLOSE key.
- BRIGHTNESS** To set brightness, press the joystick down to position the cursor at the brightness item on the menu. Use the OPEN key to increase brightness and the CLOSE key to decrease it. Brightness numbers range from 1 (darkest) to 8 (brightest). Brightness changes on the menu as you change the number.
- ENABLE TITLES** You toggle this field on/off by placing the cursor on the selection and pressing the OPEN key. You can activate or deactivate the titles on a camera-by-camera basis. The selection immediately appears on the menu.
- ENABLE TIME DATE** You toggle this field on/off by placing the cursor on the selection and pressing the OPEN key. You can activate or deactivate the time and date on a camera-by-camera basis. The selection immediately appears on the menu.
- ENABLE VIDEO DISPLAY OUTPUT** Use this field to direct the alphanumeric data (text) to the desired output. In the example in Figure 12, outputs 1 and 3 will have alphanumeric information while outputs 2 and 4 will not. To change the settings, position the cursor at locations A, B, C, or D and press the OPEN or CLOSE key to turn the settings ON or OFF.

As shipped from the factory, the four outputs for the title, time, and date display are ON. Brightness is set to level 5.

Position the cursor at RETURN and press the joystick right to return to the Main Menu. You can also press the NEAR key to exit this menu.

SET TIME AND DATE

If you choose item 4 on the Main Menu, the program displays the following menu:



Figure 13. Set Time and Date Menu

The CM9760-MDA supports four of the CM9760-CC1's time and date formats; and the MDA's format must match the CC1's format for correct updating of the MDA from the CC1 to occur. Table E shows how the supported formats should be matched.

Table E. CM9760-CC1/CM9760-MDA Format Matchup

CM9760-CC1 Format #	CM9760-CC1 Format Example	CM9760-MDA Format
0	16/11/03 17:56	DD-MM-YY 24 hour
1	11/16/03 17:56	MM-DD-YY 24 hour
2	16/11/03 05:56 PM	DD-MM-YY 12 hour
3	11/16/03 05:56 PM	MM-DD-YY 12 hour

Press the joystick up/down and left/right to move through the four general selections on the menu. If you press the joystick right for any selection in the set time or date areas of this menu without first entering a number, the program keeps the existing information for the field and moves you to the next field.

The fields are defined as follows:

DATE When the program displays this menu, the cursor flashes on the month entry in this field. To change the month entry, press the OPEN or CLOSE key to pick the number of the month you want. Then press the joystick right to enter your selection. This also moves you to the next entry (day) on the line.

If you want to leave the month area without changing the month, just press the joystick right. This moves the cursor to the day area.

Select the day using the OPEN or CLOSE key. Depending on the month, the number of days will be 28, 29, 30, or 31. To enter your selection, press the joystick right.

After you enter a day, the year flashes. Use the OPEN or CLOSE key to choose a number between 0 and 99 for the year. Then press the joystick right to enter your selection.

TIME Select the hour, minute, and second in the same way you selected the month, day, and year in the previous field.

STYLE The four styles for date display are mm dd yy, dd mm yy, mmm dd yy, and dd mmm yy where mm = 2-digit month, mmm = 3-letter month abbreviation, dd = 2-digit day, and yy = 2-digit year. Use the OPEN or CLOSE key to make your selection. Then press the joystick right to enter your selection. Refer to Table E for formats compatible with the CM9760-CC1.

TYPE The time types are 12-hour and 24-hour (military time). In 12-hour mode, the program displays an AM or PM on the monitor. Use the OPEN or CLOSE key to make your selection. Then press the joystick right to enter your selection.

When you finish entering information, press the joystick down to place the cursor at RETURN on the menu. Press the joystick right to return to the Main Menu.

SET PORT

If you choose item 5 on the Main Menu, the program displays the following menu:

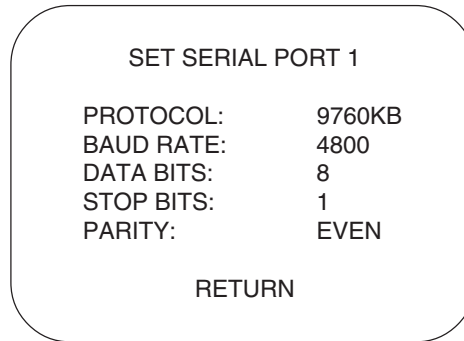

Figure 14. Set Port Menu

This menu lets you view the settings of the two ports, and change the settings in one of them.

- The Port 1 menu settings **can** be changed. The Port 1 menu lets you pick what you want to connect to Port 1—an ASCII device (such as a PC), a CM9760 keyboard, a CM9760 CC1, or an MDA loop. You use the menu's Protocol field to select which one.

You use the remaining four fields (Baud Rate, Data Bits, Stop Bits, and Parity) to set the communication parameters for what you picked in the Protocol field.

- The Port 2 menu settings **cannot** be changed. Port 2 is locked as the MDA loop-out port. It is set up so you can plug a CM9760-KBD keyboard into it and program the MDA.

When the program displays the menu, the "1" in "Port 1" flashes. (To view the setup for Port 2, press the joystick right.)

To set up Port 1, press the OPEN key. The selection in the Protocol field flashes.

PROTOCOL Use the OPEN and CLOSE keys to cycle through the four types of protocol. These are Terminal (ASCII device), CM9760-KBD, CM9760-CC1, and MDA Loop.

- BAUD RATE**
- If you chose Terminal in the Protocol field above, the ASCII protocol for external devices other than a keyboard or Pelco system is activated. The available baud rates are 1200, 2400, 4800, and 9600 bits per second. In Terminal mode, you can also select the data bit length, the number of stop bits, and the parity type. Place the cursor on the displayed rate and press the OPEN/CLOSE key to cycle forward and backward through the options.
 - If you chose CM9760-KBD in the Protocol field above, 9600 baud is displayed but cannot be changed.
 - If you chose CM9760 CC1, 9600 baud is displayed, which cannot be changed. This selection is used for connecting to the CM9760 Controller, which provides the timing signal for the MDAs. (**NOTE:** The baud rate must equal that which was selected from the system.)
 - If you chose MDA Loop in the Protocol field above, 9600 baud is displayed but cannot be changed.

DATA BITS The number flashes. To select the number of data bits, use the OPEN or CLOSE key to choose between 7 and 8 bits. Press the joystick down to move to the next field.

NOTE: The following can only be adjusted in Terminal mode.

STOP BITS The number flashes. Use the OPEN or CLOSE key to choose between 1 and 2 stop bits. Press the joystick down to move to the next field.

PARITY The three options for this field are none, odd, and even. The first character in the word flashes when you access this field. Use the OPEN or CLOSE key to move through the three selections. When you leave this field, the program keeps the last selection.

Position the cursor at RETURN and press the joystick right to return to the Main Menu, or press the NEAR key.

RESET MDA

If you choose item 6 on the Main Menu, the program displays the following menu:

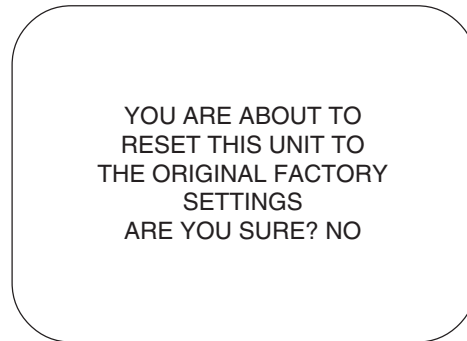

Figure 15. Reset CM9760-MDA Screen

This screen lets you reset the CM9760-MDA's software to the original factory settings. You can change the selection from "NO" to "YES" on the line that asks "ARE YOU SURE?" by pressing the OPEN key. The unit returns to the original factory settings for titles, cable compensation, time, date, and communication ports when you place the cursor on RETURN and press the joystick right.

Position the cursor at RETURN and press the joystick right to return to the Main Menu, or press the NEAR key.

PROGRAMMING WITH THE CM9760-MDA SETUP PROGRAM

CM9760-MDA SETUP PROGRAM DESCRIPTION

Using a PC, the CM9760-MDA Setup program allows you to set camera titles, cable compensation, camera display, time and date, and message text for each video output. The program is useful when multiple CM9760-MDA units are used in one installation.

SYSTEM REQUIREMENTS

The CM9760-MDA Setup program is provided on the CM9760-MDA Resource CD. System requirements are as follows:

- Microsoft Windows 98, 2000, NT, or XP
- Intel486™ or Pentium® processor-based PC
- 16 MB or more of RAM
- 25 MB of free hard disk space
- CD-ROM drive

INSTALLING THE CM9760-MDA SETUP PROGRAM

The following procedure provides instructions to install the CM9760-MDA Setup program on a PC that meets or exceeds minimum system requirements (see *System Requirements* above). (For information about connecting the PC to the CM9760-MDA, see *Connecting the MDA to an External PC* earlier in this manual.)

To install the CM9760-MDA Setup program, do the following:

1. Start Microsoft Windows. If Microsoft Windows is already running, close any application programs that may be running.

2. Insert the CM9760-MDA Resource CD into the CD-ROM drive.

The CD automatically starts and the CM9760-MDA Setup dialog box appears.

3. Click CM9760-MDA Software.

The Welcome dialog box appears.

4. Click OK.

The CM9760-MDA Setup software installation dialog box appears.

5. Begin CM9760-MDA Setup software installation by doing one of the following:

- Install CM9760-MDA Setup software into the default destination directory by clicking the button indicated in the on-screen instructions. The default installation directory is as follows:

C:\Program Files\CM9760-MDA Setup\

- If necessary, change the installation destination directory by clicking Change Directory:

- a. Enter or select the destination directory and then click OK.

The CM9760-MDA Setup software installation dialog box reappears.

- b. Click the button indicated in the on-screen instructions to install the CM9760-MDA Setup software.

The CM9760-MDA Setup – Choose Program Group dialog box appears.

6. Do one of the following:

- Accept the default program group name, CM9760-MDA SETUP, by clicking Continue.
- Enter a new program group name or select a name from the Existing Groups list, and then click Continue.

A message appears indicating that the CM9760-MDA Setup program was installed successfully.

7. Click OK.

STARTING THE CM9760-MDA SETUP PROGRAM

To start the CM9760-MDA Setup program, do the following:

1. In the Windows taskbar, click the Start button, point to Programs > CM9760-MDA SETUP, and then click CM9760-MDA SETUP.

The CM9760-MDA SETUP introductory screen appears followed by the Login dialog box shown in Figure 16.

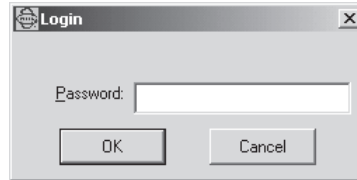

Figure 16. Login Dialog Box

2. Enter the password and then click OK. The default password is **2899100**. (To set a new password, refer to the *Set Password* section later in this manual.)

The CM9760-MDA SETUP dialog box appears as shown in Figure 17.

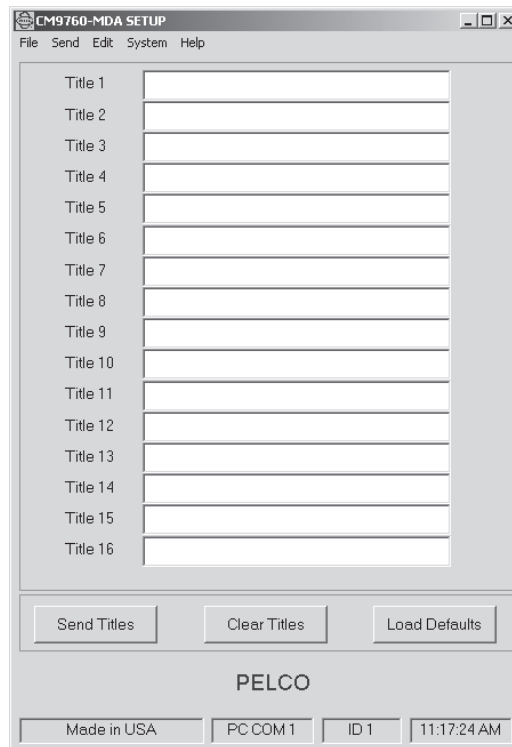

Figure 17. CM9760-MDA SETUP Dialog Box

For information about the CM9760-MDA SETUP dialog box, see the following section titled *CM9760-MDA SETUP Dialog Box*.

CM9760-MDA SETUP DIALOG BOX

The CM9760-MDA SETUP dialog box, Figure 17, is the main window of the CM9760-MDA Setup program. Menus at the top of the dialog box let you access other menus and operation windows. The following sections provide detailed information about the functions that can be performed using the CM9760-MDA SETUP dialog box:

- The *Set Password* section tells you how to change the current password used to enter the CM9760-MDA Setup program.
- The *Set Unit ID* section describes how to select the unit you want.
- The *Set System* section deals with the setup of the communication parameters for the CM9760-MDA Setup program and the CM9760-MDA unit and with the reset of MDA software.
- The *Set Time and Date*, *Set Unit ID*, *Set Titles*, *Set Cable Compensation*, *Set Display*, and *Set Message Text* sections deal with the setup of the data to be used by the CM9760-MDA and the CM9760-MDA Setup program.
- The *Send Data* section describes how to send time and date, titles, or both.

SET PASSWORD

To change the password used to enter the CM9760-MDA Setup program, click Edit and then click Password on the CM9760-MDA SETUP dialog box. As shown in Figure 18, a dialog box appears asking you to enter the old (current) password.

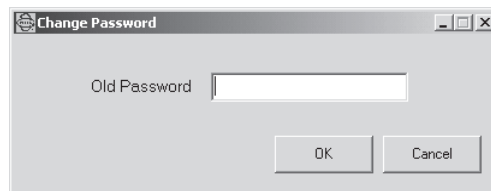

Figure 18. Old Password Dialog Box

Enter the current password, and then click OK.

As shown in Figure 19, another dialog box appears asking you to enter a new password and to verify the new password by entering it a second time.

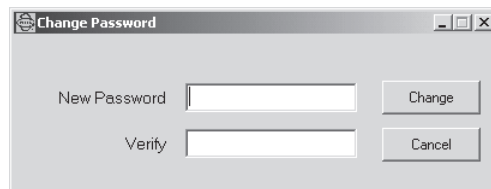

Figure 19. New Password Dialog Box

After entering and verifying your new password, click the Change button to load your new password. If you decide not to change your password, click the Cancel button.

SET UNIT ID

To enter the MDA unit for which you want to assign or modify settings, click Edit on the CM9760-MDA SETUP dialog box and then click Unit ID. The Unit ID dialog box, Figure 20, appears.

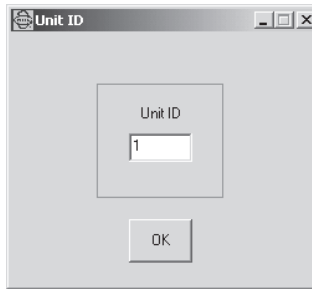

Figure 20. Unit ID Dialog Box

Enter the Unit ID number (1-64), and then click OK.



CAUTION:

Be careful when changing the selections on the CM9760-MDA ports. You could accidentally change the port setting and lose communication with your system!

SET SYSTEM

The System menu allows you to set up communication ports for the CM9760-MDA and the PC and to reset MDA software to factory default settings.

CM9760-MDA Communication: To set up the communication port for the CM9760-MDA unit, click System on the CM9760-MDA SETUP dialog box and then click MDA COM1 Setup. The MDA COM 1 Setup dialog box, Figure 21, appears.

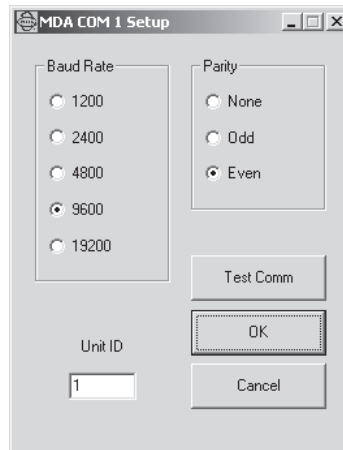

Figure 21. MDA COM 1 Setup Dialog Box

Set communication parameters for the COM 1 port of the CM9760-MDA as follows:

1. Select the baud rate by clicking the option button next to the desired setting. The default is 9600.
2. Select the parity by clicking the option button next to the desired setting. The default is Even.
3. Enter the unit ID number of the MDA to which you are sending the data. The unit ID number ranges from 1 to 64. The default is 1.
4. Click OK.
A Warning dialog box appears indicating that the CM9760-MDA COM 1 port settings will be changed and that the PC serial port settings will be updated accordingly.
5. Click OK.
A confirmation dialog box appears indicating that the MDA COM 1 port settings were changed.

NOTE: *The baud rate and parity settings of the connected CM9760-MDA COM 1 port and PC port must match.*

NOTE: Clicking Cancel on the MDA COM 1 Setup dialog box does not cancel the MDA COM 1 port setting changes you made. Clicking Cancel only closes the dialog box.

6. Click OK. The MDA COM 1 Setup dialog box remains on the screen displaying the updated port settings.
7. Test the CM9760-MDA communication port by clicking Test Comm:
 - If communication between the MDA COM 1 port and the PC port has been established, an information dialog box appears confirming communication between the ports. Click OK on the information dialog box, and then click Cancel on the MDA COM 1 Setup dialog box to close the dialog box.
 - If communication between the MDA COM 1 port and the PC port has not been established, a No Response dialog box appears instructing you to check the PC port and unit ID settings. Click OK. Modify the settings as necessary and then test the CM9760-MDA port again to confirm communication.

PC Communication: To set up the communication port for the PC, click System on the CM9760-MDA SETUP dialog box and then click PC COM Setup. The System Communication Setup dialog box, Figure 22, appears.

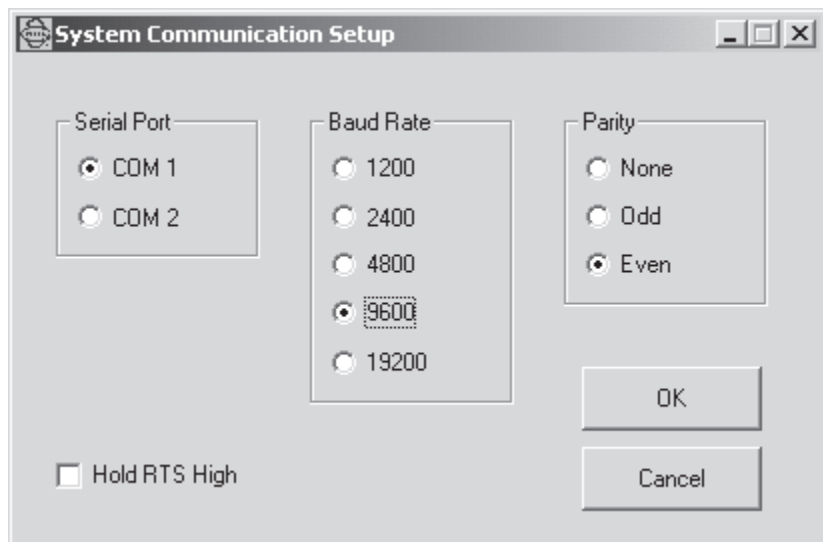

Figure 22. System Communication Setup Dialog Box

Set communication parameters for the PC as follows:

1. Select the PC serial port by clicking the option button next to the desired setting. The System Communication Setup dialog box displays up to four serial ports—COM 1, COM 2, COM 3, and COM 4—depending on the number of serial ports available on your PC. Only serial ports COM 1 and COM 2 are displayed in Figure 22. The default is COM 1.
2. Select the baud rate by clicking the option button next to the desired setting. The default is 9600.
3. Select the parity by clicking the option button next to the desired setting. The default is Even.
4. For port-powered RS-232 to RS-422 converters, set RTS (Request To Send) high by selecting the Hold RTS High item. The Hold RTS High item is selected when a checkmark appears in the checkbox next to the item. Clicking the checkbox functions as a toggle and selects or deselects the Hold RTS High item.
5. Click OK.

NOTE: The baud rate and parity settings of the connected CM9760-MDA COM 1 port and PC port must match.

MDA Software Reset: To reset MDA software to factory default settings, click System on the CM9760-MDA SETUP dialog box and then click MDA Software Reset. At the prompt that asks you whether you wish to reset MDA software, click Yes.

SET TIME AND DATE

To set time and date, you send the current time and date from your PC or edit the time and date and upload it. To get the current time and date from your PC, click Edit on the CM9760-MDA SETUP dialog box and then click Time & Date. The Set Time and Date dialog box, Figure 23, appears. The dialog box contains the current time and date of your PC.

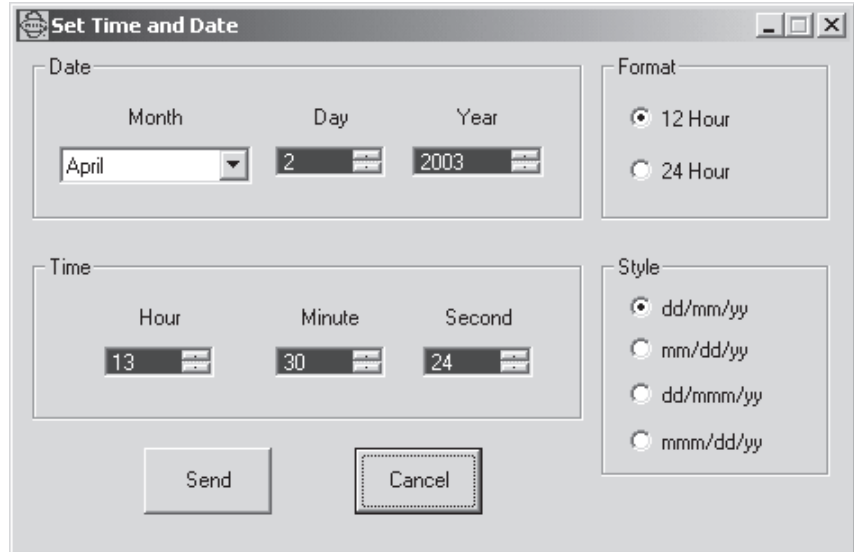

Figure 23. Set Time and Date Dialog Box

The Set Time and Date dialog box allows you to do the following:

- Set the date:
 - Set the month by clicking the down arrow button and then clicking the desired month from the drop-down box.
 - Set the day and year by selecting the desired setting in the list boxes using the up or down button.
- Set the time—hour, minute, and second—by selecting the desired setting in the list boxes using the up or down button.
- Set the time format to either 12-hour or 24-hour format by clicking the option button next to the desired setting.
- Set the date display style to one of the following options: dd/mm/yy, mm/dd/yy, dd/mmm/yy, or mmm/dd/yy where dd = 2-digit day, mm = 2-digit month, yy = 2-digit year, and mmm = 3-letter month abbreviation. To set the date style, click the option button next to the desired setting.

Note that the date style and time format used by the CM9760-MDA must match those used by the CM9760-CC1. Refer to Table F for date styles and time formats compatible with the CM9760-CC1.

Table F. CM9760-CC1/CM9760-MDA Compatible Date Styles and Time Formats

CM9760-CC1 Date Style/ Time Format #	CM9760-CC1 Date Style/ Time Format Example	CM9760-MDA Date Style/ Time Format
0	16/11/03 17:56	DD-MM-YY 24 hour
1	11/16/03 17:56	MM-DD-YY 24 hour
2	16/11/03 05:56 PM	DD-MM-YY 12 hour
3	11/16/03 05:56 PM	MM-DD-YY 12 hour

Click the Send button to upload your settings to the CM9760-MDA unit. To exit the dialog box without uploading your settings, click Cancel.

SET TITLES

As shown in Figure 24, you set titles in the CM9760-MDA SETUP dialog box. Using the CM9760-MDA Setup program, you can read the titles if they are already loaded in the CM9760-MDA or create titles and upload (send) them to the CM9760-MDA.

NOTE: A list of characters supported by the MDA for display of titles is provided in Appendix B.

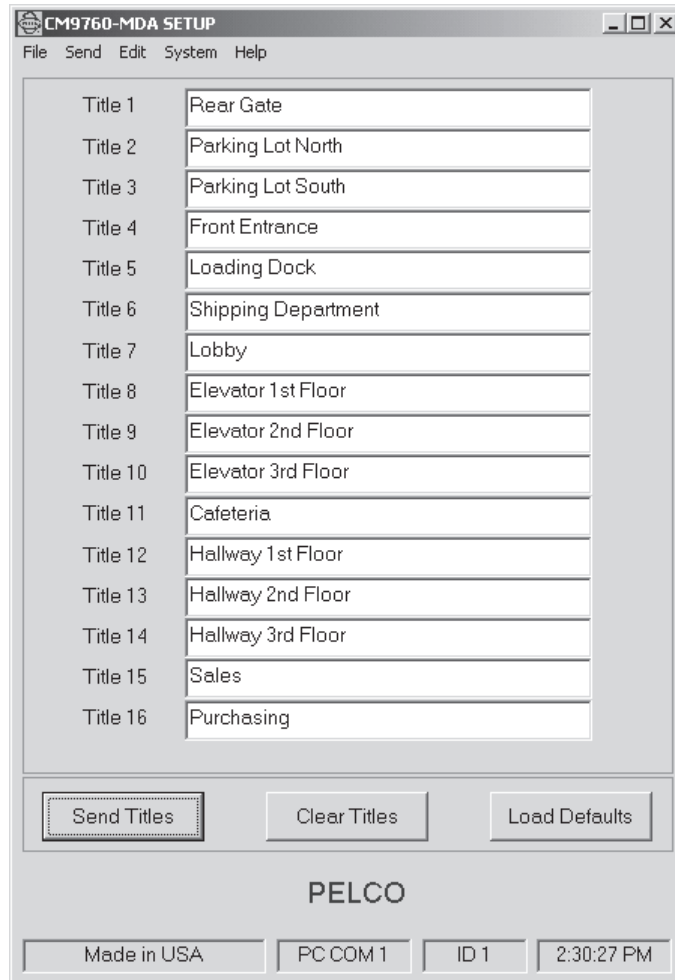

Figure 24. Setting Titles Using the CM9760-MDA SETUP Dialog Box

To Download Titles From An MDA: To import titles from a CM9760-MDA unit, click File on the CM9760-MDA SETUP dialog box and then click Import. The program asks you to confirm the ID number of the MDA unit from which the titles will be loaded. (Click Yes if this is the unit from which you want to import titles. If not, click No. Then click Edit, click Unit ID, change the unit ID to the one you want, and return to the CM9760-MDA SETUP dialog box.) After you confirm, the program reads the titles in the CM9760-MDA unit and displays them in the CM9760-MDA SETUP dialog box.

To Load Default Titles: To load all 16 fields with "CAMX" (where "X" is a camera number), click the Load Defaults button near the bottom of the CM9760-MDA SETUP dialog box. The defaults can be used to test communications with the CM9760-MDA unit. Or, you can modify the defaults by highlighting and typing over them.

To Edit Titles: Once you have imported titles from a CM9760-MDA unit into the CM9760-MDA SETUP dialog box or loaded default titles, you can edit them. You can then send the titles back into the CM9760-MDA unit, and store them as a file in your PC. To edit a title in the dialog box, use the cursor to highlight the line (or characters) you want to change and type over it. Or you can simply edit titles using the normal editing keys (backspace, arrows, DELETE, and space bar).

To Upload Titles: You can upload (send) the edited titles that are in the CM9760-MDA SETUP dialog box back into the CM9760-MDA unit. Click Send at the top of the dialog box, and then click Titles. The program asks you to confirm the MDA unit that will receive the titles. If the ID is correct, click the Yes button. If it is not the MDA unit you want to receive the edited titles: click NO, click Edit at the top of the dialog box, click Unit ID, change the unit ID, and return to the CM9760-MDA SETUP dialog box.

Another way to transmit this data to the CM9760-MDA unit is to click the Send Titles button at the bottom of the CM9760-MDA SETUP dialog box.

To Save Titles: To save the titles displayed in the CM9760-MDA SETUP dialog box to your PC, click File and then click Save or Save As. The titles are saved in a subdirectory called "Camera Titles."

To Print Titles: To print titles, click File on the CM9760-MDA SETUP dialog box and then select Print. Click Current Title to print the titles currently in the window or click From File to print titles stored in a file on your PC.

To Clear Titles: To erase all the titles from the CM9760-MDA SETUP dialog box at one time, click the Clear Titles button.

SET CABLE COMPENSATION

The CM9760-MDA contains circuitry to adjust for long cable runs between the camera and the CM9760-MDA.

To set the cable compensation for each camera using the CM9760-MDA Setup program, click Edit on the CM9760-MDA SETUP dialog box and then click Cable Compensation. The Cable Compensation dialog box, Figure 25, appears.

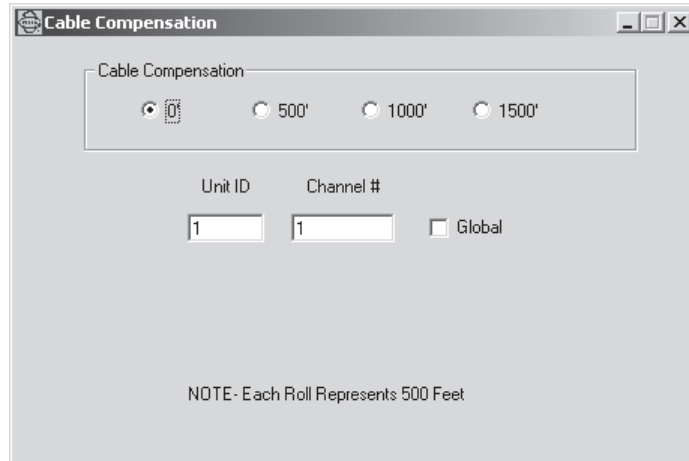

Figure 25. Set Cable Compensation Dialog Box

To set cable compensation for a camera, do the following:

1. Enter the Unit ID number (1-64) of the MDA unit to which the camera is connected, and then press Return. Note that all subsequent changes that are made using the CM9760-MDA Setup program will be applied to the unit ID number that was entered.
2. Enter the channel (camera) number (1-16) for which you want to set cable compensation, and then press Return. All subsequent changes that are made using the CM9760-MDA Setup program will be applied to the channel number that was entered.
3. If you wish the cable compensation of the channel number entered in step 2 above to be applied also to all of the other 15 channels, select the Global checkbox option.
4. Set cable compensation by clicking the option button next to the setting that is closest to the actual length of the cable connecting the camera to the MDA: 500 feet (152 m), 1,000 feet (304 m), or 1,500 feet (457 m). The program illustrates your selection by displaying 500-foot (152 m) reels of cable at the bottom of the dialog box.

If cable compensation is not required, select 0 feet (default setting).

When you finish entering all the data for the compensations you want for your system, close the dialog box by clicking the "X" box.

SET DISPLAY

The Display dialog box allows you to set the positions of the alphanumeric display (text location) for each camera input. In addition, you can adjust brightness through eight levels. You can also pick—for each camera input—what each of the four outputs associated with the input video will have for a display; that is, the alphanumeric display is ON or OFF for each of the four outputs.

To access the Display dialog box, click Edit on the CM9760-MDA SETUP dialog box and then click Display.

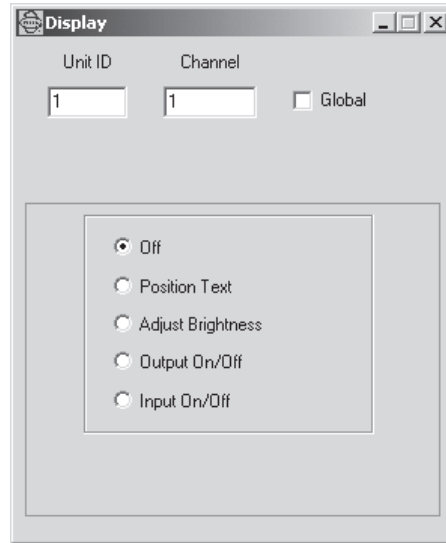

Figure 26. Display Dialog Box

At the top of the Display dialog box, you can set the unit ID and channel (camera) number. To set the unit ID, enter the unit ID number (1-64) and then press Return. To set the channel, enter the channel number (1-16) and then press Return. In addition, there is a Global option for title position, brightness, output on/off, and input on/off that allows all cameras of a unit to be set to the same state as the current channel. Also, there are five options: (display) Off, Position Text, Adjust Brightness, Output On/Off, and Input On/Off. The options are defined as follows:

NOTE: Selecting both the Off option and the Global option causes all display settings for the current channel to be applied to all of the other 15 channels.

NOTE: If message text is set, the Position Text dialog box may indicate the position of message text rather than title/time/date text. For information about message text, refer to the Set Message Text section of this manual.

- Off** This option turns the setup display off for the program.
- Position Text** This option sets the position of text; that is, where text will appear on all video outputs for the cameras selected that have the display option ON. To position text on an NTSC video display, click the NTSC option button (default setting). To position text on a PAL video display, click the PAL option button. Use the up arrow, down arrow, left arrow, and right arrow buttons to position the text on the video outputs. See Figure 27, Position Text Dialog Box. As adjustments are made, they appear in the blue screen at the bottom of the dialog box.
- Adjust Brightness** The brightness level option for the text display ranges from 1 (darkest) to 8 (brightest). Use the up arrow and down arrow buttons to adjust brightness. See Figure 28, Adjust Brightness Dialog Box. As adjustments are made, they appear in the blue screen at the bottom of the dialog box.
- Output On/Off** For each camera input, this option determines the output(s) (Out 1, Out 2, Out 3, Out 4) that will have an alphanumeric (text) display. A check-mark in the box turns on the output. See Figure 29, Output On/Off Dialog Box.
- Input On/Off** This option gives you two selection boxes in which you can toggle time/date and titles on and off. A checkmark in the box turns on the selection. See Figure 30, Input On/Off Dialog Box.



Figure 27. Position Text Dialog Box

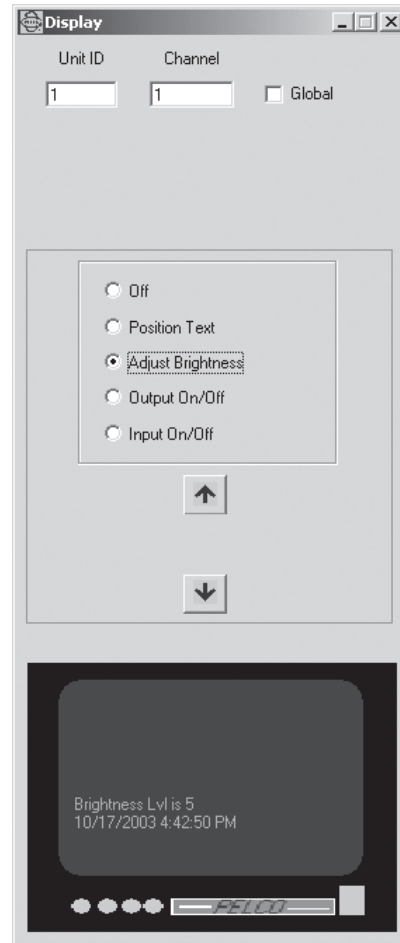

Figure 28. Adjust Brightness Dialog Box

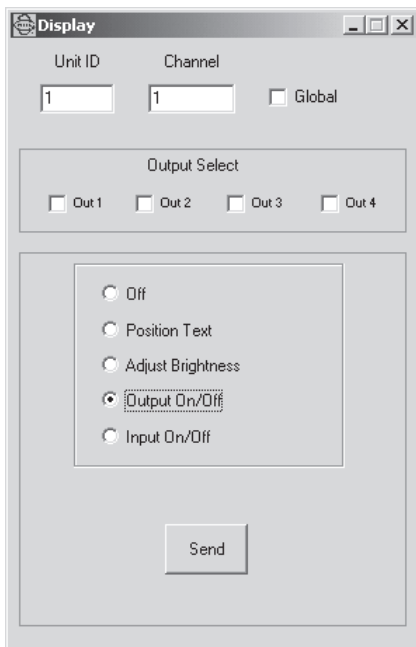

Figure 29. Output On/Off Dialog Box

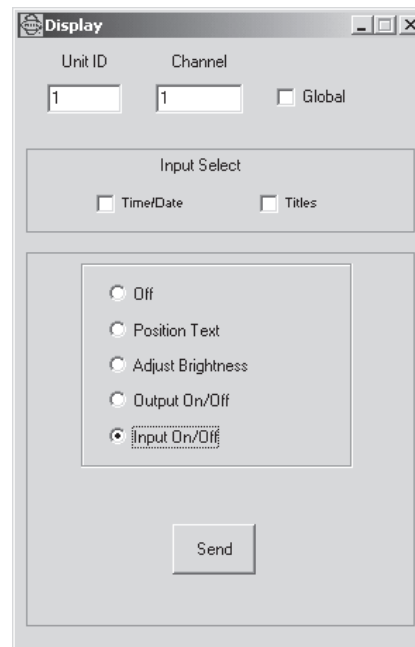

Figure 30. Input On/Off Dialog Box

NOTE: A list of characters supported by the MDA for display of message text is provided in Appendix B.

NOTE: Positioning the title/time/date text in the top or middle of the screen in the Position Text dialog box ensures that you will be able to view the message text that is displayed on a monitor. (For information about the Position Text dialog box, refer to the Set Display section of this manual.)

SET MESSAGE TEXT

The CM9760-MDA accepts message text to meet the needs of applications that require real-time information overlaid on the video being viewed. Up to five lines of message text can be sent to the MDA simultaneously. Each line can contain up to 24 alphanumeric characters. The message text can be inserted onto any MDA channel independently.

The CM9760-MDA Setup program provides a tool that demonstrates support of the message text feature of the MDA. The program allows message text to be sent from the PC to an MDA or to an MDA daisy chain. The PC application is designed as an example of message text operation for third parties who wish to develop their own message text interface to the MDA. (Refer to the *Applications* section of this manual for an application diagram and to *Appendix C* for a listing of the message text insertion commands supported by the MDA.)

To set message text using the CM9760-MDA Setup program, proceed as follows:

1. Open the Position Text dialog box and do the following:
 - a. Position the title/time/date text in the top or middle of the screen (the text should not be positioned at the bottom of the screen).
 - b. Close the Position Text dialog box.
2. Open the Message Text Editing dialog box by clicking Edit on the CM9760-MDA SETUP dialog box and then clicking Message Text. The Message Text Editing dialog box, Figure 31, appears.

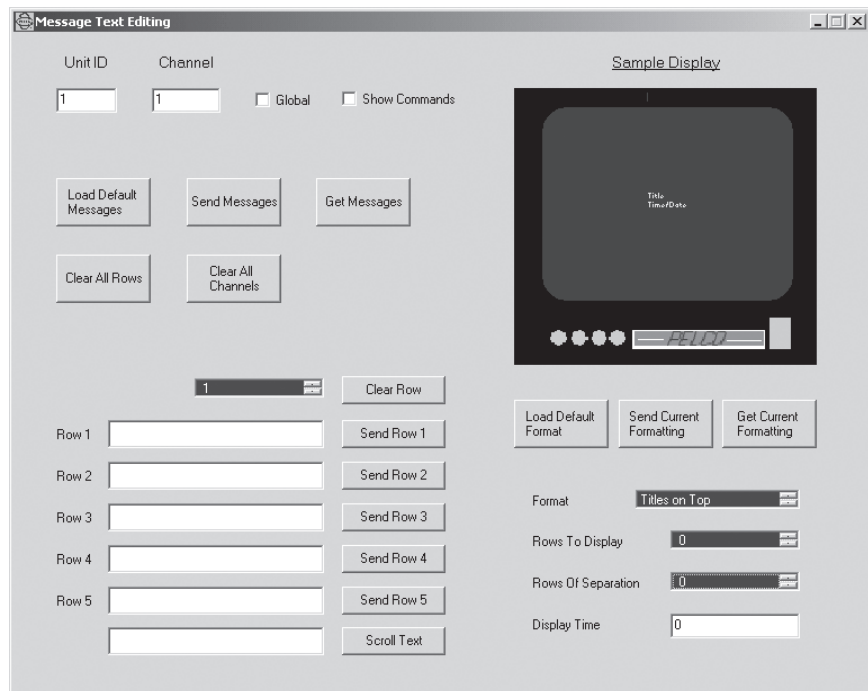

Figure 31. Message Text Editing Dialog Box

3. Enter the Unit ID number (1-64) of the MDA unit for which you want to set message text, and then press Return. Note that all subsequent changes using the CM9760-MDA Setup program will be applied to the unit ID number that was entered.
4. Enter the channel (camera) number (1-16) for which you want to set message text, and then press Return. Note that all subsequent changes using the CM9760-MDA Setup program will be applied to the channel number that was entered.

5. Determine whether you wish to apply message formatting changes to all channels. (Changes to message formatting involve programming the Format, Rows to Display, Rows of Separation, and Display Time settings that are provided in the lower right-hand corner of the Message Text Editing dialog box. Information about setting message formatting is provided in step 7 below.)

To apply message formatting changes to all channels, select the Global checkbox option.

6. Determine whether you wish to display the command transactions between the MDA and the PC in hexadecimal and ASCII formats. (For additional information about the command transactions that are displayed, refer to the *Showing Commands* section later in this manual.)

To display the command transactions, do the following:

- a. Select the Show Commands checkbox. The Command Data window, Figure 32, appears in front of the Message Text Editing dialog box.

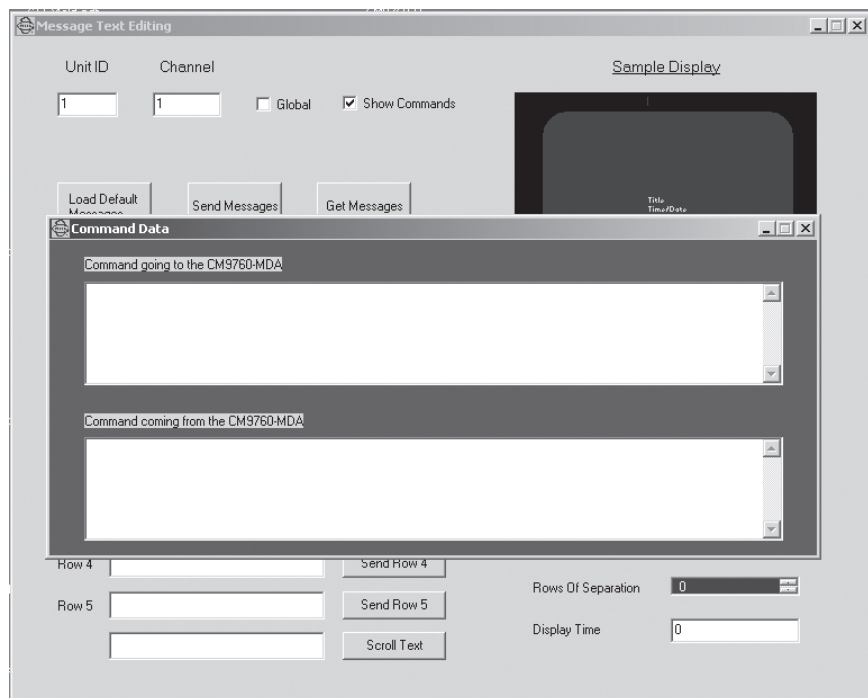

Figure 32. Command Data Window

- b. Do either of the following:
 - Move the Message Text Editing dialog box in front of the Command Data window by clicking the Message Text Editing dialog box. Each time a command is sent from the PC to the MDA, the Command Data window appears. After viewing the command transactions, move the Message Text Editing dialog box in front of the Command Data window again.
 - Minimize the Command Data window. Whenever you wish to view a command transaction in the Command Data window, click the Command Data button in the taskbar on the Windows desktop. Then minimize the Command Data window again.

7. Set the message text format characteristics in the lower right-hand corner of the Message Text Editing dialog box by programming the following information:
 - Format—Specifies the positioning of title/time/date text and message text. Select the desired setting in the list box using the up or down button:
 - Titles on Top specifies that title/time/date text is to be positioned above message text (default setting).
 - Messages on Top specifies that message text is to be positioned above title/time/date text.
 - Rows to Display—Specifies the number of rows (lines) of message text to be displayed. In addition, the Rows to Display field also specifies the number of rows of text that can be scrolled (for information about scrolling text, refer to the *Scrolling Message Text* section later in this manual). Select the desired setting in the list box using the up or down button. The range is 0-5 rows. The default setting is 0, which disables the message text feature.
 - Rows of Separation—Specifies the number of blank rows to be set between the title/time/date text and the message text displays. Select the desired setting in the list box using the up or down button. The range is 0-28 rows. The default setting is 0.
 - Display Time—Specifies the number of seconds that message text is to be displayed. Enter a value ranging from 0-9999 seconds. The default setting is 0, which allows the message text to be displayed for an indefinite period of time or until the message text is overwritten.
8. Send the formatting changes set in step 7 above to the selected unit and channel(s) by clicking the Send Current Formatting button, which is located below the Sample Display screen.

The Sample Display screen then displays the current formatting determined by the Format, Rows to Display, and Rows of Separation settings selected in step 7. In addition, the default message text for each row to be displayed appears. The default message text for rows 1-5 is as follows: Row 1 Message, Row 2 Message, Row 3 Message, Row 4 Message, and Row 5 Message.

Figure 33 provides an example of a Sample Display screen and the associated formatting settings (titles on top, three rows to display, and two rows of separation).

Note that the Sample Display does not show the actual position of the title/time/date and message text on the monitor on which the text is to be displayed but rather shows the position of the title/time/date text in relation to the message text. The actual positioning of the text is shown in the Position Text dialog box:

- If message text is set and Titles on Top is set as the format, the Position Text dialog box shows the positioning of the title/time/date text.
- If message text is set and Messages on Top is set as the format, the Position Text dialog box shows the positioning of the message text.

(For additional information about the Position Text dialog box, refer to the *Set Display* section of this manual.)

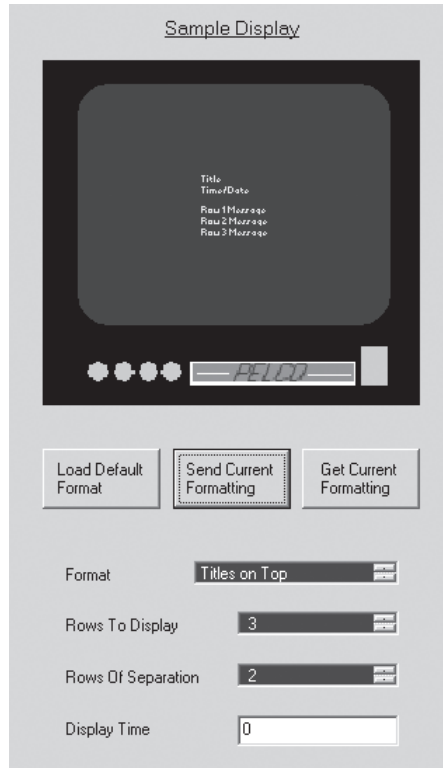

Figure 33. Sample Display Screen Example

9. Enter and send message text to the selected unit and channel for the desired number of rows (as determined by the Rows to Display value set in step 7 above). For each row, the message text can contain a maximum number of 24 alphanumeric characters.
 - If the desired number of rows is 1, enter the message text into the Row 1 message text entry box and then click the Send Row 1 button.
 - If the desired number of rows is more than one, you can enter and send the message text for each row individually or you can enter the message text for all rows and then send the message text for all rows at one time:
 - To send the message text individually for each row, click the Send Row x button (x = 1, 2, 3, 4, or 5) as appropriate.
 - To send the message text for all rows at one time, click the Send Messages button.

The desired message text is displayed on the number of rows selected to display message text on the current MDA channel.

The following sections provide additional information about functions that can be performed from the Message Text Editing dialog box.

Showing Commands: You can display command transactions between the PC and the MDA by selecting the Show Commands checkbox in the Message Text Editing dialog box. The Command Data window displays the command sent to the MDA and the response sent from the MDA each time you click a command button in the Message Text Editing dialog box. The command transaction is displayed in hexadecimal format and in ASCII format.

Figure 34 provides a sample of a Command Data window. The message *Hello World* was sent from the PC to the MDA using the Send Row 1 command button.

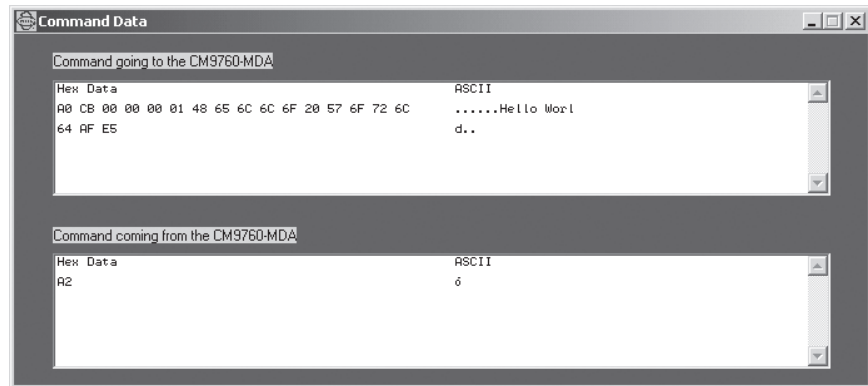

Figure 34. Sample Command Data Window

Note the following:

- The ASCII equivalent of hexadecimal data 00 to 1F and hexadecimal data 80 and beyond is represented as dots.
- When the MDA acknowledges the command that was sent to it, the MDA responds by sending *A2* as shown in Figure 34. If the MDA does not acknowledge the command that was sent to it, the MDA responds by sending *A4*.

For additional information about message text commands, refer to *Appendix C* in this manual.

Scrolling Message Text: If you have set message text on a selected unit and channel for a specified number of rows, the MDA allows you to scroll message text to allow a new message to be displayed.

To scroll message text, do the following:

1. In the Rows to Display formatting list box, specify the number of text rows that can be scrolled and displayed.
2. Send the formatting to the selected unit and channel(s) by clicking the Send Current Formatting button.
3. In the Scroll Text entry box, enter the desired message text and then click the Scroll Text button.

Message text scrolls as follows. Each row that is scrolled moves upward one row. As a result, the first row of message text is overwritten. The new message is displayed in the bottom row, which is determined by the number of rows specified in the Rows to Display formatting setting.

An example of message text scrolling is as follows. If the Rows to Display field specifies that three rows can be scrolled, the following occurs when message text is scrolled:

- Message text on row 2 moves up to row 1. The message text that previously appeared on row 1 is overwritten.
- Message text on row 3 moves up to row 2.
- The new message to be displayed (scroll message) appears on message row 3.

Note that you can view the scrolled text in the message text entry boxes by clicking the Get Messages button.

Loading Default Message Text: You can display the default message text in the message text entry boxes by clicking the Load Default Messages button. Default message text appears as follows:

Row 1 Message
Row 2 Message
Row 3 Message
Row 4 Message
Row 5 Message
Scroll Message

Clearing Message Text: For the selected unit and channel, you can clear message text from a particular row or from all rows. In addition, you can clear message text from all rows for all channels of a selected unit.

- To clear message text from a particular row for the selected unit and channel, select the desired row number in the Clear Row list box using the up or down button and then click the Clear Row button.
- To clear message text for all rows (1-5) for the selected unit and channel, click the Clear All Rows button.
- To clear message text for all rows (1-5) for all channels of the selected unit, click the Clear All Channels button.

Retrieving Current Message Text: If the current message text is not displayed in the message text entry boxes for the selected unit and channel, you can retrieve the current message text by clicking the Get Messages button.

Loading Default Format: You can load default format settings of the Format, Rows To Display, Rows of Separation, and Display Time fields by clicking the Load Default Format button. The following default settings are displayed:

- In the Format list box, Titles on Top is displayed and is highlighted. Titles on Top specifies that title/time/date text is to appear above message text.
- In the Rows to Display list box, 0 is displayed and is highlighted. The value of 0 disables the display of message text.
- In the Rows of Separation list box, 0 is displayed and is highlighted. The value of 0 prevents the two text displays, date/time/title text and message text, from being separated by blank rows.
- In the Display Time text entry box, 0 is displayed. The value of 0 allows the message text to be displayed for an indefinite period of time or until it is overwritten.

Retrieving Current Formatting: If the current formatting settings are not displayed in the Sample Display screen and are not shown in the Format, Rows To Display, Rows of Separation, and Display Time fields, you can retrieve the current settings by clicking the Get Current Formatting button. The Sample Display screen then displays the current formatting and the current settings are shown in the formatting fields.

SEND DATA

The program's Send menu lets you transmit either the current time and date, titles, or both to the CM9760-MDA. (You can also use the Send Titles button on the CM9760-MDA SETUP dialog box to directly send just titles.)

To send data, click Send on the CM9760-MDA SETUP dialog box and then click Time & Date, Titles, or All.

VIDEO ALPHANUMERIC OVERLAYS

Figure 35, Typical Camera Display With Alphanumerics, shows what is displayed on each video output. The system displays the title on the first line. The second line shows the time and date. Depending on the time and date format, there can be extra characters for AM and PM for the 12-hour format, and two digits instead of the three letters in the month, as shown in Figure 35.

NOTE: *The optional message text feature of the MDA allows the MDA to accept text messages from third-party equipment. Consequently, text messages can also appear on the camera display. (For additional information, refer to the Set Message Text section of this manual.*

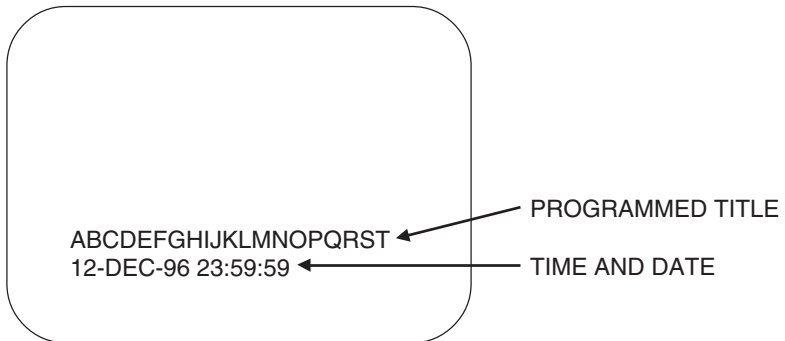

Figure 35. Typical Camera Display With Alphanumerics

TROUBLESHOOTING

Symptom	Possible Problem	Possible Solution
Unit not functioning.	No power at the unit.	Check the power plug and fuse. (Refer to Figure 2 for fuse location.)
	No video source.	Check that the video source is connected. (Refer to Figure 1.)
	No output device (such as a monitor).	Check the connection. Check that the monitor is turned on. (Refer to Figure 1.)
No video on any output channel.	No video source.	Check that the video source is plugged in and functioning. (Refer to Figure 1.)
Programming menu not turning on.	No input from keyboard.	Check that keyboard is plugged into COM 1. (Refer to Figure 1.)
	No signal from keyboard.	Move joystick right.
	Wrong signal from keyboard.	Place keyboard into direct mode. (Refer to the <i>Entering Program Mode</i> section.) Set keyboard to 4800 baud. (Refer to the <i>Set Port</i> section.)
No text overlay on the video output(s).	Text overlay turned off for one or all outputs.	Check menu for display options for that camera. (Refer to the <i>Set Camera Display</i> section or <i>Set Display</i> section, depending on programming method.) In addition, check unit ID DIP switch settings. (Refer to the <i>Clearing Text Display on All Channels</i> section.)
	Display is set off the screen.	Check display position in camera menu. (Refer to the <i>Set Camera Display</i> section or <i>Set Display</i> section, depending on programming method.)
MDA does not display a character that was sent to it.	A character was entered that is not supported by the MDA.	Refer to Appendix B for a list of characters supported by the MDA for display of titles and message text.

SPECIFICATIONS

Electrical

Consumption:	25 W
Fuse:	120 VAC, 250 mA; 230 VAC, 125 mA
Input Voltage	
CM9760-MDA:	120 VAC, 60 Hz \pm 10%
CM9760-MDA-X:	230 VAC, 50 Hz \pm 10%

Mechanical

Connectors	
Video Input:	BNC (16)
Video Output:	BNC (4 per input)
Communications	
COM 1 (In):	RJ-45 8-pin modular
COM 2 (Out):	RJ-45 8-pin modular

Video

Video Input(s):	.5 to 2 Vp-p, 16 inputs per unit
Video Output(s):	1 Vp-p, 4 outputs per input
Input/Output Impedance:	75 ohms, terminated
Gain:	Unity \pm 1 dB
Input Cable	
Compensation Range:	0-1,500 feet (none, 500, 1,000, 1,500 ft) (none, 152, 304, 457 m)
Frequency Response:	\pm 1 dB @ 8 MHz
Bandwidth:	\pm 3 dB @ 15 MHz
Crosstalk:	-60 dB @ 2.58 MHz
Gain:	+ .88 dB + .55 dB with 1,500 feet of RG59\U
Differential Gain:	Less than 4%
Differential Phase:	Less than 1 degree
Max. Output Level:	1.0 Vp-p terminated
Signal-to-Noise Ratio:	-45 dB
Tilt:	Less than 1 degree
Inputs:	Ground isolated

On-Screen Display

Character Size:	7 x 9 TV lines
Brightness:	Individually adjustable (digital)
Horizontal Position:	Individually adjustable (digital)
Vertical Position:	Individually adjustable (digital)

Communication

Type:	Selectable: RS-232, RS-422, RS-485
Data Rate:	Selectable: 1200, 2400, 4800 or 9600 baud

General

- Construction: Aluminum
- Dimensions: See Figure 36
- Mounting: 19-in. (48.26 cm) EIA standard rack mount (3 RUs)
- Operating Temperature: 14° to 122°F (-10° to 50°C)
- Humidity: 90% non-condensing
- Memory Backup: Lithium battery

Ratings

NEMA 1

(Design and product specifications subject to change without notice.)

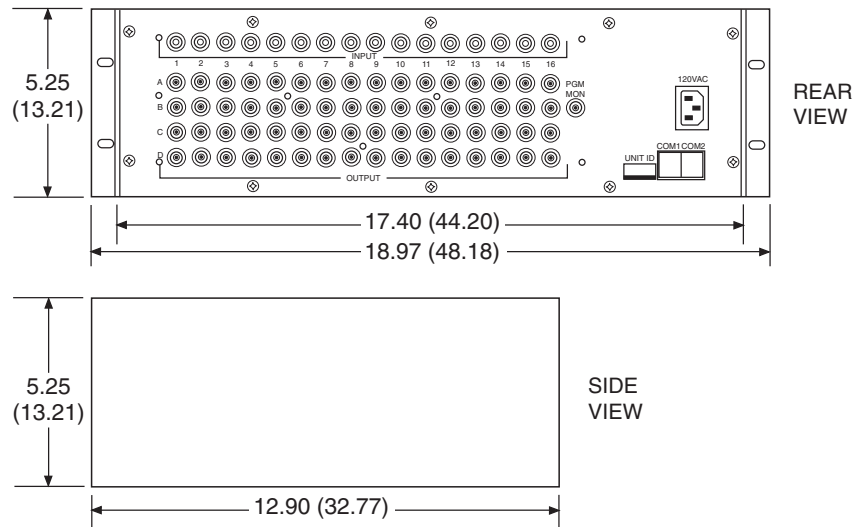

NOTE: VALUES IN PARENTHESES ARE CENTIMETERS; ALL OTHERS ARE INCHES

Figure 36. CM9760-MDA Dimension Drawing

APPENDIX A – APPLICATIONS

The MDA can be used in several different applications. Note that, as illustrated in some of the applications below, a maximum of 16 MDAs can be daisy-chained. When more than 16 MDAs are required, a CM9760-CDU-T must be used.

- Figure 37 illustrates a simple system configuration of the MDA.
- Figure 38 illustrates a master MDA unit, MDA 1, connected to 63 MDA slave units: MDA 2 to MDA 64. The slave units accept the master time and date from MDA 1, which functions as the master clock. (An MDA functions as the master clock when unit ID DIP switch 8 is set to the ON position. An MDA functions in slave mode when unit ID DIP switch 8 is in the OFF position, which is the default setting.)

As illustrated in Figure 38, the CM9760-CDU-T must be used when an MDA functions as the master clock time and date generator for more than 16 MDAs. In the illustration, note the following:

- The RS-422 COM 1 port of the master MDA unit (MDA 1) connects to the RS-422 IN data port of the CM9760-CDU-T.
- The first RS-422 output of the CDU-T connects to the RS-422 COM 1 port of the first MDA in a chain of 16 MDAs (MDA 2 to MDA 17).
- The second output of the CDU-T connects to the second chain of 16 MDAs (MDA 18 to MDA 33).
- The third output of the CDU-T connects to the third chain of 16 MDAs (MDA 34 to MDA 49).
- The fourth output of the CDU-T connects to a chain of 15 MDAs (MDA 50 to MDA 64).

In addition, note that RS-422 shielded twisted pair cable is used to connect each output of the CDU-T to a wall block for connection to the COM 1 port of the first MDA in each chain.

- Figure 39 illustrates a PC connected to a chain of 16 MDA units (MDA 1 to MDA 16). In this application, the PC is used to program the 16 MDA units.
- Figure 40 illustrates a PC connected to 64 MDA units: MDA 1 to MDA 64. In this application, the PC is used to program the 64 MDA units. The Pelco PV130 RS-232/422 converter provides an electrical interface between RS-232 and RS-422 data ports. In Figure 40, the PV130 interfaces the DB9 RS-232 port of the PC to a wall block for connection to the RS-422 IN port of the CM9760-CDU-T. (Note that the PV130 RS-232/422 converter eliminates the need to change the internal DIP switch settings of the MDA COM port to RS-232 for communication with the PC.) A plug-in power supply allows the PV130 to communicate serial port data over wire pairs for distances up to 4,000 feet (1,219 m) on the RS-422 side.

Each of the first four outputs of the CDU-T connects to a chain of 16 MDAs (MDA 1 to MDA 16, MDA 17 to MDA 32, MDA 33 to MDA 48, and MDA 49 to MDA 64).

- Figure 41 illustrates a CM9760-CC1 connected to a chain of 16 MDA units (MDA 1 to MDA 16). An RS-422 output of the CC1 connects to the RS-422 COM 1 port of the first MDA in the chain. MDA 1 to MDA 16 accept the master time and date from the CM9760-CC1; therefore, the MDAs must be set to slave mode.
- Figure 42 illustrates a CM9760-CC1 connected to 64 MDA units: MDA 1 to MDA 64. An RS-422 output of the CC1 connects to the RS-422 IN data port of the CM9760-CDU-T. Each of the first four outputs of the CDU-T connects to a chain of 16 MDAs (MDA 1 to MDA 16, MDA 17 to MDA 32, MDA 33 to MDA 48, and MDA 49 to MDA 64). MDA 1 to MDA 64 accept the master time and date from the CM9760-CC1; therefore, the MDAs must be set to slave mode.
- Figure 43 illustrates an MDA connected to multiplexers.

NOTE: As illustrated in Figures 45 and 46, the MDA can be used with Coaxitron products such as the CM9760-CXTA, CM6800, and CM6700. Note that the MDA must be placed **after** the Coaxitron equipment. If the MDA is placed incorrectly, camera control may be adversely affected.

- Figure 44 illustrates a non-Coaxitron setup that includes an MDA connected to a 9760 keyboard, CM9760-CC1 CPU, and CM9760-MXB matrix bay. The MDA accepts the master time and date from the CM9760-CC1; therefore, the MDA must be set to slave mode.
- Figure 45 illustrates a Coaxitron setup that includes a System 9760 connected to an MDA. The MDA accepts the master time and date from the CM9760-CC1; therefore, the MDA must be set to slave mode.
- Figure 46 illustrates a CM6800 connected to an MDA. The MDA accepts the master time and date from the CM6800; therefore, the MDA must be set to slave mode. (The MDA can also accept the master time and date from the CM6700.)
- Figure 47 illustrates an MDA that accepts message text from third-party equipment. The third-party equipment connects to a COM port (COM 1 or COM 2) of the MDA using the RS-232 or RS-422 communication standard. For cabling requirements, refer to the *Data Connections* section of this manual. For information about COM port DIP switch settings required for RS-232 and RS-422 communication, refer to the *Communication Ports Setup* section of this manual. For a wiring diagram of the MDA using RS-232 communication, refer to the *Connecting the MDA to an External PC* section of this manual. For information about MDA COM port pinouts using RS-422 communication, refer to Table D in this manual. Note that when connecting the MDA to third-party equipment using RS-422 communication, TX+ must connect to RX+ and TX- must connect to RX-. For information about support of message text insertion by the MDA, refer to the *Set Message Text* section of this manual and to Appendix C.

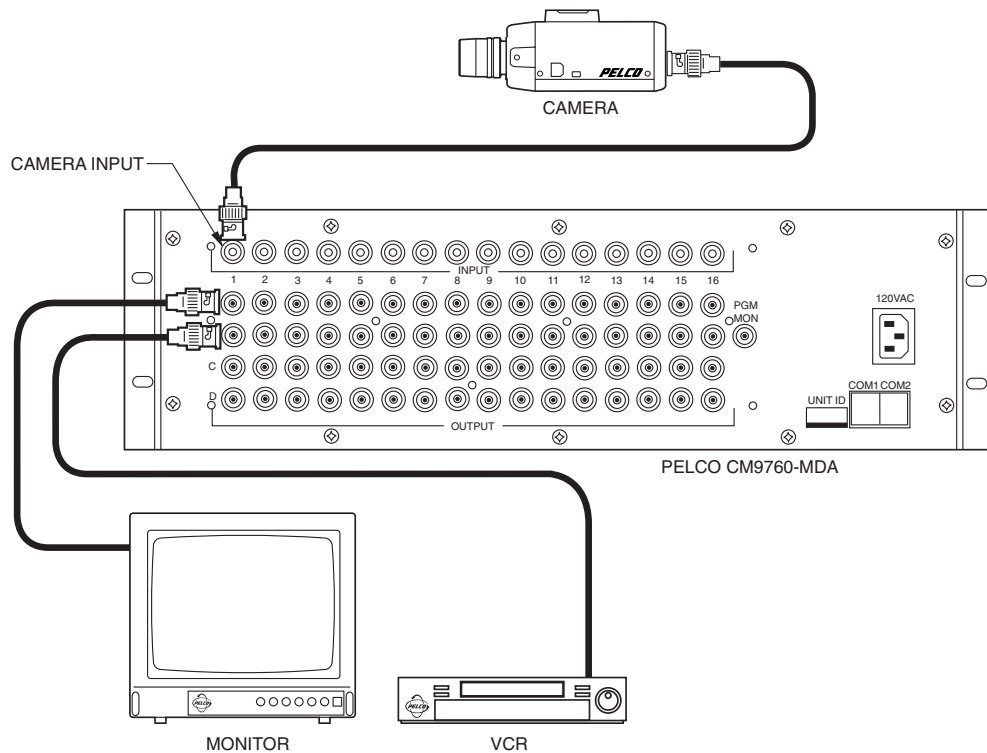

Figure 37. Simple System Configuration

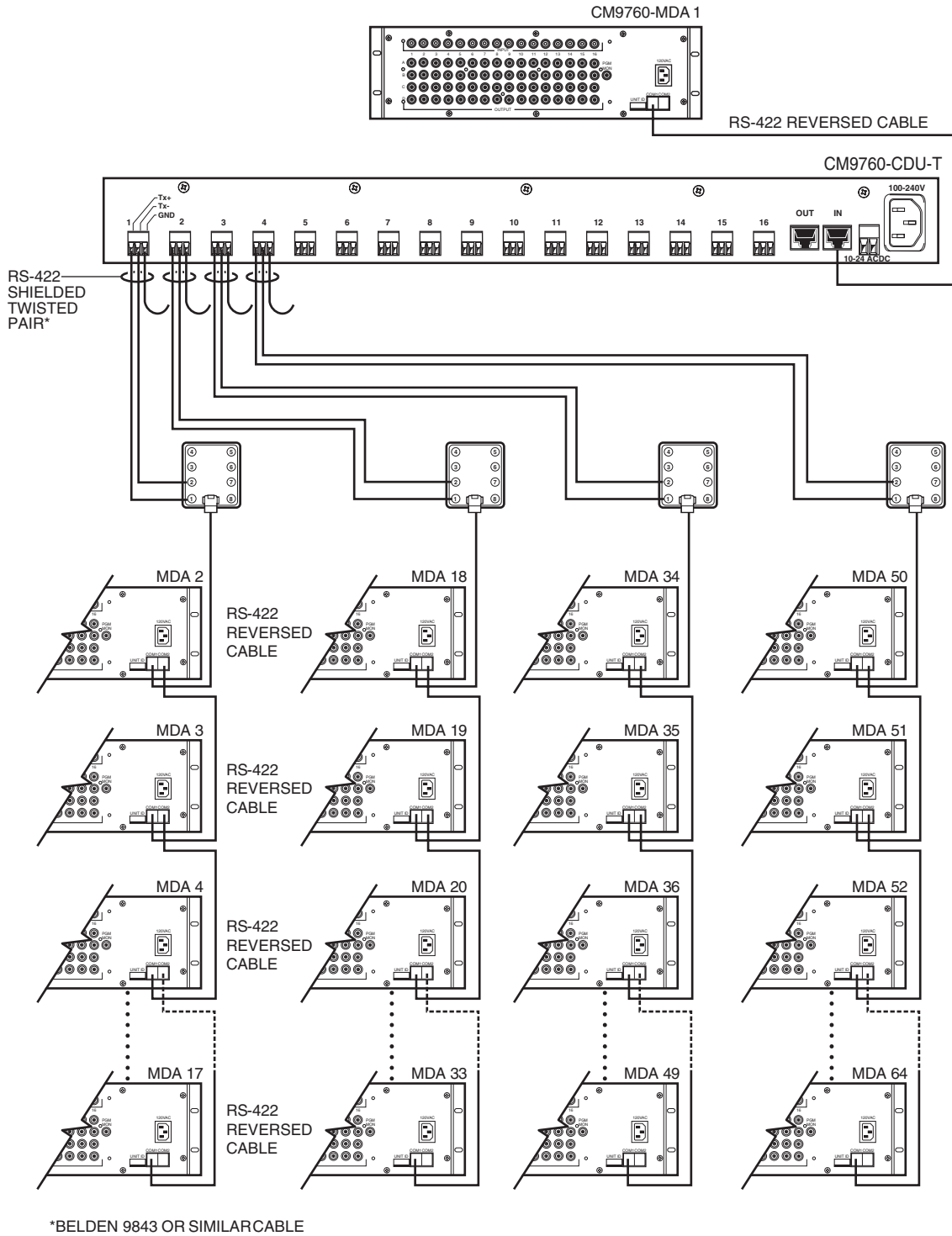
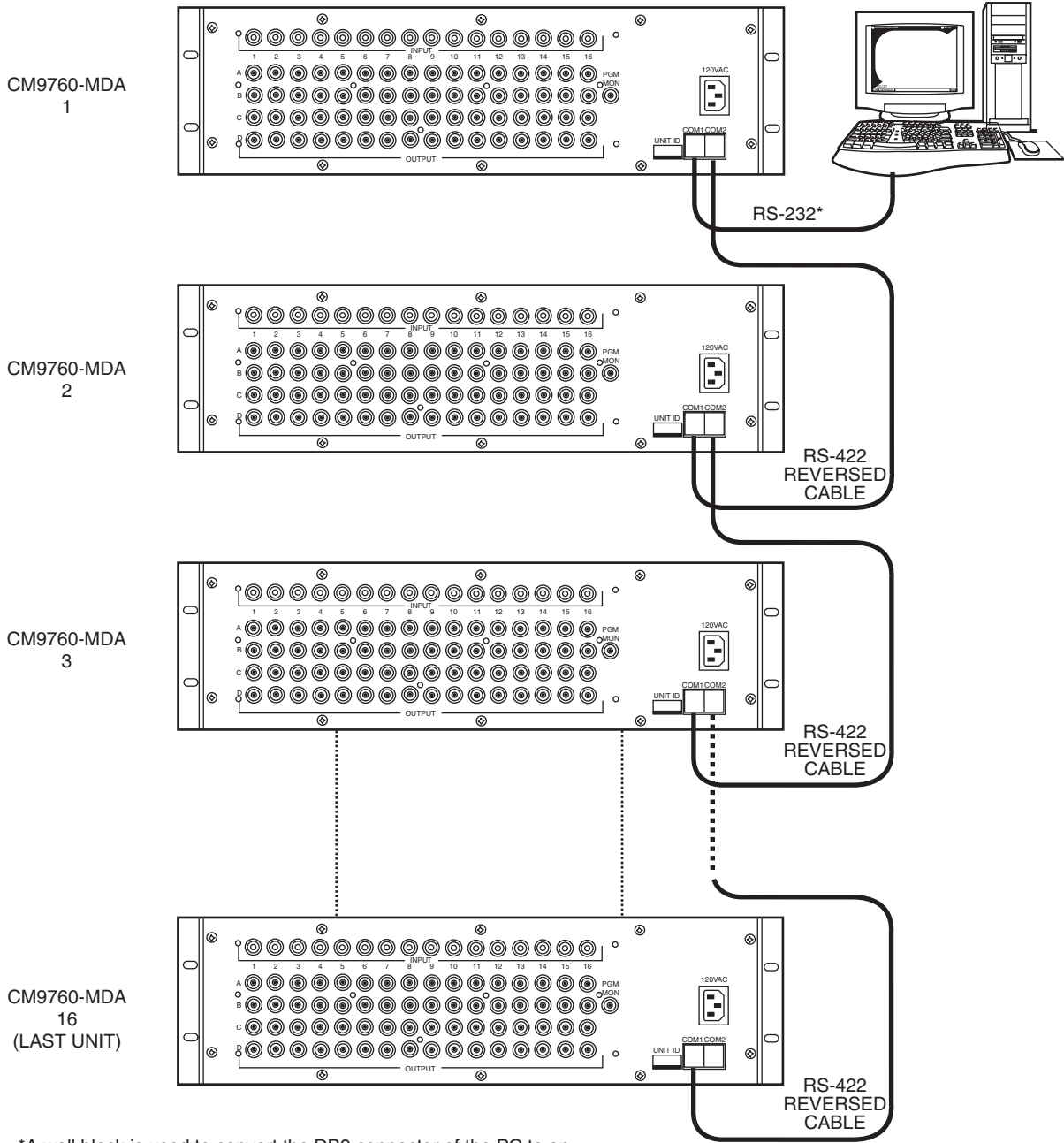
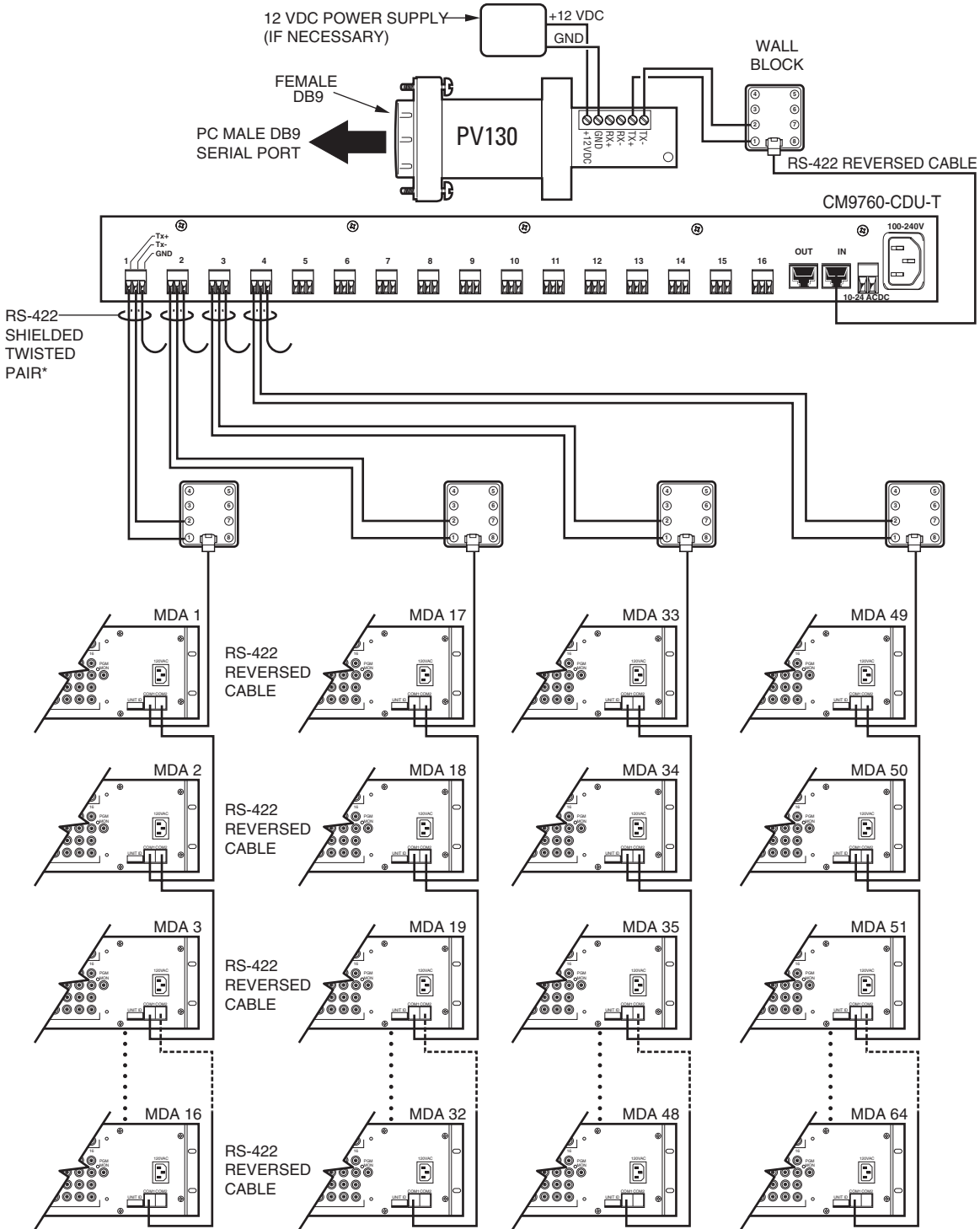

Figure 38. Master MDA Time and Date Generator for 63 MDA Slave Units (64 Total MDA Units)



*A wall block is used to convert the DB9 connector of the PC to an RJ-45 connector for connection to the COM1 port of the MDA. Refer to Figure 5 for a wiring diagram of PC-to-MDA connections.

Figure 39. PC Connection to Up to 16 Daisy-Chained MDA Units



*BELDEN 9843 OR SIMILAR CABLE

Figure 40. PC Connection to over 16 MDA Units (Maximum of 64 MDA Units)

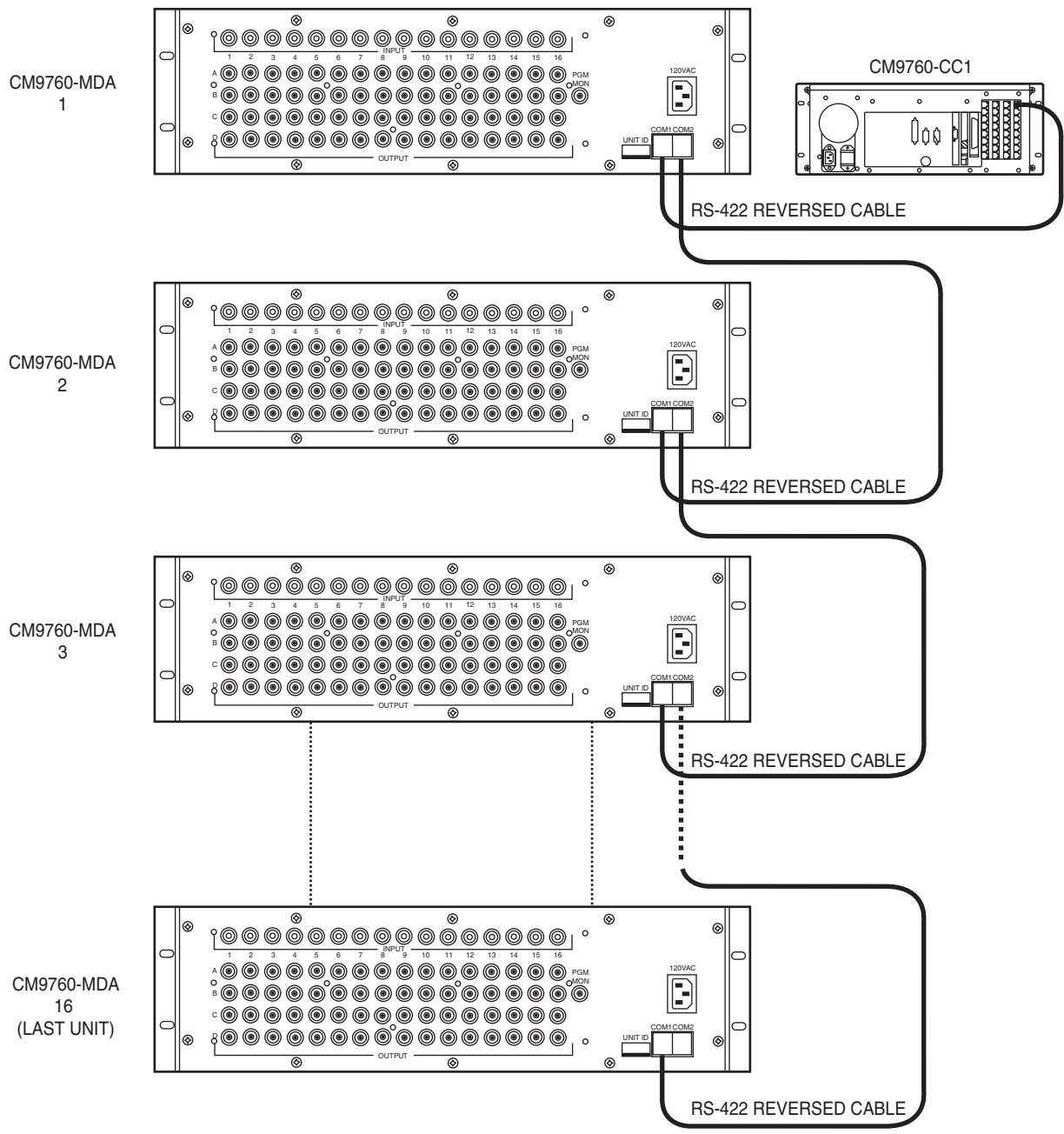

Figure 41. CM9760-CC1 Connection to up to 16 Daisy-Chained MDA Units

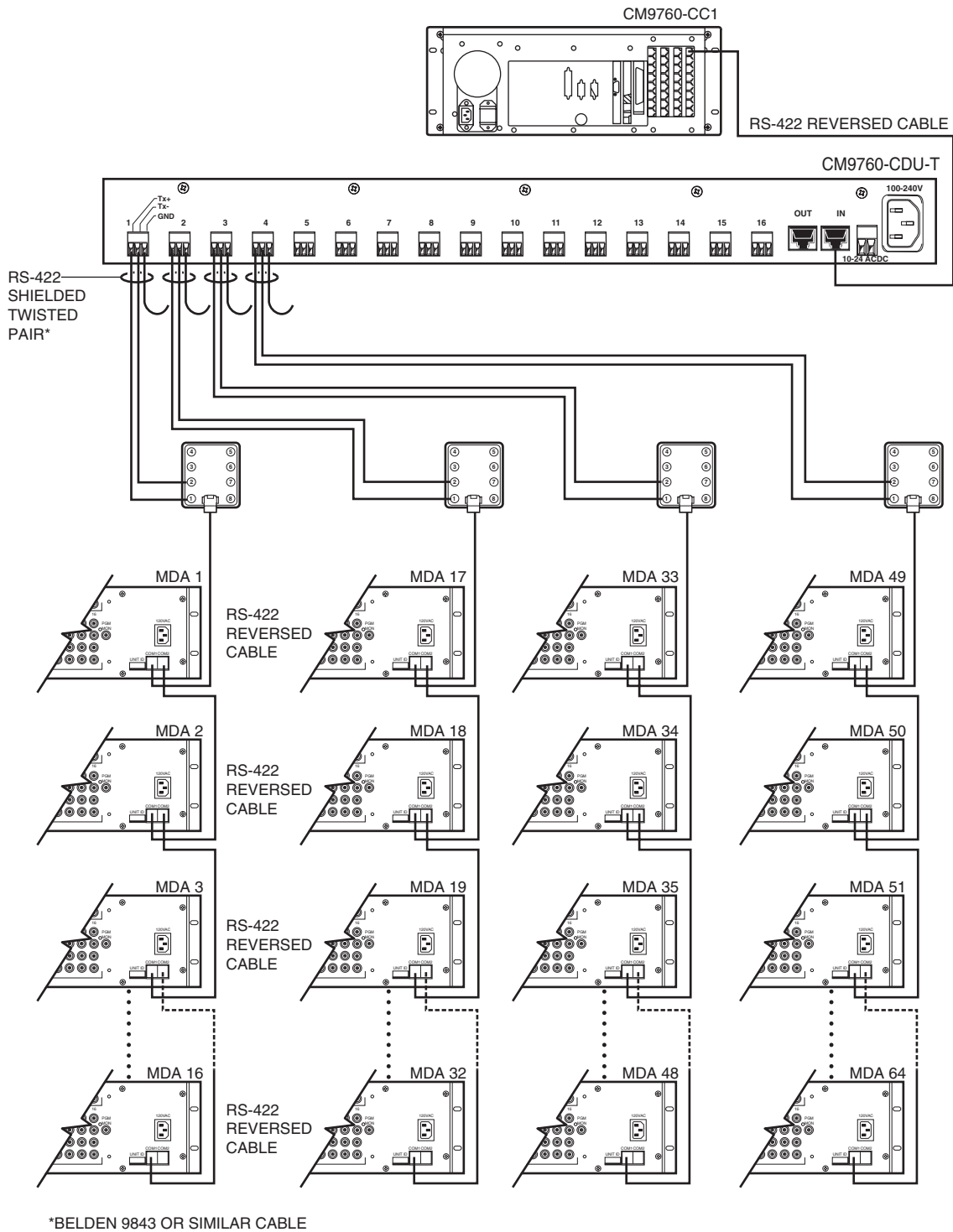

Figure 42. CM9760-CC1 Connection to over 16 MDA Units (Maximum of 64 MDA Units)

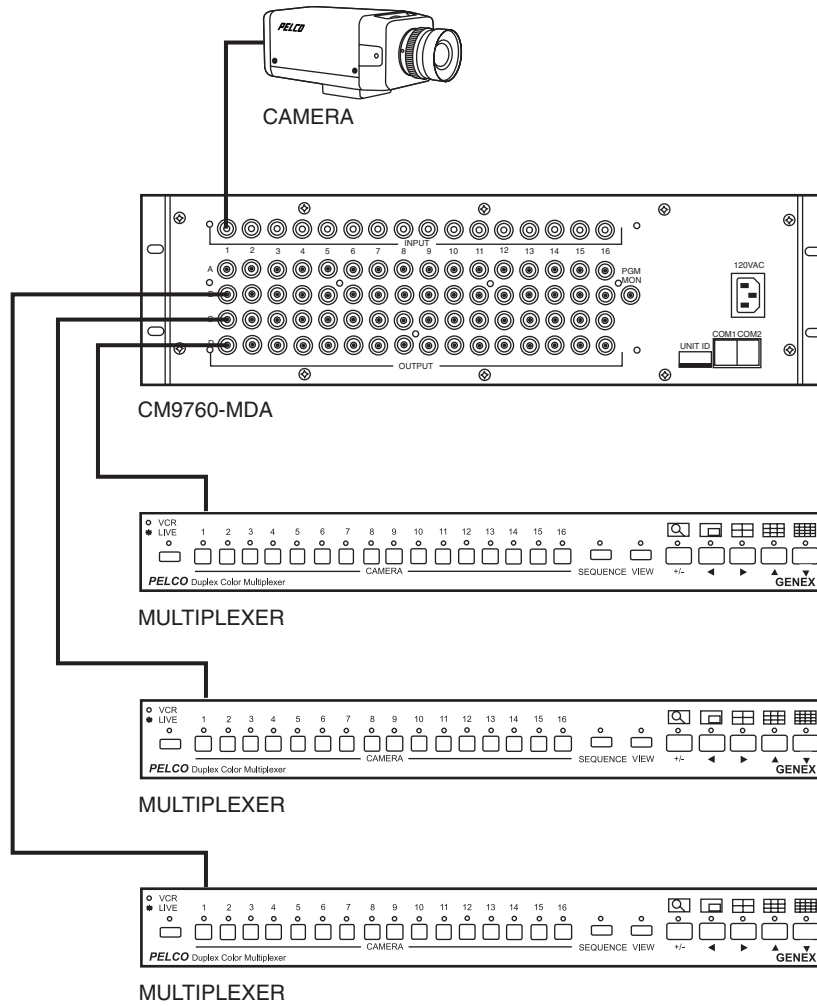

Figure 43. MDA Connected to Multiplexers

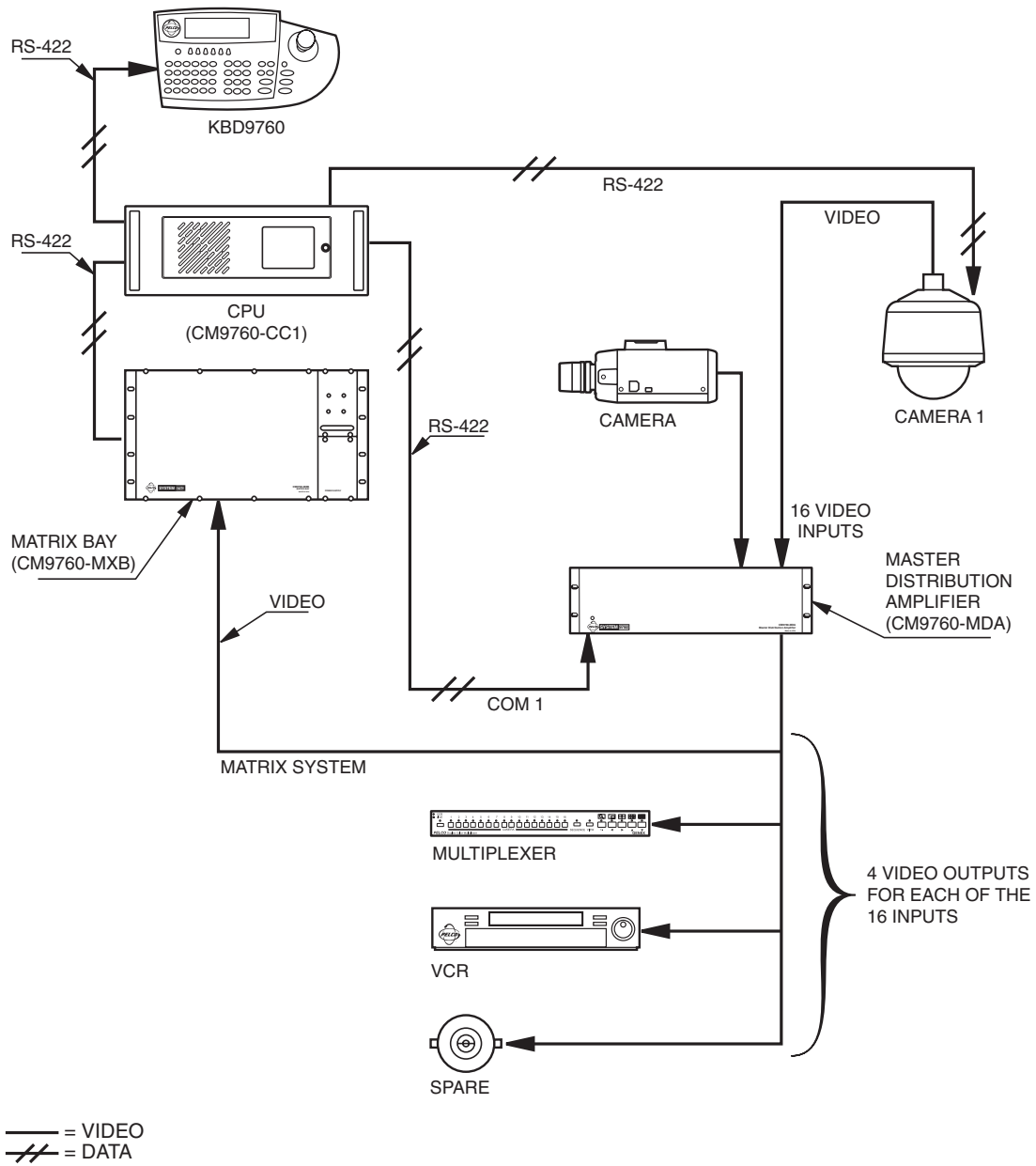

Figure 44. Non-Coaxitron System Setup

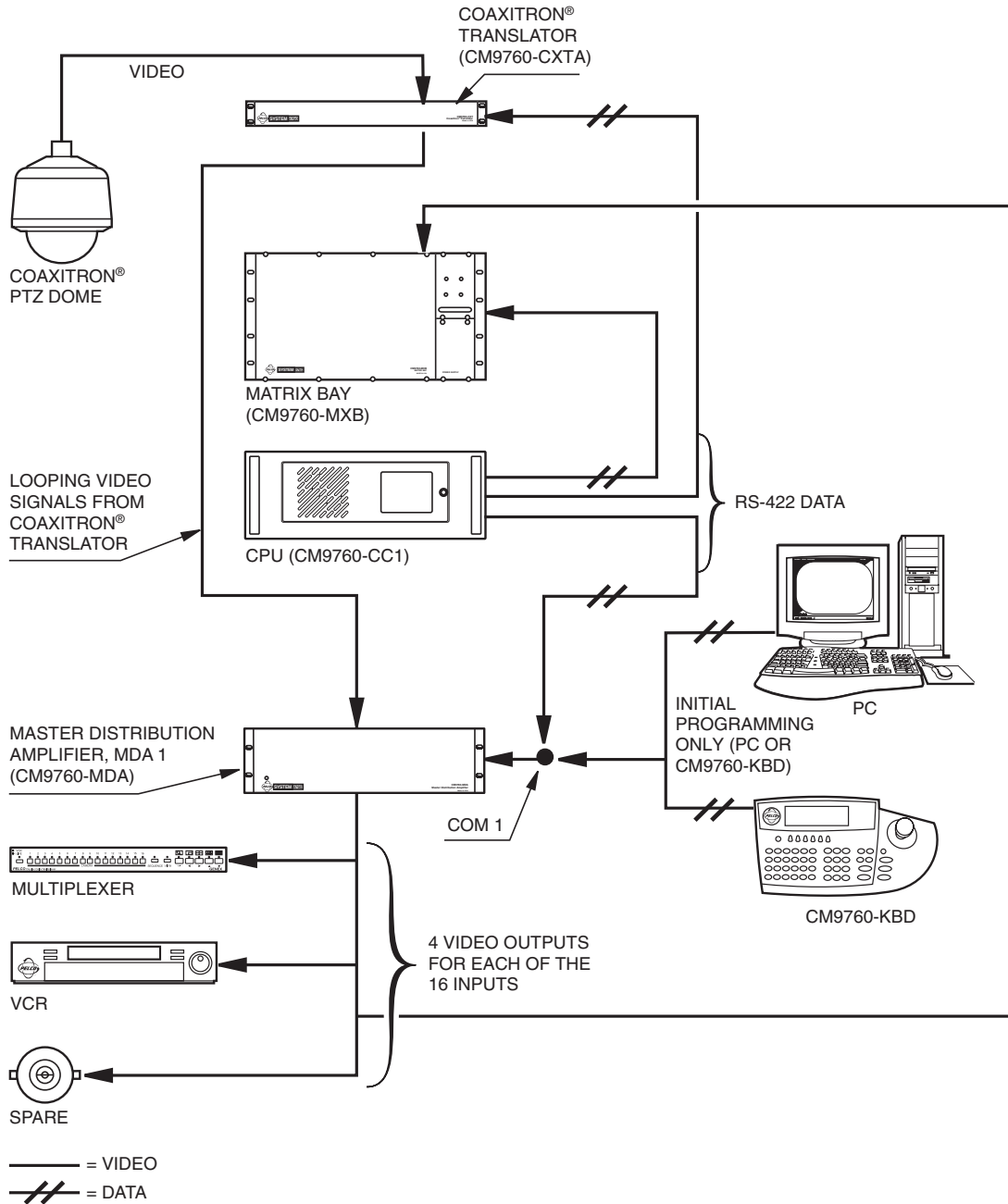

Figure 45. Coaxitron with System 9760 Setup

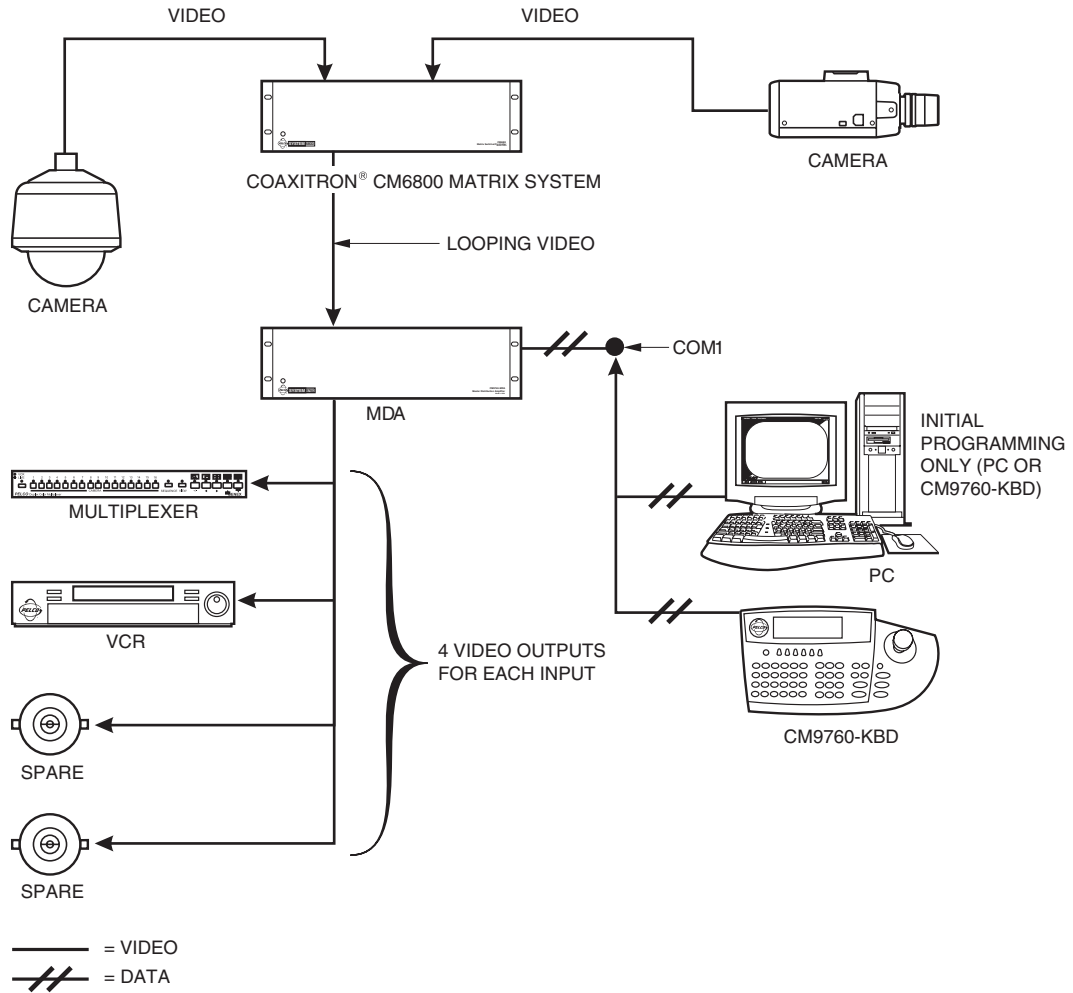

Figure 46. Coaxitron with System 6800 Setup

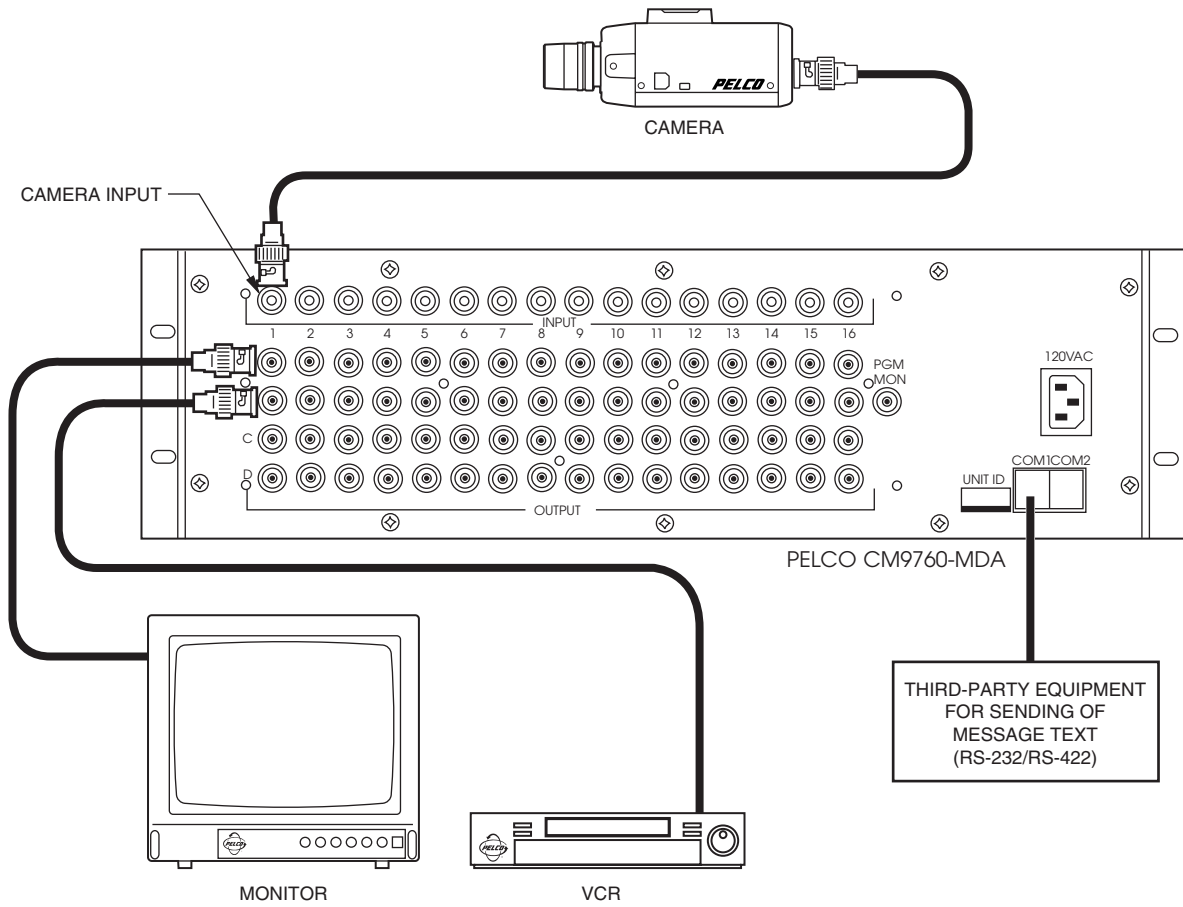

Figure 47. CM9760-MDA Message Text Sent from Third-Party Equipment

APPENDIX B – SUPPORTED TITLE AND MESSAGE TEXT CHARACTERS

The CM9760-MDA supports the characters listed in Table G for display of title and message text. If a character is not supported, the CM9760-MDA PC Setup program on a PC blocks entry of the character in title and message lines. If you enter a title in the CM9760-MDA SETUP dialog box or enter a message in the Message Text Editing dialog box and type a character that is not supported, the CM9760-MDA PC Setup program prevents entry of the character.

Table G. Supported Title and Message Text Character Set

1	a	k	u	E	O	Y	/ (forward slash) (see NOTE below)
2	b	l	v	F	P	Z	* (asterisk)
3	c	m	w	G	Q	:	(colon) space
4	d	n	x	H	R	<	(less than)
5	e	o	y	I	S	>	(greater than)
6	f	p	z	J	T	-	(hyphen)
7	g	q	A	K	U	.	(period)
8	h	r	B	L	V	,	(comma)
9	i	s	C	M	W	;	(semicolon)
0	j	t	D	N	X	?	(question mark)
NOTE: The forward slash can be displayed in a message but cannot be displayed in a title.							

APPENDIX C – MESSAGE TEXT INSERTION COMMANDS

As discussed in the *Set Message Text* section of this manual, the CM9760-MDA supports message text insertion protocol commands for display of text messages. The commands can be used by third-party equipment when interfacing the COM 1 or COM 2 port of the CM9760-MDA using the RS-232 or RS-422 communication standard.

Table H provides a listing of the message text insertion commands based upon the function of the command.

Table H. CM9760-MDA Message Text Insertion Commands

Command Function	Command Format
Set one line of message text on an MDA unit/channel/row	[A0][CB][00][Unit ID][Channel][Row][Message Text (1-24 characters)][AF][Checksum]
Set up to five lines of message text on an MDA unit/channel	[A0][CB][01][Unit ID][Channel][Message Text (4 to 124 characters)][AF][Checksum]
Query the message text that is displayed on an MDA unit/channel*	[A0][CB][02][Unit ID][Channel][AF][Checksum]
Clear one line of message text from an MDA unit/channel/row	[A0][CB][03][Unit ID][Channel][Row][AF][Checksum]
Clear all lines of message text from an MDA unit/channel	[A0][CB][04][Unit ID][Channel][AF][Checksum]
Clear all message text from all channels of the selected MDA unit	[A0][CB][05][Unit ID][AF][Checksum]
Format the text block display on MDA unit/channel	[A0][CB][06][Unit ID][Channel][Format][Rows to Display/Scroll][Row Separation][High Message Time][Low Message Time][AF][Checksum]
Format the text block display on all channels for the selected MDA unit	[A0][CB][07][Unit ID][Format][Rows to Display/Scroll][Row Separation][High Message Time][Low Message Time][AF][Checksum]
Query text block format on an MDA unit/channel†	[A0][CB][08][Unit ID][Channel][AF][Checksum]
Insert message text and scroll the other rows upward	[A0][CB][09][Unit ID][Channel][Message Text (1-24 characters)][AF][Checksum]
*The MDA response to the message text query command is the command using function byte 01.	
†The MDA response to the message format query command is the command using function byte 06.	

Note the following about the commands shown in Table H:

- Data within brackets is expressed as hexadecimal data. Brackets are not part of the commands—the brackets are used to separate the various parts of the command to provide ease of readability.

- First four bytes of each command are as follows:

[A0][CB][function byte][Unit ID]

where:

[A0] and [CB] = 2-byte header information

[function byte] = [00] to [09], which determines the command function

[Unit ID] = [00] to [63] in packed binary code decimal (BCD) format, which defines the Unit ID number of the MDA

- Optional command parameters depend on the function byte ([00] to [09]) and include the following:
 - [Channel] = [00] to [15] in packed BCD format, which defines the channel number of the MDA unit
 - [Row] = [01] to [05] in packed BCD format, which defines the row number in which message text is to be set or cleared
 - [Message Text] = specifies the message text to be displayed:
 - 1 to 24 characters for one line of message text
 - 4 to 124 characters, where:
 - Minimum = 4 message separator bytes ([7F][7F][7F][7F]) and no message text
 - Maximum = 124 bytes: 5 messages containing 24 characters each (120 message bytes) plus 4 message separator bytes ([7F][7F][7F][7F])
 - [Format] = [00] or [01], where:
 - [00] = displays message text below the title/time/date text
 - [01] = displays message text above the title/time/date text
 - [Row-Separation] = [00] to [28], which defines the number of blank rows separating the title/time/date text and the message text displays
 - [Rows-to-Display/Scroll] = [00] to [05], which defines the number of message text lines to be displayed. Also defines the number of message text lines to be scrolled.
 - [High Message Time][Low Message Time] = Message time bytes that are transmitted and received in packed BCD format. The message time bytes define the number of seconds that the message text is to be displayed. The maximum display time-out is 9,999 seconds. A display time-out of 0 seconds allows the text to be displayed indefinitely or until overwritten.
- Last two bytes of each command are as follows:

[AF][Checksum]

where:

 - [AF] = signals end of the command
 - [Checksum] = exclusive-or of all other bytes in the command

REGULATORY NOTICES

This device complies with part 15 of the FCC Rules. Operation is subject to the following two conditions: (1) this device may not cause harmful interference, and (2) this device must accept any interference received, including interference that may cause undesired operation.

RADIO AND TELEVISION INTERFERENCE

This equipment has been tested and found to comply with the limits of a Class B digital device, pursuant to part 15 of the FCC rules. These limits are designed to provide reasonable protection against harmful interference in a residential installation. This equipment generates, uses, and can radiate radio frequency energy and, if not installed and used in accordance with the instructions, may cause harmful interference to radio communications. However there is no guarantee that the interference will not occur in a particular installation. If this equipment does cause harmful interference to radio or television reception, which can be determined by turning the equipment off and on, the user is encouraged to try to correct the interference by one or more of the following measures:

- Reorient or relocate the receiving antenna.
- Increase the separation between the equipment and the receiver.
- Connect the equipment into an outlet on a circuit different from that to which the receiver is connected.
- Consult the dealer or an experienced radio/TV technician for help.

You may also find helpful the following booklet, prepared by the FCC: "How to Identify and Resolve Radio-TV Interference Problems." This booklet is available from the U.S. Government Printing Office, Washington D.C. 20402.

Changes and modifications not expressly approved by the manufacturer or registrant of this equipment can void your authority to operate this equipment under Federal Communications Commission's rules.



This equipment contains electrical or electronic components that must be recycled properly to comply with Directive 2002/96/EC of the European Union regarding the disposal of waste electrical and electronic equipment (WEEE). Contact your local dealer for procedures for recycling this equipment.

Green The materials used in the manufacture of this document and its components are compliant to the requirements of Directive 2002/95/EC.

WARRANTY AND RETURN INFORMATION

WARRANTY

Pelco will repair or replace, without charge, any merchandise proved defective in material or workmanship for a period of one year after the date of shipment. Exceptions to this warranty are as noted below:

- Five years on Pelco manufactured cameras (CC3500/CC3600/CC3700 and MC3500/MC3600 Series); two years on all other cameras.
- Three years on Genex® Series (multiplexers, server, and keyboard) and 090 Series Camclosure® Camera System.
- Two years on 100/150, 200 and 300 Series Camclosure® Camera Systems.
- Two years on all standard motorized or fixed focal length lenses.
- Two years on Legacy®, CM6700/CM6800/CM8500/CM9500/CM9740/CM9760 Matrix, DF5 and DF8 Series Fixed Dome products.
- Two years on Spectra®, Esprit®, and PS20 Scanners, including when used in continuous motion applications.
- Two years on Esprit and WW5700 series window wiper (excluding wiper blades).
- Eighteen months on DX Series digital video recorders.
- One year (except video heads) on video cassette recorders (VCRs). Video heads will be covered for a period of six months.
- Six months on all pan and tilts, scanners or preset lenses used in continuous motion applications (that is, preset scan, tour and auto scan modes).

Pelco will warrant all replacement parts and repairs for 90 days from the date of Pelco shipment. All goods requiring warranty repair shall be sent freight prepaid to Pelco, Clovis, California. Repairs made necessary by reason of misuse, alteration, normal wear, or accident are not covered under this warranty.

Pelco assumes no risk and shall be subject to no liability for damages or loss resulting from the specific use or application made of the Products. Pelco's liability for any claim, whether based on breach of contract, negligence, infringement of any rights of any party or product liability, relating to the Products shall not exceed the price paid by the Dealer to Pelco for such Products. In no event will Pelco be liable for any special, incidental or consequential damages (including loss of use, loss of profit and claims of third parties) however caused, whether by the negligence of Pelco or otherwise.

The above warranty provides the Dealer with specific legal rights. The Dealer may also have additional rights, which are subject to variation from state to state.

If a warranty repair is required, the Dealer must contact Pelco at (800) 289-9100 or (559) 292-1981 to obtain a Repair Authorization number (RA), and provide the following information:

1. Model and serial number
2. Date of shipment, P.O. number, Sales Order number, or Pelco invoice number
3. Details of the defect or problem

If there is a dispute regarding the warranty of a product which does not fall under the warranty conditions stated above, please include a written explanation with the product when returned.

Method of return shipment shall be the same or equal to the method by which the item was received by Pelco.

RETURNS

In order to expedite parts returned to the factory for repair or credit, please call the factory at (800) 289-9100 or (559) 292-1981 to obtain an authorization number (CA number if returned for credit, and RA number if returned for repair).

All merchandise returned for credit may be subject to a 20% restocking and refurbishing charge.

Goods returned for repair or credit should be clearly identified with the assigned CA or RA number and freight should be prepaid. Ship to the appropriate address below.

If you are located within the continental U.S., Alaska, Hawaii or Puerto Rico:
 Service Department
 Pelco
 3500 Pelco Way
 Clovis, CA 93612-5699

If you are located outside the continental U.S., Alaska, Hawaii or Puerto Rico:
Intermediate Consignee
 American Overseas Air Freight
 320 Beach Road
 Burlingame, CA 94010
 USA

Ultimate Consignee
 Pelco
 3500 Pelco Way
 Clovis, CA 93612-5699
 USA

REVISION HISTORY

Manual #	Date	Comments
C573M	6/98	Original version.
C573M-A	6/99	Rev. A. Added Regulatory Notices section. Revised Overview section. Added FCC certification. Revised the Installation section and added new drawings. Expanded the address switch settings chart from 512 cameras to 1,024 cameras. Added Reset and Master Clock sections. Added a video coaxial cable wiring distances chart. Removed the menu system map and reorganized material in the Software and Programming Methods sections. Reorganized and revised the Specifications section. Removed section numbers, and renumbered figures and cross references throughout the manual.
C573M-B	4/00	Added information on programming with the KBD200 and KBD300 keyboards. Added reset information to a Caution at a later date.
C573M-C	8/02	Revised Figure 5.
C573M-D	11/03	Revised manual to support version 1.40 (ECO #03-8629) and 2.05 (ECO #03-9517) of the CM9760-MDA Setup program. Also revised and added information regarding support of maximum of 16 daisy-chained MDA units.

® Pelco, the Pelco logo, Spectra, Genex, Legacy, PelcoVision, Coaxitron, Esprit, Camclosure, and System 9760 are registered trademarks of Pelco.

® Microsoft and Windows are registered trademarks of Microsoft Corporation.

™ System 9740 is a trademark of Pelco.

© Copyright 2003, Pelco.

All rights reserved.

Free Manuals Download Website

<http://myh66.com>

<http://usermanuals.us>

<http://www.somanuals.com>

<http://www.4manuals.cc>

<http://www.manual-lib.com>

<http://www.404manual.com>

<http://www.luxmanual.com>

<http://aubethermostatmanual.com>

Golf course search by state

<http://golfingnear.com>

Email search by domain

<http://emailbydomain.com>

Auto manuals search

<http://auto.somanuals.com>

TV manuals search

<http://tv.somanuals.com>