



## **400 Series Flat Panel LCD Monitors**



**C2927M-C (12/06)**



# Contents

---

Important Safety Instructions .....	4
Regulatory Notices .....	5
Description .....	6
Models .....	6
Package Contents .....	7
Installation .....	8
Desktop Stand .....	8
Rear Panel Connectors .....	8
Video and Power Connections .....	10
Operation .....	12
Installing Remote Control Batteries .....	12
Front Panel Controls .....	13
Remote Control Functions .....	14
OSD Control Menus .....	15
Video Menu (Video Mode) .....	15
Video Menu (VGA Mode) .....	16
Audio Menu .....	16
Screen Menu (Video Mode) .....	16
Screen Menu (VGA Mode) .....	17
Source Menu (Video Mode) .....	17
Source Menu (VGA Mode) .....	18
Option Menu .....	18
Menu Default Values .....	19
Cleaning .....	19
Supported Input Modes .....	20
Specifications .....	21

## List of Illustrations

1 Rear Panel Connectors .....	7
2 Front Panel Controls .....	8
3 Main Menu .....	9
4 Display Adjust Menu .....	10
5 Color Temperature Menu .....	10
6 OSD Adjust Menu .....	11
7 Audio Control Menu .....	11

## List of Tables

A Video Coaxial Cable Requirements .....	10
--	----

# Important Safety Instructions

---

1. Read these instructions.
2. Keep these instructions.
3. Heed all warnings.
4. Follow all instructions.
5. Do not use this apparatus near water.
6. Clean only with dry cloth.
7. Do not block any ventilation openings. Install in accordance with the manufacturer's instructions.
8. Do not install near any heat sources such as radiators, heat registers, stoves, or other apparatus (including amplifiers) that produce heat.
9. Do not defeat the safety purpose of the polarized or grounding-type plug. A polarized plug has two blades with one blade wider than the other. A grounding plug has two blades and a third grounding prong. The wide blade or the third prong are provided for your safety. If the provided plug does not fit into your outlet, consult an electrician for replacement of the obsolete outlet.
10. Protect the power cord from being walked on or pinched particularly at plugs, convenience receptacles, and the points where they exit from the apparatus.
11. Only use attachments/accessories specified by the manufacturer.
12. Use only with the cart, stand, tripod, bracket, or table specified by the manufacturer, or sold with the apparatus. When a cart is used, use caution when moving the cart/apparatus combination to avoid injury from tip-over.
13. Refer all servicing to qualified service personnel. Servicing is required when the apparatus has been damaged in any way, such as power-supply cord or plus is damaged, liquid has been spilled or objects have fallen into the apparatus, the apparatus has been exposed to rain or moisture, does not operate normally, or has been dropped.
14. Apparatus shall not be exposed to dripping or splashing and that no objects filled with liquids, such as vases shall be placed on the apparatus.
15. **WARNING:** To reduce the risk of fire or electric shock, do not expose this apparatus to rain or moisture.
16. Installation should be done only by qualified personnel and conform to all local codes.
17. Unless this unit is specifically marked as NEMA Type 3, 3R, 3S, 4, 4X, 6, or 6P enclosure, it is designed for indoor use only and it must not be installed where exposed to rain and moisture.
18. Use only installation methods and materials capable of supporting four times the maximum specified load.
19. Only use replacement parts recommended by Pelco.
20. Avoid touching the screen directly with your fingers as the oils from your skin may be difficult to remove from the LCD.
21. Do not apply direct pressure on the screen.
22. Keep the monitor in a dust-free environment and away from strong electromagnetic fields.
23. Do not use attachments, such as mounts, that are not recommended by Pelco. They may be hazardous.
24. Do not place the monitor on an unstable stand, bracket, or mount. The unit may fall, causing serious damage to the unit or injury to a person. Only use mounts recommended by Pelco.
25. A CCC-approved power cord must be used to power this equipment when used in China.

The product and/or manual may bear the following marks:



This symbol indicates that dangerous voltage constituting a risk of electric shock is present within this unit.



This symbol indicates that there are important operating and maintenance instructions in the literature accompanying this unit

<b>CAUTION:</b>
<b>RISK OF ELECTRIC SHOCK. DO NOT OPEN.</b>

# Regulatory Notices

---

This device complies with Part 15 of the FCC Rules. Operation is subject to the following two conditions: (1) this device may not cause harmful interference, and (2) this device must accept any interference received, including interference that may cause undesired operation.

## **RADIO AND TELEVISION INTERFERENCE**

This equipment has been tested and found to comply with the limits of a Class B digital device, pursuant to Part 15 of the FCC Rules. These limits are designed to provide reasonable protection against harmful interference in a residential installation. This equipment generates, uses, and can radiate radio frequency energy and, if not installed and used in accordance with the instructions, may cause harmful interference to radio communications. However there is no guarantee that the interference will not occur in a particular installation. If this equipment does cause harmful interference to radio or television reception, which can be determined by turning the equipment off and on, the user is encouraged to try to correct the interference by one or more of the following measures:

- Reorient or relocate the receiving antenna.
- Increase the separation between the equipment and the receiver.
- Connect the equipment into an outlet on a circuit different from that to which the receiver is connected.
- Consult the dealer or an experienced radio/TV technician for help.

You may also find helpful the following booklet, prepared by the FCC: "How to Identify and Resolve Radio-TV Interference Problems." This booklet is available from the U.S. Government Printing Office, Washington D.C. 20402.

Changes and Modifications not expressly approved by the manufacturer or registrant of this equipment can void your authority to operate this equipment under Federal Communications Commission's rules.

This Class B digital apparatus complies with Canadian ICES-003.

Cet appareil numérique de la classe B est conforme à la norme NMB-003 du Canada.

# Description

---

The 400 Series high performance LCD monitors are designed specifically for the security industry and provide high quality display of video or computer signals using multiple inputs. These 15-, 17-, and 19-inch monitors use a color, thin film transfer (TFT) active matrix LCD panel that automatically adapts to the appropriate input resolution.

The 400 Series is distinguished by many performance-enhancing features such as a 3-D digital comb filter, DVI (digital visual interface) input, picture-in-picture (PIP), and USB hub. The 3-D digital comb filter with deinterlacing provides the most accurate processing of composite video signals for a sharper, cleaner picture. DVI ensures that digital signals remain uncompressed (in their true digital form) without the distortion that may occur through analog-to-digital conversion. The PIP feature allows for simultaneous viewing of surveillance camera images and PC screens. A USB hub provides a single input with three outputs adding to the overall flexibility of the high performance 400 Series.

The 400 Series provides two looping composite (BNC) inputs and outputs and one S-Video input and output. Additionally, these models provide an analog VGA input to support the use of DVRs (digital video recorders) and PC applications. This multimode functionality—combined with the high performance features, quick panel response time to minimize ghosting in motion video, ergonomic design, autoranging internal power supply, and low power consumption—makes the 400 Series the optimal replacement for conventional CRT monitors.

The 400 Series features a folding picture frame-style desktop stand, optional rack mount kits, and VESA®-compliant mounting holes to easily adapt to any VESA-compliant wall mount.

These monitors automatically detect and display the correct video format (NTSC or PAL) and are powered by an internal autoranging power supply.

The 400 Series uses four long-life CCFT (cold cathode fluorescent tube) backlights to maintain the brightness level over time, eliminating the brightness degradation common in aging CRT monitors.

Adjustments of standard monitor display parameters are made using user-friendly, on-screen menus and front panel controls.

## MODELS

PMCL415	15-inch (381 mm) active TFT LCD monitor
PMCL417	17-inch (432 mm) active TFT LCD monitor
PMCL419	19-inch (483 mm) active TFT LCD monitor

## PACKAGE CONTENTS

- 1 15-, 17-, or 19-inch TFT LCD monitor
- 1 VGA cable with 15-pin, D-sub connector
- 1 US standard power cable
- 1 EU standard power cable
- 1 DVI cable
- 1 USB cable (Type A to B)
- 1 Remote control unit
- 2 AA batteries
- 1 Installation/Operation manual

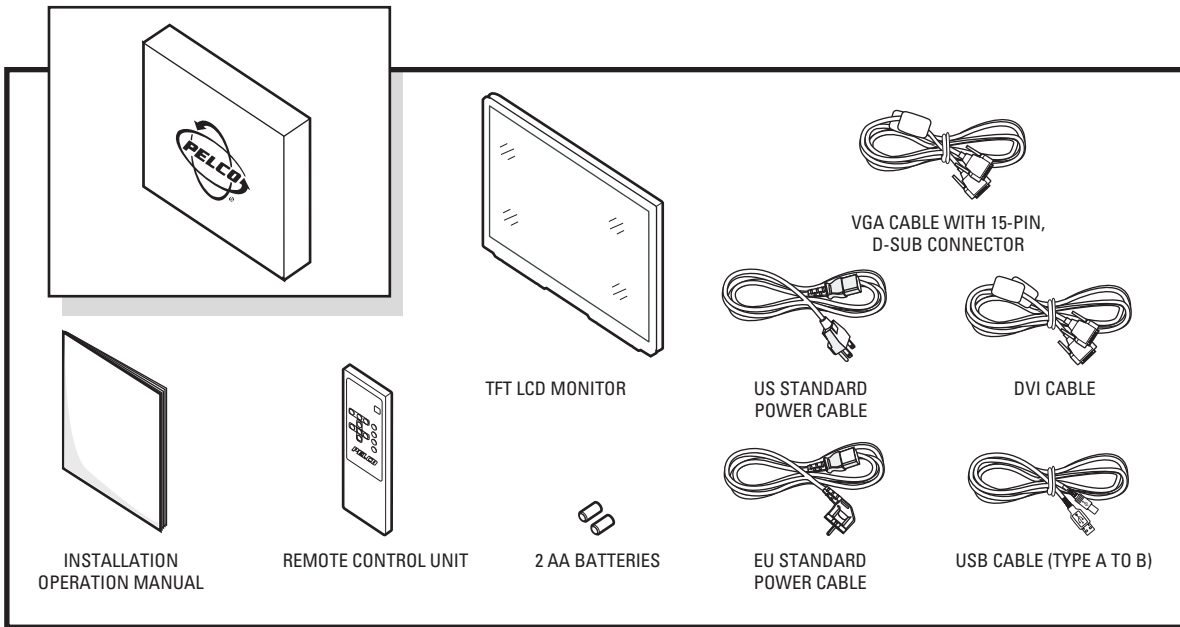

Figure 1. Parts List Illustration

# Installation

The monitor can be placed on any flat surface (desk or table), or it can be rack mounted or wall mounted.

**NOTE:** Only use a recommended rack mount or wall mount kit, such as the PMCL-RM15, PMCL-RM17, PMCL-RM19, or PMCL-WM. To rack-mount or wall-mount the monitor, follow the instructions supplied with the mount kit. Refer to manual C2220M for the rack mount kit instructions or C2219M for the wall mount kit instructions.

## DESKTOP STAND

You can manually adjust the 400 Series monitor to the viewing angle you want by repositioning the foot stand on the back of the monitor.

## REAR PANEL CONNECTORS

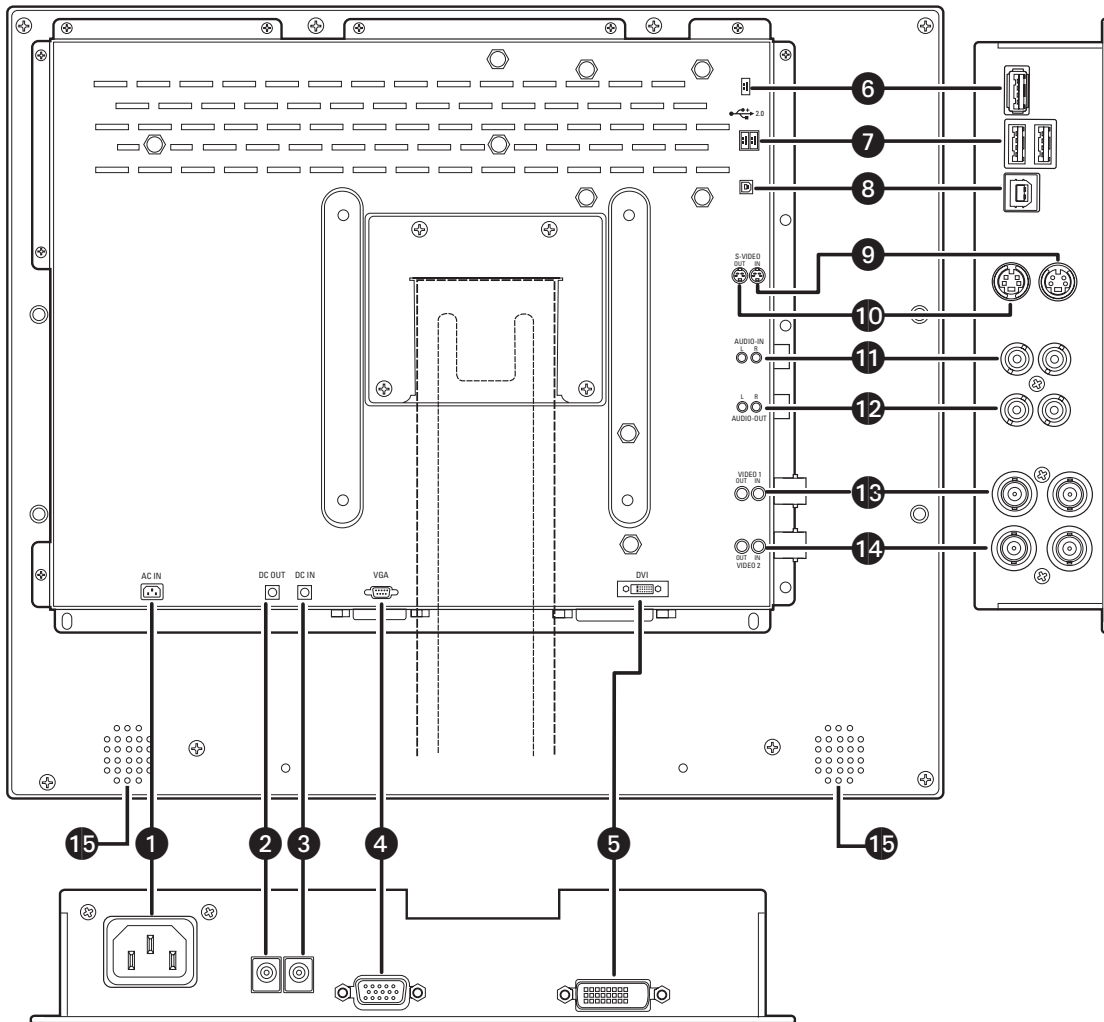

Figure 2. Rear Panel Connectors



1. **AC IN:** Can be connected to a 100-240 VAC, 50/60 Hz source.
2. **DC OUT:** Can output 12 VDC, 0.5 A (continuous), 50/60 Hz.
3. **DC IN:** Can be connected to an external 12 VDC, 5 A source.
4. **VGA IN:** Can be connected to the VGA cable (supplied).
5. **DVI IN:** Can be connected to the DVI cable (supplied).
6. **USB:** The USB-A 2.0 downstream port. It can be used to connect to such peripherals as a USB camera or USB key.
7. **USB:** The USB-A 2.0 downstream dual port. It can be used to connect to such peripherals as a USB camera or USB key.
8. **USB:** The USB-B 2.0 upstream port. It can be used to connect to a PC using the USB cable (supplied).
9. **S-VIDEO IN:** Can input an S-video signal by DIN socket.
10. **S-VIDEO OUT:** Can output an S-video signal by DIN socket. This socket is the loop-through output (maximum of one looping operation only is recommended).
11. **AUDIO IN:** These RCA sockets can be connected to audio outputs (White terminal, Red terminal).
12. **AUDIO OUT:** These RCA sockets can output sound to other speakers. This socket is the loop-through output.
13. **VIDEO 1 IN/OUT:** The IN BNC socket can be connected to a composite video output. The OUT BNC socket is the loop-through output. The input is automatically terminated if the loop-through output is not used.
14. **VIDEO 2 IN/OUT:** The IN BNC socket can be connected to a composite video output. The OUT BNC socket is the loop-through output. The input is automatically terminated if the loop-through output is not used.
15. **Speakers:** The unit has two built-in speakers.

# VIDEO AND POWER CONNECTIONS

Refer to Figure 2 for video, audio, power, and other connections.

1. Connect the video cable (refer to Table A for video coaxial requirements.)
  - a. Connect video cables as follows, depending on the input source.
    - For composite, connect to the BNC video input labeled VIDEO 1 IN on the back panel of the monitor. If the installation requires a second video input, connect a video cable to the BNC video input labeled VIDEO 2 IN. (Inputs are auto-terminating. If the correlating output is not used, the input will be terminated.)
    - For S-Video, connect to the input labeled S-VIDEO IN on the back panel of the monitor. (Inputs are auto-terminating. If the correlating output is not used, the input will be terminated.)
    - For VGA, connect to the input labeled VGA IN on the back panel of the monitor.
    - For DVI, connect to the input labeled DVI IN on the back panel of the monitor.
  - b. If you intend on using the PIP feature, you can connect video inputs in any of the following combinations:
    - One VGA input and one composite input.
    - One VGA input and one S-Video input.

Note the following when using PIP mode:

- If PIP is enabled when you connect a video input, auto detect will not function and the signal may not be synchronized.
  - If PIP is enabled in VGA or composite video mode, video menu adjustments affect the PIP and not the main screen.
  - DVI mode does not support PIP.
- c. *Looping operation only.* Connect a video cable to the BNC video connector labeled VIDEO 1 OUT for composite video or connect the video cable to the connector labeled S-VIDEO OUT for S-Video. If the installation requires a second composite video output, connect a video cable to the BNC video output labeled VIDEO 2 OUT (refer to Figure 3 and Figure 4.)

**NOTE:** A maximum of three Lacs can be looped (except for S-Video, where only one loop is advised).

2. Connect peripherals, as desired. Connect USB cables to the downstream USB ports on the back of the monitor (refer to callout numbers 6 and 7 in Figure 2.)
3. Connect to a PC, as desired. Connect a USB cable (supplied) to the upstream USB port on the back of the monitor (refer to callout number 8 in Figure 2.)
4. Connect audio, as desired. The monitor has built-in speakers but can also loop out to an external speaker. Connect the audio input cables to the connections labeled AUDIO IN on the back panel of the monitor. Connect one end of the audio output cables to the connections labeled AUDIO OUT on the back panel of the monitor and the other end to a speaker (refer to Figure 3 and Figure 4 for looping connections.)
5. Connect power. Do one of the following:
  - Plug the provided power cord into the AC IN connection on the back panel. Plug the other end of the cord into a power receptacle.
  - If using an external power supply (not included), plug one end of the power supply into the DC IN connector on the back panel of the monitor. Plug the other end of the power supply into a power receptacle.

Table A. Video Coaxial Cable Requirements

Cable Type*	Maximum Distance
RG59/U	750 ft (229 m)
RG6/U	1,000 ft (305 m)
RG11/U	1,500 ft (457 m)

\*Minimum cable requirements:

75 ohms impedance. All-copper center conductor.

95% braided copper shield.

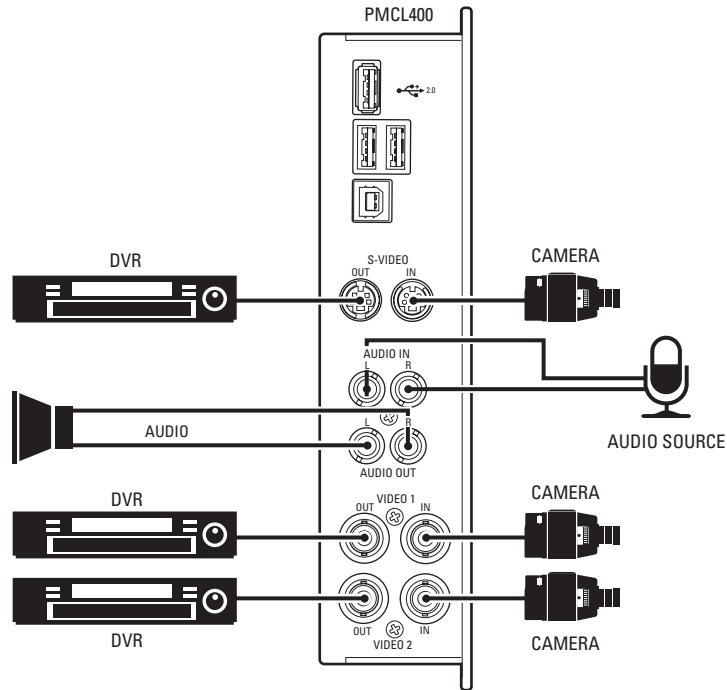

Figure 3. Looping Operation: One Monitor with External Video Equipment

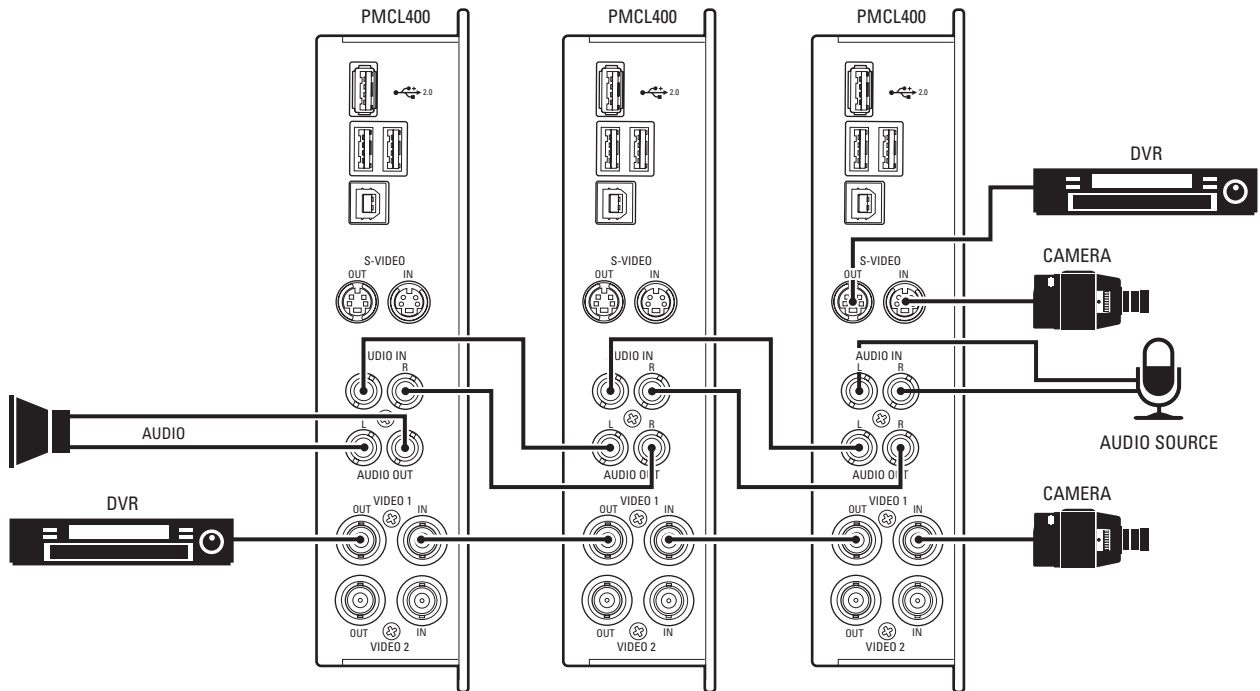

Figure 4. Looping Operation: Maximum of Three Monitors with External Video Equipment

**NOTE:** Looping more than three 400 Series monitors is *not* recommended.

# Operation

---

## INSTALLING REMOTE CONTROL BATTERIES

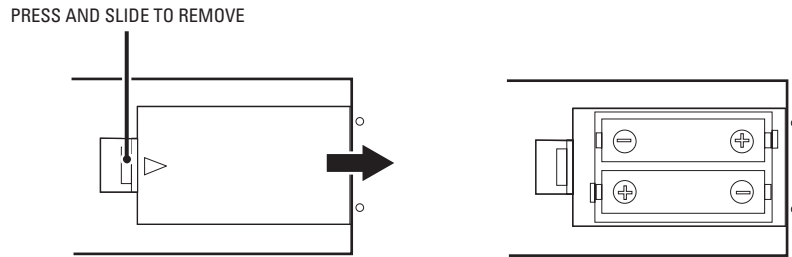

Figure 5. Battery Installation

Refer to Figure 5 for the following procedure.

1. Open and remove the battery cover on the back of the remote control.
2. Install two AA size batteries (supplied). Match the + and – signs on the batteries to the signs on the battery compartment.
3. Close the battery cover. Make sure the lock snaps closed.

### **WARNING:**

- Dispose of batteries in a designated disposal area. Do not throw batteries into a fire.
- Do not mix battery types.
- Remove dead batteries immediately to prevent battery acid from leaking into the battery compartment.
- Remove the batteries if you do not intend to use the remote control for a long period of time.

## FRONT PANEL CONTROLS

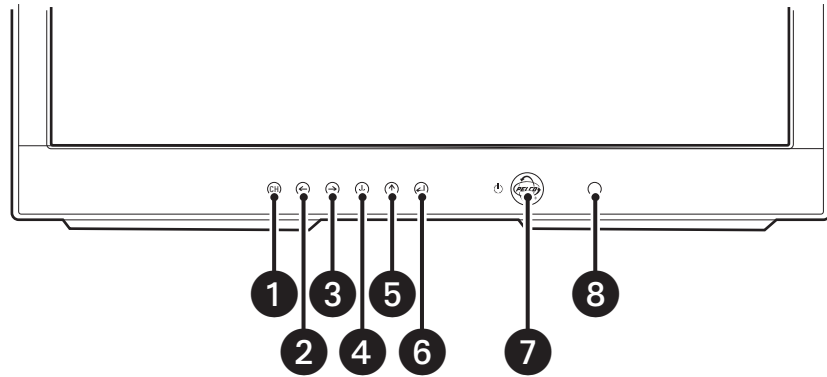

Figure 6. Front Panel Controls

1. Selects the input signal and swaps the main and PIP displays when PIP is active.
2. Decreases the value of a selected menu item and accesses the brightness control when no PIP or menu is active. It can reposition PIP when PIP is active.
3. Increases the value of a selected menu item, and it enables or disables PIP when no menu is active.
4. Moves the highlighter downward through a menu.
5. Moves the highlighter upward through a menu.
6. Opens the main menu when no menu is active, and it selects a highlighted menu item when a menu is active.  
**NOTE:** This button has a two-second delay in opening the menu when pressed. It also functions as a lock/unlock button. When pressed for five seconds, a red box containing the words KEY LOCKED or KEY UNLOCK appears. When KEY LOCKED is active, all front panel controls (including the power button and controls on the remote control) are disabled. Activate KEY UNLOCK by pressing the button for five seconds to regain control.
7. Turns on or off power to the monitor.
8. Receives the remote control signal. This is the infrared sensor for the remote control unit.

## REMOTE CONTROL FUNCTIONS

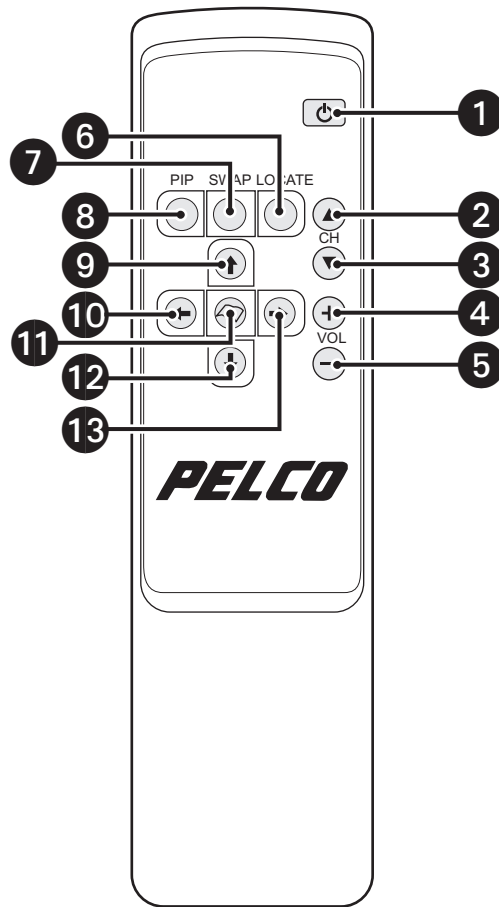

Figure 7. Remote Control Functions

1. Turns on or off power to the monitor.
2. Selects the previous channel.
3. Selects the next channel.
4. Increases the audio volume.
5. Decreases the audio volume.
6. Moves the PIP location to the next location (upper left, upper right, lower right, lower left, middle).
7. Swaps the PIP image with the main image or the main image with the PIP image.
8. Selects the PIP function.
9. Moves the highlighter upward through a menu.
10. Decreases the value of a selected menu item.
11. Enters the OSD menu and submenus, and it selects items.
12. Moves the highlighter downward through a menu.
13. Increases the value of a selected menu item.

## OSD CONTROL MENUS

Unless otherwise noted, the menus are the same for the PMCL415, PMCL417, and PMCL419. Since different options are available for different input types, some menus have a video mode and a VGA mode. Some options may be unavailable and are grayed out.

**NOTE:** There is no reset feature to return the monitor to factory defaults.

To use the menus:

1. Press the menu button to access the Main menu.
2. Use the up and down arrow buttons to highlight a selection.
3. Press the menu button to select an item.
4. Use the left and right arrow buttons to adjust the setting on a selected item.

### VIDEO MENU (VIDEO MODE)

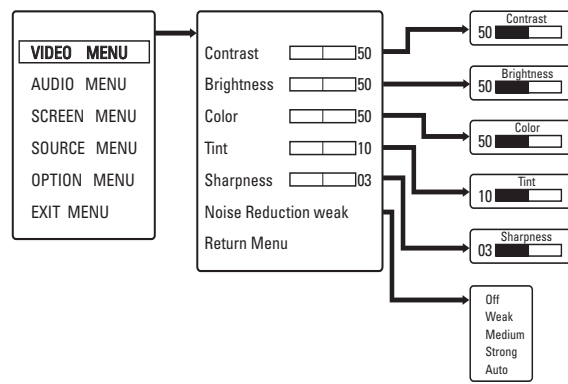

Figure 8. Video Menu (Video Mode)

If PIP is active in video mode, these controls affect PIP and not the Main Display.

#### Video Menu (Video Mode) Field Definitions

**Contrast:** Adjusts the white level of the video screen image.

**Brightness:** Adjusts the black level of the video screen image.

**Color:** Adjusts the color saturation of the video signal.

**Tint:** Adjusts the range of color: green to red.

**Sharpness:** Adjusts the picture softer or sharper.

**Noise Reduction:** Adjusts the background noise of the video signal.

## VIDEO MENU (VGA MODE)

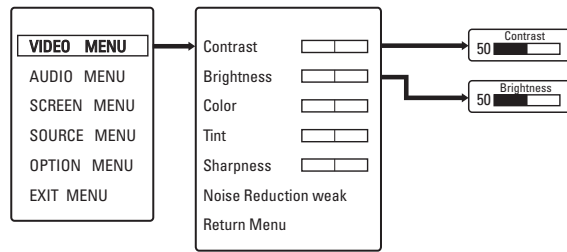

Figure 9. Video Menu (VGA Mode)

If PIP is active in VGA mode, these controls affect PIP and not the Main Display.

### Video Menu (VGA Mode) Field Definitions

**Contrast:** Adjusts the white level of the video screen image.

**Brightness:** Adjusts the black level of the video screen image.

## AUDIO MENU

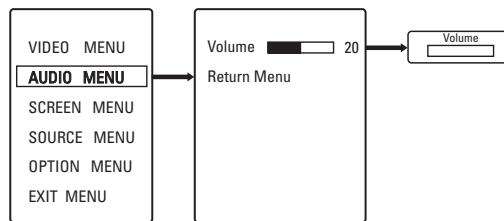

Figure 10. Audio Menu

### Audio Menu Field Definitions

**Volume:** Adjusts the volume level.

## SCREEN MENU (VIDEO MODE)

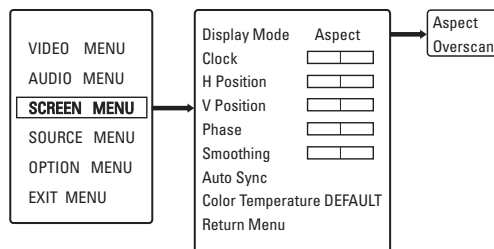

Figure 11. Screen Menu (Video Mode)

### Screen Menu (Video Mode) Field Definitions

**Display Mode:** Select Aspect or Overscan mode.

Aspect mode on the 17- and 19-inch monitors gives a slightly elongated picture. In overscan mode some of the picture's sides are lost but the vertical geometry is correct. These accommodations occur as the incoming 4:3 aspect ratio composite video [1024 x 768] is converted to the panel's native 5:4 ratio (1280 x 1024).



## SCREEN MENU (VGA MODE)

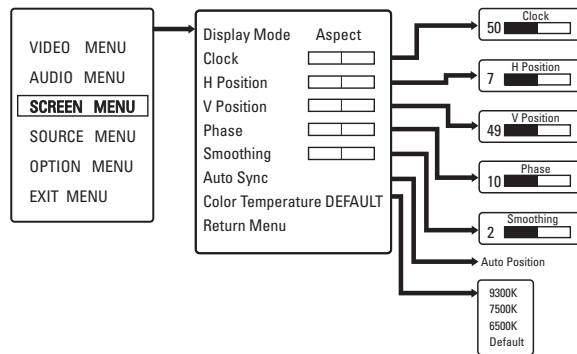

Figure 12. Screen Menu (VGA Mode)

### Screen Menu (VGA Mode) Field Definitions

**Clock:** Adjusts the horizontal size of the screen image.

**H Position:** Moves the screen image left or right.

**V Position:** Moves the screen image up or down.

**Phase:** Adjusts image distortion appearing as horizontal noise on the screen.

**Smoothing:** Enhances picture quality.

**Auto Sync:** Adjusts the screen image automatically for the best result.

**Color Temperature:** Adjusts the color temperature to 9300K, 7500K, 6500K or Default.

## SOURCE MENU (VIDEO MODE)

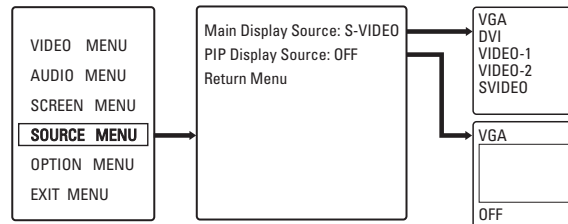

Figure 13. Source Menu (Video Mode)

### Source Menu (Video Mode) Field Definitions

**Main Display Source:** Select one: VGA, DVI, VIDEO-1, VIDEO-2, SVIDEO.

**PIP Display Source:** Select one: VGA or OFF. (Some choices will be shaded depending on your Main Display Source selection.) If PIP is active in video mode, these controls affect PIP and not the Main Display.

## SOURCE MENU (VGA MODE)

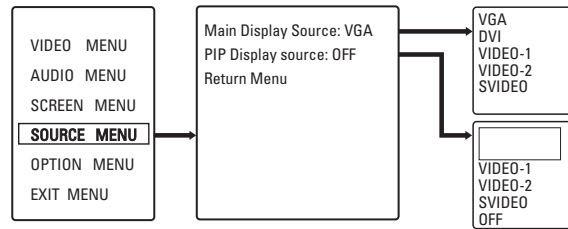

Figure 14. Source Menu (VGA Mode)

### Source Menu (VGA Mode) Field Definitions

**Main Display Source:** Select one: VGA, DVI, VIDEO-1, VIDEO-2, SVIDEO.

**PIP Display source:** Select one: VIDEO-1, VIDEO-2, SVIDEO, OFF. (Some choices will be shaded depending on your Main Display Source selection.) If PIP is active in VGA mode, these controls affect PIP and not the Main Display.

## OPTION MENU

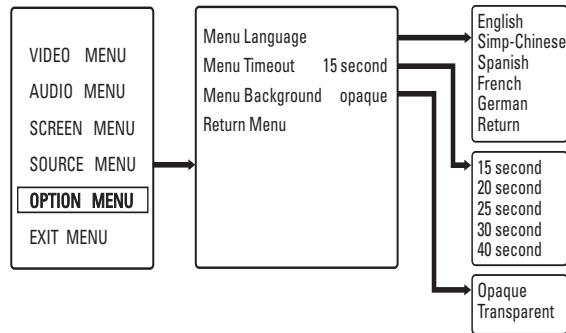

Figure 15. Option Menu

### Option Menu Field Definitions

**Menu Language:** Select a language for the OSD menu display: English, Chinese, Spanish, French, or German.

**Menu Timeout:** Select one for the OSD menu display: 15 second, 20 second, 25 second, 30 second, 40 second. Every "x" seconds, submenus will exit until the menus are fully exited.

**Menu Background:** Select one for the OSD menu display: Opaque or Transparent.

## MENU DEFAULT VALUES

Refer to the following default values if you need to manually return the monitor to the factory settings.

### Video Menu

Contrast	50
Brightness	50
Color	50
Tint	0
Sharpness	2
Noise Reduction	Strong

### Audio Menu

Volume	8
--------	---

### Screen Menu

Display Mode	Aspect
Clock	50
H Position	50
V Position	50
Phase	0
Smoothing	0
Auto Sync	(no default setting)
Color Temperature	9300K

### Source Menu

Main Display Source	VGA
PIP Display Source	OFF

### Option Menu

Menu Language	English
Menu Timeout	15
Menu Background	Opaque

## Maintenance

If the quality of the picture is poor and cannot be improved by making adjustments on the front control panel, inspect all system connections and cable runs.



**WARNING:** To reduce the risk of electrical shock, do not remove the cover or back of the monitor. No user-serviceable parts are inside. Refer servicing to qualified personnel, or contact the Pelco Customer Service Department for assistance, 1-800-289-9100. Refer to the *Product Warranty and Return Information* located on the inside back cover of this manual.

## CLEANING

- Gently wipe your screen with a clean camel hair brush or a soft, clean, lint-free cloth.
- Gently apply pressure to the screen surface to clean the display.
- Do not spray *any* liquid directly on the screen or the LCD monitor casing.
- Chemical cleaners can damage the screen or the LCD monitor casing.

## Supported Input Modes

---

Mode	Resolution	H Freq (kHz)	V Freq (Hz)
0	720 x 350	31.469	70.087
1	640 x 480	31.469	59.940
2	640 x 480	35.000	66.667
3	640 x 480	37.861	72.809
4	640 x 480	37.500	75.000
5	720 x 400	31.469	70.087
6	800 x 600	35.156	56.250
7	800 x 600	37.879	60.317
8	800 x 600	48.077	72.188
9	800 x 600	46.875	75.000
10	1024 x 768	48.363	60.004
11	1024 x 768	60.023	75.029

# Specifications

---

## MODELS

PMCL415	15-inch (381 mm) active TFT LCD monitor
PMCL417	17-inch (432 mm) active TFT LCD monitor
PMCL419	19-inch (483 mm) active TFT LCD monitor

## GENERAL

LCD Panel Pixel Array	
PMCL415	1024 X 768, 75 Hz
PMCL417, PMCL419	1280 x 1024, 75 Hz (maximum VGA and DVI resolution is 1024 x 768)
Panel Aspect Ratio	
PMCL415	4.3
PMCL417, PMCL419	4.3 composite, 5.4 VGA
Viewing Area	
PMCL415	304 x 228 mm
PMCL417	338 x 270 mm
PMCL419	376 x 301 mm
Pixel Pitch	
PMCL415	0.297 x 0.297
PMCL417	0.264 x 0.264
PMCL419	0.294 x 0.294
Brightness	
PMCL415	350 cd/m <sup>2</sup>
PMCL417	430 cd/m <sup>2</sup>
PMCL419	450 cd/m <sup>2</sup>
Contrast Ratio	500:1
Backlight Type	4 CCFL
Panel Lamp Life	40,000 hours
Viewing Angle (H/V)	
PMCL415	140°/125°
PMCL417	140°/130°
PMCL419	150°/130°
Tilt	<10° to >45°
Display Colors	
PMCL415, PMCL417	16.2 million
PMCL419	16.7 million
Response Time	
PMCL415	16 ms
PMCL417	8 ms
PMCL419	8 ms
Speakers	2, integrated, 1 W each
Front Panel Controls	Video input, menu (access and navigation), power
Indicators	LED (power on/off), on-screen ("no signal")
<b>ELECTRICAL</b>	
Input Voltage	100-240 VAC, 50/60 Hz, internal power supply or 12 VDC external power supply (not included)
Power Consumption	
PMCL415	<50 W (on)
PMCL417, PMCL419	<60 W (on)
Input Interfaces	
Video*	2 BNC, looping; 1 S-Video, looping; 1 VGA; 1 DVI; 1 PIP
Audio	1 (L/R), RCA, looping
Horizontal Frequency	30 kHz to 60 kHz
Vertical Frequency	56 Hz to 75 Hz
Sync Format	NTSC/PAL autosensing

\*Maximum VGA and DVI resolution is 1024 x 768 on PMCL417 and PMCL419.

## PHYSICAL

### Dimensions

PMCL415	3.0" D x 13.7" W x 11.7" H (7.5 x 34.70 x 29.8 cm)
PMCL417	3.2" D x 15.0" W x 13.4" H (8.0 x 38.1 x 34.1 cm)
PMCL419	3.3" D x 16.6" W x 14.7" H (8.3 x 42.1 x 37.4 cm)

### Unit Weight

PMCL415	10.1 lb (4.6 kg)
PMCL417	13.1 lb (5.9 kg)
PMCL419	15.1 lb (6.9 kg)

### Shipping Weight

PMCL415	14.0 lb (6.4 kg)
PMCL417	18.0 lb (8.2 kg)
PMCL419	20.0 lb (9.1 kg)

## ENVIRONMENTAL

Operating Temperature	32° to 104°F (0° to 40°C)
Storage Temperature	-4° to 140°F (-20° to 60°C)
Operating Humidity	20% to 85%, noncondensing
Storage Humidity	5% to 90%, noncondensing

## PRODUCT WARRANTY AND RETURN INFORMATION

### WARRANTY

Pelco will repair or replace, without charge, any merchandise proved defective in material or workmanship for a period of one year after the date of shipment.

Exceptions to this warranty are as noted below:

- Five years on FR/FT/FS Series fiber optic products and TW3000 Series unshielded twisted pair transmission products.
- Three years on Spectra® IV products.
- Three years on Genex® Series products (multiplexers, server, and keyboard).
- Three years on Camclosure® and fixed camera models, except the CC3701H-2, CC3701H-2X, CC3751H-2, CC3651H-2X, MC3651H-2, and MC3651H-2X camera models, which have a five-year warranty.
- Three years on PMCL200/300/400 Series LCD monitors.
- Two years on standard motorized or fixed focal length lenses.
- Two years on Legacy®, CM6700/CM6800/CM9700 Series matrix, and DF5/DF8 Series fixed dome products.
- Two years on Spectra III™, Esprit®, ExSite™, and PS20 scanners, including when used in continuous motion applications.
- Two years on Esprit and WW5700 Series window wiper (excluding wiper blades).
- Two years (except lamp and color wheel) on Digital Light Processing (DLP®) displays. The lamp and color wheel will be covered for a period of 90 days. The air filter is not covered under warranty.
- Eighteen months on DX Series digital video recorders, NVR300 Series network video recorders, and Endura™ Series distributed network-based video products.
- One year (except video heads) on video cassette recorders (VCRs). Video heads will be covered for a period of six months.
- Six months on all pan and tilts, scanners or preset lenses used in continuous motion applications (that is, preset scan, tour and auto scan modes).

Pelco will warrant all replacement parts and repairs for 90 days from the date of Pelco shipment. All goods requiring warranty repair shall be sent freight prepaid to Pelco, Clovis, California. Repairs made necessary by reason of misuse, alteration, normal wear, or accident are not covered under this warranty.

Pelco assumes no risk and shall be subject to no liability for damages or loss resulting from the specific use or application made of the Products. Pelco's liability for any claim, whether based on breach of contract, negligence, infringement of any rights of any party or product liability, relating to the Products shall not exceed the price paid by the Dealer to Pelco for such Products. In no event will Pelco be liable for any special, incidental or consequential damages (including loss of use, loss of profit and claims of third parties) however caused, whether by the negligence of Pelco or otherwise.

The above warranty provides the Dealer with specific legal rights. The Dealer may also have additional rights, which are subject to variation from state to state.

If a warranty repair is required, the Dealer must contact Pelco at (800) 289-9100 or (559) 292-1981 to obtain a Repair Authorization number (RA), and provide the following information:

1. Model and serial number
2. Date of shipment, P.O. number, Sales Order number, or Pelco invoice number
3. Details of the defect or problem

If there is a dispute regarding the warranty of a product which does not fall under the warranty conditions stated above, please include a written explanation with the product when returned.

Method of return shipment shall be the same or equal to the method by which the item was received by Pelco.

### RETURNS

In order to expedite parts returned to the factory for repair or credit, please call the factory at (800) 289-9100 or (559) 292-1981 to obtain an authorization number (CA number if returned for credit, and RA number if returned for repair).

All merchandise returned for credit may be subject to a 20% restocking and refurbishing charge.

Goods returned for repair or credit should be clearly identified with the assigned CA or RA number and freight should be prepaid. Ship to the appropriate address below.

*If you are located within the continental U.S., Alaska, Hawaii or Puerto Rico, send goods to:*

Service Department  
Pelco  
3500 Pelco Way  
Clovis, CA 93612-5699

*If you are located outside the continental U.S., Alaska, Hawaii or Puerto Rico and are instructed to return goods to the USA, you may do one of the following:*

If the goods are to be sent by a COURIER SERVICE, send the goods to:

Pelco  
3500 Pelco Way  
Clovis, CA 93612-5699 USA

If the goods are to be sent by a FREIGHT FORWARDER, send the goods to:

Pelco c/o Expeditors  
473 Eccles Avenue  
South San Francisco, CA 94080 USA  
Phone: 650-737-1700  
Fax: 650-737-0933

 Green The materials used in the manufacture of this document and its components are compliant to the requirements of Directive 2002/95/EC.



This equipment contains electrical or electronic components that must be recycled properly to comply with Directive 2002/96/EC of the European Union regarding the disposal of waste electrical and electronic equipment (WEEE). Contact your local dealer for procedures for recycling this equipment.

### REVISION HISTORY

Manual #	Date	Comments
C2927M	01/06	Original version.
C2927M-A	01/06	Changed diagonal screen size to 381 mm for the PMCL415 and to 432 mm for the PMCL417. Changed the backlight type to 4 CCFL for the PMCL419. Changed the power consumption to <60W for the PMCL417 and PMCL419. Removed the standby mode specification. Also, removed the second occurrence of the tilt angle specification.
C2927M-B	8/06	In the <i>Specifications</i> section, changed the PMCL419 response time to 8 ms.
C2927M-C	12/06	Changed PMCL417 response time to 8 ms.

Pelco, the Pelco logo, Camclosure, Esprit, Genex, Legacy, and Spectra are registered trademarks of Pelco.  
Endura and ExSite are trademarks of Pelco.  
DLP is a registered trademark of Texas Instruments, Inc.  
VESA is a registered trademark of the Video Electronics Standards Association.

© Copyright 2006, Pelco. All rights reserved.



Worldwide Headquarters  
3500 Pelco Way  
Clovis, California 93612 USA

USA & Canada  
Tel: 800/289-9100  
Fax: 800/289-9150

International  
Tel: 1-559/292-1981  
Fax: 1-559/348-1120

**[www.pelco.com](http://www.pelco.com)**

**ISO9001**

Australia | Canada | Finland | France | Italy | Russia | Singapore | Spain | Sweden | The Netherlands | United Arab Emirates | United Kingdom | United States



## Free Manuals Download Website

<http://myh66.com>

<http://usermanuals.us>

<http://www.somanuals.com>

<http://www.4manuals.cc>

<http://www.manual-lib.com>

<http://www.404manual.com>

<http://www.luxmanual.com>

<http://aubethermostatmanual.com>

Golf course search by state

<http://golfingnear.com>

Email search by domain

<http://emailbydomain.com>

Auto manuals search

<http://auto.somanuals.com>

TV manuals search

<http://tv.somanuals.com>