



# DX7100 Series Digital Video Recorder



C641M (11/03)

# CONTENTS

<u>Section</u>	<u>Page</u>
IMPORTANT SAFEGUARDS AND WARNINGS .....	3
WELCOME .....	4
MODELS .....	4
MOUNTING .....	5
FLAT SURFACE MOUNTING .....	5
EQUIPMENT RACK MOUNTING .....	5
BACK PANEL LAYOUT .....	6
BASIC INSTALLATION .....	7
EXTENDED INSTALLATION .....	8
SPECIFICATIONS .....	10
REGULATORY NOTICES .....	11
WARRANTY AND RETURN INFORMATION .....	11

## LIST OF ILLUSTRATIONS

<u>Figure</u>	<u>Page</u>
1 Rack Ear Installation .....	5
2 Back Panel Layout .....	6
3 Basic Equipment Installation .....	7
4 Extended Equipment Installation .....	8
5 PTZ Installation .....	8
6 Bottom View of the RS-422 Converter .....	9

## IMPORTANT SAFEGUARDS AND WARNINGS

Prior to installation and use of this product, the following WARNINGS should be observed.

1. Installation and servicing should be done only by qualified service personnel and conform to all local codes.
2. Unless the unit is specifically marked as a NEMA Type 3, 3R, 3S, 4, 4X, 6, or 6P enclosure, it is designed for indoor use only and it must not be installed where exposed to rain and moisture.
3. Only use replacement parts recommended by Pelco.
4. After replacement/repair of this unit's electrical components, conduct a resistance measurement between line and exposed parts to verify the exposed parts have not been connected to line circuitry.
5. For USA and Canada, use only a UL-listed, CSA-labeled detachable power cord, 3-conductor, 18 AWG, SVT or SJT type, round type plug, parallel blade, cord connector body IEC 320 style to mate with inlet on product.
6. To reduce the risk of fire, use only No. 2 AWG or larger telecommunications line cord.

---

**IMPORTANT:** The only way to disconnect power completely is to unplug the power cord. Make sure at least one end of the power cord is within easy reach so that the unit can be unplugged when required.

**CAUTION:** DANGER OF EXPLOSION IF BATTERY IS INCORRECTLY REPLACED. REPLACE ONLY WITH THE SAME OR EQUIVALENT TYPE RECOMMENDED BY THE MANUFACTURER. DISCARD USED BATTERIES ACCORDING TO THE MANUFACTURER'S INSTRUCTIONS.

---

The product and/or manual may bear the following marks:



This symbol indicates that dangerous voltage constituting a risk of electric shock is present within this unit.



This symbol indicates that there are important operating and maintenance instructions in the literature accompanying this unit.

**CAUTION:**

RISK OF ELECTRIC SHOCK.  
DO NOT OPEN.

Please thoroughly familiarize yourself with the information in this manual prior to installation and operation.

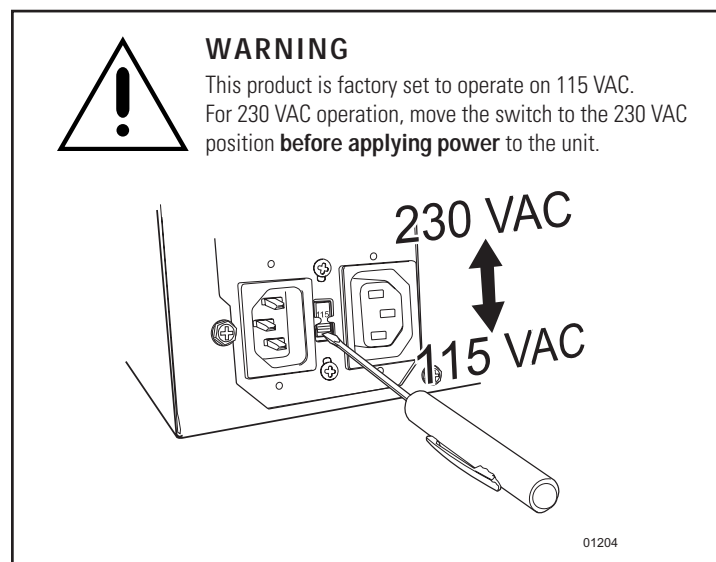

## WELCOME

Thank you for purchasing Pelco's DX7100 Series, high-quality digital video recorder (DVR). Your new system combines the functions of a recorder and multiplexer into a product with versatile recording and playback functions.

The following equipment is supplied with the DX7100 Series DVR:

Qty	Description
1	Keyboard
1	Mouse
1	RS-422 communication converter, including power adapter
1	9-pin to 25-pin adapter
2	Power cables (1 USA standard and 1 European standard)
2	Keys for front panel
1	Windows® 2000 CD
1	DX7100 Remote Site Software CD
6	10-32 x 5/8-inch black screws and washers
2	Rack mount ears
2	Handles
4	Flat head screws, 3/8-inch
4	Rubber feet
1	Installation manual
1	Operation/Programming manual
1	Software license agreement

---

**NOTE:** An uninterruptible power supply (UPS) is not supplied with the DVR. If required, use a device with the following specifications:

- Capacity – 350 VA, 210 watts
  - Output voltage – 115V ± 8% (on battery)
  - Frequency range – 47 Hz to 63 Hz
- 

## MODELS

DX7108-120	Eight-channel digital video recorder, 120 GB hard drive space
DX7108-240	Eight-channel digital video recorder, 240 GB hard drive space
DX7108-360	Eight-channel digital video recorder, 360 GB hard drive space
DX7108-480	Eight-channel digital video recorder, 480 GB hard drive space
DX7116-120	Sixteen-channel digital video recorder, 120 GB hard drive space
DX7116-240	Sixteen-channel digital video recorder, 240 GB hard drive space
DX7116-360	Sixteen-channel digital video recorder, 360 GB hard drive space
DX7116-480	Sixteen-channel digital video recorder, 480 GB hard drive space

## MOUNTING

The DX7100 may be placed on a flat surface, such as a shelf, or it can be installed in a 19-inch (48.26 cm) equipment rack.

### FLAT SURFACE MOUNTING

Before placing the unit on a flat surface, attach the rubber feet (supplied) to the bottom of the DVR. The unit may scratch the surface if the rubber feet are not installed.

### EQUIPMENT RACK MOUNTING

To install the unit in an equipment rack:

1. Attach the handles to the rack ears using the four flat head screws provided. Refer to Figure 1.
2. Remove the top screw and bottom screw from the left and right side of the DVR. Remove the side plates. Refer to Figure 1.
3. Use the screws removed from the sides of the DVR and attach the rack ears to the unit. Refer to Figure 1.
4. Use four of the supplied 10-32 x .75-inch black screws and finishing washers and mount the assembly to a 19-inch (48.26 cm) rack or console. Installation of the assembly may require two persons. One rack unit (1.75 inches or 4.45 cm) of spacing between units is recommended.

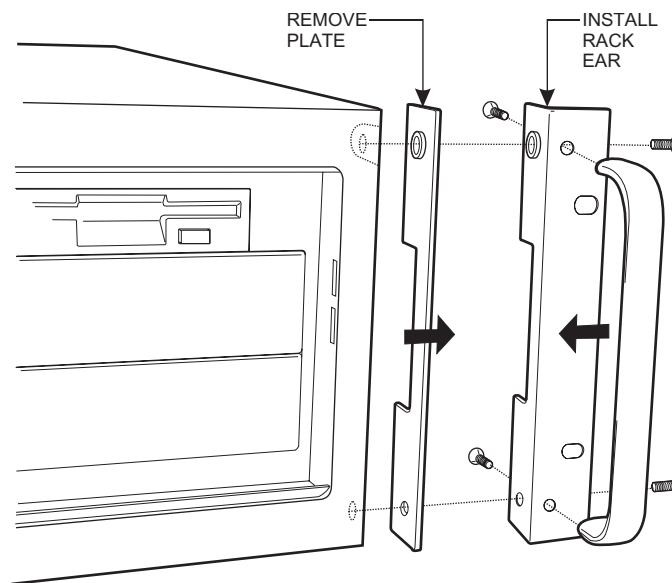

Figure 1. Rack Ear Installation

---

**IMPORTANT:** Slots and openings in the cabinet provide ventilation and prevent it from overheating. Do not block these openings. Never place the DVR near or over a radiator or heat register. Do not place it in a built-in installation, such as a rack, unless proper ventilation is provided or Pelco's instructions have been followed.

---

## BACK PANEL LAYOUT

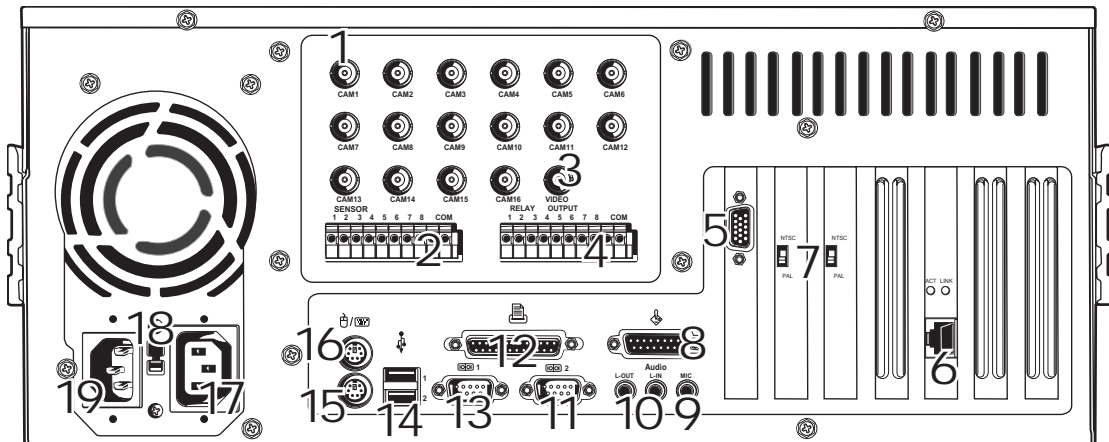

Figure 2. Back Panel Layout (DX7116 Model Shown)

- 1 Camera Inputs – 8 or 16 BNC camera inputs, depending on model
- 2 Alarm Inputs – 8 normally closed dry contact inputs
- 3 Analog Monitor Output – 1 BNC output (sequencing only)
- 4 Relay Outputs – 8 normally open dry contact outputs
- 5 SVGA Monitor Output – 15-pin output
- 6 Ethernet Adapter Port – 10/100 port
- 7 NTSC/PAL Selection Switches – 1 or 2, depending on model
- 8 Joystick Port (not used)
- 9 Microphone Jack (not used)
- 10 Audio In/Out (not used)
- 11 COM 2 Serial Port – 9-pin port
- 12 LPT1 Printer Port – 25-pin port
- 13 COM 1 Serial Port – 9-pin port
- 14 USB Ports – For Pelco-supported devices only
- 15 Keyboard (PS/2) Input
- 16 Mouse (PS/2) Input
- 17 AC Power Output
- 18 Power Voltage Selection Switch – This product is set at the factory to operate on 115 VAC. For 230 VAC operation, move the switch to the 230 VAC position **before applying power** to the unit.
- 19 AC Power Input – Please see *Important Safeguards and Warnings*.

# BASIC INSTALLATION

Basic installation covers all the equipment necessary to program and operate the system. Refer to the *Extended Installation* section for PTZ, alarm, sensors, and network connections.

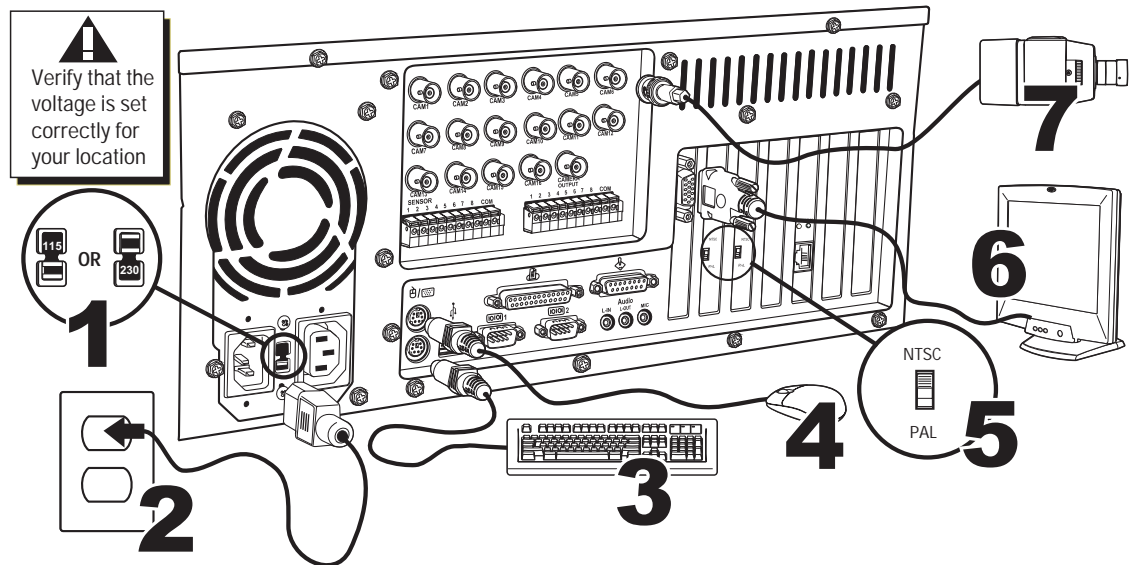

Figure 3. Basic Equipment Installation

- 1 Set the Voltage Selection Switch - Verify that the voltage selection switch is set correctly for your location. This product is set at the factory to operate on 115 VAC. For 230 VAC operation, move the switch to the 230 VAC position **before applying power** to the unit.
- 2 Connect the power cord to the AC input located on the back panel. Plug the other end of the power cord into an AC outlet.
- 3 Connect the keyboard to the bottom PS/2 input.
- 4 Connect the mouse to the top PS/2 input.
- 5 Set the NTSC/PAL switch (DX7108 models) or switches (DX7116 models) to the correct camera setting for your location.
- 6 Connect the SVGA monitor (not supplied).
- 7 Connect the cameras. Refer to the following table for video coaxial cable requirements:

Video Coaxial Cable Requirements

Cable Type*	Maximum Distance
RG59/U	750 ft (229 m)
RG6/U	1,000 ft (305 m)
RG11/U	1,500 ft (457 m)

\* Minimum cable requirements:  
 75 ohms impedance  
 All-copper center conductor  
 All-copper braided shield with 95% braid coverage

## EXTENDED INSTALLATION

Extended installation covers installation of accessories for the DX7100. Refer to the *Basic Installation* section to install the basic equipment necessary to program and operate the system.

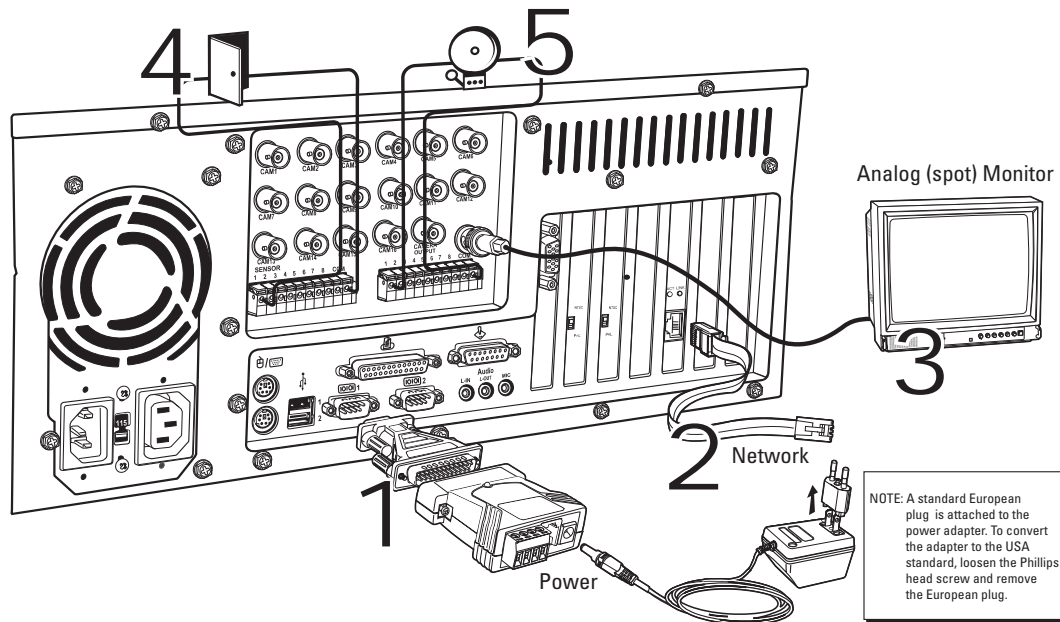

Figure 4. Extended Equipment Installation

### 1 PTZ (RS-422 Converter)

To control receivers with pan/tilt and zoom functions, such as Pelco's Esprit® and Spectra® systems, you must install the RS-422 communication converter. The DX7100 DVR cannot operate PTZ receivers if the RS-422 converter is not installed and the PTZ receiver address is not set to accept D protocol control. For information on setting the receiver address for D-type control, refer to the documentation supplied with the PTZ receiver.

Do the following to install the RS-422 converter:

- Connect the control wires from the receiver to the RS-422 converter (refer to Figure 5). The DX7100 can support up to 16 PTZ devices, at a maximum of 4,000 feet (1,219 m).
- Set the DTE/DCE switch located on the bottom of the converter to DCE (refer to Figure 6).
- Plug the RS-422 converter into the 9-pin to 25-pin adapter.
- Plug the pin converter into the COM 1 Port.
- Attach the power adapter to the RS-422 converter.
- Plug power adapter into a power source.

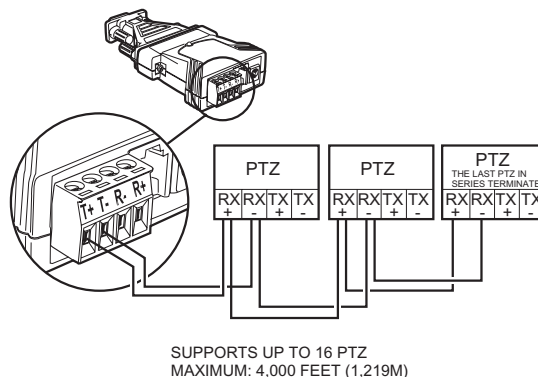

**NOTE:** The DX7100 may be connected to Pelco's CM9760-CXT-A for Coaxitron® control. Refer to the manual for the CM9760-CXT-A for installation instructions.

Figure 5. PTZ Installation



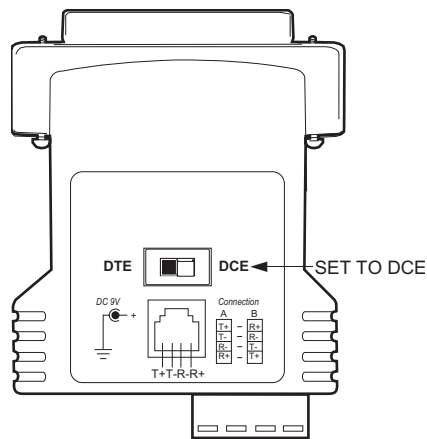

Figure 6. Bottom View of the RS-422 Converter

## 2 TCP/IP Access

Consult your network administrator to avoid possible network conflicts. For TCP/IP access, connect the DX7100 to a 10/100 Ethernet network. Use a standard UTP Cat5 cable with RJ-45 connectors. Plug the cable into the LAN port located on the back of the unit. Use a router with multicasting when connecting to a WAN network.

## 3 Analog Spot Monitor (Sequencing Only)

You can connect an analog monitor to the DX7100. This monitor is for viewing purposes only. Programming menus and bars are not displayed on the screen. All enabled cameras are displayed on the monitor in a sequential order.

Connect the analog spot monitor to the output labeled VIDEO OUTPUT.

## 4 Sensor (Alarm) Inputs

The DX7100 has eight normally closed dry contact sensor inputs. Sensor inputs require an open circuit contact, such as a switch or relay, to trigger an alarm.

To wire a sensor input:

- Connect one wire from the source device (for example, a door) to one of the sensor input terminals 1 through 8.
- Connect a second wire from the source device to the COM terminal.

## 5 Relay Outputs (Maximum Power Rating 125 VAC, 0.5 A; 30VDC, 1 A)

The DX7100 has eight normally open dry contact relay outputs. A signal from a output will operate the device connected to the output.

To wire a relay output:

- Connect one wire from the device (for example, an alarm) to one of the relay output terminals 1 through 8.
- Connect a second wire from the relay device to the COM terminal.

---

**NOTE:** The sensor input does not have to correspond numerically to the relay output. All sensor input and relay output actions are linked through programming. Refer to the Operation/Programming manual for details.

---

Refer to the Operation/Programming manual for instructions on how to set up and operate the DX7100 DVR.

# SPECIFICATIONS

## ELECTRICAL/VIDEO

Input Voltage:	100-240 VAC switchable, 50/60 Hz
Power:	210 watts
Signal System:	NTSC/PAL
CPU and RAM	
DX7008:	Celeron®, 256 MB
DX7016:	Pentium® III, 256 MB
Resolution	
NTSC:	320 x 240
PAL:	384 x 288
Compression:	M-JPEG
Video Inputs:	8 or 16, depending on model
Video Outputs:	2 (1 SVGA, 1 analog)
Alarm Inputs:	8
Control Outputs:	8
Remote Control:	Full remote control via PSTN, ISDN, TCP/IP
Pan/Tilt/Zoom Control:	RS-422 interface to receivers

## MECHANICAL

CD-RW (Internal)	
Data Transfer Rate:	Write: 52X (7.8 MB/sec) Rewrite: 24X (3.6 MB/sec) Read: 52X maximum (7.2 MB/sec) 32X maximum (6 MB/sec)
Video Playback:	
Connectors	
BNC:	Video inputs and analog monitor
6-pin mini-DIN	PS/2 mouse and keyboard
Push-in	Alarm inputs, control outputs
9-pin D-type	COM 1 and 2
15-pin D-type	SVGA monitor port
25-pin D-type	Printer port
RJ-45	TCP/IP, LAN/WAN
USB	Two ports available for external backup device

## GENERAL

Operating Temperature:	50° to 95°F (10° to 35°C)
Relative Humidity:	Maximum 80%, non-condensing
Dimensions:	7 (H) x 17 (W) x 18 (D) inches (17.78 x 43.18 x 45.72 cm)

Unit Weight (Approximate)	<u>Unit</u>	<u>Shipping</u>
DX7108-120, DX7116-120	39.2 lb (17.8 kg)	50 lb (22.7 kg)
DX7108-240, DX7116-240	43.2 lb (19.6 kg)	54 lb (24.4 kg)
DX7108-360, DX7116-360	47.2 lb (21.4 kg)	58 lb (26.3 kg)
DX7108-480, DX7116-480	51.2 lb (23.2 kg)	62 lb (28.1 kg)

*(Design and product specifications subject to change without notice.)*

# REGULATORY NOTICES

This device complies with part 15 of the FCC Rules. Operation is subject to the following two conditions: (1) this device may not cause harmful interference, and (2) this device must accept any interference received, including interference that may cause undesired operation.

## RADIO AND TELEVISION INTERFERENCE

This equipment has been tested and found to comply with the limits of a Class B digital device, pursuant to part 15 of the FCC rules. These limits are designed to provide reasonable protection against harmful interference in a residential installation. This equipment generates, uses, and can radiate radio frequency energy and, if not installed and used in accordance with the instructions, may cause harmful interference to radio communications. However there is no guarantee that the interference will not occur in a particular installation. If this equipment does cause harmful interference to radio or television reception, which can be determined by turning the equipment off and on, the user is encouraged to try to correct the interference by one or more of the following measures:

- Reorient or relocate the receiving antenna.
- Increase the separation between the equipment and the receiver.
- Connect the equipment into an outlet on a circuit different from that to which the receiver is connected.
- Consult the dealer or an experienced radio/TV technician for help.

You may also find helpful the following booklet, prepared by the FCC: "How to Identify and Resolve Radio-TV Interference Problems." This booklet is available from the U.S. Government Printing Office, Washington D.C. 20402.

Changes and Modifications not expressly approved by the manufacturer or registrant of this equipment can void your authority to operate this equipment under Federal Communications Commission's rules.

### WARRANTY AND RETURN INFORMATION

**WARRANTY**  
Pelco will repair or replace, without charge, any merchandise proved defective in material or workmanship for a period of one year after the date of shipment. Exceptions to this warranty are as noted below:

- Five years on Pelco manufactured cameras (CC3500/CC3600/CC3700 and MC3500/MC3600 Series); two years on all other cameras.
- Three years on Genex® Series (multiplexers, server, and keyboard) and 090 Series Camclosure® Camera System.
- Two years on 100/150, 200 and 300 Series Camclosure® Camera Systems.
- Two years on cameras and all standard motorized or fixed focal length lenses.
- Two years on Legacy®, CM6700/CM6800/CM6800E/CM8500/CM9500/CM9740/CM9760 Matrix, DF5 and DF8 Series Fixed Dome products.
- Two years on Spectra®, Esprit®, and PS20 Scanners, including when used in continuous motion applications.
- Two years on Esprit and VW5700 series window wiper (excluding wiper blades).
- Eighteen months on DX Series digital video recorders.
- One year (except video heads) on video cassette recorders (VCRs). Video heads will be covered for a period of six months.
- Six months on all pan and tilts, scanners or preset lenses used in continuous motion applications (that is, preset scan, tour and auto scan modes).

Pelco will warrant all replacement parts and repairs for 90 days from the date of Pelco shipment. All goods requiring warranty repair shall be sent freight prepaid to Pelco, Clovis, California. Repairs made necessary by reason of misuse, alteration, normal wear, or accident are not covered under this warranty.

Pelco assumes no risk and shall be subject to no liability for damages or loss resulting from the specific use or application made of the Products. Pelco's liability for any claim, whether based on breach of contract, negligence, infringement of any rights of any party or product liability, relating to the Products shall not exceed the price paid by the Dealer to Pelco for such Products. In no event will Pelco be liable for any special, incidental or consequential damages (including loss of use, loss of profit and claims of third parties) however caused, whether by the negligence of Pelco or otherwise.

The above warranty provides the Dealer with specific legal rights. The Dealer may also have additional rights, which are subject to variation from state to state.

If a warranty repair is required, the Dealer must contact Pelco at (800) 289-9100 or (559) 292-1981 to obtain a Repair Authorization number (RA), and provide the following information:

1. Model and serial number
2. Date of shipment, P.O. number, Sales Order number, or Pelco invoice number
3. Details of the defect or problem

If there is a dispute regarding the warranty of a product which does not fall under the warranty conditions stated above, please include a written explanation with the product when returned.

Method of return shipment shall be the same or equal to the method by which the item was received by Pelco.

**RETURNS**  
In order to expedite parts returned to the factory for repair or credit, please call the factory at (800) 289-9100 or (559) 292-1981 to obtain an authorization number (CA number if returned for credit, and RA number if returned for repair).

All merchandise returned for credit may be subject to a 20% restocking and refurbishing charge.

Goods returned for repair or credit should be clearly identified with the assigned CA or RA number and freight should be prepaid. Ship to the appropriate address below.

*If you are located within the continental U.S., Alaska, Hawaii or Puerto Rico:*  
Service Department  
Pelco  
3500 Pelco Way  
Clovis, CA 93612-5699

*If you are located outside the continental U.S., Alaska, Hawaii or Puerto Rico:*  
**Intermediate Consignee**  
American Overseas Air Freight  
320 Beach Road  
Burlingame, CA 94010  
USA

**Ultimate Consignee**  
Pelco  
3500 Pelco Way  
Clovis, CA 93612-5699  
USA

## REVISION HISTORY

Manual #	Date	Comments
C641M	11/03	Original version.

® Pelco, the Pelco logo, Spectra, Genex, Esprit, Camclosure, Legacy, and Coaxitron are registered trademarks of Pelco.

® Windows is a registered trademark of Microsoft Corporation.

® Pentium and Celeron are registered trademarks of Intel Corporation.

© Copyright 2003, Pelco.  
All rights reserved.



World Headquarters  
3500 Pelco Way  
Clovis, California 93612 USA

USA & Canada  
Tel: 800/289-9100  
Fax: 800/289-9150

International  
Tel: 1-559/292-1981  
Fax: 1-559/348-1120

[www.pelco.com](http://www.pelco.com)

ISO9001

Orangeburg, New York | Las Vegas, Nevada | Eindhoven, The Netherlands | Wokingham, United Kingdom | Montreal, Canada  
Singapore

## Free Manuals Download Website

<http://myh66.com>

<http://usermanuals.us>

<http://www.somanuals.com>

<http://www.4manuals.cc>

<http://www.manual-lib.com>

<http://www.404manual.com>

<http://www.luxmanual.com>

<http://aubethermostatmanual.com>

Golf course search by state

<http://golfingnear.com>

Email search by domain

<http://emailbydomain.com>

Auto manuals search

<http://auto.somanuals.com>

TV manuals search

<http://tv.somanuals.com>