

# C a u t i o n

**Remove  
this page  
and keep  
it in a  
secure  
place.**



C681M- A- LB ( 9/01)

3500 Pelco Way  
Clovis, CA 93612 USA

North America and Canada  
Tel 800/289-9100  
FAX 800/289-9150  
DataFAX 800/289-9108

International  
Tel +1 559/292-1981  
FAX +1 559/348-1120  
DataFAX +1 559/292-0435

PelcoEurope BV  
Tel +31 40/251-9870  
FAX +31 40/251-9835

[www.pelco.com](http://www.pelco.com)

The DX3000 Series DVR has an unmarked lock button to restrict unauthorized use of the recorder. The lock button will work only as long as no one discovers its function. Since you may need to make the manual accessible to others, the lock button's location and operation are NOT documented in the manual – this is the only place it is shown.

If you want to keep this page in the manual, just staple it inside the cover.

The lock button is located on the front panel below the PRE ALARM REC light.

## SIMPLE LOCK

When the LOCK button is pressed (with a ball-point pen, for example), the front panel controls are disabled except for the CAMERA, SPLIT/SEQUENCE, and ZOOM buttons. The LOCK indicator light illuminates when the unit is in the Lock mode. Press the LOCK button again to exit the Lock mode.

The simple lock function does not work if a password has been entered into the recorder (refer to *Password Lock*).

## PASSWORD LOCK

Pressing the LOCK button on the front of the unit lets you record a password. Once the password has been entered and the unit has been locked, the front panel controls are disabled except for the CAMERA, SPLIT/SEQUENCE, and ZOOM buttons.

### Entering Initial Password

1. Press the LOCK button for five seconds. The Password Setting menu appears.
2. Enter a four-digit password. The password may consist of the numbers 0-9. 1-9 are assigned to the camera buttons on the front of the unit. 0 is assigned to the ZOOM key.
3. Turn the SHUTTLE ring to the right to enter the password.
4. Re-enter the password, and then turn the SHUTTLE ring to the right. The password is now set, and the normal operating screen appears.

If the wrong password is entered, "PASSWORD ERROR" appears on the screen, and the password is cleared. Turn the SHUTTLE ring to the left to exit the menu. Press the LOCK button to turn off the indicator light. Return to step 1.

### Changing Password

1. Turn the Password Lock feature OFF (refer to *Turning Password Lock On and Off*).
2. Press the LOCK button for five seconds. The Password Lock menu appears.
3. Enter the current password, and then turn the SHUTTLE ring to the right. The Password Setting menu appears.
4. Using the same procedure for setting the original password, enter and set the new password.

### Password Error

If you are asked to enter a password and you enter the wrong one, press the WARNING RESET button to clear the incorrect password.

### Turning Password Lock On and Off

OFF: To disable the Password Lock feature, press the LOCK button, enter the password, and turn the SHUTTLE ring to the right.

ON: To return to locked status, press the LOCK button again.

### Erasing the Password

If you no longer need a password, or if you forget your password, the current password can be erased.

1. Press and hold the INFO and SET UP buttons on the front of the recorder. Press the RESET button on the back of the unit, and then release the INFO and SET UP buttons. The unit begins a self-test.
2. When the self-test is complete, press the RESET button again. The unit turns itself off.
3. Turn on the power.
4. Reset the time and date.

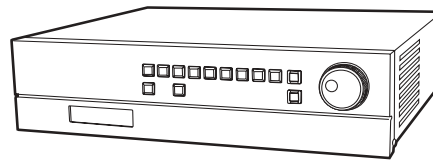

DX3000 Series  
Digital Recorder

Installation/  
Operation Manual

C681M-D (2/02)



Pelco • 3500 Pelco Way • Clovis, CA 93612-5699 USA • Pelco Online @ [www.pelco.com](http://www.pelco.com)  
In North America and Canada: Tel (800) 289-9100 • FAX (800) 289-9150 • DataFAX (800) 289-9108  
International Customers: Tel +1(559) 292-1981 • FAX +1(559) 348-1120 • DataFAX +1(559) 292-0435  
PelcoEurope BV • Dillenburg Center, Dillenburgstraat 7C • 5652 AM Eindhoven • The Netherlands  
Tel +31(40) 251-9870 • FAX +31(40) 251-9835

# CONTENTS

<u>Section</u>	<u>Page</u>
IMPORTANT SAFEGUARDS AND WARNINGS .....	5
OVERVIEW .....	6
DESCRIPTION .....	6
MODELS .....	7
FRONT PANEL CONTROLS .....	7
REAR PANEL CONNECTORS .....	10
INSTALLATION .....	12
ADDING OR REMOVING A COPY OR ARCHIVE DEVICE .....	16
ADDING A HARD DRIVE(S) .....	16
REMOVING A HARD DRIVE(S) .....	17
CONFIRMING THAT A DEVICE IS CONNECTED .....	17
BOOT-UP DELAY .....	17
PROGRAMMING .....	18
ALARMS .....	22
IMAGE QUALITY .....	22
MAXIMUM RECORDING FIELDS .....	22
DEFINE GROUP SETTING .....	23
ALARM RECORDING DURATION .....	24
RECORD ALARM .....	24
PRE-ALARM RECORDING .....	25
M-DET SETTING .....	26
ARCHIVE POINTER RESET .....	26
ARCHIVE .....	26
DATA .....	26
OVERWRITE .....	27
AUDIO RECORDING .....	28
AUTO EJECT .....	28
BUZZER .....	29
CALL OUT .....	30
CAPACITY REMAINING .....	30
DATA CLEAR (ERASE) SELECTION .....	31
FIFO/OVERWRITE MODE (DX3016 Models Only) .....	32
BACKUP FOLLOWING A POWER FAILURE .....	32
HARD DISK DRIVE (HDD) FULL .....	33
HARD DISK DRIVE (HDD) REPEAT PLAYBACK .....	34
IM-CHECK MODE .....	34
INITIALIZE MENUS .....	35
MODE OUT .....	35
MOTION DETECTION .....	36
MULTIPLEXER DISPLAY .....	38
SPLIT SCREEN SETTING (DX3009 Models Only) .....	38
Nine-Camera (Split 9) Setting .....	38
Four-Camera (Split 4) Setting .....	39
SCREEN SWITCH PATTERN (DX3016 Models Only) .....	39
SPLIT 4 SCREEN SETTING (DX3016 Models Only) .....	40
SPLIT 9 SCREEN SETTING (DX3016 Models Only) .....	40
SPLIT 16 SCREEN SETTING (DX3016 Models Only) .....	41
IMAGE QUALITY .....	41
SEQUENCE .....	42
CHANNEL TITLE (Displaying Camera Title and/or Number) .....	42
ALARM DISPLAY .....	43
CAMERA TITLE .....	44
POWER FAILURE .....	44
RECORD .....	44
IMAGE QUALITY .....	44
MAXIMUM RECORDING FIELDS .....	45
SELECT RECORDING MODE .....	46
DEFINE GROUP .....	46
RS-232C COMMUNICATION .....	47
SAVING MENU SETTINGS .....	48
SAVING MENU DATA .....	48
RESTORING MENU DATA .....	48

TCP/IP SETTING (DX3016 Models Only) .....	49
TIME AND DATE DISPLAY .....	49
DISPLAY MODE .....	49
CHARACTER SIZE .....	50
CLOCK LOCATION .....	51
TIME AND DATE SETTING .....	51
TIMER RECORDING .....	52
MOTION DETECTION DURING A TIMER RECORDING (DX3016 Models Only) .....	55
ESTIMATING RECORDING TIME .....	56
OPERATION .....	57
VIEWING CAMERAS .....	58
SPLIT/SEQUENCE BUTTON .....	58
ZOOM BUTTONS .....	59
REMOTE VIEWING .....	59
RECORDING .....	59
BASIC RECORDING .....	59
ALARM RECORDING .....	60
TIMER RECORDING .....	61
PLAYBACK .....	61
BASIC PLAYBACK .....	61
FRAME-BY-FRAME (STILL FRAME) PLAYBACK .....	62
PAUSE PLAYBACK .....	62
REVERSE PLAYBACK .....	62
ADJUSTING PLAYBACK SPEED .....	62
Regular Playback Mode .....	62
Still-Frame Playback Mode .....	63
Shuttle Hold .....	63
CHANGING PLAYBACK INTERVAL .....	63
FAST FORWARD/REWIND .....	63
SEARCHING .....	63
Time and Date Search .....	63
Index Search .....	64
Skip Search .....	65
Alarm List Search .....	66
Jump to Starting Point .....	66
PLAYBACK ON ANOTHER DEVICE .....	67
BACKING UP DATA .....	67
USING THE ARCHIVE BUTTON .....	67
Start Copying .....	67
Stop Copying .....	67
Timer Backup .....	67
Auto-Eject at the Completion of Backup .....	68
USING THE COPY BUTTON .....	68
Still-Frame Playback Copy Mode .....	69
SIMULTANEOUS RECORDING AND BACKUP .....	69
RESTORING DATA FROM A BACKUP DEVICE .....	70
INFORMATION .....	71
ELAPSED TIME DISPLAY .....	71
POWER FAILURE LIST .....	71
RECORDED PERIOD .....	72
SCSI DEVICE(S) CONNECTED .....	72
POWER FAILURE .....	72
RESET .....	72
DX3009 RECORDING TIME TABLES .....	73
DX3016 RECORDING TIME TABLES .....	76
WARNINGS .....	79
TROUBLESHOOTING .....	80
SPECIFICATIONS .....	82
WARRANTY AND RETURN INFORMATION .....	84
REGULATORY NOTICES .....	84

## LIST OF ILLUSTRATIONS

<u>Figure</u>		<u>Page</u>
1	Front Panel Controls, DX3009 Models .....	7
2	Front Panel Controls, DX3016 Models .....	7
3	Rear Panel Connectors, DX3009 Models .....	10
4	Rear Panel Connector, DX3016 Models .....	10
5	Equipment Connections (DX3009 Model Shown) .....	12
6	Alarm Input and Output Connections .....	12
7	Schematics for Alarm Input and Output Terminals .....	13
8	Operation of Power On and Power Off Terminals .....	13
9	Schematic for Power On and Power Off Terminals .....	13
10	Schematics for Input and Output Terminals .....	14
11	Connecting Recorders in Series .....	14
12	Connecting Peripheral Recording Devices (DX3009 Models Shown) .....	15
13	Menu Tree, DX3009 Models .....	18
14	Menu Tree, DX3016 Models .....	20

## IMPORTANT SAFEGUARDS AND WARNINGS

Prior to installation and use of this product, the following WARNINGS should be observed.

1. Installation and servicing should only be done by qualified service personnel and conform to all local codes.
2. Unless the unit is specifically marked as a NEMA Type 3, 3R, 3S, 4, 4X, 6 or 6P enclosure, it is designed for indoor use only and it must not be installed where exposed to rain and moisture.
3. The installation method and materials should be capable of supporting four times the weight of the unit and equipment.

The product and/or manual may bear the following marks:



This symbol indicates that dangerous voltage constituting a risk of electric shock is present within this unit.



This symbol indicates that there are important operating and maintenance instructions in the literature accompanying this unit.

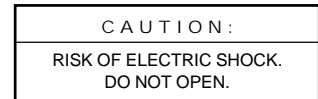

Please thoroughly familiarize yourself with the information in this manual prior to installation and operation.

# OVERVIEW

## DESCRIPTION

The DX3000 Series Digital Video Recorder (DVR) is a high-quality digital recorder that combines the functions of a recorder and multiplexer into one unit.

With the number of cameras in systems increasing, the combination of a video recorder with a multiplexer has become standard. In pursuit of the high-quality image playback characteristic of digital recording and as a way to make the recording operation more ideal, the DX3000 Series DVR includes versatile multiplexer functions that allow the images from the camera inputs to be shown on the monitor in multiple formats: 1-, 4-, or 9-camera displays on the DX3009 models or 1-, 4-, 9-, or 16-camera displays on the DX3016 models.

The DX3000 Series DVR uses JPEG compression to produce high-resolution playback with more than 450 horizontal lines. There are five user-selectable image quality settings. The DVR has a built-in, large-volume hard disk for both high reliability and high-speed operation. Users can select from six (DX3009 models) or eight (DX3016 models) recording intervals ranging from 1-30 frames per second. The maximum number of frames that can be recorded consecutively is as follows:

MODEL	MAXIMUM FRAMES
DX3009-030	2,456,000
DX3009-060	4,913,000
DX3016-060	4,800,000
DX3016-120	9,601,000

Recording can be done continuously or at specified time periods. The user also can categorize cameras into three recording groups, allowing different recording patterns, for example, during weekdays and weekends.

Zoom buttons permit the user to zoom in on a selected area of the image.

There are two methods of detecting alarms. First, for each camera there is an alarm input that triggers alarm recording when a ground signal is received from the alarm device. A pre-alarm recording function can be set to record images before the alarm sensor detects disturbances. Second, each camera can be programmed to detect motion, including the capability to select the motion detection area and the sensitivity of motion detection.

Versatile high-speed search operations include time and date searching, index searching, skip searching, and alarm list searching.

To handle applications requiring long-term storage of recorded images, the DX3000 Series DVR is capable of using supplementary devices to create backups and copies without interrupting hard disk recording. Used in conjunction with a wide selection of media, DX3000 Series DVR can handle many different kinds of non-stop recording. Additional hard disk drives can be added to supplement the built-in hard disk when extended recording time is needed, as follows:

MODEL	MAXIMUM NUMBER OF ADDITIONAL HARD DRIVES
DX3009-030	3 (34 GB PER UNIT)
DX3009-060	2 (34 GB PER UNIT)
DX3016-060	2 (103 GB PER UNIT)
DX3016-120	2 (103 GB PER UNIT)

Other features include audio recording, recognition of recorded images that have been altered, and an RS-232C interface for remote control from a PC or other control terminals.

## MODELS

DX3009-030	Nine-channel digital video recorder, 30 GB hard drive, simplex operation (cannot record and play back video at the same time), 120/230 VAC, NTSC
DX3009-060	Same as the DX3009-030, except has 60 GB hard drive
DX3016-060	Sixteen-channel digital video recorder, 60 GB hard drive, simplex operation (cannot record and play back video at the same time), 120/230 VAC, NTSC
DX3016-120	Same as the DX3016-060, except has 120 GB hard drive

## FRONT PANEL CONTROLS

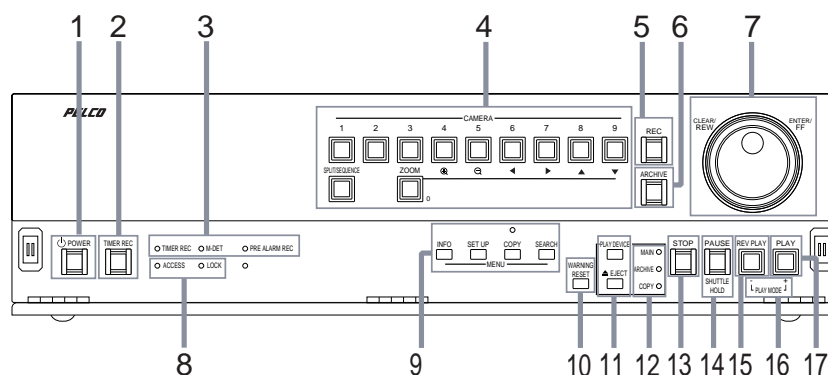

Figure 1. Front Panel Controls, DX3009 Models

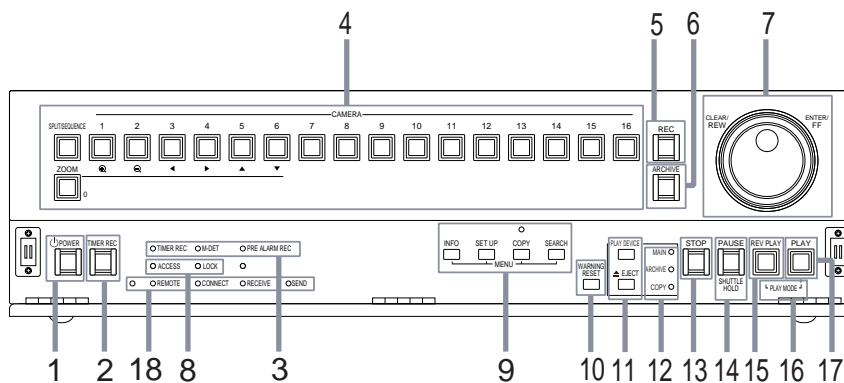

Figure 2. Front Panel Controls, DX3016 Models

1. **POWER** button  
Press this button to turn the power on; press again to turn the power off. This button lights/goes off when the power is on/off. It flashes when switching between functions, such as during setup. When the POWER button is flashing, the front panel buttons do not work.
2. **TIMER REC** button  
Press this button to activate the timer recording function. Press again to cancel the timer recording function. The light is on when timer recording is in progress.



### 3. Recording indicators

#### TIMER REC indicator

This light illuminates during timer recording and timer recording standby mode. The POWER button does not work when the TIMER REC indicator is lit. To turn on the power when the TIMER REC indicator is lit in the standby mode, press the TIMER REC button.

#### M-DET indicator

The light illuminates whenever the motion detection setting is ON in the Initial Set Up menu. When the setting is ON, the light goes out if you are in a programming menu.

#### PRE ALARM REC indicator

The light illuminates whenever SHORT, MEDIUM, or LONG is selected in the pre-alarm recording (PRE A-REC) field in the alarm recording and motion detection (A-Rec/M-Det Setting) menu.

### 4. Multiplexer buttons

#### Camera number buttons

Buttons 1-9 on DX3009 models

Buttons 1-16 on DX3016 models

Press the number of the camera you want to display on the monitor. In addition, these buttons are used to set the password in the Password Lock function.

#### SPLIT/SEQUENCE button

Press this button to switch between the single-camera, four-camera, and nine-camera displays on DX3009 models and between single-camera, four-camera, nine-camera, and sixteen-camera displays on DX3016 models. Also use to switch sequence functions.

#### ZOOM button

Press this button to display the Zoom Pointer (X) on the monitor. In addition, this button can be used as the number 0 to set the password in the Password Lock function.

#### ZOOM IN button

Button 4 on DX3009 models

Button 1 on DX3016 models

Pressing this button after pressing the ZOOM button enlarges the image in two steps.

#### ZOOM OUT button

Button 5 on DX3009 models

Button 2 on DX3016 models

Pressing this button after pressing the ZOOM IN button reduces the image.

#### Move buttons

Buttons 6-9 on DX3009 models

Buttons 3-6 on DX3016 models

Press these buttons to move the Zoom Pointer to the desired position.

### 5. REC button

Press this button to begin recording.

### 6. ARCHIVE button

Press this button to begin making a backup copy of the hard drive. If there is no peripheral recording device connected, this button cannot be used.

### 7. Jog and shuttle operation

#### SHUTTLE ring

Use the ring to set various menus and search functions, to adjust the playback speed, and to rewind or forward the image.

#### JOG dial

Use the dial to set various menus and search functions, and to forward or reverse the image during playback (field-by-field).

8. Mode indicators

ACCESS indicator

This light flashes when the hard disk drive or peripheral recording devices are being accessed.

LOCK indicator

This light illuminates when the LOCK button is set to ON.

9. Menu buttons

Press one of the buttons to display each menu. Press again to exit the menu.

INFO button

Press this button to display the Information menu.

SET UP button

Press this button to display the Menu Setting menu.

COPY button

Press this button to display the Copy Selection menu. This button works only if a peripheral device is connected to SCSI ID 4 and SCSI ID 5.

SEARCH button

Press this button to display the Search Selection menu.

COPY indicator

This indicator blinks during a copy or restore operation and illuminates during copying.

10. WARNING RESET button

Press this button to clear a warning displayed on the monitor.

This button also clears the "X" that appears on the monitor after a power failure.

11. PLAY DEVICE button

Press this button to select a playback device. If there is no peripheral recording device connected, this button cannot be selected.

EJECT button

Press this button to eject the medium in the playback device. If there is no peripheral recording device connected, this button cannot be used.

12. Play device indicators

The illuminated light indicates the device selected by the PLAY DEVICE button.

13. STOP button

Press this button to stop recording or playback. To stop a timer recording, press the TIMER REC button.

14. PAUSE button

When pressed during recording, the recording pauses. Press again to resume recording. When pressed during playback, a still picture is displayed.

SHUTTLE HOLD button

This button retains the selected playback or reverse playback speed.

15. REV PLAY button

Press this button to begin reverse playback.

16. PLAY MODE buttons

These buttons switch the playback interval while in still mode and playback.

17. PLAY button

Press this button to begin playback.

18. REMOTE communication button and indicator lights (DX3016 Models Only)  
Not used.

## REAR PANEL CONNECTORS

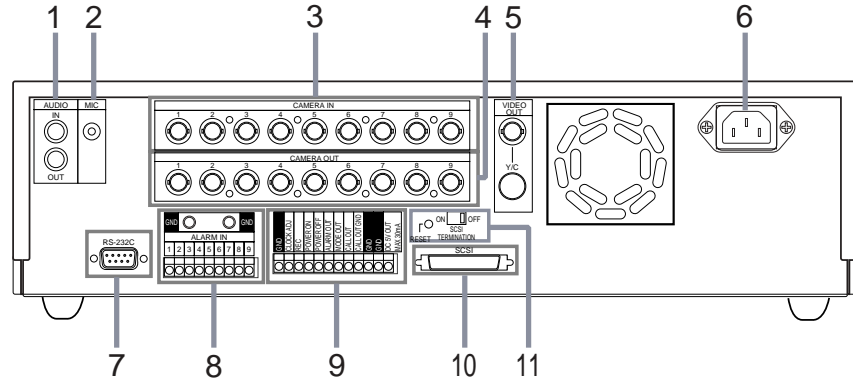

Figure 3. Rear Panel Connectors, DX3009 Models

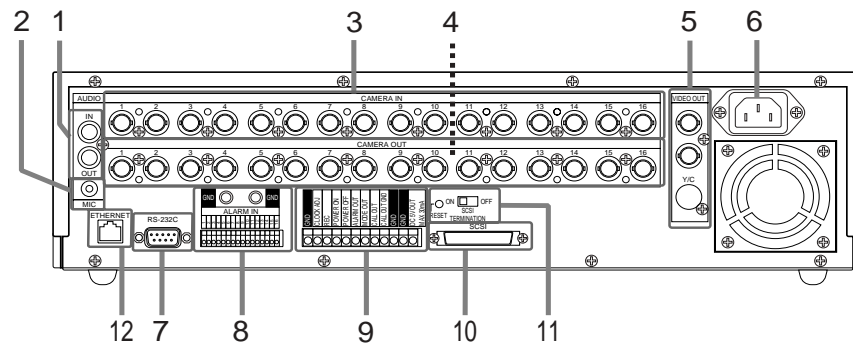

Figure 4. Rear Panel Connector, DX3016 Models

1. Audio connectors
  - AUDIO IN connector  
This is an RCA input connector for an audio signal.
  - AUDIO OUT connector  
This is an RCA output connector for an audio signal.
2. MIC jack  
This is an input connector for a microphone (600-ohm impedance).
3. CAMERA IN connectors  
These are BNC input connectors for cameras.
4. CAMERA OUT connectors  
These are BNC output (looping) connectors for cameras.
5. VIDEO OUT connectors  
There are two video output connectors: a BNC standard composite video output connector and an SVHS connector for separate luminance and chrominance (Y/C) signals. Both connectors can be used at the same time.

6. AC power socket  
This socket is for a 100-240 VAC power cord.
7. RS-232C connector  
This is where a PelcoNet™ Transmission System can be connected for remote viewing and control of cameras.
8. ALARM IN terminals  
These are input terminals for alarm signals.  
  
GND terminals  
These are earth ground terminals for the ALARM IN terminals. Use only the terminal screws provided with this unit; otherwise, the recorder could be damaged or connections may be poor.
9. I/O terminals  
  
GND terminals  
These are ground terminals for the input/output terminals.  
  
CLOCK ADJ terminal  
This is an input terminal to set the time display. The time display is adjusted to the nearest hour (00 minutes, 00 seconds) when this terminal receives the clock adjust signal.  
  
REC terminal  
This is an input terminal to start recording.  
  
POWER ON terminal  
This is an input terminal to turn on the recorder through a peripheral device.  
  
POWER OFF terminal  
This is an input terminal to turn off the recorder through a peripheral device.  
  
ALARM OUT terminal  
This is an output terminal to indicate that an alarm recording is being made.  
  
MODE OUT terminal  
This is an output terminal to indicate the recorder's current mode. Select the mode in the Rear Terminal menu.  
  
CALL OUT terminal / CALL OUT GND terminal  
This is an isolated (optically coupled) output to indicate information such as the hard disk drive is full. Refer to the *Warnings* section.  
  
DC 5V OUT terminal  
This terminal is for direct current voltage output. The maximum current is 30 mA.
10. SCSI connector  
This connector is for peripheral recording devices.
11. RESET button  
When pressed, the present time is erased, the system is reset, and the power is turned off.  
  
SCSI TERMINATION switch  
When set to ON, the termination function is enabled; when set to OFF, the termination function is disabled. Set the switch ON when nothing is connected to the SCSI connector.
12. Ethernet connector (DX3016 Models Only)  
Not used.

# INSTALLATION

1. Connect cameras, monitor, and audio equipment to the recorder as shown in Figure 5.

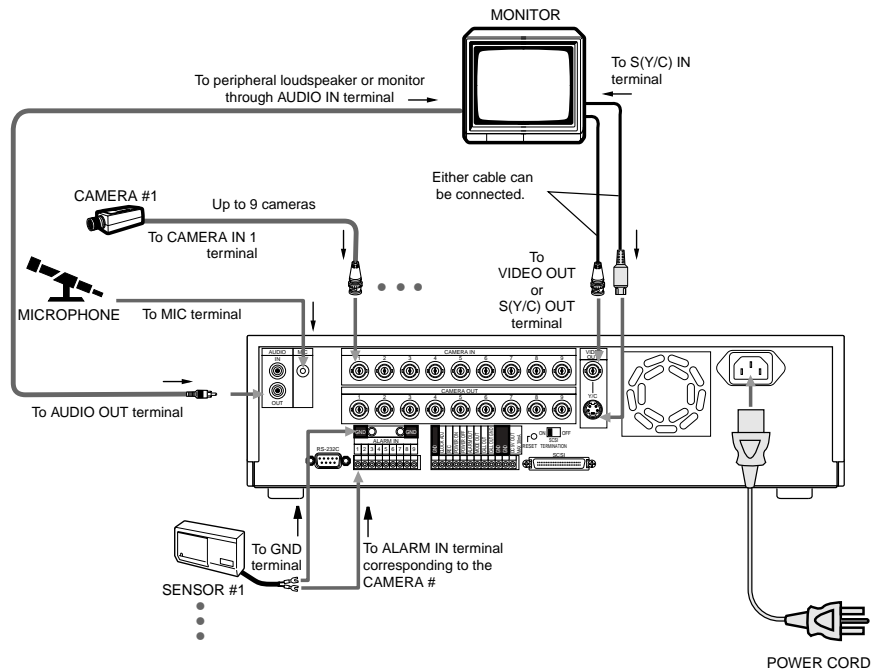
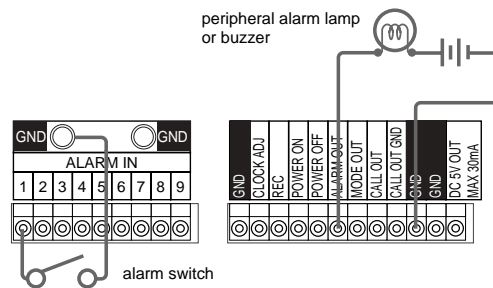

**Figure 5.** Equipment Connections (DX3009 Model Shown)

2. Connect alarm inputs and alarm output as shown in Figures 5 and 6. Figure 7 shows schematics for the alarm circuits.

An alarm input is active when a ground or low voltage signal is applied. An input is non-active when the terminal is open.

The alarm output is active when the terminal is at a low voltage level and non-active when the terminal is open. Maximum drive current is 7 mA DC, and the maximum voltage is +24 VDC.



**Figure 6.** Alarm Input and Output Connections

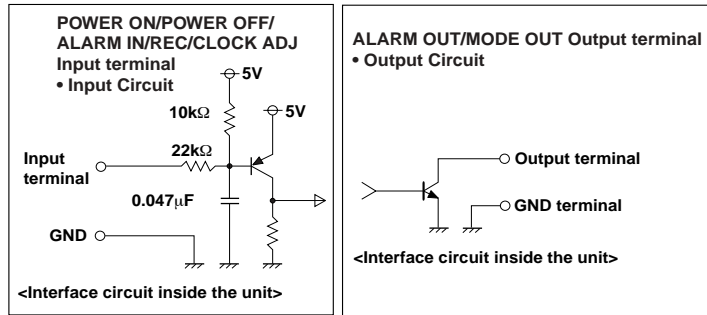

**Figure 7.** Schematics for Alarm Input and Output Terminals

- Optional. Connect the recorder to a remote source for turning the unit on/off.

By using the POWER ON/POWER OFF terminals, it is possible to turn on/off the recorder externally. The POWER ON terminal turns power on or off (refer to Figure 8). The POWER OFF terminal turns power off (refer to Figure 8). Turning the recorder on/off also controls the output of the DC 5V OUT terminal (refer to Figure 8). Figure 9 shows the schematic for the POWER ON/POWER OFF terminals.

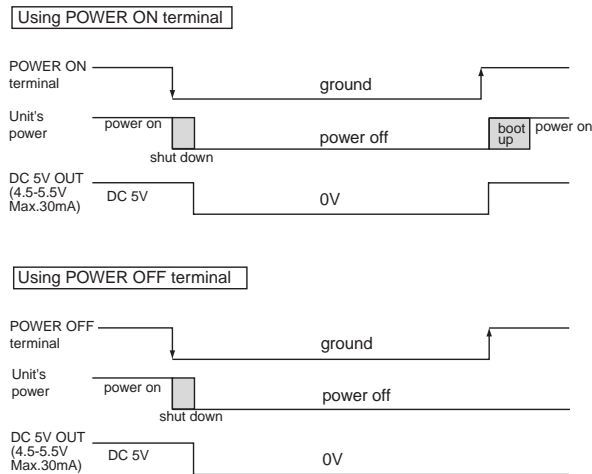

**Figure 8.** Operation of Power On and Power Off Terminals

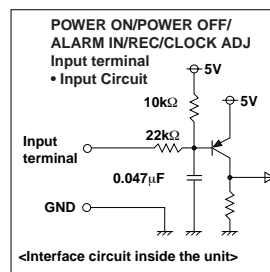

**Figure 9.** Schematic for Power On and Power Off Terminals

- Optional. Connect equipment to the CLOCK ADJ, REC, MODE OUT, and CALL OUT terminals. Refer to Figure 10 for schematics of the input/output terminals.

The CLOCK ADJ input terminal is used for adjusting the clock. The input is active when a ground or low voltage signal is applied. The input is non-active when the terminal is open.

The REC input terminal is used to start recording. Refer to *Series Recording* in this step for more information. The input is active when a ground or low voltage signal is applied. The input is non-active when the terminal is open.

The MODE OUT output terminal is used to indicate the status of the recorder (refer to *Mode Out* in the *Programming* section for more information). It can also be used to turn on another recorder (refer to *Series Recording* in this step for more information). The output is active when the terminal is at a low voltage level and non-active when the terminal is open. Maximum current drive is 7 mA DC, and the maximum voltage is +24 VDC.

The CALL OUT output terminal is used for warnings (refer to the *Warnings* section for more information). It can also be used to turn on another recorder (refer to *Series Recording* in this step for more information). The output is active when the optical coupler is turned on and non-active when the optical coupler is turned off. Maximum current drive is 7 mA DC, and the maximum voltage is +24 VDC.

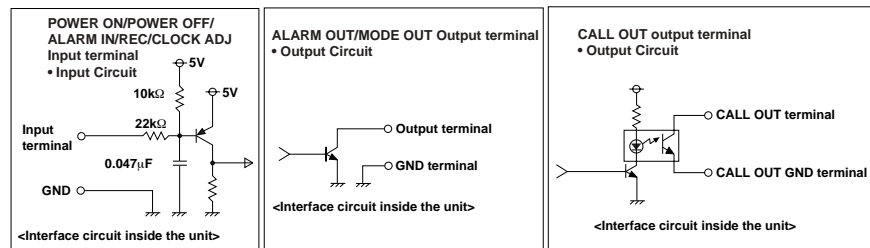
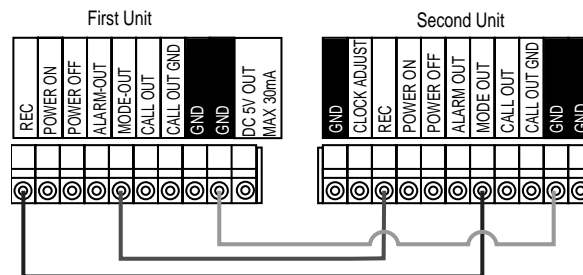

**Figure 10.** Schematics for Input and Output Terminals

#### SERIES RECORDING

By connecting multiple units in series as shown in Figure 11, when the one unit's hard disk is full, the next unit automatically begins recording.

In this example, when the first unit's hard disk is full, the second unit begins recording; when the second unit's hard disk is full, the first unit begins overwriting its hard disk. If you do not want the first unit to overwrite its hard disk, do not connect MODE OUT from the second unit to REC of the first unit. The series recording function can also be activated by connecting the CALL OUT terminal in place of the MODE OUT terminal; the disk storage capacity setting is made in the Call Out menu. When the CALL OUT terminal is used, if the first unit reaches the preset capacity, experiences a malfunction, or otherwise cannot continue recording, the second unit begins recording.



**Figure 11.** Connecting Recorders in Series

5. Optional. Connect peripheral recording devices.

By connecting peripheral recording devices to the recorder through the SCSI interface (SCSI-II half-pitch 50-pin), storage space can be increased and archiving and copying functions can be performed.

To increase storage space, up to two (DX3009-060, DX3016-060, and DX3016-120) or three (DX3009-030) peripheral hard disk drives (maximum of 34 GB per unit for DX3009 models or 103 GB per unit for DX3016 models) can be added to supplement the built-in hard disk.

For archiving or copying functions, a tape or disk device can be connected.

The following tape devices can be connected to the recorder:

Pelco	DX3000-D25 (drive)
Pelco	DX3000-T25 (blank tape)

The following disk devices can be connected to the recorder:

MO (640 MB)	Fujitsu SMB-640WF
MO (1.3 GB)	Fujitsu SMB-1300W
DVD-RAM	Panasonic LF-D200JD
HDD	SCSI-IF Type
Zip (250 MB)	IOMEGA Z250S

Connections between the recorder and peripheral devices are made with SCSI cables (not supplied). As SCSI cables differ with each device, check for the appropriate pin arrangement before use. Cables must not exceed 3 feet (1 m).

On the rear panel of the recorder is a SCSI termination switch. Set the switch ON when nothing is connected the SCSI connector. Set to OFF when connecting peripheral devices.

Correct termination is necessary to maintain proper electrical connections to the peripheral devices. Make sure that the last peripheral device is terminated. (Depending on the device, the terminator may be built into the device. In this case, set the built-in terminator correctly.) Use an active terminator for SCSI.

Set the SCSI ID number of the peripheral recording device. Refer to the operation manual of each peripheral recording device for setting the SCSI ID Number. Use ID1-3 for hard drives, ID4 for an archive device, and ID5 for a copy device. On DX3016 models, also use ID4 when a hard disk drive is connected for repeated backup recording (considered an archiving function).

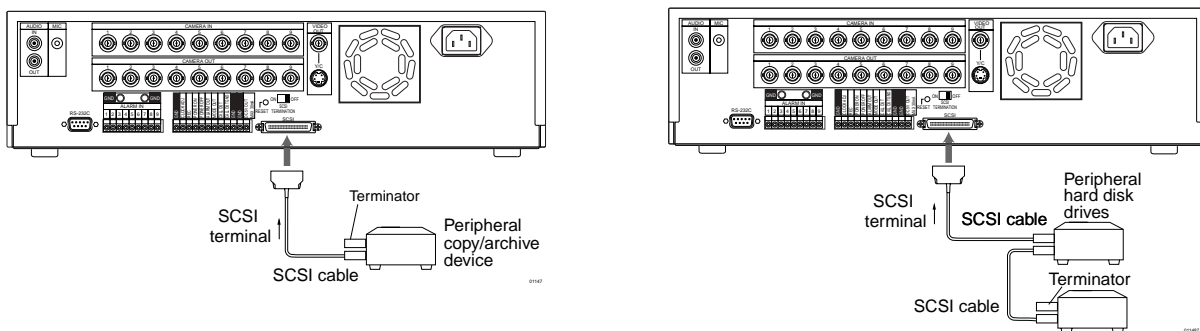

**Figure 12.** Connecting Peripheral Recording Devices (DX3009 Models Shown)



6. Connect the power cord to the recorder, and then plug the power cord into a wall socket.
7. Turn on power to peripheral recording devices first, and then turn on the power to the recorder. Power to the cameras and monitor can be turned on before or after turning on the recorder.

If there are no peripheral devices connected to the SCSI terminal, the installation is complete. Proceed to the *Programming* section.

If there are peripheral devices connected to the SCSI terminal, the recorder automatically detects peripheral recording devices connected to the SCSI terminal.

If a hard drive(s) has been added, refer to the *Adding a Hard Drive(s)* section for more information about turning on the recorder.

If a peripheral device takes a long time to start up, refer to the section on *Boot-Up Delay*.

## ADDING OR REMOVING A COPY OR ARCHIVE DEVICE

1. Turn off the power.
2. Connect or disconnect the copy or archive device.
3. Turn on the power.

## ADDING A HARD DRIVE(S)

This section applies only to devices connected to ID1-ID3.



**WARNING:** All data will be lost on the current drive(s) after you install an additional hard drive(s) and turn the power back on. Back up data you want to save before turning off the power to add a hard drive(s).

**NOTE:** The DX3000 uses the native format of the added drive(s); therefore, any added drive(s) do not have to be reformatted.

Up to two (DX3009-060) or three (DX3009-030) peripheral hard disk drives (maximum of 34 GB per unit) can be added to supplement the built-in hard disk when extended recording time is needed.

1. If a hard drive(s) has been added, a screen similar to the first one on the left appears after turning on the power. This screen shows a peripheral device connected to ID1.

```
<DEVICE CHECK>
SCSI ID0:HDD (30GB)
      ID1:HDD ( 9GB)
      ID2:NONE
      ID3:NONE
      ID4:NONE
      ID5:NONE
▶PWR-OFF      INITIALIZE
BOOT UP DELAY      00
```

If the second screen to the left appears, it is possible that there is either a poor connection, overlapping SCSI ID numbers, or an error in SCSI ID number settings. In this case, turn the SHUTTLE ring twice in the clockwise direction. Main power to the recorder is turned off. Check the connection and SCSI ID settings.

2. Make sure that the connected device(s) is recognized correctly.

If the connected device(s) is not displayed correctly, make sure that the cursor is beside POWER OFF. If the cursor is not beside POWER OFF, turn the JOG dial to move the cursor beside POWER OFF, and then turn the SHUTTLE ring twice to the right. The recorder's power is turned off. Make sure that the connection of the external device and the setting of the SCSI ID number is correct, and then turn the power back on.

```
      ID4:RDD
      ID5:DDS
▶PWR-OFF
BOOT UP DELAY      00
```

3. Turn the JOG dial to select INITIALIZE.
4. Turn the SHUTTLE ring to the right when "Turn the SHUTTLE RING >> to EXECUTE." is displayed.

## REMOVING A HARD DRIVE(S)

```
ID5:RDD
▶PWR-OFF CONFIG. 00
BOOT UP DELAY
```

This section applies only to devices removed from ID1-ID3.

1. Turn off power.
2. Remove the hard drive(s).
3. Turn on power. The screen to the left appears.
4. Make sure that any connected device is recognized correctly.
5. Turn the JOG dial to select CONFIG., and then turn the SHUTTLE ring to the right twice. The recorder starts configuring.

When CONFIG. is selected, the recorder saves the data recorded on any connected peripheral recording device (which has not been removed) as well as the data recorded on the built-in hard drive. Data recorded on a removed peripheral recording device is not affected.

## CONFIRMING THAT A DEVICE IS CONNECTED

1. Press the INFO button. The Information menu appears.
2. Turn the JOG dial to move the cursor beside CONNECTED SCSI DEVICE.
3. Turn the SHUTTLE ring to the right. The Connected SCSI Device menu appears.
4. Press the INFO button to exit.

## BOOT-UP DELAY

```
<DEVICE CHECK>
SCSI ID0:HDD (30GB)
ID1:HDD ( 9GB)
ID2:NONE
ID3:NONE
ID4:NONE
ID5:NONE
▶INITIALIZE ALL HDD BOOT UP DELAY 00
```

Because the recorder searches for connected devices when power is turned on, peripheral devices must be turned on before power is turned on to the digital recorder. To handle peripherals that take a long time to start up, the recorder can be preset to delay the timing of its search for these devices, as follows.

1. Press the POWER button while pressing the REC button to turn the power on. The Device Check menu appears.
2. Turn the JOG dial to move the cursor beside BOOT UP DELAY, and then turn the SHUTTLE ring to the right. The boot-up delay option starts flashing.
3. Turn the JOG dial to set the delay time, and then turn the SHUTTLE ring to the right. You can set the time from 00 to 99 seconds.

*NOTE: When the boot-up delay is set and a timer recording is performed, the recorder will begin recording later than the time set as the recording time.*

4. Press the POWER button. The recorder's power is turned off.
5. Press the POWER button again. The recorder starts configuring after the preset delayed time has passed.

If a different peripheral recording device was connected since the last time the recorder was booted up, the Device Check menu appears.

# PROGRAMMING

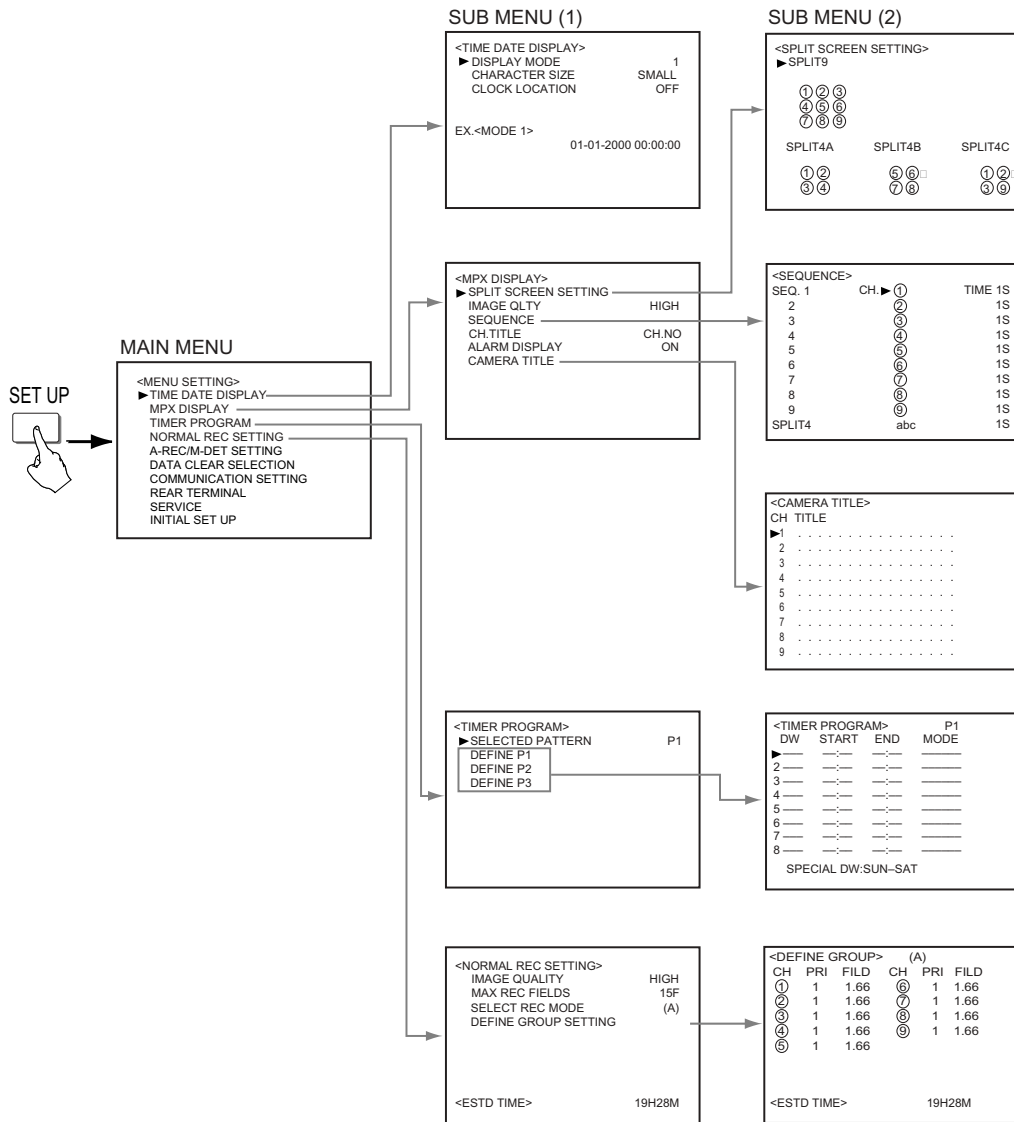
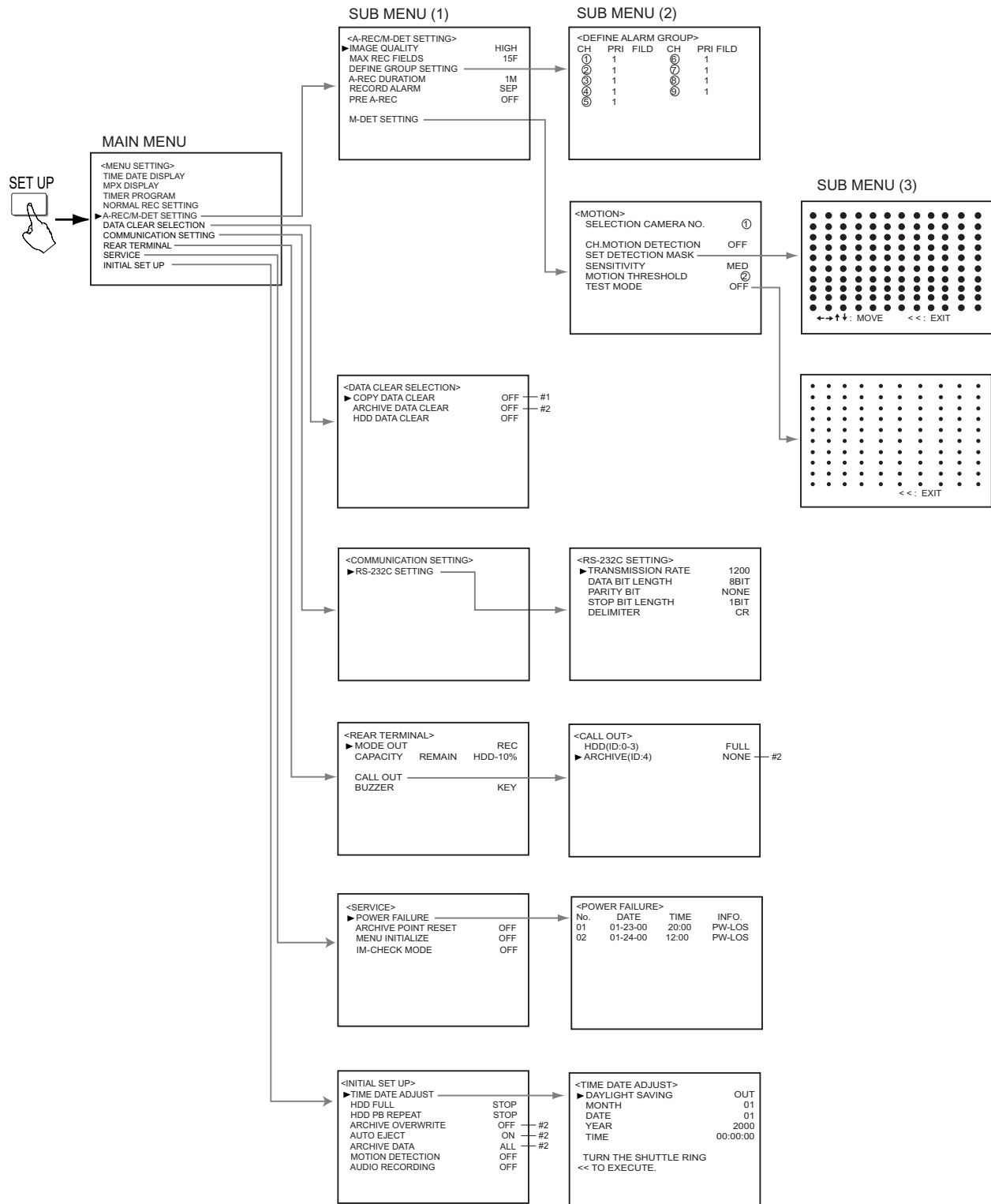

Figure 13. Menu Tree, DX3009 Models



#1 - This is displayed only when a copying device is connected to ID5.

#2 - This is displayed only when an ARCHIVE device is connected to ID4.

01134

**Figure 13. Menu Tree, DX3009 Models (Continued)**

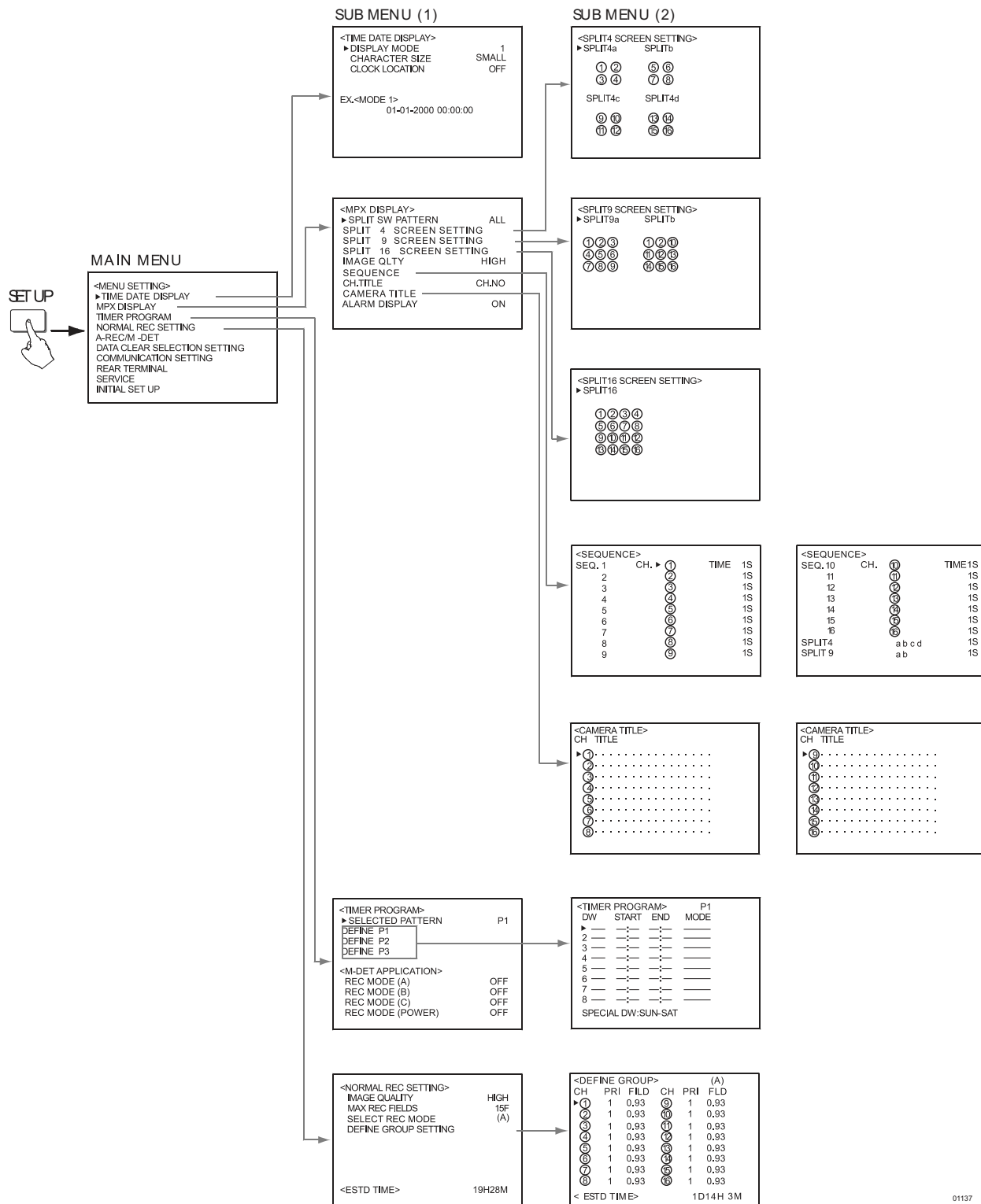
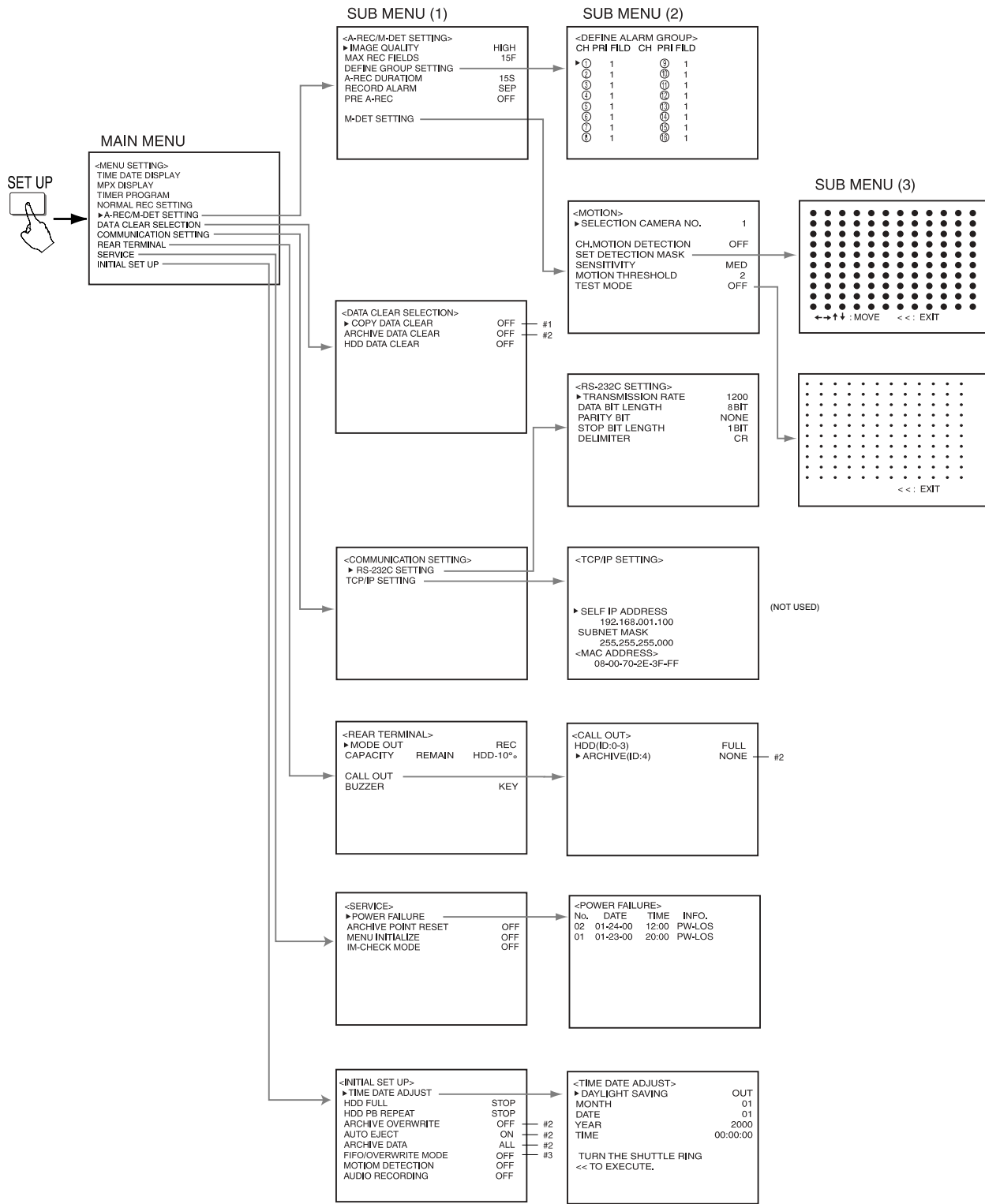

Figure 14. Menu Tree, DX3016 Models



#1 - This is displayed only when a copying device is connected to ID5.  
 #2 - This is displayed only when an ARCHIVE device is connected to ID4.  
 #3 - This is displayed only when an HDD device is connected to ID4.

01136

Figure 14. Menu Tree, DX3016 Models (Continued)

## ALARMS

### IMAGE QUALITY

Skip steps 1 and 2 if they have already been done.

1. Press the SET UP button to display the Menu Setting menu.
2. Turn the JOG dial to move the cursor to A-REC/M-DET SETTING, and then turn the SHUTTLE ring to the right. The A-Rec/M-Det Setting menu appears.
3. Check that the cursor is next to IMAGE QUALITY, and then turn the SHUTTLE ring to the right. The option starts flashing.

*NOTE: If the PRE A-REC field in this menu has been set to SHORT, MEDIUM, or LONG, the option does not flash because it cannot be changed.*

4. Turn the JOG dial to select the option, and then turn the SHUTTLE ring to the right. The option stops flashing.

Turning the JOG dial switches the image quality options as follows:

BASIC, STANDARD, MEDIUM, HIGH, SUPERIOR

5. Do one of the following:
  - Turn the JOG dial to go to another item in this menu.
  - Turn the SHUTTLE ring to the left to return to the Menu Setting menu to go to another menu.
  - Press the SET UP button to exit the programming mode.

### MAXIMUM RECORDING FIELDS

Skip steps 1 and 2 if they have already been done.

1. Press the SET UP button to display the Menu Setting menu.
2. Turn the JOG dial to move the cursor to A-REC/M-DET SETTING, and then turn the SHUTTLE ring to the right. The A-Rec/M-Det Setting menu appears.
3. Turn the JOG dial to move the cursor to MAX REC FIELDS, and then turn the SHUTTLE ring to the right. The option starts flashing.

*NOTE: If the PRE A-REC field in this menu has been set to SHORT, MEDIUM, or LONG, the option does not flash because it cannot be changed.*

4. Turn the JOG dial to select the maximum recording fields, and then turn the SHUTTLE ring to the right. The option stops flashing.

Turning the JOG dial switches the maximum recording fields options as follows:

DX3009 Models – 1F, 3F, 5F, 7.5F, 15F, 30F

DX3016 Models – 1F, 3F, 5F, 6F, 7.5F, 10F, 15F, 30F

*NOTE: If the motion detection setting in the Initial Set Up menu is turned ON, option 30F is not available on the DX3009 models, and options 6F, 10F, and 30F are not available on the DX3016 models.*

5. Do one of the following:
  - Turn the JOG dial to go to another item in this menu.
  - Turn the SHUTTLE ring to the left to return to the Menu Setting menu to go to another menu.
  - Press the SET UP button to exit the programming mode.

## DEFINE GROUP SETTING

Skip steps 1 and 2 if they have already been done.

1. Press the SET UP button to display the Menu Setting menu.
2. Turn the JOG dial to move the cursor to A-REC/M-DET SETTING, and then turn the SHUTTLE ring to the right. The A-Rec/M-Det Setting menu appears.
3. Turn the JOG dial to move the cursor to DEFINE GROUP SETTING, and then turn the SHUTTLE ring to the right. The Define Alarm Group menu appears.
4. Turn the JOG dial to move the cursor into one of the camera fields, and then turn the SHUTTLE ring to the right. The Priority (PRI) option starts flashing.

*NOTE: If the PRE A-REC field in this menu has been set to SHORT, MEDIUM, or LONG, the option does not flash because it cannot be changed.*

5. Turn the JOG dial to select an option, and then turn the SHUTTLE ring to the right. The option stops flashing.

Turning the JOG dial switches the priority options as follows:

1, 2, 3, 4, 5, -

The - (hyphen) means that camera channel is turned off; that is, if there is an alarm, it will not be recorded.

For camera channels with a Priority setting of 1-5, the recording interval set in maximum recording fields is divided according to the value entered in the Priority setting. The FILD (FIELDS) setting will vary according to this value.

*NOTE: When the AUDIO RECORDING setting in the Initial Set Up menu is ON, the only options available are 1 and -.*

*NOTE: When the RECORD ALARM setting in this menu is set to SEP, the only options available are 1 and -. The FILD screen remains blank.*

6. Repeat steps 4 and 5 for other cameras. Every camera channel must be assigned a priority setting; otherwise, you will not be able to exit the menu.
7. Turn the SHUTTLE ring to the left once to return to the A-Rec/M-Det Setting menu or twice to return to the Menu Setting menu, or press the SET UP button to exit the programming mode.



## ALARM RECORDING DURATION

Skip steps 1 and 2 if they have already been done.

1. Press the SET UP button to display the Menu Setting menu.
2. Turn the JOG dial to move the cursor to A-REC/M-DET SETTING, and then turn the SHUTTLE ring to the right. The A-Rec/M-Det Setting menu appears.
3. Turn the JOG dial to move the cursor to A-REC DURATION, and then turn the SHUTTLE ring to the right. The option starts flashing.

*NOTE: If the PRE A-REC field in this menu has been set to SHORT, MEDIUM, or LONG, the option does not flash because it cannot be changed.*

4. Turn the JOG dial to select the option, and then turn the SHUTTLE ring to the right. The option stops flashing.

Turning the JOG dial switches the alarm record duration options as follows:

DX3009 Models – MAN, 15S, 30S, 45S, 1M, 2M, 5M, 10M

DX3016 Models – MAN, 2S, 5S, 10S, 15S, 30S, 45S, 1M, 2M, 5M, 10M

MAN: Alarm recording continues until the ALARM IN terminal is cleared.

*NOTE: MAN cannot be selected when the Motion Detection setting in the Initial Set Up menu is ON. If MAN is selected and then the motion detection setting is turned on, MAN is automatically changed to 15S on DX3009 models and 2S on DX3016 models.*

5. Do one of the following:
  - Turn the JOG dial to go to another item in this menu.
  - Turn the SHUTTLE ring to the left to return to the Menu Setting menu to go to another menu.
  - Press the SET UP button to exit the programming mode.

## RECORD ALARM

This setting determines which cameras to record when an ALARM IN terminal is grounded. This setting is only effective during alarm recording. After alarm recording, operations return to their prior settings.

Skip steps 1 and 2 if they have already been done.

1. Press the SET UP button to display the Menu Setting menu.
2. Turn the JOG dial to move the cursor to A-REC/M-DET SETTING, and then turn the SHUTTLE ring to the right. The A-Rec/M-Det Setting menu appears.
3. Turn the JOG dial to move the cursor to RECORD ALARM, and then turn the SHUTTLE ring to the right. The option starts flashing.

*NOTE: If the PRE A-REC field in this menu has been set to SHORT, MEDIUM, or LONG, the option does not flash because it cannot be changed.*

4. Turn the JOG dial to select the option, and then turn the SHUTTLE ring to the right. The option stops flashing.

Turning the JOG dial switches the record alarm options as follows:

ALL, SEP

ALL: Alarm recording of all cameras set to be operated on the Define Alarm Group menu will start when the ALARM IN terminal is grounded.

SEP: Alarm recording of the camera that received the alarm signal will start. If several cameras received an alarm input at once, all of those cameras will start alarm recording.

5. Do one of the following:
  - Turn the JOG dial to go to another item in this menu.
  - Turn the SHUTTLE ring to the left to return to the Menu Setting menu to go to another menu.
  - Press the SET UP button to exit the programming mode.

### PRE-ALARM RECORDING

This setting determines if pre-alarm images will be recorded either before motion is detected or before there is an alarm signal at the ALARM IN terminal. If the pre-alarm recording option is selected, the recorder temporarily records video, but saves it only if motion is detected or the ALARM IN terminal is activated. The duration of the saved recording depends on the settings in the MAX REC FIELDS, IMAGE QUALITY, and PRE-A REC fields.

Skip steps 1 and 2 if they have already been done.

1. Press the SET UP button to display the Menu Setting menu.
2. Turn the JOG dial to move the cursor to A-REC/M-DET SETTING, and then turn the SHUTTLE ring to the right. The A-Rec/M-Det Setting menu appears.
3. Turn the JOG dial to move the cursor to PRE A-REC, and then turn the SHUTTLE ring to the right. The option starts flashing.
4. Turn the JOG dial to select the option. The option stops flashing.

Turning the JOG dial switches the pre-alarm recording options as follows:

OFF, SHORT, MEDIUM, LONG

*NOTE: When SHORT, MEDIUM, or LONG is selected, the SELECT REC MODE field in the Normal Rec Setting menu is automatically set to A-REC (Alarm Record), and many menu settings cannot be changed.*

*NOTE: The duration of recording before the alarm occurs depends on the settings in the MAX REC FIELDS, IMAGE QUALITY, and PRE A-REC fields.*

5. Turn the SHUTTLE ring to the right. The unit enters standby mode for pre-alarm recording, and the PRE ALARM REC indicator on the front panel illuminates (unless OFF was selected).

6. Do one of the following:
  - Turn the JOG dial to go to another item in this menu.
  - Turn the SHUTTLE ring to the left to return to the Menu Setting menu to go to another menu.
  - Press the SET UP button to exit the programming mode.

## M-DET SETTING

Refer to *Motion Detection* for instructions.

## ARCHIVE POINTER RESET

The recorder places the Archive Pointer where the archive stops. For example, 100 hours of data recorded on the unit's hard disk is to be transferred to a medium with only 80 hours of available recording space. When the backup process is completed, the Archive Pointer will memorize the hard disk's 80-hour mark. When the next backup process is initiated, backup will begin at this point.

If you want to reset the Archive Pointer, follow the steps below.

Skip steps 1 and 2 if they have already been done.

1. Press the SET UP button to display the Menu Setting menu.
2. Move the cursor next to SERVICE, and then turn the SHUTTLE ring to the right. The Service menu appears.
3. Turn the JOG dial until the cursor is next to ARCHIVE POINT RESET, and then turn the SHUTTLE ring to the right. The option starts flashing.
4. Turn the JOG dial to select ON.
5. The message "TURN THE SHUTTLE RING >> to EXECUTE." appears on the screen. Turn the SHUTTLE ring to the right to reset the archive pointer. The pointer resets and the option returns to OFF.
6. Do one of the following:
  - Turn the JOG dial to go to another item in this menu.
  - Turn the SHUTTLE ring to the left to return to the Menu Setting menu to go to another menu.
  - Press the SET UP button to exit the programming mode.

## ARCHIVE

*NOTE: This menu item does not appear unless an archiving device is connected to the recorder.*

### DATA

When backing up records onto backup media, it is possible to back up all data on the hard disk drive or to select and back up only the alarm portions of the records.

Skip steps 1 and 2 if they have already been done.

1. Press the SET UP button to display the Menu Setting menu.
2. Move the cursor to INITIAL SET UP, and then turn the SHUTTLE ring to the right. The Initial Set Up menu appears.
3. Turn the JOG dial move the cursor to ARCHIVE DATA, and then turn the SHUTTLE ring to the right.

4. Turn the JOG dial to select the option, and then turn the SHUTTLE ring to the right.

Turning the JOG dial switches the archive data options as follows:

ALL: This backs up all the data recorded on the main hard disk after the archive pointer. Alternatively, all data will be backed up.

ALARM: Of all the data blocks recorded on the main hard disk (1 MB units), this will back up only the data blocks that contain the alarm record. Some data on either side of the alarm record may be included when backing up a small alarm record.

5. Do one of the following:

- Turn the JOG dial to go to another item in this menu.
- Turn the SHUTTLE ring to the left to return to the Menu Setting menu to go to another menu.
- Press the SET UP button to exit the programming mode.

### OVERWRITE

This setting determines whether the recorder will overwrite data on the archive medium when making a new archive. When set to ON, all data on the archive medium will be overwritten.

Skip steps 1 and 2 if they have already been done.

1. Press the SET UP button to display the Menu Setting menu.
2. Turn the JOG dial until the cursor is next to INITIAL SET UP, and then turn SHUTTLE ring to the right. The Initial Set Up menu appears.
3. Move the cursor to ARCHIVE OVERWRITE, and then turn the SHUTTLE ring to the right until the option flashes.
4. Turn JOG dial to select ON or OFF, and then turn the SHUTTLE ring to the right. The option stops flashing.

The Archive Pointer is recorded when backup is either temporarily stopped or finished. Using the Archive Pointer, the recorder will begin the next backup at the end point of the previous backup.

5. Do one of the following:

- Turn the JOG dial to go to another item in this menu.
- Turn the SHUTTLE ring to the left to return to the Menu Setting menu to go to another menu.
- Press the SET UP button to exit the programming mode.

*NOTE: This menu item does not appear unless an archiving device is connected to the recorder.*

## AUDIO RECORDING

The recorder can record audio with an image.

Skip steps 1 and 2 if they have already been done.

1. Press the SET UP button to display the Menu Setting menu.
2. Turn the JOG dial to move the cursor to INITIAL SET UP, and then turn the SHUTTLE ring to the right. The Initial Set Up menu appears.
3. Turn the JOG dial to select AUDIO RECORDING, and then turn the SHUTTLE ring to the right. The option starts flashing.

*NOTE: If the PRE A-REC field in the A-Rec/M-Det Setting menu has been set to SHORT, MEDIUM, or LONG, the option does not flash because it cannot be changed.*

4. Turn the JOG dial to select ON or OFF, and then turn the SHUTTLE ring to the right. The option stops flashing.

*NOTE: When the audio recording setting is set to ON, the available recording time and audio indicator (speaker icon) appear in the ESTD TIME in the Normal Rec Setting menu. Also, on DX3009 models PRI settings of 2-5 are automatically changed to 1 in the DEFINE GROUP setting in the Normal Rec Setting menu and in the DEFINE ALARM GROUP setting in the A-Rec/M-Det Setting menu.*

*NOTE: Depending on the setting of the image quality and the maximum recording fields, audio recording may not be available. If so, a speaker icon with a line through it appears next to the ESTD TIME in the Normal Rec Setting menu.*

5. Do one of the following:
  - Turn the JOG dial to go to another item in this menu.
  - Turn the SHUTTLE ring to the left to return to the Menu Setting menu to go to another menu.
  - Press the SET UP button to exit the programming mode.

## AUTO EJECT

*NOTE: This menu item does not appear unless an archiving device is connected to the recorder.*

This setting is for automatically ejecting the medium in the archive device.

If set to ON, the medium is ejected under the following conditions:

- At the completion of the backup process
- At the end of the programmed time, if the back up is made with the timer program
- When the archive in progress is cancelled

If you set to OFF, the archive medium is not ejected.

Skip steps 1 and 2 if they have already been done.

1. Press the SET UP button to display the Menu Setting menu.
2. Turn the JOG dial to move the cursor to INITIAL SET UP, and then turn the SHUTTLE ring to the right. The Initial Set Up menu appears.
3. Turn the JOG dial until the cursor is next to AUTO EJECT, and then turn the SHUTTLE ring to the right. The option flashes.
4. Turn the JOG dial to select ON or OFF, and then turn the SHUTTLE ring to the right. The option stops flashing.

5. Do one of the following:
  - Turn the JOG dial to go to another item in this menu.
  - Turn the SHUTTLE ring to the left to return to the Menu Setting menu to go to another menu.
  - Press the SET UP button to exit the programming mode.

## BUZZER

You can set the buzzer to sound under different conditions, depending on the option selected.

Skip steps 1 and 2 if they have already been done.

1. Press the SET UP button to display the Menu Setting menu.
2. Turn the JOG dial to move the cursor to REAR TERMINAL, and then turn the SHUTTLE ring to the right. The Rear Terminal menu appears.
3. Turn the JOG dial until the cursor is next to BUZZER, and then turn the SHUTTLE ring to the right. The option flashes.
4. Turn the JOG dial to select the option, and then turn the SHUTTLE ring to the right. The option stops flashing.

Turning the JOG dial switches the buzzer options as follows:

KEY, WRNG, REMAIN, OFF

KEY: The buzzer sounds when any button is pressed or the JOG dial or SHUTTLE ring is turned.

WRNG: The buzzer sounds when a warning occurs. Refer to the *Warnings* section.

REMAIN: The buzzer sounds when the remaining storage capacity of hard drive reaches the preset amount selected in CAPACITY REMAIN. Press the WARNING RESET button to stop the buzzer.

OFF: The buzzer does not sound.

5. Do one of the following:
  - Turn the JOG dial to go to another item in this menu.
  - Turn the SHUTTLE ring to the left to return to the Menu Setting menu to go to another menu.
  - Press the SET UP button to exit the programming mode.

## CALL OUT

A signal from the CALL OUT terminal can be sent to an external device to warn when the hard disk drive or archive device reaches the remaining capacity set in this menu. The call out signal can also activate another recorder if the CALL OUT terminal is wired to the record (REC) input of another recorder.

Skip steps 1 and 2 if they have already been done.

1. Press the SET UP button to display the Menu Setting menu.
2. Turn the JOG dial to move the cursor to REAR TERMINAL, and then turn the SHUTTLE ring to the right. The Rear Terminal menu appears.
3. Turn the JOG dial until the cursor is next to CALL OUT, and then turn the SHUTTLE ring to the right. The Call Out menu appears.
4. Check that the cursor is next to HDD, and then turn the SHUTTLE ring to the right. The option starts flashing.
5. Turn the JOG dial to select the option, and then turn the SHUTTLE ring to the right. The option stops flashing.

Turning the JOG dial switches the call out options as follows:

NONE, FULL, 2%, 4%, 6%, 8%, 10%, 15%, 20%, 30%, 40%, 50%

NONE: No signal is sent from the CALL OUT terminal.

6. If an archive device is connected to the recorder, turn the JOG dial until the cursor is next to ARCHIVE, and then turn the SHUTTLE ring to the right. The option starts flashing.
7. Turn the JOG dial to select the option, and then turn the SHUTTLE ring to the right. The option stops flashing.
8. Turn the SHUTTLE ring to the left once to return to the Rear Terminal menu or twice to return to the Menu Setting menu, or press the SET UP button to exit the programming mode.

## CAPACITY REMAINING

When the remaining storage capacity of the main hard drive (HDD) or archive device reaches the preset amount set in this menu, the recorder does the following:

- A signal is sent from the Mode Out terminal when the MODE OUT field in the Rear Terminal menu is set to REMAIN.
- The recorded storage capacity flashes when Display Mode 3 is selected.
- The buzzer sounds when the buzzer field in the Rear Terminal menu is set to REMAIN.

Skip steps 1 and 2 if they have already been done.

1. Press the SET UP button to display the Menu Setting menu.
2. Turn the JOG dial to move the cursor to REAR TERMINAL, and then turn the SHUTTLE ring to the right. The Rear Terminal menu appears.
3. Turn the JOG dial until the cursor is next to CAPACITY REMAIN, and then turn the SHUTTLE ring to the right. The device option starts flashing.

4. Turn the JOG dial to select the device.

Turning the JOG dial switches the device options as follows:

HDD, ARC, NONE

Select HDD if the MODE OUT terminal is wired to the record (REC) input of another recorder.

5. Turn the SHUTTLE ring to the right. The percentage option starts flashing unless NONE was selected. If NONE was selected, go to step 7.
6. Turn the JOG dial to select the percentage, and then turn the SHUTTLE ring to the right.

Turning the JOG dial switches the percentage options as follows:

2%, 4%, 6%, 8%, 10%, 15%, 20%, 30%, 40%, 50%

If the MODE OUT terminal is wired to the record (REC) input of another recorder, the other recorder begins recording when the storage capacity of this unit reaches the pre-specified level. REMAIN must be selected in the MODE OUT field in the Rear Terminal menu.

7. Do one of the following:
  - Turn the JOG dial to go to another item in this menu.
  - Turn the SHUTTLE ring to the left to return to the Menu Setting menu to go to another menu.
  - Press the SET UP button to exit the programming mode.

## DATA CLEAR (ERASE) SELECTION

This function allows you to erase data from a recording device.

Skip steps 1 and 2 if they have already been done.

1. Press the SET UP button to display the Menu Setting menu.
2. Turn the JOG dial to move the cursor to DATA CLEAR SELECTION, and then turn the SHUTTLE ring to the right. The Data Clear Selection menu appears.
3. Turn the JOG dial to select the device, and then turn the SHUTTLE ring to the right. The option starts flashing.

*NOTE: If the PRE A-REC field in the A-Rec/M-Det Setting menu has been set to SHORT, MEDIUM, or LONG, the option does not flash because it cannot be changed.*

COPY DATA CLEAR or ARCHIVE DATA CLEAR appear on the screen only when a copy device or archive device is connected.

4. Turn the JOG dial to select ON or OFF.

If you selected ON, the message, "TURN SHUTTLE RING >> to EXECUTE." appears on the screen. Turn the SHUTTLE ring to the right to erase the data.

If you do not want to erase data, turn the JOG dial until OFF flashes, and then turn the SHUTTLE ring to the right.



**WARNING:** If you selected HDD Data Clear, data will be erased from all internal and external hard disk drives (ID0-ID3). Back up any data you want to save before executing this command.



5. Do one of the following:
  - Turn the JOG dial to go to another item in this menu.
  - Turn the SHUTTLE ring to the left to return to the Menu Setting menu to go to another menu.
  - Press the SET UP button to exit the programming mode.

### FIFO/OVERWRITE MODE (DX3016 Models Only)

*NOTE: This menu item does not appear unless a hard disk drive is connected to ID4.*

Use this setting when you want to make repeated backups to a hard disk drive that is connected to ID4.

Skip steps 1 and 2 if they have already been done.

1. Press the SET UP button to display the Menu Setting menu.
2. Turn the JOG dial to move the cursor to INITIAL SET UP, and then turn the SHUTTLE ring to the right. The Initial Set Up menu appears.
3. Turn the JOG dial until the cursor is next to FIFO/OVERWRITE MODE, and then turn the SHUTTLE ring to the right. The option starts flashing.
4. Turn the JOG dial to select ON or OFF, and then turn the SHUTTLE ring to the right. The option stops flashing.
5. Do one of the following:

Turn the JOG dial to go to another item in this menu.

Turn the SHUTTLE ring to the left to return to the Menu Setting menu to go to another menu.

Press the SET UP button to exit the programming mode.

### BACKUP FOLLOWING A POWER FAILURE

If a power failure occurs during backup, the backup process must be started over.

Press the ARCHIVE button to restart the backup process if the recorder is not set for timer recording or if the current time is not covered by a timer program.

If the recorder is set for timer recording and the current time is covered by a program, backup restarts automatically after power is restored.

When the backup process is restarted, all data backed up until the power failure is lost, and the backup pointer returns to the backup starting point before the power failure.

## HARD DISK DRIVE (HDD) FULL

When the end of the hard disk drive (HDD) is reached during recording, this function determines what the recorder will do.

Skip steps 1 and 2 if they have already been done.

1. Press the SET UP button to display the Menu Setting menu.
2. Turn the JOG dial to move the cursor to INITIAL SET UP, and then turn the SHUTTLE ring to the right. The Initial Set Up menu appears.
3. Turn the JOG dial until the cursor is next to HDD FULL, and then turn the SHUTTLE ring to the right. The option starts flashing.

*NOTE: If the PRE A-REC field in the A-Rec/M-Det Setting menu has been set to SHORT, MEDIUM, or LONG, the option does not flash because it cannot be changed.*

4. Turn the JOG dial to select the option, and then turn the SHUTTLE ring to the right. The option stops flashing.

Turning the JOG dial switches the hard drive options as follows:

**REC•STANDBY** (Recording standby): The unit stops recording when the hard disk is full. The unit overwrites the hard disk when the unit receives an alarm signal, a REC terminal signal, or when the REC button is pushed.

Select this option if the REC terminal is wired to the MODE OUT terminal of another recorder.

**REPEAT**: When the disk reaches the end during recording, the recording starts again from the beginning of the disk.

**ALARM•PROT** (Alarm protection): If there is any alarm recording, the unit stops recording when the hard disk is full and displays the HDD FULL message on the monitor. When WRNG is entered as the BUZZER value (found in the Rear Terminal menu), the buzzer is also activated. A signal is sent from the CALL OUT terminal when the CALL OUT value (found in the Rear Terminal menu) is reached. If there are no alarm recordings, the unit continues recording by automatically overwriting the hard disk.

If the CALL OUT terminal is wired to the REC input of another recorder, the other recorder begins recording when the call out signal is sent.

**STOP**: The unit stops recording when the hard disk is full and displays the HDD FULL message on the monitor. When WRNG is entered as the BUZZER value (found in the Rear Terminal menu), the buzzer is also activated. The unit stops recording when there is no more storage space in memory. A signal is sent from the CALL OUT terminal when the CALL OUT value (found in the Rear Terminal menu) is reached. To restart overwriting on the hard disk, press the WARNING RESET button to cancel HDD FULL, and then press the REC button.

If the CALL OUT terminal is wired to the REC input of another recorder, the other recorder begins recording when the call out signal is sent.

5. Do one of the following:
  - Turn the JOG dial to go to another item in this menu.
  - Turn the SHUTTLE ring to the left to return to the Menu Setting menu to go to another menu.
  - Press the SET UP button to exit the programming mode.

## HARD DISK DRIVE (HDD) REPEAT PLAYBACK

When the end of the hard disk drive (HDD) is reached during playback, you can set the recorder either to stop playback or to continue playback from the beginning of the disk.

Skip steps 1 and 2 if they have already been done.

1. Press the SET UP button to display the Menu Setting menu.
2. Turn the JOG dial until the cursor is next to INITIAL SET UP, and then turn the SHUTTLE ring to the right. The Initial Set Up menu appears.
3. Turn the JOG dial until the cursor is next to HDD PB REPEAT, and then turn the SHUTTLE ring to the right. The option starts flashing.

*NOTE: If the PRE A-REC field in the A-Rec/M-Det Setting menu has been set to SHORT, MEDIUM, or LONG, the option does not flash because it cannot be changed.*

4. Turn the JOG dial to select REPEAT or STOP, and then turn the SHUTTLE ring to the right. The option stops flashing.

**REPEAT:** At the end of the hard disk, the recorder continues playback from the beginning of the disk.

**STOP:** The recorder stops playback at the end of the hard disk.

5. Do one of the following:
  - Turn the JOG dial to go to another item in this menu.
  - Turn the SHUTTLE ring to the left to return to the Menu Setting menu to go to another menu.
  - Press the SET UP button to exit the programming mode.

## IM-CHECK MODE

This function checks to determine if the recorded video has been altered. This function can check the recorded video on the internal hard drive as well as video from external devices. The authentication software analysis each frame of the video stream to verify that the watermarking is present and that the original video has not been changed. If an image is modified, a small black square appears in the modified area of the image. If the image is an alarm, a small black square also appears on the screen next to the alarm number. The message "WARNING: MODIFIED IMAGE" appears on the screen along with the numbers of the affected cameras.

Skip steps 1 and 2 if they have already been done.

1. Press the SET UP button to display the Menu Setting menu.
2. Move the cursor next to SERVICE, and then turn the SHUTTLE ring to the right. The Service menu appears.
3. Turn the JOG dial until the cursor is next to IM-CHECK MODE, and then turn the SHUTTLE ring to the right. The option starts flashing.

*NOTE: If the PRE A-REC field in the A-Rec/M-Det Setting menu has been set to SHORT, MIDDLE, or LONG, the option does not flash because it cannot be changed.*

4. Turn the JOG dial to select ON or OFF, and then turn the SHUTTLE ring to the right. The option stops flashing.

5. Do one of the following:
  - Turn the JOG dial to go to another item in this menu.
  - Turn the SHUTTLE ring to the left to return to the Menu Setting menu to go to another menu.
  - Press the SET UP button to exit the programming mode.

## INITIALIZE MENU

Initializing the menus returns most settings to their default values.

Skip steps 1 and 2 if they have already been done.

1. Press the SET UP button to display the Menu Setting menu.
2. Turn the JOG dial to move the cursor to SERVICE, and then turn the SHUTTLE ring to the right. The Service menu appears.
3. Turn the JOG dial until the cursor is next to MENU INITIALIZE, and then turn the SHUTTLE ring to the right. The option starts flashing.

*NOTE: If the PRE A-REC field in the A-Rec/M-Det Setting menu has been set to SHORT, MEDIUM, or LONG, the option does not flash because it cannot be changed.*

4. Turn the JOG dial to select ON or OFF.
5. If you selected ON, "PUSH WARNING RESET KEY THEN ALL MENU WILL BE INITIALIZED." appears on the screen. Press the WARNING RESET button. The 9-camera screen (DX3009 models) or 16-camera screen (DX3016 models) appears on the monitor and menus are reset to their default values, except for the time and date display, timer program settings, and camera titles. The Selected Pattern setting is set to P1 in the Timer Program. The Menu Initialize option returns to OFF and stops flashing.

If you selected OFF, turn the SHUTTLE ring to the right. The option stops flashing.

6. Do one of the following:
  - Turn the JOG dial to go to another item in this menu.
  - Turn the SHUTTLE ring to the left to return to the Menu Setting menu to go to another menu.
  - Press the SET UP button to exit the programming mode.

## MODE OUT

With this setting, a signal can be output to indicate the status of the recorder.

Skip steps 1 and 2 if they have already been done.

1. Press the SET UP button to display the Menu Setting menu.
2. Turn the JOG dial to move the cursor to REAR TERMINAL, and then turn the SHUTTLE ring to the right. The Rear Terminal menu appears.
3. Check that the cursor is next to MODE OUT, and then turn the SHUTTLE ring to the right. The option starts flashing.

4. Turn the JOG dial to select the option, and then turn the SHUTTLE ring to the right. The option stops flashing.

Turning the JOG dial switches the mode out options as follows:

REC, PLAY, POWER, REMAIN

REC: The signal is output during recording.

PLAY: The signal is output during playback.

POWER: The signal is output when the recorder's power switch is on.

REMAIN: The signal is output when the remaining storage capacity of main hard drive, archive device, or copy device reaches the rate which is set in the CAPACITY REMAIN field of the Rear Terminal menu.

Select REMAIN if the MODE OUT terminal is wired to the record (REC) input of another recorder.

5. Do one of the following:
  - Turn the JOG dial to go to another item in this menu.
  - Turn the SHUTTLE ring to the left to return to the Menu Setting menu to go to another menu.
  - Press the SET UP button to exit the programming mode.

## MOTION DETECTION

*NOTE: To set up motion detection to operate during a specified time period (DX3016 models only), refer to the section on Motion Detection During a Timer Recording.*

These settings are used to initiate alarm recording when movement is detected within the images captured by the cameras.

Skip steps 1 and 2 if they have already been done.

1. Press the SET UP button to display the Menu Setting menu.
2. Turn the JOG dial to move the cursor to INITIAL SET UP, and then turn the SHUTTLE ring to the right. The Initial Set Up menu appears.
3. Turn the JOG dial to select MOTION DETECTION, and then turn the SHUTTLE ring to the right. The option starts flashing.

*NOTE: If the PRE A-REC field in the A-Rec/M-Det Setting menu has been set to SHORT, MEDIUM, or LONG, the option does not flash because it cannot be changed.*

4. Turn the JOG dial to select ON or OFF, and then turn the SHUTTLE ring to the right. The option stops flashing.

If you selected ON, proceed to step 5.

If you selected OFF, turn the SHUTTLE ring to the left to return to the Menu Setting menu to go to another menu, or press the SET UP button to exit the programming mode.

5. Turn the SHUTTLE ring to the left to return to the Menu Setting menu.
6. Turn the JOG dial to select A-REC/M-DET SETTING, and then turn the SHUTTLE ring to the right. The A-REC/M-DET SETTING menu appears.

*NOTE: The image quality, maximum recording fields, and alarm recording duration in the A-Rec/M-Det Setting menu also apply to motion detection recordings.*

7. Turn the JOG dial to select the M-DET SETTING, and then turn the SHUTTLE ring to the right. The Motion menu appears. This menu will not appear if the MOTION DETECTION setting in the Initial Set Up menu is OFF.
8. Check that the cursor is next to SELECTION CAMERA NO., and then turn the SHUTTLE ring to the right. The option starts flashing.
9. Turn the JOG dial to select the camera number, and then turn the SHUTTLE ring to the right. The option stops flashing.

When the camera selection setting has been made, the background display switches to the selected camera. Exiting the menu reverts the display to its original state.

Make sure the camera is also selected in the DEFINE GROUP SETTING in the A-Rec/M-Det Setting menu.

10. Turn the JOG dial to select CH. MOTION DETECTION, and then turn the SHUTTLE ring to the right. The option starts flashing.
11. Turn the JOG dial to select ON or OFF, and then turn the SHUTTLE ring to the right. The option stops flashing.

If you selected ON, proceed to the next step.

If you selected OFF, return to step 8 to select another camera. Otherwise, turn the SHUTTLE ring to the left once to return to the A-Rec/M-Det Setting menu, twice to return to the Menu Setting menu, or press the SET UP button to exit the programming mode.

12. Turn the JOG dial to select the SET DETECTION MASK, and then turn the SHUTTLE ring to the right. The Set Detection Mask menu appears. The mask is a 10 x 12 grid of 120 dots.
13. Set the detection mask.

“●” : Active symbol (Indicates the area where motion detection is active.)  
 “•” : Inactive symbol (Indicates the area where motion detection is inactive.)

Turn the JOG dial to change the symbol.  
 To move to the left, press camera button 6.  
 To move to the right, press camera button 7.  
 To move up, press camera button 8.  
 To move down, press camera button 9.  
 To select the entire screen, press camera button 4.  
 To deselect the entire screen, press camera button 5.

14. Turn the SHUTTLE ring to the left when you are finished setting the detection mask.
15. Turn the JOG dial to select SENSITIVITY, and then turn the SHUTTLE ring to the right. The option starts flashing.
16. Turn the JOG dial to select the option, and then turn the SHUTTLE ring to the right. The option stops flashing.

Turning the JOG dial switches the sensitivity options as follows:

LOW, LOWER, HIGHER, HIGH, MED

The camera's image data is sampled and compared every 0.6 seconds. Sensitivity is the difference in the degree of brightness between the sampled images and is divided into settings of five different levels. Select HIGHER to make the unit sensitive to even the smallest changes. Note, however, that false alarms may be caused by, for example, the flickering of fluorescent lighting fixtures.

17. Turn the JOG dial to select MOTION THRESHOLD, and then turn the SHUTTLE ring to the right. The option starts flashing.

18. Turn the JOG dial to select the threshold, and then turn the SHUTTLE ring to the right. The option stops flashing.

Select a number between 1 and 120. The number is the minimum number of active dots required to initiate alarm recording.

When establishing a value for the motion threshold setting, use a value that does not exceed the number of active dots set for the motion detection function. Alarm recording will not operate if a larger value is used.

19. This step and the next step verify the motion detection settings. Turn the JOG dial to select TEST MODE, and then turn the SHUTTLE ring to the right. The option starts flashing.
20. Turn the JOG dial to display ON, and then turn the SHUTTLE ring to the right. The test screen appears. The area where motion detection has been activated is displayed using “•”. When motion is detected on the number of dots specified in the motion threshold setting, the active symbol “●” appears on the screen.
21. Turn the SHUTTLE ring to the left to exit the test screen. Redo the settings if the recorder does not operate as intended.
22. Do one of the following:
  - Return to step 8 to select another camera.
  - Turn the SHUTTLE ring to the left once to return to the A-Rec/M-Det Setting menu or twice to return to the Menu Setting menu.
  - Press the SET UP button to exit the programming mode.

## MULTIPLEXER DISPLAY

By using the multiplexer functions, you can view 4, 9, or 16 cameras on your monitor. You can also arrange the viewing order of cameras.

### SPLIT SCREEN SETTING (DX3009 Models Only)

#### Nine-Camera (Split 9) Setting

Skip steps 1 and 2 if they have already been done.

1. Press the SET UP button to display the Menu Setting menu.
2. Turn the JOG dial to move the cursor to MPX DISPLAY, and then turn the SHUTTLE ring to the right. The MPX Display menu appears.
3. Check that the cursor is next to SPLIT SCREEN SETTING, and then turn the SHUTTLE ring to the right. The Split Screen Setting menu appears.
4. Make sure that the cursor is next to SPLIT 9, and then turn the SHUTTLE ring to the right. The top left number starts flashing.
5. Turn the JOG dial to display the desired camera number, and then turn the SHUTTLE ring to the right. The next camera number starts flashing. If you do not want to change the number, just turn the SHUTTLE ring to the right.
6. Repeat step 5 for all other cameras. You cannot use the same camera number more than once.
7. Turn the SHUTTLE ring to the left once to return to the MPX Display menu or twice to return to the Menu Setting menu, or press the SET UP button to exit the programming mode.

## Four-Camera (Split 4) Setting

In the SPLIT 4 setting mode, you select which camera images to show in a four-camera display. Three different groups of cameras can be defined.

Skip steps 1-3 if they have already been done.

1. Press the SET UP button to display the Menu Setting menu.
2. Turn the JOG dial to move the cursor to MPX DISPLAY, and then turn the SHUTTLE ring to the right. The MPX Display menu appears.
3. Check that the cursor is next to SPLIT SCREEN SETTING, and then turn the SHUTTLE ring to the right. The Split Screen Setting menu appears.
4. Turn the JOG dial to move the cursor to SPLIT4a, and then turn the SHUTTLE ring to the right. The top left number starts flashing.
5. Turn the JOG dial to display the desired camera number, and then turn the SHUTTLE ring to the right. The next camera number starts flashing. If you do not want to change the number, just turn the SHUTTLE ring to the right.
6. Repeat step 5 for the other three cameras. You cannot use the same camera number more than once in the same group.
7. Repeat steps 4-6 for SPLIT 4b and SPLIT 4c.
8. Turn the SHUTTLE ring to the left once to return to the MPX Display menu or twice to return to the Menu Setting menu, or press the SET UP button to exit the programming mode.

## SCREEN SWITCH PATTERN (DX3016 Models Only)

Skip steps 1 and 2 if they have already been done.

1. Press the SET UP button to display the Menu Setting menu.
2. Turn the JOG dial to move the cursor next to MPX DISPLAY, and then turn the SHUTTLE ring to the right. The MPX Display menu appears.
3. Check that the cursor is next to SPLIT SW PATTERN, and then turn the SHUTTLE ring to the right. The option starts flashing.
4. Turn the JOG dial to select the option, and then turn the SHUTTLE ring to the right. The option stops flashing.

Turning the JOG dial switches the options as follows:

ALL: All the display modes and sequential display modes for SPLIT 16, SPLIT 9, SPLIT 4, and single screens can be selected.

SHORT: Single-screen, SPLIT 4, and SPLIT 9 sequential displays can be selected. By combining SEQUENCE with the split-screen display setting, a fixed split-screen display pattern can be established. In this case, only SPLIT 16 can be selected during playback.

5. Do one of the following:
  - Turn the JOG dial to go to another item in this menu.
  - Turn the SHUTTLE ring to the left to return to the Menu Setting menu to go to another menu.
  - Press the SET UP button to exit the programming mode.



### SPLIT 4 SCREEN SETTING (DX3016 Models Only)

In the Split 4 Screen Setting, you select which camera images to show in a four-camera display. Four different groups of cameras can be defined.

Skip steps 1 and 2 if they have already been done.

1. Press the SET UP button to display the Menu Setting menu.
2. Turn the JOG dial to move the cursor next to MPX DISPLAY, and then turn the SHUTTLE ring to the right. The MPX Display menu appears.
3. Turn the JOG dial to move the cursor next to SPLIT 4 SCREEN SETTING, and then turn the SHUTTLE ring to the right. The Split4 Screen Setting menu appears.
4. Make sure the cursor is next to SPLIT4a, and then turn the SHUTTLE ring to the right. The top left number starts flashing.
5. Turn the JOG dial to display the desired camera number, and then turn the SHUTTLE ring to the right. The next camera number starts flashing. If you do not want to change the camera number, just turn the SHUTTLE ring to the right.
6. Repeat step 5 for the other three cameras. You cannot use the same camera number more than once in the same group.
7. Repeat steps 4-6 for SPLIT 4b, SPLIT 4c, and SPLIT 4d.
8. Turn the SHUTTLE ring to the left once to return to the MPX Display menu or twice to return to the Menu Setting Menu, or press the SET UP button to exit the programming mode.

### SPLIT 9 SCREEN SETTING (DX3016 Models Only)

In the Split 9 Screen Setting, you select which camera images to show in a nine-camera display. Two different groups of cameras can be defined.

Skip steps 1 and 2 if they have already been done.

1. Press the SET UP button to display the Menu Setting menu.
2. Turn the JOG dial to move the cursor next to MPX DISPLAY, and then turn the SHUTTLE ring to the right. The MPX Display menu appears.
3. Turn the JOG dial to move the cursor next to SPLIT 9 SCREEN SETTING, and then turn the SHUTTLE ring to the right. The Split9 Screen Setting menu appears.
4. Make sure the cursor is next to SPLIT9a, and then turn the SHUTTLE ring to the right. The top left number starts flashing.
5. Turn the JOG dial to display the desired camera number, and then turn the SHUTTLE ring to the right. The next camera number starts flashing. If you do not want to change the camera number, just turn the SHUTTLE ring to the right.
6. Repeat step 5 for the other eight cameras. You cannot use the same camera number more than once in the same group.
7. Repeat steps 4-6 for SPLIT 9b.
8. Turn the SHUTTLE ring to the left once to return to the MPX Display menu or twice to return to the Menu Setting Menu, or press the SET UP button to exit the programming mode.

## SPLIT 16 SCREEN SETTING (DX3016 Models Only)

Skip steps 1 and 2 if they have already been done.

1. Press the SET UP button to display the Menu Setting menu.
2. Turn the JOG dial to move the cursor next to MPX DISPLAY, and then turn the SHUTTLE ring to the right. The MPX Display menu appears.
3. Turn the JOG dial to move the cursor next to SPLIT 16 SCREEN SETTING, and then turn the SHUTTLE ring to the right. The Split16 Screen Setting menu appears.
4. Make sure the cursor is next to SPLIT16, and then turn the SHUTTLE ring to the right. The top left number starts flashing.
5. Turn the JOG dial to display the desired camera number, and then turn the SHUTTLE ring to the right. The next camera number starts flashing. If you do not want to change the camera number, just turn the SHUTTLE ring to the right.
6. Repeat step 5 for the other 15 cameras. You cannot use the same camera number more than once.
7. Turn the SHUTTLE ring to the left once to return to the MPX Display menu or twice to return to the Menu Setting Menu, or press the SET UP button to exit the programming mode.

## IMAGE QUALITY

It is possible to set the image quality when viewing multiple cameras.

Skip steps 1 and 2 if they have already been done.

1. Press the SET UP button to display the Menu Setting menu.
2. Turn the JOG dial to move the cursor to MPX DISPLAY, and then turn the SHUTTLE ring to the right. The MPX Display menu appears.
3. Turn the JOG dial to move the cursor to IMAGE QUALITY, and then turn the SHUTTLE ring to the right. The option flashes.  
  
HIGH: Fine details are visible.  
  
NO FLICKER: Screen flicker is reduced. Vertical resolution may be slightly degraded.
4. Turn the JOG dial to choose the option, and then turn the SHUTTLE ring to the right. The option stops flashing.
5. Do one of the following:
  - Turn the JOG dial to go to another item in this menu.
  - Turn the SHUTTLE ring to the left to return to the Menu Setting menu to go to another menu.
  - Press the SET UP button to exit the programming mode.

## SEQUENCE

Cameras can be sequenced individually, in groups of four cameras, or, for the DX3016 models only, in groups of nine cameras. Set all sequence patterns. These are the patterns that will be displayed when the SPLIT/SEQUENCE button is pushed (refer to the *Operation* section).

Skip steps 1 and 2 if they have already been done.

1. Press the SET UP button to display the Menu Setting menu.
2. Turn the JOG dial to move the cursor to MPX DISPLAY, and then turn the SHUTTLE ring to the right. The MPX Display menu appears.
3. Turn the JOG dial to move the cursor to SEQUENCE, and then turn the SHUTTLE ring to the right. The Sequence menu appears. The cursor is beside channel (camera) 1 in the nine-camera sequence.
4. Turn the JOG dial to select the desired channel number, and then turn the SHUTTLE ring to the right. The channel number starts flashing.
5. Turn the JOG dial until the desired channel number appears, and then turn the SHUTTLE ring to the right. The time starts flashing.
6. Turn the JOG dial to display the desired length of time that the camera's image will be shown before switching to the next camera, and then turn the SHUTTLE ring to the right. The option stops flashing.

The time can be set from 1 to 30 seconds.

7. Repeat steps 4, 5, and 6 to enter settings for the other cameras in the 9-camera or 16-camera sequence. The same camera can be entered in the sequence repeatedly. If you have a DX3016 model, turn the JOG dial when the cursor is on channel 9 to scroll to the next screen.
8. Turn the JOG dial to move the cursor to SPLIT 4, and then turn the SHUTTLE ring to the right. The option starts flashing.
9. Turn the JOG dial to select the pattern: ab or abc for DX3009 models and a, ab, abc, or abcd or DX3016 models. The letters a, b, c, and d refer to the Split 4 settings in the Split Screen Setting in the MPX Display menu.
10. Turn the SHUTTLE ring to the right. The time starts flashing.
11. Turn the JOG dial to display the desired length of time that the quad image will be shown before switching to the next quad display, and then turn the SHUTTLE ring to the right. The option stops flashing.

The time can be set from 1 to 30 seconds.

12. DX3016 Models Only – Repeat steps 8-11 to set the SPLIT9 settings. The two patterns are a and ab.
13. Turn the SHUTTLE ring to the left once (twice for DX3016 models) to return to the MPX Display menu or twice (three times for DX3016 models) to return to the Menu Setting menu, or press the SET UP button to exit the programming mode.

## CHANNEL TITLE (Displaying Camera Title and/or Number)

You can choose whether to display the camera (channel) title and/or camera number on the screen.

Skip steps 1 and 2 if they have already been done.

1. Press the SET UP button to display the Menu Setting menu.
2. Turn the JOG dial to move the cursor to MPX DISPLAY, and then turn the SHUTTLE ring to the right. The MPX Display menu appears.

3. Turn the JOG dial to move the cursor to CH.TITLE, and then turn the SHUTTLE ring to the right. The option starts flashing.

*NOTE: If the PRE A-REC field in the A-Rec/M-Det Setting menu has been set to SHORT, MEDIUM, or LONG, the option does not flash because it cannot be changed.*

4. Turn the JOG dial to select the option, and then turn the SHUTTLE ring to the right to finish setting.

Turning the JOG dial switches the title options as follows:

NONE, TITLE, CH. NO

NONE: Camera numbers and titles are not displayed.

TITLE: Camera numbers and titles are displayed.

CH. NO: Only camera numbers are displayed.

5. Do one of the following:
  - Turn the JOG dial to go to another item in this menu.
  - Turn the SHUTTLE ring to the left to return to the Menu Setting menu to go to another menu.
  - Press the SET UP button to exit the programming mode.

## ALARM DISPLAY

When the unit receives an alarm input signal, the monitor displays images from the camera with the alarm. If, during alarm recording, the recorder receives another alarm input signal, the monitor displays images from the latest alarm recording camera channel. (The display is single-camera mode.) The monitor returns to its original display mode after alarm recording is completed.

Skip steps 1 and 2 if they have already been done.

1. Press the SET UP button to display the Menu Setting menu.
2. Turn the JOG dial to move the cursor to MPX DISPLAY, and then turn the SHUTTLE ring to the right. The MPX Display menu appears.
3. Turn the JOG dial to move the cursor to ALARM DISPLAY, and then turn the SHUTTLE ring to the right. The option starts flashing.

*NOTE: If the PRE A-REC field in the A-Rec/M-Det Setting menu has been set to SHORT, MEDIUM, or LONG, the option does not flash because it cannot be changed.*

4. Turn the JOG dial to select ON or OFF, and then turn the SHUTTLE ring to the right. The option stops flashing.
5. Do one of the following:
  - Turn the JOG dial to go to another item in this menu.
  - Turn the SHUTTLE ring to the left to return to the Menu Setting menu to go to another menu.
  - Press the SET UP button to exit the programming mode.

## CAMERA TITLE

Titles can be added for each camera. In single-camera display mode, up to 16 characters can be displayed. In four-camera display mode, the first 8 characters are displayed. Titles cannot be displayed in nine-camera or sixteen-camera display mode. In addition, displayed titles do not get recorded.

Skip steps 1 and 2 if they have already been done.

1. Press the SET UP button to display the Menu Setting menu.
2. Turn the JOG dial to move the cursor to MPX DISPLAY, and then turn the SHUTTLE ring to the right. The MPX Display menu appears.
3. Turn the JOG dial to move the cursor to CAMERA TITLE, and then turn the SHUTTLE ring to the right.
4. Turn the JOG dial to the right to move the cursor next to camera number, and then turn the SHUTTLE ring to the right. The first character position of the TITLE setting flashes.

*NOTE: If the PRE A-REC field in the A-Rec/M-Det Setting menu has been set to SHORT, MEDIUM, or LONG, the option does not flash because it cannot be changed.*

DX3016 Models Only – The Camera Title menu has two screens. When the cursor is on camera 8, turn the JOG dial to the right to scroll to the next screen.

5. Turn the JOG dial to display the desired character, and then turn the SHUTTLE ring to the right to move to the next position.

Turning the SHUTTLE ring to the left erases the character.

6. Repeat step 5 to finish entering the word. To exit the TITLE row, move the flashing cursor to the right end, and then turn the SHUTTLE ring to the right.
7. Repeat steps 4-6 to enter other titles.
8. Turn the SHUTTLE ring to the left once (twice for DX3016 models) to return to the MPX Display menu or twice (three times for DX3016 models) to return to the Menu Setting menu, or press the SET UP button to exit the programming mode.

You cannot exit the menu if any TITLE character is flashing. Refer to step 6 to exit.

## POWER FAILURE

There is nothing to program in this screen. It lists power failures. Refer to *Power Failure* in the *Operation* section.

## RECORD

### IMAGE QUALITY

Skip steps 1 and 2 if they have already been done.

1. Press the SET UP button to display the Menu Setting menu.
2. Turn the JOG dial to move the cursor to NORMAL REC SETTING, and then turn the SHUTTLE ring to the right. The Normal Rec Setting menu appears.
3. Check that the cursor is next to IMAGE QUALITY, and then turn the SHUTTLE ring to the right. The Image Quality option starts flashing.

*NOTE: If the PRE A-REC field in the A-Rec/M-Det Setting menu has been set to SHORT, MEDIUM, or LONG, this field cannot be changed.*

4. Turn the JOG dial to select the option, and then turn the SHUTTLE ring to the right. The flashing stops.

Turning the JOG dial changes the image quality setting as follows:

BASIC, STANDARD, MEDIUM, HIGH, SUPERIOR

5. Do one of the following:
  - Turn the JOG dial to go to another item in this menu.
  - Turn the SHUTTLE ring to the left to return to the Menu Setting menu to go to another menu.
  - Press the SET UP button to exit the programming mode.

## MAXIMUM RECORDING FIELDS

Skip steps 1 and 2 if they have already been done.

1. Press the SET UP button to display the Menu Setting menu.
2. Turn the JOG dial to move the cursor to NORMAL REC SETTING, and then turn the SHUTTLE ring to the right. The Normal Rec Setting menu appears.
3. Turn the JOG dial and move the cursor to MAX REC FIELDS, and then turn the SHUTTLE ring to the right. The option starts flashing.

*NOTE: If the PRE A-REC field in the A-Rec/M-Det Setting menu has been set to SHORT, MEDIUM, or LONG, this field cannot be changed.*

4. Turn the JOG dial to select the option, and then turn the SHUTTLE ring to the right. The option stops flashing.

Turning the JOG dial changes the maximum recording fields as follows:

DX3009 Models – 1F, 3F, 5F, 7.5F, 15F, 30F

DX3016 Models – 1F, 3F, 5F, 6F, 7.5F, 10F, 15F, 30F

*NOTE: If the motion detection setting in the Initial Set Up menu is turned ON, option 30F is not available on the DX3009 models, and options 6F, 10F, and 30F are not available on the DX3016 models.*

Changing the recording setting changes the estimated recording time at the bottom of the screen. (The alarm recording setting does not affect the estimated recording time).

The available recording time changes depending on the settings of the image quality and maximum recording fields. The estimated recording time display will include all hard disk drives. The estimated time may not show the exact time if the recording interval was set too long. For available recording times, refer to the *Recording Time Table* section.

5. Do one of the following:
  - Turn the JOG dial to go to another item in this menu.
  - Turn the SHUTTLE ring to the left to return to the Menu Setting menu to go to another menu.
  - Press the SET UP button to exit the programming mode.

## SELECT RECORDING MODE

There are three recording modes: A, B, and C. For example, mode A might be used for daytime recording, mode B for nighttime recording, and mode C for weekend recording. The cameras that will record in each mode are selected in the next section, *Define Group*.

The settings made for image quality and maximum recording fields apply to all three modes.

Skip steps 1 and 2 if they have already been done.

1. Press the SET UP button to display the Menu Setting menu.
2. Turn the JOG dial to move the cursor to NORMAL REC SETTING, and then turn the SHUTTLE ring to the right. The Normal Rec Setting menu appears.
3. Turn the JOG dial to move the cursor to SELECT REC MODE, and then turn the SHUTTLE ring to the right. The option starts flashing.

*NOTE: When SHORT, MEDIUM, or LONG is selected in the PRE A-REC field in the A-Rec/M-Det Setting menu, the SELECT REC MODE field is automatically set to A-REC (Alarm Record) and cannot be changed.*

4. Turn the JOG dial to select mode A, B, or C, and then turn the SHUTTLE ring to the right. The option stops flashing.
5. Do one of the following:
  - Turn the JOG dial to go to another item in this menu.
  - Turn the SHUTTLE ring to the left to return to the Menu Setting menu to go to another menu.
  - Press the SET UP button to exit the programming mode.

## DEFINE GROUP

In the Define Group Setting menu selection, you choose which cameras will record during the mode (A, B, or C) that was picked in the Select Recording Mode field. A camera can be used in more than one mode.

Skip steps 1 and 2 if they have already been done.

1. Press the SET UP button to display the Menu Setting menu.
2. Turn the JOG dial to move the cursor to NORMAL REC SETTING, and then turn the SHUTTLE ring to the right. The Normal Rec Setting menu appears.
3. Turn the JOG dial to move the cursor to DEFINE GROUP SETTING, and then turn the SHUTTLE ring to the right. The Define Group menu appears.

*NOTE: If the PRE A-REC field in the A-Rec/M-Det Setting menu has been set to SHORT, MEDIUM, or LONG, the menu cannot be accessed.*

4. Turn the JOG dial to select the camera channel, and then turn the SHUTTLE ring to the right. The option starts flashing.

5. Turn the JOG dial to select the option, and then turn the SHUTTLE ring to the right. The option stops flashing.

Turning the JOG dial changes the priority setting as follows:

1, 2, 3, 4, 5, -

The - (hyphen) means that camera channel is turned off; that is, if a camera is connected to the DVR, it will not be recorded.

For camera channels with a Priority setting of 1-5, the recording interval set in maximum recording fields is divided according to the value entered in the Priority setting. The FILD (FIELDS) setting will vary according to this value.

*NOTE: When the AUDIO RECORDING setting in the Initial Set Up menu is ON, the only options available are 1 and -.*

6. Repeat steps 4 and 5 for other cameras. Every camera channel must have a priority setting; otherwise, you will not be able to exit the menu.
7. Turn the SHUTTLE ring to the left once to return to the Normal Rec Setting menu or twice to return to the Main Setting menu, or press the SET UP button to exit the programming mode.

## RS-232C COMMUNICATION

The recorder can be operated from a personal computer connected to the RS-232C terminal. These settings set the communication parameters.

Pelco does not offer equipment to support this function.

Skip steps 1 and 2 if they have already been done.

1. Press the SET UP button to display the Menu Setting menu.
2. Turn the JOG dial to move the cursor to COMMUNICATION SETTING, and then turn the SHUTTLE ring to the right. The Communication Setting menu appears.
3. Check that the cursor is next to RS-232C SETTING, and then turn the SHUTTLE ring to the right. The RS-232C Setting menu appears.
4. Check that the cursor is next to TRANSMISSION RATE, and then turn the SHUTTLE ring to the right. The option starts flashing.

*NOTE: If the PRE A-REC field in the A-Rec/M-Det Setting menu has been set to SHORT, MEDIUM, or LONG, the option does not flash because it cannot be changed.*

5. Turn the JOG dial to select the baud rate, and then turn the SHUTTLE ring to the right.

The options are 1200, 2400, 4800, and 9600.

6. Repeat steps 4 and 5 for the data bit length, parity, stop bit length, and delimiter.

The options for each field:

Data bit length: 7 or 8

Parity: None, odd, even

Stop bit length: 1 or 2

Delimiter: CR (carriage return) or CR•LF (carriage return and line feed)

7. Turn the SHUTTLE ring to the left once to return to the Communication Setting menu or twice to return to the Menu Setting menu, or press the SET UP button to exit the programming mode.



## SAVING MENU SETTINGS

Complex menu settings can be saved on a peripheral recording device connected to SCSI ID number 5. These settings also can be read by the recorder from the peripheral device.

### SAVING MENU DATA

If you have previously saved menu settings, saving them again will overwrite the current settings on the peripheral device.

1. Make sure the recorder is turned off.
2. Press and hold the ARCHIVE button, and then press the POWER button to turn the power on. Release the ARCHIVE button. The Quick Setting menu appears. The Power button blinks and the recorder will not perform any other functions until you complete this procedure.
3. Turn the JOG dial to select Menu Data Saving, and then turn the SHUTTLE ring to the right when "TURN THE SHUTTLE RING >> TO EXECUTE." appears on the screen.

*NOTE: If a peripheral device is not connected to ID5, the only option is POWER OFF. Turn the SHUTTLE ring to the right twice to turn off the power, and then turn the power back on.*

4. Turn the SHUTTLE ring twice to the right. "SAVING. . ." appears while the data is being saved, and "COMPLETED." appears when the process is finished.
5. Turn the SHUTTLE ring to the left. The "COMPLETED." message disappears.
6. Turn the JOG dial to select Power Off, and then turn the SHUTTLE ring to the right. The power is turned off.

### RESTORING MENU DATA

Copying menu settings from a peripheral device overwrites current menu settings in the recorder.

1. Make sure the recorder is turned off.
2. Press and hold the ARCHIVE button, and then press the POWER button to turn the power on. Release the ARCHIVE button. The Quick Setting menu appears. The Power button blinks and the recorder will not perform any other functions until you complete this procedure.
3. Turn the JOG dial to select Menu Data Loading, and then turn the SHUTTLE ring to the right when "TURN THE SHUTTLE RING >> TO EXECUTE." appears on the screen.

*NOTE: If a peripheral device is not connected to ID5, the only option is POWER OFF. Turn the SHUTTLE ring to the right twice to turn off the power, and then turn the power back on.*

4. Turn the SHUTTLE ring twice to the right. "LOADING. . ." appears while the data is being read, and "COMPLETED." appears when the process is finished.
5. Turn the SHUTTLE ring to the left. The "COMPLETED." message disappears.
6. Turn the JOG dial to select Power Off, and then turn the SHUTTLE ring to the right. The power is turned off.

## TCP/IP SETTING (DX3016 Models Only)

| This menu is not used.

## TIME AND DATE DISPLAY

### DISPLAY MODE

Skip steps 1 and 2 if they have already been done.

1. Press the SET UP button to display the Menu Setting menu.
2. Make sure the cursor is next to TIME DATE DISPLAY, and then turn the SHUTTLE ring to the right. The Time Date Display menu appears.
3. Make sure the cursor is next to DISPLAY MODE, and then turn the SHUTTLE ring to the right. The current option starts flashing.

- Turn the JOG dial to select 1-6, and then turn the SHUTTLE ring to the right. The option stops flashing. An example of the display mode appears on the screen, as shown in the chart below.

Display Mode	Display	Sample
1	Date, present time, and camera number	06-09-2000 11:39:10 C1
2	Date, day of the week, present time, recording interval, and camera number	06-09-2000 FRI 11:39:10 12.5F C1
3	Date, day of the week, present time, Recording interval, recording capacity of HDD, and camera number	06-09-2000 FRI 11:39:10 12.5F% 33
4	No indication (When alarm signal is input, date, day of the week, present time, and recording interval will be displayed.)	
5	No indication (When warning signal is received, warning indicator will be displayed.)	
6	No indication	

Display modes 2 to 5 are only available when single screen is displayed or CH. TITLE is set to NONE in the MPX Display menu. 01135

- Do one of the following:
  - Turn the JOG dial to go to another item in this menu.
  - Turn the SHUTTLE ring to the left to return to the Menu Setting menu to go to another menu.
  - Press the SET UP button to exit the programming mode.

## CHARACTER SIZE

Skip steps 1 and 2 if they have already been done.

- Press the SET UP button to display the Menu Setting menu.
- Make sure the cursor is beside TIME DATE DISPLAY, and then turn the SHUTTLE ring to the right. The Time Date Display menu appears.
- Turn the JOG dial to move the cursor to CHARACTER SIZE, and then turn the SHUTTLE ring to the right. The option starts flashing.
- Turn the JOG dial to select SMALL or LARGE, and then turn the SHUTTLE ring to the right. The option stops flashing.
- Do one of the following:
  - Turn the JOG dial to go to another item in this menu.
  - Turn the SHUTTLE ring to the left to return to the Menu Setting menu to go to another menu.
  - Press the SET UP button to exit the programming mode.

## CLOCK LOCATION

Skip steps 1 and 2 if they have already been done.

1. Press the SET UP button to display the Menu Setting menu.
2. Make sure the cursor is beside TIME DATE DISPLAY, and then turn the SHUTTLE ring to the right. The Time Date Display menu appears.
3. Turn the JOG dial until the cursor is next to CLOCK LOCATION, and then turn the SHUTTLE ring to the right. The option starts flashing.
4. Turn the JOG dial to select ON or OFF, and then turn the SHUTTLE ring to the right. If ON is selected, the monitor display switches to the display position setting screen.

ON can be selected when the CH. TITLE setting in the MPX Display menu is as follows:

- When set to NONE, the display position can be changed on single-camera, four-camera, nine-camera, and sixteen-camera displays.
- When set to CH.NO, the display position can be changed on single-camera displays only.

ON cannot be selected when the CH. TITLE setting in the MPX Display menu is set to TITLE.

5. If ON was selected, turn the JOG dial to move the display move to the desired position.

The display moves to the right when turning the JOG dial to the right. When the display reaches the right edge of the screen, it goes down to the next line.

The display moves to the left when turning the JOG dial to the left. When the display reaches the left edge of the screen, it goes up to the next line.

6. When the display reaches the desired position, turn the SHUTTLE ring to the right.

## TIME AND DATE SETTING

Skip steps 1 and 2 if they have already been done.

1. Press the SET UP button to display the Menu Setting menu.
2. Turn the JOG dial to select INITIAL SET UP, and then turn the SHUTTLE ring to the right. The Initial Set Up menu appears.
3. Make sure the cursor is next to TIME DATE ADJUST, and then turn the SHUTTLE ring to the right. The Time Date Adjust menu appears. The DAYLIGHT SAVING option is flashing.
4. Turn the JOG dial to select IN to activate the daylight saving function or OUT to deactivate the function. Turn the SHUTTLE ring to the right. The month starts flashing.
5. Turn the JOG dial to set the month, and then turn the SHUTTLE ring to the right. The Date starts flashing.
6. Repeat step 5 and set the year, hour, 10-minute digit, and minute digit.

Seconds cannot be set.

DAYLIGHT SAVING option will flash again when you turn the SHUTTLE ring to the right after setting the minute.

7. Turn the SHUTTLE ring to the left to enter the setting. The display returns to the Initial Set Up menu.

8. Do one of the following:
  - Turn the JOG dial to go to another item in this menu.
  - Turn the SHUTTLE ring to the left to return to the Menu Setting menu to go to another menu.
  - Press the SET UP button to exit the programming mode.

## TIMER RECORDING

When using the timer to start recording, the Define P1-P3 screens can be used to set different recording patterns.

Skip steps 1 and 2 if they have already been done.

1. Press the SET UP button to display the Menu Setting menu.
2. Turn the JOG dial to move the cursor to **TIMER PROGRAM**, and then turn the SHUTTLE ring to the right. The Timer Program menu appears.
3. Check that the cursor is next to **SELECTED PATTERN**, and then turn the SHUTTLE ring to the right. The option starts flashing.
4. Turn the JOG dial to the right to select the pattern (P1, P2, or P3) that will be used during timer recording, and then turn the SHUTTLE ring to the right. The option stops flashing.
5. Turn the JOG dial to move the cursor to **DEFINE P1** (or P2 or P3), and then turn the SHUTTLE ring to the right. The timer program appears.

<TIMER PROGRAM>				P1
	DW	START	END	MODE
1	---	---:--	---:--	-----
2	---	---:--	---:--	-----
3	---	---:--	---:--	-----
4	---	---:--	---:--	-----
5	---	---:--	---	-----
6	---	---:--	---	-----
7	---	---:--	---	-----
8	---	---:--	---	-----

SPECIAL DW:SUN-SAT

6. Check that the cursor is on Program 1, and then turn the SHUTTLE ring to the right to select the DW column.
7. Turn the JOG dial to select the day, and then turn the SHUTTLE ring to the right. The cursor moves to the column for the starting time.

Settings for the DW column:

- The days of the week from Sunday to Saturday (SUN-SAT)
- DAY (to record at the same time every day)
- SPL (to record on the days displayed at the bottom of the screen)

*NOTE: Turning the SHUTTLE ring to the left moves the cursor to the previous entry.*

8. Use the JOG dial to select the hour, and then turn the SHUTTLE ring to the right. The cursor moves to the 10-minute digit.

Time is displayed in 24-hour format.

9. Use the JOG dial to select the 10-minute time, and then turn the SHUTTLE ring to the right. The cursor moves to the minute digit.
10. Use the JOG dial to select the minute, and then turn the SHUTTLE ring to the right. The cursor moves to the column for the ending time.

11. Repeat steps 8-10 for the ending time.

A dot between the columns for the starting and ending times indicates that the recording time overlaps into the following day; for example, if you select 5 p.m. to 8 a.m.

12. Set the MODE column.

Use the JOG dial to select the option, and then turn the SHUTTLE ring clockwise.

Turning the JOG dial switches the options as follows:

A, B, C, SKIP, ARC, POWER

A, B, C: These are the recording modes. For more information, refer to *Select Recording Mode* in the *Record* section.

SKIP: The SKIP setting can be used to stop the recording temporarily. Recording will stop for the specified time frame, and the unit's main power will automatically turn off.

ARCHIVE: This setting is used for making back-ups of data stored in the unit's hard disk drive.

POWER: Used when alarm recording is set with the timer. This setting keeps the unit idle, but with the power on, during the specified time frame. Recording starts when

- An alarm is triggered at one of the ALARM IN connectors on the back of the recorder
- Motion is detected (refer to the next section, *Motion Detection During a Timer Recording*, to set up the motion detection option, which is available on DX3016 models only)

EJECT: (DX3016 Models Only) After backing up the recording contents of the hard disk drive to the backup device, the recording medium is ejected automatically.

13. If option A, B, or C was selected, the cursor moves to the field for setting the maximum recording fields. Use the JOG dial to select the desired interval, and then turn the SHUTTLE ring to the right.

Turning the JOG dial switches the options as follows:

DX3009 Models – 1, 3, 5, 7.5, 15, 30F

DX3016 Models – 1, 3, 5, 6, 7.5, 10, 15, 30

*NOTE: If the motion detection setting in the Initial Set Up menu is turned ON, option 30 is not available on the DX3009 models, and options 6, 10, and 30 are not available on the DX3016 models.*

14. To set other programs, repeat steps 6-13. Up to eight programs can be set per screen.

*NOTE: All fields in a program entry must be filled in before you can move to another entry line.*

*NOTE: To erase a program entry, press the WARNING RESET button. The cursor must be in the DW field.*

15. If you entered SPL in the DW column, set the days of the week as follows:

- a. Turn the JOG dial to move the cursor to select SPECIAL DW, and then turn the SHUTTLE ring to the right.
- b. Turn the JOG dial to select the beginning day, and then turn the SHUTTLE ring to the right.
- c. Turn the JOG dial to select ending day. The settings for the starting and ending days cannot be identical. Turn the SHUTTLE ring to the right. The flashing stops.

16. Turn the SHUTTLE ring to the left to return to the Timer Program menu. Repeat steps 3-15 to define other patterns.

17. When you finish defining patterns, do one of the following:

- Proceed to the next section (*Motion Detection During a Timer Recording*) to set up motion detection to operate during a timer recording (DX3016 models only).
- Turn the SHUTTLE ring to the left twice to return to the Menu Setting menu to go to another menu.
- Press the SET UP button to exit the programming mode.

When timer settings overlap, the unit will give priority to the higher-numbered program.

Example 1

- Program 1 is set for 14:00 to 17:00 with a recording interval of 3F.
- Program 2 is set for 15:00 to 16:00 with recording interval of 5F.

Under this condition, the unit will give priority to Program 2 for the duration of the overlapping period, from 15:00 to 16:00. The unit will operate as shown in the illustration below.

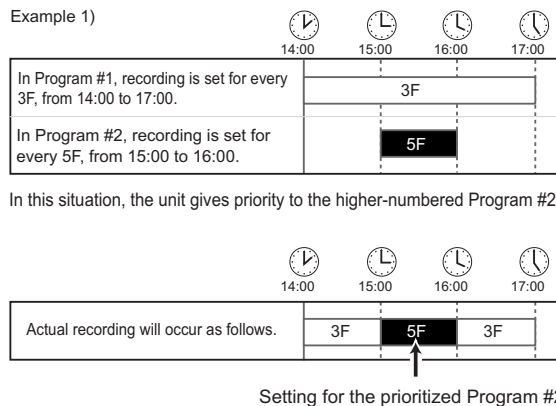

Example 2

- Program 1 is set for 14:00 to 17:00 with a recording interval of 3F.
- Program 2 is set for 15:00 to 16:00 with the SKIP setting.

Again, the unit will give priority to Program 2 for the duration of the overlapping period. As shown in the illustration below, the unit will activate the Skip setting from 15:00 to 16:00.

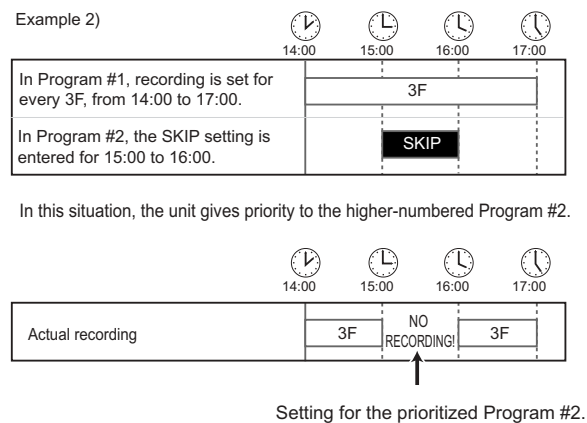

## MOTION DETECTION DURING A TIMER RECORDING (DX3016 Models Only)

This function allows you to set up motion detection to operate during a specified time period. Recording occurs, however, only if motion is detected.

1. Follow all the steps in the *Motion Detection* section to turn motion detection on and activate the desired cameras.
2. In the Normal Rec Setting menu, select the recording mode (A, B, or C) that you want to use for motion detection, and then define the group setting (select the cameras). Refer to the *Record* section for detailed instructions. The cameras you select must have their motion detection function activated (step 1).
3. Follow the steps in the previous section (*Timer Recording*) to schedule the timer program. In the MODE column, select POWER as the mode.
4. In the Timer Program menu, turn the JOG dial to select record mode A, B, or C under M-Det Application. This must be the same mode that you selected in step 2. Turn the SHUTTLE ring to the right. The option starts flashing. Turn the JOG dial to select ON. Turn the SHUTTLE ring to the right. The option stops flashing.
5. Turn the JOG dial to select REC MODE (POWER). Turn the SHUTTLE ring to the right. The option starts flashing. Turn the JOG dial to select ON. Turn the SHUTTLE ring to the right. The option stops flashing.
6. Do one of the following:
  - Turn the JOG dial to go to another item in this menu.
  - Turn the SHUTTLE ring to the left to return to the Menu Setting menu to go to another menu.
  - Press the SET UP button to exit the programming mode.

When the timer program is activated (refer to *Timer Recording* in the *Operation* section), the recorder goes into an idle state (it is on but not recording). When motion is detected, recording begins and continues until the motion stops. When motion stops, recording continues for the time set in the A-REC DURATION setting in the A-Rec/M-Det Setting menu.



## ESTIMATING RECORDING TIME

When using the Timer Program, there may be instances where, because of maximum recording fields, image quality, and audio recording settings, there is insufficient recording space on the unit's hard disk drive to complete the recordings as programmed.

When the maximum recording fields setting differs in the Normal Rec Setting menu and Timer Program menu, the possible recording duration will differ from the duration displayed in ESTD TIME field in the Normal Rec Setting menu.

When setting the timer for multiple programs, refer to the *DX3009 Recording Time Tables* section or *DX3016 Recording Time Tables* section to confirm the amount of hard disk space the recording duration will take up under different setting conditions.

Using the Timer Program settings below as an example of estimating possible recording duration, the chart below shows that everything is recorded on the sixth day, and on the seventh day only 1.1% of Program 2 content is recorded on the hard disk drive. (Conditions: Image Quality is set to HIGH, Audio Recording is set to OFF, built-in 30 GB hard disk drive.) The calculation is derived as follows: Program 1 uses 5.3% of the disk space per day. In six days it uses 31.8% (5.3 times 6). Program 2 uses 10.3% per day or 61.8% in six days (10.3 times 6). In six days 93.6% of the disk space has been used (31.8 plus 61.8). This leaves 6.4% available at the beginning of day seven. After Program 1 finishes recording only 1.1% is left for Program 2 (6.4 minus 5.3).

<TIMER PROGRAM>					P1
1	DW	START	END	MODE	
1	DAY	12:00	13:00		
▶	DAY	16:00	22:00		
3					

00509

Program	Recording time for one day (A)	Possible duration for Consecutive Recording (B)	HDD recording space (A/B)
1	1 hour ( 60 minutes)	19 hour (1140 minutes)*	5.3%
2	6 hour ( 360 minutes)	58 hour (3480 minutes)**	10.3%

\* The recording time is obtained from the DX30009 Recording Time Tables in the back of the manual. The figure is found in the first table under high image quality at 15 fields per second (19h).

\*\* The recording time is obtained from the DX30009 Recording Time Tables in the back of the manual. The figure is found in the first table under high image quality at 5 fields per second (2D10h).

01138

## OPERATION

Press the POWER button on the front of the recorder to turn on the unit. Video from all nine cameras appears on the monitor.

The time and date display may appear on the screen, depending on the setting of the Display Mode in the Time Date Display menu (refer to *Time and Date Display* in the *Programming* section). The different types of displays are shown below.

Display Mode	Display	Sample
1	Date, present time, and camera number	06-09-2000 11:39:10 C1
2	Date, day of the week, present time, recording interval, and camera number	06-09-2000 FRI 11:39:10 12.5F C1
3	Date, day of the week, present time, Recording interval, recording capacity of HDD, and camera number	06-09-2000 FRI 11:39:10 12.5F 50% C1
4	No indication (When alarm signal is input, date, day of the week, present time, and recording interval will be displayed.)	
5	No indication (When warning signal is received, warning indicator will be displayed.)	
6	No indication	

Display modes 2 to 5 are only available when single screen is displayed or CH. TITLE is set to NONE in the MPX Display menu.

01135

Below is a description of the time and date display when the display mode is set to 3.

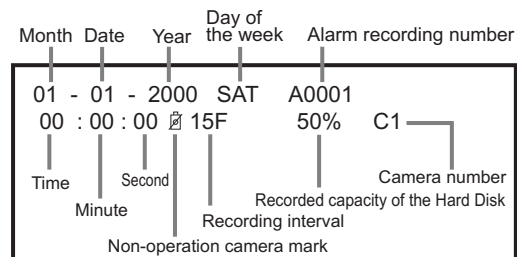

The camera number does not appear if CH. TITLE is set to NONE in the MPX Display menu.

The alarm recording number is displayed during alarm recording.

If you select a camera that is not programmed to be recorded, an icon appears showing a camera with a line through it. Cameras are programmed in the Define Group Setting menu (refer to *Record* in the *Programming* section).

The amount of space used in the hard drive is displayed during recording. When recording is stopped, this figure is not displayed. (It remains displayed during pause.) When recording is started again, this figure reappears after a few moments. The % symbol will flash when the designated amount of space remaining on the storage medium has been reached (refer to *Capacity Remaining* in the *Programming* section). The % symbol will flash only when one camera is displayed on the monitor, not when multiple cameras are being shown.

The recorder can display dates from January 1, 2000 to December 31, 2030. It also has a built-in function to calculate leap years automatically. After December 31, 2030, the date indicator will return to 2000.

The on-screen clock can be reset to the nearest hour by applying a signal to the CLOCK ADJ terminal. For example, if the current time is 11:29:59, it will be reset to 11:00:00, and if the current time is 11:30:00, it will be reset to 12:00:00.

## VIEWING CAMERAS

*NOTE: You cannot operate the CAMERA buttons when a menu is displayed on the screen. The buttons do not work when the recorder is accessing a peripheral recording device or the ARCHIVE, COPY, or PLAY button is flashing.*

Press the CAMERA buttons (1-9) buttons to view images from cameras connected to CAMERA IN terminals at the rear of the recorder. If there is no video from a camera, or no camera is connected, the screen is blue. If the camera is not programmed for recording, the non-operational camera icon appears on the screen (display modes 1-3). Cameras are programmed in the Define Group Setting menu (refer to *Recording* in the *Programming* section). You can still view the picture from the camera even it is not programmed to be recorded.

### SPLIT/SEQUENCE BUTTON

*NOTE: You cannot operate the SPLIT/SEQUENCE button when a menu is displayed on the screen. The button does not work when the recorder is accessing a peripheral recording device or the ARCHIVE, COPY, or PLAY button is flashing.*

By pressing the SPLIT/SEQUENCE button, you can switch the display mode as follows:

DX3009 Models	DX3016 Models
Nine cameras	Sixteen cameras
Four cameras (group A)	Nine cameras (group A)
Four cameras (group B)	Nine cameras (group B)
Four cameras (group C)	Four cameras (group A)
Single-camera sequencing*	Four cameras (group B)
Four-camera group sequencing*	Four cameras (group C)
	Four cameras (group D)
	Single-camera sequencing*
	Four-camera group sequencing*
	Nine-camera group sequencing*

\* The SPLIT/SEQUENCE button lights.

The refresh cycle of camera images becomes longer as the number of cameras increases. Smoother images can be viewed when cameras that are not needed are removed from the cameras designated in the Define Group Setting menus (refer to *Alarms* and *Recording* in the *Programming* section).

Images are displayed in real time during single-camera display.

Pressing the SPLIT/SEQUENCE button during playback switches the split display options as follows:

DX3009 Models	DX3016 Models
Nine cameras	Sixteen cameras
Four cameras (group A)	Nine cameras (group A)
Four cameras (group B)	Nine cameras (group B)
Four cameras (group C)	Four cameras (group A)
	Four cameras (group B)
	Four cameras (group C)
	Four cameras (group D)

You can view any picture in actual screen size by pressing the camera number button. You can go back to the previous split display by pressing the SPLIT/SEQUENCE button again.

If camera numbers are shown on the screen during sequencing of groups of four or nine cameras, "-" appears instead of the camera number if the camera's operation has been turned off in the Define Group setting in the Normal Rec Setting menu.

If camera numbers are part of the time and date display, the display is shown only in Mode 1 when more than one camera appears on the screen.

If a camera is not programmed for recording, the screen for that camera is black. If there is no video (camera is not turned on or is not connected), the screen for that camera is blue.

## ZOOM BUTTONS

*NOTE: You cannot operate the ZOOM buttons when a menu is displayed on the screen. The buttons do not work when the recorder is accessing a peripheral recording device or the ARCHIVE, COPY, or PLAY button is flashing.*

1. Display the Zoom Pointer (X) by pressing the ZOOM button.
2. Move the pointer to the desired position by pressing the camera number buttons 6 to 9. The picture will be enlarged/reduced from the center of the pointer.
3. Press the 4 button once to make the picture twice as large as the original picture size. Press the button a second time to make the picture four times as large. The zoom ratio appears in the top left-hand corner of the screen. As the zoom function is digital, details of the image appear pixelized when enlarged. After enlarging the picture, you can move the whole picture by pressing the 6-9 buttons.
4. After enlarging the picture, press the 5 button to reduce it.

The zoom pointer's position does not change when the display screen changes or when power is turned off. This is convenient for situations where the desired viewing areas, such as a counter or cash register, are determined in advance. In addition, the zoom pointer can be used during playback of recorded images.

When playing back images from multiple cameras on a single screen, if the zoom control is used during the pause mode, there is a possibility that a black screen will be displayed. In this case, the desired enlarged image can be obtained by moving through frames using the JOG dial.

The zoom function is deactivated if the ALARM IN terminal is triggered.

## REMOTE VIEWING

Camera images can be viewed from a remote site using a PelcoNet Transmission System.

To view images remotely, refer to separate documentation that accompanies PelcoNet.

## RECORDING

### BASIC RECORDING

1. Press a camera number button and verify that there is video.
2. Press the REC button. The REC button lights and recording starts.

If you press the PAUSE button during recording, recording will pause. To resume recording, press the PAUSE button again. (The PAUSE button only works when MAIN is selected as a playback device. Press the PLAY DEVICE button to select MAIN.)

A warning appears during recording if there is no input signal from the selected camera channel (refer to the *Warnings* section.) In addition, select " - " in the Define Group menu for those cameras with no input (refer to *Record, Define Group* in the *Programming* section). If the unit is operated without this " - " setting, there may be occasions during split-screen viewing when an image from another screen will appear in a channel without an input signal.

The HDD FULL setting determines the operation of the recorder when the hard disk is full. Refer to *HDD (Hard Disk Drive) Repeat Recording* in the *Programming* section.

If multiple recorders are connected in series, when the storage capacity of the one unit's memory reaches a pre-specified level, the next unit begins recording. Through this exchange, recording continues uninterrupted.

3. Press the STOP button to stop recording. The REC button light goes out.

## ALARM RECORDING

Alarm recording commences upon either of the following conditions:

- An ALARM IN terminal is triggered by an alarm sensor
- A camera detects motion

When there is an alarm:

- 1) The recorder switches to its preset recording intervals. Refer to *Alarms* in the *Programming* section for alarm settings.
- 2) An index signal is automatically stored in memory when alarm recording begins. Refer to the *Playback* section for reviewing alarm recordings using the index search.
- 3) If the unit receives a new alarm signal while in the alarm recording mode, the unit completes the alarm recording session initiated by the new signal.
- 4) If the unit receives an alarm signal at an ALARM IN terminal while settings are being made on the on-screen menus, the unit exits the menu screen and begins alarm recording.
- 5) The unit stores a data entry in an Alarm List of the time it receives the alarm signal. Refer to the *Playback* section for reviewing images from the Alarm List.
- 6) Regardless of the display mode, camera number buttons flash for those cameras making alarm recordings. The Alarm Recording indicator flashes on and off during alarm recording and stays on at the completion of alarm recording. If the DISPLAY MODE is set for values other than 5 or 6, an Alarm Recording number will automatically appear on-screen while the unit is running in alarm recording mode. The maximum Alarm Recording number is 9999.



At the end of alarm recording, the unit returns to the same recording intervals that were in effect before the alarm recording.

When in the alarm recording mode, the unit records for the entire alarm recording duration even if the end-time specified in a timer program has been exceeded. Alarm recording also continues as long as motion is detected within the active area established for motion detection. When motion stops, alarm recording continues for the time set in the A-REC DURATION setting.

There may be cases when the recorder's built-in motion detection function does not operate properly due to the condition of the input video signal or other factors. There may be such operation errors when the recorder is connected to a system that uses the recorder's detection function to send a warning signal.

If the recorder is programmed for pre-alarm recording, pre-alarm recordings are made of all cameras since it is not known which camera will have an alarm. After an ALARM IN terminal is triggered, however, only those cameras designated in the RECORD ALARM setting will make alarm recordings. This means that during playback the number of cameras displayed may differ for pre-alarm and post-alarm recording.

## TIMER RECORDING

1. Select the timer program (P1, P2, or P3) that you want to use for recording. Refer to *Timer Recording* in the *Programming* section.
2. Press the TIMER REC button. The TIMER REC indicator illuminates. If the current time is covered by a program, the unit begins recording immediately. If the current time is not covered by a program, the unit turns the power off and goes into standby mode.
3. To stop timer recording, press the TIMER REC button once more.

*NOTE: If PRE A-REC has been set to SHORT, MEDIUM, or LONG in the A-Rec/M-Det Setting Menu, the recorder will use the alarm recording settings to make timer recordings, even though there is no alarm signal when recording starts.*

## PLAYBACK

### BASIC PLAYBACK

1. Turn on the power of the connected peripheral recording device, if any, and then turn on this recorder.
2. Press the PLAY DEVICE button on the front panel to select the playback device. The indicator of the selected device illuminates. (The indicator will not light when a peripheral recording device is not connected.)
3. Press the PLAY button.

*NOTE: When playing back from a DDS device, there will be a few minutes delay in playback and eject, depending on the condition of the recording.*

The oldest recording on the hard disk is played back when you press the PLAY button for the first time after the power is turned on for the first time after you stop recording

The newest recording on the hard disk is played back (in the reverse direction) when you press the REV PLAY button for the first time after the power is turned on for the first time after you stop recording

After the first time, subsequent pressing of the PLAY or REV PLAY buttons will resume playback from the point where it was stopped.

When recording more than one camera, the playback interval per camera will be the frames per second multiplied by the number of cameras. A recording interval of 15 frames equals one second.

- Single camera: The screen changes frame-by-frame at a rate equal to the recording interval multiplied by the number of cameras used in the recording.
- Four cameras: Each camera changes frame-by-frame at a rate equal to the recording interval multiplied by the number of cameras used in the recording. The display shifts to still-frame mode during playback from a camera that is not indicated.
- Nine and sixteen cameras: Each camera changes frame-by-frame at the recorded rate. The display shifts to still-frame mode during playback from a camera that is not indicated.

Playback will stop automatically at the end of the hard disk (if extra hard disk drives are installed, playback will stop at the end of the hard disk drive with the highest ID number) or the end of the recorded part when the HDD PB REPEAT field in the Initial Set Up menu is set to OFF. The recorded data is played back repeatedly when the HDD PB REPEAT field is set to REPEAT. Refer to *Hard Disk Drive (HDD) Repeat Playback* in the *Programming* section.

4. Press the STOP button to stop playback.
5. Press the EJECT button to eject the medium from a copy or archive device.

*NOTE: Also refer to the section on Playback on Another Device.*

## FRAME-BY-FRAME (STILL FRAME) PLAYBACK

1. Press the PAUSE button during playback. The unit shifts into still-frame mode.
2. If the screen shows more than one camera, you can view a full-screen view of a single camera by pressing the CAMERA button for that camera.
3. Turn the JOG dial in either direction during still-frame playback.

Turn the JOG dial one stop to the right to move forward one frame and one stop to the left to move back one frame. Continue turning the JOG dial to the right for forward playback of consecutive frames and to the left for reverse playback of consecutive frames. Stop turning the dial for still-frame viewing.

The PLAY button lights when moving in the forward direction, and the REV PLAY button lights when moving in the reverse direction.

If you switch directions, the first stop reverses the direction, as indicated by the lights changing on the PLAY and REV PLAY buttons, but the video does not move. When you turn the JOG dial to the next stop, the video moves forward or backward one frame.

4. Press the PAUSE button again to resume playback in the forward or reverse direction, depending on whether the PLAY or REV PLAY button is lit. Or, press the PLAY or REV PLAY button to exit the pause mode and resume playback in the desired direction.

## PAUSE PLAYBACK

1. Press the PAUSE button to pause playback.
2. Press the PAUSE button again to resume playback.

## REVERSE PLAYBACK

Press the REV PLAY button when the unit is not in operation. The unit begins reverse playback.

On the first reverse playback after the power switch is turned on or after recording, the unit starts by displaying the last recorded image.

## ADJUSTING PLAYBACK SPEED

The SHUTTLE ring can be used to adjust the playback speed. Playback speed will vary according to how far the SHUTTLE ring is turned.

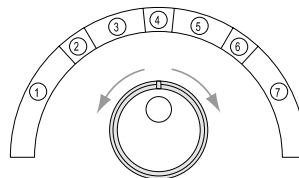

- ① Reverse speed search (1MB units)
- ② Reverse speed search (5X speed)
- ③ Reverse speed search (3X speed)
- ④ Regular or still-frame playback
- ⑤ Forward speed search (3X speed)
- ⑥ Forward speed search (5X speed)
- ⑦ Forward speed search (1MB units)

01129

## Regular Playback Mode

1. Turn the SHUTTLE ring to the desired playback speed while the recorder is in playback or reverse playback.

When playing back images recorded at different recording intervals, there may be rare occasions when the playback speed differs from the original recording rate.

2. The unit shifts to regular playback mode when the SHUTTLE ring is returned to the center position.

## Still-Frame Playback Mode

1. Press the PAUSE button while the recorder is in playback or reverse playback. The unit shifts to still-frame playback mode.
2. Turn the SHUTTLE ring to the desired playback speed.
3. The unit shifts to still-frame playback mode when the SHUTTLE ring is returned to the center position.

## Shuttle Hold

Pressing the PAUSE button during playback (or reverse playback) shifts the recorder into still-frame mode. Rotate the SHUTTLE ring to the desired search speed, and then press the PAUSE button while holding the SHUTTLE ring at the selected search speed. Search speed will be maintained even when the SHUTTLE ring is returned to its original position.

## CHANGING PLAYBACK INTERVAL

When the PLAY or REV PLAY button is pressed when the unit is not in operation, playback occurs at the same intervals as the recording intervals. Playback intervals can be changed, however, when the PLAY or REV PLAY button is pressed while the unit is in playback or reverse playback operation. This is a convenient function for slow viewing of recordings with fast movement or fast playback of images captured at long recording intervals.

Playback or reverse playback intervals speed up when the PLAY button is pressed.

Playback or reverse playback intervals slow down when the REV PLAY button is pressed.

If the time and date display is in Mode 2 or 3 (refer to *Time and Date Display* in the *Programming* section), you can verify the change by observing the playback interval (number followed by an F) in the display.

An audio recording cannot be played when the playback interval has been altered, even if the playback interval is returned to its original rate. To play back an audio recording, stop playback and restart it at the original rate.

## FAST FORWARD/REWIND

When the SHUTTLE ring is turned clockwise or counterclockwise for more than one second when the recorder is not recording, the unit shifts into high-speed fast-forward or high-speed rewind mode, and an indicator appears at the bottom left of the monitor. "S" denotes the start point of the data stored in the hard disk and "E" denotes the end point. The vertical line marks the current position.

Press the STOP button to stop the fast forward or rewind operation.

## SEARCHING

### Time and Date Search

1. Press the SEARCH button to display the Search Selection menu.
2. Make sure the cursor is next to SELECTION CAMERA NO., and then turn the SHUTTLE ring to the right. The option starts flashing.
3. Turn the JOG dial to select the option, and then turn the SHUTTLE ring to the right. The option stops flashing.

Turning the JOG dial switches the options as follows:

DX3009 Models – ALL, 1, 2, 3, 4, 5, 6, 7, 8, 9

DX3016 Models – ALL, 1, 2, 3, 4, 5, 6, 7, 8, 9, 10, 11, 12, 13, 14, 15, 16

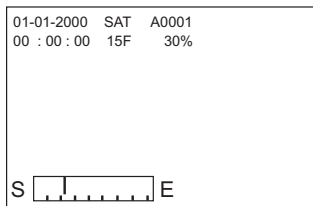



4. Turn the JOG dial to move the cursor beside TIME DATE SEARCH, and then turn the SHUTTLE ring to the right. The Time Date Search menu appears and the month number starts flashing.

*NOTE: If the PRE A-REC field in the A-Rec/M-Det Setting menu has been set to SHORT, MEDIUM, or LONG, the menu cannot be accessed.*

To exit the Time Date Search menu without activating the search, press the SEARCH button on the front of the unit.

5. Turn the JOG dial to set the month. Turn the SHUTTLE ring to the right. The next item starts flashing.
6. Repeat step 3 to set the date, year, hour, 10-minutes digit, minute digit, 10-seconds digit, and second digit. The option OFF starts flashing.
7. Turn the JOG dial to select ON.
8. Turn the SHUTTLE ring to the right. The time date search starts and pauses the playback display at the specified time point (or the nearest point from the specified time). The searched image appears in a 9-camera display (DX3009 models) or 16-camera display (DX3016 models) if ALL was selected or on a single screen if an individual camera was selected. The PLAY and PAUSE buttons light.

If there is no recording or no data that is recorded on the date you have set, the time-date search will not be activated and the month number will start flashing again.

If there is no data that is recorded at the time you have set, the image that is recorded at the nearest time from the time you have set will be displayed on the paused screen.

The time date search function may not work correctly depending on the condition of the recording.

To change the 9-camera display (DX3009 models) or 16-camera display (DX3016 models) to a single camera, press the CAMERA number button on the front of the recorder.

9. Press the PLAY or PAUSE button to play back the searched image.
10. Press the STOP button to stop playback and exit the search function.

## Index Search

During alarm recording, an index signal is automatically written onto the hard disk. Index search is a process of retrieving still frames using their associated index signal.

The index count can be set, as desired, up to 99.

1. Press the SEARCH button to display the Search Selection menu.
2. Make sure the cursor is next to SELECTION CAMERA NO., and then turn the SHUTTLE ring to the right. The option starts flashing.
3. Turn the JOG dial to select the option, and then turn the SHUTTLE ring to the right. The option stops flashing.

Turning the JOG dial switches the options as follows:

DX3009 Models – ALL, 1, 2, 3, 4, 5, 6, 7, 8, 9

DX3016 Models – ALL, 1, 2, 3, 4, 5, 6, 7, 8, 9, 10, 11, 12, 13, 14, 15, 16

4. Turn the JOG dial to move the cursor to INDEX SEARCH, and then turn the SHUTTLE ring to the right. The Index Search menu appears.

*NOTE: If the PRE A-REC field in the A-Rec/M-Det Setting menu has been set to SHORT, MEDIUM, or LONG, the menu cannot be accessed.*

5. Turn the JOG dial to display the desired index count.

- Turn the SHUTTLE ring in the desired search direction.

The present position in the diagram below represents the point of playback or stopped playback. To search for an index with a "+", turn the SHUTTLE ring to the right to search forward. To search for an index with a "-", turn the SHUTTLE ring to the left to search backward.

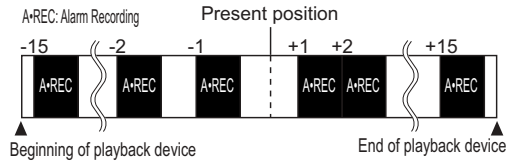

The index search begins, and images appear in a 9-camera display (DX3009 models) or 16-camera display (DX3016 models) if ALL was selected or on a single screen if an individual camera was selected. The PLAY and PAUSE buttons light.

*NOTE: When using DDS tape, index searches can be done in the forward direction only.*

- Press the SEARCH button to clear the Search menu from the screen.
- To change the 9-camera display (DX3009 models) or 16-camera display (DX3016 models) to a single-camera display, press the CAMERA number button on the front of the recorder. The display for the single camera appears.
- Press the PLAY or PAUSE button to play back the searched image.
- Press the STOP button to stop playback and exit the search function.

### Skip Search

Skip search is a process in which the unit automatically searches for an index signal, and then retrieves the visuals associated with that index and plays back the images for five seconds each.

- Press the SEARCH button to display the Search Selection menu.
- Make sure the cursor is next to SELECTION CAMERA NO., and then turn the SHUTTLE ring to the right. The option starts flashing.
- Turn the JOG dial to select the option, and then turn the SHUTTLE ring to the right. The option stops flashing.

Turning the JOG dial switches the options as follows:

DX3009 Models – ALL, 1, 2, 3, 4, 5, 6, 7, 8, 9

DX3016 Models – ALL, 1, 2, 3, 4, 5, 6, 7, 8, 9, 10, 11, 12, 13, 14, 15, 16

- Turn the JOG dial to move the cursor to SKIP SEARCH, and then turn the SHUTTLE ring to the right. The Skip Search menu appears.

*NOTE: If the PRE A-REC field in the A-Rec/M-Det Setting menu has been set to SHORT, MEDIUM, or LONG, the menu cannot be accessed.*

- Turn the SHUTTLE ring in desired direction (forward search to the right and reverse to the left). The unit begins the index search and plays back the images associated with the index for five seconds each.

Images appear in a 9-camera display (DX3009 models) or 16-camera display (DX3016 models) if ALL was selected or on a single screen if an individual camera was selected.

The image cannot be changed from a 9-camera display (DX3009 models) or 16-camera display (DX3016 models) to a single-camera display.

Depending on the recording condition of the index signal, there might be occasions when skip search cannot be performed.

- Press the STOP button to stop searching.

## Alarm List Search

The Alarm List search retrieves alarm video at the time an alarm occurred. It does not retrieve pre-alarm recording if the pre-alarm recording option was turned on (PRE A-REC field in the A-Rec/M-Det Setting menu).

Up to 500 alarm times (DX3009 models) or 800 alarm times (DX3016 models) can be stored in the alarm list. After the 500th time (DX3009 models) or 801st time (DX3016 models), the first alarm time is erased and the 501st (or 801st) alarm time is added to the list.

1. Press the SEARCH button to display the Search Selection menu.
2. Make sure the cursor is next to SELECTION CAMERA NO., and then turn the SHUTTLE ring to the right. The option starts flashing.
3. Turn the JOG dial to select the option, and then turn the SHUTTLE ring to the right. The option stops flashing.

Turning the JOG dial switches the options as follows:

DX3009 Models – ALL, 1, 2, 3, 4, 5, 6, 7, 8, 9

DX3016 Models – ALL, 1, 2, 3, 4, 5, 6, 7, 8, 9, 10, 11, 12, 13, 14, 15, 16

4. Turn the JOG dial to move the cursor to ALARM LIST SEARCH, and then turn the SHUTTLE ring to the right to display the Alarm List Search menu.
5. Turn the JOG dial until the cursor is at the desired alarm list number. When the cursor reaches either the top or the bottom of the list, the Alarm List Search menu scrolls to the next page. To move through the pages, place the cursor over “No.”, and then turn the SHUTTLE ring.
6. Turn the SHUTTLE ring to the right. The unit begins the alarm list search and retrieves the image associated with the selected time.

*NOTE: If the PRE A-REC field in the A-Rec/M-Det Setting menu has been set to SHORT, MEDIUM, or LONG, the search cannot be done.*

Images appear in a 9-camera display (DX3009 models) or 16-camera display (DX3016 models) if ALL was selected or on a single screen if an individual camera was selected. The PLAY and PAUSE buttons light.

7. Press the SEARCH button to clear the Alarm List from the screen.
8. To change the 9-camera display (DX3009 models) or 16-camera display (DX3016 models) to a single-camera display, press the CAMERA number button on the front of the recorder. The display for the single camera appears.
9. Press the PLAY or PAUSE button to play back the searched image.
10. Press the STOP button to stop playback and exit the search function.

## Jump to Starting Point

Select this option to play back the oldest recorded data.

1. Press the SEARCH button to display the Search Selection menu.
2. Turn the JOG dial to move the cursor to JUMP TO START POINT, and then turn the SHUTTLE ring to the right. The Jump to Start Point screen appears.
3. Turn the SHUTTLE ring to the right. The recorder displays the oldest recordings on a 9-camera screen (DX3009 models) or 16-camera screen (DX3016 models). The PLAY and PAUSE buttons light.
4. To change the 9-camera display (DX3009 models) or 16-camera display (DX3016 models) to a single-camera display, press the CAMERA number button on the front of the recorder. The display for the single camera appears.

5. Press the PLAY or PAUSE button to play back the searched image.
6. Press the STOP button to stop playback and exit the search function.

### PLAYBACK ON ANOTHER DEVICE

Data recorded on an external copying or archiving device can be played back on a personal computer or laptop computer.

1. Make sure the PC or laptop computer has the DX3016RX Remote Viewing Software installed on it. The software was supplied with your DX3000 Series recorder or can be downloaded from Pelco's website at Pelco.com.
2. Connect the external copying or recording device to the PC or laptop computer.

## BACKING UP DATA

The recorder can back up data which is recorded on the hard disk drive. You can back up data previously recorded data at the same time the DVR is recording new data (refer to the section on *Simultaneous Recording and Backup*).

There are two ways to make copies:

Using the ARCHIVE button

Using the COPY button

### USING THE ARCHIVE BUTTON

*NOTE: If you use the ARCHIVE button, the peripheral recording device must be assigned to SCSI ID number 4.*

#### Start Copying

Press the ARCHIVE button. The button starts blinking. While the light is blinking, the archiving process is being set up. This may take several minutes. When the light remains on, the backup is in progress.

When the ARCHIVE button is pressed, the recorder makes backups after the point indicated by the Archive Pointer. If the Archive Overwrite setting is OFF, the backup process will not overwrite data already recorded on the storage medium. If ON, data previously recorded on the storage medium will be overwritten and erased. Refer to *Archive, Overwrite* in the *Programming* section.

The position of the Archive Pointer will not be erased when the unit's main power switch is turned off. To reset the position of the pointer, refer to *Archive Pointer Reset* in the *Programming* section.

#### Stop Copying

Press the ARCHIVE button. The button blinks while the archiving process is halted. If the Auto Eject setting is ON, the medium is automatically ejected at the end of the process. The Archive Pointer is repositioned to where operation was stopped, and the next backup recording will begin at this point.

#### Timer Backup

Timer backup is a method for using the timer to perform archive backup. The timer can be used to archive data in the main hard disk drive that has not yet been backed up. The unit can archive data even if it is currently in the process of timer recording.

Refer to *Timer Recording* in the *Programming* section to program the recorder. In the Mode setting, select ARC.

The recorder makes backups on the archive device after the point indicated by the Archive Pointer if the ARCHIVE OVERWRITE setting is OFF. If ON, data previously recorded on the storage medium will be overwritten and erased. Refer to *Archive, Overwrite* in the *Programming* section.

## Auto-Eject at the Completion of Backup

The archive medium will be automatically ejected under the following conditions:

When the archive medium becomes full during archive backup. Refer to *Auto Eject* in the *Programming* section.

When the archive medium becomes full during timer backup. Refer to *Auto Eject* in the *Programming* section.

When the ARCHIVE button is pressed again, after operation was started with the ARCHIVE button.

When a recording malfunction, medium error, or system error occurs during backup operation.

## USING THE COPY BUTTON

*NOTE: If you use the COPY button, the peripheral recording device must be assigned to SCSI ID number 5.*

1. Make sure that the peripheral recording device is connected and set correctly.
2. Turn on the power of the peripheral recording device.
3. Turn on the power of the recorder.
4. Insert a copying medium into the archive device or copy device.
5. Press the COPY button. The Copy Selection menu appears.
6. Make sure that the cursor is next to COPY DIRECTION, and then turn the SHUTTLE ring to the right. The option starts flashing.
7. Use the JOG dial to choose copy direction (HDD to COPY), and then turn the SHUTTLE ring to the right. The option stops flashing.
8. Turn the JOG dial to move the cursor to OVERWRITE, and then turn the SHUTTLE ring to the right. The option starts flashing.
9. Turn the JOG dial to select ON or OFF, and then turn the SHUTTLE ring to the right. The option stops flashing.

ON: Copying starts at beginning of the medium, overwriting previously recorded data.  
OFF: Copying starts at the end of the recorded part of the medium.

10. Turn the JOG dial to move the cursor next to TRANSFER PERIOD, and then turn the SHUTTLE ring to the right. The option starts flashing.
11. Turn the JOG dial to select MAN or S/E, and then turn the SHUTTLE ring to the right. The option stops flashing.

MAN: Set the starting and ending times for copying in the next step.  
S/E: Copy all data from the device which is recognized as a device to copy from.

12. Set the starting and ending times.

If S/E was selected in the previous step, the starting and ending times of the data recorded on the hard disk are displayed. There may be instances where it takes time for the peripheral device to collect the copy starting and ending times from the main unit. When the times are displayed, press the COPY button to enter the copy range automatically. This does not mean, however, that the copy function has been started.

If MAN was selected, the recorder will execute the copy function at a range slightly larger than the starting and ending settings.

- a. Turn the JOG dial to move the cursor to the start time.

- b. Use the JOG dial and SHUTTLE ring to set the month, date, year, hour, minute, and second of the starting time.
- c. Turn the JOG dial to move the cursor to the stop time.
- d. Use the JOG dial and SHUTTLE ring to set the month, date, year, hour, minutes, and second of the ending time.

If the copy range exceeds the amount of available storage space in the copy medium, the recorder issues a size error warning during the copy operation. In this case, either reset the copy range or replace the copy medium. Limits to the copy range can be established by first selecting S/E to find the starting and ending times; then the manual settings can be made.

- 13. Turn the JOG dial to move the cursor beside EXECUTE, and then turn the SHUTTLE ring to the right. The option OFF starts flashing.
- 14. Turn the JOG dial to select ON.
- 15. Turn the SHUTTLE ring to the right to start copying.

### Still-Frame Playback Copy Mode

#### DX3009 Models

By pressing the PAUSE button and, while the unit is in still-frame playback mode, setting the Transfer Period to MAN in the Copy Selection menu, the unit copies 1 MB of data from the time when the PAUSE button is pressed.

#### DX3016 Models

Press the PAUSE button, and then press the COPY button. One megabyte of data is copied from the time the PAUSE button is pressed.

### SIMULTANEOUS RECORDING AND BACKUP

Backups of previously recorded data can be made at the same time the DVR is recording new data, but the following restrictions apply.

- 1. Cancelling copy operation

If you are doing a backup at the same time the DVR is recording and you want to stop the backup operation, press the WARNING RESET button.

- 2. Selecting recording interval for simultaneous backup

The recording interval for simultaneous backup of recorded data is determined by the data-writing speed of the connected device. For reference, the following chart provides a list of interval modes that can be selected when the unit is used in conjunction with a Hewlett-Packard C1556A drive (DDS3). (The same modes apply when the main hard disk drive has been expanded.)

Field/sec.	30F	15F	7.5F	5F
IMAGE QUALITY				
<b>SUPERIOR</b>				
<b>HIGH</b>	Non-selectable			
<b>MEDIUM</b>				
<b>STANDARD</b>				
<b>BASIC</b>				

: Simultaneous backup is possible without audio  
 : Simultaneous backup is possible with audio

### 3. Precautions when designating simultaneous timer backup

The backup program, which can be designated as an individual operation, can also be designated with the record and power programs. The following items apply when designating these multiple program modes.

There may be restrictions imposed by the other recording devices. It is recommended that adequate program checks are run before actual operation.

Observe the following precautions when connecting devices requiring time to halt startup (for example, archive devices, tape recording devices etc.)

- Using the backup setting's designated time plus five minutes (the halt startup time of the peripheral recording devices) as a gauge, set the unit so that modes do not change. (Refer to illustration 1.)
- Even when only designating the backup mode, add one minute or more to the backup operation time, and set other programs to start and stop. (Refer to Illustration 2.)

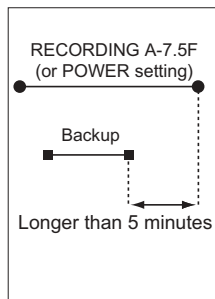

Illustration 1:  
Correct setting

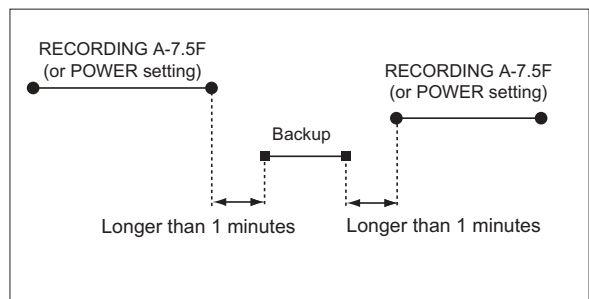

Illustration 2

## RESTORING DATA FROM A BACKUP DEVICE

The recorder can restore recorded data to the hard disk from an archive or copy device. Follow the steps in the section on *Using the COPY Button* in the *Backing up Data* section. In step 7, set the Copy Direction to COPY → HDD. In step 8, ON is the only setting available for OVERWRITE. During the restoration process, image data currently stored on the unit's hard disk is overwritten.

## INFORMATION

### ELAPSED TIME DISPLAY

1. Press the INFO button. The Information menu appears. The elapsed time appears in the lower part of the screen.
2. To exit the menu, press the INFO button again.

The elapsed time of main hard disk drive, archive device, and copy device are shown on the screen. The elapsed time for the archive or copy devices will not be displayed unless they are connected to the recorder.

The elapsed time of main hard disk drive is counted when the recorder's power is turned on.

The elapsed time of the peripheral device (ID4) is counted:

- When the ARCHIVE button illuminates or flashes
- When the PLAY or REV PLAY button illuminates or flashes when the archive device is selected as a playback device using the PLAY DEVICE button
- While the ARCHIVE indicator illuminates or flashes when restoring the data from main hard disk drive to the archive device

The elapsed time of the peripheral device (ID5) is counted:

- When the PLAY or REV PLAY button illuminates or flashes when the copy device is selected as a playback device using the PLAY DEVICE button
- When the COPY indicator illuminates or flashes when copying the data from main HDD to the copy device
- When the COPY indicator illuminates or flashes when restoring the data from main HDD to the copy device

The elapsed time of the archive device or copy device will not be reset even though those devices are disconnected.

The elapsed time of archive device starts when the ARCHIVE button is pressed (when pressed, the ARCHIVE button illuminates), even when there is no data on the main hard disk drive, such as when the recorder is in the alarm standby mode.

The elapsed time may not be consistent with the normal time for wearing of parts.

The elapsed time is shown up to a maximum of 999999 hours.

### POWER FAILURE LIST

If your system has had power failures, you can view the Power Failure list to see when they occurred. Up to 50 power failure starting times are shown on the list. If there are more than 50 times, the last 50 starting times are shown.

1. Press the SET UP button to display the Menu Setting menu.
2. Turn the JOG dial to move the cursor to SERVICE, and then turn the SHUTTLE ring to the right. The Service menu appears.
3. Turn the JOG dial to move the cursor next to POWER FAILURE, and then turn the SHUTTLE ring to the right. The Power Failure list appears on the screen. The number of times, the date, and the time when the power failure occurred are given on the list.

To reset the power failure start time, press the WARNING RESET button when the Power Failure list is shown on the screen.

4. Press the SET UP button to exit the menu.



## RECORDED PERIOD

The recorded periods of the main hard disk drive, the archive device, and the copy device are shown on the screen.

The archive device is displayed only when an archive device is connected to ID4.

The copy device is displayed only when a copy device is connected to ID5.

1. Press the INFO button. The Information menu appears.
2. Check that the cursor is next to RECORDED PERIOD, and then turn the SHUTTLE ring to the right.
3. The message, "GET S/E INFORMATION. TURN THE SHUTTLE RING >> TO EXECUTE." appears on the screen. Turn the SHUTTLE ring to the right. The Recorded Period menu appears.
4. To exit the menu, press the INFO button again.

## SCSI DEVICE(S) CONNECTED

The SCSI ID number of connected devices can be confirmed on the screen.

1. Press the INFO button. The Information menu appears.
2. Turn the JOG dial until the cursor is next to CONNECTED SCSI DEVICE, and then turn the SHUTTLE ring to the right. The SCSI ID numbers appear on the screen.  
  
ID0 to ID3 are allocated to the main hard disk drive. ID4 is allocated to the archive device, and ID5 is allocated to the copy device.
3. To exit the menu, press the INFO button again.

## POWER FAILURE

The unit resumes recording after a power failure if the unit was recording prior to the power failure. When running a timer recording, the unit restarts recording if a power failure ends before the user-specified time frame. An "X" appears next to the time display following a power outage; push the WARNING RESET button to remove the "X."

If there is a power failure during recording, image quality may be partially degraded and search functions may not operate normally.

The starting times of power failures are recorded when power is restored and can be confirmed later. (Starting times of power failures occurring during backup operation are not recorded.) Refer to *Information, Power Failure List* in the *Operation* section.

The unit is equipped with an internal power failure compensation circuit, and, after a full recharge of 48 or more hours, will preserve data and time settings for one month. Timer settings and menu settings will also be preserved. Time settings will not be precise, however, if the circuit has been unplugged for a long period of time. If this situation continues, it is recommended that current time settings be confirmed.

Recharging occurs automatically while the recorder is plugged into a 100-240 VAC power source.

## RESET

The following conditions occur when the RESET button located on the unit's back panel is pressed (using a ball-point pen or other object): the current time is erased, the system is reset, and main power is turned off. Recorded data and menu settings are not erased.

## DX3009 RECORDING TIME TABLES



Audio recording possible. (12.8kHz sampling)



Audio recording possible, but with diminished quality. (8kHz sampling)



Audio recording not possible.

### ■ Audio recording time table

Approximate recording time (if recording is made with internal 30 GB HDD)

#### ◆ Without Audio recording

Field/sec. IMAGE QUALITY	30F	15F	7.5F	5F	3F	1F	NUMBER OF RECORDING FIELD
<b>SUPERIOR</b>	6h10min	12h	1D	1D13h	2D14h	7D18h	672,000
<b>HIGH</b>	9h40min	19h	1D14h	2D10h	4D 1h	12D 4h	1,052,000
<b>MEDIUM</b>	13h	1D 3h	2D 7h	3D10h	5D18h	17D 6h	1,491,000
<b>STANDARD</b>	18h	1D12h	3D	4D12h	7D13h	22D16h	1,959,000
<b>BASIC</b>	22h	1D21h	3D18h	5D16h	9D11h	28D10h	2,456,000

#### ◆ Audio recording

Field/sec. IMAGE QUALITY	30F	15F	7.5F	5F	3F	1F	NUMBER OF RECORDING FIELD
<b>SUPERIOR</b>	4h50min	9h40min	19h	1D 5h	2D	6D 2h	526,000
<b>HIGH</b>	7h10min	14h	1D 5h	1D19h	3D 1h	9D 3h	789,000
<b>MEDIUM</b>	10h	21h	1D19h	2D16h	4D12h	13D12h	1,169,000
<b>STANDARD</b>	14h	1D 4h	2D 8h	3D12h	5D20h	17D14h	1,520,000
<b>BASIC</b>	17h	1D11h	2D22h	4D 9h	7D 8h	22D	1,901,000

### ■ Audio recording time table

Approximate recording time (if recording is made with internal 60 GB HDD)

#### ◆ Without Audio recording

Field/sec. IMAGE QUALITY	30F	15F	7.5F	5F	3F	1F	NUMBER OF RECORDING FIELD
<b>SUPERIOR</b>	12h	1D	2D 1h	3D 2h	5D 4h	15D13h	1,345,000
<b>HIGH</b>	19h	1D14h	3D 5h	4D20h	8D 2h	24D 8h	2,105,000
<b>MEDIUM</b>	1D 3h	2D 7h	4D14h	6D21h	11D12h	34D12h	2,983,000
<b>STANDARD</b>	1D12h	3D	6D 1h	9D 1h	15D 2h	45D 8h	3,919,000
<b>BASIC</b>	1D21h	3D18h	7D13h	11D 8h	18D22h	56D20h	4,913,000

#### ◆ Audio recording

Field/sec. IMAGE QUALITY	30F	15F	7.5F	5F	3F	1F	NUMBER OF RECORDING FIELD
<b>SUPERIOR</b>	9h40min	19h	1D14h	2D10h	4D 1h	12D 4h	1,052,000
<b>HIGH</b>	14h	1D 5h	2D10h	3D15h	6D 2h	18D 6h	1,579,000
<b>MEDIUM</b>	21h	1D19h	3D14h	5D 9h	9D	27D 1h	2,339,000
<b>STANDARD</b>	1D 4h	2D 8h	4D16h	7D	11D17h	35D 4h	3,041,000
<b>BASIC</b>	1D11h	2D22h	5D20h	8D19h	14D16h	44D	3,802,000

## DX3009 RECORDING TIME TABLES (Continued)

### ■ Pre-alarm recording time table

♦ Without Audio recording, Pre-Alarm Recording duration is set to LONG.

Field/sec. IMAGE QUALITY	30F	15F	7.5F	5F	3F	1F
<b>SUPERIOR</b>	2s	4s	9s	13s	23s	1min9s
<b>HIGH</b>	3s	7s	14s	21s	36s	1min48s
<b>MEDIUM</b>	5s	10s	20s	30s	51s	2min33s
<b>STANDARD</b>	6s	13s	26s	40s	1min7s	3min21s
<b>BASIC</b>	8s	16s	33s	50s	1min24s	4min12s

♦ Without Audio recording, Pre-Alarm Recording duration is set to MIDDLE.

Field/sec. IMAGE QUALITY	30F	15F	7.5F	5F	3F	1F
<b>SUPERIOR</b>	1s	3s	6s	9s	15s	46s
<b>HIGH</b>	2s	4s	9s	14s	24s	1min12s
<b>MEDIUM</b>	3s	6s	13s	20s	34s	1min42s
<b>STANDARD</b>	4s	8s	17s	26s	44s	2min14s
<b>BASIC</b>	5s	11s	22s	33s	56s	2min48s

## DX3009 RECORDING TIME TABLES (Continued)



Audio recording possible. (12.8kHz sampling)



Audio recording possible, but with diminished quality. (8kHz sampling)



Audio recording not possible.

- ◆ Without audio Pre-Alarm Recording, recording duration is set to SHORT.

Field/sec. IMAGE QUALITY	30F	15F	7.5F	5F	3F	1F
<b>SUPERIOR</b>	0s	1s	3s	4s	7s	23s
<b>HIGH</b>	1s	2s	4s	7s	12s	36s
<b>MEDIUM</b>	1s	3s	6s	10s	17s	51s
<b>STANDARD</b>	2s	4s	8s	13s	22s	1min7s
<b>BASIC</b>	2s	5s	11s	16s	28s	1min24s

- ◆ Audio recording, Pre-Alarm Recording duration is set to LONG.

Field/sec. IMAGE QUALITY	30F	15F	7.5F	5F	3F	1F
<b>SUPERIOR</b>	1s	3s	7s	10s	18s	54s
<b>HIGH</b>	2s	5s	10s	16s	27s	1min21s
<b>MEDIUM</b>	4s	8s	16s	24s	40s	2min
<b>STANDARD</b>	5s	10s	20s	31s	52s	2min36s
<b>BASIC</b>	6s	13s	26s	39s	1min5s	3min15s

- ◆ Audio recording, Pre-Alarm Recording duration is set to MIDDLE.

Field/sec. IMAGE QUALITY	30F	15F	7.5F	5F	3F	1F
<b>SUPERIOR</b>	1s	2s	4s	7s	12s	36s
<b>HIGH</b>	1s	3s	7s	10s	18s	54s
<b>MEDIUM</b>	2s	5s	10s	16s	26s	1min20s
<b>STANDARD</b>	3s	6s	13s	20s	34s	1min44s
<b>BASIC</b>	4s	8s	17s	26s	43s	2min10s

- ◆ Audio recording, Pre-Alarm Recording duration is set to SHORT.

Field/sec. IMAGE QUALITY	30F	15F	7.5F	5F	3F	1F
<b>SUPERIOR</b>	0s	1s	2s	3s	6s	18s
<b>HIGH</b>	0s	1s	3s	5s	9s	27s
<b>MEDIUM</b>	1s	2s	5s	8s	13s	40s
<b>STANDARD</b>	1s	3s	6s	10s	17s	52s
<b>BASIC</b>	2s	4s	8s	13s	21s	1min5s

# DX3016 RECORDING TIME TABLES



Audio recording possible. (12.8kHz sampling)



Audio recording possible, but with diminished quality. (8kHz sampling)



Audio recording not possible.

## ■ Audio recording time table

Approximate recording time (if recording is made with internal 60 GB HDD)

- This recording time display chart is only valid when PRIORITY in DEFINE GROUP SETTING has been set to “1” for all camera numbers.
- 30F, 10F, and 6F cannot be used for REC INTERVAL when the MOTION DETECTION setting is active.

### ◆ Without Audio recording

Field/sec. IMAGE QUALITY	30F	15F	10F	7.5F	6F	5F	3F	1F	NUMBER OF RECORDING FIELD
<b>SUPERIOR</b>	12H	1D	1D12H	2D	2D12H	3D 1H	5D 1H	15D 5H	1,314,000
<b>HIGH</b>	19H	1D14H	2D 9H	3D 4H	3D23H	4D18H	7D22H	23D19H	2,057,000
<b>MEDIUM</b>	1D 2H	2D 5H	3D 8H	4D11H	5D14H	6D17H	11D 5H	33D17H	2,914,000
<b>STANDARD</b>	1D11H	2D22H	4D10H	5D21H	7D 9H	8D20H	14D18H	44D 7H	3,829,000
<b>BASIC</b>	1D20H	3D16H	5D13H	7D 9H	9D 6H	11D 2H	18D12H	55D13H	4,800,000

00499

### ◆ Audio recording

Field/sec. IMAGE QUALITY	30F	15F	10F	7.5F	6F	5F	3F	1F	NUMBER OF RECORDING FIELD
<b>SUPERIOR</b>	9H	19H	1D 4H	1D14H	1D23H	2D 9H	3D23H	11D21H	1,028,000
<b>HIGH</b>	14H	1D 4H	1D18H	2D 9H	2D23H	3D13H	5D22H	17D20H	1,543,000
<b>MEDIUM</b>	21H	1D18H	2D15H	3D12H	4D 9H	5D 7H	8D19H	26D11H	2,286,000
<b>STANDARD</b>	1D 3H	2D 6H	3D10H	4D14H	5D17H	6D21H	11D11H	34D 9H	2,971,000
<b>BASIC</b>	1D10H	2D20H	4D 7H	5D17H	7D 3H	8D14H	14D 7H	42D23H	3,714,000

00497

## ■ Audio recording time table

Approximate recording time (if recording is made with internal 120 GB HDD)

- This recording time display chart is only valid when PRIORITY in DEFINE GROUP SETTING has been set to “1” for all camera numbers.
- 30F, 10F, and 6F cannot be used for REC INTERVAL when the MOTION DETECTION setting is active.

### ◆ Without Audio recording

Field/sec. IMAGE QUALITY	30F	15F	10F	7.5F	6F	5F	3F	1F	NUMBER OF RECORDING FIELD
<b>SUPERIOR</b>	1D	2D	3D 1H	4D 1H	5D 1H	6D 2H	10D 3H	30D10H	2,628,000
<b>HIGH</b>	1D14H	3D 4H	4D18H	6D 8H	7D22H	9D12H	15D20H	47D15H	4,114,000
<b>MEDIUM</b>	2D 5H	4D11H	6D17H	8D23H	11D 5H	13D11H	22D11H	67D11H	5,829,000
<b>STANDARD</b>	2D22H	5D21H	8D20H	11D19H	14D18H	17D17H	29D13H	88D15H	7,658,000
<b>BASIC</b>	3D16H	7D 9H	11D 2H	14D19H	18D12H	22D 5H	37D	111D 3H	9,601,000

00498

### ◆ Audio recording

Field/sec. IMAGE QUALITY	30F	15F	10F	7.5F	6F	5F	3F	1F	NUMBER OF RECORDING FIELD
<b>SUPERIOR</b>	19H	1D14H	2D 9H	3D 4H	3D23H	4D18H	7D22H	23D19H	2,057,000
<b>HIGH</b>	1D 4H	2D 9H	3D13H	4D18H	5D22H	7D 3H	11D21H	35D17H	3,086,000
<b>MEDIUM</b>	1D18H	3D12H	5D 7H	7D 1H	8D19H	10D14H	17D15H	52D22H	4,572,000
<b>STANDARD</b>	2D 6H	4D13H	6D21H	9D 4H	11D11H	13D18H	22D22H	68D19H	5,943,000
<b>BASIC</b>	2D20H	5D17H	8D14H	11D11H	14D 7H	17D 4H	28D15D	85D23H	7,429,000

00496

## DX3016 RECORDING TIME TABLES (Continued)



Audio recording possible. (12.8kHz sampling)



Audio recording possible, but with diminished quality. (8kHz sampling)



Audio recording not possible.

### ■ Pre-alarm recording time table

- ◆ Without Audio recording, recording duration is set to LONG.

Field/sec. IMAGE QUALITY	30F	15F	10F	7.5F	6F	5F	3F	1F	NUMBER OF RECORDING FIELD
<b>SUPERIOR</b>	3s	6s	9s	12s	15s	18s	30s	1min32s	92
<b>HIGH</b>	4s	9s	14s	19s	24s	28s	48s	2min24s	144
<b>MEDIUM</b>	6s	13s	20s	27s	34s	40s	1min8s	3min24s	204
<b>STANDARD</b>	8s	17s	26s	35s	44s	53s	1min29s	4min28s	268
<b>BASIC</b>	11s	22s	33s	44s	56s	1min7s	1min52s	5min36s	336

00503

- ◆ Without Audio recording, recording duration is set to MEDIUM.

Field/sec. IMAGE QUALITY	30F	15F	10F	7.5F	6F	5F	3F	1F	NUMBER OF RECORDING FIELD
<b>SUPERIOR</b>	1s	3s	4s	6s	7s	9s	15s	46s	46
<b>HIGH</b>	2s	4s	7s	9s	12s	14s	24s	1min12s	72
<b>MEDIUM</b>	3s	6s	10s	13s	17s	20s	34s	1min42s	102
<b>STANDARD</b>	4s	8s	13s	17s	22s	26s	44s	2min14s	134
<b>BASIC</b>	5s	11s	16s	22s	28s	33s	56s	2min48s	168

00504

- ◆ Without Audio recording, recording duration is set to SHORT.

Field/sec. IMAGE QUALITY	30F	15F	10F	7.5F	6F	5F	3F	1F	NUMBER OF RECORDING FIELD
<b>SUPERIOR</b>	0s	1s	2s	3s	3s	4s	7s	23s	23
<b>HIGH</b>	1s	2s	3s	4s	6s	7s	12s	36s	36
<b>MEDIUM</b>	1s	3s	5s	6s	8s	10s	17s	51s	51
<b>STANDARD</b>	2s	4s	6s	8s	11s	13s	22s	1min7s	67
<b>BASIC</b>	2s	5s	8s	11s	14s	16s	28s	1min24s	84

00505

- ◆ Audio recording, recording duration is set to LONG.

Field/sec. IMAGE QUALITY	30F	15F	10F	7.5F	6F	5F	3F	1F	NUMBER OF RECORDING FIELD
<b>SUPERIOR</b>	2s	4s	7s	9s	12s	14s	24s	1min12s	72
<b>HIGH</b>	3s	7s	10s	14s	18s	21s	36s	1min48s	108
<b>MEDIUM</b>	5s	10s	16s	21s	26s	32s	53s	2min40s	160
<b>STANDARD</b>	6s	13s	20s	27s	34s	41s	1min9s	3min28s	208
<b>BASIC</b>	8s	17s	26s	34s	43s	52s	1min26s	4min20s	260

00500

## DX3016 RECORDING TIME TABLES (Continued)



Audio recording possible. (12.8kHz sampling)



Audio recording possible, but with diminished quality. (8kHz sampling)



Audio recording not possible.

- ◆ Audio recording, recording duration is set to MEDIUM.

Field/sec. IMAGE QUALITY	30F	15F	10F	7.5F	6F	5F	3F	1F	NUMBER OF RECORDING FIELD
<b>SUPERIOR</b>	1s	2s	3s	4s	6s	7s	12s	36s	36
<b>HIGH</b>	1s	3s	5s	7s	9s	10s	18s	54s	54
<b>MEDIUM</b>	2s	5s	8s	10s	13s	16s	26s	1min20s	80
<b>STANDARD</b>	3s	6s	10s	13s	17s	20s	34s	1min44s	104
<b>BASIC</b>	4s	8s	13s	17s	21s	26s	43s	2min10s	130

00501

- ◆ Audio recording, recording duration is set to SHORT.

Field/sec. IMAGE QUALITY	30F	15F	10F	7.5F	6F	5F	3F	1F	NUMBER OF RECORDING FIELD
<b>SUPERIOR</b>	0s	1s	2s	3s	3s	4s	7s	23s	23
<b>HIGH</b>	1s	2s	3s	4s	6s	7s	12s	36s	36
<b>MEDIUM</b>	1s	3s	5s	6s	8s	10s	17s	51s	51
<b>STANDARD</b>	2s	4s	6s	8s	11s	13s	22s	1min7s	67
<b>BASIC</b>	2s	5s	8s	11s	14s	16s	28s	1min24s	84

00505

## WARNINGS

The following table tells you what to do if a warning appears on your monitor.

Options in the CALL OUT options column:

- Selectable: CALL OUT output can be selected or deselected in the Call Out setting in the Rear Terminal menu and the HDD Full setting in the Initial Set Up menu.
- Yes: CALL OUT signal is always sent.

Warning	Status	Countermeasure	Canceling the warning	CALL OUT output
HDD FULL	The internal hard disk drive is full when either STOP or ALARM-PROT has been selected in HDD FULL.	<ul style="list-style-type: none"> <li>• When the warning is canceled, the unit will start overwriting the oldest data remaining in the hard disk drive.</li> <li>• Archive or copy data as necessary.</li> </ul>	Press the WARNING RESET button.	Selectable
HDD NEAR END	The storage capacity of the hard disk drive is approaching the value entered into the HDD capacity setting.	<ul style="list-style-type: none"> <li>• Archive or copy data as necessary.</li> </ul>	Press the WARNING RESET button.	Selectable
ARCHIVE FULL	The storage medium in the backup recording device is full.	<ul style="list-style-type: none"> <li>• Replace the medium in the backup recording device.</li> </ul>	Press the WARNING RESET button.	Selectable
ARCHIVE NEAR END	The limit of the archive medium's storage capacity is being reached.	<ul style="list-style-type: none"> <li>• Replace the medium in the backup recording device.</li> </ul>	Press the WARNING RESET button.	Selectable
COPY OVERTAKE ERROR ARCHIVE OVERTAKE ERROR	Non-backed up data was overwritten while the HDD was in Repeat mode.	<ul style="list-style-type: none"> <li>• If you do not wish to have the data overwritten, stop recording.</li> <li>• Change the settings for recording interval and image quality. (More specifically, lengthen intervals and lower image quality.)</li> </ul>	Press the WARNING RESET button.	Yes
COPY NEAR OVERTAKE ARCHIVE NEAR OVERTAKE	The HDD is in Repeat mode, and data which has not been backed up will be overwritten. (The amount of time remaining before the unit begins overwriting is approximately 5% of the time indicated as the possible recording duration.)	<ul style="list-style-type: none"> <li>• If you do not wish to have the data overwritten, stop recording.</li> <li>• Change the settings for recording interval and image quality. (More specifically, lengthen intervals and lower image quality.)</li> </ul>	Press the WARNING RESET button.	Yes
COPY SIZE ERROR ARCHIVE SIZE ERROR RESTORE SIZE ERROR	When using the copy or restore functions, either the amount of data to be transferred exceeds the limits of the storage medium, or there is no data to be copied.	<ul style="list-style-type: none"> <li>• Reset the range of backup or copying.</li> <li>• Replace the archive/copy medium.</li> </ul>	Press the WARNING RESET button.	Yes
COPY CHECK MEDIA 1 ARCHIVE CHECK MEDIA 1 RESTORE CHECK MEDIA 1	An error has occurred in either the RDD device or the DDS device.	<ul style="list-style-type: none"> <li>• Check the storage medium in the RDD or DDS device. (Insert medium if there is none. If medium is present and you wish to use it, undo the write-protection. If medium is present and you do not wish to use it, replace the medium.)</li> </ul>	Press the WARNING RESET button.	Yes
NO SIGNAL (1 2 3 4 5 6 7 8 9)  [The warning will indicate the number of the non-functioning camera.]	Visual signal was absent for over five seconds during recording.	<ul style="list-style-type: none"> <li>• Check whether the unit and camera are properly connected, and that electricity is on.</li> <li>• Check whether the visual signal is being properly outputted.</li> <li>• Check whether the unit's camera setting is set to an empty channel.</li> </ul>	<ul style="list-style-type: none"> <li>• Either turn off recording or, if the visual signal has been restored, cancel the warning</li> <li>• Press the WARNING RESET button.</li> </ul>	Yes
SYSTEM ERROR REC SYSTEM ERROR COPY SYSTEM ERROR ARCHIVE SYSTEM ERROR RESTORE SYSTEM ERROR	SCSI connection error or system malfunction.	<ul style="list-style-type: none"> <li>• Confirm that the SCSI cable is properly connected.</li> <li>• Restart operation.</li> <li>• Inspect the HDD/archive/copy device.</li> </ul>	Press the WARNING RESET button.	Yes
COPY R/W ERROR ARCHIVE R/W ERROR RESTORE R/W ERROR	A data-writing error occurred during backup or copying.	<ul style="list-style-type: none"> <li>• Inspect the archive/copy device.</li> </ul>	Press the WARNING RESET button.	Yes



# TROUBLESHOOTING

If problems with the unit persist even after you've followed the suggestions below, please disconnect the power cord and contact Pelco's Technical Support Group at 800-289-9100.

	<b>Description of problem</b>	<b>Please consult the following</b>
<b>INSTALLATION</b>	The unit will not turn on.	Is the power cord properly plugged in? Is the LOCK indicator light on? Is the TIMER REC indicator light on?
	Power is on, but the unit will not operate.	Is the LOCK indicator light on? Is the POWER button blinking? (The unit cannot be operated when the POWER button is blinking and it's the same when the other buttons and indicators are blinking.) It is possible that the safety features are in operation. Restart the unit by pressing the RESET button located at the back of the unit using a ballpoint pen or similar object. Is the REMOTE communication indicator light on (DX3016 models only)? Press the REMOTE communication button to turn off the light.
	Images are not appearing on the monitor.	Are the monitor and camera(s) connected correctly? Is the unit receiving an input signal from the selected camera? Check this by setting the unit to SPLIT 9.
	The quality of the monitor picture is poor.	Is the connecting cord connected correctly? Is the camera's focus adjusted correctly?
<b>RECORDING</b>	The unit will not start recording.	Is there any recording space left on the disk? The unit begins recording only after the specified recording time. Was the unit stopped during the specified recording time? Is the PRE ALARM REC indicator light on?
	The unit will not stop recording.	Is the LOCK indicator light on? Is the unit running in Timer Recording mode? If so, cancel the Timer Recording and press the TIMER REC button once again.
	The unit will not perform Repeat Recording.	Is the unit running in Repeat Recording mode?
	The unit will not perform Timer Recording.	Are the date and current time set accurately? Are the Recording Start-/End-times and the recording interval set correctly? If the recording interval has been set correctly, then has the recording medium been placed in the unit? Has the recording medium's write-protect been removed? Is the HDD Repeat Recording setting set on REC-STANDBY?
	The unit will not perform Alarm Recording.	Is the unit in stand-by mode? Are the peripheral switches, etc., connected correctly?
<b>PLAYBACK</b>	The unit will not perform playback.	Is the LOCK indicator light on? Has the image data been erased? Has the playback device been selected correctly? Is the PRE ALARM REC indicator light on?
<b>PERIPHERAL RECORDING DEVICE</b>	The copying device/archive device does not respond.	Has the recording medium been inserted correctly into the unit? Is the unit currently in the middle of loading the recording medium? Has the playback device been selected correctly?
	Power is on, but I cannot get past the "SETTING UP ..." display.	Has the peripheral recording device been selected correctly? Is the peripheral recording device's SCSI ID number set correctly? Is the SCSI terminator switch off?
	The unit will not backup all of the data on the hard disk.	Inspect the recording medium. Check the amount of available recording space.

<b>OTHERS</b>	<b>Description of problem</b>	<b>Please consult the following</b>
	The unit will not respond to PC control.	Is the RS-232C setting set correctly? Are the unit and computer connected correctly? Is there a defect in the connecting cable? Is the proper connecting cable being used? Is the REMOTE communication indicator light on (DX3016 models only)? Press the REMOTE communication button to turn off the light.
	The DEVICE CHECK menu does appear when power is turned on.	Is peripheral device's SCSI ID setting set correctly? Inspect the connecting cable.
	The unit is not detecting its peripheral recording device(s).	Is the SCSI terminator switch on? Have the peripheral devices been disconnected? Are the recommended peripheral devices being used?
	Black screens are being displayed during multi-screen display.	Operations settings have not been made, in the Camera Operation Setting parameter of the DEFINE GROUP SETTING. Input from cameras displaying the " - " symbol will appear black on the monitor.
	Button operation is not working.	Is the playback device indicator light blinking? Wait until the light stays on, then start operation once more. If the light does not stop blinking for a long period, use the RESET button located at the back of the unit. Is the LOCK function or the PASSWORD LOCK function in effect? If so, please cancel the function(s).
	Button operation of camera numbers is not working.	Is the Menu screen being displayed? (Camera number buttons cannot be used when the Menu screen is displayed.) Is the unit currently accessing a peripheral recording device? Check the ACCESS indicator.
	The unit will not detect motion.	Is the MOTION DETECTION setting ON in the Initial Set Up menu? Is the value of the MOTION THRESHOLD setting greater than the dot value entered in the SET DETECTION MASK setting? The motion detection function will not work when menus are open. (The M-DET indicator light is off when the motion detection function is not operating.)

## SPECIFICATIONS

### ELECTRICAL/VIDEO/AUDIO

Input Voltage:	100-240 VAC, 50/60Hz
Power Consumption:	150W maximum
Signal System:	NTSC
Recording System:	Digital recording system with JPEG compression method
Sampling:	13.5 MHz
Data Compression:	JPEG
Compression Unit:	Field
Audio Recording System:	PCM
Resolution:	684 x 480 pixels
Video Storage	
DX3009-030:	30 GB hard drive
DX3009-060:	60 GB hard drive
DX3016-060:	60 GB hard drive
DX3016-120:	120 GB hard drive
Video Input	
Number:	9 (DX3009 models) or 16 (DX3016 models)
Signal:	1.0 Vp-p, 75 ohms
Looping Video Output	
Number:	9 (DX3009 models) or 16 (DX3016 models)
Signal:	1.0 Vp-p, 75 ohms
Monitor Output	
SVHS Video:	Y-Signal: 1.0 Vp-p, 75 ohms C-Signal: 0.286 Vp-p, 75 ohms
Standard Video:	1.0 Vp-p, 75 ohms
Audio Input:	-8 dBs, 50K ohms
Audio Output:	-8 dBs, 1K ohms
Microphone Input:	-67 dBs, 600 ohms
Timer Program:	Three one-week programs with daily start and stop times
Memory Backup:	Lasts for more than 1 month

<b>Inputs/Outputs</b>	
POWER ON:	Input for power ON. Low input state is power off; high input state is power on.
POWER OFF:	Input for power OFF. Low input state is power off.
ALARM IN (1-9):	Inputs for starting alarm recording. Active: When terminals are short-circuited or "Low" Level voltage is applied. Non active: Open.
CLOCK ADJ:	Input for adjusting clock. Active: When terminals are short-circuited or "Low" Level voltage is applied. Non active: Open.
REC:	Input to start recording. Active: When terminals are short-circuited or "Low" Level voltage is applied. Non active: Open.
GND:	Ground.
ALARM OUT:	Output for use while alarm recording is under way. Active: "Low" Level. Maximum drive current: 7 mA DC.
MODE OUT:	Output for indication of selected recording mode. Non-active: Open. Maximum voltage: +24V DC.
DC 5V OUT:	Output for DC 5V OUT.
CALL OUT:	Output for external warning device. Active: ON. Maximum drive current: 7 mA DC.
CALL OUT GROUND:	Ground for external warning device. Non active: Open. Maximum voltage: +24VDC.

GENERAL

Operating Temperature:	41° to 104°F (5° to 40°C).
Relative Humidity:	Maximum 80%
Dimensions:	16.7 (W) x 15.0 (D) x 4.45 (H) inches (42.5 x 38.0 x 11.3 cm)
<b>Unit Weight</b>	
DX3009 models:	15.7 lb (7.1 kg)
DX3016 models:	17.9 lb (8.1 kg)
<b>Connectors</b>	
Push-in terminal:	POWER ON, POWER OFF, ALARM IN, CLOCK ADJ, REC inputs Ground, CALL OUT ground ALARM OUT, MODE OUT, DC 5V OUT, CALL OUT outputs
BNC:	Video input/output
SVHS:	Video output
DB9:	RS-232C for connection with personal computer
50-pin D-type:	SCSI

*(Design and product specifications subject to change without notice.)*

## REGULATORY NOTICES

This equipment has been tested and found to comply with the limits of a Class A digital device, pursuant to part 15 of the FCC rules. These limits are designed to provide reasonable protection against harmful interference when the equipment is operated in a commercial environment. This equipment generates, uses, and can radiate radio frequency energy and, if not installed and used in accordance with the instruction manual, may cause harmful interference to radio communications. Operation of this equipment in a residential area is likely to cause harmful interference in which case the user will be required to correct the interference at his own expense.

### WARRANTY AND RETURN INFORMATION

#### WARRANTY

Pelco will repair or replace, without charge, any merchandise proved defective in material or workmanship for a period of one year after the date of shipment. Exceptions to this warranty are as noted below:

- Five years on Pelco manufactured cameras (CC3500/CC3600 and MC3500/MC3600 Series); two years on all other cameras.
- Three years on Genex® Series (multiplexers, server, and keyboard).
- Two years on cameras and all standard motorized or fixed focal length lenses.
- Two years on Legacy®, Camclosure™ Camera Systems, CM6700/CM6800/CM8500/CM9500/CM9740/CM9760 Matrix, DF5 and DF8 Series Fixed Dome products.
- Two years on Spectra®, Esprit™, and PS20 Scanners, including when used in continuous motion applications.
- Two years on WW5700 series window wiper (excluding wiper blades).
- Eighteen months on DX Series digital video recorders.
- One year (except video heads) on video cassette recorders (VCRs). Video heads will be covered for a period of six months.
- Six months on all pan and tilts, scanners or preset lenses used in continuous motion applications (that is, preset scan, tour and auto scan modes).

Pelco will warrant all replacement parts and repairs for 90 days from the date of Pelco shipment. All goods requiring warranty repair shall be sent freight prepaid to Pelco, Clovis, California. Repairs made necessary by reason of misuse, alteration, normal wear, or accident are not covered under this warranty.

Pelco assumes no risk and shall be subject to no liability for damages or loss resulting from the specific use or application made of the Products. Pelco's liability for any claim, whether based on breach of contract, negligence, infringement of any rights of any party or product liability, relating to the Products shall not exceed the price paid by the Dealer to Pelco for such Products. In no event will Pelco be liable for any special, incidental or consequential damages (including loss of use, loss of profit and claims of third parties) however caused, whether by the negligence of Pelco or otherwise.

The above warranty provides the Dealer with specific legal rights. The Dealer may also have additional rights, which are subject to variation from state to state.

If a warranty repair is required, the Dealer must contact Pelco at (800) 289-9100 or (559) 292-1981 to obtain a Repair Authorization number (RA), and provide the following information:

1. Model and serial number
2. Date of shipment, P.O. number, Sales Order number, or Pelco invoice number
3. Details of the defect or problem

If there is a dispute regarding the warranty of a product which does not fall under the warranty conditions stated above, please include a written explanation with the product when returned.

Method of return shipment shall be the same or equal to the method by which the item was received by Pelco.

#### RETURNS

In order to expedite parts returned to the factory for repair or credit, please call the factory at (800) 289-9100 or (559) 292-1981 to obtain an authorization number (CA number if returned for credit, and RA number if returned for repair).

All merchandise returned for credit may be subject to a 20% restocking and refurbishing charge.

Goods returned for repair or credit should be clearly identified with the assigned CA or RA number and freight should be prepaid. Ship to the appropriate address below.

*If you are located within the continental U.S., Alaska, Hawaii or Puerto Rico:*  
Service Department  
Pelco  
3500 Pelco Way  
Clovis, CA 93612-5699

*If you are located outside the continental U.S., Alaska, Hawaii or Puerto Rico:*  
Intermediate Consignee      Ultimate Consignee  
American Overseas Air Freight      Pelco  
320 Beach Road      3500 Pelco Way  
Burlingame, CA 94010      Clovis, CA 93612-5699  
USA      USA

#### REVISION HISTORY

Manual #	Date	Comments
C681M	01/01	Original version.
C681M-A	01/01	Added models of peripheral devices the recorder supports, noted that recorder does not support RS-232C port, added section on <i>Saving Menu Settings</i> , revised <i>Operation</i> section, and revised <i>Recording Time Table</i> .
C681M-B	3/01	Added 16-channel models.
C681M-C	9/01	Extensive revisions to clarify information. Added sections on <i>FIFO/Overwrite Mode</i> , <i>IM-Check Mode</i> , <i>Motion Detection During a Timer Recording</i> , and <i>Playback on Another Device</i> .
C681M-D	2/02	Removed references to DX3016RX software. Added PelcoNet for remote viewing. Replaced Matsushita brand of DVD-RAM with Panasonic brand.

## Free Manuals Download Website

<http://myh66.com>

<http://usermanuals.us>

<http://www.somanuals.com>

<http://www.4manuals.cc>

<http://www.manual-lib.com>

<http://www.404manual.com>

<http://www.luxmanual.com>

<http://aubethermostatmanual.com>

Golf course search by state

<http://golfingnear.com>

Email search by domain

<http://emailbydomain.com>

Auto manuals search

<http://auto.somanuals.com>

TV manuals search

<http://tv.somanuals.com>