



DX3100 Series Digital Video Recorder



C695M-B (11/03)

CONTENTS

Section	Page
IMPORTANT SAFEGUARDS AND WARNINGS	4
DESCRIPTION	5
MODELS	5
ACCESSORIES	5
INSTALLATION	7
DX3100 REAR PANEL CONNECTIONS	7
MOUNT THE DX3100	8
CONNECT EQUIPMENT	8
CHANNELS AND MONITOR	9
RECEIVER WIRING	9
ALARM WIRING	10
NETWORK CONNECTION	10
CONNECT POWER	11
POWER CYCLING AND SCAN MODE OPERATION	11
OPERATING AND PROGRAMMING CONTROLS	12
DX3100 FRONT PANEL CONTROLS	13
IR REMOTE CONTROLLER CONTROLS	14
PROGRAMMING	15
MENU STRUCTURE	15
SETUP MENU NAVIGATION	16
DX3100-IR REMOTE SYNCHRONIZATION	18
STORAGE CALCULATIONS	19
DX3100 CONFIGURATION	21
RECORDER SETUP	22
CAMERA SETUP	25
ALARM SETUP	27
NETWORK SETUP	28
SYSTEM STATUS AND UPGRADE	29
ENG/DEU/ESP/FRA/POR (LANGUAGE)	30
OPERATION	31
LIVE VIEW MODE	32
ON-SCREEN OVERLAY	33
VIEWING VIDEO	33
SINGLE SCREEN VIEWING	33
MULTIPLE SCREEN VIEWING	34
SEQUENCES	35
PLAYBACK MODE	36
STARTING PLAYBACK MODE	37
ACCESSING RECORDED VIDEO	38
SWITCHING CHANNELS	39
SEARCHING FOR SPECIFIC VIDEO	40
SEARCHING OPEN TIME FILES	41
SEARCHING VIDEO DURING CHANGE TO DAYLIGHT SAVING TIME	42
MPEG STRUCTURE AND FRAME OPERATIONS	43
SAVING IMAGES TO FLOPPY DISKETTE	44
EVENT	45
PTZ MODE	46
ARROW BUTTONS: FRONT PANEL VS. REMOTE	46
ZOOMING	47
LENS FUNCTIONS	47
PTZ TROUBLESHOOTING	47
ALARM DISPLAY ISSUES	48
SPECIFICATIONS	49
WARRANTY AND RETURN INFORMATION	50

LIST OF ILLUSTRATIONS

Figure		Page
1	DX3100 Front and Rear Panels	6
2	DX3108 Rear View	7
3	DX3116 Rear View	7
4	DX3100 Series Installation	8
5	Alarm Wiring Example	10
6	Scan Mode Engaged	11
7	Menu Tree	15
8	Setup Menu Screen	16
9	Navigating the CAMERA SETUP Screen	17
10	DX3100-IR Remote Synchronization	18
11	Setup Menu Screen	21
12	Recorder Setup Screen	22
13	Camera Setup Screen	25
14	Alarm Setup Screen	27
15	Network Setup Screen	28
16	System Status Screen	29
17	Language Setup Screen	30
18	DX3100 Sample LIVE VIEW Screens	32
19	On-Screen Overlay	33
20	Channel Selection	33
21	Stepping Through Screen Sets: Front Panel	34
22	Stepping Through Screen Sets: IR Remote Control	35
23	Opening Playback Overlay	37
24	Playback Mode Entry Time Files	38
25	Play Back Different Channels	39
26	Switching Channels and Time Frames	40
27	Searching DST Files	42
28	Event Display	45
29	PTZ Instructions	46

LIST OF TABLES

Table		Page
A	Video Coaxial Cable Requirements	9
B	Transmit (TX) to Receive (RX) Connections	9
C	DX3100 Channel Sets	34

IMPORTANT SAFEGUARDS AND WARNINGS

Observe the following WARNINGS before installing and using this product.

1. Read these instructions.
2. Keep these instructions.
3. Heed all warnings.
4. Follow all instructions.
5. Do not use this apparatus near water.
6. Clean only with dry cloth.
7. Do not block any ventilation openings. Install in accordance with the manufacturer's instructions.
8. Do not install near any heat sources such as radiators, heat registers, stoves, or other apparatus (including amplifiers) that produce heat.
9. Do not defeat the safety purpose of the polarized or grounding-type plug. A polarized plug has two blades with one wider than the other. A grounding plug has two blades and a third grounding prong. The wide blade or the third prong is provided for your safety. If the provided plug does not fit into your outlet, consult your electrician for replacement of the obsolete outlet.
10. Protect the power cord from being walked on or pinched, particularly at the plug, convenience receptacle, and the point where it exits from the apparatus.
11. Only use attachments/accessories specified by the manufacturer.
12. Use only with the cart, stand, tripod, bracket, or table specified by the manufacturer, or sold with the apparatus. When a cart is used, use caution when moving the cart/apparatus combination to avoid injury from tip-over.
13. Refer all servicing to qualified service personnel. Servicing is required when the apparatus has been damaged in any way, such as when the power supply cord or plug is damaged, liquid has been spilled or objects have fallen into the apparatus, the apparatus has been exposed to rain or moisture, the apparatus does not operate normally, or the apparatus has been dropped.
14. Apparatus shall not be exposed to dripping or splashing, and no objects filled with liquids, such as vases, shall be placed on the apparatus.
15. **Warning:** To reduce the risk of fire or electric shock, do not expose this apparatus to rain or moisture.
16. **Caution:** Risk of explosion exists if battery is replaced by an incorrect type. Dispose of used batteries according to the instructions provided by the battery manufacturer.
17. To reduce the risk of shock, do not perform any servicing other than that contained in the operating instructions unless you are qualified to do so.
18. Unless the unit meets NEMA Type 3, 3R, 3S, 4, 4X, 6, or 6P standards, it is designed for indoor use only and must not be installed where exposed to rain and moisture.
19. **Caution:** The voltage rating for equipment attached to the ALARM IN, OUT terminals of the DX3100 Series should not exceed 1 A, 24 VDC.
20. The installation method and materials should be capable of supporting four times the weight of the unit and equipment.

The product and/or manual may bear the following marks:



This symbol indicates that dangerous voltage constituting a risk of electric shock is present within this unit.



This symbol indicates that there are important operating and maintenance instructions in the literature accompanying this unit.



Please thoroughly familiarize yourself with the information in this manual prior to installation and operation.

DESCRIPTION

DX3100 digital video recorders (DVRs) combine the functions of a high-quality recorder with a multiplexer into a single unit. Both 8- and 16-channel models are available with 60, 120, or 240 GB hard drives. You can set the DX3100 to record video at either high (640 x 240) or low (352 x 240) resolution. The DX3100 software can be upgraded through the built-in floppy disk drive (FDD) or by remote download through a network connection. All units are capable of both NTSC and PAL formats.

MODELS

DX3108-060	Eight-channel digital video recorder, 60 GB (one 60 GB hard drive)
DX3108-120	Eight-channel digital video recorder, 120 GB (one 120 GB hard drive)
DX3108-240	Eight-channel digital video recorder, 240 GB (two 120 GB hard drives)
DX3116-060	Sixteen-channel digital video recorder, 60 GB (one 60 GB hard drive)
DX3116-120	Sixteen-channel digital video recorder, 120 GB (one 120 GB hard drive)
DX3116-240	Sixteen-channel digital video recorder, 240 GB (two 120 GB hard drives)

ACCESSORIES

The following accessories are supplied with the DX3100 Series digital video recorder:

Qty	Description
1	DX3100 Series Installation/Operation manual
1	DX3100 Series Quick Start Guide
1	DX3100 Resource CD
1	DX3100RX Remote Site Software Installation/Operation manual
1	IR (infrared) remote controller
2	Power cables (1 USA standard and 1 European standard)
1	RS-232 to RS-422/RS-485 converter (including power adapter and 9-pin to 25-pin adapter)
2	DB15 to 8-BNC cable-set for looping outputs (DX3116 models only)
2	rack ears for rack-mount installation
4	rubber feet

The following accessory is optional:

DX3100IRREC	External receiver for IR (infrared) remote controller
-------------	---

8-CHANNEL FRONT VIEW

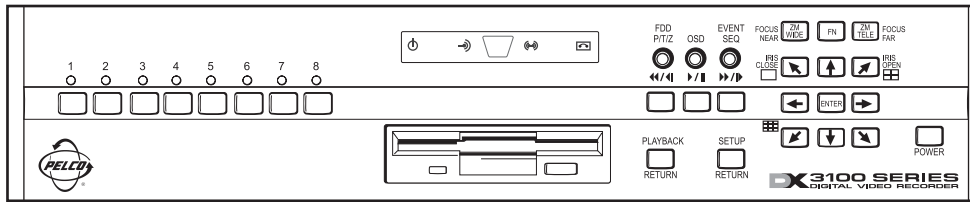

8-CHANNEL REAR VIEW

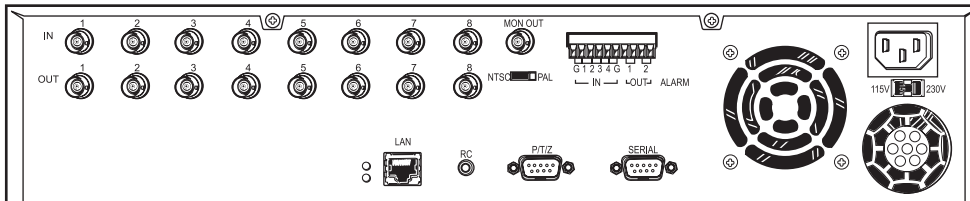

16-CHANNEL FRONT VIEW

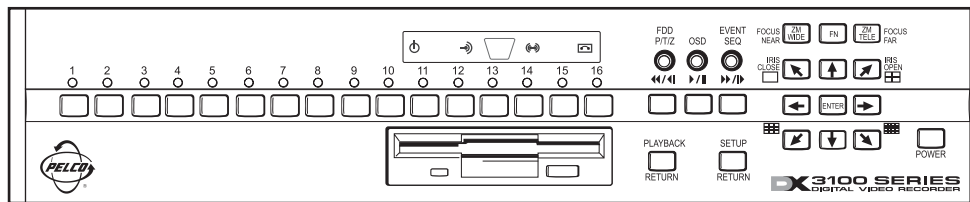

16-CHANNEL REAR VIEW

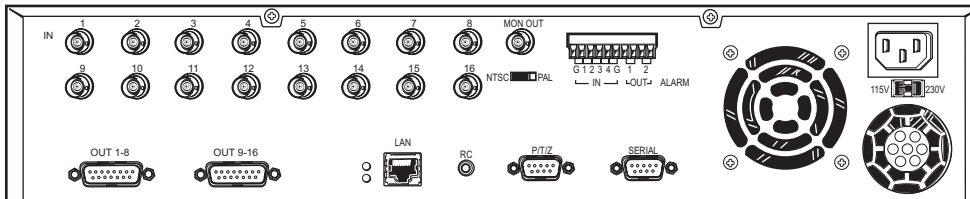

Figure 1. DX3100 Front and Rear Panels

INSTALLATION

DX3100 REAR PANEL CONNECTIONS

The rear views of the DX3108 and DX3116 are shown in Figures 2 and 3, respectively.

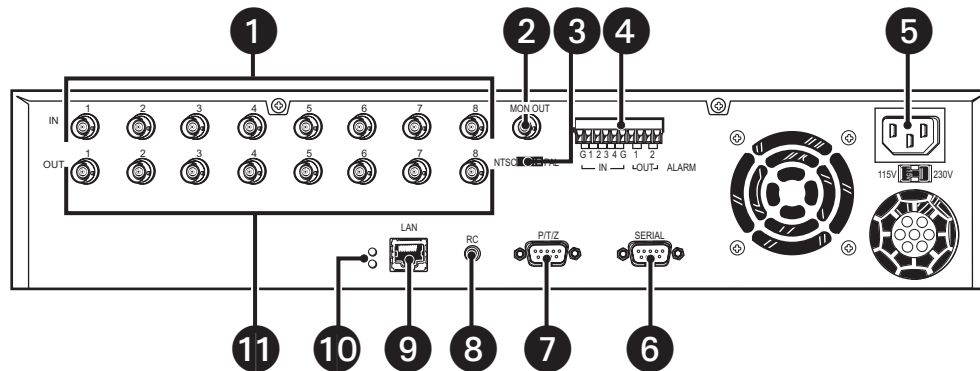

Figure 2. DX3108 Rear View

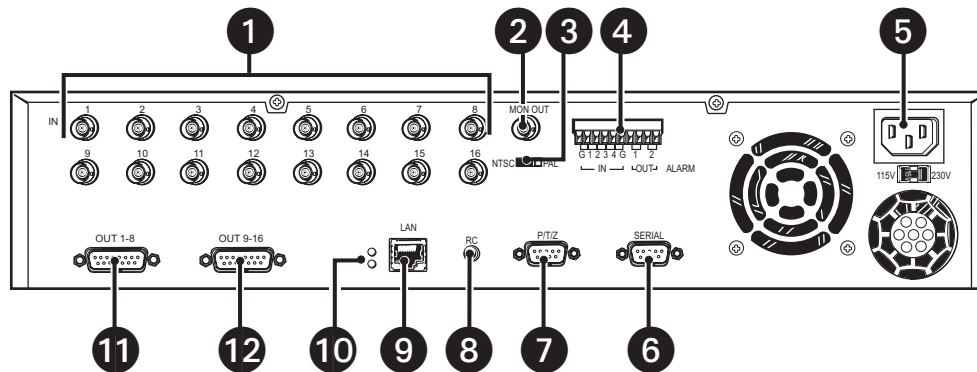

Figure 3. DX3116 Rear View

- 1 Channel inputs: 16 for DX3116, 8 for DX3108; 8 looping outputs for DX3108
- 2 Monitor out BNC connector
- 3 NTSC/PAL selection switch (default is NTSC)
- 4 Alarms: 4 dry contact inputs and 2 relay outputs
- 5 AC power input (default is 115V)
- 6 Serial port (reserved)
- 7 PTZ port (PTZ control of cameras using Pelco's P or D protocol)
- 8 RC (connection for optional external receiver for IR remote controller)
- 9 Network port (10/100BASE-TX Ethernet)
- 10 Network indicators: Red LED for connection, green LED for network activity
- 11 Looping outputs 1-8
- 12 **DX3116 only:** Looping outputs 9-16

MOUNT THE DX3100

Mount the controller on a flat surface (attach rubber feet if mounting on a flat surface) or use the provided rack ears to rack-mount the unit. All models occupy two rack units (RU) of rack space. One RU equals 1.75 inches or 4.45 cm.

CONNECT EQUIPMENT

Use the following instructions to attach all equipment to be used with the recorder. Use Figure 4 as a visual guide for connecting various types of equipment.

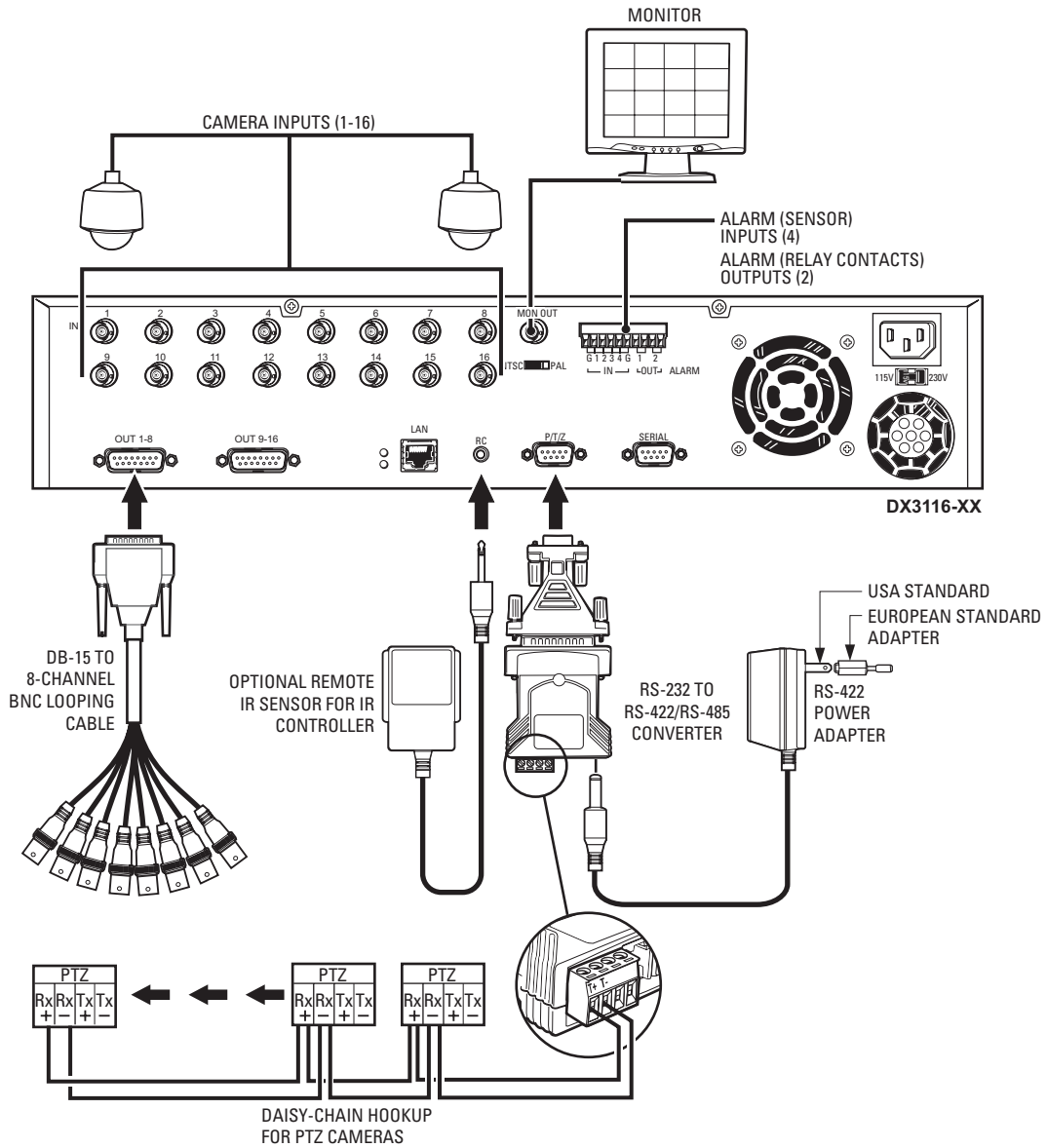

Figure 4. DX3100 Series Installation

CHANNELS AND MONITOR

Refer to Table A for video coaxial cable distances.

1. Connect video cables to the inputs on the rear of the unit.
2. If looping is desired, attach BNC monitor cables to the appropriate output BNCs (DX3108 models) or use the provided looping output cables (DX3116 models).
3. Attach a monitor to the MON OUT BNC on the rear of the unit. This is used for programming the unit and for user operation.

Table A. Video Coaxial Cable Requirements

Cable Type*	Maximum Distance
RG59/U	750 ft (229 m)
RG6/U	1,000 ft (305 m)
RG11/U	1,500 ft (457 m)

*Minimum cable requirements:

75 ohms impedance

All-copper center conductor

All-copper braided shield with 95% braid coverage

RECEIVER WIRING

Wire all camera receiver units that are to be used for PTZ operations. Note that although both Pelco P and Pelco D protocols are recognized and can be used with the controller, you cannot mix receiver protocols on the same DX3100. Select the protocol when programming the unit.

1. Connect the control wires from the receiver to the RS-232 to RS-422/RS-485 converter. The DX3100 can support up to 16 PTZ devices. (Refer to Table B and Figure 4.)

Table B. Transmit (TX) to Receive (RX) Connections

RS-232 to RS-422/RS-485 Converter	Receiver
TX+	RX+
TX-	RX-

2. Set the DTE/DCE switch located on the bottom of the converter to DCE.
3. Plug the RS-232 to RS-422/RS-485 converter into the 9-pin to 25-pin adapter.
4. Plug the converter into the PTZ port.
5. Attach the power adapter to the RS-232 to RS-422/RS-485 converter.
6. Plug the power adapter into a power source. The standard European plug is attached to the power adapter. To convert the adapter to the USA standard, loosen the Phillips screw and remove the European plug (refer to Figure 4).

ALARM WIRING

Up to four alarm inputs can be wired to the DX3100. You can also connect up to two external devices to the unit. When an alarm input is triggered, the unit begins alarm recording. It can also activate the external devices.

Use Figure 5 as a guide for wiring the alarm inputs and relay outputs.

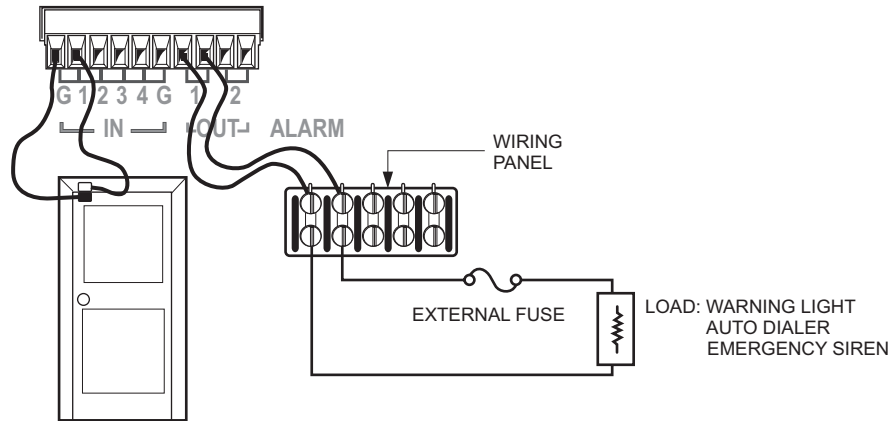

Figure 5. Alarm Wiring Example



WARNING: The alarm relay output provides a maximum load of 1 A at 24 VDC. Therefore, it is recommended that you install a fuse with your external circuit to protect the DX3100.

NETWORK CONNECTION

The DX3100 can be connected to other network equipment as part of a LAN (local area network). Contact your network administrator to set up your connections properly, assign static IP addresses, and so on.

NOTE: The product's network connection should be professionally integrated into existing on-site network configurations, where possible. The connecting cable should meet or exceed Cat5 cable specifications.

CONNECT POWER

NOTE: The DX3100 is set at the factory to operate on 115 VAC. For 230 VAC operation, move the voltage selection slide switch (located below the power input cord connector) to the 230 VAC position. After attaching your equipment to the rear panel connectors, connect the power cable to the unit. The unit powers up automatically.

NOTE: The unit defaults to LIVE VIEW mode immediately after power-up.

POWER CYCLING AND SCAN MODE OPERATION

The DX3100 enters SCAN mode when it is powered up. In this mode, it performs housekeeping functions and guards the integrity of recorded video files and their file structure. Users cannot control this process; it is automatic.

SCAN mode time can be affected by the following three issues:

1. Number of recorded files: The more files there are, the longer the scan takes. When a system is powered up for the first time, there is no scan operation because there are few recorded files.
2. Disk drive size in GB: The larger the system hard drive, the greater the number of files that can be recorded.
3. Type of power-up: SCAN mode is faster after a normal power cycle than after an abnormal power loss.

The word "SCAN" appears on the monitor during power-up at about the same time that "REC" appears (refer to Figure 6). During the scan, the user cannot enter either SETUP or PLAYBACK modes. Only LIVE VIEW and PTZ modes are available. As soon as the unit finishes the scan, normal operation can resume.



Figure 6. Scan Mode Engaged

If you try to access either the SETUP or PLAYBACK modes, the DX3100 displays the following message:

"WAIT UNTIL FILE SCAN IS COMPLETED"

OPERATING AND PROGRAMMING CONTROLS

The DX3100 can be operated and programmed either from the front panel of the unit or from the IR (infrared) remote controller.

NOTE: Each DX3100 has its own identification number or ID. This ID can be changed on the RECORDER SETUP screen on the unit. If you change the ID on the DX3100, you must enter the new ID on the IR remote controller (refer to DX3100-IR Remote Synchronization for more information).

Many controls on both the front panel and the IR remote controller share functions. The function of these buttons depends on the mode (LIVE VIEW, SETUP, PLAYBACK, or PTZ). For example, the arrow buttons on the front panel and the IR remote controller are used differently in LIVE VIEW, SETUP and PTZ modes.

Refer to the controls for each mode on the following pages. Front panel controls appear on page 13; IR remote controller controls appear on page 14.

DX3100 FRONT PANEL CONTROLS

General

- 1 Power switch (startup and shutdown)
- 2 Toggle on-screen display (OSD)
- 3 Sequence
- 4 Activate multi-screen views: ↶ for 1x1, ↷ for 2x2, ↸ for 3x3, ↹ for 4x4
- 5 Display selected channel (1-8 or 1-16)

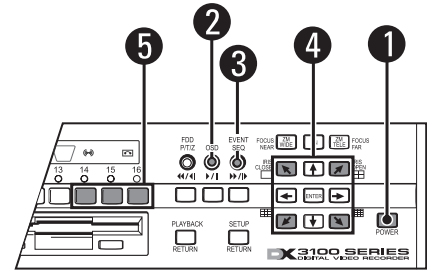

Setup

- 6 Enter and exit setup mode; exit submenus
NOTE: The default password is **1981**.
- 7 Select submenu or edit field
- 8 Field selection and edit: ↑, ↓, ←, →
- 9 Edit password (DX3116): buttons 1-9 = numbers 1-9, button 10 = 0
- 10 Edit password (DX3108): buttons 1-8 = numbers 1-8, button ← = number 9, button → = number 0

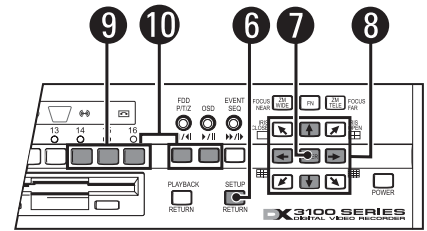

Playback

- 11 Enter and exit playback mode
- 12 VCR-style controls for video playback
- 13 Display event list
- 14 Field selection/edit: ↑, ↓, ←, →, ENTER
- 15 Display video from selected channel (1-8 or 1-16)
- 16 Save image to floppy disk

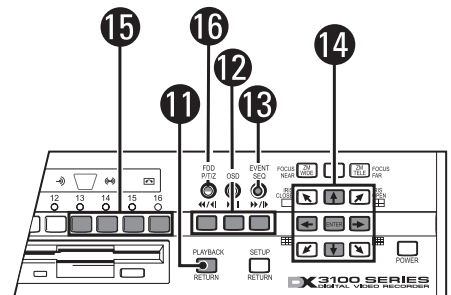

PTZ

- 17 Enter and exit PTZ mode
- 18 Toggle on-screen display (OSD)
- 19 Zoom control: ZM WIDE, ZM TELE
- 20 PTZ directional movement: ↶, ↑, ↷, ←, →, ↸, ↓, ↹
- 21 Enter and exit focus and iris controls
- 22 Focus controls: FOCUS NEAR, FOCUS FAR
- 23 Iris controls: IRIS CLOSE, IRIS OPEN

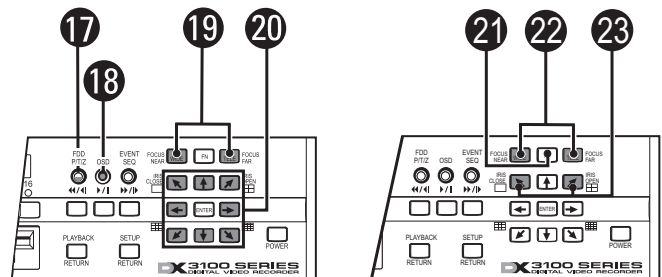

IR REMOTE CONTROLLER CONTROLS

General

- 1 Power switch (startup and shutdown)
- 2 Toggle on-screen display (OSD)
- 3 Sequence
- 4 Display selected channel full screen
- 5 Step through multi-screen views: 1x1, 2x2, 3x3, 4x4

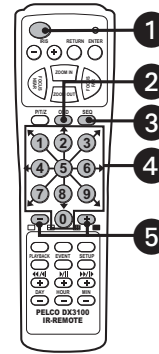

Setup

- 6 Enter and exit setup mode; exit submenus
NOTE: The default password is **1981**.
- 7 Exit submenus and setup mode
- 8 Select submenu or edit field
- 9 Field selection and edit: ↑, ↓, ←, →
- 10 Enter password
- 11 Synchronize IR remote controller to DX3100

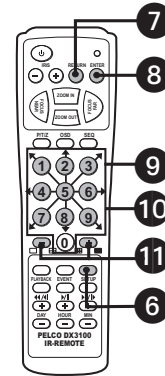

Playback

- 12 Enter and exit playback mode
- 13 Exit playback mode
- 14 VCR-style controls for video playback
- 15 Display event list
- 16 Field selection/edit: ↑, ↓, ←, →, ENTER
- 17 Display video from selected channel (1-8 or 1-16)
- 18 Save image to floppy disk
- 19 Increase or decrease DAY, HOUR, MINUTE fields

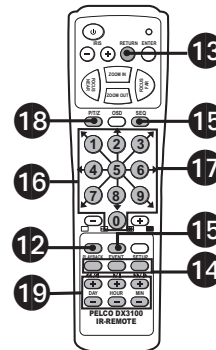

PTZ

- 20 Enter and exit PTZ mode
- 21 Exit PTZ mode
- 22 Toggle on-screen display (OSD)
- 23 Zoom control: ZOOM IN, ZOOM OUT
- 24 PTZ directional movement: ↖, ↑, ↗, ←, →, ↘, ↓, ↙
- 25 Focus controls: FOCUS NEAR, FOCUS FAR
- 26 Iris controls: IRIS CLOSE, IRIS OPEN

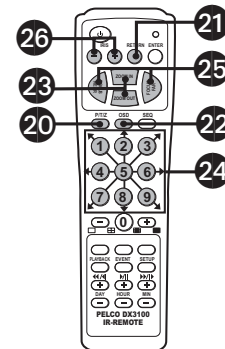

PROGRAMMING

MENU STRUCTURE

All programming operations are performed in SETUP mode. Use either the DX3100 front panel buttons or the IR remote controller to program the unit. The programming menu tree is shown in Figure 7.

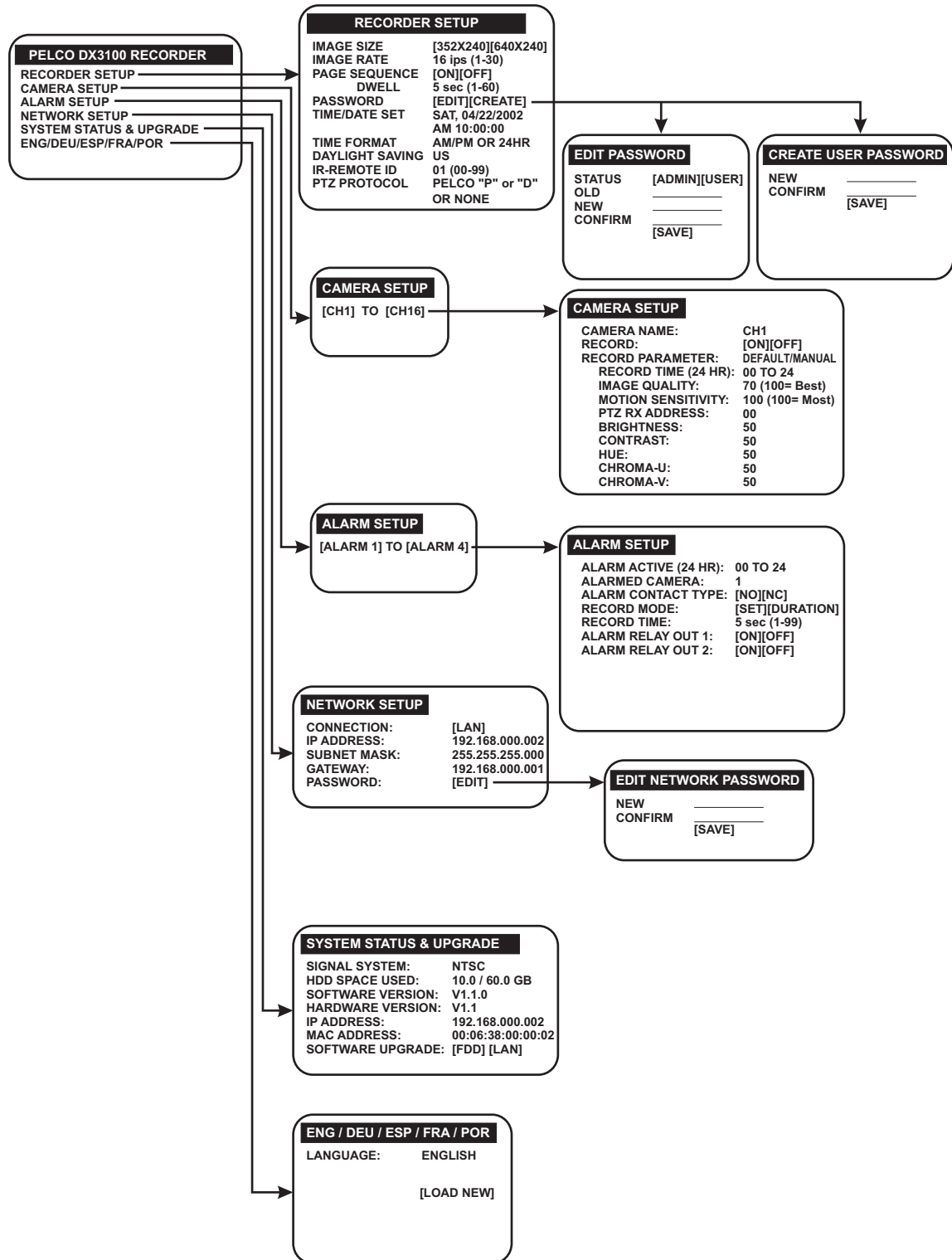

Figure 7. Menu Tree

SETUP MENU NAVIGATION

The DX3100 has four operating modes: LIVE VIEW, SETUP, PLAYBACK, and PTZ. LIVE VIEW, which is the default mode upon power-up, is “home base” for the other three modes.

NOTE: When programming the DX3100, use either the DX3100 front panel controls or the IR remote controller.

To access the DX3100 setup menu:

1. Make sure the unit is in LIVE VIEW mode. If not, exit the current mode.
2. Press the **SETUP** button. The unit asks for the security password.

NOTE: The default password is **1981**. To implement unit security, change the password on the RECORDER SETUP screen.

3. Use the channel buttons to enter the four-digit password. The setup menu screen appears (refer to Figure 8).

NOTE: On the DX3116 front panel, use the **10** button for 0. On the DX3108 front panel, use the **◀** button for 9 and the **▶** button for 0.

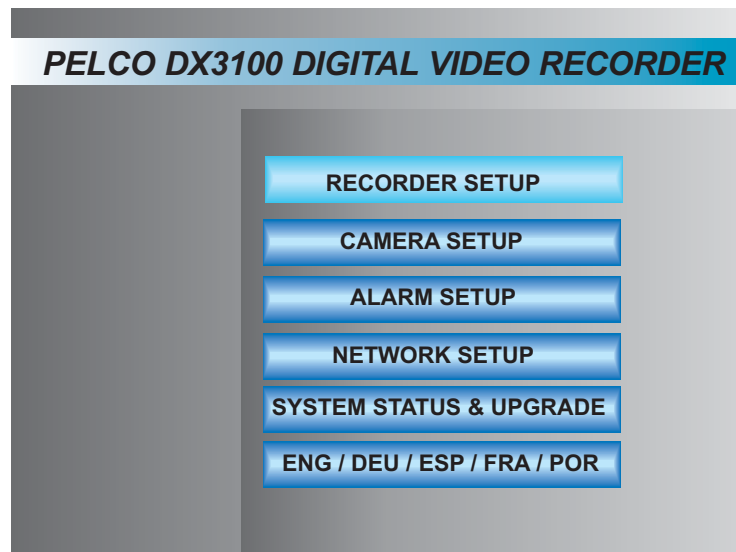

Figure 8. Setup Menu Screen

To access a specific setup screen:

1. Use the up and down arrow buttons to highlight the setup option.
2. Press the **ENTER** button. The setup screen appears.
3. Press the **SETUP** button to exit the specific setup screen.

To close the DX3100 setup menu screen, press the **SETUP** button. The unit returns to LIVE VIEW mode.

Navigating specific setup menu screens is actually quite simple. The following five steps describe how to navigate the CAMERA SETUP menu shown in Figure 9.

1. CH1 is selected. The information in the right window applies to CH1. To select a different channel, use the up and down arrow buttons.
2. Press the **ENTER** button to access the CH1 setting fields. The currently selected field has a darker background. Use the up and down arrow buttons to select a different field.

NOTE: On the IR remote controller, press the 5 button for ENTER.

3. Press the **ENTER** button to edit the field. The white cursor line indicates the current cursor position. Use the up and down arrow buttons to scroll through any field options. Use the right and left arrow buttons to move either to the next position in the field or to the next field. To exit the field, press the **SETUP** button.
4. On-screen buttons provide access to additional settings. Use on-screen buttons to gain access to additional settings, in this case RECORD PARAMETERS for CH1. Use the up and down arrow buttons to select one of these additional fields.

In this example, when **DEFAULT** is selected, the RECORD PARAMETERS for CH1 can be neither accessed nor changed. They are grayed out or disabled. When **MANUAL** is selected, these additional settings can be both accessed and changed. If **DEFAULT** is selected again, the RECORD PARAMETERS are reset to their default values and then disabled.

5. Many setup screens offer additional information, which appears in black lettering.

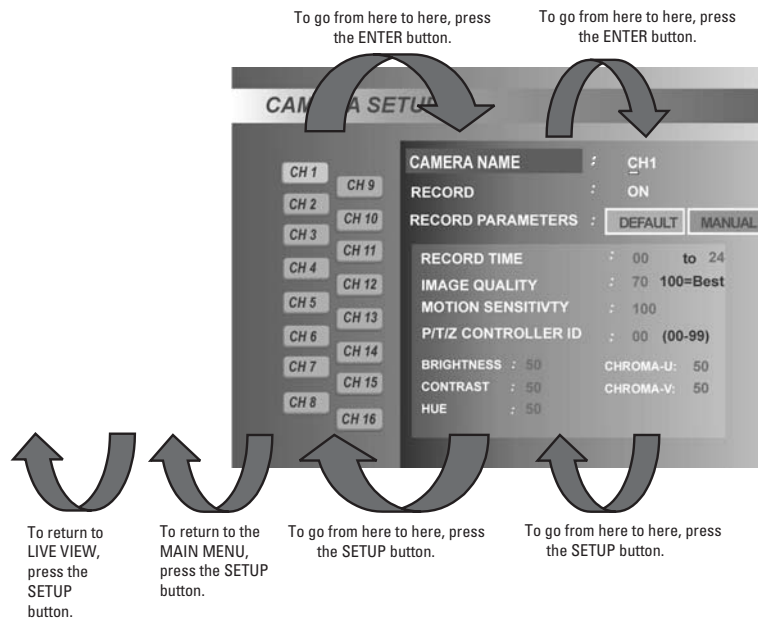

Figure 9. Navigating the CAMERA SETUP Screen

Some on-screen buttons allow access to additional screens. Highlight the button and press the **ENTER** button. Change the appropriate settings and then press the **SETUP** button to exit that screen.

DX3100-IR REMOTE SYNCHRONIZATION

If your IR remote controller does not work with a specific DX3100, perform the following:

1. Obtain the IR remote identification number for the DX3100 from your administrator, or, if you can access SETUP mode on the DX3100, open the RECORDER SETUP screen and note the **IR REMOTE ID** (refer to Figure 12). It will be a number between 00 and 99.
2. Press the - and + buttons on the IR remote controller simultaneously. These buttons are located on the left and right side of the 0 button (refer to Figure 10).
3. The red LED on the unit should light.
4. Use the number keys on the remote to immediately enter the IR REMOTE ID for the DX3100. If the remote accepts the number, the red LED will flash on and off a couple of times.

The IR remote controller should now be able to control the DX3100.

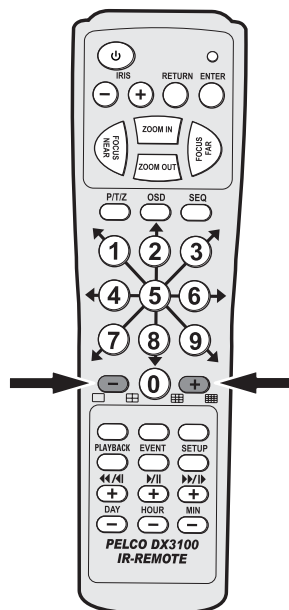

Figure 10. DX3100-IR Remote Synchronization

STORAGE CALCULATIONS

Due to the nature of digital video recording, the particular capabilities of the DX3100, and the different parameters for each installation, it is very difficult to calculate storage capacity. Desired image size, record rate, image quality, and number of channels are only a few of the variables that affect capacity.

Before configuring the DX3100, work through this section to identify the desired settings for the DX3100 as well as all channels that are connected to it. This section describes how different settings impact storage capacity.

NOTE: Values indicating video storage capacity are estimates only. These estimates are to be used as guidelines in determining proper hard drive requirements. Many user-selectable factors, including image quality, recording rate, image content/motion, and video noise, affect the total unit storage capacity. These estimates will vary based on actual use. These estimates are not an implied or expressed guarantee of actual performance.

Average Image Size in KB (IMAGE SIZE)

File size affects how long you can record for a given time period. The greater the file size, the faster you will use available hard disk space. The resolution setting reflects the size of the recorded display and thus the KB size per image. For 352 x 240, the average file size is 3KB to 5KB. A 640 x 240 choice results in a 4KB to 8KB average file size. These resolution settings only affect the image size, not the image quality.

Actual image size can vary within the ranges mentioned for the given resolutions based on the dynamic interplay of image motion and image complexity (over which you have no control). Moreover, the IMAGE QUALITY and MOTION SENSITIVITY settings for each channel in the CAMERA SETUP menu have an effect. For example, if MOTION SENSITIVITY is set to 100 for a channel, it will record all of the time.

Images per Second (IMAGE RATE)

Enter the total images per second (ips) to be shared by all channels on the DX3100. The unit can record 1 to 30 ips for NTSC or 1 to 25 ips for PAL. Enter the highest ips rate required for your installation. Keep in mind that the higher the IMAGE RATE, the lower the storage capacity. However, at lower IMAGE RATES, the unit records fewer images per channel.

For example, on a DX3116 with 16 channels that is set to 30 ips (NTSC), the unit records 1.875 ips for each channel (30 ips / 16 channels). If there are only 12 channels at 30 ips, the unit records 2.5 ips for each channel. If you have 15 channels at 15 ips, the unit only records one ips for each channel.

Recording Hours per Day (RECORD TIME)

Enter the minimum number of recording hours for the installation. For example, if the unit only records from 7:00 p.m. to 7:00 a.m., this number is 12. This is a global setting and applies equally to all channels that have recording enabled.

Number of Days to Store

Enter the number of days per month that the system will be used. There is no menu setting for this item.

0.0036 (Multiplier)

This fixed value represents the amount of required storage capacity, in gigabytes, to record one KB per second for one hour.

$$\left[\text{Average Image Size (KB)} \times \text{Images per Second (ips)} \times \text{Recording Hours per Day (hrs.)} \times \text{Number of Days to Store} \times 0.0036 \text{ (Multiplier)} \right] = \text{Needed Capacity (GB)}$$

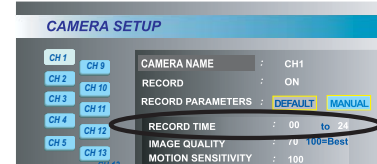
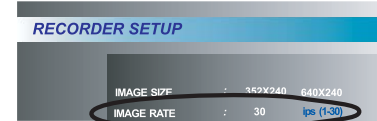
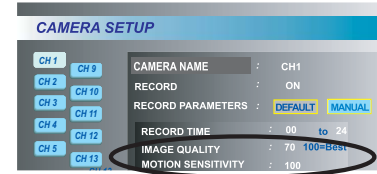
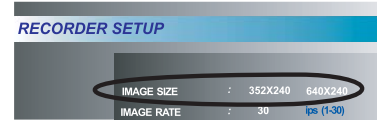

Average Image Size (KB)	Images per Second (ips)	Recording Hours per Day (hrs.)	Number of Days to Store	0.0036 (Multiplier)	Needed Capacity (GB)
<i>Examples:</i>					
3	15	12	30	0.0036	58.32
3	30	12	30	0.0036	116.64
5	15	24	30	0.0036	194.40
3	30	24	30	0.0036	233.28

NOTE: The DX3108-240 and the DX3116-240 each have a maximum capacity of 240GB.

DX3100 CONFIGURATION

The DX3100 setup menu screen is shown in Figure 11.

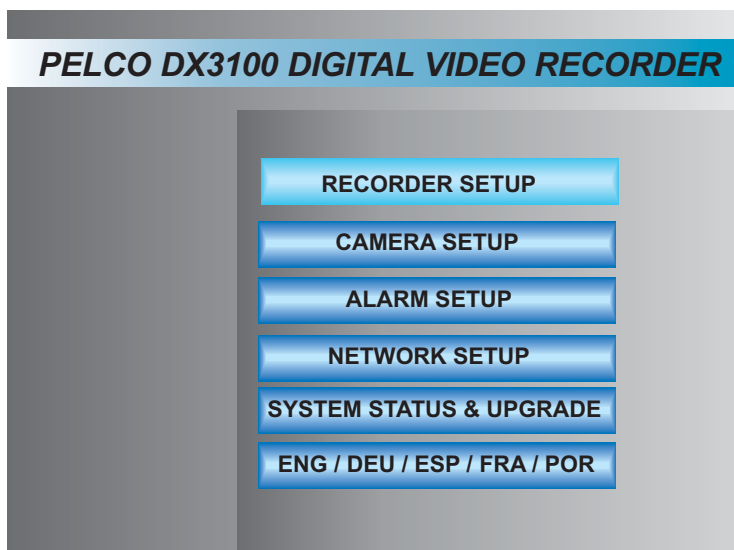

Figure 11. Setup Menu Screen

The DX3100 setup menu screen offers access to the following setup screens:

RECORDER SETUP	Update the unit parameters. These include image size, image rate, password management, time and date, PTZ protocol, and IR remote ID.
CAMERA SETUP	Update the title and recording parameters for each channel input.
ALARM SETUP	Update the parameters for each alarm input and output.
NETWORK SETUP	Update the network address settings: IP, subnet, and gateway.
SYSTEM STATUS & UPGRADE	Display general system information. Also upgrade unit software from the floppy disk drive or a network connection.
ENG/DEU/ESP/FRA/POR	Select the unit language.

NOTE: The DX3100 only supports English at present.

RECORDER SETUP

Highlight the **RECORDER SETUP** option on the setup menu screen and press the **ENTER** button. The RECORDER SETUP screen appears (refer to Figure 12).

The screenshot shows the RECORDER SETUP screen with the following settings:

IMAGE SIZE	:	352X240
IMAGE RATE	:	16 ips
PAGE SEQUENCE	:	ON OFF
DWELL	:	3 sec (1-60)
PASSWORD	:	EDIT CREATE
TIME / DATE SET	:	WED,04/24/2002 AM 10:42:34
TIME FORMAT	:	AM/PM
DAYLIGHT SAVING	:	US
IR-REMOTE ID	:	01 (00-99)
PTZ PROTOCOL	:	PELCO "P"

Figure 12. Recorder Setup Screen

IMAGE SIZE Select the pixel resolution for each recorded image. Choose either **352 x 240** or **640 x 240**. The larger size offers higher image quality, but uses twice as much storage capacity as the smaller size. This global setting applies to all channels. The default is **352 x 240**.

IMAGE RATE Select the total per-second image rate for the unit. This rate is shared equally among available channels. Select a number between 1 and 30 (NTSC) or 1 and 25 (PAL). For example, if the rate is 30 ips with 16 channels, the image rate for each channel is 1.875 ips ($30 / 16 = 1.875$). The default setting is **8 ips** for DX3108 models and **16 ips** for DX3116 models. For the relationship between image rate and alarmed channels, refer to *Record Mode* under *Alarm Setup*.

PAGE SEQUENCE Select **ON** to enable page sequencing. Select **OFF** to disable page sequencing. The default is **ON**.

DWELL If page sequencing is enabled, set the number of seconds to display each channel before proceeding to the next channel in the sequence. Select the number of seconds from 1 to 60. The default is **3**.

PASSWORD Create or update the ADMIN and USER passwords. The default ADMIN password is **1981**. The default USER password is blank.

When preparing system security, you have three options:

- Keep the default ADMIN password.
- Change the default ADMIN password and set up password security.
- Remove the ADMIN password to disable password security.

To access the PTZ and PLAYBACK modes, enter the USER password. To access SETUP mode or to shut down the unit, enter the ADMIN password. LIVE VIEW mode does not require a password.

NOTE: When entering a password on the DX3116, press the **10** button to enter 0. On the DX3108, press the **◀** button to enter 9 and the **▶** button to enter 0.

Edit Password Select **EDIT** and press the **ENTER** button. The EDIT PASSWORD screen appears.

STATUS: Select the password to change: **ADMIN** or **USER**.

OLD (**ADMIN only**): Enter the current four-digit password by pressing the numbered channel buttons. An asterisk is displayed as each number is entered to maintain security.

NEW: Enter the new four-digit password by pressing the numbered channel buttons. An asterisk is displayed as each number is entered to maintain security.

CONFIRM: Reenter the new four-digit password by pressing the numbered channel buttons. An asterisk is displayed as each number is entered to maintain security.

SAVE: Select **SAVE** and press the **ENTER** button to save the new password.

Exit: Press the **SETUP** button to exit the EDIT PASSWORD screen.

NOTE: To delete a password, leave the NEW and CONFIRM fields blank. Then save the blank password.

Create Password To create the USER password, select **CREATE** and press the **ENTER** button. The CREATE USER PASSWORD screen appears.

NEW: Enter the new four-digit password by pressing the numbered channel buttons. An asterisk is displayed as each number is entered to maintain security.

CONFIRM: Reenter the new four-digit password by pressing the numbered channel buttons. An asterisk is displayed as each number is entered to maintain security.

SAVE: Select **SAVE** and press the **ENTER** button to save the new password.

Exit: Press the **SETUP** button to exit the EDIT PASSWORD screen.

NOTE: To delete a password, leave the NEW and CONFIRM fields blank. Then save the blank password.

TIME/DATE SET Enter the current time and date. Select and scroll through the day, date, and time fields, incrementing or decrementing each entry until all are correct.

NOTE: Be sure to enter the correct time and date. Unit operations, including searches, involve time-based parameters that are referenced against this setting.

Since all recording in progress is paused temporarily until setup mode is exited, it is recommended that you exit setup immediately after you set the time and date.

TIME FORMAT Select **AM/PM** or **24HR**.

DAYLIGHT SAVING Select the country to set daylight saving time (DST).

If you select a European country, the date format changes to DD/MM/YYYY. For all other countries, the date format is MM/DD/YYYY. The default is **US**.

NOTE: After changing the daylight saving setting, the unit temporarily pauses all recording until SETUP mode is exited. Therefore, you should exit SETUP mode as soon as possible.

When you exit SETUP MODE after changing DAYLIGHT SAVING, the DX3100 performs a file scan process of all recorded files. This procedure may take several minutes, during which time you cannot enter SETUP or PLAYBACK mode. The word "SCAN" appears on the monitor display.

IR REMOTE ID Select the IR remote controller identification code (00-99). Any IR remote controller that is set to this number can access this DX3100. The default is **01**.

PTZ PROTOCOL Select the Pelco protocol for controlling PTZ receivers that are connected to the unit. Choose between **PELCO D**, **PELCO P** and **NONE**. The default is **NONE**.

Since this is a global setting, all receivers attached to this unit must be configured for the same protocol.

NOTE: Baud rates for Pelco P and Pelco D protocols are fixed at 4800 and 2400 respectively. Therefore, receiver protocol baud rate settings should correspond.

CAMERA SETUP

Highlight the **CAMERA SETUP** option on the setup menu screen and press the **ENTER** button. The CAMERA SETUP screen is shown in Figure 13.

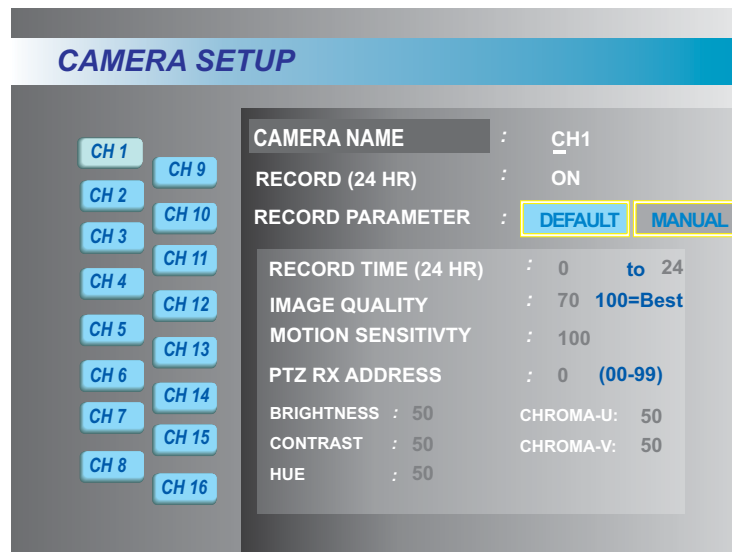

Figure 13. Camera Setup Screen

CAMERA NAME Label the channel with an alphanumeric name (up to 15 characters). The channel name and other information appear on the monitor when the channel is selected.

NOTE: When sequencing in LIVE VIEW mode, the on-screen display (OSD) is not redisplayed until the unit sequences again.

Press the **OSD** button to toggle the channel name on and off. The **OSD** button is active in LIVE VIEW and PTZ modes and also when sequencing in LIVE VIEW mode (refer to the *Operation* section in this manual).

NOTE: When the 3x3 screen format is selected, the DX3100 only displays the first 11 characters of each channel name. When the 4x4 screen format is selected, the DX3116 only displays the first seven characters of each channel name.

RECORD Enable or disable recording for each individual channel. Select and choose between **ON** or **OFF**. Channels with record off are not included in calculations for total shared image rate of recorded channels. For each channel that is set to record OFF, there is a related increase in the individual image rate for channels with record ON.

RECORD PARAMETERS Determine the recording parameters. Select either **DEFAULT** or **MANUAL**. If **DEFAULT** is chosen, all record parameters will be set to default values. If **MANUAL** set is chosen, all record parameters can be adjusted.

RECORD TIME Specify the time span for recording this channel if record ON is selected (refer to *Record* above). This setting indicates the recording start and stop time for each day. The time format is always 24-hour and the default is **0 to 24**, that is, midnight to midnight.

IMAGE QUALITY Specify the general image quality in increments of 10 on a scale of 0 (minimum) to 100 (maximum). The default is **70**.

This setting affects the size of each recorded image. Higher settings result in larger image sizes and reduced recording capacity. Lower settings result in smaller image sizes and increased recording capacity. Select a quality that meets the needs of your installation.

MOTION
SENSITIVITY

Specify the level of motion that is required to record captured images. This level is in increments of 10 on a scale of 0 (minimum) to 100 (maximum). The default is **100**.

At maximum sensitivity (100), motion detection is actually not used. The unit records all images from the channel; it does not skip any images.

The DX3100 evaluates each image to identify the amount of change from the previous image. If the amount of change is above the threshold, the unit records the image. If the amount of change is below the threshold, the unit skips the image.

PTZ RX ADDRESS

Specify the PTZ RX address that is configured for this camera. The default is **00**, which means none specified.

BRIGHTNESS

Specify the brightness level for this channel. This setting ranges from 0 (minimum) to 100 (maximum). The default is **50**.

CONTRAST

Specify the contrast level for this channel. This setting ranges from 0 (minimum) to 100 (maximum). The default is **50**.

HUE

Specify the hue level for this channel. This setting ranges from 0 (minimum) to 100 (maximum). The default is **50**.

CHROMA-U
CHROMA-V

Specify the color levels for this channel. These settings range from 0 (minimum) to 100 (maximum). The default is **50**.

ALARM SETUP

Highlight the **ALARM SETUP** option on the setup menu screen and press the **ENTER** button. The ALARM SETUP screen is shown in Figure 14.

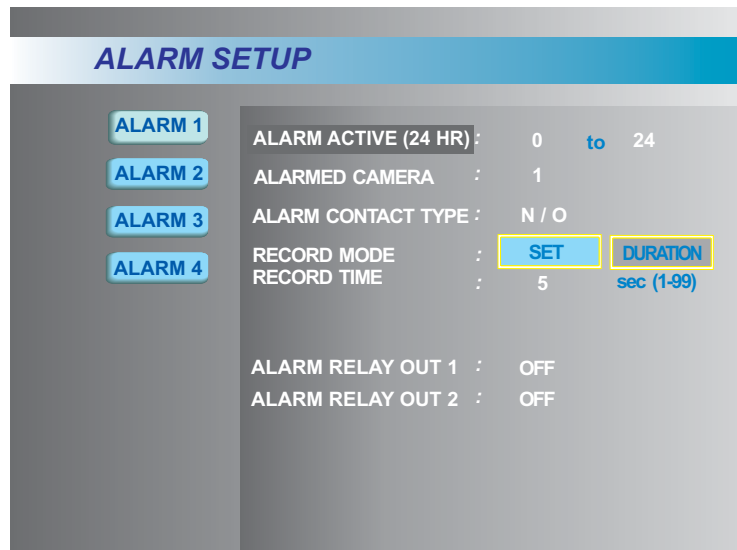

Figure 14. Alarm Setup Screen

NOTE: These settings only apply to how the DX3100 records alarmed channels.

ALARM ACTIVE Select the start and stop time for this alarm. This setting indicates the activation start and stop time for each day. The time format is always 24-hour and the default is **0 to 24**, that is, midnight to midnight.

ALARM CONTACT TYPE Select the type of contact that is connected to the alarm input terminal: **N/O** (normally open) or **N/C** (normally closed). The default is **N/O**.

RECORD MODE Set the recording behavior when this alarm is activated. The default is **SET**.

SET When the alarm is triggered, the unit records the alarmed channel at the full frame rate for the number of seconds specified in the RECORD TIME field. The unit ignores any alarm deactivation.

DURATION When the alarm is triggered, the unit records the alarmed channel at the full frame rate until the alarm is deactivated.

Channels that are programmed for alarm recording have precedence over channels that are not alarmed. When an alarm is triggered, the alarmed channel records at the per-image rate entered in the RECORDER SETUP menu. If the ips setting is relatively high, the recorded image rate of the alarmed channel approaches real-time viewing quality. If more than one alarmed channel is triggered, the ips rate is shared equally among the alarmed channels. All nonalarmed channel recording is halted for the duration of the alarm.

RECORD TIME **SET only:** Set the alarm record time for alarm activation. This setting ranges from 1 to 99 seconds. The default is **5** seconds.

ALARM RELAY OUT 1 Select **ON** to enable the first alarm relay output. If the alarm is activated, the unit closes alarm relay output 1 for the duration of alarm activation. Select **OFF** to disable this relay output.

ALARM RELAY OUT 2 Select **ON** to enable the second alarm relay output. If the alarm is activated, the unit closes alarm relay output 2 for the duration of alarm activation. Select **OFF** to disable this relay output.

NETWORK SETUP

Highlight the **NETWORK SETUP** option on the setup menu screen and press the **ENTER** button. The NETWORK SETUP screen is shown in Figure 15.

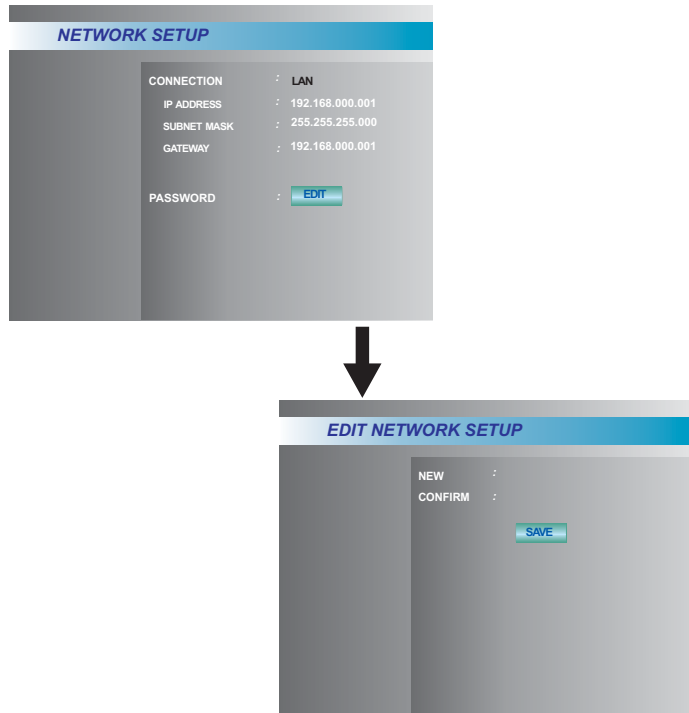

Figure 15. Network Setup Screen

NOTE: Only set up the following network parameters if you will access this unit over a network.

CONNECTION	For each of the following three fields, you must enter a valid network address. Each of the four IP address fields are separated by decimal points and have three digits that range from 000 to 255.
IP ADDRESS	Enter the IP address for the DX3100 on the TCP/IP network. Obtain a valid IP address from your network administrator. The default is 192.168.000.xxx , where xxx is the decimal equivalent of the hexadecimal value of the last byte of the network card address.
SUBNET MASK	Enter the subnet mask for the DX3100 on the TCP/IP network. Obtain the subnet mask from your network administrator. The default is 255.255.000.000 .
GATEWAY	Enter the address for the network gateway or router. Obtain the gateway address from your network administrator. This address is required for connecting to the unit remotely from outside of the network router. The default is 192.168.000.001 .
EDIT NETWORK PASSWORD	Connecting to the unit from a remote workstation requires a password. The default is 1981 . To edit this password, select EDIT and then press the ENTER button.
NEW	Enter a new four-digit password from the front panel or IR remote controller.
CONFIRM	Confirm the new password by entering it again from the front panel or IR remote controller.
SAVE	Save the new password.

Enter this password in the connection property sheet in the DX3100RX software (refer to *Connecting to the DX3100* in the *DX3100 Series Remote Site Software* manual).

SYSTEM STATUS AND UPGRADE

Highlight the **SYSTEM STATUS & UPGRADE** option on the setup menu screen and press the **ENTER** button. The SYSTEM STATUS & UPGRADE screen is shown in Figure 16. It provides access to important system details.

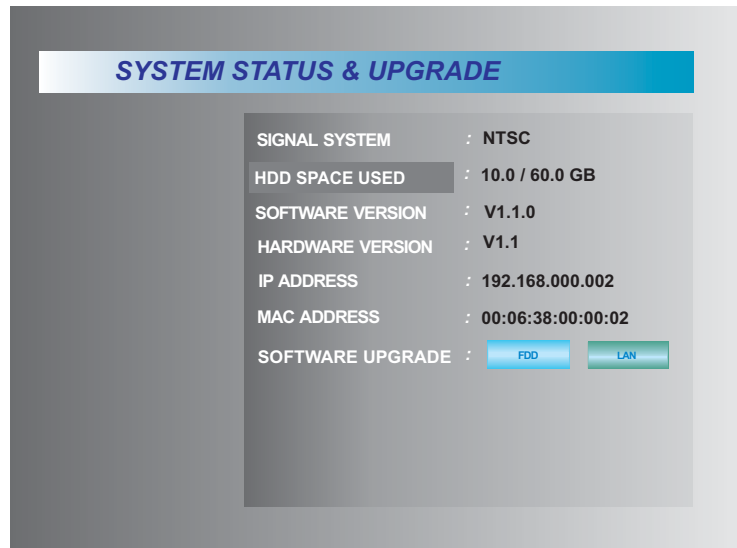

Figure 16. System Status Screen

SIGNAL SYSTEM	Displays the setting of the NTSC/PAL switch on the rear of the unit.
HDD SPACE USED	Displays the used storage space and the total available storage space.
SOFTWARE VERSION	Displays the version of the currently installed software.
HARDWARE VERSION	Displays the current hardware version.
IP ADDRESS	Displays the IP address for the unit that was entered on the NETWORK SETUP screen.
MAC ADDRESS	Displays the unique MAC (Media Access Control) address for the network interface card for the DX3100. The MAC address consists of six bytes of hexadecimal values.
SOFTWARE UPGRADE	Use this option to upgrade the DX3100 system software, either from a set of floppy diskettes or from a network drive. Refer to the <i>Software Upgrade</i> section in the <i>DX3100 Series Remote Site Software</i> manual for complete information.

ENG / DEU / ESP / FRA / POR (LANGUAGE)

Highlight the **ENG/DEU/ESP/FRA/POR** option on the setup menu screen and press the **ENTER** button. The language setup screen is shown in Figure 17.

NOTE: The DX3100 only supports English at present.



Figure 17. Language Setup Screen

LANGUAGE	Displays the language that has been set for the DX3100.
LOAD NEW	Select this option to change the system language.

OPERATION

The DX3100 offers three operating modes: LIVE VIEW, PLAYBACK, and PTZ.

LIVE VIEW mode displays live video from one or more channels (refer to *Live View Mode* for more information).

PLAYBACK mode lets you select and then view recorded video (refer to *Playback Mode* for more information).

PTZ mode lets you control PTZ-capable cameras (refer to *PTZ Mode* for more information).

SETUP mode lets you configure the DX3100 (refer to *Programming* for more information).

LIVE VIEW MODE

When first powered up, the DX3100 opens in LIVE VIEW mode. Figure 18 shows sample LIVE VIEW screens for the DX3108 (3x3 format) and the DX3116 (4x4 format).



DX3108



DX3116

Figure 18. DX3100 Sample LIVE VIEW Screens

Video from all active inputs is displayed on the monitor. The channel LED on the front panel also lights for each active input.

In LIVE VIEW mode, you can

- Display the on-screen overlay
- View live video from one or many active inputs
- Define and run channel display sequences

NOTE: When video is being recorded, "REC" appears at the bottom right of the screen. Its appearance is independent of the current screen format or view. For example, if input 10 is recording and input 12 is displayed, "REC" still appears on the screen. Use the **OSD** button to either hide or display "REC." The **OSD** button does not affect recording.

ON-SCREEN OVERLAY

The DX3100 displays the name for each channel, unit date and time, and record status as an on-screen overlay (refer to Figure 19). Press the **OSD** button to either hide or display this overlay. The **OSD** button does not affect recording.

NOTE: When the 3x3 screen format is selected, the DX3100 only displays the first 11 characters of each channel name. When the 4x4 screen format is selected, the DX3116 only displays the first seven characters of each channel name.



Figure 19. On-Screen Overlay

VIEWING VIDEO

Single Screen Viewing

To view a single channel full-screen, simply press the channel button for that display. In Figure 20, selecting channel 7 switches from the 4x4 format to a single screen. Selecting channel 12 switches channels, but keeps the full-screen format.

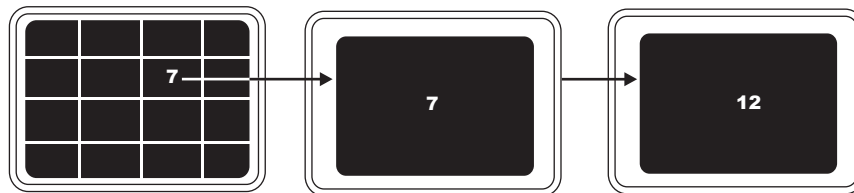

Figure 20. Channel Selection

On the IR remote controller, enter the number of the channel to view from the numeric keypad.

NOTE: To allow selection of channels 10 to 16, there is a one-second delay after you press the **1** button.

Multiple Screen Viewing

For multiple screen viewing, the DX3100 groups channels into specific sets for each screen format: 1x1, 2x2, 3x3, and 4x4. Table C identifies the channel sets for each screen format.

Table C. DX3100 Channel Sets

	DX3116	DX3108
1x1	16 "sets" One for each channel	8 "sets" One for each channel
2x2	Four sets Channels 1-4 Channels 5-8 Channels 9-12 Channels 13-16	Two sets Channels 1-4 Channels 5-8
3x3	Two sets Channels 1-9 Channels 8-16	One set Channels 1-8
4x4	One set Channels 1-16	

To view one (1x1), four (2x2), nine (3x3), or 16 (4x4) channels, press the screen format button on the front panel. The DX3100 displays the set of channels based on the previous screen format. For example, if you select 2x2 when channel 5 is displayed full-screen, the DX3100 displays channels 5-8.

To step through screen sets, press the screen format button again. When the last set is displayed, press the screen format button again to display the first set.

Figure 21 shows how to step through each screen set from the front panel. Each time you press the screen format button, the next set appears.

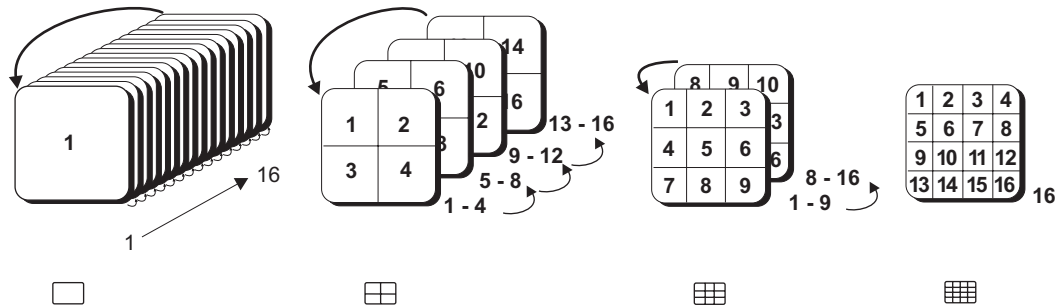

Figure 21. Stepping Through Screen Sets: Front Panel

When using the IR remote controller, you must step through screen sets in a linear fashion: full-screen channels followed by the 2x2, 3x3, and 4x4 sets (refer to Figure 22). Press the **+** button to advance through the channel sets (1x1, 2x2, 3x3, 4x4). Press the **-** button to step backward through the channel sets (4x4, 3x3, 2x2, 1x1).

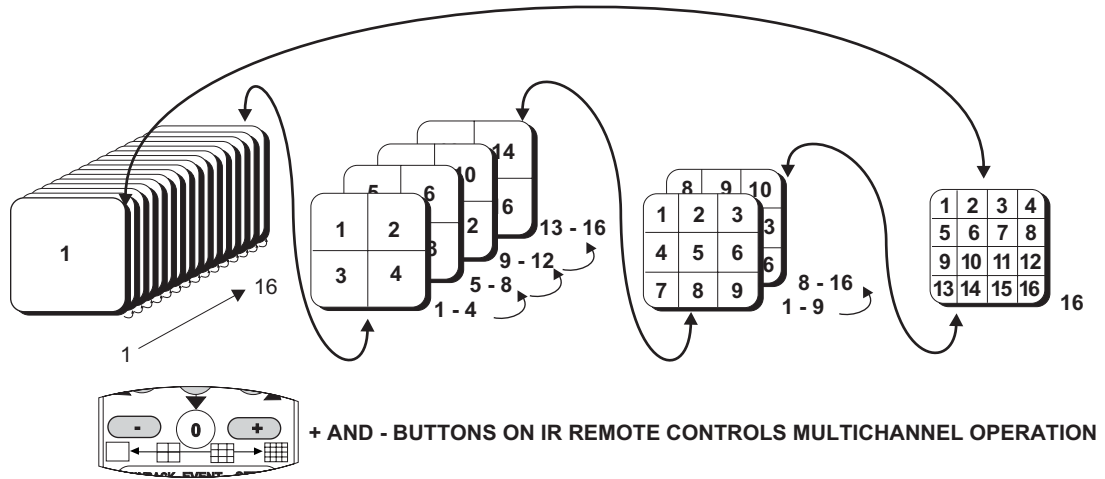

Figure 22. Stepping Through Screen Sets: IR Remote Control

Sequences

You can automate the process of displaying multiple channels and channel sets. Press the **SEQ** button to set up the sequence; “SEQ” appears on the top right of the screen. Select the channels and screen formats in their proper order. To stop sequencing, press the **SEQ** button again.

NOTE: To use sequencing, you must enable it in the RECORDER SETUP screen. You can also set the DWELL TIME, that is, how long each screen is displayed before the next screen in the sequence appears. Dwell time is a global item and applies equally to all sequence types.

NOTE: Sequence only displays channels with active video.

PLAYBACK MODE

Use PLAYBACK mode to view recorded video for a specific channel.

NOTE: In PLAYBACK mode, recorded video can only be displayed full-screen.

In PLAYBACK mode, you can

- Use several methods to locate specific segments of recorded video
- Save a particular frame or video image to a floppy diskette
- Access lists of system events, which include
 - System performance information, including each time the unit was either shut down or powered up
 - Recorded video grouped by alarm event and number, including the time and date of alarm events. Each alarm event can be accessed directly for immediate playback without performing time searches (refer to *Event* later in this manual)

NOTE: The compression structure of MPEG video data causes observational differences when using the step-forward and step-reverse controls. For more information, refer to *MPEG Structure and Frame Operations* later in this manual.

STARTING PLAYBACK MODE

Enter PLAYBACK mode from LIVE VIEW mode by pressing the **PLAYBACK** button. A sample of the opening on-screen overlay is shown in Figure 23.



Figure 23. Opening Playback Overlay

The DX3100 always defaults to channel 1 when you first enter PLAYBACK mode. When you select a different channel, the overlay appears for that channel.

The BEGIN and END fields on the overlay give the range of recorded video for the selected channel. The current END time does not change until you exit PLAYBACK mode.

NOTE: The time at the bottom of the screen applies to the last video image that was displayed. It has nothing to do with the current BEGIN-END timeline. The pause icon appears in the lower right corner.

Recorded video is not stored in one linear, contiguous track that stretches from the BEGIN to END time stamps. Instead, recorded video is stored in time files. Each channel is assigned its own set of time files.

Time files are each limited to one hour. At the end of an hour, the unit closes the current file for the channel and starts a new file.

When you enter PLAYBACK mode, the DX3100 makes all complete time files available for searching. Open time files, that is, files with less than one hour of video, are not available for searching. To view video from an open time file, refer to *Searching Open Time Files*.

ACCESSING RECORDED VIDEO

When you enter PLAYBACK mode for the first time, the unit automatically advances to the end of the last complete time file for channel 1 (refer to Figure 24).

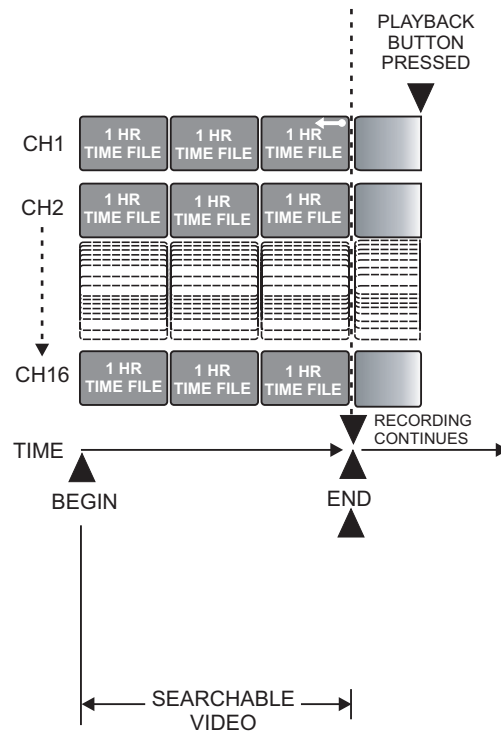

Figure 24. Playback Mode Entry Time Files

To view previously recorded video for a channel, you must “rewind” to the desired time file:

1. Press the play/pause button. The play icon appears on-screen.
2. Immediately press the fast reverse button. The reverse icon appears on-screen.
3. Press the play/pause button again. The play icon appears on-screen again.

You can use the three VCR-style control buttons to view the video. Whenever you press one of these control buttons, the BEGIN-END time overlay disappears.

When you return to PLAYBACK mode, the unit automatically returns to the time frame that was last accessed for channel 1.

SWITCHING CHANNELS

When you re-enter PLAYBACK mode, the unit automatically displays recorded video for channel 1. The unit automatically returns to the timeframe that was last accessed for channel 1.

To view video from a different channel, press the button for the desired channel. The on-screen overlay appears with the BEGIN and END fields, giving the range of recorded video for the channel.

When you switch to a different channel, the unit displays video from the same time frame for the new channel. Figure 25 shows what happens when you switch from channel 2 to channel 7 to channel 8. The unit accesses recorded video at the same time on each channel.

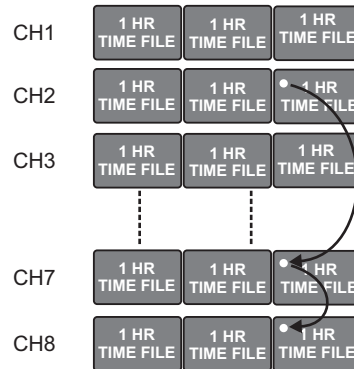

Figure 25. Play Back Different Channels

When you use any of the VCR-type controls, the BEGIN-END timeline disappears from the screen. The time frame for the channel also moves. If you switch to a different channel, the unit displays video from the new time frame as well as the on-screen overlay with the BEGIN and END fields.

SEARCHING FOR SPECIFIC VIDEO

In addition to switching to a different channel, you can switch to video at an earlier or a later point in time. Then you can switch to a different channel, based on the new time frame.

To access a different time frame, use one of the following methods to select the desired date and time:

- DX3100 Front Panel:
 1. Press the ← and → buttons to select a field to change: month, day, year, hour, minutes.
 2. Press the ↑ and ↓ buttons to increase or decrease the field value.
 3. Press the **ENTER** button.
 4. Use the VCR-type controls to playback video.
- IR Remote Controller:
 1. Press the + or - button for **DAY**, **HOUR**, and **MIN** to select the desired date and time.
 2. Press the **ENTER** button.
 3. Use the VCR-type controls to playback video.

NOTE: There is no cursor movement when using the IR Remote Controller to select a date and time.

In Figure 26, the user switches from channel 1 to channel 2, keeping the same time frame. Then the user backs up a couple of hours. When the user switches to channel 8, the DX3100 maintains the new time frame.

NOTE: If you select a date and time, but do not press the **ENTER** button, the DX3100 will ignore your date and time parameters.

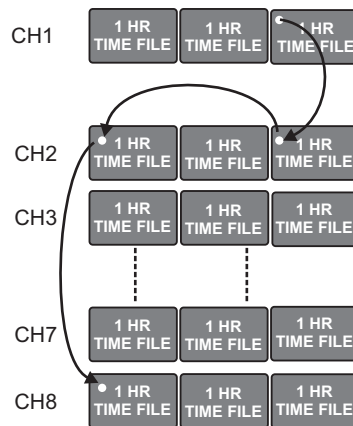

Figure 26. Switching Channels and Time Frames

SEARCHING OPEN TIME FILES

You can only search for video within closed time files. For example, if it is 10:40 a.m., you can search all files with video prior to 10:00 a.m. However, you can close an open time file and then play it back. In this example, this would include video that has been recorded since 10:00 a.m.

To play back recorded video for an open time file, use the following procedure:

1. Press the **PLAYBACK** button to enter PLAYBACK mode. This takes you to the last point in time that a search was done. The date and time probably differ greatly from the current date and time.
2. Identify the date and time to view. In the above example, you may want to view video that was recorded at 10:30 a.m.
3. Set the date and time to the time frame to observe. Using the above example, you might enter 10:20 a.m.

NOTE: You can only search open time files that are at least five minutes old.

4. As soon as you press the **ENTER** button, the DX3100 closes the open time file. Now you can search and play back video up to the time the file was closed.

When you close an open time file, the system updates the END time that appears on the monitor when you open PLAYBACK mode again.

The remaining portion of the normal time file (in this case, 10:20 to 11:00 a.m.) becomes the second time file for the 10:00 a.m. to 11:00 a.m. time slot. You created the first file when you closed the open time file. The unit creates the second file when it closes the open time file at 11:00 a.m.

SEARCHING VIDEO DURING CHANGE TO DAYLIGHT SAVING TIME

You must perform a special file search to view time files created during the switch to daylight saving time in the fall of the year. The unit creates two time files, both marked with the same start and stop times. However, they contain totally different video images. Refer to Figure 27, which illustrates both the problem and several solutions.

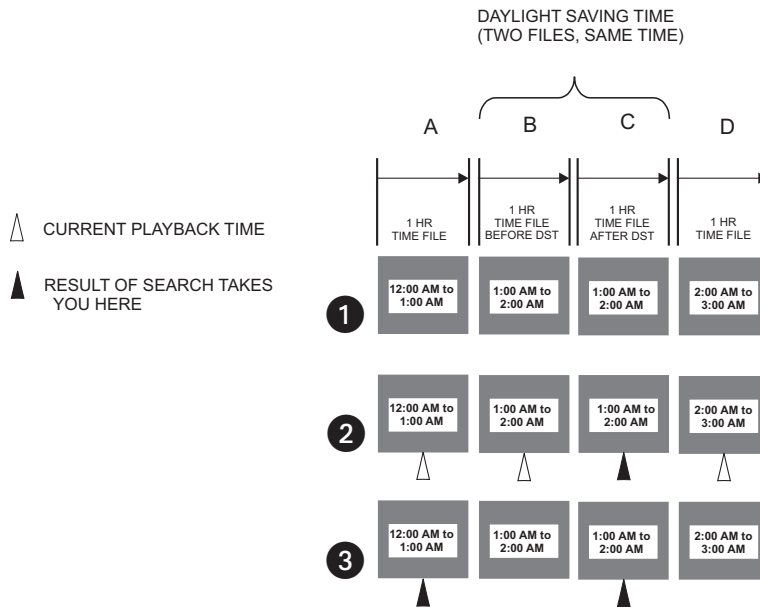

Figure 27. Searching DST Files

- 1 The first line shows two time files, one (B) for the hour before the time change and one (C) for the hour after the time change. Both are marked 1:00 a.m. to 2:00 a.m.
- 2 The second line shows that any search from blocks A, B, C, or D identifies block C.
- 3 The third line shows that you can search for block A, which is marked 12:00 a.m. to 1:00 a.m. Then play video forward past 1:00 a.m. You can also search for block C and play video backward into block B.

NOTE: Block C cannot be accessed from a remote workstation using the DX3100RX software.

MPEG STRUCTURE AND FRAME OPERATIONS

There is a difference between the displayed time index during step-forward and step-backward operations. This results from the compression techniques used in MPEG.

When video is recorded, the DX3100 does not store every piece of information contained in each video frame. Otherwise, the file would be too large. Instead, the unit stores all of the information in some video frames. These complete frames are called I-frames.

The unit also creates P-frames between successive I-frames. P-frames contain only the changes since the previous I-frame or P-frame.

Because of this construction, a step-forward command displays video on a frame-by-frame basis. However, this is not possible when stepping backward. The step-backward command causes jumps from one I-frame backward to the previous I-frame because P-frames do not contain reverse direction changes.

Also, if you pause forward video playback and it stops between I-frames, the video will skip to the next I-frame when playback is resumed. To view the skipped P-frames, rewind past a couple of I-frames and play the video forward again.

SAVING IMAGES TO FLOPPY DISKETTE

The FDD function saves the currently displayed video image to a floppy diskette. You must be in PLAYBACK mode. To save the image, perform the following:

1. Insert a formatted floppy diskette into the diskette drive.
2. Make sure the image to save is currently on-screen.
3. Press the **FDD** button on the front panel. On the IR remote controller, press the **PTZ** button.
4. The on-screen display will read

"NETWORK IS STOPPED"
"WRITING IMAGE FILE DATA TO FLOPPY"
"DATA WRITING IS COMPLETE"

After the image file has been saved, the on-screen display reads

"NETWORK IS RESTARTED"

The DX3100 writes two image files to the diskette. The .mpg file can be viewed on many different platforms by any standard MPEG-1 player. However, .mpg files are not encrypted and can therefore be easily altered or forged.

The .dsf file can only be viewed with the DX3100RX software. It has an over-128-bit encryption key so it cannot be altered or forged. It is very secure. However, it cannot be viewed on many different platforms.

NOTE: Images stored in the .dsf or .mpg files consist of 16 consecutive images that include the selected (displayed) image. The selected image may appear anywhere among the 16 images; it is not fixed. These images are called a GOP (Group Of Pictures) that consists of one I-frame and 15 P-frames according to MPEG-1 structure.

NOTE: If an alarm is triggered during an image-saving operation, the saving operation will finish before the unit processes the alarm.

EVENT

Press the **EVENT** button to display a list of dates with recorded video (refer to Figure 28). Press the up and down arrow buttons to select a date. The events for a date are listed as you step through each date. Press the right arrow button to move the cursor to the event list for the selected date. Then press the up and down arrow buttons to locate a specific event for the specific date.

To exit the event display, press the **EVENT** button again.

NOTE: You can also display event dates by pressing the **SEQ** button on the IR remote controller while in PLAYBACK mode.



Figure 28. Event Display

The event display contains data about important system events. These include the following:

1. The time the unit was powered on or off normally.
2. The time the machine was powered on after an abnormal power interruption.
3. Specific information about alarm events.

To play back video from a specific alarm event, navigate to the event, for example, ALARM001-CH01. When you press the **ENTER** button, the unit jumps to the start of the recorded video for that alarm. Use the VCR-type controls to play back the video full-screen at its recorded rate.

NOTE: Global events include DVR POWER ON and DVR POWER OFF, which are not channel-specific. Local events include ALARMxxx-CHyy, which gives an alarm event number for each channel.

PTZ MODE

PTZ (pan/tilt/zoom) mode lets you control camera movement from the DX3100. Before you can control a camera, make sure the camera is configured for PTZ operation (refer to *Receiver Wiring, Recorder Setup and Camera Setup*).

To operate a PTZ camera, press the **PTZ** button. The PTZ instructions appear briefly on the monitor (refer to Figure 29). If PTZ is not enabled on the DX3100, the unit displays the following message:

“NO CAMERA WITH P/T/Z ENABLED”

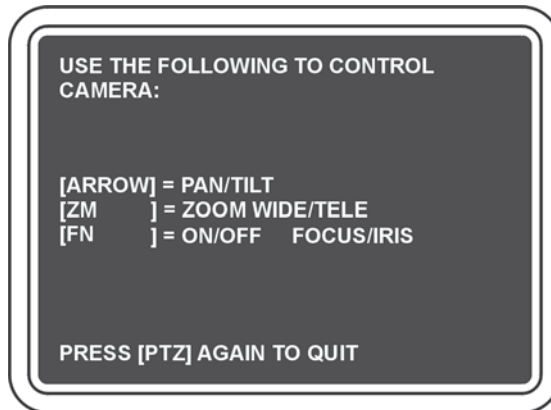

Figure 29. PTZ Instructions

Press the button for the camera to control. Then press the direction arrow buttons to move the camera. If the camera is not PTZ-capable, the unit displays the following message:

“P/T/Z OF CHyy IS DISABLED”

To exit PTZ mode, press the **PTZ** button.

ARROW BUTTONS: FRONT PANEL VS. REMOTE

Pressing the arrow buttons on the front panel operates slightly different than pressing the arrow buttons on the IR remote controller. When you press an arrow button on the front panel, the camera moves in that direction until you release the button; then camera motion stops. When you press an arrow button on the IR remote controller, the camera continues to move in that direction. You must press the same arrow button again to stop camera movement in that direction. You can also press a different arrow button to immediately start moving the camera in a different direction; you do not have to stop it first.

ZOOMING

To zoom in, press the **ZM TELE** button on the front panel or the **ZOOM IN** button on the IR remote controller.

To zoom out, press the **ZM WIDE** button on the front panel or the **ZOOM OUT** button on the IR remote controller. You cannot use both arrow buttons and zooming buttons at the same time.

LENS FUNCTIONS

In PTZ mode, you can focus near or far and also open or close the iris.

To access these functions from the front panel, press the **FN** button. "FN" appears next to "PTZ" at the top of the screen. Press the **FOCUS NEAR** or **FOCUS FAR** buttons to focus the camera. Press the **IRIS CLOSE** or **IRIS OPEN** buttons to close or open the iris. When you are finished, press the **FN** button again. "FN" disappears from the top of the screen.

To focus the camera using the IR remote controller, press the **FOCUS NEAR** or **FOCUS FAR** buttons. To adjust the iris opening using the IR remote controller, press the **IRIS +** or **IRIS -** buttons.

PTZ TROUBLESHOOTING

If you cannot control a PTZ camera, check the following:

1. Verify the PTZ protocol setting in the RECORDER SETUP screen on the DX3100 against the protocol setting on all receivers.
2. Verify that the receiver baud rate setting matches the baud rate for the PTZ protocol (PELCO D or PELCO P).
3. Verify that the camera address for each receiver matches the PTZ RX address for the camera in the CAMERA SETUP screen on the DX3100.
4. Verify that the switch on the RS-232 to RS-422/RS-485 converter is set to DCE.
5. Verify that receiver power is turned on.
6. Verify that the wires between the DX3100 and the receivers are connected correctly.
7. Verify that all connector and wire contacts are secure.
8. Check for broken wires.

ALARM DISPLAY ISSUES

You can view alarm video in two ways. You can search for and play back video from specific alarm events (refer to *Playback Mode*). You can also view alarm event video in real time, as the event occurs, as a natural consequence of alarm wiring and programming.

When there is a valid alarm event, the DX3100 performs the following steps:

1. The unit immediately directs system control to record and display the alarm event. This is done regardless of any user pre-alarm activity.
2. The channel associated with the alarm is displayed full-screen, if there is only one alarm.
3. The total available record rate (30 ips for NTSC) is used to record and display the alarm on the monitor. If more than one alarm occurs, the ips rate is shared between active alarms.
4. Alarm events are displayed as they occur. If a second alarm occurs, the screen format changes to 2x2 so that video from both alarms can be displayed. If more than four alarms occur, the screen format changes to 3x3. For example, if Channel 1 and Channel 5 are both alarmed at the same time, video from each will appear in the top left and top right panes of the 2x2 display format.

NOTE: The unit displays alarm text information at the lower right of the screen. This text appears in the format: ALARM * * * *. The asterisks are placeholders for active alarm inputs 1 through 4. For example, "ALARM *2 * 4" appears when alarm inputs 2 and 4 are active; in this example, alarm inputs 1 and 3 are not active.

5. When all alarms have ceased, either because the alarm record time has elapsed or the alarm has been reset, the existing display after the last occurring alarm remains on-screen. The system does not return to the pre-alarm position. However, you can resume normal system operation and manually return to the pre-alarm display using normal button functions.
6. When an alarm event occurs on the DX3100, the remote software (DX3100RX) disconnects all live and playback video currently being viewed.

SPECIFICATIONS

ELECTRICAL/VIDEO

Input Voltage:	115/230 VAC switchable, 50/60 Hz
Power Consumption:	60 W maximum
Signal System:	NTSC/PAL switchable
CPU information (all models)	
CPU:	Hitachi SH-3
RAM:	32 MB
Flash Memory:	8 MB
Image Size	
NTSC:	352 x 240 or 640 x 240
PAL:	352 x 240 or 640 x 240
Video Storage	
DX3108-060:	60 GB hard drive
DX3108-120:	120 GB hard drive
DX3108-240:	Two 120 GB hard drives
DX3116-060:	60 GB hard drive
DX3116-120:	120 GB hard drive
DX3116-240:	Two 120 GB hard drives
Compression:	Enhanced MPEG
Monitor Output:	Analog composite video
Video Inputs	
Number:	8 (DX3108 models) or 16 (DX3116 models)
Signal:	1.0 Vp-p, 75 ohms
Looping Video Outputs	
Number:	8 (DX3108 models) or 16 (DX3116 models)
Signal:	1.0 Vp-p, 75 ohms
Alarms	
Input:	4, dry contact type
Output:	2 relay outputs, maximum 1 A
Pan/Tilt/Zoom Control:	RS-232 to RS-422/RS-485 interface to receivers
Remote Control:	LAN, WAN, or Internet-based TCP/IP

GENERAL

Ambient Operating Temperature:		41°F to 104°F (5°C to 40°C)
Relative Humidity:		Maximum 80% noncondensing
Dimensions:		3.5 (H) x 17.3 (W) x 18.3 (D) inches (8.8 x 44.0 x 46.5 cm)
Weight:		
	Unit	Shipping
DX3108-060	23.5 lb (10.7 kg)	35 lb (15.9 kg)
DX3116-060	23.5 lb (10.7 kg)	35 lb (15.9 kg)
DX3108-120	23.5 lb (10.7 kg)	35 lb (15.9 kg)
DX3116-120	23.5 lb (10.7 kg)	35 lb (15.9 kg)
DX3108-240	25.0 lb (11.3 kg)	36 lb (16.3 kg)
DX3116-240	25.0 lb (11.3 kg)	36 lb (16.3 kg)

WARRANTY AND RETURN INFORMATION

WARRANTY

Pelco will repair or replace, without charge, any merchandise proved defective in material or workmanship for a period of one year after the date of shipment. Exceptions to this warranty are as noted below:

- Five years on Pelco manufactured cameras (CC3500/CC3600/CC3700 and MC3500/MC3600 Series); two years on all other cameras.
- Three years on Genex® Series (multiplexers, server, and keyboard) and 090 Series Camclosure® Camera System.
- Two years on 100/150, 200 and 300 Series Camclosure® Camera Systems.
- Two years on cameras and all standard motorized or fixed focal length lenses.
- Two years on Legacy®, CM6700/CM6800/CM6800E/CM8500/CM9500/CM9740/CM9760 Matrix, DF5 and DF8 Series Fixed Dome products.
- Two years on Spectra®, Esprit®, and PS20 Scanners, including when used in continuous motion applications.
- Two years on Esprit and WW5700 series window wiper (excluding wiper blades).
- Eighteen months on DX Series digital video recorders.
- One year (except video heads) on video cassette recorders (VCRs). Video heads will be covered for a period of six months.
- Six months on all pan and tilts, scanners or preset lenses used in continuous motion applications (that is, preset scan, tour and auto scan modes).

Pelco will warrant all replacement parts and repairs for 90 days from the date of Pelco shipment. All goods requiring warranty repair shall be sent freight prepaid to Pelco, Clovis, California. Repairs made necessary by reason of misuse, alteration, normal wear, or accident are not covered under this warranty.

Pelco assumes no risk and shall be subject to no liability for damages or loss resulting from the specific use or application made of the Products. Pelco's liability for any claim, whether based on breach of contract, negligence, infringement of any rights of any party or product liability, relating to the Products shall not exceed the price paid by the Dealer to Pelco for such Products. In no event will Pelco be liable for any special, incidental or consequential damages (including loss of use, loss of profit and claims of third parties) however caused, whether by the negligence of Pelco or otherwise.

The above warranty provides the Dealer with specific legal rights. The Dealer may also have additional rights, which are subject to variation from state to state.

If a warranty repair is required, the Dealer must contact Pelco at (800) 289-9100 or (559) 292-1981 to obtain a Repair Authorization number (RA), and provide the following information:

1. Model and serial number
2. Date of shipment, P.O. number, Sales Order number, or Pelco invoice number
3. Details of the defect or problem

If there is a dispute regarding the warranty of a product which does not fall under the warranty conditions stated above, please include a written explanation with the product when returned.

Method of return shipment shall be the same or equal to the method by which the item was received by Pelco.

RETURNS

In order to expedite parts returned to the factory for repair or credit, please call the factory at (800) 289-9100 or (559) 292-1981 to obtain an authorization number (CA number if returned for credit, and RA number if returned for repair).

All merchandise returned for credit may be subject to a 20% restocking and refurbishing charge.

Goods returned for repair or credit should be clearly identified with the assigned CA or RA number and freight should be prepaid. Ship to the appropriate address below.

If you are located within the continental U.S., Alaska, Hawaii or Puerto Rico:

Service Department
Pelco
3500 Pelco Way
Clovis, CA 93612-5699

If you are located outside the continental U.S., Alaska, Hawaii or Puerto Rico:

Intermediate Consignee
American Overseas Air Freight
320 Beach Road
Burlingame, CA 94010
USA

Ultimate Consignee
Pelco
3500 Pelco Way
Clovis, CA 93612-5699
USA

REVISION HISTORY

Manual #	Date	Comments
C695M	3/03	Original version.
C695M-A	9/03	Revised storage calculations and added note.
C695M-B	11/03	Reorganized manual for clarity and ease of use. Updated warnings information. Updated descriptions of front panel and IR remote controller buttons.



World Headquarters
3500 Pelco Way
Clovis, California 93612 USA

USA & Canada
Tel: 800/289-9100
Fax: 800/289-9150

International
Tel: 1-559/292-1981
Fax: 1-559/348-1120

www.pelco.com

ISO9001

Orangeburg, New York | Las Vegas, Nevada | Eindhoven, The Netherlands | Wokingham, United Kingdom | Montreal, Canada | Singapore

Free Manuals Download Website

<http://myh66.com>

<http://usermanuals.us>

<http://www.somanuals.com>

<http://www.4manuals.cc>

<http://www.manual-lib.com>

<http://www.404manual.com>

<http://www.luxmanual.com>

<http://aubethermostatmanual.com>

Golf course search by state

<http://golfingnear.com>

Email search by domain

<http://emailbydomain.com>

Auto manuals search

<http://auto.somanuals.com>

TV manuals search

<http://tv.somanuals.com>