



by **Schneider** Electric

**INSTALLATION/OPERATION**

## **IX Series Network Camera**



**Sarix™ Technology**

**C2950M-E (8/10)**



# Contents

---

Important Notices .....	6
Legal Notice .....	6
Regulatory Notices .....	6
Video Quality Caution .....	6
Frame Rate Notice Regarding User-Selected Options .....	6
Open Source Software Notice .....	6
Introduction .....	7
Models .....	7
Getting Started .....	7
Parts List .....	7
Product Overview .....	8
Product Label .....	9
Installation .....	10
Service Cable .....	12
Wiring .....	13
Cat5 Cable .....	13
Alarm, Relay, and 24 VAC Connector .....	14
Operation .....	17
Camera Configuration Sequence .....	17
Minimum System Requirements .....	17
Accessing the IP Camera .....	18
Logging on to the Camera .....	18
Live Video Page .....	19
Live Video Page Icons .....	20
Selecting a Stream .....	21
Primary Stream and Secondary Stream .....	21
QuickView Stream .....	21
Event Stream .....	22
Unicast .....	22
Multicast .....	22
Taking a Snapshot .....	22
Displaying Video in the Multiscreen View .....	22
Settings Page .....	23
Accessing the Camera Menus .....	23
System Tab .....	24
Changing the Device Name .....	24
Configuring the Time Settings .....	25
Customizing the Appearance of the Text Overlay .....	25
Generating a System Log .....	25
Rebooting the Camera .....	25
Restoring All Camera Defaults .....	26
Network Tab .....	27
Changing the Hostname .....	28
Turning On DHCP .....	28
Turning Off DHCP .....	28
Selecting the Secure Sockets Layer Mode .....	29
Generating a Certificate Request .....	30
Generating a Self-Signed Certificate .....	30
Enabling Secure Shell .....	31
Configuring the 802.1x Port Security Settings .....	31
Selecting SNMP Settings .....	32
Configuring SNMP V2c .....	32
Configuring SNMP V3 .....	33

Imaging Tab .....	34
Configuring the Orientation of the Scene .....	35
Changing the Digital Processing Settings .....	36
Selecting Auto Exposure Settings .....	37
Selecting Manual Exposure Settings .....	39
Day Night Settings .....	40
Day Night Auto and Manual Modes .....	40
Day Night Auto Mode .....	40
Day Night Manual Mode .....	40
Configuring Auto Focus Settings .....	41
Configuring Manual Focus Settings .....	42
Setting Tone Map Options .....	43
Selecting Auto White Balance Settings .....	44
Selecting Manual White Balance Settings .....	45
Turning On Window Blanking .....	46
Turning Off Window blanking .....	46
Deleting a Window Blanking Area .....	46
A/V Streams Tab .....	47
Selecting a Video Preset Configuration .....	48
Configuring a Custom Video Stream Configuration .....	49
Compression Standards .....	50
Available Camera Resolution .....	50
Image Rate .....	50
Bit Rate .....	51
I-Frame Interval .....	51
Quality of Service for Differentiated Services Code Point .....	51
Endura Signing .....	51
Advanced Sharpening .....	51
Selecting the Audio Configuration Settings .....	52
Users Tab .....	53
Selecting the Users and Groups Settings .....	54
Creating a New User .....	55
Editing a User .....	56
Deleting A User .....	56
Events Tab .....	57
Sources .....	58
Creating an Alarm Event Source .....	58
Creating a System Event Source .....	59
Creating a Timer Event Source .....	59
Editing an Event Source .....	59
Deleting an Event Source .....	59
Handlers .....	60
Creating an Event Handler: Send Email .....	61
Creating an Event Handler: Write JPEG to SD Card .....	62
Creating an Event Handler: Upload JPEG to FTP Server .....	62
Creating an Event Handler: Open/Close Relay .....	63
Editing an Event Handler .....	63
Deleting an Event Handler .....	63
Example Handler Filter Setup .....	64
Analytic Configuration .....	65
Creating a new Profile .....	66
Revising A Profile .....	66
Deleting a Profile .....	66
Specifications .....	67
IXS0 Series .....	67
IX10 Series .....	69
IX30 Series .....	71

# List of Illustrations

---

1	Camera Connections and Features	8
2	Remove Back Cover	9
3	Product Label	9
4	Lens Pin Connections	10
5	Ferrite Installation	11
6	Attaching the 2.5 mm Stereo Headphone Plug	12
7	Cat5 Cable Pin Descriptions	13
8	Alarm, Relay, and 24 VAC Connector	14
9	Relay Wiring	14
10	Supervised Alarm Conditions	15
11	Supervised Alarm Input Wiring	15
12	Unsupervised Alarm Conditions	16
13	Normally Closed and Normally Open Unsupervised Alarm Input Wiring	16
14	Alarm Connections	16
15	Live Video Page	19
16	SSL Configuration Page	29
17	SSH Settings Page	31
18	SNMP V2c Settings	32
19	SNMP V3 Settings	33
20	Orientation Page	35
21	Digital Processing Page	36
22	Auto Exposure Page	37
23	Manual Exposure Page	39
24	Auto Focus Page	41
25	Manual Focus Page	42
26	Tone Map Page	43
27	Auto White Balance Page	44
28	Manual White Balance Page	45
29	Window Blanking Page	46
30	Select Video Preset Configuration Page	48
31	Custom Video Stream Configuration Page	49
32	Audio Configuration Page	52
33	General Settings Page for Users	54
34	Users Page	55
35	New Event Source Page	58
36	New Event Handler Page	60
37	Analytic Configuration Page	65

# Important Notices

---

## LEGAL NOTICE

SOME PELCO EQUIPMENT CONTAINS, AND THE SOFTWARE ENABLES, AUDIO/VISUAL AND RECORDING CAPABILITIES, THE IMPROPER USE OF WHICH MAY SUBJECT YOU TO CIVIL AND CRIMINAL PENALTIES. APPLICABLE LAWS REGARDING THE USE OF SUCH CAPABILITIES VARY BETWEEN JURISDICTIONS AND MAY REQUIRE, AMONG OTHER THINGS, EXPRESS WRITTEN CONSENT FROM RECORDED SUBJECTS. YOU ARE SOLELY RESPONSIBLE FOR INSURING STRICT COMPLIANCE WITH SUCH LAWS AND FOR STRICT ADHERENCE TO ANY/ALL RIGHTS OF PRIVACY AND PERSONALTY. USE OF THIS EQUIPMENT AND/OR SOFTWARE FOR ILLEGAL SURVEILLANCE OR MONITORING SHALL BE DEEMED UNAUTHORIZED USE IN VIOLATION OF THE END USER SOFTWARE AGREEMENT AND RESULT IN THE IMMEDIATE TERMINATION OF YOUR LICENSE RIGHTS THEREUNDER.

## REGULATORY NOTICES

This device complies with Part 15 of the FCC Rules. Operation is subject to the following two conditions: (1) this device may not cause harmful interference, and (2) this device must accept any interference received, including interference that may cause undesired operation.

### RADIO AND TELEVISION INTERFERENCE

This equipment has been tested and found to comply with the limits of a Class B digital device, pursuant to Part 15 of the FCC Rules. These limits are designed to provide reasonable protection against harmful interference in a residential installation. This equipment generates, uses, and can radiate radio frequency energy and, if not installed and used in accordance with the instructions, may cause harmful interference to radio communications. However there is no guarantee that the interference will not occur in a particular installation. If this equipment does cause harmful interference to radio or television reception, which can be determined by turning the equipment off and on, the user is encouraged to try to correct the interference by one or more of the following measures:

- Reorient or relocate the receiving antenna.
- Increase the separation between the equipment and the receiver.
- Connect the equipment into an outlet on a circuit different from that to which the receiver is connected.
- Consult the dealer or an experienced radio/TV technician for help.

You may also find helpful the following booklet, prepared by the FCC: "How to Identify and Resolve Radio-TV Interference Problems." This booklet is available from the U.S. Government Printing Office, Washington D.C. 20402.

Changes and Modifications not expressly approved by the manufacturer or registrant of this equipment can void your authority to operate this equipment under Federal Communications Commission's rules.

This Class B digital apparatus complies with Canadian ICES-003.

Cet appareil numérique de la classe B est conforme à la norme NMB-003 du Canada.

## VIDEO QUALITY CAUTION

### FRAME RATE NOTICE REGARDING USER-SELECTED OPTIONS

Pelco systems are capable of providing high quality video for both live viewing and playback. However, the systems can be used in lower quality modes, which can degrade picture quality, to allow for a slower rate of data transfer and to reduce the amount of video data stored. The picture quality can be degraded by either lowering the resolution, reducing the picture rate, or both. A picture degraded by having a reduced resolution may result in an image that is less clear or even indiscernible. A picture degraded by reducing the picture rate has fewer frames per second, which can result in images that appear to jump or move more quickly than normal during playback. Lower frame rates may result in a key event not being recorded by the system.

Judgment as to the suitability of the products for users' purposes is solely the users' responsibility. Users shall determine the suitability of the products for their own intended application, picture rate and picture quality. In the event users intend to use the video for evidentiary purposes in a judicial proceeding or otherwise, users should consult with their attorney regarding any particular requirements for such use.

## OPEN SOURCE SOFTWARE NOTICE

This product includes certain open source or other software originated from third parties that is subject to the GNU General Public License (GPL), GNU Library/Lesser General Public License (LGPL) and different and/or additional copyright licenses, disclaimers, and notices.

The exact terms of GPL, LGPL, and some other licenses are provided to you with this product. Please refer to the exact terms of the GPL and LGPL at <http://www.fsf.org> (Free Software Foundation) or <http://www.opensource.org> (Open Source Initiative) regarding your rights under said license. You may obtain a complete corresponding machine-readable copy of the source code of such software under the GPL or LGPL by sending your request to [digitalsupport@pelco.com](mailto:digitalsupport@pelco.com), the subject line should read *Source Code Request*. You will then receive an email with a link for you to download the source code.

This offer is valid for a period of three (3) years from the date of the distribution of this product by Pelco.

# Introduction

---

The IX Series camera is a network-based camera with a built-in, Web-based viewer for live streaming to a standard Web browser (Microsoft® Internet Explorer® or Mozilla® Firefox®). All camera models are preloaded with Pelco's Camera Sabotage behavior, which can be configured and enabled using a standard Web browser.

The camera features open architecture connectivity for third-party applications and is Endura Enabled™ and compatible with Digital Sentry® to record, manage, configure, and view multiple live streams. Some models are also compatible with DX8100 Series and DVR5100 Series digital video recorders.

The camera supports up to three compression formats and many resolutions. The two standard compression formats include H.264 and MJPEG. MPEG-4 is also available with IXS0 models. The dual streams can be configured to a variety of resolutions, frame rates, and bit rates.

The camera includes 0.5, 1.3, and 3.1 megapixel models available in two camera styles: color or day/night. The day/night models have a mechanical IR cut filter that increases camera sensitivity in low light situations. The camera uses a 1/3-inch imager and accommodates CS-mount lenses.

The camera also includes built-in Power over Ethernet (PoE), which supplies power to the camera through the network. If PoE is not available, the camera is prewired for 24 VAC.

## MODELS

IXS0C	Sarix IX Series, network camera, 0.5 megapixel standard definition color
IXS0DN	Sarix IX Series, network camera, 0.5 megapixel standard definition day/night
IX10C	Sarix IX Series, network camera, 1.3 megapixel color
IX10DN	Sarix IX Series, network camera, 1.3 megapixel day/night
IX30C	Sarix IX Series, network camera, 3.1 megapixel color
IX30DN	Sarix IX Series, network camera, 3.1 megapixel day/night

## Getting Started

Before installing your camera, thoroughly familiarize yourself with the information in this section.

### NOTES:

- Pelco recommends connecting the camera to a network that uses a Dynamic Host Configuration Protocol (DHCP) server to address devices.
- Do not use a network hub when configuring the network settings for the camera.
- To ensure secure access to the IP camera, place the camera behind a firewall when it is connected to a network.

## PARTS LIST

### Qty Description

- 1 Camera
- 1 Ferrite (for Class B compliance)
- 1 6-pin connector
- 1 IX Series Quick Start Guide
- 1 Resource disc
- 3 MAC address labels (extra)

Installation tools and the following parts are needed but not supplied

### Qty Description

- 1 Lens (use either a megapixel or standard auto iris lens, depending on the camera model)
- 1 Service cable (IX-SC)
- 1 Mounting hardware

## PRODUCT OVERVIEW

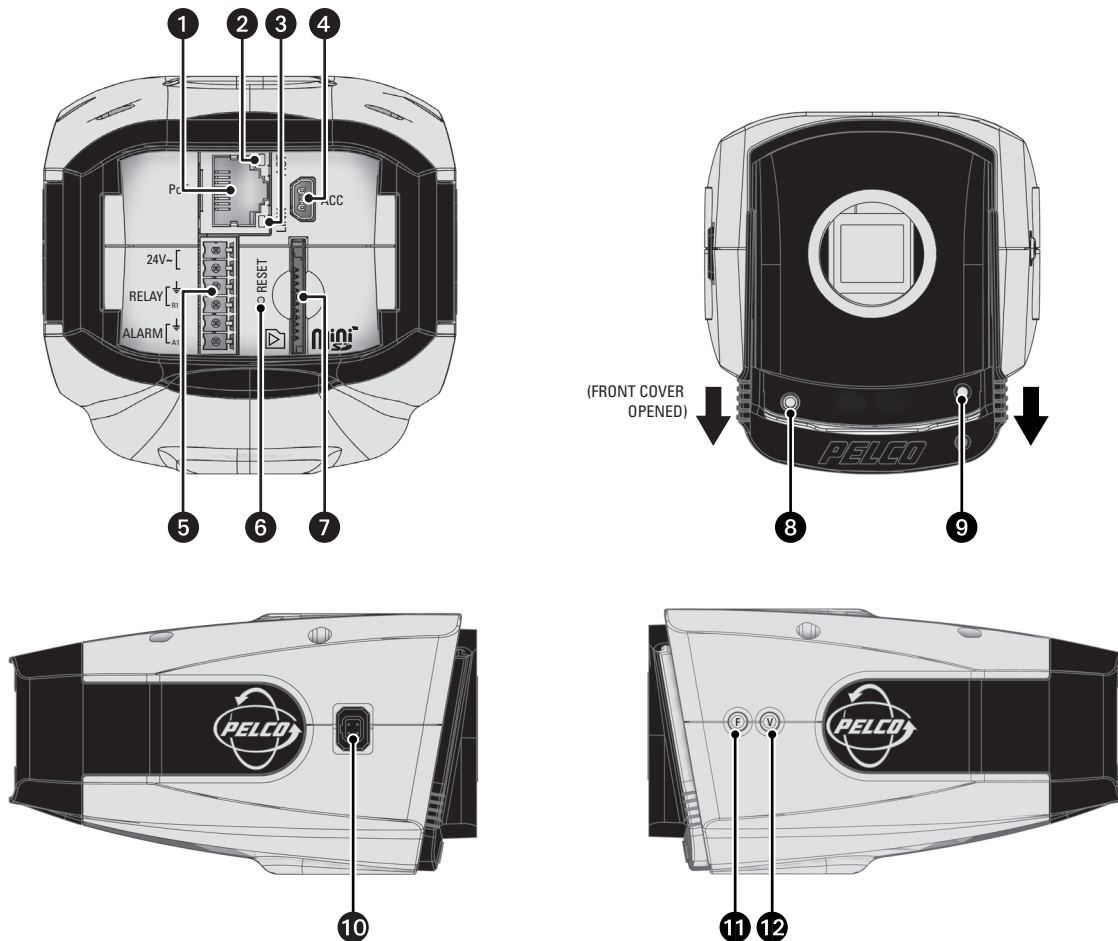

**Figure 1. Camera Connections and Features**

- ❶ **RJ-45 Network Port:** Connects the camera to the IP network. Also supplies power to the camera through the network using PoE. If PoE is not available, the camera is prewired for 24 VAC.
- ❷ **Ethernet Activity LED:** Flashes green to indicate that data is being transmitted or received by the camera.
- ❸ **Ethernet Link LED:** Glows solid amber to indicate that a live network connection is established.
- ❹ **Accessory Port:** For use with compatible Pelco accessories.
- ❺ **24 VAC Power, Relay, and Alarm Connections:** Supports 24 VAC as the power source, one relay that can be used to control an external circuit, and one alarm for physical input into the system.
- ❻ **Reset Button:** Reboots the camera or restores the camera's factory default settings. This button is recessed. Using a small tool, such as a paper clip, press and release the reset button once to reboot the camera. Press and hold the reset button until the green light inside the SD card slot flashes orange to restore the camera to the factory default settings.
- ❼ **Mini SD Card Slot:** Saves a snapshot image to a mini SD card based on alarm activity.  
**NOTE:** The mini SD card must be formatted as FAT32. Other formats are not compatible with the camera.
- ❽ **Service Port:** Outputs analog video. Use this port at the installation site to set up the field of view and to focus the camera. When a service cable is connected to the camera, video to the IP stream is disabled (refer to *Service Cable* on page 12).
- ❾ **Power LED:** Glows solid amber and then flashes green during the configuration sequence; glows solid green after the sequence is complete. The LED can be disabled (refer to *System Tab* on page 24). If this LED glows red (solid or flashing), contact Pelco Product Support at 1-800-289-9100 (USA and Canada) or +1-559-292-1981 (international) for assistance.



- ⑩ **Auto Iris Lens Connector:** Controls the amount of light allowed through the lens. Insert the 4-pin connector from the DC drive auto iris lens into this connector
- ⑪ **Auto Back Focus Button:** Sets the auto back focus mechanism. Press the button once to center the auto back focus mechanism and to fully open the iris. Press and hold the button for three seconds to start the auto back focus mechanism and to focus the camera.
- ⑫ **NTSC/PAL Button:** Toggles the service port between NTSC and PAL formats.

## PRODUCT LABEL

The product label lists the model number, date code, serial number, and Media Access Control (MAC) address. This information might be required for setup. To access the product label remove the back cover of the camera (refer to Figure 2 and Figure 3).

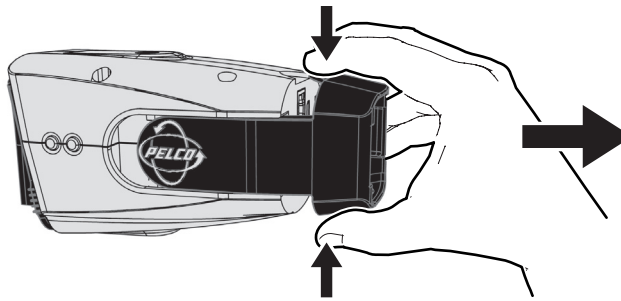

Figure 2. Remove Back Cover

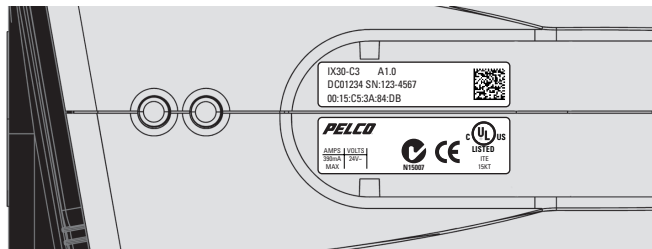
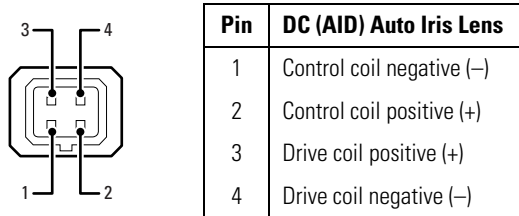

Figure 3. Product Label

# Installation

**NOTE:** Megapixel lenses are designed and tested to deliver optimal image quality to megapixel cameras. A standard definition lens installed on a megapixel camera will limit the resolution of the camera and create poor image quality.

1. Install the lens.
  - a. Remove the cover from the lens mount.
  - b. Screw the lens onto the lens mount. Be careful to prevent dust from entering the space between the lens and the imager. If necessary, use clean, compressed air to remove any foreign matter (refer to the instructions shipped with the lens). Make sure the lens does not touch the camera imager when installed.
  - c. Connect the auto iris lens to the 4-pin connector located on the side of the camera. Refer to Figure 4 for the pin connections for the auto iris lens connector



**Figure 4.** Lens Pin Connections

2. Use a standard screw to mount the camera in the desired location. The maximum thread depth is 0.25 inches (6.4 mm). The camera can be mounted from either the top or bottom, depending on the type of camera mount used in your installation.

**NOTE:** When installed inside an enclosure, mount the camera in an inverted position to allow easy access to the service port. Use the camera software to reconfigure the camera orientation for normal operation (refer to *Configuring the Orientation of the Scene* on page 35).

3. Connect the power wiring using one of the following options:
  - Connect the network cable to RJ-45 network port on the back of the camera.
  - If the network has no PoE, connect a 24 VAC Class 2 power supply to the 24 VAC power connector.

Refer to *Wiring* on page 13 for more information.

4. For FCC Class B installations, attach the supplied ferrite to the network cable (refer to Figure 5.) The ferrite should be installed on the cable approximately 1 inch (2.54 cm) from the camera's RJ-45 network port.

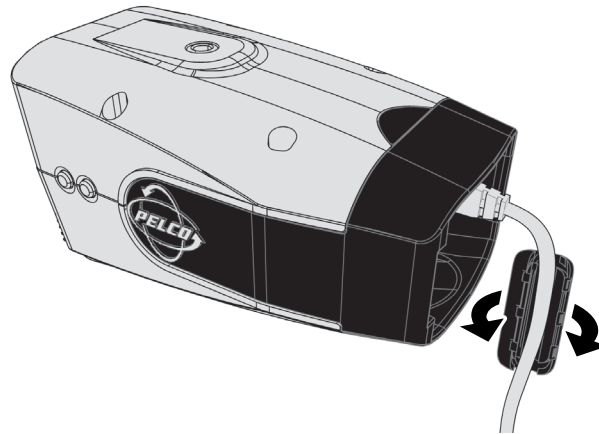

**Figure 5.** Ferrite Installation

**⚠ WARNING:** The ferrite *must be installed* for the camera to meet FCC Class B compliance standards. Failure to correctly install the ferrite might cause harmful interference to radio communications.

5. Connect the necessary wiring for alarms and relays (refer to *Wiring* on page 13).
6. Apply power to the camera. The camera will complete a configuration sequence; the green LED flashes five times per second for approximately two minutes, and then turns solid after the sequence is complete.

**NOTE:** If the camera is not connected to a DHCP server and DHCP is enabled, the configuration sequence might take up to five minutes to complete.

7. View the camera image using the service port or a Web browser.
8. Focus the lens:
  - a. Press the auto back focus button once to center the focus mechanism. The button is located on the side of the camera.
  - b. Manually adjust the zoom and focus of the lens to the desired field of view (refer to the instructions shipped with the lens).
  - c. Press and hold the back focus button for three seconds to start the auto back focus mechanism.

## SERVICE CABLE

The camera includes a service port that outputs camera video. Use it at the installation site to set up the field of view and to focus the camera.

Pelco offers an optional service cable (IX-SC) that connects directly to the service port. The service cable has a male BNC output for most standard viewers.

**NOTE:** The ICS-SC and CST150 *are not compatible* with this camera. If you have any questions about service cable compatibility, contact Pelco Product Support at 1-800-289-9100 (USA and Canada) or +1-559-292-1981 (international).

To assemble a service cable for the camera, purchase the following items from an electronics supply store:

### Qty Description

- 1 2.5 mm stereo plug (male)
- 1 CPM 88 miniature coaxial connector
- 1 RG174/U coaxial cable
- 1 1/8-inch shrink fit tubing, 1/2-inch long

To assemble the cable:

1. Attach the CPM 88 miniature coaxial connector to one end of the cable. Follow the directions supplied with the miniature coaxial connector.
2. Attach the 2.5 mm stereo plug to the other end of the coaxial cable (refer to the figure below):
  - a. Remove the support sleeve from the plug.
  - b. Slip the shrink fit tubing and support sleeve over the end of the cable.
  - c. Prepare the cable:
    - (1) Strip back the outer jacket 0.318 inch (8.06 mm) inch from the end of the cable.
    - (2) Pull back the coaxial braid shield.
    - (3) Strip back the insulating material 0.125 inch (3.18 mm) inch to expose the center conductor.
  - d. Solder the center connector of the cable to the shoulder pin of the plug.
  - e. Heat the shrink fit tubing around the center conductor and shoulder pin
  - f. Pull the coaxial braid shield back through the crimp pin and solder it to the top of the crimp pin arm.
  - g. Crimp the end of the crimp pin around the cable.
  - h. Reassemble the support sleeve and the plug.

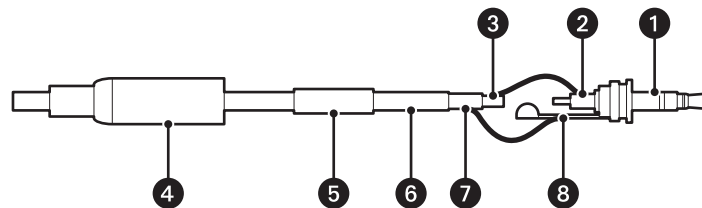

**Figure 6.** Attaching the 2.5 mm Stereo Headphone Plug

- |                      |                        |
|----------------------|------------------------|
| ① 2.5 mm Stereo Plug | ⑤ Shrink Fit Tubing    |
| ② Plug Shoulder Pin  | ⑥ Coaxial Cable        |
| ③ Center Conductor   | ⑦ Coaxial Braid Shield |
| ④ Support Sleeve     | ⑧ Crimp Pin Arm        |

# WIRING

## CAT5 CABLE

Connect a Cat5 cable to an RJ-45 network connector (not supplied). The 8-pin connector includes video and PoE for the camera. PoE (IEEE 802.3af) injects power over the same cabling that carries the network data, eliminating the need for a separate power supply. This simplifies the installation and operation of the camera without affecting network performance.

**NOTE:** The camera will autosense and configure itself to use either a crossover cable or a straight cable.

Refer to Figure 7 for pin descriptions.

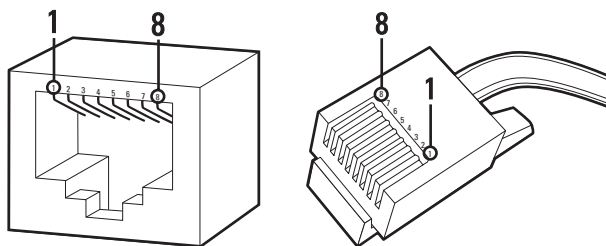

Pin	Function
1	TX+
2	TX-
3	RX+
4	PoE 1-2
5	PoE 1-2
6	RX-
7	PoE 3-4
8	PoE 3-4

**Figure 7.** Cat5 Cable Pin Descriptions

## ALARM, RELAY, AND 24 VAC CONNECTOR

### Single Camera Wiring

If PoE is not available:

1. Connect the alarm, relay, and 24 VAC wires to the supplied mating connector (refer to Figure 8).

**NOTE:** Only use the 24 VAC wires if PoE is not available.

2. When finished, attach the mating connector to the green connector on the back of the camera.

### Multiple Camera Wiring

If you are operating the camera using 24 VAC and you are wiring more than one camera to the same transformer:

1. Connect one side of the transformer to pin 1 of the 2-position terminal block on all modules.
2. Connect the other side of the transformer to pin 2 of the terminal block on all modules.

**NOTE:** Failure to connect all modules identically might introduce video noise for some installations.

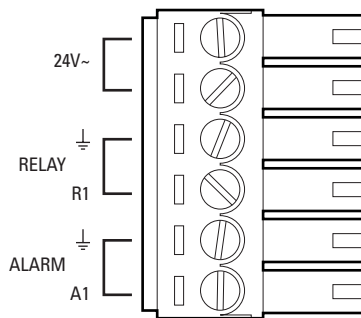

**Figure 8.** Alarm, Relay, and 24 VAC Connector

### Connecting a Relay Device

The camera has an output for activating an external device. It supports both momentary and continuous relay operation.

You can operate the relay interactively during an active connection, or it can operate automatically to coincide with certain events. Typical applications include turning on lights or other electrical devices or activating a door, gate, or lock.

**⚠ WARNING:** Do not exceed the maximum rating of 12 VDC, 0.15 A.

Figure 9 shows how to wire the relay with its power source to the camera.

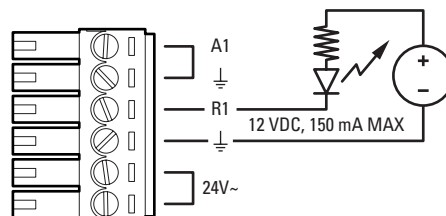

**Figure 9.** Relay Wiring

## Connecting Alarms

The camera provides an alarm input for external signaling devices, such as door contacts or motion detectors. Both normally open and normally closed devices are supported.

### Supervised Alarms

When an alarm is configured as a supervised alarm, the camera maintains a constant electrical current through the alarm circuit (3.3 VDC, 1 ohm). If the alarm circuit length changes, due to an electrical short or a bypass, the voltage fluctuates from its normal state and activates an alarm.

**NOTE:** Install the 1-kohm resistor as close to the switch as possible.

Figure 10 illustrates the alarm and no alarm conditions of a supervised alarm input. Whether the alarm is normally closed or normally open, neither a cut nor a bypass can defeat these alarms.

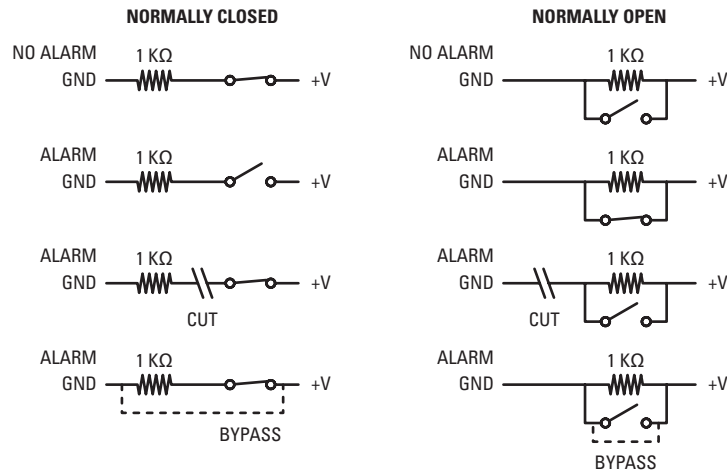

**Figure 10.** Supervised Alarm Conditions

Figure 11 illustrates the wiring configuration for supervised alarm inputs.

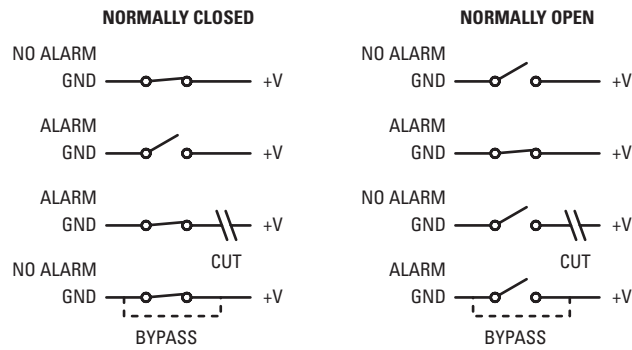

**Figure 11.** Supervised Alarm Input Wiring

## Unsupervised Alarms

When an alarm is configured as an unsupervised alarm, the camera only activates an alarm when the normal alarm state (open or closed) changes.

Figure 12 illustrates the alarm and no alarm conditions of an unsupervised alarm input.



**Figure 12.** Unsupervised Alarm Conditions

Figure 13 illustrates the wiring configuration for unsupervised alarm inputs.

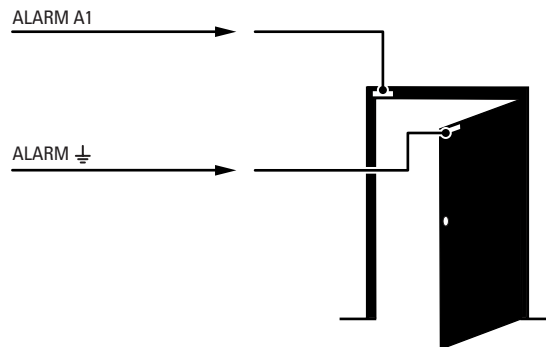

**Figure 13.** Normally Closed and Normally Open Unsupervised Alarm Input Wiring

**NOTE:** A normally closed alarm input can be defeated with a bypass; a normally open input can be defeated with a cut.

## Alarm Connections

Figure 14 shows how to wire the camera to an alarm.



**Figure 14.** Alarm Connections



# Operation

---

## CAMERA CONFIGURATION SEQUENCE

Once the device is installed and power is applied, the device will start a configuration sequence: the green LED flashes five times per second for approximately two minutes and then glows solid green, indicating that the boot cycle is complete and the device is on line.

**NOTE:** If the device is not connected to a Dynamic Host Configuration Protocol (DHCP) server and DHCP is enabled, the configuration sequence might take up to five minutes to complete.

Refer to the following sections for more information:

- *Network Tab* on page 27
- *Turning On DHCP* on page 28
- *Turning Off DHCP* on page 28

## MINIMUM SYSTEM REQUIREMENTS

Network and processor bandwidth limitations might cause the video stream to pause or appear pixilated when additional Web-interface users connect to the camera. Decrease the images per second (ips), resolution, compression, or bit rate settings of the Web interface video streams to compensate for network/processor limitations.

The following minimum system requirements are needed to use a Web browser with the IP camera:

**Processor:** Intel® Pentium® 4 microprocessor, 1.6 GHz

**Operating system:** Microsoft® Windows® XP, Windows Vista®, or Mac® OS X 10.4

**Memory:** 512 MB RAM

**Network interface card:** 100 megabits (or greater)

**Monitor:** Minimum of 1024 x 768 resolution, 16- or 32-bit pixel color resolution

**Web browser:** Internet Explorer® 7.0 (or later) or Mozilla® Firefox® 3.0 (or later)

**Media player:** Pelco's Media Player or QuickTime® 7.6.5 for Windows XP and Windows Vista, or QuickTime 7.6.4 for Mac OS X 10.4 (or later)

**NOTE:** This product is not compatible with QuickTime version 7.6.4 for Windows XP or Windows Vista. If either operating system is installed on your computer, upgrade to QuickTime version 7.6.5.

Refer to the following sections for more information:

- *Compression Standards* on page 50
- *Available Camera Resolution* on page 50
- *Image Rate* on page 50
- *Bit Rate* on page 51

## ACCESSING THE IP CAMERA

The first time you access the camera, the live video page appears. By default, you are viewing the video as a public user and only have access to the single stream live view.

If, for security purposes, users should not be allowed to view video without first logging on to the camera, change the permissions for public users.

### LOGGING ON TO THE CAMERA

1. Open the Web browser.
2. Type the camera's IP address in the browser address bar.

**NOTE:** If you do not know the camera's IP address, you can locate it using the Pelco Device Utility software.

3. Click the Login button in the navigation bar; a dialog box appears.
4. Type your user ID and password.

**NOTE:** If you are logging on to the camera as the administrator for the first time, the default User ID and Password are **admin** (all lowercase). For security purposes, be sure to change the password after you log on for the first time.

5. Click Log In.

Refer to the following sections for more information:

- *System Tab* on page 24
- *Network Tab* on page 27
- *Imaging Tab* on page 34
- *A/V Streams Tab* on page 47
- *Users Tab* on page 53
- *Events Tab* on page 57

# Live Video Page

The live video page allows you to manage the way you view live video and capture images. You can also view live video from this page and access menus on the navigation bar (based on user permissions).

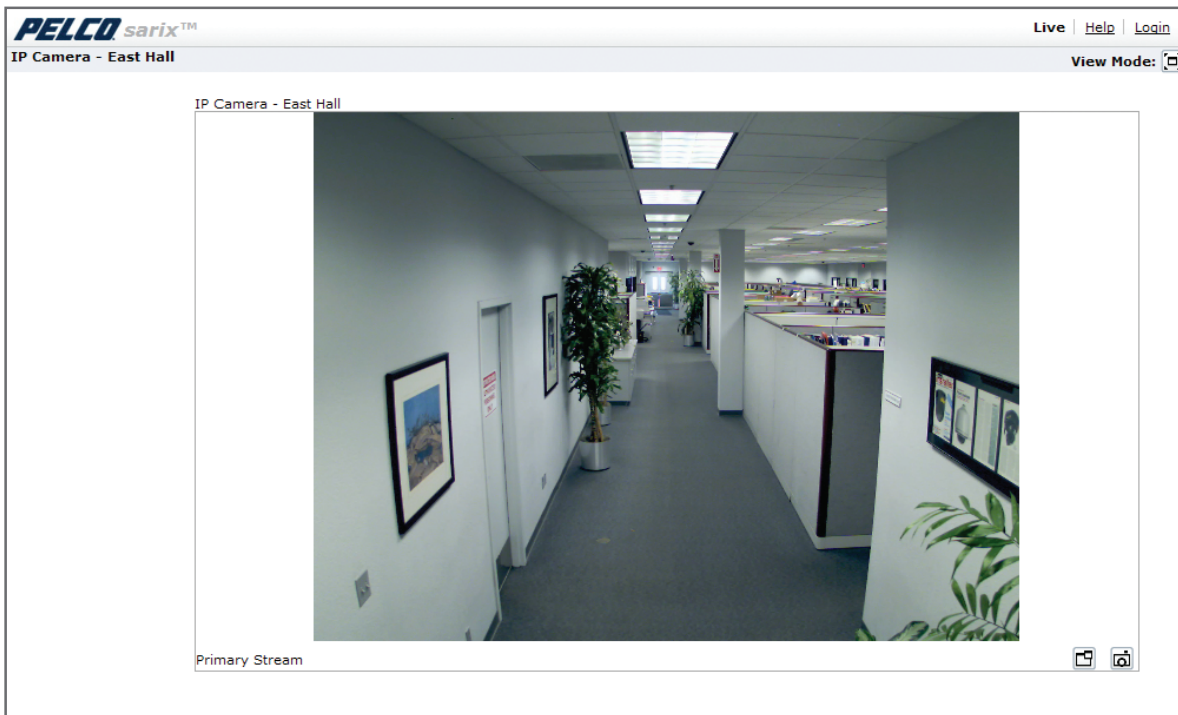











**Figure 15.** Live Video Page

Refer to the following sections for more information:

- *Live Video Page Icons* on page 20
- *Selecting a Stream* on page 21
- *Taking a Snapshot* on page 22
- *Displaying Video in the Multiscreen View* on page 22

## LIVE VIDEO PAGE ICONS

Viewable icons are based on user permissions.

-  **Show Device List:** Displays a list of viewable cameras connected to the same virtual local area network (VLAN) as the camera to which you are logged on.
-  **Disable Viewer:** Closes the live view window.
-  **1 x 1 Mode:** Displays a single video pane.
-  **2 x 2 Mode:** Displays 4 video panes in rows of two.
-  **3 x 3 Mode:** Displays 9 video panes in rows of three.
-  **4 x 4 Mode:** Displays 16 video panes in rows of four.
-  **Select Stream:** Selects the viewable video stream that is displayed in live view (primary or secondary) and selects unicast or multicast settings.
-  **Maximize Viewing Area:** Scales the image to the full size of the browser. To resize the video pane to normal view, click the Show Toolbar button in the upper-right corner of the window.
-  **Show Toolbar:** Returns the window to normal view. This option is only available after the window has been set to maximize the viewing area.
-  **Open Stream in New Window:** Opens the video in a scalable, independent window. Opening the video in a separate window allows you to view the video while other applications are running. This window can be minimized, maximized, or closed using the title bar buttons of the active window. The window can also be resized by dragging the lower-right corner of the window.
-  **Take a Snapshot:** Captures the image displayed in the video pane and then saves it as a JPEG file.

## SELECTING A STREAM

1. Click the Select Stream button.
2. Select one of the following stream options from the Select Stream page:

**Primary Stream:** To select this stream, click the button next to Primary Stream.

**Secondary Stream:** To select this stream, click the button next to Secondary Stream.

**QuickView Stream:** To select this stream, click the button next to QuickView Stream.

**Event Stream:** To select this stream, click the button next to Event Stream.

**NOTE:** If the secondary stream has not been configured, only Primary Stream, Event Stream, and QuickView Stream are available.

3. Select one of the following options to adjust the stream settings:

**MPEG-4 or H.264 compression:** Select the video transmission type from the Transmission drop-down menu. Available settings include Unicast and Multicast. Select the media player from the Player drop-down menu. Available settings include Pelco Media Player or QuickTime.

**JPEG compression:** Select the image rate for the stream from the Image Rate drop-down menu. The available settings for the primary and secondary streams depend on the Image Rate setting. The QuickView Stream has only two image rate settings: 2 ips and 1 ips.

4. Click the Select button to save the stream settings.

Refer to the following sections for more information:

- *QuickView Stream* on page 21
- *Multicast* on page 22
- *Primary Stream and Secondary Stream* on page 21
- *QuickView Stream* on page 21
- *Compression Standards* on page 50
- *Image Rate* on page 50

## PRIMARY STREAM AND SECONDARY STREAM

The Primary Stream and Secondary Stream are video streams that include compression, resolution, image rate, and bit rate settings. The streams can be set up using a video preset setting, or they can be customized using the video configuration settings.

A video preset is a predefined video configuration that offers a good balance between video performance and bandwidth usage. For easy stream configuration, use the Video Preset page located in the drop-down menu of the A/V Streams Tab.

To customize the Primary Stream or Secondary Stream use the Video Configuration page located in the drop-down menu of the A/V Streams Tab. Configurable settings include the stream name, compression standard, resolution setting, image rate, and bit rate. The default names for the streams are Primary Stream and Secondary Stream; however, if these stream names have been changed, the new names will replace the default names (Primary Stream and Secondary Stream) on the Select Stream page.

## QUICKVIEW STREAM

The QuickView Stream is a predefined JPEG video stream with VGA resolution. This low resolution, low frame rate stream is displayed when the Imaging Tab settings are configured. This allows users to view changes to exposure, white balance, and tone map settings as they are configured and before the settings are saved.

The QuickView Stream is also ideal for users who are connected to a network with processor bandwidth limitations that might cause a high resolution, high frame rate video stream to pause or appear pixilated.

The aspect ratio of the QuickView Stream mirrors that of the Primary Stream. The only stream setting that is selectable is the framerate: 2 ips or 1 ips.

## EVENT STREAM

The Event Stream displays a list of alerts triggered by a running behavior (analytic). The alert includes a screen capture, the profile that was triggered, and the zone where the alert was detected. For the Event Stream to work you must have a behavior profile running. To set up and run behaviors, use the Analytic Configuration page located in the drop-down menu of the Events Tab.

## UNICAST

A unicast transmission sends a separate video stream to each user that is requesting data. Although multiple users might request the same data from the camera at the same time, duplicate video streams are transmitted to each user. Every unicast user that connects to the camera consumes additional processing power, which limits the number of simultaneous users who can access the camera.

The camera supports a maximum of 20 simultaneous users.

## MULTICAST

A multicast transmission sends data to multiple users at the same time using one transmission stream. Each multicast user that connects to the camera consumes no additional processing power; therefore, multicast video streams can be sent to an unlimited number of simultaneous users.

## TAKING A SNAPSHOT

1. Click the "Take a Snapshot" button.
2. The File Download dialog box opens, and the following message appears: "Do you want to open or save this file?"
3. Select one of the following options:

**Open:** Your computer's photo editing program opens and displays the screen image. This function is available only when using Microsoft® Internet Explorer® 7.0 (or later) or Mozilla® Firefox® 3.0 (or later).

**Save:** The image is saved as a JPEG file on your computer.

**Cancel:** The captured image is not saved or displayed and the dialog box closes.

**NOTE:** If you are using JPEG, the captured image will be the size of the largest MJPEG stream. If you are using MPEG-4 or H.264, the image is captured using the QuickView Stream, which is approximately VGA resolution.

## DISPLAYING VIDEO IN THE MULTISCREEN VIEW

Cameras connected to the same virtual local area network (VLAN) as the camera to which you are logged on can be displayed in a multiscreen view. Use the 4-camera, 9-camera, or 16-camera view mode buttons to display video from multiple cameras simultaneously.

The camera you are logged on to is the default display for the upper-left video pane in the multiscreen view. The device name for this camera is displayed in the gray area near the top of the page.

**NOTE:** Using Primary and Secondary streams in multiscreen view will limit the available processing power and create responsiveness issues for the camera and PC. If you experience latency issues, set the camera streams to QuickView. Available processing power is determined by the settings for compression standards, resolution, image rate, bit rate, and analytic configuration.

To select video to display in the individual multiscreen panes:

1. Click the desired View Mode display button.
2. Click the Show Device List button above the selected video pane. A list of cameras connected to the same VLAN as the camera to which you are logged on appears in the video pane.
3. Click the name of the camera you want to view. The live video of the selected camera appears in the video pane.
4. Repeat steps 1 through 3 for the remaining video panes.

# Settings Page

Depending on user permissions, the Settings page allows you to manage camera system settings, set up users, configure events, and control the camera.

**NOTE:** The Settings menu might not be available if the user does not have permission to access this feature.

## ACCESSING THE CAMERA MENUS

1. Log on to the camera.
2. Click the Settings link in the navigation bar located in the upper-right corner of the page; a list of menu tabs appears.
3. Place the mouse pointer over a tab to display a list of submenus.

Refer to the following sections for more information:

- *System Tab* on page 24
- *Network Tab* on page 27
- *Imaging Tab* on page 34
- *A/V Streams Tab* on page 47
- *Users Tab* on page 53
- *Events Tab* on page 57

# System Tab

Use the System tab to change the device name, configure the time settings, set up the text overlay for the live view, and display system information. You can also use the System tab to generate a system log, reboot the camera, or to restore the camera's factory default settings.

## General Settings

The General Settings page includes configurable fields for the device name, time server, and text overlay settings. The device name is the user-friendly description of the camera displayed in the gray area near the top of screen. The time server is an external server that uses Network Time Protocol (NTP) to synchronize the camera date and time settings. The text overlay settings allow you to customize the appearance of the Web browser by displaying the device name and the date and time at the top or bottom of the live view.

You can also use the General Settings page to turn the camera's power LED on or off and to configure the Simple Mail Transfer Protocol (SMTP) server to send an email notification when an event handler is activated.

**NOTE:** Consult your network administrator for information on configuring email notification on your local network.

## Information Settings

The System Information page fields are read-only and include the firmware version, hardware version, model number, and serial number of the system. This information is typically required by Pelco Product Support for troubleshooting purposes.

Refer to the following sections for more information:

- *Changing the Device Name* on page 24
- *Configuring the Time Settings* on page 25
- *Customizing the Appearance of the Text Overlay* on page 25
- *Generating a System Log* on page 25
- *Rebooting the Camera* on page 25
- *Restoring All Camera Defaults* on page 26

## CHANGING THE DEVICE NAME

1. Place your mouse pointer over the System tab.
2. Select General Settings from the drop-down menu.
3. Click the Device Name box and highlight the text.
4. Type a user-friendly name into the Device Name box (2 to 63 characters). A user-friendly name makes it easier to recognize the device on the network. Examples of user-friendly names are Front Door, Lobby, or Parking Lot.
5. Click Save to save the new device name, or click Reset to restore to the previously saved device name.



## CONFIGURING THE TIME SETTINGS

If the camera is connected to a Dynamic Host Configuration Protocol (DHCP) network that has time server properties configured, the camera will synchronize automatically with the time server. If the DHCP network's time server properties are not configured or the network does not have a time server, you need to configure the DHCP settings manually.

1. Click the System tab.
2. Select General Settings from the drop-down menu.
3. Type the IP address of the time server in the Time Server field. The time server is an external server that uses Network Time Protocol (NTP) to synchronize the camera date and time settings.
4. Select the Time Zone option. Select the continent and the region that are closest to the camera's location from the Time Zone drop-down menus.

**NOTE:** If your location observes a form of daylight saving time, the system will automatically change the time on the associated dates.

5. Click the Save button to save the settings, or click the Reset button to clear all of the information you entered without saving it.

## CUSTOMIZING THE APPEARANCE OF THE TEXT OVERLAY

1. Click the System tab.
2. Select General Settings from the drop-down menu.
3. Set the Text Overlay settings:

**Date/Time Overlay:** Select Show to display the date and time in the live view overlay. The default setting is Hide.

**Camera Name Overlay:** Select Show to display the device name in the live view overlay. The default setting is Hide.

4. Select the display position for the overlay from the Position drop-down menu. Selections include Top Right, Top Center, Top Left, Bottom Right, Bottom Center, and Bottom Left.
5. Click the Save button to save the settings, or click the Reset button to clear all of the information you entered without saving it.

## GENERATING A SYSTEM LOG

1. Click the System tab.
2. Click the Generate System Log button to create a system log that can be used by Pelco Product Support for troubleshooting. Contact Pelco Product Support at 1-800-289-9100 (USA and Canada) or +1-559-292-1981 (international).

## REBOOTING THE CAMERA

1. Click the System tab.
2. Select General Settings from the drop-down menu.
3. Click the Reboot Camera button to restart the camera. Rebooting the camera does not change the configured camera settings.

## RESTORING ALL CAMERA DEFAULTS

 **WARNING:** This process cannot be undone; all user and custom settings will be lost.

1. Click the System tab.
2. Select General Settings from the drop-down menu.
3. Click the Restore All Camera Defaults button to restore the camera's factory default settings.

**NOTE:** If the camera is not connected to a Dynamic Host Configuration Protocol (DHCP) network, the IP address settings for the camera will be lost and the server will not recognize the camera. DHCP On is the default setting for the camera IP address.

Refer to the following section for more information:

- *Turning Off DHCP* on page 28

# Network Tab

Use the Network tab to change the camera's general network settings, select the Secure Sockets Layer (SSL) settings, enable Secure Shell (SSH), configure 802.1x port security, and select Simple Network Management Protocol (SNMP) settings.

## General Network Settings

The General Network page includes configurable and read-only fields for network communication settings. Available settings include the Hardware Address, Hostname, IP Address, Subnet Mask, Gateway, and DNS Servers.

You can also enable or disable the Dynamic Host Configuration Protocol (DHCP) server from the General Network page. DHCP automatically assigns an IP address to the device if there is a DHCP server on the network. If DHCP is set to On, the IP address, subnet mask, gateway, and DNS server settings are read-only text. If DHCP is set to Off, these settings must be manually changed. The default camera setting for DHCP is On.

## SSL Settings

To ensure security on the Internet, all Web browsers provide several security levels that can be adjusted for sites that use SSL technology to transmit data. SSL encrypts communications, making it difficult for unauthorized users to intercept and view user names and passwords.

SSL requires signed certificates to determine if the Web browser accessing the camera has the required authentication. The camera can generate a certificate signing request (CSR) that can be sent to a certificate authority for a signature (for example, VeriSign®), or it can generate a self-signed certificate using the Generate Self-Signed Certificate option.

## SSH Settings

SSH is a user-enabled protocol that allows Pelco Product Support to log on to and service the camera for advanced troubleshooting purposes. From this page, users with the appropriate permissions can enable or disable SSH access to the camera.

## 802.1x

802.1x is a port security that authenticates devices that want to establish a point-to-point access through a wired or wireless port using Extensible Authentication Protocol (EAP). This port-based authentication method prevents unauthorized access to a Local Area Network (LAN) through a physical port. For example, when a device is connected to a network port, the network switch will ask the device for authentication. If the credential is accepted when the device sends a credential to the network switch, the network switch will open the port for normal use. If authentication fails, the device is prevented from accessing information on the port.

## SNMP

SNMP is an application layer protocol used to manage TCP/IP-based networks from a single workstation or several workstations. The camera supports SNMP versions 2c and 3 and can be configured to send data using a trap.

Refer to the following sections for more information:

- *Changing the Hostname* on page 28
- *Turning On DHCP* on page 28
- *Turning Off DHCP* on page 28
- *Selecting the Secure Sockets Layer Mode* on page 29
- *Generating a Certificate Request* on page 30
- *Generating a Self-Signed Certificate* on page 30
- *Enabling Secure Shell* on page 31
- *Configuring the 802.1x Port Security Settings* on page 31
- *Selecting SNMP Settings* on page 32

## CHANGING THE HOSTNAME

1. Place your mouse pointer over the Network tab.
2. Select General from the drop-down menu.
3. Click in the Hostname box and highlight the text.
4. Type a user-friendly name into the Hostname box (1 to 21 characters) using any combination of alphanumeric characters. A user-friendly name makes it easier to recognize the device on the network.
5. Click the Save button to save the settings, or click the Reset button to clear all of the information you entered without saving it.

## TURNING ON DHCP

The default Dynamic Host Configuration Protocol (DHCP) setting for the camera is DHCP On. If the DHCP option is set to Off, complete the following steps to reset it to On.

1. Place your mouse pointer over the Network tab.
2. Select General from the drop-down menu.
3. Select the On option for DHCP.
4. Click the Save button to save the settings, or click the Reset button to clear all of the information you entered without saving it.

**NOTE:** If the camera is not connected to a DHCP server but DHCP is set to On, the default IP address 192.168.0.20 on subnet mask 255.255.255.0 is automatically assigned to the camera. After the first camera is connected and assigned the default IP address, the system will automatically look for other cameras on the auto IP address system and assign IP addresses in sequential order as required. For example, if three cameras are connected to a network without a DHCP server, the first camera will be assigned address 192.168.0.20, the second camera will be assigned address 192.168.0.21, and the third camera will be assigned address 192.168.0.22.

## TURNING OFF DHCP

 **WARNING:** Contact your network administrator to avoid any network conflicts before setting or changing the IP address of the device.

1. Place your mouse pointer over the Network tab.
2. Select General from the drop-down menu.
3. Select the Off option for the Dynamic Host Configuration Protocol (DHCP).
4. Change the following network settings as required:

**IP Address:** The address of the camera connected to the network.

**Subnet Mask:** The address that determines the IP network that the camera is connected to (relative to its address).

**Gateway:** The router that accesses other networks.

**DNS Servers:** The addresses of the dedicated servers that translate the names for Web sites and hostnames into numeric IP addresses.

5. Click the Save button to save the settings, or click the Reset button to clear all of the information you entered without saving it.

## SELECTING THE SECURE SOCKETS LAYER MODE

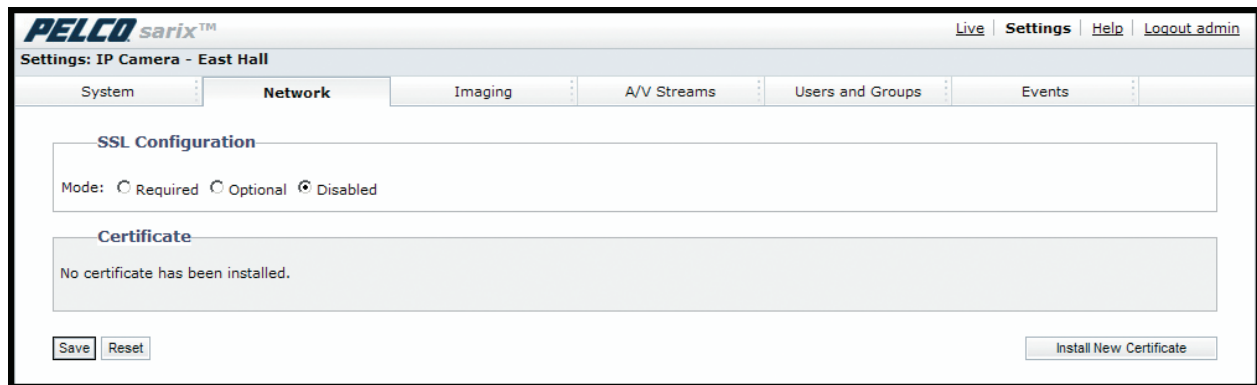

**Figure 16.** SSL Configuration Page

1. Place your mouse pointer over the Network tab.
2. Select SSL from the drop-down menu.
3. Select one of the following modes:

**Required:** A signed Secure Sockets Layer (SSL) certificate must be installed, and a secure URL that begins with the protocol name "https:" must be used to access the camera. Sensitive data is always encrypted during transmission. A URL that begins with the "http:" protocol rather than the "https:" protocol will be redirected to the secure URL automatically.

**Optional:** A signed SSL certificate must be installed, but a secure URL that begins with the protocol name "https:" is optional when accessing the camera. You can also access the camera using a standard URL with the "http:" protocol, but sensitive data is not encrypted during transmission. To ensure that sensitive data is encrypted, you must use a secure URL with the "https:" protocol.

**Disabled (default):** Turns off access to the Web client through SSL. Sensitive data will not be encrypted during transmission.

**NOTE:** If the SSL mode is set to disabled, you cannot access the camera using a URL that begins with an "https:" protocol. Your Web browser displays an error message if you do not type the camera URL correctly.

Refer to the following sections for more information:

- *Generating a Certificate Request* on page 30
- *Generating a Self-Signed Certificate* on page 30

## GENERATING A CERTIFICATE REQUEST

1. Place your mouse pointer over the Network tab.
2. Select SSL from the drop-down menu.
3. Click the Install Certificate button located at the bottom of the SSL Configuration page. The Select Certificate Install Method option buttons appear on the page.
4. Select Generate Certificate Request, and then click Next. The Certificate Request Form opens.
5. Fill in all of the fields, and then click Generate Request. The following progress message appears on the page: "Generating certificate signing request, please wait."
6. Send the CSR, which looks like an encrypted block of undecipherable text, to a third-party certificate authority of your choice for a signature.
7. After you receive the signed certificate, click the Install Certificate button to upload the signed certificate to the device.
8. After the certificate is uploaded, select the desired mode.
9. Click Save.

**NOTE:** Depending on the third-party certificate authority that signed your certificate, you might need to renew your certificate after a specified amount of time. Consult the certificate authority for more details.

## GENERATING A SELF-SIGNED CERTIFICATE

1. Place your mouse pointer over the Network tab.
2. Select SSL from the drop-down menu.
3. Click the Install Certificate button located at the bottom of the SSL Configuration page. The Select Certificate Install Method option buttons appear on the page.
4. Select the "Generate Self-signed Certificate" option, and then click Next. The "Self-signed Certificate Information Form" opens.
5. Fill in all of the fields, and then click Generate Request. The following progress message appears on the page: "Your changes are being applied. This process might take up to 3 minutes." After three minutes, the certificate is uploaded to the device.
6. After the certificate is uploaded, select the desired mode.
7. Click Save.

**NOTE:** Self-signed certificates are valid for one year. The certificate's expiration date is listed in the Installed Certificate information section. If the certificate has expired and you attempt to access the camera using a secure URL, the Web browser displays a message. Repeat this procedure to generate and upload a new certificate.

## ENABLING SECURE SHELL

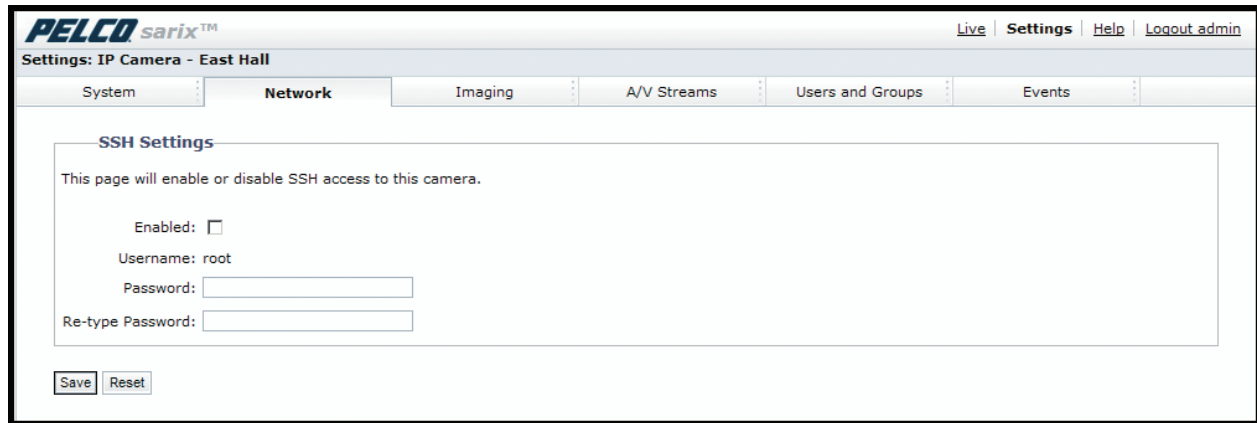

**Figure 17.** SSH Settings Page

1. Place your mouse pointer over the Network tab.
2. Select SSH from the drop-down menu.
3. Select the Enabled check box.

**NOTE:** The username is always root and cannot be changed. The username and password are required when accessing the camera through a third-party SSH client.

4. Click in the Password box and type a password (4 to 16 alphanumeric characters). Passwords are case-sensitive.
5. Click in the Re-type Password box and retype your password.
6. Click the Save button to save the password and enable SSH, or click the Reset button to clear all of the information you entered without saving it.

## CONFIGURING THE 802.1X PORT SECURITY SETTINGS

**WARNING:** To prevent network conflicts, contact your network administrator before configuring the 802.1x port security settings.

1. Place your mouse pointer over the Network tab.
2. Select 802.1x from the drop-down menu.
3. Select the On option for the 802.1x Port Security. The default setting for 802.1x is Off.
4. Select the Extensible Authentication Protocol (EAP) method from the Protocol drop-down menu. Supported EAP methods include EAP-MD5, EAP-PEAP, EAP-TLS, and EAP-TTLS.
5. Type the information required for the selected 802.1x authentication method.
6. Connect the PC to a 802.1x secured switch with like authentication protocols.
7. Click the Save button to save the settings, or click the Reset button to clear all of the information you entered without saving it.

## SELECTING SNMP SETTINGS

**⚠ WARNING:** The Simple Network Management Protocol (SNMP) settings are advanced controls. Consult your network administrator to obtain the required information to configure SNMP settings.

1. Place your mouse pointer over the Network tab.
2. Select SNMP from the drop-down menu.
3. Select the SNMP Version: None, V2c, or V3. None disables the SNMP configuration and is the default setting.

**NOTE:** SNMP V2c and SNMP V3 configuration settings are independent of each other, but only one SNMP version can be active at a time.

## CONFIGURING SNMP V2C

The screenshot shows the PELCO sarix™ web interface for an IXE20C-PM device. The top navigation bar includes links for Live, Settings, Help, and Logout admin. Below the navigation bar, there are tabs for System, Network, Imaging, A/V Streams, Users, and Events. The Network tab is selected, and the SNMP Configuration section is expanded. The configuration includes radio buttons for SNMP Version (None, V2c, V3), a text input for the Community String (set to 'public'), and a section for Trap Configuration with text inputs for Address and Community String. Save and Reset buttons are at the bottom.

**Figure 18.** SNMP V2c Settings

1. Place your mouse pointer over the Network tab.
2. Select V2c as the SNMP Version.
3. Type the community name in the Community String box. The default name for the Community String is "public."
4. Configure the Trap Configuration settings.

**Address:** Type the hostname or IP address of the recipient of the trap message.

**Community String:** Type the name of the community that should receive the trap message.

5. Click the Save button to save the settings, or click the Reset button to clear all of the information you entered without saving it.



## CONFIGURING SNMP V3

**PELCO Spectra IV-IP** [Live](#) | [Settings](#) | [Help](#) | [Logout admin](#)

**Settings: IP Camera - TXB-N-AAATRP9**

System | **Network** | Camera Configuration | A/V Streams | Users | Events

**SNMP Configuration**

SNMP Version:  None  V2c  V3

Engine ID: 800061EA0300047D02CC2E

SNMP user:  Authentication:   Privacy:

**Trap Configuration**

Address:

**Figure 19.** SNMP V3 Settings

1. Place your mouse pointer over the Network tab.
2. Select V3 as the SNMP Version.
3. Type the SNMP user name in the SNMP user field.
4. Select the encryption algorithm for authentication from the Authentication drop-down menu: None, MD5, or SHA. If you use authentication method MD5 or SHA, type a password in the text box to the right of the selected Authentication encryption.
5. Select the privacy encryption algorithm setting from the Privacy drop-down menu: None, DES, or AES. If you use privacy method DES or AES, type a password in the text box to the right of the selected Privacy encryption.
6. Configure the address for the Trap Configuration. The Address is the hostname or IP address of the recipient of the trap message.
7. Click the Save button to save the settings, or click the Reset button to clear all of the information you entered without saving it.

# Imaging Tab

Use the Imaging tab to change the camera's general image settings, adjust the camera exposure, program the focus mechanism, adjust the tone map settings to increase scene detail, tune the white balance settings for scenes with fluctuating lighting conditions, or define window blanking privacy areas.

## General Imaging Settings

General imaging settings include adjustments for camera orientation and digital processing. The Orientation settings reconfigure the image 180 degrees horizontally and 180 degrees vertically. Use these settings when installing the camera in an inverted position. If the orientation is not adjusted, the image will display upside down and mirrored.

Digital processing settings can be set to Auto or Manual to adjust the camera's sharpness, saturation, and contrast. When set to Auto, the camera continually delivers the best possible image by automatically adjusting the digital processing settings based on the scene. Auto is the default setting. Manual digital processing is recommended only for indoor applications that have a single, unchanging primary light source.

## Exposure Settings

Exposure is the amount of light detected by the camera sensor. A scene with correct exposure settings has adequate detail and contrast between white and dark values. An image with too little or too much exposure eliminates detail in the scene. The camera features Auto and Manual exposure settings. Auto exposure automatically sets the amount of light detected by the camera sensor based on settings for light control, exposure compensation, and the day and night exposure times. Manual exposure sets the amount of light detected by the camera sensor based on a user-defined setting. Manual exposure is recommended only for indoor applications that have a single, unchanging primary light source. Auto is the default setting.

## Focus Settings

Focus sets the back focus to the center focal point of the scene. The camera can be configured to back focus automatically or manually. Auto focus automatically back focuses the camera on the subject in the center of the scene. Manual focus turns off the auto focus mechanism and locks the camera at a user-specified position. The manual focus setting is recommended only for indoor applications that have a single, unchanging primary light source. The Focus page also includes Full Range Auto-Focus, Quick Auto-Focus, and a Factory Defaults.

## Tone Map Settings

Tone map balances the brightest and darkest sections of a scene to produce an image with more balanced lighting and more detail. This is accomplished, in part, when the device maps the 10-bit input sensor data (0 to 1023 bits) into 8-bit output RGB values (0 to 255 bits).

## White Balance Settings

White balance settings define how the camera processes video images to render true colors in a scene. White balance is especially effective in scenes with changing lighting conditions or in scenes with more than one type of light source. For example, scenes that benefit from white balance correction are outdoor scenes, indoor scenes that include a window or door that opens to the outdoors, or indoor scenes that include both incandescent and fluorescent lighting.

## Window Blanking Settings

Window blanking is used to conceal user-defined privacy areas. A blanked area appears on the screen as a solid gray window. The camera can handle up to four blanked windows as long as the total blanked area does not exceed 50 percent of the field of view.

Refer to the following sections for more information:

- *Configuring the Orientation of the Scene* on page 35
- *Changing the Digital Processing Settings* on page 36
- *Selecting Auto Exposure Settings* on page 37
- *Selecting Manual Exposure Settings* on page 39
- *Day Night Settings* on page 40
- *Configuring Auto Focus Settings* on page 41
- *Configuring Manual Focus Settings* on page 42
- *Setting Tone Map Options* on page 43
- *Selecting Auto White Balance Settings* on page 44
- *Selecting Manual White Balance Settings* on page 45
- *Turning On Window Blanking* on page 46
- *Turning Off Window blanking* on page 46
- *Deleting a Window Blanking Area* on page 46

## CONFIGURING THE ORIENTATION OF THE SCENE

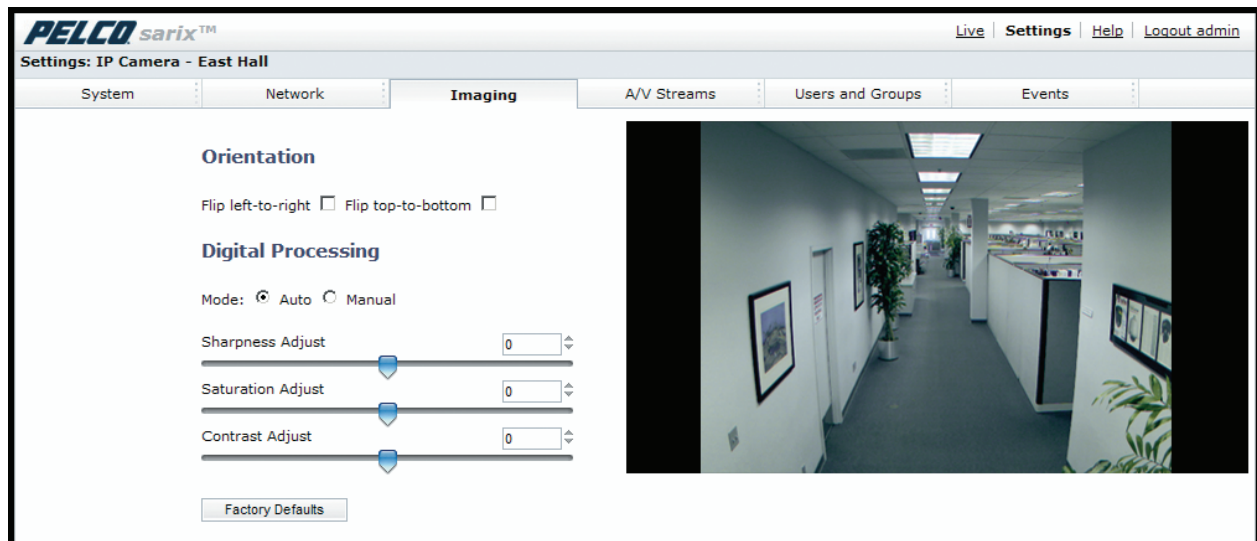

Figure 20. Orientation Page

1. Place your mouse pointer over the Imaging tab.
2. Select General from the drop-down menu.
3. Select one of the following options:
  - Click the "Flip left-to-right" box to rotate the camera image 180 degrees horizontally.
  - Click the "Flip top-to-bottom" box to rotate the camera image 180 degrees vertically.

## CHANGING THE DIGITAL PROCESSING SETTINGS

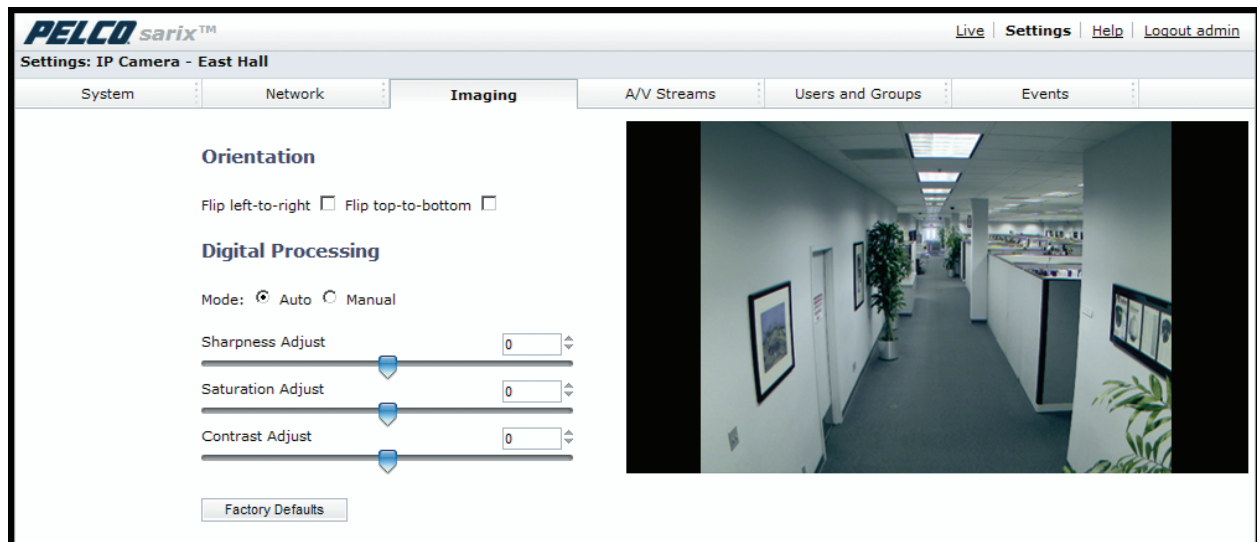

Figure 21. Digital Processing Page

1. Place your mouse pointer over the Imaging tab.
2. Select General from the drop-down menu.
3. Select the mode: Manual or Auto. Auto is the default.
4. Move the slider to the left or right to change the following settings:

**Sharpness Adjust/Sharpness:** Controls the clarity of detail in a scene. Move the slider to the right to increase the sharpness; move the slider to the left to decrease the sharpness. Increasing the sharpness also increases the image noise. The auto range of adjustment is -100 to 100; the auto default setting is 0 (zero). The manual range of adjustment is 0 to 100; the manual default setting is 50.

**Saturation Adjust/Saturation:** Controls how intense or vivid the colors are in a scene. Move the slider to the right to increase the saturation level; move the slider to the left to decrease the saturation level. The auto range of adjustment is -100 to 100; the auto default setting is 0 (zero). The manual range of adjustment is 0 to 100; the manual default setting is 50.

**Contrast Adjust/Contrast:** Controls gradations between the darkest and lightest portions of the scene. Move the slider to the right to increase the contrast; move the slider to the left to decrease the contrast. The auto range of adjustment is -100 to 100; the auto default setting is 0 (zero). The manual range of adjustment is 0 to 100; the manual default setting is 50.

# SELECTING AUTO EXPOSURE SETTINGS

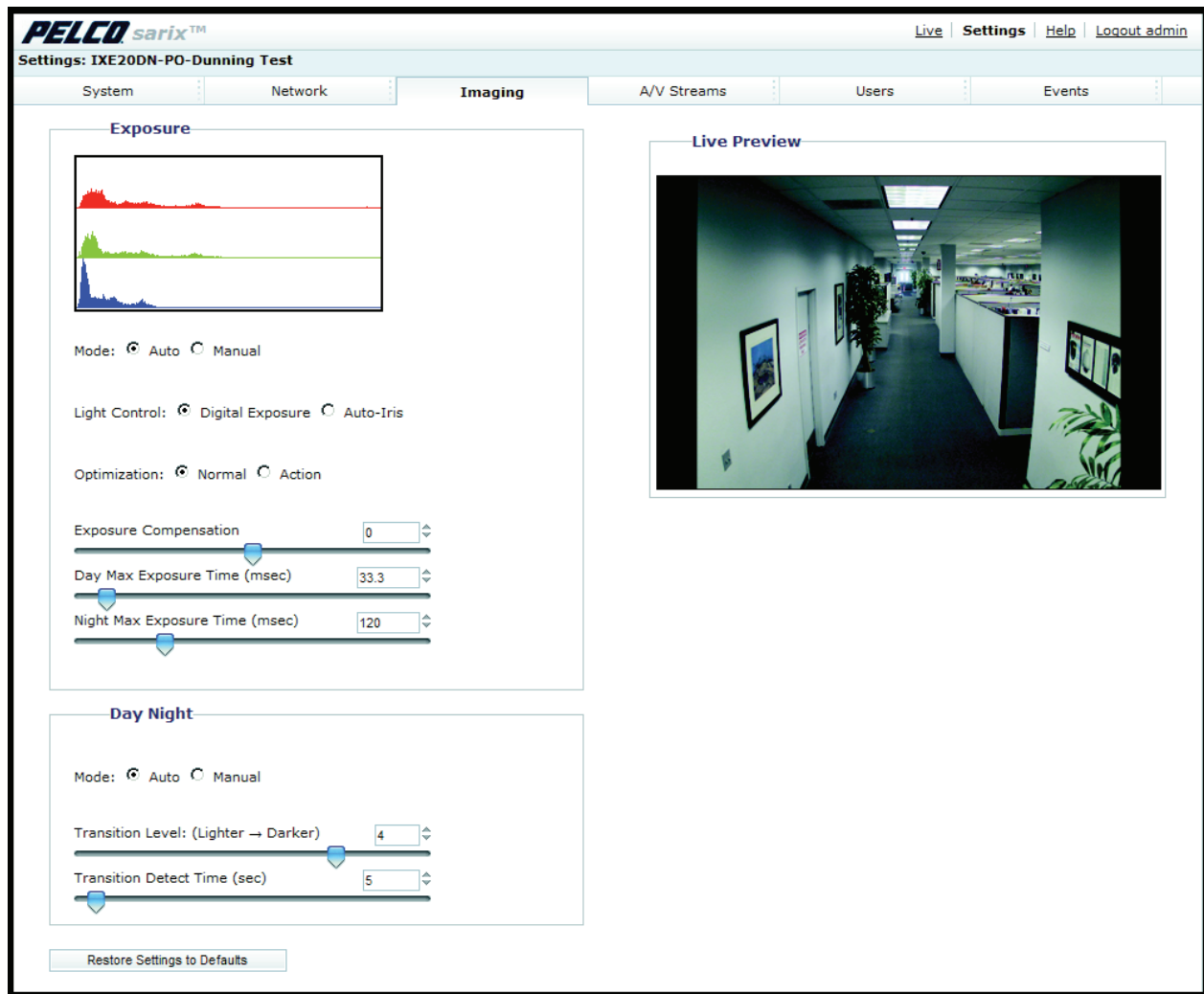

Figure 22. Auto Exposure Page

1. Place your mouse pointer over the Imaging tab.
2. Select Exposure from the drop-down menu.
3. Select the Auto mode.
4. Select the Light Control method: Digital Exposure or Auto-Iris Exposure.

**Digital Exposure:** This setting automatically adjusts the sensor exposure time depending on the light level at the scene. For very bright scenes, the exposure time is very short and, as the scene becomes less bright, the exposure time is increased until the maximum exposure time is reached. Digital Exposure is the default setting and provides the best image quality for the majority of scenes.

**Auto-Iris Exposure:** This setting automatically adjusts the lens iris depending on the light level at the scene. For this setting, the sensor exposure time is fixed. Select Auto-Iris if the video shows flickering or rolling bands due to 50 Hz or 60 Hz lighting. Most lighting situations do not require this setting.

5. Select the Exposure Optimization setting: Normal or Action. These are optimizations of the Digital Exposure control.

**Normal:** This setting is for very bright scenes and exposure time is very short. As the scene becomes less bright, the exposure time is increased until the maximum exposure time is reached. Normal is the default setting.

**Action:** This setting operates similar to Normal except the short exposure times are used for both bright and mid-level lighting. This minimizes the blur in video caused by moving objects. For very low light scenes, Action optimization operates the same as Normal, increasing the exposure time until the maximum exposure time is reached.

6. Set the Exposure Compensation setting. Move the slider bar to the right to brighten the video, or move it to the left to darken the video. The exposure compensation range is -100 to 100; the default setting is 0 (zero).

7. *Color cameras only:* Set the Max Exposure Time and Night Max Exposure Time.

**Max Exposure Time:** This setting controls the maximum time in milliseconds that an image is exposed during daytime conditions. Decreasing Max Exposure Time reduces the blur caused by fast moving objects as the light dims, but it also reduces the light sensitivity of the camera. The exposure range is 1 to 500 msec; the default setting is 33.3 msec.

**Night Max Exposure Time:** This setting controls the maximum time in milliseconds that an image is exposed during dim light, such as nighttime conditions. Increase this time to increase the light sensitivity of the camera. The exposure range is 1 to 500 msec; the default setting is 120 msec.

8. *Day/night cameras only:* Set the Day Max Exposure Time and Night Exposure Time.

**Day Max Exposure Time:** This setting controls the maximum time in milliseconds that an image is exposed when the camera is in Day (Color) mode. Decreasing Max Exposure Time reduces the blur caused by fast moving objects as the light dims, but it also reduces the light sensitivity of the camera. The exposure range is 1 to 500 msec; the default setting is 33.3 msec.

**Night Max Exposure Time:** This setting controls the maximum time in milliseconds that an image is exposed when the camera is in Night (black-white) mode. Increase this time to increase the light sensitivity of the camera. The exposure range is 1 to 500 msec; the default setting is 120 msec.

9. *Day/night cameras only:* Set the Day Exposure Time and the Night Exposure Time.

**Day Exposure Time:** This setting is the maximum time in milliseconds that an image is exposed during daytime conditions. Decreasing exposure time decreases the light sensitivity of the scene and reduces the blur caused by fast moving objects; however, it increases the amount of noise in the scene. The day maximum exposure time range is 1 to 500 msec; the default setting is 33.3 msec.

**Night Exposure Time:** This setting is the maximum time in milliseconds that an image is exposed during nighttime (black-white) conditions. Increase the exposure time to increase light sensitivity of the scene. The night maximum exposure time range is 1 to 500 msec; the default setting is 120 msec.

10. *Day/night cameras only:* Set the Day Night mode to Auto or Manual.

**Auto:** This setting automatically controls the IR cut filter determined by the Transition Level and the Transition Detect settings.

**Manual:** This setting sets the IR filter to a fixed position. The filter can be set to the Day (color) position or the Night (black-white) position.

Refer to the following section for more information:

- *Day Night Settings* on page 40

# SELECTING MANUAL EXPOSURE SETTINGS

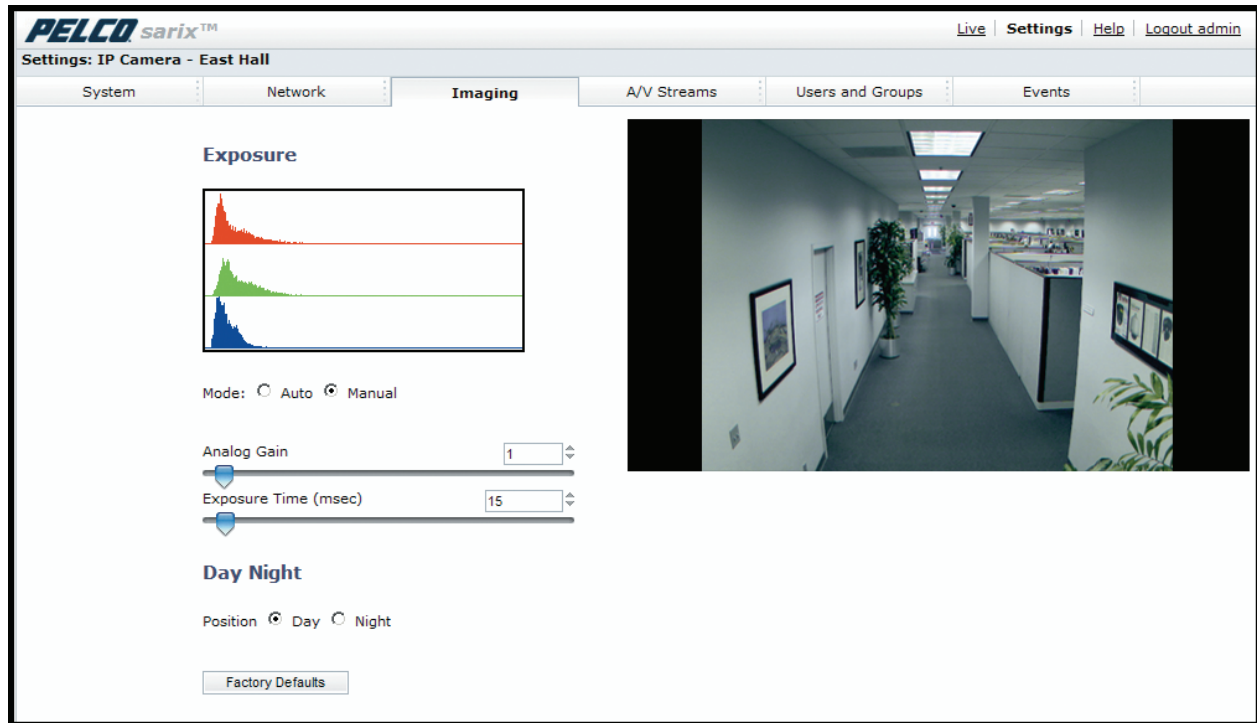

**Figure 23.** Manual Exposure Page

1. Place your mouse pointer over the Imaging tab.
2. Select Exposure from the drop-down menu.
3. Select the Manual mode.
4. Move the Analog Gain slider to the desired position. Increasing the gain increases the brightness of the image, but it also increases the amount of noise in the image. The analog gain range is 1.00 to 15.75; the default setting is 1.00.
5. Move the Exposure Time slider to the desired position. This setting is the maximum time in milliseconds that the sensor is exposed to the light. Decreasing the maximum exposure time decreases the light sensitivity. The exposure time range is 0.01 to 1000 msec; the default setting is 15 msec.
6. *Day/night cameras only:* Set the Day Night Position setting.  
**Day:** Sets the IR filter to the Day (color) position.  
**Night:** Sets the IR filter to the Night (black-white) position.

Refer to the following section for more information:

- *Day Night Settings* on page 40

## DAY NIGHT SETTINGS

The Day Night mode controls the position of the IR cut filter, which determines the color or black-white setting of the camera. The Day Night mode settings change depending on the Exposure settings. If the camera is set to Auto Exposure mode, the Day Night mode can be set to Auto or Manual and all of the respective settings are available. If the camera is set to Manual Exposure, the only available Day Night mode setting is Position, which sets the IR filter to either the Day (color) position or the Night (black-white) position.

## DAY NIGHT AUTO AND MANUAL MODES

### DAY NIGHT AUTO MODE

The Day Night Auto mode setting automatically controls the IR cut filter depending on the Transition Level and Transition Detect Time settings.

**Transition Level:** Determines when the camera changes from day mode (color) to night mode (black-white). Move the slider to the left or right to change the transition level to a lighter or darker setting. Select a lighter transition level setting if you want the camera to change modes at a high lux setting. Use the default setting of 4 for normal day/night operation. Use a darker transition level to change modes at a low lux setting.

**Table A.** Lux Transition Points for Incandescent Lighting

	Transition Level Setting	Day to Night Transition Point
Lighter	1	50 ~ 25 lux
	2	25 ~ 12.5 lux
	3	12.5 ~ 6.25 lux
	4	6.25 ~ 3.125 lux
	5	3.125 ~ 1.5 lux
Darker		

**Transition Detect Time (sec):** Controls the length of time the camera is exposed to a light level before it changes to color or black-white mode. This setting is useful for dark scenes where a bright light is momentarily introduced in the scene (for example, when a car with its headlights turned on passes the camera scene).

### DAY NIGHT MANUAL MODE

The Day Night Manual mode sets the IR cut filter to a fixed position depending on the Position setting. Available settings include Day and Night.

**Day:** Sets the IR filter to the Day (color) position.

**Night:** Sets the IR filter to the Night (black-white) position.

**NOTE:** Position is the only available Day Night setting if the camera exposure is set to Manual.



## CONFIGURING AUTO FOCUS SETTINGS

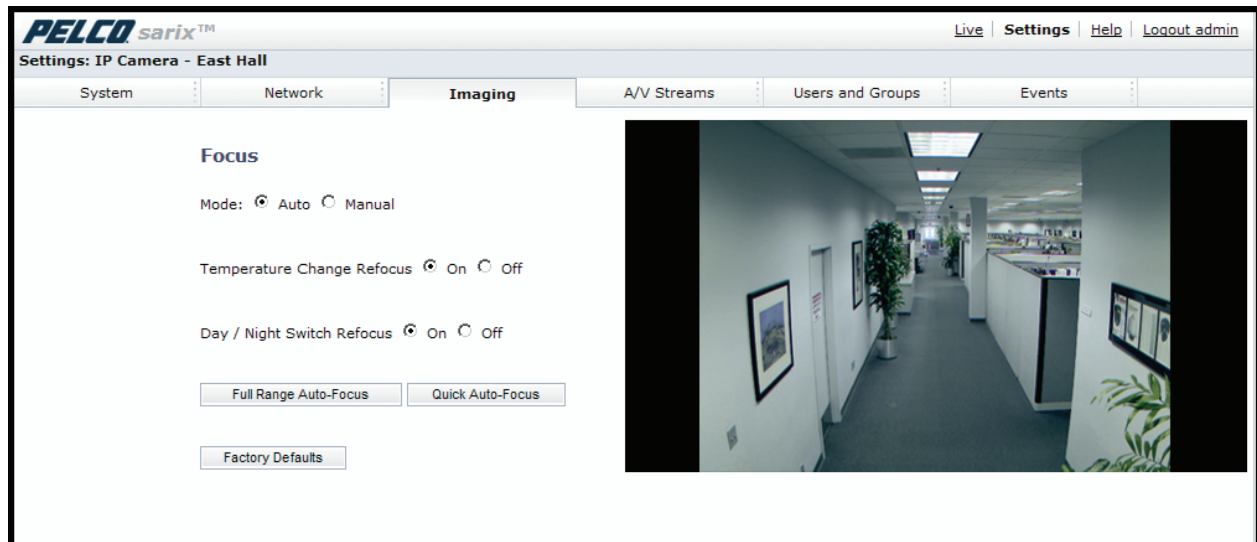

**Figure 24.** Auto Focus Page

1. Place your mouse pointer over the Imaging tab.
2. Select Focus from the drop-down menu.
3. Select the Auto mode.
4. Set the Temperature Change Refocus setting. The camera is programmed to run a quick automatic focus sequence when the internal temperature sensor of the camera detects an environmental temperature change of 41°F (5°C). This focus sequence adjusts the center focal point of the scene to maintain optimal focus. The default setting is On; select Off to turn off this setting.
5. *Day/night cameras only:* Set the Day/Night Switch Refocus setting. The default setting for the Day/Night Switch Refocus is Off. Select On if the camera's focal length is greater than ~25 mm or the night scene uses mostly IR lighting. The best method to determine if the day/night refocus should be enabled is to test the camera with the daytime light conditions, and then test it again with the nighttime light conditions.

When enabled (On) this setting refocuses the camera when the camera changes from day mode (color) to night mode (black-white) or vice versa. For example, if the camera changes from day mode to night mode, the imager automatically adjusts the back focus for the change in light.

6. If required, use one of the following buttons to adjust the focus:

**Full Range Auto-Focus:** The camera starts a full-range search to find the optimal focal point for the scene.

**Quick Auto-Focus:** The camera searches for the optimal focal point in a limited range.

**Restore Settings to Defaults:** The camera resets the auto focus to the factory default setting.

## CONFIGURING MANUAL FOCUS SETTINGS

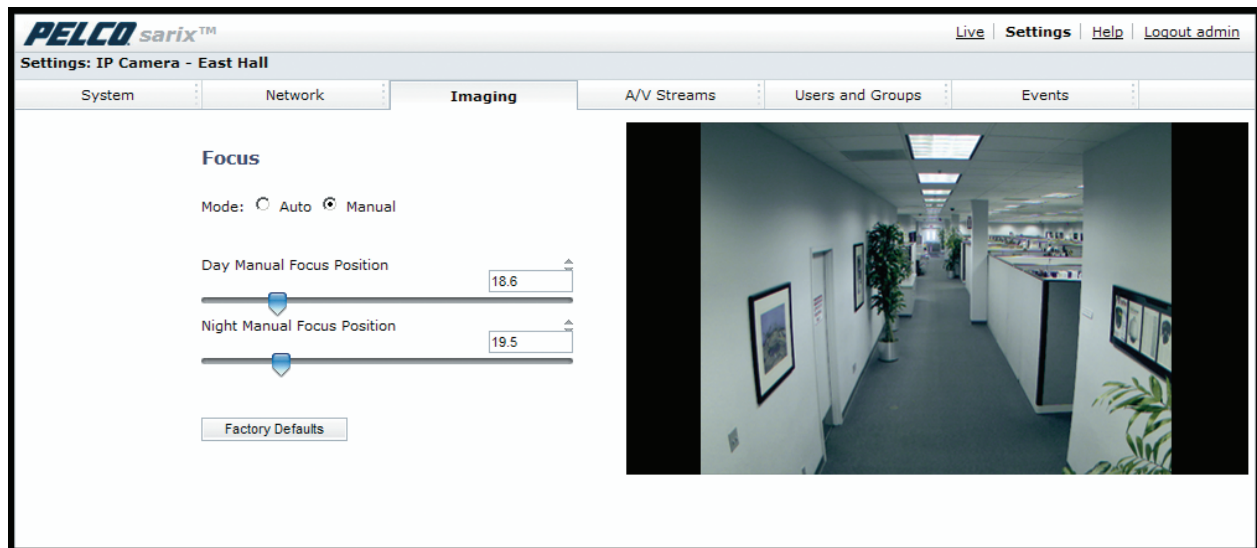

**Figure 25.** Manual Focus Page

**NOTE:** It is recommended to set the focus to Manual when using analytics. If the focus is set to Auto, significant background changes will occur when the camera automatically adjusts to different points within a scene resulting in frequently changing image sharpness. This may cause problems with scene recognition, which will suspend analytics operation or cause false alarms.

1. Place your mouse pointer over the Imaging tab.
2. Select Focus from the drop-down menu.
3. Select the Manual mode.
4. Set one of the following settings:

**Day Manual Focus Position:** (Available only with day/night cameras.) This is the position of the focus mechanism when the IR cut filter is applied. The day mode focus position range is 0 to 100.

**Night Manual Focus Position:** (Available only with day/night cameras.) This is the position of the focus mechanism when the IR cut filter is removed. The night mode focus position range is 0 to 100.

**Manual Focus Position:** (Available only with color cameras.) This is the manual setting of the focus mechanism. The focus range is 0 to 100.

5. Set the Manual Focus Position. The focus range is 0 to 100.
6. If required, click the Restore Settings to Defaults button to reset the focus to the factory default setting.

# SETTING TONE MAP OPTIONS

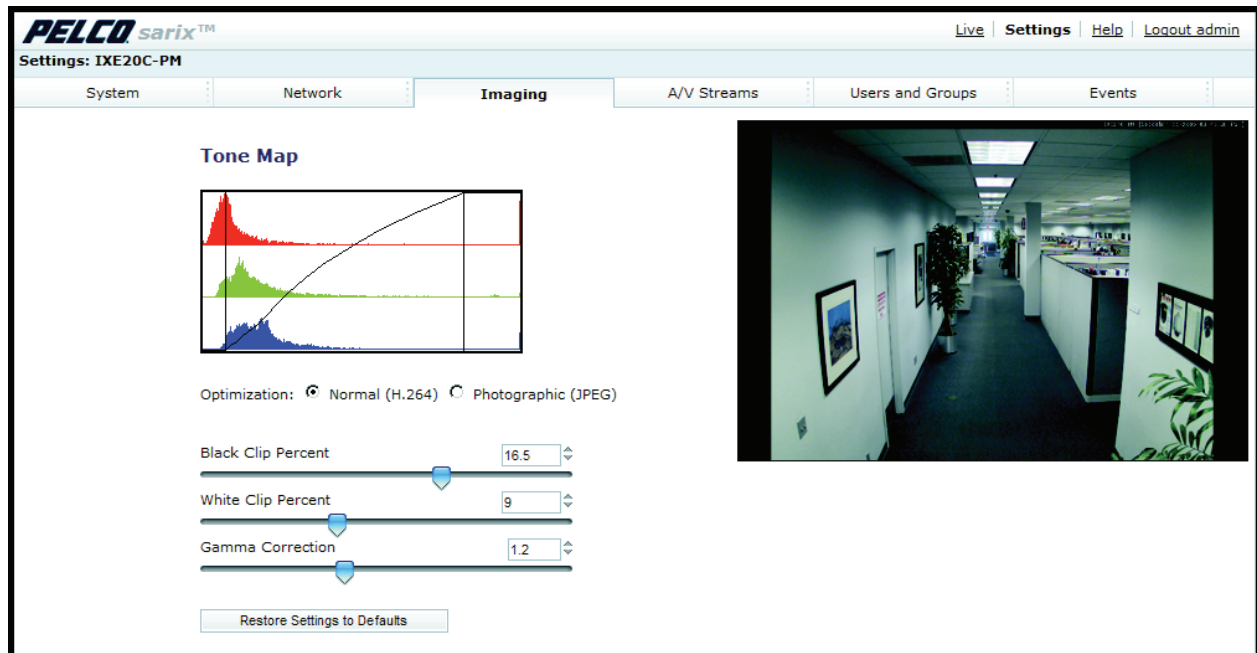

**Figure 26.** Tone Map Page

1. Place your mouse pointer over the Imaging tab.
2. Select Tone Map from the drop-down menu.
3. Select the Optimization setting:

**Normal (H.264):** If the compression standard for the primary stream is H.264, set Optimization to Normal (H.264). This is the default setting.

**Photographic (JPEG):** If the compression standard for the primary stream is JPEG, set Optimization to Photographic (JPEG).

4. Move the Tone Map sliders to adjust the following image settings:

**Black Clip Percent:** Adjusts the percent of pixels set to black. Move the slider to the right to darken the scene by increasing the number of pixels that are mapped to absolute black. The black clip percent range is 0 to 25; the default setting is 0.5.

**White Clip Percent:** Adjusts the percent of pixels set to white. Move the slider to the right to lighten the scene by increasing the number of pixels that are mapped to absolute white. The white clip range is 0 to 25; the default setting is 0.5.

**Gamma Correction:** Adjusts the details in the light and dark areas of the scene. Move the slider to the left to expose more detail in the light areas of the scene; move the slider to the right to expose more detail in the dark areas of the scene. The gamma corrector range is 0.1 to 3.0; the default setting is 2.2.

5. If required, click the Restore Settings to Defaults button to reset the Tone Map to the factory default setting.

## SELECTING AUTO WHITE BALANCE SETTINGS

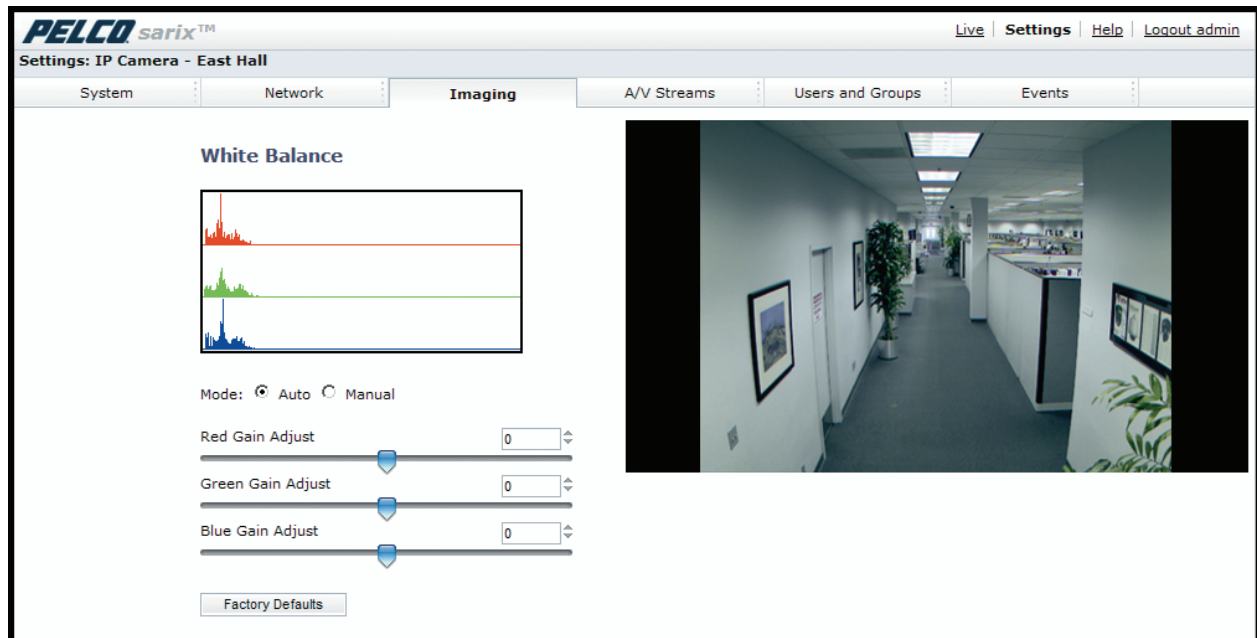

**Figure 27.** Auto White Balance Page

1. Place your mouse pointer over the Imaging tab.
2. Select White Balance from the drop-down menu.
3. Select the Auto mode.
4. Move the sliders to adjust the following settings in Auto mode:

**Red Gain Adjust:** Adjusts the image output in the red range. Move the slider to the right to increase the red level; move the slider to the left to decrease the red level. As you move the slider, you will see the color change on your monitor. The auto range of adjustment is  $-1.0$  to  $1.0$ ; the default setting is  $0$  (zero).

**Green Gain Adjust:** Adjusts the image output in the green range. Move the slider to the right to increase the green level; move the slider to the left to decrease the green level. As you move the slider, you will see the color change on your monitor. The auto range of adjustment is  $-1.0$  to  $1.0$ ; the default setting is  $0$  (zero).

**Blue Gain Adjust:** Adjusts the image output in the blue range. Move the slider to the right to increase the blue level; move the slider to the left to decrease the blue level. As you move the slider, you will see the color change on your monitor. The auto range of adjustment is  $-1.0$  to  $1.0$ ; the default setting is  $0$  (zero).

5. If required, click the Restore Settings to Defaults button to reset the white balance to the factory default setting.

# SELECTING MANUAL WHITE BALANCE SETTINGS

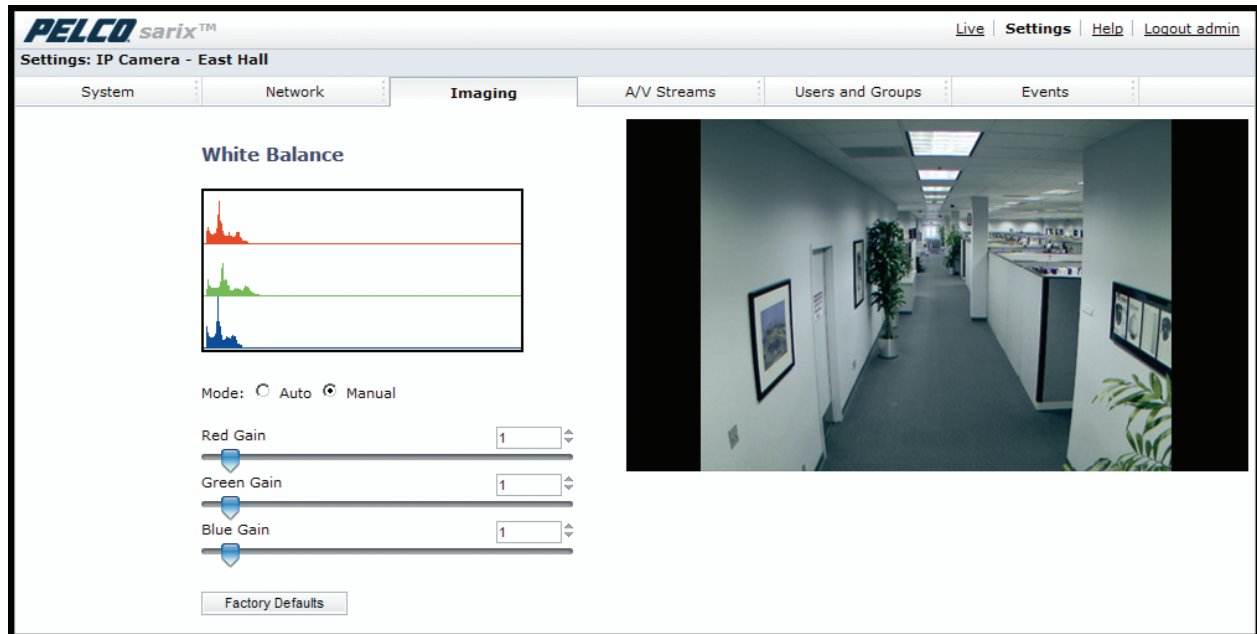

**Figure 28.** Manual White Balance Page

**NOTE:** Manual white balance is recommended only for indoor applications that have a single, unchanging primary light source.

1. Place your mouse pointer over the Imaging tab.
2. Select White Balance from the drop-down menu.
3. Select the Manual mode.
4. Move the sliders to adjust the following settings in Manual mode:

**Red Gain:** Adjusts the image output in the red range. Move the slider to the right to increase the red level; move the slider to the left to decrease the red level. As you move the slider, you will see the color change on your monitor. The manual range of adjustment is 0 to 32; the default setting is 1.

**Green Gain:** Adjusts the image output in the green range. Move the slider to the right to increase the green level; move the slider to the left to decrease the green level. As you move the slider, you will see the color change on your monitor. The manual range of adjustment is 0 to 32; the default setting is 1.

**Blue Gain:** Adjusts the image output in the blue range. Move the slider to the right to increase the blue level; move the slider to the left to decrease the blue level. As you move the slider, you will see the color change on your monitor. The manual range of adjustment is 0 to 32; the default setting is 1.

5. If required, click the Restore Settings to Defaults button to reset the white balance to the factory default setting.

## TURNING ON WINDOW BLANKING

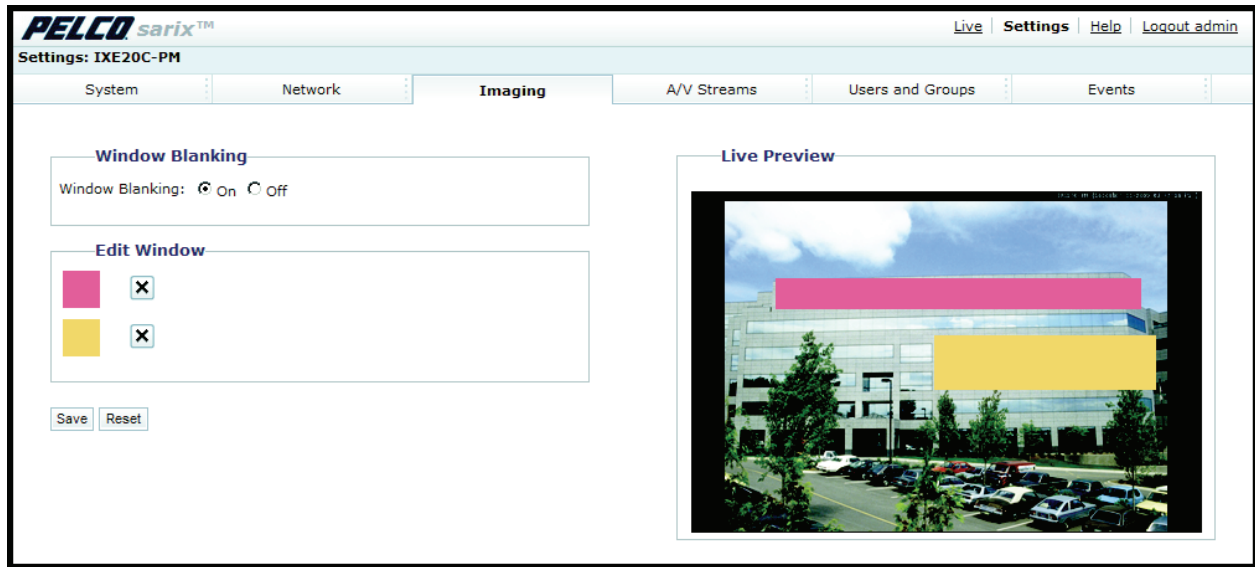

Figure 29. Window Blanking Page

1. Place your mouse pointer over the Imaging tab.
2. Select Window Blanking from the drop-down menu.
3. Select the On option for Window Blanking.
4. Draw a window in the Live Preview area of the page:
  - a. Hold down the left mouse button.
  - b. Drag the mouse diagonally across the area you want to blank.
  - c. A color-coded box appears in the Edit Window section of the page that is the same color as the window drawn in the Live Preview area.

**NOTE:** Up to four blanked windows can be defined, but the blanked area cannot exceed 50 percent of the field of view.

5. To resize the window, click and drag one or more of the points until the window is the desired shape and size.
6. Click the Save button to save the settings, or click the Reset button to clear all of the information you entered without saving it.

## TURNING OFF WINDOW BLANKING

1. Place your mouse pointer over the Imaging tab.
2. Select Window Blanking from the drop-down menu.
3. Select the Off option for Window Blanking.
4. Click the Save button to save the settings, or click the Reset button to clear all of the information you entered without saving it.

## DELETING A WINDOW BLANKING AREA

1. Place your mouse pointer over the Imaging tab.
2. Select Window Blanking from the drop-down menu.
3. In the Edit Window area of the page, click the check box next to the window blanking area you want to delete.
4. Click the Save button to save the settings, or click the Reset button to clear all of the information you entered without saving it.

# A/V Streams Tab

Use the A/V Streams tab to configure the video and audio streams for the camera. The A/V Streams tab includes a Video Presets page, a Video Configuration page, and an Audio Configuration page.

## Video Presets

The Video Preset page includes three fully-configured video presets, which include primary and secondary video stream settings for easy setup. These presets may also be used as a starting point for a custom video configuration. These preset configurations vary depending on camera model.

## Video Configuration

The Video Configuration page allows you to customize the compression, resolution, image rate, and bit rate of the video streams. The default names for the streams are Primary Stream and Secondary Stream. Although each stream can be configured independently, the settings of one stream can limit the options available to the other stream, depending on the processing power used.

**NOTE:** Always configure the primary stream before the secondary stream. The primary stream should always be the most resource-intensive of the streams.

## Audio Configuration

The Audio Configuration page allows you to setup an external audio device. The default setting for Audio is disabled, which means that no audio is transmitted from the camera. When enabled, audio is transmitted from the camera to the PC. Based on your system configuration, images and audio may not be synchronized.

Not all camera models are equipped with an internal audio device. Refer to the specifications for your camera model for information.

**NOTE:** Improper use of audio/visual recording equipment may subject you to civil and criminal penalties. Applicable laws regarding the use of such capabilities vary between jurisdictions and may require, among other things, express written consent from the recorded subjects. You are solely responsible for insuring strict compliance with such laws and for strict adherence to any/all rights of privacy and personalty.

Refer to the following sections for more information:

- *Selecting a Video Preset Configuration* on page 48
- *Configuring a Custom Video Stream Configuration* on page 49
- *Compression Standards* on page 50
- *Available Camera Resolution* on page 50
- *Image Rate* on page 50
- *Bit Rate* on page 51
- *I-Frame Interval* on page 51
- *Quality of Service for Differentiated Services Code Point* on page 51
- *Endura Signing* on page 51
- *Advanced Sharpening* on page 51

## SELECTING A VIDEO PRESET CONFIGURATION

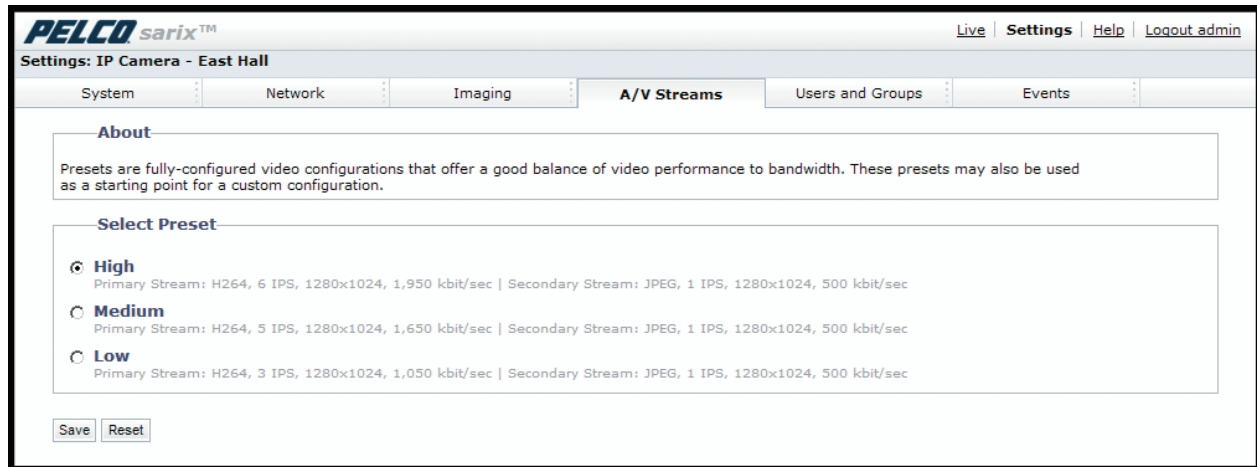

**Figure 30.** Select Video Preset Configuration Page

1. Place your mouse pointer over the A/V Streams tab.
2. Select the Video Preset option from the drop-down menu.
3. Click the button next to the video preset stream configuration (High, Medium, or Low) that you want to select.
4. Click the Save button to save the settings, or click the Reset button to clear your selection without saving it.



# CONFIGURING A CUSTOM VIDEO STREAM CONFIGURATION

The screenshot displays the 'Custom Video Stream Configuration' page for a PELCO sarix™ IP camera. The page is divided into two main sections: 'Primary Stream' and 'Secondary Stream'. Each section contains a 'Clear' button and a set of configuration options.

**Primary Stream:** H264, 6 IPS, 1280x1024, 1,950 kbit/sec. The 'Clear' button is located at the top right of this section. The configuration options are: Name (Primary Stream), Compression Standard (H264), Resolution (1280x1024), Image Rate (6 IPS), Bit Rate (1,950 kbit/sec), I-frame Interval (8), QoS (DSCP) Codepoint (34), and Endura Signing (unchecked). There is also an 'Advanced Sharpening' checkbox under 'Image Processing'.

**Secondary Stream:** JPEG, 1 IPS, 1280x1024, 500 kbit/sec. The 'Clear' button is located at the top right of this section. The configuration options are: Name (Secondary Stream), Compression Standard (JPEG), Resolution (1280x1024), Image Rate (1 IPS), and Bit Rate (500 kbit/sec).

At the bottom of the page, there are 'Save' and 'Reset' buttons.

**Figure 31.** Custom Video Stream Configuration Page

1. Place your mouse pointer over the A/V Streams tab.
2. Select Video Configuration from the drop-down menu.
3. Click both of the Clear buttons to delete the primary and secondary streams settings.
4. *Optional:* In the Primary Stream section, type a user-friendly name in the Name box (2 to 64 characters). A user-friendly name makes it easier to recognize the stream (for example, Live and Recording).
5. Configure the Compression Standard, Resolution, Image Rate, and Bit Rate settings for the primary stream.

**NOTE:** The compression standard, resolution, image rate, and bit rate settings are dependent on each other. You must first decide the priority setting before you configure a stream. For example, if you want an image rate of 30 ips, set the image rate before you configure the other settings.

6. Repeat steps 3 through 5 for the Secondary stream.
7. Click the Save button to save the settings, or click the Reset button to clear all of the information you entered without saving it.

## COMPRESSION STANDARDS

**JPEG:** A commonly used video compression scheme, also known as MJPEG. JPEG has the least impact on the camera's processor, but it requires the most bandwidth.

**MPEG-4 (available only with 0.5 megapixel model):** A full-motion video standard used by most DVD recorders. MPEG-4 is less processor-intensive than JPEG, but it uses more bandwidth than H.264.

**H.264:** A new version of MPEG-4 compression used in high-definition video players such as Blu-ray™ and HD-DVD. H.264 is the most processor-intensive, but it requires the least amount of bandwidth.

## AVAILABLE CAMERA RESOLUTION

Refer to the following table for the resolution capabilities of your camera model

**Table B. Available Camera Resolution**

Camera Model	0.5 Megapixel	1.3 Megapixel	3.1 Megapixel
Available Resolutions	—	—	2048 x 1536
	—	—	1920 x 1080
	—	—	1600 x 1200
	—	1280 x 1024	1280 x 1024
	—	1280 x 960	1280 x 960
	—	1280 x 720	1280 x 720
	800 x 600	800 x 600	800 x 600
	704 x 576	—	—
	704 x 480	—	—
	640 x 512	640 x 512	640 x 512
	640 x 480	640 x 480	640 x 480
	640 x 352	640 x 352	640 x 352
	480 x 368	480 x 368	480 x 368
	480 x 272	480 x 272	480 x 272
	352 x 240	—	—
	352 x 288	—	—
	320 x 256	320 x 256	320 x 256
	320 x 240	320 x 240	320 x 240
	320 x 176	320 x 176	320 x 176

## IMAGE RATE

The image rate is the number of images per second (ips) available for the video stream configuration. Available image rates are 30, 25, 24, 15, 12.5, 12, 10, 8, 7.5, 6, 5, 4, 3, 2.5, 2, and 1.

**NOTE:** The maximum image rate setting might not be obtainable due to the programmed compression standard and the resolution of the stream.

Refer to the following section for more information:

- *Specifications on page 67*

## BIT RATE

The bit rate is the quality of the video stream (rendered in kilobits per second). The higher the value, the higher the video quality and bandwidth required.

**NOTE:** When you change any of the video stream configuration settings, the camera automatically adjusts the bit rate. If you manually reduce the bit rate lower than the camera's automatic setting, the image quality might be reduced and the stream selection options might be limited.

## I-FRAME INTERVAL

The I-frame interval configures the number of partial frames that occur between full frames in the video stream. For example, in a scene where a door opens and a person walks through, only the movements of the door and the person are stored by the video encoder. The stationary background that occurs in the previous partial frames is not encoded, because no changes occurred in that part of the scene. The stationary background is only encoded in the full frames. Partial frames improve video compression rates by reducing the size of the video. As the I-frame interval increases, the number of partial frames increases between full frames. Higher values are only recommended on networks with high reliability. This setting is only available with H.264 and MPEG-4 compression standards.

## QUALITY OF SERVICE FOR DIFFERENTIATED SERVICES CODE POINT

Quality of Service (QoS) for Differentiated Services Code Point (DSCP) is a code that allows the network to prioritize the transmission of different types of data. This setting is only available with H.264 and MPEG-4 compression standards.

### NOTES:

- If you are not familiar with DSCP, contact your network administrator before changing this setting.
- Your network must be configured to use QoS. If you are unsure if your network is QoS-aware, contact your network administrator.

## ENDURA SIGNING

Enabling the Endura Signing feature allows an Endura® system to authenticate video from an Endura recorded stream. This setting is only available with H.264 and MPEG-4 compression standards.

## ADVANCED SHARPENING

The Advanced Sharpening setting enhances picture detail by sharpening the edges in the picture. When this mode is enabled, there is a trade-off between image quality and the resources required for processing power. The maximum camera resolution and image rate will not be available, but the edges of the image seem sharper. Only use this setting if you cannot achieve the sharpness level you want by adjusting the digital processing settings of the camera. The default setting for Advanced Sharpening is Off.

## SELECTING THE AUDIO CONFIGURATION SETTINGS

To use audio with the camera you must have an audio device connected to the accessory port located on the back of the camera. Once the device is connected, audio can only be enabled through the primary stream.

Audio and video may not be synced when viewing and listening to the primary stream through a Web browser. You may experience a three-second delay in video when viewing the primary stream with audio.

**NOTE:** Improper use of audio/visual recording equipment may subject you to civil and criminal penalties. Applicable laws regarding the use of such capabilities vary between jurisdictions and may require, among other things, express written consent from the recorded subjects. You are solely responsible for insuring strict compliance with such laws and for strict adherence to any/all rights of privacy and personality.

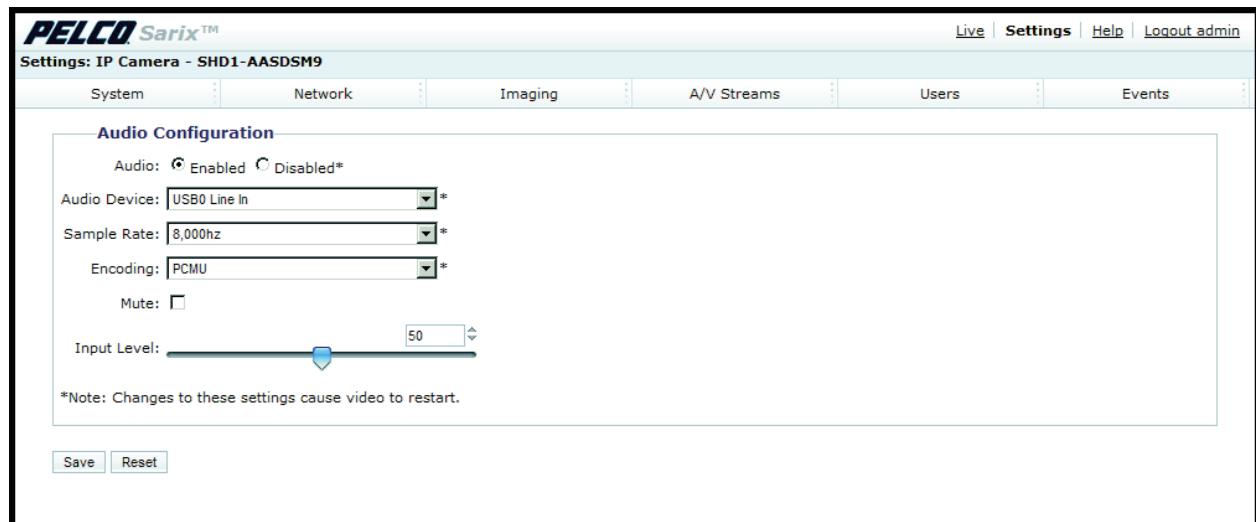

**Figure 32.** Audio Configuration Page

1. Place your mouse pointer over the A/V Streams tab.
2. Select the Audio Configuration option from the drop-down menu.
3. Select the Enabled option in the Audio section.
4. Select the audio device setting from the Audio Device drop-down box.

**USB Line In:** Enables audio from a microphone connected to the USB accessory port.

**Native Line In:** (Only available with specific Sarix™ technology products that have built-in audio. Refer to the specifications for your product model for information.) Enables audio from a microphone connected to the audio-in connector.

**Native Microphone In:** (Only available with specific Sarix technology products that have built-in audio. Refer to the specifications for your product model for information.) Enables audio from the internal microphone.

5. Select the sample rate from the Sample Rate drop-down box. The sample rate is the quality of the audio stream (rendered in hertz per second). The higher the value, the higher the audio quality. Available sample rate settings are 8000, 11025, 16000, 22050, 32000, 44100, and 48000 Hz. The default setting is 8000 Hz.
6. Select the encoding method for the audio device from the Encoding drop-down box. Available encoding methods are PCMU, PCMA, and PM16. The default setting is PCMU.
7. Set the sensitivity of the input level by moving the Input Level slider. Move the slider to the right to increase the sensitivity level; move it to the left to decrease the sensitivity level. For example, if the camera is installed in a noisy environment or the connected microphone has a built-in line amplifier, set the sensitivity to a low setting. The setting range is 0 to 100.

**NOTE:** Do not use the mute button on an audio device, as it will override the audio software settings. To mute the audio device, select the Mute option located on the Audio Configuration page.

8. Click the Save button to save the settings, or click the Reset button to clear all of the information you entered without saving it.

# Users Tab

Use the Users tab to create and manage user accounts and to change the way the camera manages the users settings.

## General Settings

Use the general settings page to set the public user access level. This access level is a predefined set of user permissions that allow the camera to be accessed without logging on. The permission levels are Operator, Viewer, and Disabled.

The General Settings page also allows you to change the way the camera manages users and groups settings. These settings can be managed on a camera-to-camera basis or by using a centralized server to apply changes to multiple cameras. General settings for users and groups include Standalone, Node, and Mixed settings. An example of a Mixed management mode would be using a Lightweight Directory Access Protocol (LDAP) server like Microsoft® Active Directory for authentication.

## Users

User accounts are created to limit the permissions of individuals who are logged onto the camera. The Users page also includes four predefined access level settings that include Administrator, Manager, Operator, and Viewer permissions.

Refer to the following sections for more information.

- *Selecting the Users and Groups Settings* on page 54
- *Creating a New User* on page 55
- *Editing a User* on page 56
- *Deleting A User* on page 56

## SELECTING THE USERS AND GROUPS SETTINGS

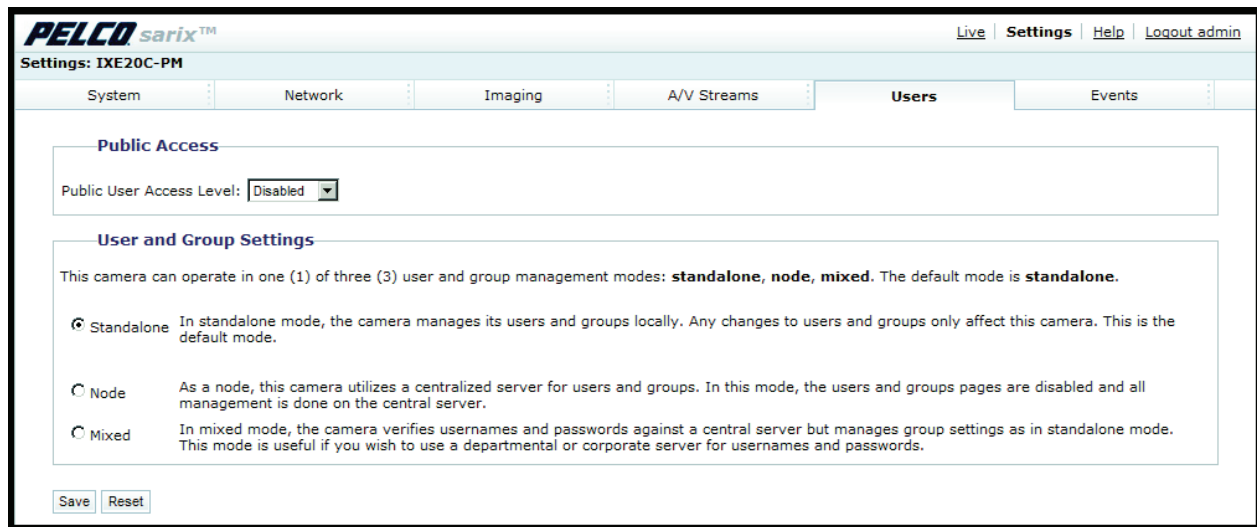

**Figure 33.** General Settings Page for Users

 **WARNING:** The Node and Mixed settings are advanced controls. Consult your network administrator to obtain the required information.

1. Place your mouse pointer over the Users tab.
2. Select General Settings from the drop-down menu.
3. Select an access level from the Public User Access Level drop-down menu.

**Disabled:** The public user has no permissions and cannot access the live view page without a password. The Login screen will appear when the camera's IP address is typed in the address bar of a Web browser.

**Viewers:** The permissions for this user are view video and API access. Viewers is the default setting.

**Operators:** The permissions for this user are view video and API access.

4. Select a user and group management mode by clicking one of the following options:

**Standalone:** The camera manages its users and groups locally. Any changes to users and groups affect only the camera that you are accessing. Standalone is the default setting.

**Node:** The camera uses a centralized server to manage users and groups. In this mode, the users and groups page is disabled and all management is done on the central server. Any changes to users and groups affect all cameras connected to the central server.

When you click the Node option, a Server box appears. Click in the Server box, and then type the name of the central server to manage users and groups.

**Mixed:** The camera verifies user names and passwords against a central server but manages the group settings locally. This is useful if you want to use a departmental or corporate server for user names and passwords. In this mode, the settings on the users page are limited, and any changes to user names and passwords are done on the Lightweight Directory Access Protocol (LDAP) server. While changes to user names and passwords affect all cameras connected to the LDAP server, group permissions must be managed from each camera individually.

When you click the Mixed option, boxes appear for the LDAP Server and Base DN. Click in the LDAP Server and Base DN boxes, and type the necessary information in each box.

5. Click the Save button to save the settings, or click the Reset button to clear all of the information you entered without saving it.

# CREATING A NEW USER

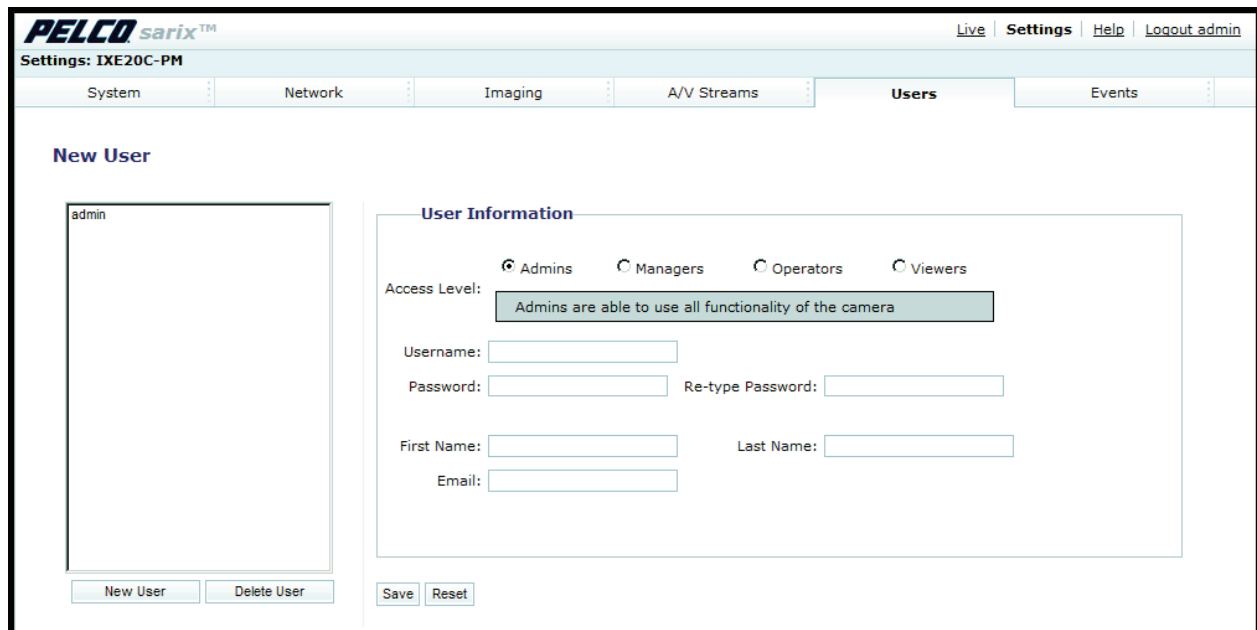

Figure 34. Users Page

1. Place your mouse pointer over the Users tab.
2. Select Users from the drop-down menu.
3. Select the Access Level for the user.  
**Admins:** This user has access to all camera settings.  
**Managers:** This user has access to all settings *except* they cannot modify a user's permissions or restore factory default settings.  
**Operators:** The permissions for this user are view video, PTZ functions, and API access.  
**Viewers:** The permissions for this user are view video and API access.
4. Click in the Username box and type a user name (2 to 23 alphanumeric characters). User names are not case-sensitive and are saved in lowercase characters.
5. Click in the Password box and type a password (4 to 16 alphanumeric characters). Passwords are case-sensitive.
6. Click in the Retype Password box and retype your password.
7. Click in the First Name box and type the user's first name (1 to 32 alphanumeric characters).
8. Click in the Last Name box and type the user's last name (1 to 32 alphanumeric characters).
9. Click in the Email box and type the user's email address.
10. Click the Save button to save the settings and create a new user (the new user profile appears in the box on the left side of the page), or click the Reset button to clear all of the information you entered without saving it.

## EDITING A USER

1. Place your mouse pointer over the Users tab.
2. Select Users from the drop-down menu.
3. Click the user profile that you want to edit from the box on the left side of the page.
4. If required, select a different Access Level for the user.
5. Double-click in each of the text boxes to highlight the text. Type the new information in each text box.

**NOTE:** The Username cannot be modified; this text box is read-only.

6. Click the Save button to save the settings, or click the Reset button to clear all of the information you entered without saving it.

## DELETING A USER

1. Place your mouse pointer over the Users tab.
2. Select Users from the drop-down menu.
3. Click the user profile that you want to delete from the defined users section located in the box on the left side of the page.
4. Click the Delete User button. A dialog box appears with the message "Are you sure you want to delete the user?"
5. Click OK. The user profile is deleted from the defined user profiles section.

**NOTE:** The "admin" user cannot be deleted.



# Events Tab

Use the Events tab to configure camera events and analytics.

Events are activated by user-defined event sources that tell the device how to react when an event occurs. Event handlers are the actions that the device takes when an event occurs. For example, a system source can be configured to send email to an operator if the system shuts-down and restarts.

## Sources

The camera supports one physical input alarm source, a system source, and a timer source. The Alarm source is the camera input for an external signaling device, such as a door contact or motion detector. The System source is activated when the camera restarts. The Timer source is a user-defined event that activates an event after a specified amount of time. For example, the timer can be activated every 60 seconds to save an image to an SD card.

## Handlers

The device supports a Send Email handler, a "Write JPEG to SD Card handler," and an "Upload JPEG to FTP Server handlers." The Send Email handler sends an email to a defined email address when an event is activated. The "Write JPEG to SD Card" saves a JPEG of the activated event to an SD card. The "Upload JPEG to FTP Server" saves a JPEG of the activated event to a defined FTP server.

## Analytic Configuration

Pelco analytics can be configured and enabled using a standard Web browser. The device is preloaded with Pelco's Camera Sabotage behavior, which detects contrast changes in the field of view. An alarm is triggered if the lens is obstructed with spray paint, a cloth, or covered with a lens cap. Any unauthorized repositioning of the camera also triggers an alarm.

Pelco analytics are also compatible with Endura® or a third-party system that supports Pelco's Analytics API system. Refer to the specific product documentation for instructions on how to configure and enable Pelco analytics.

**NOTE:** Analytic alerts can be seen in the event stream, but alarms are only transmitted through the analytics API.

# SOURCES

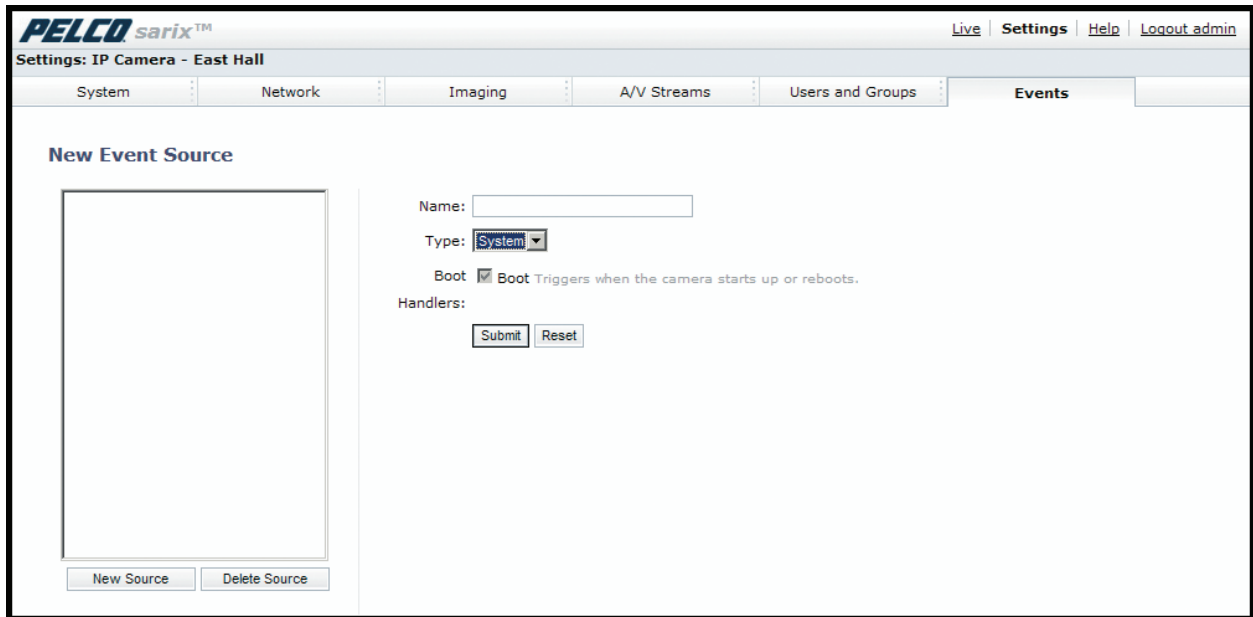

**Figure 35.** New Event Source Page

An event is a preprogrammed camera function that is automatically activated by an event source. The camera supports the following types of event sources:

**Alarm Source:** The camera supports one alarm source. The sources are the camera inputs for external signaling devices, such as door contacts or motion detectors.

**System Source:** A system source is activated when the camera restarts.

**Timer Source:** A timer source is a user-defined event. The user can program the timer to activate an event after a specified amount of time. For example, the timer can be activated every 60 seconds to save an image to an SD card.

## CREATING AN ALARM EVENT SOURCE

1. Place your mouse pointer over the Events tab.
2. Select Sources from the drop-down menu.
3. Click in the Name box and type a user-friendly name (2 to 23 alphanumeric characters).
4. Select Alarm from the Type drop-down menu.
5. Move the Dwell Time slider to set the amount of time in seconds that the alarm is active. The dwell time range is 0.1 to 200 seconds; the default setting is 0.1.
6. Select either normal or reversed from the Polarity drop-down menu.
7. Select either true or false from the Supervised drop-down menu.
8. Click the Submit button to save the settings, or click the Reset button to clear all of the information you entered without saving it.

## **CREATING A SYSTEM EVENT SOURCE**

1. Place your mouse pointer over the Events tab.
2. Select Sources from the drop-down menu.
3. Click in the Name box and type a user-friendly name (2 to 23 alphanumeric characters).
4. Select System from the Type drop-down menu.
5. Select the Boot check box to activate an event when the camera reboots.
6. Click the Submit button to save the settings, or click the Reset button to clear all of the information you entered without saving it.

## **CREATING A TIMER EVENT SOURCE**

1. Place you mouse over the Events tab.
2. Select Sources from the drop-down menu.
3. Click in the Name box and type a user-friendly name (2 to 23 alphanumeric characters).
4. Select Timer from the Type drop-down menu.
5. Click in the Frequency box and type a number. Select seconds, minutes, hours, or days from the Frequency drop-down menu.
6. Click the Submit button to save the settings, or click the Reset button to clear all of the information you entered without saving it.

## **EDITING AN EVENT SOURCE**

1. Place your mouse pointer over the Events tab.
2. Select Sources from the drop-down menu.
3. Click the source profile that you want to delete from the defined source box located on the left side of the page.
4. Make any necessary changes to the available fields.
5. Click the Submit button to save the settings, or click the Reset button to clear all of the information you entered without saving it.

## **DELETING AN EVENT SOURCE**

1. Place your mouse pointer over the Events tab.
2. Select Sources from the drop-down menu.
3. Click the source profile that you want to delete from the defined source box located on the left side of the page.
4. Click the Delete Source button. A dialog box appears with the message "Are you sure you want to delete the source?"
5. Click OK. The source profile is deleted from the defined source box.

# HANDLERS

PELCO sarix™ Live | Settings | Help | Logout admin

Settings: IP Camera - East Hall

System | Network | Imaging | A/V Streams | Users and Groups | **Events**

### New Event Handler

Name:

Type:

No SMTP server is configured; email alerts will not be sent. To configure your SMTP server, visit the [System](#) page.

To:  From:

Subject:   JPEG Snapshot

Message: Maximum of 512 characters allowed

You may insert %T to indicate time of day in the body of your message.

Attach Raw Event Data

Filter:  Sun.  Mon.  Tues.  Wed.  Thur.  Fri.  Sat.

Start:  End:

Enter time values in 24-hour notation, e.g; 8:00AM = 0800, 4PM = 1600

Sources:

**Figure 36.** New Event Handler Page

Event handlers are the actions that the camera takes when an event occurs. The camera supports the following event handlers:

**Send Email:** Sends an email to a defined email address when an event is activated. The Simple Mail Transfer Protocol (SMTP) server must be configured to accept the camera's IP address.

**Write JPEG to SD Card:** Saves a JPEG of the activated event to an SD card. An SD card must be installed in the device for this handler to function.

**NOTE:** The SD card must be formatted as FAT32. Other formats are not compatible with the camera.

**Upload JPEG to FTP Server:** Saves a JPEG of the activated event to a defined FTP server.

## CREATING AN EVENT HANDLER: SEND EMAIL

**NOTE:** To use email notification, the camera must be connected to a local area network (LAN) that maintains an SMTP mail server. Consult your network administrator for information on configuring email notification on your local network.

1. Configure the SMTP server to send email.
2. Place your mouse pointer over the Events tab.
3. Select Handler from the drop-down menu.
4. Click in the Name box and type a user-friendly name (2 to 23 alphanumeric characters).
5. Select Send Email from the Type drop-down menu.
6. Click in the text boxes (To, From, Subject, and Message), and then type the necessary information in each text box.
7. Select the JPEG Snapshot box if you want to send a JPEG as an attachment.
8. Select the Attach Raw Event Data box if you want the email to include extra data about the event. For example, select this box if the event is triggered by an alarm and you want to receive data about the state, time, or type of alarm.
9. If you do not want the handler activated every time an event occurs, set filters for the handler.
  - a. Select the day(s) of the week on which you want emails to be sent.
  - b. Type times in the Start and End boxes for the days you have selected. Use time values in 24-hour notation (for example, use 0800 for 8:00 a.m., 1600 for 4:00 p.m.).
10. Select one or more event sources to send an email when those event sources are activated.
11. Click the Submit button to save the settings, or click the Reset button to clear all of the information you entered without saving it.

Refer to the following sections for more information:

- *System Tab* on page 24
- *Example Handler Filter Setup* on page 64

## CREATING AN EVENT HANDLER: WRITE JPEG TO SD CARD

1. Install an SD card in the SD card slot located on the back of the camera.  
**NOTE:** The SD card must be formatted as FAT32. Other formats are not compatible with the camera.
2. Place your mouse pointer over the Events tab.
3. Select Handlers from the drop-down menu.
4. Click in the Name box and type a user-friendly name (2 to 23 alphanumeric characters).
5. Select "Write JPEG to SD Card" in the Type drop-down menu.
6. The JPEG files saved to the SD card will be given file names that correspond to the date and time of the event. Select a time standard from the "File name" drop-down menu.
7. Click in the Size limit box and type a number. Select Kilobytes, Megabytes, or Gigabytes from the Size Limit drop-down menu.  
**NOTE:** Do not select a size limit that is larger than the amount of memory on the SD card. For example, if the SD card is 2 MB, do not exceed 2 MB in the Size Limit box.
8. If you do not want the handler activated every time an event occurs, set filters for the handler.
  - a. Select the day(s) of the week on which you want JPEGs saved to the SD card.
  - b. Type times in the Start and End boxes for the days you have selected. Use time values in 24-hour notation (for example, use 0800 for 8:00 a.m., 1600 for 4:00 p.m.).
9. Select one or more sources to save a JPEG to the SD card when those event sources are activated.
10. Click the Submit button to save the settings, or click the Reset button to clear all of the information you entered without saving it.

Refer to the following section for more information:

- *Example Handler Filter Setup* on page 64

## CREATING AN EVENT HANDLER: UPLOAD JPEG TO FTP SERVER

1. Place your mouse pointer over the Events tab.
2. Select Handlers from the drop-down menu.
3. Click in the Name box and type a user-friendly name (2 to 23 alphanumeric characters).
4. Select "Upload JPEG to FTP Server" in the Type drop-down menu.
5. Click in the Server box and type the server address (1 to 32 alphanumeric characters).
6. Click in the Username box and type the user's name (1 to 32 alphanumeric characters).
7. Click in the Password box and type a password (4 to 16 alphanumeric characters).
8. Click in the Base Path box and type the base path (1 to 32 alphanumeric characters).
9. The JPEG files uploaded to the FTP server will be given file names that correspond to the date and time of the event. Select a time standard from the "File name" drop-down menu.
10. If you do not want the handler activated every time an event occurs, set filters for the handler.
  - a. Select the day(s) of the week on which you want JPEGs saved to the FTP server.
  - b. Type times in the Start and End boxes for the days you have selected. Use time values in 24-hour notation (for example, use 0800 for 8:00 a.m., 1600 for 4:00 p.m.).
11. Select one or more sources to save a JPEG to the FTP server when those event sources are activated.
12. Click the Submit button to save the settings, or click the Reset button to clear all of the information you entered without saving it.

Refer to the following section for more information:

- *Example Handler Filter Setup* on page 64

## CREATING AN EVENT HANDLER: OPEN/CLOSE RELAY

1. Place your mouse pointer over the Events tab.
2. Select Handlers from the drop-down menu.
3. Click in the Name box and type a user-friendly name (2 to 23 alphanumeric characters).
4. Select Open/Close Relay in the Type drop-down menu.
5. Move the On Time slider to set the amount of time that the relay will remain open. The time range is 0.1 to 200 seconds; the default setting is 0.1.
6. Move the Off Time slider to set the amount of time that the relay will remain closed. The time range is 0.1 to 200 seconds; the default setting is 0.1.
7. Click in the Pulse Count box and type a number.
8. If you do not want the handler activated every time an event occurs, set filters for the handler.
  - a. Select the day(s) of the week on which you want the relay opened/closed.
  - b. Type times in the Start and End boxes for the days you have selected. Use time values in 24-hour notation (for example, use 0800 for 8:00 a.m., 1600 for 4:00 p.m.).
9. Select one or more event sources to open/close the relay when those event sources are activated.
10. Click the Submit button to save the settings, or click the Reset button to clear all of the information you entered without saving it.

Refer to the following section for more information:

- *Example Handler Filter Setup* on page 64

## EDITING AN EVENT HANDLER

1. Place your mouse pointer over the Events tab.
2. Select Handlers from the drop-down menu.
3. Click the handler profile that you want to delete from the defined handler box located on the left side of the page.
4. Make any necessary changes to the available fields.
5. Click the Submit button to save the settings, or click the Reset button to clear all of the information you entered without saving it.

## DELETING AN EVENT HANDLER

1. Place your mouse pointer over the Events tab.
2. Select Handlers from the drop-down menu.
3. Click the handler profile that you want to delete from the defined handler box located on the left side of the page.
4. Click the Delete Handler button. A dialog box appears with the message "Are you sure you want to delete the handler?"
5. Click OK. The handler profile is deleted from the defined handler box.

## EXAMPLE HANDLER FILTER SETUP

If you do not want a handler activated every time an event occurs, use the filter fields to limit handlers. For example, you only want a handler activated when an event occurs after business hours. Your business is open Monday through Saturday, 8:00 a.m. to 6:00 p.m., and it is closed on Sunday.

1. Create a handler for Monday through Saturday:
  - a. Select the day filter fields Monday through Saturday.
  - b. Type **0000** in the Start box and **0800** in the End box.
  - c. Click the plus button (+) to add another time range. Type **1800** in the second Start box and type **2400** in the second End box.
  - d. Select the source(s) that activates the handler.
  - e. Click the Submit button to save the handler.
2. Create a second handler for Sunday:
  - a. Select Sunday from the day filter fields.
  - b. Do not set a Start time or End time as this is a 24-hour event.
  - c. Select the source(s) that activates the handler.
  - d. Click the Submit button to save the second handler.



# ANALYTIC CONFIGURATION

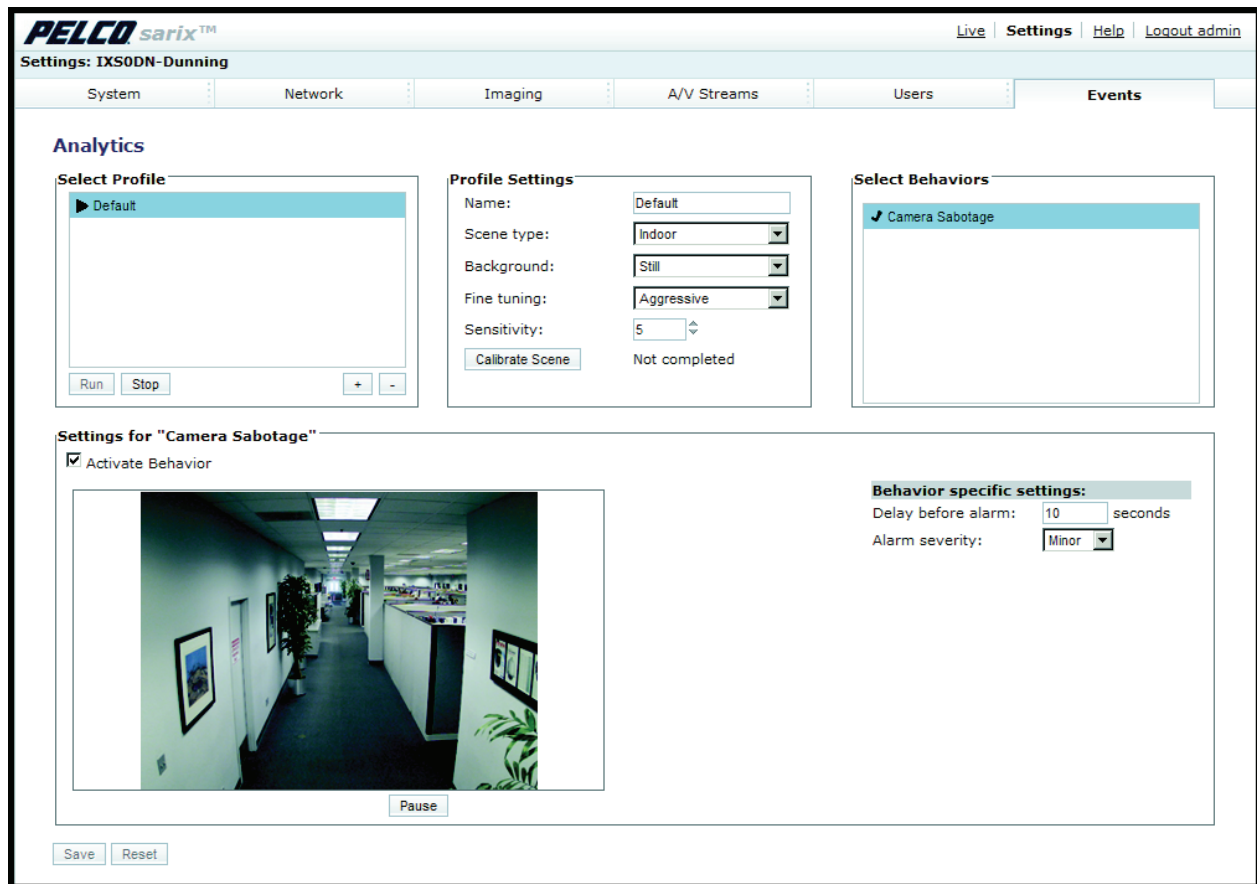

**Figure 37.** Analytic Configuration Page

To configure the Camera Sabotage behavior using a standard Web browser, you must create a profile, activate the behavior, and select the behavior-specific settings for the profile.

Camera Sabotage uses the following behavior-specific settings:

**Delay before alarm:** Defines the delay between the time a violation is detected and the actual trigger of an alarm. If the violation stops within the delay period, no alarm is triggered. If the violation lasts longer than the delay period, an alarm is triggered. The default setting is 10 seconds.

**Alarm severity:** Defines the severity level of an alarm. Available settings include Minor, Normal, Major and Critical. The default setting is Minor.

**NOTE:** Analytic alerts can be seen in the event stream, but alarms are only transmitted through the analytics API.

## CREATING A NEW PROFILE

1. Place your mouse pointer over the Events tab.
2. Select Analytic Configuration from the drop-down menu.
3. Click the plus button (+) located in the Select Profile section.
4. Type a descriptive name for the profile in the Name box located in the Profile Settings section.

**NOTE:** Consider naming profiles based on their function. A more descriptive name makes it easier to recognize and locate a profile.

5. Select the Scene Type, Background, Fine Tuning, and Sensitivity settings from the drop-down menus located in the Profile Settings section.
6. Click the Calibrate Scene button to calibrate the scene.

**NOTE:** Set the perspective settings to reflect the camera's angle. This information will make the object sizes you set on the next tab more meaningful and help reduce the number of false alarms.

7. Select the behavior for the profile from the "Select behaviors" section.
8. Configure the settings for the behavior.
9. Click the Save button to save the profile. The new profile name appears in the Select Profile section.

## REVISING A PROFILE

1. Place your mouse pointer over the Events tab.
2. Select Analytic Configuration from the drop-down menu.
3. Select the profile name from the Select Profile section. The settings for the profile appear.
4. Make the required changes to the profile settings.
5. Click the Save button to save the settings, or click the Reset button to clear all of the information you entered without saving it.

## DELETING A PROFILE

1. Place your mouse pointer over the Events tab.
2. Select Analytic Configuration from the drop-down menu.
3. Select the profile name from the Select Profile section.
4. Click the minus button (-) located in the Select Profile section.
5. A dialog box opens and the following message appears: "Are you sure you want to delete the profile?"
6. Click the OK button to delete the profile.

# Specifications

---

## IXS0 SERIES

### MODELS

IXS0C	SVGA 0.5 megapixel network color camera
IXS0DN	SVGA 0.5 megapixel network day/night camera

### GENERAL

Imaging Device	
16:9 Aspect Ratio	1/3-inch (effective)
4:3 and 5:4 Aspect Ratios	1/4-inch (effective)
Imager Type	CMOS
Imager Readout	Progressive scan
Maximum Resolution	800 x 600
Signal-to-Noise Ratio	50 dB
Auto Iris Lens Type	DC drive
Electronic Shutter Range	1 ~ 1/100,000 sec
Wide Dynamic Range	60 dB
White Balance Range	2,000° to 10,000°K
Sensitivity	f/1.2; 2850°K; SNR >24 dB
Color (33 ms)	0.50 lux
Color SENS (500 ms)	0.12 lux
Mono (33 ms)	0.25 lux
Mono SENS (500 ms)	0.03 lux

### ELECTRICAL

Port	RJ-45 connector for 100Base-TX Auto MDI/MDI-X
Cabling Type	Cat5 or better for 100Base-TX
Power Input	24 VAC or PoE (IEEE 802.3af class 3)
Power Consumption (camera only)	<6 W
Input Current	
PoE	<200 mA maximum
24 VAC	<295 mA nominal; <390 mA maximum
Local Storage	Mini SD
Alarm Input	10 VDC maximum, 5 mA maximum
Relay Output	12 VDC maximum, 150 mA maximum
Service Port	External 3-connector, 2.5 mm provides NTSC/PAL video output

### MECHANICAL

Lens Mount	CS mount, adjustable
Camera Mount	0.25-inch (0.64 cm) UNC-20 screw, top and bottom of camera housing

## VIDEO

Video Encoding	H.264 base profile, MPEG-4, and MJPEG
Video Streams	Up to 2 simultaneous streams; the second stream is variable based on the setup of the primary stream
Frame Rate	Up to 30, 25, 24, 15, 12.5, 12, 10, 8, 7.5, 6, 5, 4, 3, 2.5, 2, 1 (dependent upon coding, resolution, and stream configuration)

### Available Resolutions

Resolution				Maximum IPS		
MPx	Width	Height	Aspect Ratio	MJPEG	H.264 Base Profile	MPEG-4
0.5	800	600	4:3	30	25	N/A
0.4	704	576	4CIF (PAL)	25	25	25
0.3	704	480	4CIF (NTSC)	30	30	30
0.3	640	512	5:4	30	30	30
0.3	640	480	4:3	30	30	30
0.3	640	352	16:9	30	30	30
0.2	480	368	4:3	30	30	30
0.2	480	272	16:9	30	30	30
0.1	352	288	CIF (PAL)	25	25	25
0.1	352	240	CIF (NTSC)	30	30	30
0.1	320	250	5:4	30	30	30
0.1	320	240	4:3	30	30	30
0.1	320	176	16:9	30	30	30

Supported Protocols	TCP/IP, UDP/IP (Unicast, Multicast IGMP), UPnP, DNS, DHCP, RTP, RTSP, NTP, IPv4, SNMP, QOS, HTTP, HTTPS, LDAP (client), SSH, SSL, SMTP, FTP, mDNS (Bonjour®), and 802.1x (EAP)
Users	
Unicast	Up to 20 simultaneous users depending on resolution settings (2 guaranteed streams)
Multicast	Unlimited users H.264 or MPEG-4
Security Access	Password protected
Software Interface	Web browser view and setup, up to 16 cameras
Pelco System Integration	Endura 1.5 or later (MPEG-4) or Endura 2.0 or later (H.264); Digital Sentry 4.2 IP bundle 3 or later; DX8100 Series 2.0 or later; and DVR5100 version 1.5.4 or later
Open IP Integration	Pelco IP camera API

## ENVIRONMENTAL

Operational Temperature	14° to 122°F (–10° to 50°C)
Storage Temperature	14° to 158°F (–10° to 70°C)
Storage Humidity	20% to 90%, noncondensing

## PHYSICAL

Dimensions	5.4" D x 3.1" W x 3.0" H (13.7 x 7.9 x 7.6 cm)
Weight (without lens)	1.14 lb (0.52 kg)

# IX10 SERIES

## MODELS

IX10C	1.3 megapixel network color camera
IX10DN	1.3 megapixel network day/night camera

## GENERAL

Imaging Device	1/3-inch (effective)
Imager Type	CMOS
Imager Readout	Progressive scan
Maximum Resolution	1280 x 1024
Signal-to-Noise Ratio	50 dB
Auto Iris Lens Type	DC drive
Electronic Shutter Range	1 ~ 1/100,000 sec
Wide Dynamic Range	60 dB
White Balance Range	2,000° to 10,000°K
Sensitivity	f/1.2; 2,850°K; SNR >24dB
Color (33 ms)	0.50 lux
Color SENS (500 ms)	0.12 lux
Mono (33 ms)	0.25 lux
Mono SENS (500 ms)	0.03 lux

## ELECTRICAL

Port	RJ-45 connector for 100Base-TX Auto MDI/MDI-X
Cabling Type	Cat5 or better for 100Base-TX
Power Input	24 VAC or PoE (IEEE 802.3af class 3)
Power Consumption (camera only)	<6 W
Current Consumption	
PoE	<200 mA maximum
24 VAC	<295 mA nominal; <390 mA maximum
Local Storage	Mini SD
Alarm Input	10 VDC maximum, 5 mA maximum
Relay Output	12 VDC maximum, 150 mA maximum
Service Port	External 3-connector, 2.5 mm provides NTSC/PAL video output

## MECHANICAL

Lens Mount	CS mount, adjustable
Camera Mount	0.25-inch (0.64 cm) UNC-20 screw, top and bottom of camera housing

## VIDEO

Video Encoding	H.264 base profile and MJPEG
Video Streams	Up to 2 simultaneous streams; the second stream is variable based on the setup of the primary stream
Frame Rate	Up to 30, 25, 24, 15, 12.5, 12, 10, 8, 7.5, 6, 5, 4, 3, 2.5, 2, 1 (dependent on the coding, resolution, and stream configuration)
Available Resolutions	

Resolution				Maximum IPS	
MPx	Width	Height	Aspect Ratio	MJPEG	H.264 Base Profile
1.3	1280	1024	5:4	20	8
1.2	1280	960	4:3	20	8
0.9	1280	720	16:9	30	11
0.5	800	600	4:3	30	25
0.3	640	512	5:4	30	30
0.3	640	480	4:3	30	30
0.3	640	352	16:9	30	30
0.2	480	368	4:3	30	30
0.2	480	272	16:9	30	30
0.1	320	256	5:4	30	30
0.1	320	240	4:3	30	30
0.1	320	176	16:9	30	30

Supported Protocols	TCP/IP, UDP/IP (Unicast, Multicast IGMP), UPnP, DNS, DHCP, RTP, RTSP, NTP, IPv4, SNMP, QOS, HTTP, HTTPS, LDAP (client), SSH, SSL, SMTP, FTP, mDNS (Bonjour), and 802.1x (EAP)
Users	
Unicast	Up to 20 simultaneous users depending on resolution settings (2 guaranteed streams)
Multicast	Unlimited users H.264 or MPEG-4
Security Access	Password protected
Software Interface	Web browser view and setup, up to 16 cameras
Pelco System Integration	Endura 2.0 or later, Digital Sentry 4.2 IP bundle 3 or later
Open IP Integration	Pelco IP camera API

## ENVIRONMENTAL

Operational Temperature	14° to 122°F (–10° to 50°C)
Storage Temperature	14° to 158°F (–10° to 70°C)
Storage Humidity	20% to 90%, noncondensing

## PHYSICAL

Dimensions	5.4" D x 3.1" W x 3.0" H (13.7 x 7.9 x 7.6 cm)
Weight (without lens)	1.14 lb (0.52 kg)

# IX30 SERIES

## MODELS

IX30C	3.1 megapixel network color camera
IX30DN	3.1 megapixel network day/night camera

## GENERAL

Imaging Device	1/3-inch (effective)
Imager Type	CMOS
Imager Readout	Progressive scan
Maximum Resolution	2048 x 1536
Signal-to-Noise Ratio	50 dB
Auto Iris Lens Type	DC drive
Electronic Shutter Range	1 ~ 1/100,000 sec
Wide Dynamic Range	60 dB
White Balance Range	2,000° to 10,000°K
Sensitivity	f/1.2; 2,850°K; SNR >24dB
Color (33 ms)	0.50 lux
Color SENS (500 ms)	0.12 lux
Mono (33 ms)	0.25 lux
Mono SENS (500 ms)	0.03 lux

## ELECTRICAL

Port	RJ-45 connector for 100Base-TX Auto MDI/MDI-X
Cabling Type	Cat5 or better for 100Base-TX
Power Input	24 VAC or PoE (IEEE 802.3af class 3)
Power Consumption (camera only)	<6 W
Current Consumption	
PoE	<200 mA maximum
24 VAC	<295 mA nominal; <390 mA maximum
Local Storage	Mini SD
Alarm Input	10 VDC maximum, 5 mA maximum
Relay Output	12 VDC maximum, 150 mA maximum
Service Port	External 3-connector, 2.5 mm provides NTSC/PAL video output

## MECHANICAL

Lens Mount	CS mount, adjustable
Camera Mount	0.25-inch (0.64 cm) UNC-20 screw, top and bottom of camera housing

## VIDEO

Video Encoding

H.264 base profile and MJPEG

Video Streams

Up to 2 simultaneous streams; the second stream is variable based on the setup of the primary stream.

Frame Rate

Up to 30, 25, 24, 15, 12.5, 12, 10, 8, 7.5, 6, 5, 4, 3, 2.5, 2, 1

(dependent on the coding, resolution, and stream configuration)

Available Resolutions

Resolution				Maximum IPS	
MPx	Width	Height	Aspect Ratio	MJPEG	H.264 Base Profile
3.1	2048	1536	4:3	10	3
2.1	1920	1080	16:9	15	6
1.9	1600	1200	4:3	15	6
1.3	1280	1024	5:4	20	8
1.2	1280	960	4:3	20	8
0.9	1280	720	16:9	30	11
0.5	800	600	4:3	30	25
0.3	640	512	5:4	30	30
0.3	640	480	4:3	30	30
0.3	640	352	16:9	30	30
0.2	480	368	4:3	30	30
0.2	480	272	16:9	30	30
0.1	320	256	5:4	30	30
0.1	320	240	4:3	30	30
0.1	320	176	16:9	30	30

Supported Protocols

TCP/IP, UDP/IP (Unicast, Multicast IGMP), UPnP, DNS, DHCP, RTP, RTSP, NTP, IPv4, SNMP, QOS, HTTP, HTTPS, LDAP (client), SSH, SSL, SMTP, FTP, mDNS (Bonjour), and 802.1x (EAP)

Users

Unicast

Up to 20 simultaneous users depending on resolution settings (2 guaranteed streams)

Multicast

Unlimited users H.264 or MPEG-4

Security Access

Password protected

Software Interface

Web browser view and setup, up to 16 cameras

Pelco System Integration

Endura 2.0 or later, Digital Sentry 4.2 IP bundle 3 or later

Open IP Integration

Pelco IP camera API

## ENVIRONMENTAL

Operational Temperature

14° to 122°F (–10° to 50°C)

Storage Temperature

14° to 158°F (–10° to 70°C)

Storage Humidity

20% to 90%, noncondensing

## PHYSICAL

Dimensions

5.4" D x 3.1" W x 3.0" H  
(13.7 x 7.9 x 7.6 cm)

Weight (without lens)

1.14 lb (0.52 kg)



## PRODUCT WARRANTY AND RETURN INFORMATION

### WARRANTY

Pelco will repair or replace, without charge, any merchandise proved defective in material or workmanship **for a period of one year** after the date of shipment.

Exceptions to this warranty are as noted below:

- Five years:
  - Fiber optic products
  - Unshielded Twisted Pair (UTP) transmission products
  - CC3701H-2, CC3701H-2X, CC3751H-2, CC3651H-2X, MC3651H-2, and MC3651H-2X camera models
- Three years:
  - Pelco-designed fixed network cameras and network dome cameras with Sarix™ technology.
  - Pelco-branded fixed camera models (CCC1390H Series, C10DN Series, C10CH Series, and IP3701H Series)
  - EH1500 Series enclosures
  - Spectra® IV products (including Spectra IV IP)
  - Camclosure® Series (IS, ICS, IP) integrated camera systems
  - DX Series digital video recorders (except DX9000 Series which is covered for a period of one year), DVR5100 Series digital video recorders, Digital Sentry® Series hardware products, DVX Series digital video recorders, and NVR300 Series network video recorders
  - Endura® Series distributed network-based video products
  - Genex® Series products (multiplexers, server, and keyboard)
  - PMCL200/300/400 Series LCD monitors
  - PMCL5xx Series FHD monitors
- Two years:
  - Standard varifocal, fixed focal, and motorized zoom lenses
  - DF5/DF8 Series fixed dome products
  - Legacy® Series integrated positioning systems
  - Spectra III™, Spectra Mini, Spectra Mini IP, Esprit®, ExSite®, and PS20 scanners, including when used in continuous motion applications.
  - Esprit Ti and TI2500 Series thermal imaging products
  - Esprit and WW5700 Series window wiper (excluding wiper blades).
  - CM6700/CM6800/CM9700 Series matrix
  - Digital Light Processing (DLP®) displays (except lamp and color wheel). The lamp and color wheel will be covered for a period of 90 days. The air filter is not covered under warranty.
  - Intelli-M® eIDC controllers
- One year:
  - Video cassette recorders (VCRs), except video heads. Video heads will be covered for a period of six months.

- Six months:
  - All pan and tilts, scanners, or preset lenses used in continuous motion applications (preset scan, tour, and auto scan modes).

Pelco will warrant all replacement parts and repairs for 90 days from the date of Pelco shipment. All goods requiring warranty repair shall be sent freight prepaid to a Pelco designated location. Repairs made necessary by reason of misuse, alteration, normal wear, or accident are not covered under this warranty.

Pelco assumes no risk and shall be subject to no liability for damages or loss resulting from the specific use or application made of the Products. Pelco's liability for any claim, whether based on breach of contract, negligence, infringement of any rights of any party or product liability, relating to the Products shall not exceed the price paid by the Dealer to Pelco for such Products. In no event will Pelco be liable for any special, incidental, or consequential damages (including loss of use, loss of profit, and claims of third parties) however caused, whether by the negligence of Pelco or otherwise.

The above warranty provides the Dealer with specific legal rights. The Dealer may also have additional rights, which are subject to variation from state to state.

If a warranty repair is required, the Dealer must contact Pelco at (800) 289-9100 or (559) 292-1981 to obtain a Repair Authorization number (RA), and provide the following information:

1. Model and serial number
2. Date of shipment, P.O. number, sales order number, or Pelco invoice number
3. Details of the defect or problem

If there is a dispute regarding the warranty of a product that does not fall under the warranty conditions stated above, please include a written explanation with the product when returned.

Method of return shipment shall be the same or equal to the method by which the item was received by Pelco.

### RETURNS

To expedite parts returned for repair or credit, please call Pelco at (800) 289-9100 or (559) 292-1981 to obtain an authorization number (CA number if returned for credit, and RA number if returned for repair) and designated return location.

All merchandise returned for credit may be subject to a 20 percent restocking and refurbishing charge.

Goods returned for repair or credit should be clearly identified with the assigned CA or RA number and freight should be prepaid.

2-10-10

 The materials used in the manufacture of this document and its components are compliant to the requirements of Directive 2002/95/EC.



This equipment contains electrical or electronic components that must be recycled properly to comply with Directive 2002/96/EC of the European Union regarding the disposal of waste electrical and electronic equipment (WEEE). Contact your local dealer for procedures for recycling this equipment.

### REVISION HISTORY

Manual #	Date	Comments
C2950M	1/09	Original version.
C2950M-A	5/09	Added periodic refocus and day/night refocus features to the operation section.
C2950M-B	10/09	Added Sarix 1.3 software features to the operation section.
C2950M-C	1/10	Added Sarix 1.4 software features to the operation section.
C2950M-E	8/10	Added Sarix 1.6 software features to the operation section.

Pelco, the Pelco logo, and other trademarks associated with Pelco products referred to in this publication are trademarks of Pelco, Inc. or its affiliates. All other product names and services are the property of their respective companies. Product specifications and availability are subject to change without notice.

© Copyright 2010, Pelco, Inc.  
All rights reserved.

***PELCO***

by **Schneider** Electric

[www.pelco.com](http://www.pelco.com)

Pelco, Inc. Worldwide Headquarters 3500 Pelco Way Clovis, California 93612 USA  
USA & Canada Tel (800) 289-9100 Fax (800) 289-9150  
International Tel +1 (559) 292-1981 Fax +1 (559) 348-1120

## Free Manuals Download Website

<http://myh66.com>

<http://usermanuals.us>

<http://www.somanuals.com>

<http://www.4manuals.cc>

<http://www.manual-lib.com>

<http://www.404manual.com>

<http://www.luxmanual.com>

<http://aubethermostatmanual.com>

Golf course search by state

<http://golfingnear.com>

Email search by domain

<http://emailbydomain.com>

Auto manuals search

<http://auto.somanuals.com>

TV manuals search

<http://tv.somanuals.com>