



Spectra III™ EVS In-Ceiling Back Box





C2494M (12/05)

Important Safety Instructions

1. Read these instructions.
2. Keep these instructions.
3. Heed all warnings.
4. Follow all instructions.
5. Do not use this apparatus near water.
6. Clean only with dry cloth.
7. Do not block any ventilation openings. Install in accordance with the manufacturer's instructions.
8. Do not install near any heat sources such as radiators, heat registers, stoves, or other apparatus (including amplifiers) that produce heat.
9. Only use attachments/accessories specified by the manufacturer.
10. Use only with the cart, stand, tripod, bracket, or table specified by the manufacturer, or sold with the apparatus. When a cart is used, use caution when moving the cart/apparatus combination to avoid injury from tip-over.
11. Refer all servicing to qualified service personnel. Servicing is required when the apparatus has been damaged in any way, such as power-supply cord or plug is damaged, liquid has been spilled or objects have fallen into the apparatus, the apparatus has been exposed to rain or moisture, does not operate normally, or has been dropped.
12. Installation should be done only by qualified personnel and conform to all local codes.
13. Unless the unit is specifically marked as a NEMA Type 3, 3R, 3S, 4, 4X, 6, or 6P enclosure, it is designed for indoor use only and it must not be installed where exposed to rain and moisture.
14. Use only installation methods and materials capable of supporting four times the maximum specified load.
15. Use stainless steel hardware to fasten the mount to outdoor surfaces.
16. To prevent damage from water leakage when installing a mount outdoors on a roof or wall, apply sealant around the bolt holes between the mount and mounting surface.
17. **CAUTION:** These servicing instructions are for use by qualified service personnel only. To reduce the risk of electric shock do not perform any servicing other than that contained in the operating instructions unless you are qualified to do so.
18. Only use replacement parts recommended by Pelco.

The product and/or manual may bear the following marks:

-  This symbol indicates that dangerous voltage constituting a risk of electric shock is present within this unit
-  This symbol indicates that there are important operating and maintenance instructions in the literature accompanying this unit.

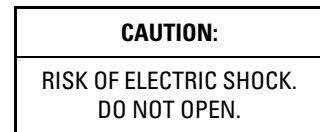

Installation

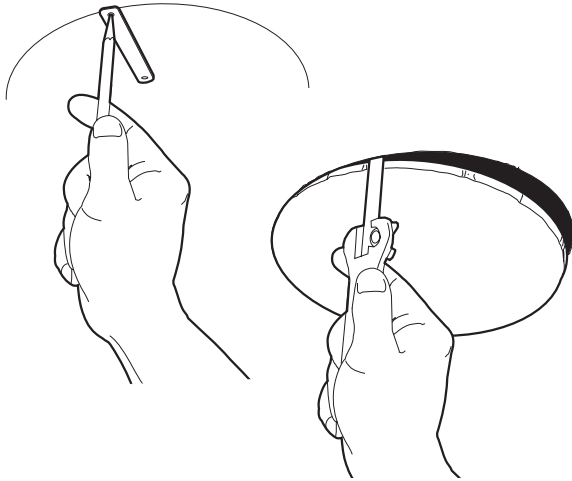

- 1 Locate the center point of the mounting location and insert the compass tool. Draw a circle.
Cut the circle out of the ceiling.

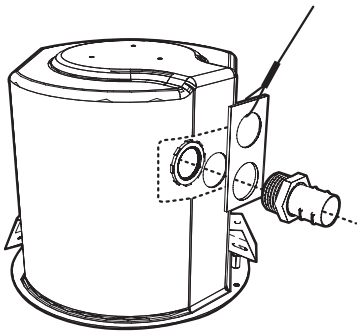

- 2 Attach the conduit fitting, safety chain bracket, and lock nut. Install a safety chain/cable (not supplied) that will support up to 16 pounds (7.3 kg).

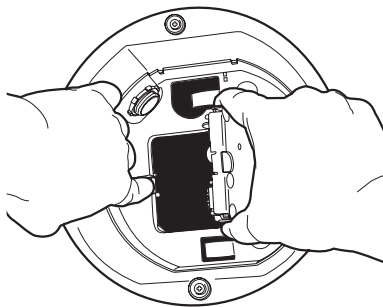

- 3 Open the hinged door to the back box. Push the tab lock towards the wall of the unit and lift the door open. Pull power, alarm/auxiliary, and network cable into the back box.

The following are the recommended maximum distances for 24 VAC applications and are calculated with a 10 percent voltage drop. (Ten percent is generally the maximum allowable voltage drop for AC-powered devices.)

Total VA	20 AWG (0.5 mm ²)	18 AWG (1.0 mm ²)	16 AWG (1.5 mm ²)	14 AWG (2.5 mm ²)
36	79 ft (24 m)	125 ft (38 m)	199 ft (60 m)	316 ft (96 m)

NOTE: Input power for the dome is 24 VAC only. Power consumption is 36 VA per dome. Use a 24 VAC transformer with a minimum of 36 VA per dome.

4 Install the back box by compressing the spring clips and pushing the back box through the hole. Tighten the screws until you hear a clicking noise.

Suspended Ceiling Only: Install the ceiling tile with the back box. Attach a T-rail clip on each side of the ceiling tile to hold the ceiling tile secure during installation of the dome drive and lower dome.

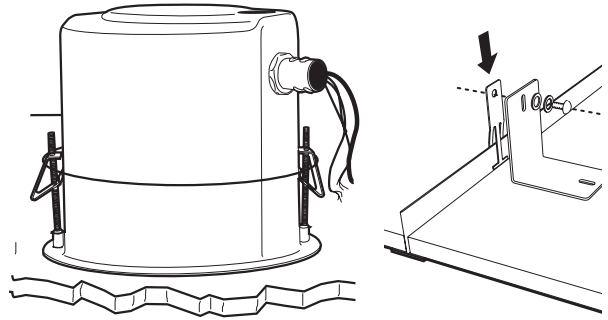

5 Connect the power wires to the circuit board inside the back box. Connect any alarm and auxiliary circuits. Turn on the power to the system. The green LED on the door indicates system power is on.

NOTE: Aux 1 – Maximum 2 A at low voltage (<40 V)

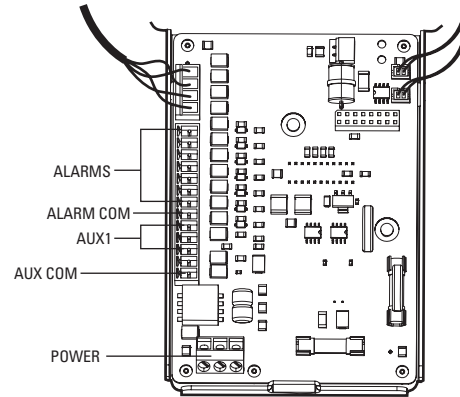

6 Connect a 10/100/1000BaseT network Cat5e (or better) cable to the RJ-45 network connector located inside the back box. Check the LED indicators located inside the back box to check unit status, network status, and network activity.

Unit Status LED

- Green Unit is functioning normally.
- Amber Unit is in configuration mode.
- Red Unit is in an error condition.

Network Status LED

- Off Unit is not connected to the network.
- Amber Unit is connected to a 100BaseT network.
- Red Unit is connected to a 10BaseT network.

Network Activity LED

The LED flashes whenever the unit is sending or receiving network data.

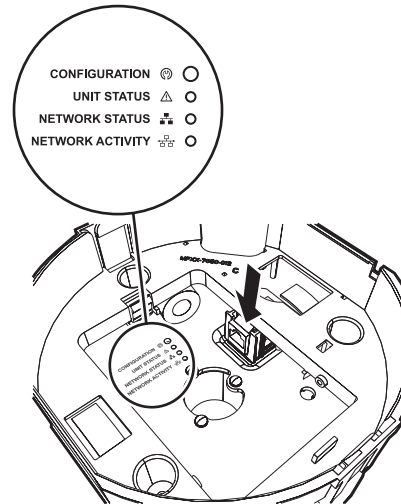

7 No DIP switch settings are required for the system. Before installing the dome drive verify that switch SW1-1 (SW1, switch 1) is set to the ON position and all other switches are set to the OFF position.

The switches set the dome drive for Pelco's D protocol, address 1, 2400 baud, and no termination.

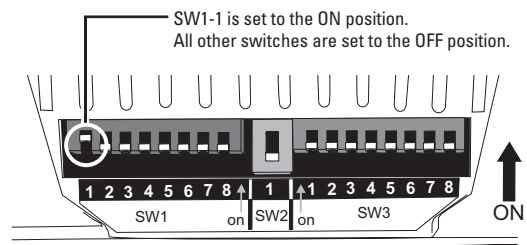

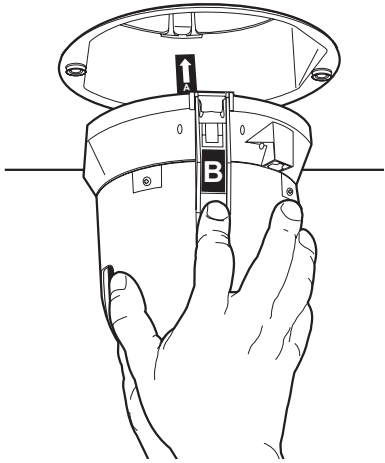

8 Install the dome drive. Line up the blue (A) and red (B) tabs with the blue (A) and red (B) labels. Push in the tabs. Insert one side and then the other side. Continue pushing on the ends of the tabs until both sides click into place.

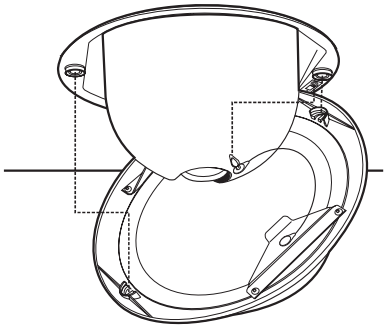

9 Install the lower dome. Snap the clip of the lower trim ring leash into the hole on the lip of the back box. Snap the trim ring into the plastic snap washers on the mounting screws.

To operate or program your Spectra III EVS dome drive, refer to the following manuals:

Information Required	Where to Find Information
Spectra's programmable features, commands, and menu structure	Spectra III Operation/ Programming manual supplied with the dome drive or available at www.pelco.com
How to control the dome drive and access preset 95 with the WS5050	Endura™ WS5000 Advanced System Software Operation manual supplied with the WS5050 workstation or available at www.pelco.com
How to control the dome drive and access preset 95 with the VCD5000	Endura VCD5000 Video Control Display Operation manual supplied with the VCD5000 or available at www.pelco.com

Specifications

SYSTEM

Processor	PowerPC® 405EP
Operating System	Linux®
User Interface	Remote operation via WS5050 or VCD5000

ELECTRICAL

Input Voltage	18-30 VAC; 24 VAC nominal
Input Power	36 VA nominal (without heaters) 88 VA nominal (with heaters)
Fuse	1.25 A
Auxiliary Outputs	1
Alarm Inputs	7

VIDEO

Video Standards	NTSC/PAL/EIA/CCIR composite	
Video Coding	MPEG-4	
Video Streams	2, simultaneous	
Video Resolutions	NTSC	PAL
4CIF	704 x 480	704 x 576
2CIF	704 x 240	704 x 288
CIF	352 x 240	352 x 288
QCIF	176 x 120	176 x 144
Video Inputs/Connectors	2, BNC, looping, 75 $\frac{3}{4}$, 1 Vp-p	
Video Switch	Hi-Z, 75 $\frac{3}{4}$	

VIDEO ACTIVITY DETECTION

Zones	3 plus background zone
Zone Types	Any shape, user-definable in 16 x 16 pixel blocks
Sensitivity	Adjustable

GENERAL

Construction		
Back Box	Aluminum	
Dome Drive	Aluminum, thermo plastic	
Bubble	Acrylic	
Light Attenuation		
Smoked	1/2 F-stop light loss	
Clear	Zero light loss	
Chrome and Gold	2 F-stops light loss	
Cable Entry (Back Box)	0.75-inch (1.91 cm) conduit fitting	
Weight (approximate)	Unit	Shipping
Back Box	2.8 lb (1.27 kg)	4 lb (1.81 kg)
Dome Drive	2.4 lb (1.09 kg)	4 lb (1.81 kg)
Lower Dome	0.2 lb (0.09 kg)	1 lb (0.45 kg)
Environment	Indoor	
Operating Temperature	32° to 122°F (0° to 50°C)	
Effective Projected Area (EPA)	92 square inches (without mount); 138 square inches (with IWM Series mount)	

IN-CEILING

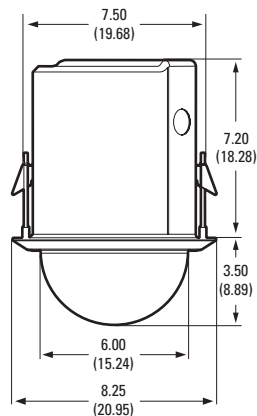

NOTE: VALUES IN PARENTHESES ARE CENTIMETERS; ALL OTHERS ARE INCHES.

PRODUCT WARRANTY AND RETURN INFORMATION

WARRANTY

Pelco will repair or replace, without charge, any merchandise proved defective in material or workmanship **for a period of one year** after the date of shipment.

Exceptions to this warranty are as noted below:

- Five years on FR/FT/FS Series fiber optic products and TW3000 Series unshielded twisted pair transmission products.
- Three years on Genex® Series products (multiplexers, server, and keyboard).
- Three years on Camclosure® and fixed camera models, except the CC3701H-2, CC3701H-2X, CC3751H-2, CC3651H-2X, MC3651H-2, and MC3651H-2X camera models, which have a five-year warranty.
- Three years on PMCL200/300/400 Series LCD monitors.
- Two years on standard motorized or fixed focal length lenses.
- Two years on Legacy®, CM6700/CM6800/CM9700 Series matrix, and DF5/DF8 Series fixed dome products.
- Two years on Spectra®, Esprit®, ExSite™, and PS20 scanners, including when used in continuous motion applications.
- Two years on Esprit and WW5700 Series window wiper (excluding wiper blades).
- Two years (except lamp and color wheel) on Digital Light Processing (DLP®) displays. The lamp and color wheel will be covered for a period of 90 days. The air filter is not covered under warranty.
- Eighteen months on DX Series digital video recorders, NVR300 Series network video recorders, and Endura™ Series distributed network-based video products.
- One year (except video heads) on video cassette recorders (VCRs). Video heads will be covered for a period of six months.
- Six months on all pan and tilts, scanners or preset lenses used in continuous motion applications (that is, preset scan, tour and auto scan modes).

Pelco will warrant all replacement parts and repairs for 90 days from the date of Pelco shipment. All goods requiring warranty repair shall be sent freight prepaid to Pelco, Clovis, California. Repairs made necessary by reason of misuse, alteration, normal wear, or accident are not covered under this warranty.

Pelco assumes no risk and shall be subject to no liability for damages or loss resulting from the specific use or application made of the Products. Pelco's liability for any claim, whether based on breach of contract, negligence, infringement of any rights of any party or product liability, relating to the Products shall not exceed the price paid by the Dealer to Pelco for such Products. In no event will Pelco be liable for any special, incidental or consequential damages (including loss of use, loss of profit and claims of third parties) however caused, whether by the negligence of Pelco or otherwise.

The above warranty provides the Dealer with specific legal rights. The Dealer may also have additional rights, which are subject to variation from state to state.

If a warranty repair is required, the Dealer must contact Pelco at (800)289-9100 or (559) 292-1981 to obtain a Repair Authorization number (RA), and provide the following information:

1. Model and serial number
2. Date of shipment, P.O. number, Sales Order number, or Pelco invoice number
3. Details of the defect or problem

If there is a dispute regarding the warranty of a product which does not fall under the warranty conditions stated above, please include a written explanation with the product when returned.

Method of return shipment shall be the same or equal to the method by which the item was received by Pelco.

RETURNS

In order to expedite parts returned to the factory for repair or credit, please call the factory at (800) 289-9100 or (559) 292-1981 to obtain an authorization number (CA number if returned for credit, and RA number if returned for repair).

All merchandise returned for credit may be subject to a 20% restocking and refurbishing charge.

Goods returned for repair or credit should be clearly identified with the assigned CA or RA number and freight should be prepaid. Ship to the appropriate address below.

If you are located within the continental U.S., Alaska, Hawaii or Puerto Rico, send goods to:

Service Department
Pelco
3500 Pelco Way
Clovis, CA 93612-5699

If you are located outside the continental U.S., Alaska, Hawaii or Puerto Rico and are instructed to return goods to the USA, you may do one of the following:

If the goods are to be sent by a COURIER SERVICE, send the goods to:

Pelco
3500 Pelco Way
Clovis, CA 93612-5699 USA

If the goods are to be sent by a FREIGHT FORWARDER, send the goods to:

Pelco c/o Expeditors
473 Eccles Avenue
South San Francisco, CA 94080 USA
Phone: 650-737-1700
Fax: 650-737-0933

 Green The materials used in the manufacture of this document and its components are compliant to the requirements of Directive 2002/95/EC.



This equipment contains electrical or electronic components that must be recycled properly to comply with Directive 2002/96/EC of the European Union regarding the disposal of waste electrical and electronic equipment (WEEE). Contact your local dealer for procedures for recycling this equipment.

REVISION HISTORY

Manual #	Date	Comments
C2494M	12/05	Original version.

Pelco, the Pelco logo, Camclosure, Esprit, Genex, Legacy, and Spectra are registered trademarks of Pelco.
Endura and ExSite are trademarks of Pelco.
DLP is a registered trademark of Texas Instruments, Inc.

©Copyright 2005, Pelco. All rights reserved.



Worldwide Headquarters
3500 Pelco Way
Clovis, California 93612 USA

USA & Canada
Tel: 800/289-9100
Fax: 800/289-9150

International
Tel: 1-559/292-1981
Fax: 1-559/348-1120

www.pelco.com

ISO9001

Australia | Canada | Finland | France | Italy | Russia | Singapore | Spain | Sweden | The Netherlands | United Arab Emirates | United Kingdom | United States

Free Manuals Download Website

<http://myh66.com>

<http://usermanuals.us>

<http://www.somanuals.com>

<http://www.4manuals.cc>

<http://www.manual-lib.com>

<http://www.404manual.com>

<http://www.luxmanual.com>

<http://aubethermostatmanual.com>

Golf course search by state

<http://golfingnear.com>

Email search by domain

<http://emailbydomain.com>

Auto manuals search

<http://auto.somanuals.com>

TV manuals search

<http://tv.somanuals.com>