

**PMC14E Series High-Resolution  
14-Inch Color Monitors**

**Installation/Operation Manual**

**C929M-B (2/97)**

Pelco • 3500 Pelco Way, Clovis, CA 93612-5699 • USA • (800) 289-9100 or (1-559) 292-1981  
FAX (800) 289-9150 or (1-559) 292-3827  
International customers call 1-559-292-1981 or FAX 1-559-348-1120

---

---

# CONTENTS

---

---

<b>Section</b>	<b>Page</b>
1.0 GENERAL .....	1
1.1 IMPORTANT SAFEGUARDS AND WARNINGS .....	1
2.0 DESCRIPTION .....	4
2.1 MODELS .....	4
2.2 OPTIONAL ACCESSORIES .....	4
3.0 INSTALLATION .....	5
3.1 BACK PANEL CONNECTIONS .....	5
3.2 FRONT PANEL CONTROLS .....	9
4.0 OPERATION .....	10
4.1 PASSIVE LOOPING .....	10
5.0 MAINTENANCE .....	11
6.0 SPECIFICATIONS .....	12
7.0 WARRANTY AND RETURN .....	14

## LIST OF ILLUSTRATIONS

<b>Figure</b>	<b>Page</b>
1 Rear Panel Connectors .....	4
2 Camera Inputs .....	5
3 Input from Switcher or Matrix Control System .....	6
4 Dedicated Monitor Application with Pan/Tilt/Zoom Control .....	6
5 Dedicated Monitor Application with No Control .....	7
6 Output Connections .....	7
7 VTR Connections .....	8
8 Front Panel Controls .....	9

## LIST OF TABLES

<b>Table</b>	<b>Page</b>
A Video Coaxial Cable Wiring Distances .....	5

## REVISION HISTORY

<u>Manual #</u>	<u>Date</u>	<u>Comments</u>
C929M	12/95	Original version.
C929M-A	6/96	Added second paragraph to item 10 in Section 1.1.
C929M-B	2/97	New part number PMC14EX created for PAL models per ECO 96-367. Completely revised manual. Deleted second paragraph of item 10 in Section 1.1.

---

---

## 1.0 GENERAL

---

---

### 1.1 IMPORTANT SAFEGUARDS AND WARNINGS

Prior to installation and use of this product, the following WARNINGS should be observed.

1. Installation and servicing should only be done by Qualified Service Personnel and conform to all Local codes.
2. Unless the unit is specifically marked as a NEMA Type 3, 3R, 3S, 4, 4X, 6 or 6P enclosure, it is designed for Indoor use only and it must not be installed where exposed to rain and moisture.
4. Only use replacement parts recommended by Pelco.
5. After replacement/repair of this unit's electrical components, conduct a resistance measurement between line and exposed parts to verify the exposed parts have not been connected to line circuitry.

#### The product may bear the following marks:



This symbol indicates that dangerous voltage constituting a risk of electric shock is present within this unit.



This symbol indicates that there are important operating and maintenance instructions in the literature accompanying this unit.

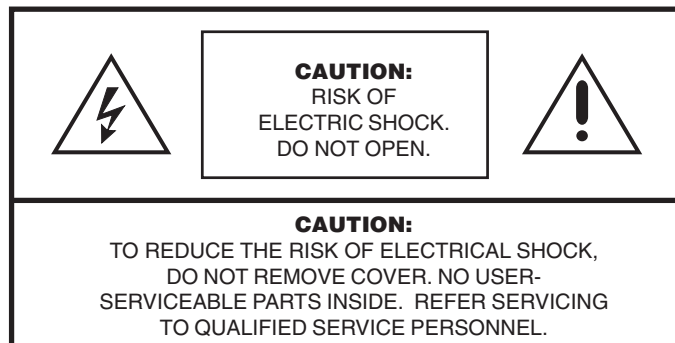

**Please thoroughly familiarize yourself with the information in this manual prior to installation and operation.**

## 1.1 IMPORTANT SAFEGUARDS

1. Read Instructions - All the safety and operating instructions should be read before the unit is operated.
2. Retain Instructions - The safety and operating instructions should be retained for future reference.
3. Heed Warnings - All warnings on the unit and in the operating instructions should be adhered to.
4. Follow Instructions - All operating and use instructions should be followed.
5. Cleaning - Unplug the unit from the outlet before cleaning. Do not use liquid cleaners or aerosol cleaners. Use a damp cloth for cleaning.
6. Attachments - Do not use attachments not recommended by the product manufacturer as they may cause hazards.
7. Water and Moisture - Do not use this unit near water - for example, near a bath tub, wash bowl, kitchen sink, or laundry tub, in a wet basement, near a swimming pool, in an unprotected outdoor installation, or any area which is classified as a wet location.
8. Accessories - Do not place this unit on an unstable stand, tripod, bracket, or mount. The unit may fall, causing serious injury to a person and serious damage to the unit. Use only with a stand, tripod, bracket, or mount recommended by the manufacturer, or sold with the product. Any mounting of the unit should follow the manufacturer's instructions, and should use a mounting accessory recommended by the manufacturer.

An appliance and cart combination should be moved with care. Quick stops, excessive force, and uneven surfaces may cause the appliance and cart combination to overturn.

9. Ventilation - Openings in the enclosure, if any, are provided for ventilation and to ensure reliable operation of the unit and to protect it from overheating. These openings must not be blocked or covered. This unit should not be placed in a built-in installation unless proper ventilation is provided or the manufacturer's instructions have been adhered to.
10. Power Sources - This unit should be operated only from the type of power source indicated on the marking label. If you are not sure of the type of power supply you plan to use, consult your appliance dealer or local power company. For units intended to operate from battery power, or other sources, refer to the operating instructions.
11. Grounding or Polarization - This unit may be equipped with a polarized alternating-current line plug (a plug having one blade wider than the other). This plug will fit into the power outlet only one way. This is a safety feature. If you are unable to insert the plug fully into the outlet, try reversing the plug. If the plug should still fail to fit, contact your electrician to replace your obsolete outlet. Do not defeat the safety purpose of the polarized plug.

Alternately, this unit may be equipped with a 3-wire grounding-type plug, a plug having a third (grounding) pin. This plug will only fit into a grounding-type power outlet. This is a safety feature. If you are unable to insert the plug into the outlet, contact your electrician to replace your obsolete outlet. Do not defeat the safety purpose of the grounding-type plug.

12. Power-Cord Protection - Power supply cords should be routed so that they are not likely to be walked on or pinched by items placed upon or against them, paying particular attention to cords and plugs, convenience receptacles, and the point where they exit from the appliance.

13. Power Lines - An outdoor system should not be located in the vicinity of overhead power lines or other electric light or power circuits, or where it can fall into such power lines or circuits. When installing an outdoor system, extreme care should be taken to keep from touching such power lines or circuits as contact with them might be fatal. U.S.A. models only - refer to the National Electrical Code Article 820 regarding installation of CATV systems.
14. Overloading - Do not overload outlets and extension cords as this can result in a risk of fire or electric shock.
15. Object and Liquid Entry - Never push objects of any kind into this unit through openings as they may touch dangerous voltage points or short-out parts that could result in a fire or electric shock. Never spill liquid of any kind on the unit.
16. Servicing - Do not attempt to service this unit yourself as opening or removing covers may expose you to dangerous voltage or other hazards. Refer all servicing to qualified service personnel.
17. Damage Requiring Service - Unplug the unit from the outlet and refer servicing to qualified service personnel under the following conditions:
  - a. When the power-supply cord or plug is damaged.
  - b. If liquid has been spilled, or objects have fallen into the unit.
  - c. If the unit has been exposed to rain or water.
  - d. If the unit does not operate normally by following the operating instructions. Adjust only those controls that are covered by the operating instructions, as an improper adjustment of other controls may result in damage and will often require extensive work by a qualified technician to restore the unit to its normal operation.
  - e. If the unit has been dropped or the cabinet has been damaged.
  - f. When the unit exhibits a distinct change in performance - this indicates a need for service.
18. Replacement Parts - When replacement parts are required, be sure the service technician has used replacement parts specified by the manufacturer or have the same characteristics as the original part. Unauthorized substitutions may result in fire, electric shock or other hazards.
19. Safety Check - Upon completion of any service or repairs to this unit, ask the service technician to perform safety checks to determine that the unit is in proper operating condition.
20. Coax Grounding - If an outside cable system is connected to the unit, be sure the cable system is grounded. U.S.A. models only-Section 810 of the National Electrical Code, ANSI/NFPA No.70-1981, provides information with respect to proper grounding of the mount and supporting structure, grounding of the coax to a discharge unit, size of grounding conductors, location of discharge unit, connection to grounding electrodes, and requirements for the grounding electrode.
21. Lightning - For added protection of this unit during a lightning storm, or when it is left unattended and unused for long periods of time, unplug it from the wall outlet and disconnect the cable system. This will prevent damage to the unit due to lightning and power-line surges.

## 2.0 DESCRIPTION

The PMC14E Series provides 14-inch (36 cm), color, high-resolution monitors.

### Monitor Features

- Two video and audio input channels (one passive) with looping output. Video inputs include connectors for either a standard composite video signal or Y/C (Super VHS) signal.
- Manual or automatic switching between channels with adjustable dwell time
- Video tape recorder input and output
- High resolution 480 lines
- Comb filter for improved picture quality
- 120 VAC or 230 VAC operation
- NTSC or PAL video format
- Controls for contrast, brightness, color, sharpness, tint, dwell time, channel selection, volume, and power
- Steel cabinet
-  Manufactured in accordance with EMC Directive, 89/336/EEC

### 2.1 MODELS

PMC14E	14-inch color monitor, 120 VAC, NTSC format
PMC14EX	14-inch color monitor, 230 VAC, PAL format

### 2.2 OPTIONAL ACCESSORIES

RMA14E-BK	Rack-mount kit for mounting one monitor in a 19-inch (48.26 cm) wide rack. Black finish.
RMA14E-GY	Same as RMA14E-BK except gray.

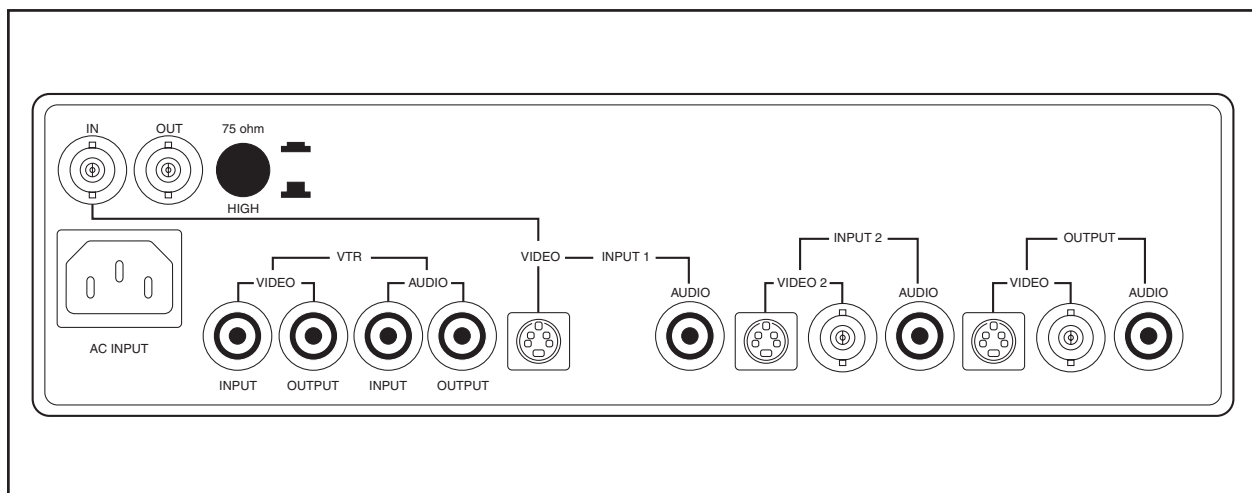

Figure 1. Rear Panel Connectors

# 3.0 INSTALLATION

## 3.1 BACK PANEL CONNECTIONS



**CAUTION:** Do not install this monitor in an excessively hot location, or in any way obstruct the ventilation openings in the cabinet. Premature component failure or damage to the cabinet may result.

**NOTE:** Do not connect equipment to both the BNC and Y/C connectors on the same input. If the monitor senses a signal at both connectors, the Y/C input will be selected.

Refer to Table A for the type of video coaxial cable to use.

Refer to Figure 1 for rear panel connections.

Connect equipment to the monitor as follows. There are several options for inputs 1 and 2 as shown on this and the following pages. Select the appropriate one.

**Table A.** Video Coaxial Cable Wiring Distances

Cable Type	Maximum Distance
RG59	750 ft (229 m)
RG6	1,000 ft (305 m)
RG11	1,500 ft (457 m)

### Inputs 1 and 2 (Camera Inputs)

1. Refer to Figure 2. Connect cameras and audio equipment to the inputs 1 and/ or 2. Note that each input has two video connectors: a BNC connector for a standard composite video signal and a four-pin jack for a Y/C signal input. The Y/C input provides luminance (Y) and chrominance (C) signal input from Super VHS equipment.
2. Set the 75-ohm/HIGH switch for 75 ohms if you are using Input 1.

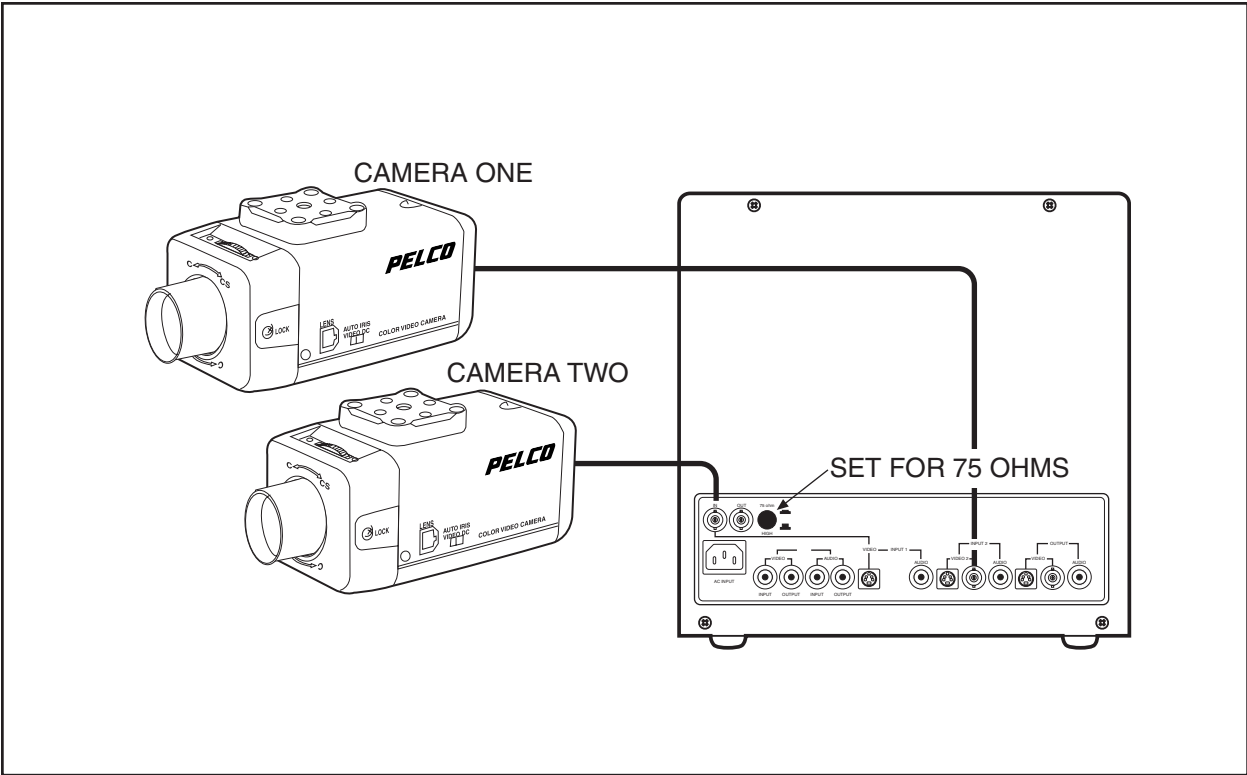

**Figure 2.** Camera Inputs

**Input 1 or 2 (Input from Switcher or Matrix Control System - Video Only)**

1. Refer to Figure 3. Connect the video output from the video switcher or matrix control equipment to Input 1 or Input 2 on the output monitor.
2. Set the 75-ohm/HIGH switch for 75 ohms if you are using Input 1.

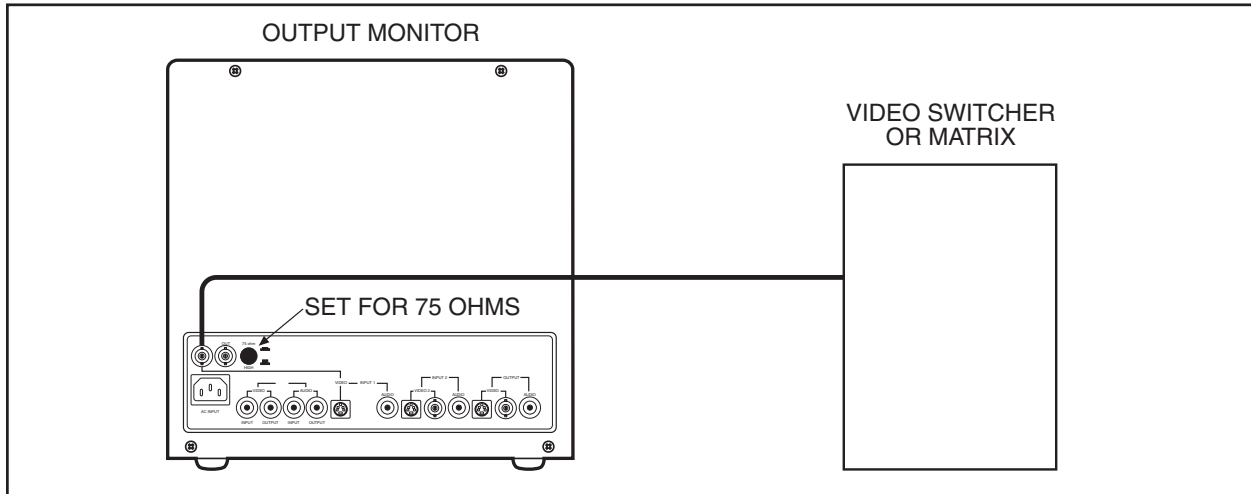
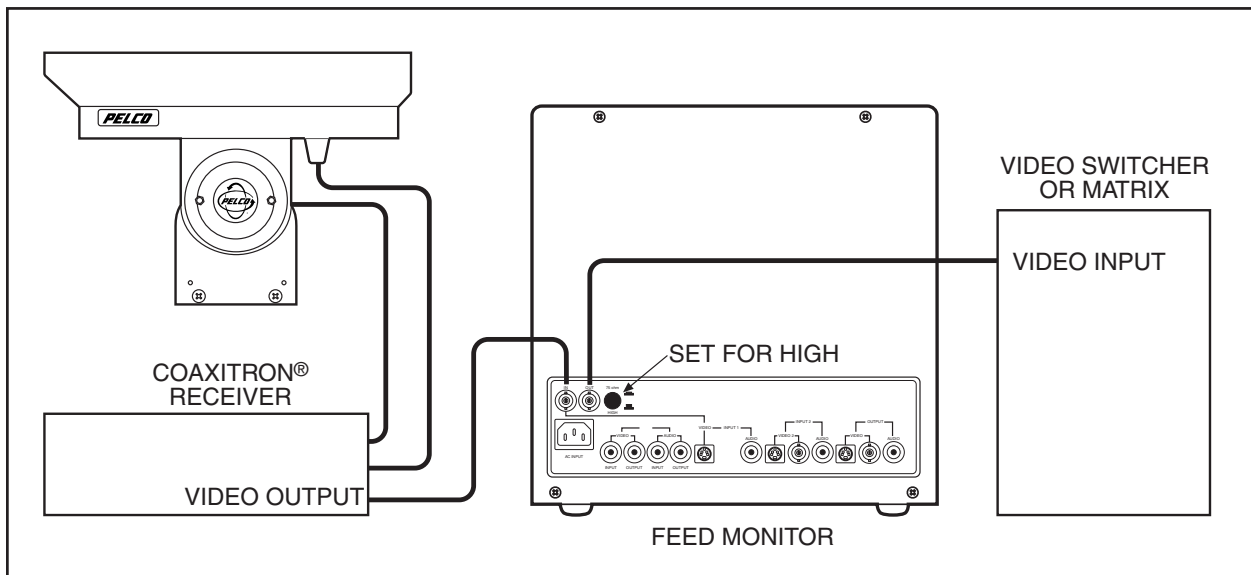

**Figure 3.** Input from Switcher or Matrix Control System

**Input 1 (Dedicated Monitor Application - Video Only with Pan/Tilt/Zoom Control)**

Refer to Figure 4. This configuration allows you to use Pelco's Coaxitron® control system to operate pan, tilt, and zoom functions. The control signals are transmitted over the video coax cable.

1. Connect the video cable from the Coaxitron® receiver to the IN connector of Input 1 on the feed monitor. Connect another video cable from the OUT connector of the feed monitor to the video switcher or matrix control equipment.
2. Set the 75-ohm/HIGH switch for HIGH.

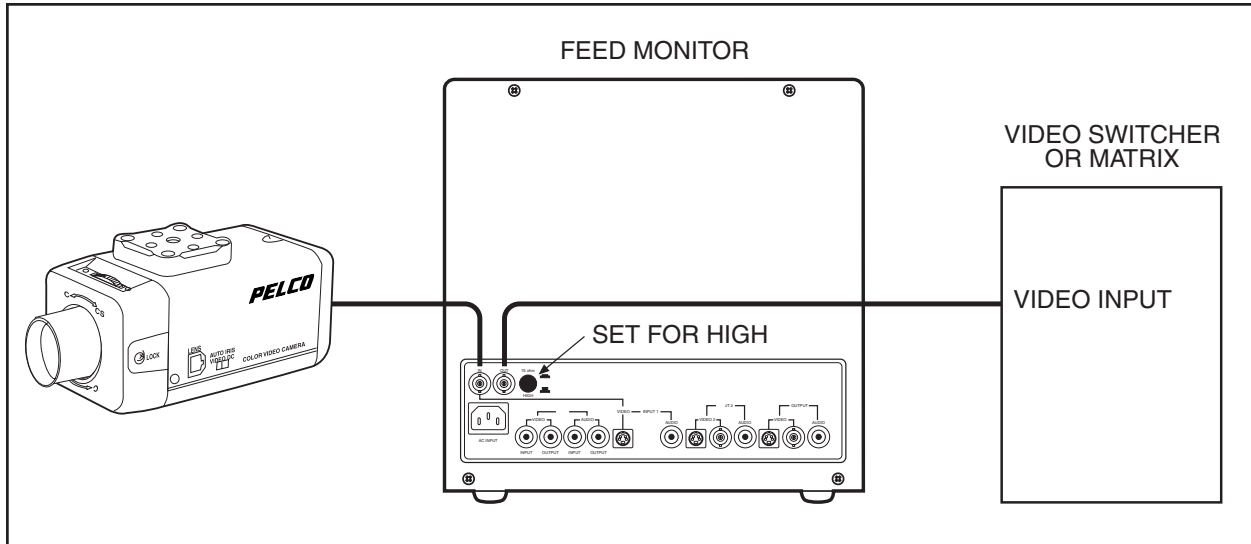

**Figure 4.** Dedicated Monitor Application with Pan/Tilt/Zoom Control



**Input 1 (Dedicated Monitor Application - Video Only, No Camera Control)**

1. Refer to Figure 5. Connect the video cable from the camera to the IN connector of Input 1 on the feed monitor. Connect another video cable from the OUT connector of the feed monitor to the video switcher or matrix equipment.
2. Set the 75-ohm/HIGH switch for HIGH.



**Figure 5.** Dedicated Monitor Application with No Control

**Output Connections**

Refer to Figure 6. To loop the video and audio signals from the monitor to another monitor, connect cables from the OUTPUT connectors of the monitor to the INPUT 1 or INPUT 2 connectors of the next monitor.

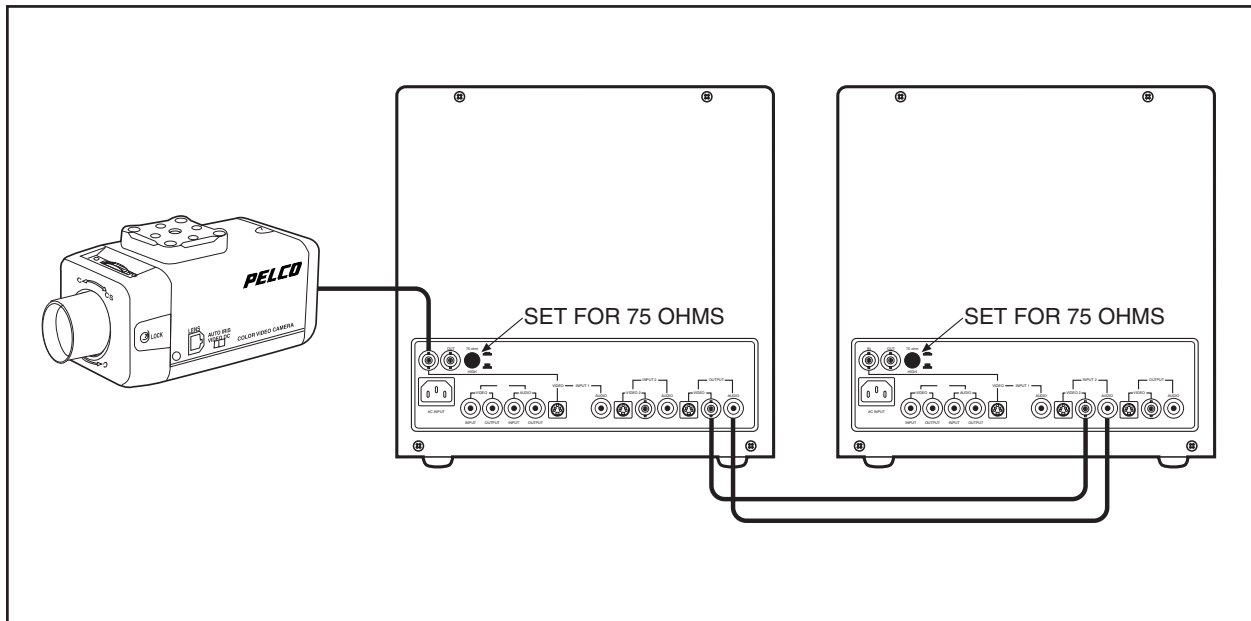

**Figure 6.** Output Connections

### VTR Connections

Refer to Figure 7. Connect the video and audio connections from the monitor to a video recorder if desired.

### Power

Plug the appropriate end of the power cable into the AC INPUT on the monitor. Plug the other end into a utility outlet.

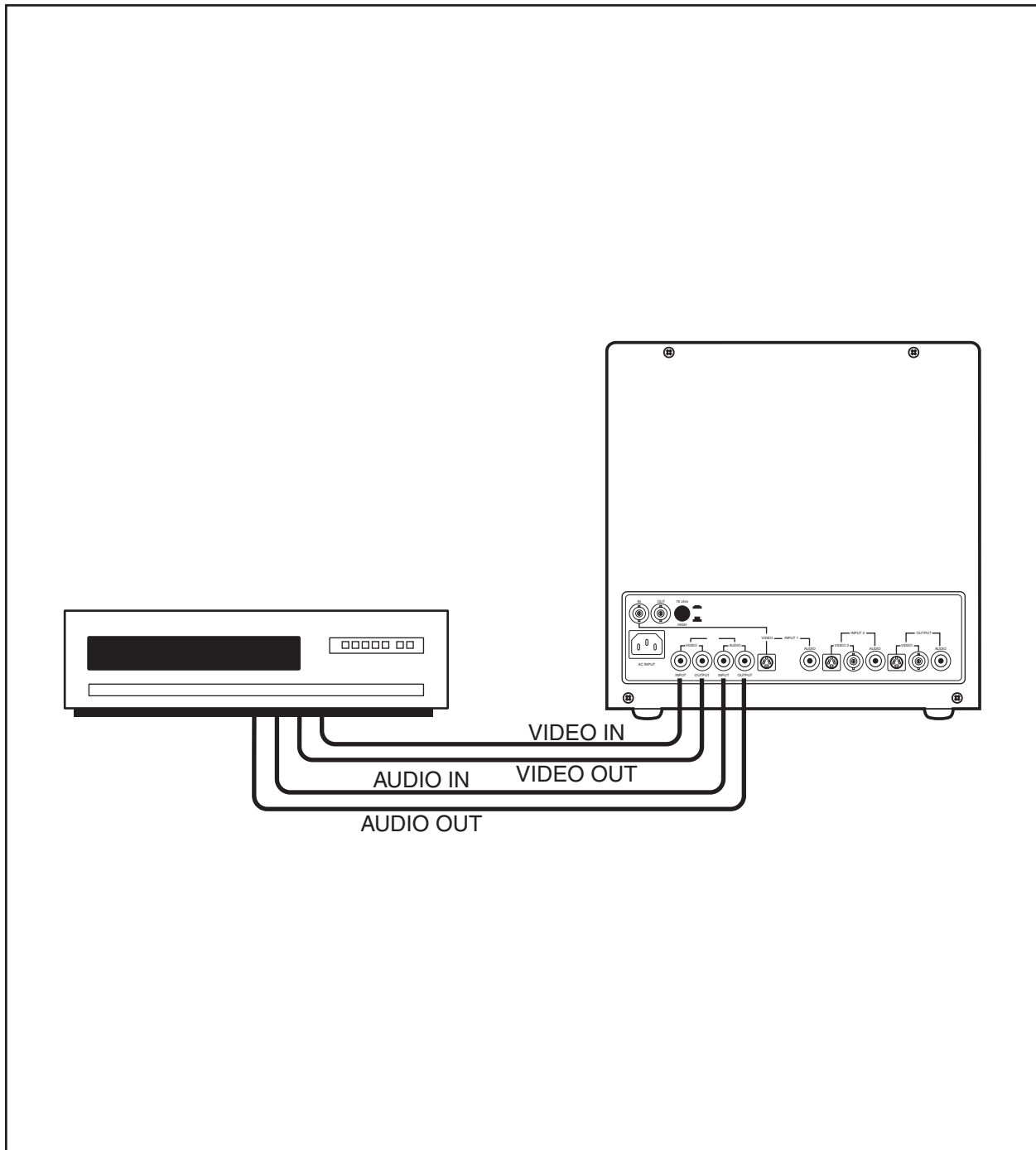

Figure 7. VTR Connections

### 3.2 FRONT PANEL CONTROLS

Refer to Figure 8. Set the controls on the front panel of the monitor as follows:

1. Set the PAL/NTSC switch for NTSC video format if you have a PMC14E monitor. Set the switch for PAL video format if you have a PMC14EX monitor.
2. Set the VTR/VIDEO switch for the signal input that you are using.
  - Select VTR if you want to play a VCR that is connected to the VTR terminals on the back of the monitor.
  - Select VIDEO if you want video and audio from equipment that is connected to inputs 1 and/or 2 on the back of the monitor.
3. If you selected VTR signal input in step 2, the VIDEO 1/VIDEO 2 and AUTO/MANUAL switches are non-functional.

If you selected VIDEO signal input in step 2, set the AUTO/MANUAL switch to MANUAL if you are using only one input (input 1 or input 2). Then set the VIDEO 1/VIDEO 2 switch for the input that you are using.

If you are using inputs 1 and 2, set the AUTO/MANUAL switch to MANUAL if you want to switch between the inputs manually using the VIDEO 1/VIDEO 2 switch.

If you are using inputs 1 and 2, set the AUTO/MANUAL switch to AUTO if you want the monitor to switch back and forth automatically between the two inputs. If you select AUTO, the VIDEO 1/VIDEO 2 switch is non-functional. You will set the dwell time for switching between the inputs in step 9.

4. Turn on the power. The LED next to the power switch will light. After about 10 seconds, a picture will appear on the monitor.
5. Adjust the BRIGHTNESS and CONTRAST controls to obtain optimum picture quality.
6. Adjust the COLOR and TINT controls for desired picture color.
7. Adjust the SHARPNESS control to obtain optimum picture quality.
8. Adjust the VOLUME control for an appropriate audio volume.
9. Adjust the TIME control to obtain the desired dwell time for automatically switching back and forth between inputs 1 and 2. This function only operates if the AUTO/MANUAL switch is in the AUTO position.

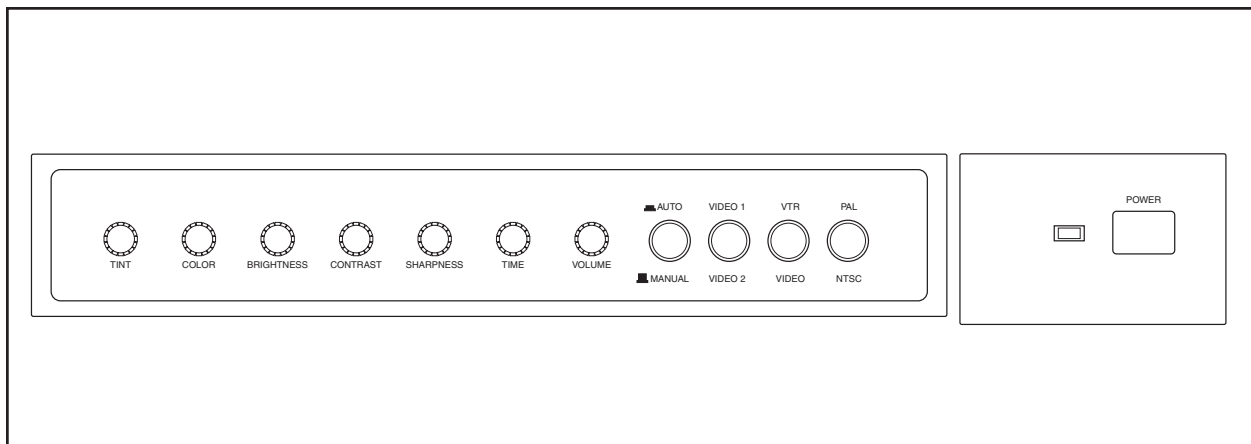

Figure 8. Front Panel Controls

---

---

## 4.0 OPERATION

---

---

There are two sources of video and audio input:

- VTR (video tape recorder)
- Video 1 and Video 2

Only one source can be selected at a time.

To select the input from a video recorder, set the VTR/VIDEO switch on the front panel in the VTR position. In this position, the video and audio signals are sent to the monitor and through the OUTPUT connectors to any equipment connected to them.

To select the input from Video 1 and/or Video 2:

1. Set the VTR/VIDEO switch on the front panel in the VIDEO position.
2. Set the AUTO/MANUAL switch to MANUAL if you are using only one input (input 1 or input 2). Then set the VIDEO 1/VIDEO 2 switch for the input that you are using.

If you are using inputs 1 and 2, set the AUTO/MANUAL switch to MANUAL if you want to switch between the inputs manually using the VIDEO 1/VIDEO 2 switch.

If you are using inputs 1 and 2, set the AUTO/MANUAL switch to AUTO if you want the monitor to switch back and forth automatically between the two inputs. The VIDEO 1/VIDEO 2 switch is non-functional. Adjust the dwell time for switching between inputs 1 and 2 with the TIME knob.

When the VTR/VIDEO switch is in the VIDEO position, the video and audio signals are sent to the monitor and through the OUTPUT connectors to any equipment connected to them. The signals are also transmitted to the VTR output jacks for recording.

### 4.1 PASSIVE LOOPING

If you are using Input 1 and are looping the signal through the IN and OUT connectors (passive looping) (refer to Figures 4 and 5), the monitor does not have to be turned on unless you want to watch the monitor.

---

---

## 5.0 MAINTENANCE

---

---

To reduce the risk of electric shock, do not remove the cover or back. No user-serviceable parts are inside. Refer servicing to qualified personnel.

Some household aerosol sprays, cleaning agents, solvents, or polishes may damage the cabinet finish. Clean the cabinet with water and mild soap. Use a soft cloth for drying.

If the quality of the picture on the monitor is poor and cannot be improved, inspect all system connections and cable runs.

---

---

## 6.0 SPECIFICATIONS

---

---

### **ELECTRICAL**

#### Input Power

PMC14E	120 VAC, 60 Hz
PMC14EX	230 VAC, 50 Hz

#### Power Consumption

PMC14E	65 W
PMC14EX	70 W

#### System

PMC14E	NTSC (525 lines, 60 fields per second)
PMC14EX	PAL (625 lines, 50 fields per second)

Picture Tube: 14 inches (36 cm) measured diagonally

#### Effective Picture Size

Height:	8.27 inches (21.0 cm)
Width:	11.0 inches (28.0 cm)

Input Signal: Composite video, negative synch  
-Y: 1.0 Vp-p  
-C: 0.286 Vp-p

#### Subcarrier Frequency

#### Synch Range at Room

Temperature:	3.579549 MHz +/-200 Hz
	4.433619 MHz +/-200 Hz

High Voltage: 23.5KV +/-500V

#### Convergence

At center of picture:	Less than 1.0 mm
At corners of picture:	Less than 1.4 mm

#### Horizontal Resolution

Center:	480 lines
Corners:	380 lines

Brightness: More than 250 lux in 100% white signal picture at center

**GENERAL**

Dimensions:	13.8" W x 12.4" H x 14.6" D (35 x 31.5 x 37.1 cm)
Finish:	Steel cabinet painted dark gray. Black bezel around the screen.
Operating Temperature:	32° to 104° F (0° to 40° C)
Humidity:	0% to 90% (non-condensing)
Connectors	
Video Input, Output:	BNC
Y/C Input, Output:	4-pin mini-Din
Audio Input, Output:	RCA
VTR Input, Output:	RCA
Power Cord:	
PMC14E	3-wire power cord with grounded plug
PMC14EX	"Euro" style grounded power cord
Weight	
Shipping:	31.74 lbs (14.4 kg)

---

---

## 7.0 WARRANTY AND RETURN INFORMATION

---

---

### WARRANTY

Pelco will repair or replace, without charge, any merchandise proved defective in material or workmanship for a period of one year after the date of shipment.

Exceptions to this warranty are as noted below:

- Five years on FT/FR8000 Series fiber optic products.
- Three years on Genex® Series products (multiplexers, server, and keyboard).
- Three years on Camclosure® and fixed camera models, except the CC3701H-2, CC3701H-2X, CC3751H-2, CC3651H-2X, MC3651H-2, and MC3651H-2X camera models, which have a five-year warranty.
- Two years on standard motorized or fixed focal length lenses.
- Two years on Legacy®, CM6700/CM6800/CM9700 Series matrix, and DF5/DF8 Series fixed dome products.
- Two years on Spectra®, Esprit®, ExSite™, and PS20 scanners, including when used in continuous motion applications.
- Two years on Esprit® and WW5700 Series window wiper (excluding wiper blades).
- Eighteen months on DX Series digital video recorders, NVR300 Series network video recorders, and Endura™ Series distributed network-based video products.
- One year (except video heads) on video cassette recorders (VCRs). Video heads will be covered for a period of six months.
- Six months on all pan and tilts, scanners or preset lenses used in continuous motion applications (that is, preset scan, tour and auto scan modes).

Pelco will warrant all replacement parts and repairs for 90 days from the date of Pelco shipment. All goods requiring warranty repair shall be sent freight prepaid to Pelco, Clovis, California. Repairs made necessary by reason of misuse, alteration, normal wear, or accident are not covered under this warranty.

Pelco assumes no risk and shall be subject to no liability for damages or loss resulting from the specific use or application made of the Products. Pelco's liability for any claim, whether based on breach of contract, negligence, infringement of any rights of any party or product liability, relating to the Products shall not exceed the price paid by the Dealer to Pelco for such Products. In no event will Pelco be liable for any special, incidental or consequential damages (including loss of use, loss of profit and claims of third parties) however caused, whether by the negligence of Pelco or otherwise.

The above warranty provides the Dealer with specific legal rights. The Dealer may also have additional rights, which are subject to variation from state to state.

If a warranty repair is required, the Dealer must contact Pelco at (800) 289-9100 or (559) 292-1981 to obtain a Repair Authorization number (RA), and provide the following information:

1. Model and serial number
2. Date of shipment, P.O. number, Sales Order number, or Pelco invoice number
3. Details of the defect or problem

If there is a dispute regarding the warranty of a product which does not fall under the warranty conditions stated above, please include a written explanation with the product when returned.

Method of return shipment shall be the same or equal to the method by which the item was received by Pelco.

### RETURNS

In order to expedite parts returned to the factory for repair or credit, please call the factory at (800) 289-9100 or (559) 292-1981 to obtain an authorization number (CA number if returned for credit, and RA number if returned for repair).

All merchandise returned for credit may be subject to a 20% restocking and refurbishing charge. Goods returned for repair or credit should be clearly identified with the assigned CA or RA number and freight should be prepaid. Ship to the appropriate address below.

If you are located within the continental U.S., Alaska, Hawaii or Puerto Rico, send goods to:

Service Department  
Pelco  
3500 Pelco Way  
Clovis, CA 93612-5699

If you are located outside the continental U.S., Alaska, Hawaii or Puerto Rico and are instructed to return goods to the USA, you may do one of the following:

If the goods are to be sent by a COURIER SERVICE, send the goods to:

Pelco  
3500 Pelco Way  
Clovis, CA 93612-5699 USA

If the goods are to be sent by a FREIGHT FORWARDER, send the goods to:

Pelco c/o Expeditors  
473 Eccles Avenue  
South San Francisco, CA 94080 USA  
Phone: 650-737-1700  
Fax: 650-737-0933

Pelco, the Pelco logo, Camclosure, Esprit, Genex, Legacy, and Spectra are registered trademarks of Pelco.  
Endura and ExSite are trademarks of Pelco.

© Copyright 1997, Pelco. All rights reserved.



## Free Manuals Download Website

<http://myh66.com>

<http://usermanuals.us>

<http://www.somanuals.com>

<http://www.4manuals.cc>

<http://www.manual-lib.com>

<http://www.404manual.com>

<http://www.luxmanual.com>

<http://aubethermostatmanual.com>

Golf course search by state

<http://golfingnear.com>

Email search by domain

<http://emailbydomain.com>

Auto manuals search

<http://auto.somanuals.com>

TV manuals search

<http://tv.somanuals.com>