



# **CM6800-32X6 Matrix Switcher**



**C1522M-C (2/05)**

# CONTENTS

<b>Section</b>	<b>Page</b>
IMPORTANT SAFEGUARDS AND WARNINGS .....	6
DESCRIPTION .....	7
MODELS .....	10
ASSOCIATED EQUIPMENT .....	10
COMPATIBLE PRODUCTS .....	10
ADDITIONAL RESOURCES .....	10
INSTALLATION .....	11
MOUNTING .....	11
VIDEO SOURCES .....	12
CONTROL LINES .....	14
MONITORS .....	15
ALARMS .....	16
CONNECTING DEVICES THROUGH THE COMMUNICATION PORTS .....	17
KBD100, KBD200A, AND KBD300A SERIES KEYBOARDS .....	19
KBD100, KBD200A, AND KBD300A: DIRECT-POWERED KEYBOARD .....	19
KBD100, KBD200A, AND KBD300A: REMOTE KEYBOARDS .....	21
M DEVICES .....	22
CONNECTING A PC .....	27
CONNECTING GENEX MULTIPLEXERS .....	28
LOCAL AUXILIARIES .....	29
SYSTEM START-UP .....	31
POWER-UP THE SYSTEM .....	31
INITIALIZE KEYBOARDS .....	31
CONFIGURE THE SYSTEM .....	31
COMMUNICATION PORTS .....	32
KBD960/KBR960 KEYBOARD .....	32
GENEX MULTIPLEXER .....	32
MONITOR COLOR ADJUSTMENT: .....	33
PROGRAM PRESETS .....	33
ADDITIONAL PROGRAMMING .....	33
PROGRAMMING THE CM6800 .....	34
CM6800 PROGRAMMING MODE .....	35
NAVIGATE AND SELECT OPTIONS/FIELD ENTRIES IN PROGRAMMING MODE .....	36
ACCESS .....	38
ALARM PROGRAMMING .....	39
PROGRAM ALARM GROUPS .....	39
INTERNAL AND EXTERNAL ALARMS .....	40
PROGRAM A VIDEO LOSS ALARM .....	41
AUXILIARY OUTPUTS .....	42
CAMERA PROGRAMMING .....	43
PROGRAM LOGICAL NUMBERS .....	43
PROGRAM CAMERAS .....	44
EVENT TIMERS .....	46
MACRO .....	47
MACRO STATUS VIEW SCREEN .....	47
MONITOR DISPLAY .....	48
PASSWORD .....	50
PORTS (SERIAL/COM PORTS) .....	51
PRIORITY .....	52
SEQUENCE .....	52
TIME AND DATE .....	54
PATTERNS, PRESETS, AND ZONES .....	54

OPERATION .....	55
OVERVIEW .....	55
OPERATING THE CM6800 .....	55
SWITCH MONITORS .....	55
SELECT CAMERAS .....	56
CONTROL RECEIVERS .....	56
OPERATE SEQUENCES .....	57
RUN A MACRO .....	58
ACKNOWLEDGE AN ALARM .....	58
CALL A PRESET .....	59
CREATE AND RUN A PATTERN .....	59
OPERATE AUXILIARIES/RELAYS .....	60
CONTROL GENEX MULTIPLEXER AND GENEX MULTIPLEXER DISPLAYS .....	61
OPERATE SCANNING FUNCTIONS .....	61
DETECT VIDEO LOSS .....	61
DEFINE ZONES .....	61
APPENDIX .....	62
CM6800 DIP SWITCHES .....	62
ALARM GROUP DISPLAY OPTIONS .....	63
MACRO COMMANDS .....	65
ASCII OPERATING COMMANDS .....	67
TROUBLESHOOTING .....	70
GAINING INITIAL CONTROL .....	70
SOFTWARE RESET .....	70
SOLUTIONS TO COMMON PROBLEMS .....	71
KBD960/KBR960 ICON/BUTTON LEGEND .....	72
GLOSSARY .....	73
INDEX .....	76
SPECIFICATIONS .....	78
REGULATORY NOTICES .....	79
WARRANTY AND RETURN INFORMATION .....	79

# LIST OF ILLUSTRATIONS

<b>Figure</b>		<b>Page</b>
1	Sample CM6800-32X6 System .....	7
2	Installing Rack Ears .....	11
3	Mounting the CM6800 Matrix Switcher/Controller .....	11
4	CM6800-32X6 Video Inputs .....	12
5	Connecting Terminated Video Sources .....	13
6	Connecting Looping Video Sources .....	13
7	PTZ Control Connections .....	14
8	Connecting Monitors .....	15
9	Connecting Alarms .....	16
10	Communication Port Inputs .....	17
11	CM6800-32X6 Communication Port Connections and Options .....	18
12	Data Cable Plugged into Local Keyboard .....	19
13	Data Cable Plugged into COM 5 .....	19
14	Remote Keyboards .....	21
15	RJ-45 Cable Types .....	22
16	Connecting a KBD960/KBR960 to the CM6800-32X6 .....	23
17	Connecting a Single ALM2064 Alarm Interface Unit .....	24
18	Connecting a Single REL2064 Relay Interface Unit .....	24
19	Connecting Multiple M Devices – Local Connection .....	25
20	Connecting Multiple M Devices – Remote Connection .....	26
21	PC Connection to DB9 Port .....	27
22	Connecting Genex Multiplexers .....	28
23	Wiring the AUX 1 (Relay) Output .....	29
24	Wiring the F2 (TTL) Output .....	30
25	CM6800 Time/Date Stamp on Monitor .....	31
26	CM6800 Color Bars .....	33
27	CM6800 Password Screen .....	35
28	CM6800 Programming Main Menu .....	35
29	Sample Access Screen .....	38
30	Program Alarm Groups .....	39
31	Program an Internal or External Alarm Screen .....	40
32	Program Video Loss Alarms .....	41
33	Program Auxiliary Outputs .....	42
34	Program Logical Camera Numbers .....	43
35	Program Cameras .....	44
36	Sample Event Timer Programming .....	46
37	Access the Macro Screen .....	47
38	Macro Status View Screen .....	47
39	Access the Monitor Screen .....	48
40	Access the Set Password Screen .....	50
41	Access the Port Screen .....	51
42	Access the Priority Screen .....	52
43	Sequence Screen .....	52
44	Scratchpad Sequence Screen .....	53
45	Access the Time and Date Screen .....	54
46	CM6800 DIP Switches – Factory Default Settings .....	62
47	Dip Switch Cover Plate .....	70
48	CM6800 DIP Switch 7 .....	70
49	Icon/Button Legend .....	72

## LIST OF TABLES

<b>Table</b>		<b>Page</b>
A	Video Coaxial Cable Requirements .....	12
B	Communication Port Devices and Wiring .....	17
C	Default Port Settings .....	18
D	Keyboard Addresses: KBD100/200A/300A Series Keyboards .....	20
E	Switch Settings – KBD200A/300A Keyboards Only .....	20
F	Default Port Settings .....	32
G	CM6800 DIP Switch Settings .....	62
H	Macro Commands .....	65
I	Examples of ASCII Commands .....	67
J	ASCII Commands .....	68
K	Solutions To Common Problems .....	71

## IMPORTANT SAFEGUARDS AND WARNINGS

1. Read, keep, and follow these instructions.
2. Heed all warnings.
3. There are no user-serviceable parts inside this unit. Only authorized service personnel may open the unit.
4. Installation and servicing should only be done by qualified service personnel and conform to all local codes.
5. **WARNING:** To reduce the risk of fire or electric shock, do not expose this unit to rain or moisture if this unit is designed for indoor use only.
6. Unless this unit is specifically marked as a NEMA Type 3, 3R, 3S, 4, 4X, 6 or 6P enclosure, it is designed for indoor use only and it must not be installed where exposed to rain or moisture.
7. Do not expose this unit to dripping or splashing. Do not place objects filled with liquids, such as vases, on this unit.
8. Do not block any ventilation openings. Install in accordance with the manufacturer's instructions.
9. The installation method and materials should be capable of supporting four times the weight of the unit and equipment.
10. Do not install near any heat source.
11. Only use attachments/accessories specified by the manufacturer.
12. Clean only with dry cloth.
13. Do not defeat the safety purpose of the polarized or grounding-type plug.
14. Protect the power cord from being walked on or pinched, particularly at plugs, convenience receptacles, and the point where they exit from the unit.
15. Unplug this unit during lightning storms or when unused for long periods of time.

The product and/or manual may bear the following marks:



This symbol indicates that dangerous voltage constituting a risk of electric shock is present within this unit.



This symbol indicates that there are important operating and maintenance instructions in the literature accompanying this unit.

### CAUTION:

**RISK OF ELECTRIC SHOCK.  
DO NOT OPEN.**

Please thoroughly familiarize yourself with the information in this manual prior to installation and operation.

### FOR QUALIFIED SERVICE PERSONNEL ONLY

1. Only use replacement parts recommended by Pelco.
2. After replacement/repair of this unit's electrical components, conduct a resistance measurement between line and exposed parts to verify the exposed parts have not been connected to line circuitry.
3. **CAUTION:** Danger of explosion if battery is incorrectly replaced. Replace only with the same or equivalent type. Dispose of used batteries according to the instructions provided by the battery manufacturer.

# DESCRIPTION

Pelco's CM6800 Matrix Switcher/Controller is a cross-point video matrix switcher. The CM6800-32X6 provides switching and control for 32 video inputs and six monitor outputs from any one of up to 10 keyboards, PCs, and other devices. All 32 video inputs can be used to control other devices, such as multiplexers, and allow for looping to other devices.

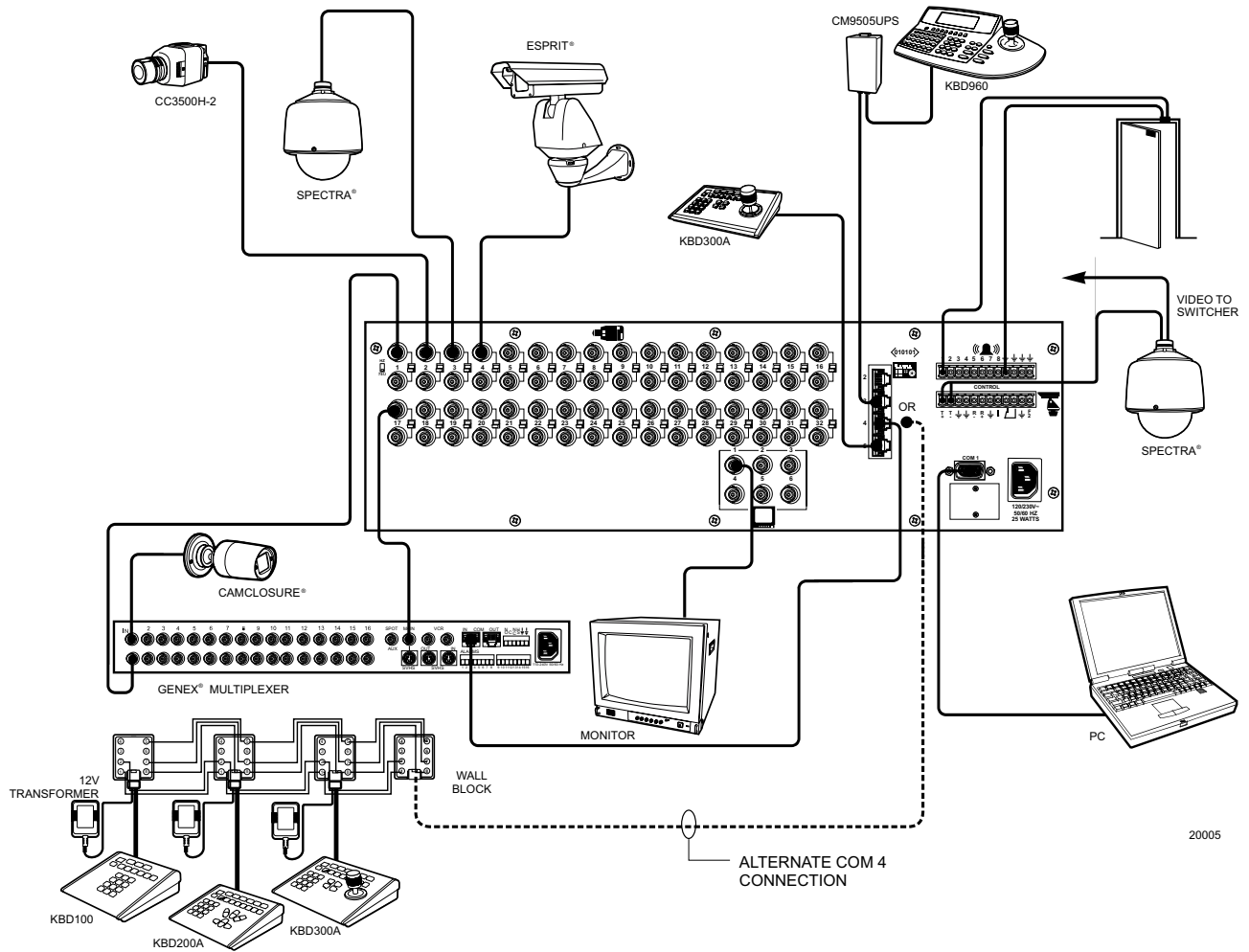

20005

Figure 1. Sample CM6800-32X6 System

## Programming

The CM6800 features easy programming through on-screen menus or the Windows®-based CM6800-MGR software package. **All programming is password-protected.** Programming menus are provided in English, French, German, Italian, Polish, Portuguese, Russian, and Spanish.

## Keyboards

Up to eight keyboards from the KBD100/200A/300A Series and two keyboards from the KBD960/KBR960 Series can be connected to the CM6800-32X6. Camera positioning can be programmed and controlled from the KBD200A/300A and KBD960/KBR960 Series keyboards. Refer to *Associated Equipment* for keyboard descriptions.

---

**NOTE:** You can program the CM6800 with the KBD200A/300A keyboard while in “CM6800 Mode” only (if you use “CM6800 ASCII Mode,” you can control the CM6800 switcher, but you cannot program it).

---

## Sequences, Macros, Presets, Patterns, and Zones

The CM6800 features the following programmed operations:

A **sequence** allows operators to see a routine of 72 camera views on any system monitor over and over again. The sequence can be operated automatically or manually.

A **scratchpad sequence** allows an operator to run a sequence from an individual monitor without entering the password-protected programming menus.

A **macro** is a sequence of commands or steps. When a macro is run, the steps programmed into that macro are performed. Macros can be operated automatically or manually. Automatic operation can be based on specific times or dates. Macros can also be triggered by alarms.

The following operations are available only with positionable cameras controlled by KBD200A/KBD300A or KBD960/KBR960 keyboards:

A **preset** allows operators to direct a PTZ (camera positioning system) to move to a predetermined scene on keyboard command or as a result of an alarm. In addition, a preset can place a descriptive title on the monitor screen. The number of presets available is determined by the camera positioning system.

With a **pattern** operators can program a camera positioning system to move around its viewing area in a repeating pattern. The number and time length of patterns varies with different positioning systems.

A **zone** is a user-defined, physical location to which (1) a label is attached and (2) a camera is associated. When the associated camera is panned through or remains within this defined zone, the zone label appears on the monitor.

## Interface Control

The CM6800 interfaces with the following:

- Coaxitron® standard mode (15-bit) and extended mode (32-bit) protocol receivers
- Pelco's D and P protocol receivers (RS-422)
- Pelco's M protocol devices (RS-485)



## System Access and Priority

The CM6800 provides the following ways to restrict system access:

- Camera to Monitor: Cameras can be assigned to specific monitors for viewing.
- Keyboard to Monitor: Keyboards can be assigned to control specific monitors.
- Camera to Keyboard:
  - Viewing: Keyboards can be assigned view-only access to specific cameras (no PTZ control).
  - Control: Keyboards can be assigned full access (both PTZ control and viewing) to specific cameras.

The CM6800 provides eight levels of **priority** control. Each level defines the ability of a keyboard to control a camera positioning system (KBD200A/KBD300A or KBD960/KBR960 only) and to access programming screens.

## Alarm Inputs

Eight internal alarm inputs are provided on the rear panel of the matrix switcher/controller. These internal alarm inputs are programmable to associate any camera to any input.

Up to two ALM2064 Alarm Interface Units can be connected to the CM6800. Each alarm interface unit can handle up to 64 alarms, for a total of 128 external alarms.

## Auxiliary Outputs

Two internal auxiliary outputs are provided on the back of the CM6800-32X6. One is a relay output, and one is an open collector (TTL) output. You can also connect up to two REL2064 Relay Interface Units.

## Power, Mounting Methods

The CM6800 operates on 120V or 230V, 50/60 Hz. The case mounts in three rack units (5.25 inches or 13.34 cm) of vertical space in a universal mount, such as a 19-inch (48.26 cm) equipment bay, or to a wall or tabletop.

## Continuous Operating Device

The CM6800 is a self-contained video surveillance system designed for continuous duty operation. Once installed, there are no user or service technician items that require intervention which would require the system to go off-line or have the power turned off under normal operation. There are two methods for system programming: direct menu control and indirect control, using a Windows®-based setup program supplied by Pelco. Both of these methods are noninvasive and do not require the cycling of power in order for storage or execution of new software settings. The communication ports use standard low voltage interfaces such as RS-232, RS-422 and RS-485, and all connections and disconnections do not require rebooting or power cycling. Video connections or changes of termination state do not require rebooting or power cycling.

## MODELS

CM6800-32X6	Matrix switcher/controller with 32 video inputs and 6 monitor outputs, NTSC configured 120/230 V, 50/60 Hz, autoranging
CM6800-32X6-X	Matrix switcher/controller with 32 video inputs and 6 monitor outputs, PAL configured 120/230 V, 50/60 Hz, autoranging

## ASSOCIATED EQUIPMENT

KBD100	Desktop keyboard with full switching and programming capabilities, +12 VDC or 12 V 50/60 Hz
KBD200A	Desktop keyboard with full switching and programming capabilities, plus push-button control of PTZ functions, +12 VDC or 12V 50/60 Hz
KBD300A	Desktop keyboard with full switching and programming capabilities, plus joystick control of PTZ functions, +12 VDC or 12 V 50/60 Hz
KBD960	Full-function desktop variable speed keyboard; 120 V, 50/60 Hz
KBD960-X	Same as KBD960, PAL configured for 230 V, 50/60 Hz operation
KBR960	Full-function rack mount variable speed keyboard; 120 V, 50/60 Hz
KBR960-X	Same as KBR960, PAL configured for 230 V, 50/60 Hz operation
KBDKIT	Wiring kit for connecting KBD100, KBD200A, and KBD300A keyboards to remote keyboard port; includes two RJ-45 wall blocks and a transformer to convert 120 V, 60 Hz to 12 V, 60 Hz for keyboard power
KBDKIT-X	Wiring kit for connecting KBD100, KBD200A, and KBD300A keyboards to remote keyboard port; includes two RJ-45 wall blocks and a transformer to convert 230 V, 50 Hz to 12 V, 50 Hz for keyboard power
CM9505UPS	Universal Power Supply for KBD960/KBR960 keyboards
MX4000	Genex Series Multiplexer; available in color or monochrome duplex, and in color or monochrome simplex.
CM9760-CDU-T	Code distribution unit; 16-channel RS-422 transmit only (transmit wire and ground) distributor; primarily used for connecting up to 16 PTZ receivers in a "star" or "home run" configuration
ALM2064	Alarm interface unit, provides alarm monitoring capabilities for up to 64 alarm inputs, 100-240 V, 50/60 Hz
REL2064	Relay interface unit, provides 64 relays for operating peripheral equipment, 100-240 V, 50/60 Hz
CM9760-MDA	Master distribution amplifier with time, date, and title, 120 V, 60 Hz

## COMPATIBLE PRODUCTS

Switchers	CM9740, CM9760, CM9770, CM9780
PelcoNet Transmission Systems	NET300 Series, NET350 Series, NET4001A
Video Management Systems	VMX200, VMX300, VMX300-E

## ADDITIONAL RESOURCES

- CM6800-32X6 Quick Start Guide
- CM6800-MGR Installation/Operation Manual
- Pelco Technical Tips available on Pelco.com or from a Technical Support representative (1-800-289-9100)

# INSTALLATION

Unpack and inspect all parts carefully. The following parts are supplied:

- 1 CM6800 Switcher/Controller
- 4 10-32 x .750-inch pan head screws
- 4 .500" OD nylon washers
- 1 Power cord
- 2 6-foot (1.8 m) straight data cables with RJ-45 connectors
- 1 6-foot (1.8 m) reversed data cable with RJ-45 connectors
- 2 RJ-45 wall block terminals

**NOTE:** There are no user-serviceable parts inside this unit. Only authorized service personnel may open the unit.

## MOUNTING

1. Select a suitable location for the CM6800. It occupies 5.25 inches (13.34 cm) of vertical space, or three rack units (RUs), in a universal mount. The CM6800 must be within 6 feet (1.8 m) of a suitable electrical outlet.

**Follow proper installation practices and leave 1 RU above and below the CM6800 for ventilation.**

**Do not connect the power until the installation is complete. Refer to the *System Start-Up* section.**

2. The CM6800 is shipped with the rack ears installed at the front. Reposition as needed for your application. If the ears are not required, remove them.

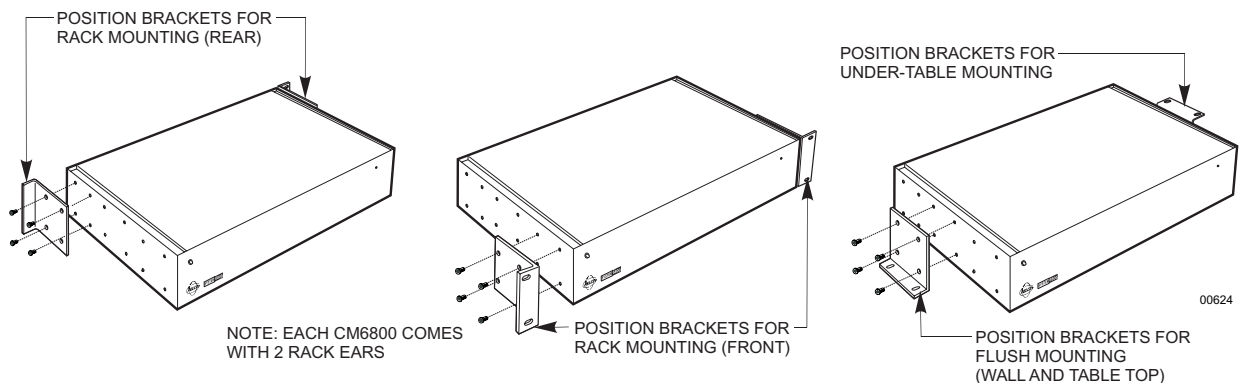

**Figure 2.** Installing Rack Ears

3. Use supplied pan head screws and washers to mount the CM6800 in a standard 19-inch (48.26 cm) equipment rack or wood or sheet metal screws to mount against a flat surface, according to your installation requirements.

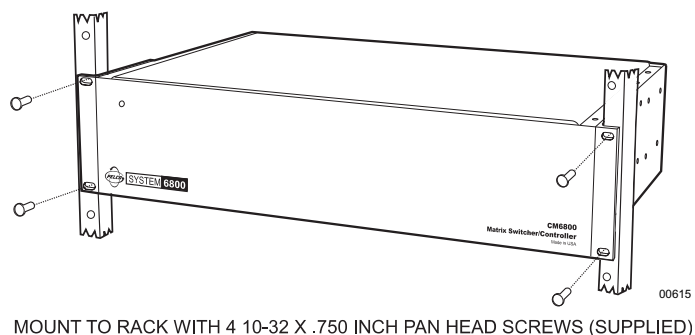

**Figure 3.** Mounting the CM6800 Matrix Switcher/Controller

## VIDEO SOURCES

The CM6800-32X6 offers 32 full-function video inputs which support Coaxitron PTZ control and video loss detection. The video inputs can be used for looping video connections with terminating and unterminating switches on the back panel. They also provide the ability to view and interface with other devices, such as Genex multiplexers. If control of the device connected to the video input is required, connect a data cable between the multiplexer and the CM6800. Refer to the *Connecting Genex Multiplexers* section for instructions on connecting and controlling video from a multiplexer.

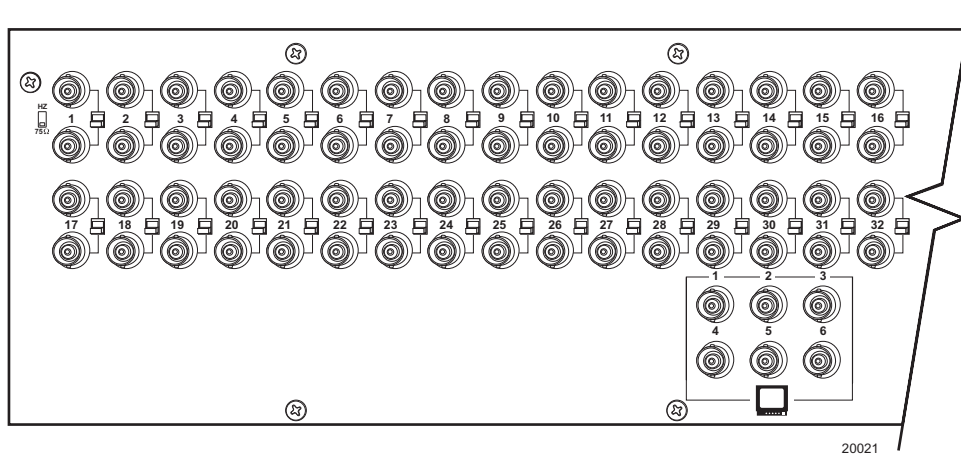

**Figure 4.** CM6800-32X6 Video Inputs

1. Connect video cables at the appropriate video input BNC receptacles on the back of the CM6800. For best results, use crimp-on BNCs only. Do not use screw-on BNCs; these typically do not provide adequate ground and signal connections.

Refer to Table A for video coaxial wiring requirements.

**Table A.** Video Coaxial Cable Requirements

Cable Type*	Maximum Distance
RG59/U	750 ft (229 m)
RG6/U	1,000 ft (305 m)
RG11/U	1,500 ft (457 m)

- \* Minimum cable requirements:
- 75 ohms impedance
  - All-copper center conductor
  - All-copper braided shield with 95% braid coverage

- Set the terminating switches according to your system requirements.

Terminating switches are used to terminate or unterminate the video input. The factory default has the switches set in the terminated (75-ohm) position.

If you are connecting only a camera to an input, leave the switch in the terminated position.

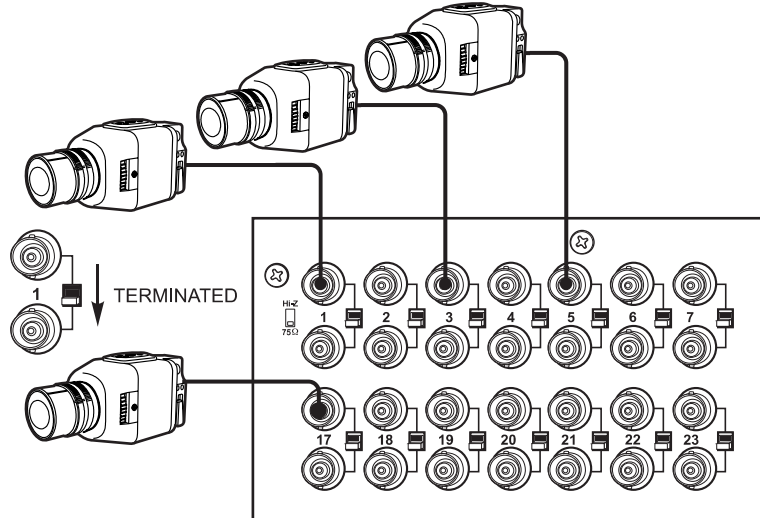

**Figure 5.** Connecting Terminated Video Sources

If you are looping the input to another device, set the rear panel switch in the unterminated (Hi-Z) position. Terminate at the final device.

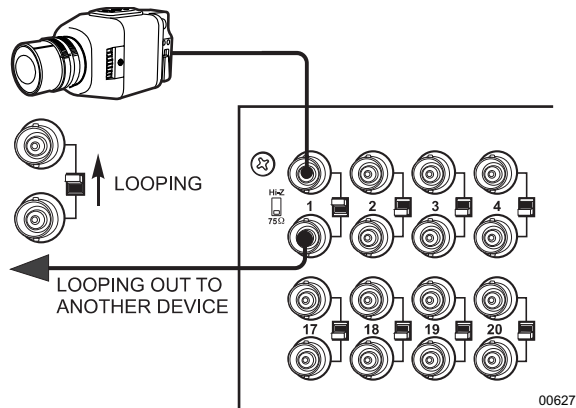

**Figure 6.** Connecting Looping Video Sources

---

**NOTE:** The end point of any video cable run must be terminated in 75 ohms.

---

## CONTROL LINES

You cannot connect a Coaxitron camera to the PTZ port. If your video sources are all controlled by Coaxitron, skip this section.

Connect camera control lines to receivers. If any of your video sources are using D or P protocol via RS-422 communications, they will connect at the PTZ connector on the back of the CM6800-32X6.

---

**NOTE:** D and P protocol receivers cannot be mixed on the same communication port but you can use D on one port and P on the other.

---

Daisy-chaining (going from one receiver to another) is recommended but not always possible. A maximum of 16 receivers can be daisy-chained from the PTZ port. If more than 16 receivers are required for your system, or if you do not want to daisy-chain the receiver connections, use the CM9760-CDU-T. You can connect up to two CM9760-CDU-T units to the CM6800-32X6.

---

**NOTE:** After completing system installation and power-up, you must configure the CM6800 and the camera/receiver. Refer to the System Start-Up section.

---

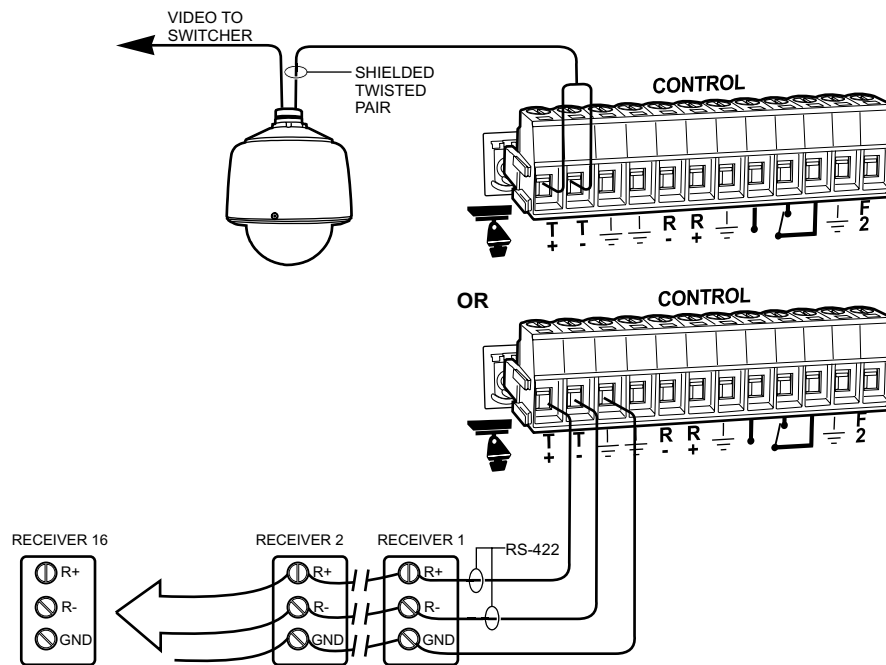
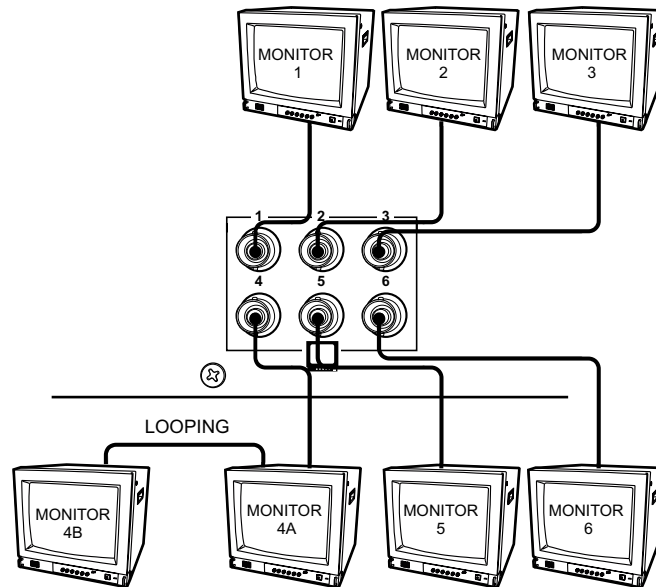

**Figure 7.** PTZ Control Connections

## MONITORS

The CM6800-32X6 supports six monitors.

1. Install monitors according to the instructions provided with them.
2. Connect the monitor cables at the appropriate video output BNC receptacles on the back of the CM6800.
3. Terminate cables at the monitors. If you are looping to other devices, unterminate all but the last device.



**Figure 8.** Connecting Monitors

## ALARMS

The CM6800 provides numerous alarm handling options. Refer to the *Programming* section for a detailed description.

1. Connect wires from the sensors to the respective alarm input points on the connectors at the back of the CM6800. Each sensor requires two wires – one wire to the alarm input terminal and a return wire to one of the ground terminals on the connector. The CM6800 supports eight internal alarms.

Alarm sensors can be either N.O. (normally open) or N.C. (normally closed) contacts. The CM6800 is set to N.O. as a factory default.

2. If your system requires more than eight alarms, connect an ALM2064 unit to the system. Refer to the *M Devices* section.

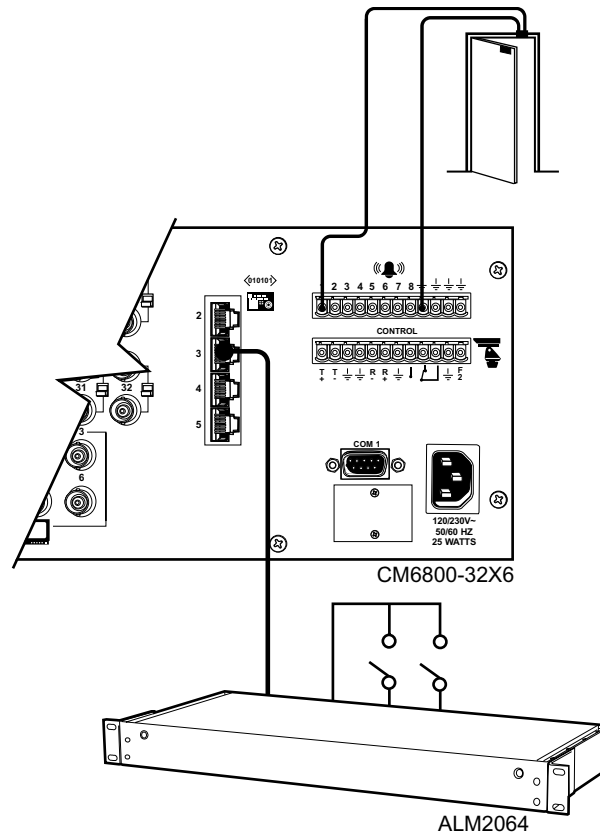

**Figure 9.** Connecting Alarms



## CONNECTING DEVICES THROUGH THE COMMUNICATION PORTS

The CM6800-32X6 Matrix Switcher/Controller provides five communication ports on the rear panel for connecting peripheral components. Instructions are provided in this section for the most commonly used connections.

**NOTE:** Connection instructions for other peripheral devices, such as the CM9760-MDA or CM9760-CDU-T, are provided as Pelco Technical Tips. Connection instructions for compatible products, such as PelcoNet transmission systems and the VMX300 are provided in the appropriate product installation manual.

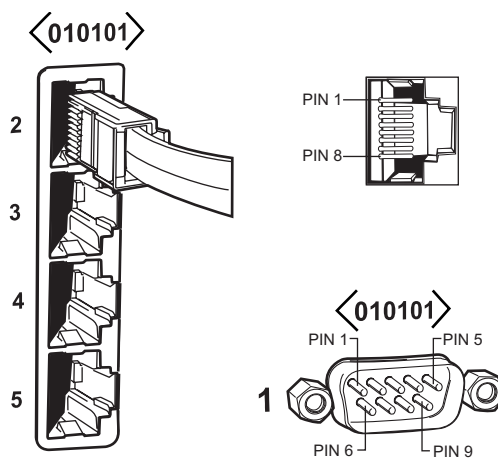

Figure 10. Communication Port Inputs

Table B. Communication Port Devices and Wiring

Port	Input Type	Wiring	Pin-Outs	Default Device	Programmable to Other Device(s)
1	DB9	RS-232	2 Rx 3 Tx 5 Ground	PC Setup – CM6800MGR program	ASCII device
2	RJ-45	RS-232	1 Rx 5 Ground 8 Tx	ASCII device	No
3	RJ-45	RS-485	1 Rx+ 2 Rx- 5 Ground 7 Tx- 8 Tx+	M devices – ALM2064, REL2064, KBD960	No
4	RJ-45	RS-485	1 Rx+ 2 Rx- 5 Ground 7 Tx- 8 Tx+	Genex multiplexer	CM9760-MDA, ASCII, keyboards (KBD100, 200A, & 300A)
5	RJ-45	RS-485 plus power	1 Rx+ 2 Rx- 3 KBD power (12V) 4 KBD Ground 5 Ground 7 Tx- 8 Tx+	Keyboard (direct powered) – KBD100, 200, & 300	No

**Table C. Default Port Settings**

Port	Default Settings
COM 1	MGR, RS-232, 56000 baud, no parity, 8 data bits, 1 stop bit
COM 2	ASCII, RS-232, 9600 baud, no parity, 8 data bits, 1 stop bit
COM 3	M, RS-485, 19200 baud, no parity, 8 data bits, 1 stop bit
COM 4	MUX-GENEX, RS-485, 9600 baud, odd parity, 8 data bits, 1 stop bit
COM 5	KBD-300A, RS-485, 9600 baud, odd parity, 8 data bits, 1 stop bit

**NOTE:** Refer to the *Programming* section for instructions on changing Port settings.

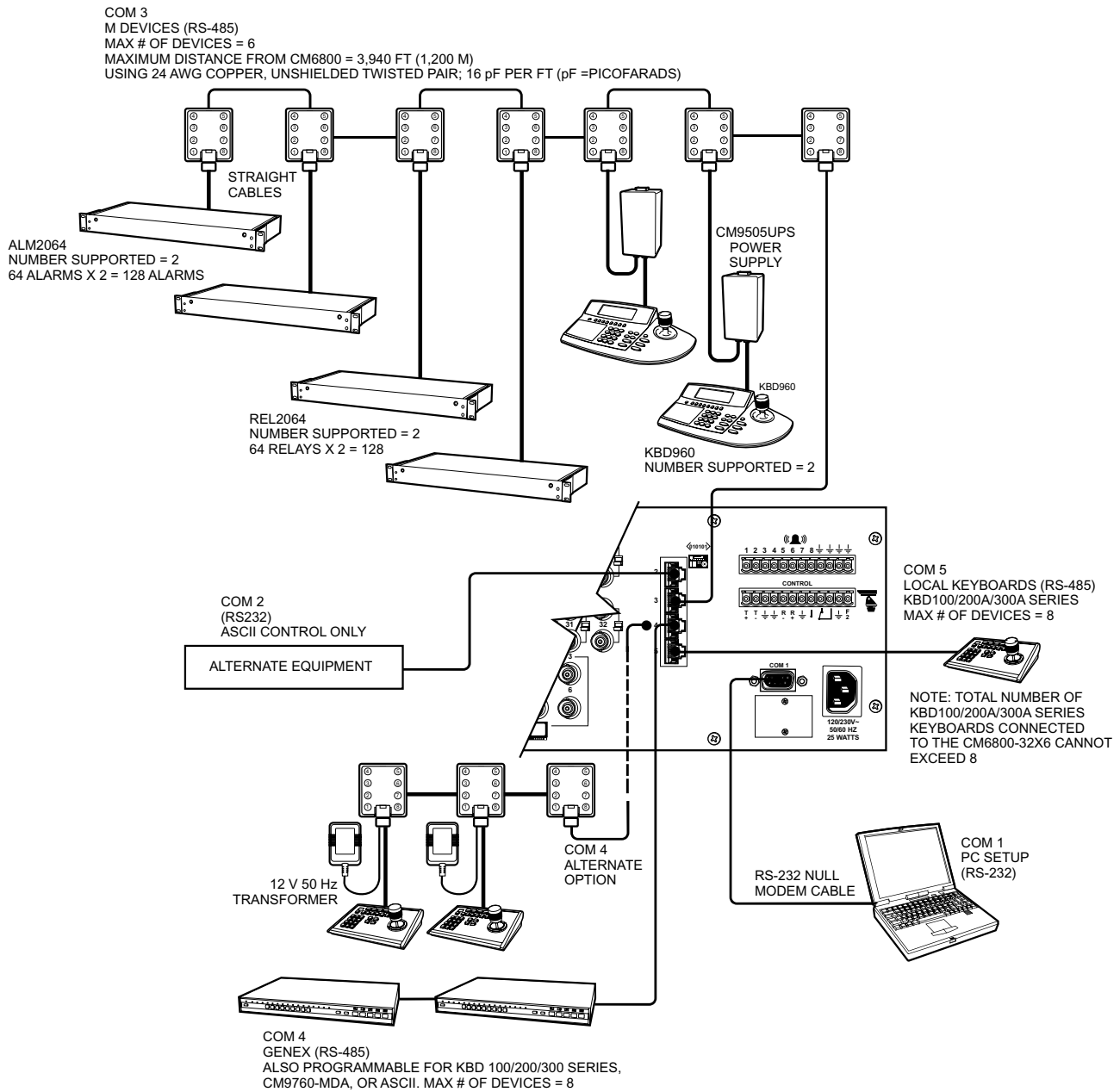

**Figure 11.** CM6800-32X6 Communication Port Connections and Options

## KBD100, KBD200A, AND KBD300A SERIES KEYBOARDS

You can connect up to eight KBD100/200A/300A Series keyboards to either of the following ports:

- COM 4 (up to 8 remotely connected keyboards)
- COM 5 (1 direct-powered keyboard or up to 8 remotely connected keyboards)

The total number of KBD100/200A/300A Series keyboards connected to the CM6800-32X6 cannot exceed eight.

### KBD100, KBD200A, AND KBD300A: DIRECT-POWERED KEYBOARD

Use COM 5 (Serial Port 5) for a direct-powered local keyboard. COM 5 can power one KBD100/200A/300A Series keyboard.

If you are connecting more than one keyboard to COM 5, a KBDKIT(-X) is required for each keyboard. Refer to the *KBD100, KBD200A, and KBD300A: Remote Keyboards* section.

1. Using the 25-foot (7.62 m) straight data cable supplied with the keyboard, plug one end into the RJ-45 connector on the rear of the keyboard.

**NOTE:** If distance between CM6800 and keyboard exceeds 25 feet, use KBDKIT(-X).

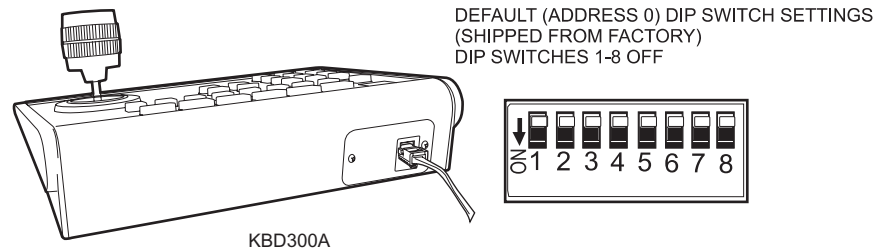

**Figure 12.** Data Cable Plugged into Local Keyboard

2. Plug the other end of the data cable into COM 5 on the CM6800-32X6.

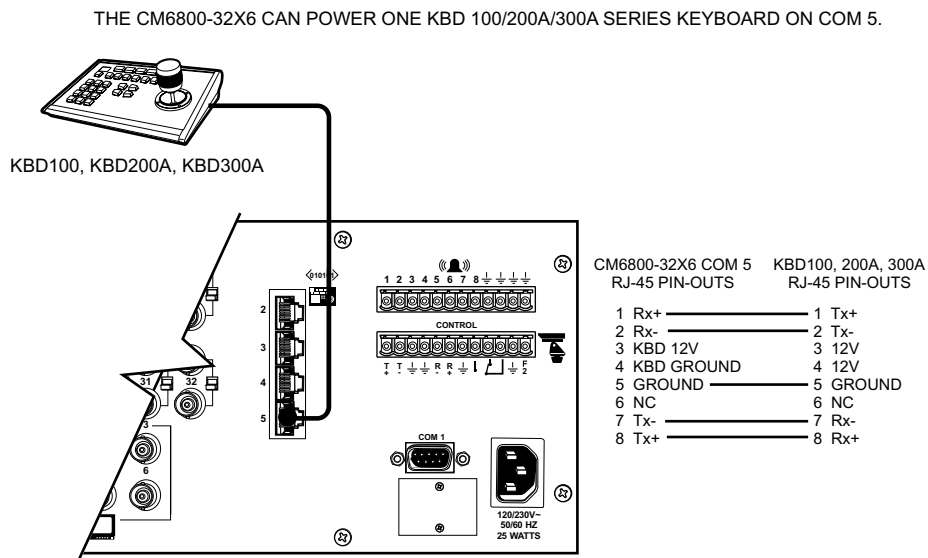

**Figure 13.** Data Cable Plugged into COM 5

3. Set the keyboard DIP switches for the desired address for the local keyboard (refer to Figure 12 and Table D).

**Table D.** Keyboard Addresses: KBD100/200A/300A Series Keyboards

Keyboard	Address	Switch Settings			
		1	2	3	4
1	0	OFF	OFF	OFF	OFF
2	1	ON	OFF	OFF	OFF
3	2	OFF	ON	OFF	OFF
4	3	ON	ON	OFF	OFF
5	4	OFF	OFF	ON	OFF
6	5	ON	OFF	ON	OFF
7	6	OFF	ON	ON	OFF
8	7	ON	ON	ON	OFF

**Table E.** Switch Settings – KBD200A/300A Keyboards Only

Keyboard	Switch			
	5	6	7	8
KBD200A	OFF	OFF	OFF (NOT USED)	OFF
KBD300A	OFF	ON or OFF*	OFF (NOT USED)	OFF

\* Switch 6 enables/disables turbo pan (can be switched while keyboard is on).



## M DEVICES

M protocol devices (KBD960/KBR960 keyboards, ALM2064 Alarm Interface Units, and REL2064 Relay Interface Units) can be connected to COM 3 on the CM6800-32X6.

If only one device is to be connected to COM 3, use the instructions for that device in the following sections.

If more than one device is to be connected to COM 3, refer to the *Multiple M Devices* section.

Connect M devices to the CM6800 with straight cables. Two straight cables and one reversed cable are supplied with the CM6800 (save the reversed cable for connecting a Genex Multiplexer, if applicable).

### M Devices Addressing

Each M device connected to the CM6800 must have a unique local address within a range of 1-16. Use the hardware DIP switches to set the appropriate ALM2064 and REL2064 local addresses. Specify the appropriate KBD960/KBR960 local address through the keyboard Setup Mode after you complete the system installation (refer to the *System Start-Up* section).

For use with the CM6800, Pelco recommends numbering M devices in a sequential order. In a sample application, with two of each M device, you might assign local addresses as follows:

M device local addresses:	Default	Recommended for CM6800
KBD960/KBR960:	1	1, 2
REL2064:	1	3, 4
ALM2064:	1	5, 6

---

**NOTE:** To use the CM6800 system access or keyboard priority features, you must address KBD960/KBR960 keyboards within a *range of 1-8*.

---

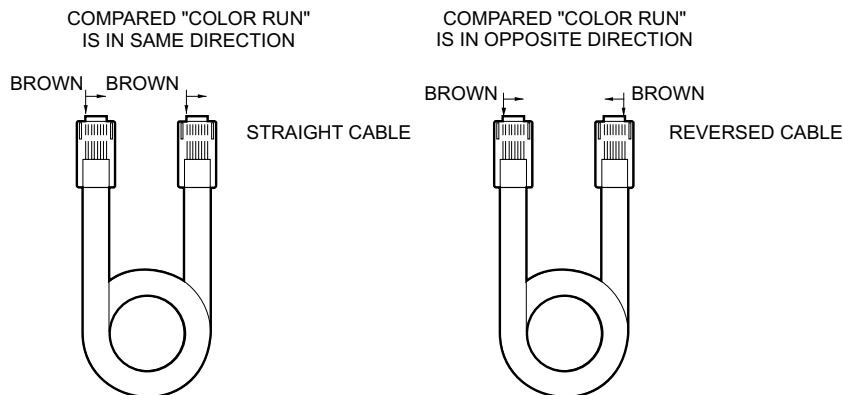

**Figure 15.** RJ-45 Cable Types

## Connecting a Single KBD960/KBR960 Keyboard

To connect a single KBD960/KBR960 Keyboard to the CM6800:

1. Connect the keyboard to the CM9505UPS using the straight cable supplied with the keyboard.
2. Connect the CM9505UPS to COM 3 on the CM6800-32X6 using the 6-foot (1.8 m) straight data cable supplied with the CM6800.

**NOTE:** After completing system installation and power-up, you must configure the KBD960/KBR960 settings. Refer to the System Start-Up section.

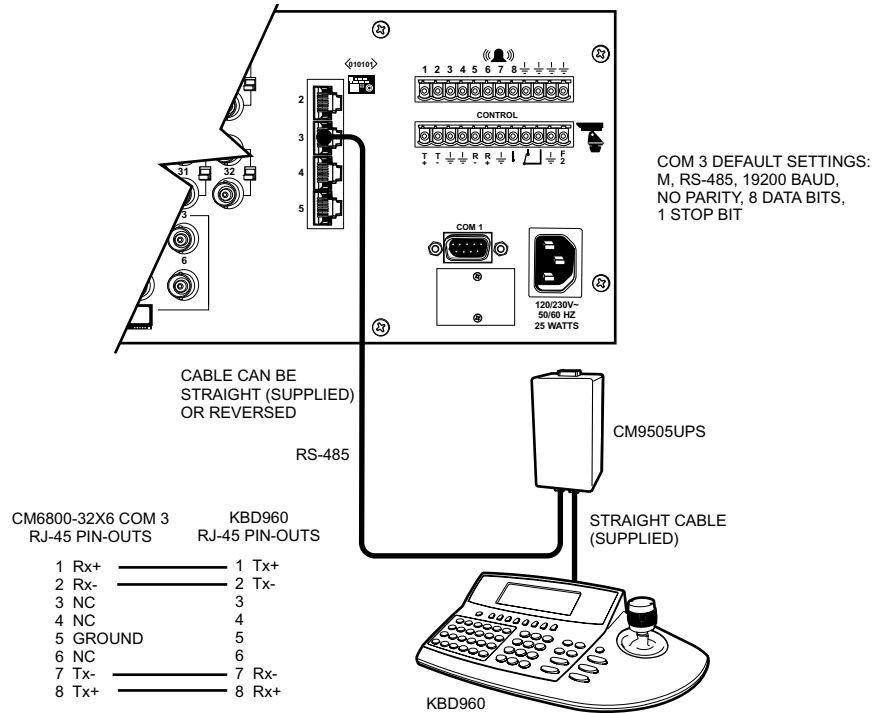

**Figure 16.** Connecting a KBD960/KBR960 to the CM6800-32X6

## Connecting a Single ALM2064 Alarm Interface Unit

To connect a single ALM2064 Alarm Interface Unit:

1. Connect the ALM2064 OUT port to COM 3 on the CM6800-32X6 using the 6-foot (1.8 m) straight data cable supplied with the CM6800.
2. Set SW2, DIP switches 1-8 to the appropriate positions for the local address (default address setting is 1). Refer to the ALM2064 Alarm Interface Unit Installation/Operation Manual for instructions.

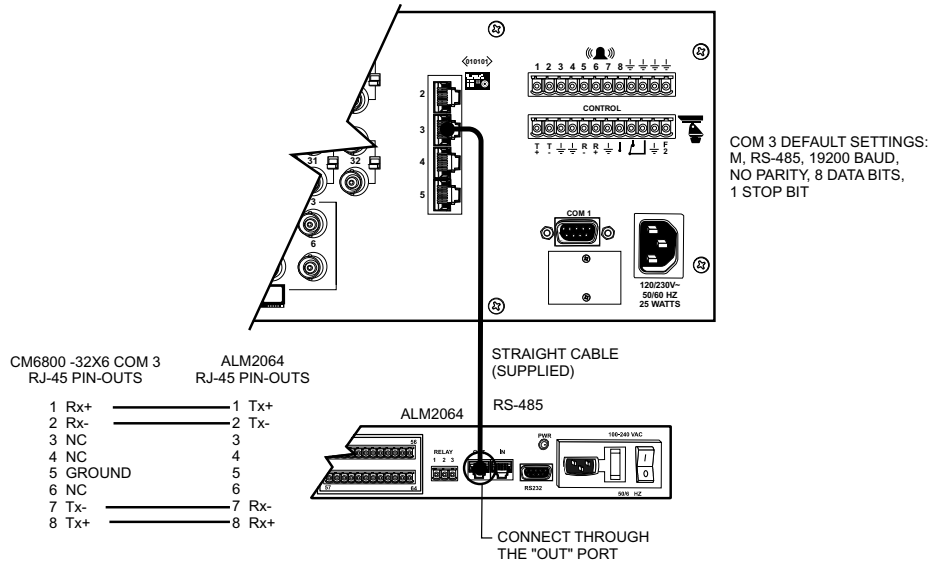

Figure 17. Connecting a Single ALM2064 Alarm Interface Unit

## Connecting a Single REL2064 Relay Interface Unit

To connect a single REL2064 Relay Interface Unit:

1. Connect the REL2064 OUT port to COM 3 on the CM6800-32X6 using the 6-foot (1.8 m) straight data cable supplied with the CM6800.
2. Set SW2, DIP switches 1-8 to the appropriate positions for the local address (default address setting is 1). Refer to the REL2064 Relay Interface Unit Installation/Operation Manual for instructions.

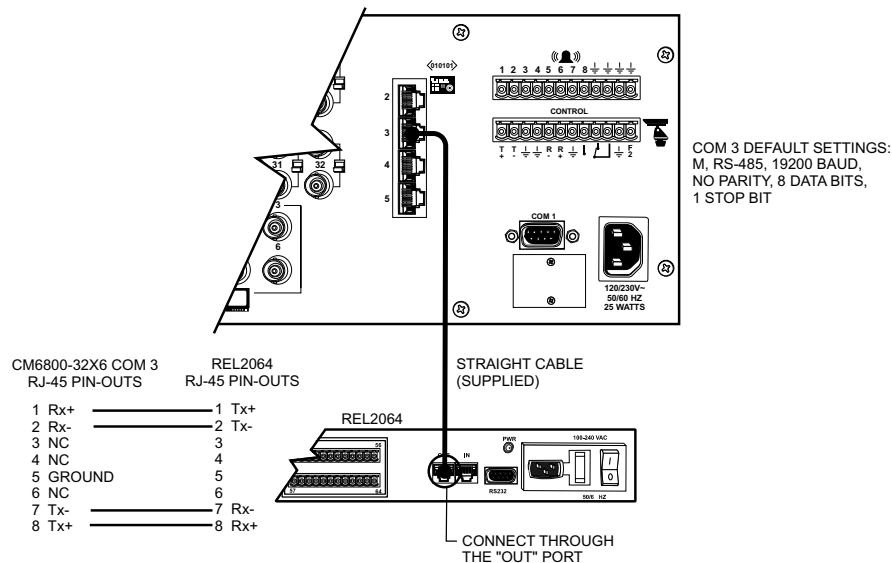

Figure 18. Connecting a Single REL2064 Relay Interface Unit



## Multiple M Devices

Multiple M devices (KBD960/KBR960, ALM2064, and REL2064) can be connected to COM 3 on the CM6800-32X6, either as local devices or remote devices (when connecting two KBD960/KBR960 keyboards to the CM6800, you must use a remote connection).

### Multiple M Devices: Local Connection

1. If you are connecting a KBD960/KBR960, connect it to the CM9505UPS with the straight cable supplied with the keyboard. Then connect the CM9505UPS to the IN port on the next unit (either the ALM2064 or the REL2064) with a 6-foot (1.8 m) straight cable (supplied with the CM6800).
2. Connect each ALM2064 and REL2064 unit to the next unit with a 6-foot (1.8 m) straight cable (supplied with the CM6800) from the OUT port to the IN port on the next unit. You can connect a maximum of two ALM2064 units and two REL2064 units to the CM6800.
3. Connect the last unit to the CM6800 with a 6-foot (1.8 m) straight cable (supplied with the CM6800) from the OUT port to COM 3 on the CM6800-32X6.

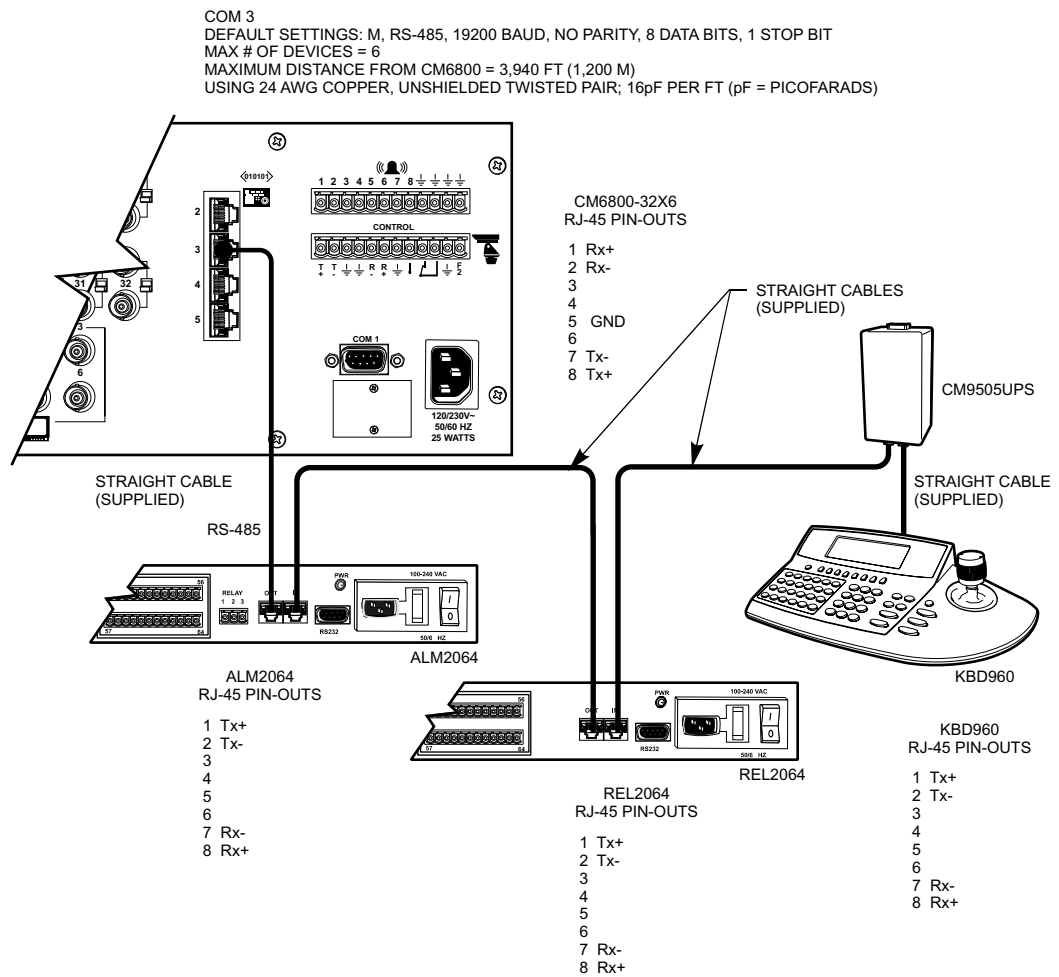

Figure 19. Connecting Multiple M Devices – Local Connection

## Multiple M Devices: Remote Connection

Use a remote connection when the distance from the CM6800 is greater than 6-feet (1.8 m).

1. Connect each ALM2064 and REL2064 unit to a wall block with a 6-foot (1.8 m) straight cable (supplied with the CM6800). You can connect a maximum of two ALM2064 units and two REL2064 units to the CM6800.
2. If you are connecting a KBD960, connect it to the CM9505UPS with the straight cable supplied with the keyboard. Then connect the CM9505UPS to a wall block with a 6-foot (1.8 m) straight cable (supplied with the CM6800). You can connect a maximum of two KBD960 keyboards to the CM6800.
3. Connect the wall blocks to a final wall block. If additional wall blocks are needed, order part number CON12J008Z03G0Z.
4. Connect the terminal wall block to COM 3 on the CM6800-32X6 using a 6-foot (1.8 m) straight cable (supplied with the CM6800).

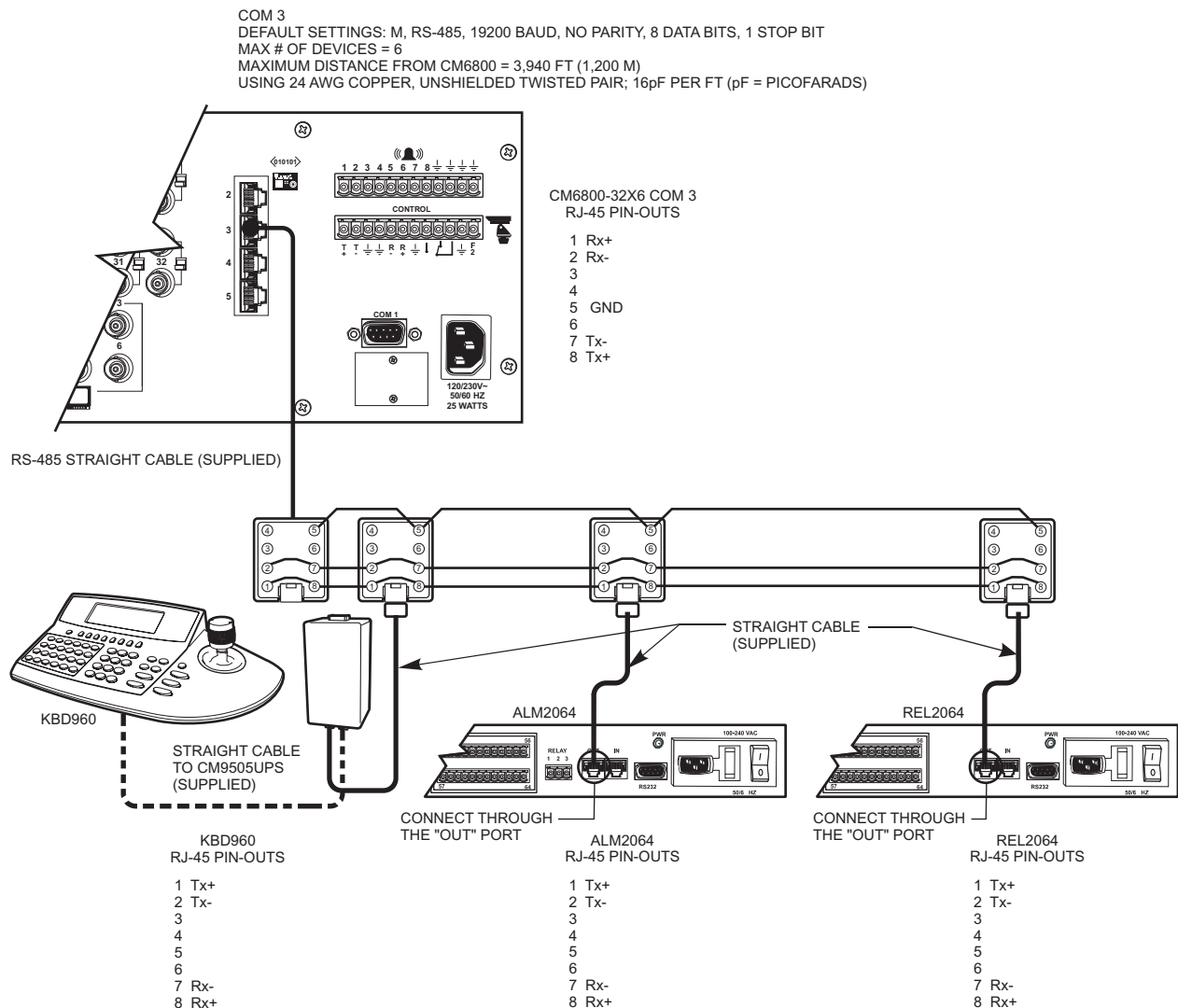

Figure 20. Connecting Multiple M Devices – Remote Connection

## CONNECTING A PC

The CM6800 provides PC-based setup and programming software that facilitates complete switcher programming and configuration. Refer to the CM6800-MGR Quick Start Guide for instructions on using the software.

Connect a PC to the CM6800 to access the CM6800-MGR software or to download upgrades to the software.

1. Using a null modem cable (user-supplied), plug one end into the DB9 COM 1 port on the PC. (To use a PC port other than COM 1, refer to the CM6800-MGR Installation/Operation Manual.)
2. Plug the other end of the cable into the DB9 COM 1 port of the CM6800.

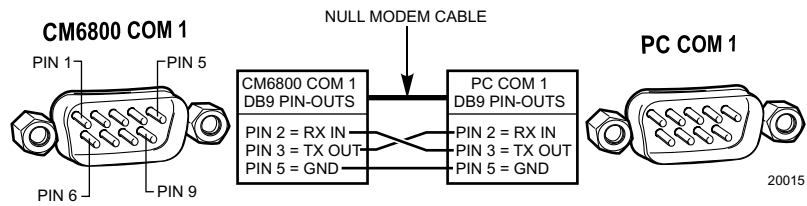

**Figure 21.** PC Connection to DB9 Port

## CONNECTING GENEX MULTIPLEXERS

Use COM 4 to connect up to eight Genex Multiplexers to the CM6800-32X6.

1. Connect the COM IN port of the multiplexer to COM 4 on the CM6800-32X6, using the 6-foot (1.8 m) reversed data cable supplied with the CM6800.

One reversed cable and two straight cables are supplied with the CM6800 (save the reversed cable for connecting a Genex multiplexer, if applicable).

A straight data cable is supplied with the Genex multiplexer. Use this cable for connecting a second Genex multiplexer to the first multiplexer, if necessary.

2. Connect the MAIN monitor output from the multiplexer to any of the camera inputs on the CM6800-32X6.
3. Connect cameras to the multiplexer and then loop them to the CM6800. Refer to the MX4000 Genex Series Simplex and Duplex Multiplexers Installation/Operation Manual for detailed camera connection instructions. Terminate the video loop at the CM6800.
4. If required, you can connect a total of eight Genex multiplexers through COM 4. Daisy-chain the multiplexers by connecting a straight data cable from the COM OUT port on the first multiplexer to the COM IN port on the second multiplexer; connect the COM OUT port on the second multiplexer to the COM IN port on the third multiplexer. Continue to the eighth multiplexer, if necessary.

Refer to the *System Start-Up* section for additional configuration steps required when using a Genex Multiplexer.

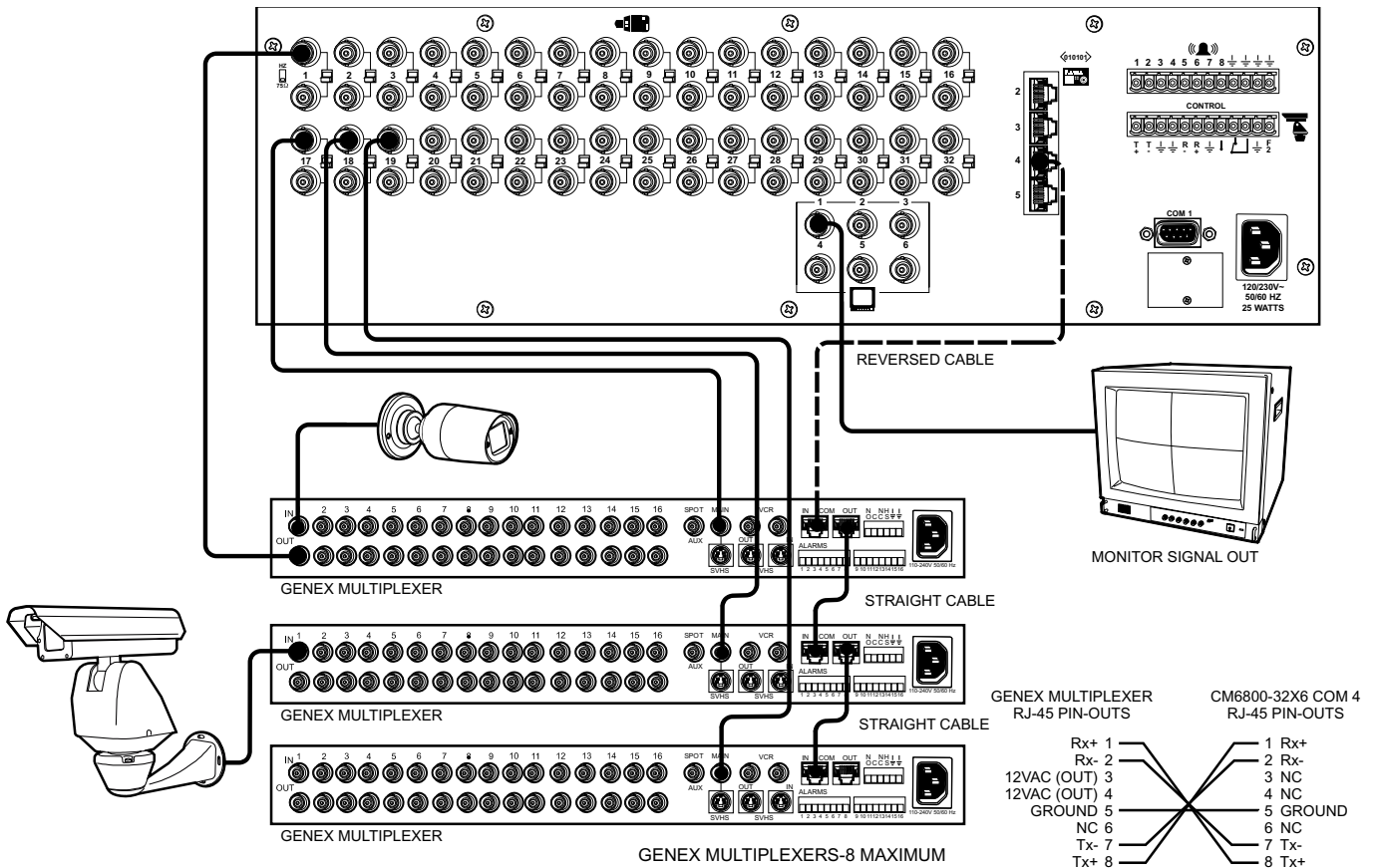

Figure 22. Connecting Genex Multiplexers

## LOCAL AUXILIARIES

The CM6800-32X6 provides two local auxiliary (AUX) outputs on the rear panel for controlling VCRs, printers, and other devices. These outputs can be activated directly from a keyboard by using the F1 and F2 function keys, or they can be activated by an alarm (determined by programming). Both relay contacts and TTL outputs are used.

In addition, you can connect up to two REL2064 Relay Interface Units to the CM6800. Note that since operation of the two internal auxiliary relays on the CM6800-32X6 will also operate the first two relays on the external unit, the maximum capacity of the system may be limited to 128 auxiliaries (depending on how you number the external relays). Refer to the *Connecting a Single REL2064 Relay Interface Unit* section for connection instructions.

### Connecting Relay Contacts – AUX 1

AUX 1 is a dry contact relay output. Terminal connections are provided for both normally open (N.O.) and normally closed (N.C.) contacts.

Refer to Figure 23 for wiring details. Note that this figure shows the wiring for a normally open contact. For a normally closed contact, move the wire from the N.O. terminal to the the N.C. terminal.

Do not exceed the voltage and current ratings for the relay contacts.

You will need to provide an external power source to operate your device. In most cases you will also need an external current limiting resistor. The formula for calculating the resistor value is given in Figure 23.

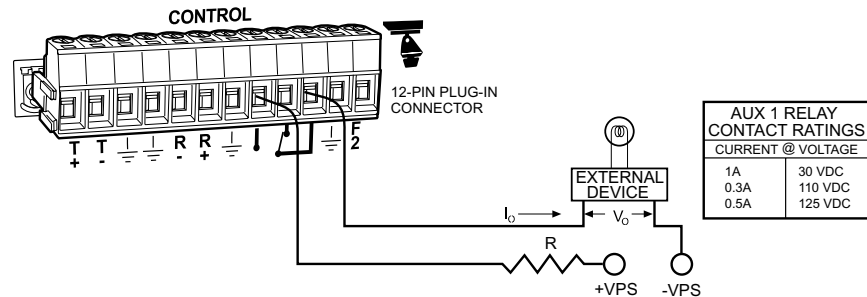

- $I_o$  = OPERATING CURRENT OF THE EXTERNAL DEVICE (MUST NOT EXCEED AUX 1 CURRENT RATING.)  
 $V_o$  = RATED OPERATING VOLTAGE OF THE EXTERNAL DEVICE.  
 $R$  = CURRENT LIMITING RESISTOR.  
 $+VPS$  = VOLTAGE OF THE EXTERNAL POWER SOURCE (MUST NOT EXCEED VOLTAGE RATING FOR THE ASSOCIATED CURRENT). VPS CAN BE AC OR DC.  
 $-VPS$  = NEGATIVE, COMMON OR GROUND TERMINAL OF EXTERNAL POWER SOURCE (AC OR DC).

#### FORMULAS FOR R VALUES

$$R \text{ (OHMS)} = \frac{VPS - V_o}{I_o}$$

$$P \text{ (WATTS)} = (I_o)^2 \times R$$

**Figure 23.** Wiring the AUX 1 (Relay) Output

### Connecting the Open Collector output – F2 (TTL)

F2 is a TTL open collector output. This output provides a path to ground to control the low voltage trigger input on many devices. It can control higher voltage control inputs via isolation relays. Refer to Figure 24 for wiring details.

Do not exceed the voltage and current ratings for the TTL output.

An external pull-up resistor is usually necessary. The formula for calculating the resistor value is given in Figure 24.

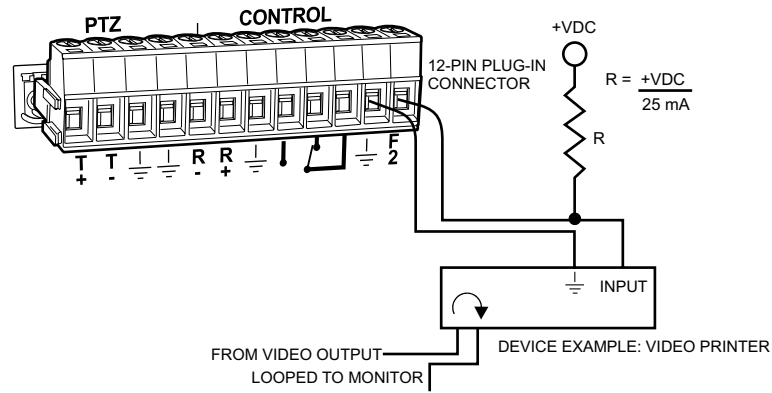

20018

+VDC = VOLTAGE OF THE EXTERNAL POWER SOURCE.

NOTE: +VDC SHOULD BE 5V OR GREATER, BUT NOT EXCEED 15V OR THE MAXIMUM RATED OUTPUT VOLTAGE FOR THE DEVICE INPUT. +VDC CAN ONLY BE DC.

**Figure 24.** Wiring the F2 (TTL) Output

## SYSTEM START-UP

After completing the system installation, follow the procedure below to start proper system operation. Skip any "system-specific" steps that do not apply to your system setup.

### POWER-UP THE SYSTEM

Plug the CM6800 power cord into a 120/230V, 50/60 Hz power source. Plug in and turn on all devices connected to the CM6800.

Once the system is powered-up you will see video from camera 1 and the following time/date stamp on all system monitors:

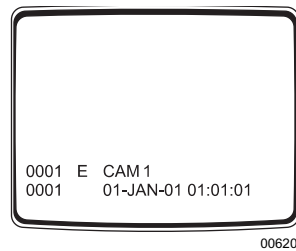

**Figure 25.** CM6800 Time/Date Stamp on Monitor

The time stamp will be advancing in one-second increments. Wait five seconds before proceeding.

### INITIALIZE KEYBOARDS

Specify a monitor for each keyboard after your first power-up or any time power is cycled to the keyboard or the CM6800.

Always allow five seconds to elapse before specifying a monitor.

1. Enter a number corresponding to the monitor output that is feeding the monitor you are viewing.
2. Press the MON key. The keyboard LED displays the number you entered. This also confirms successful communication between the keyboard and the CM6800. If the keyboard LED does not display the monitor number, repeat 1 and 2.

### CONFIGURE THE SYSTEM

The CM6800 is shipped from the factory with default programming settings. If the defaults are acceptable, the CM6800 can be operated without any user programming. However, you may want to program the following basic system settings:

- Time and date.
- Camera titles: by default, each camera is titled "CAM #" (# = camera number).
- Camera video source: Extended Coaxitron protocol receivers can be operated without any programming changes. For other receiver control protocols, access the Camera programming screen to select the control type for the device connected to each video input.
- Alarms: The CM6800 is shipped from the factory with the alarm contact enable field set to OFF. To use the alarm features, access the Alarm programming screens to enable the alarm contact.

In addition, some or all of the following configuration steps may be necessary, depending on your system. Configure the CM6800 through Programming mode. Refer to the *Programming* section for detailed instructions.

## COMMUNICATION PORTS

If you are using any communication port for a device not specified by the default setting, open the Port programming screen to change the settings.

**Table F. Default Port Settings**

Port	Default Settings
COM 1	MGR, RS-232, 56000 baud, no parity, 8 data bits, 1 stop bit
COM 2	ASCII, RS-232, 9600 baud, no parity, 8 data bits, 1 stop bit
COM 3	M, RS-485, 19200 baud, no parity, 8 data bits, 1 stop bit
COM 4	MUX-GENEX, RS-485, 9600 baud, odd parity, 8 data bits, 1 stop bit
COM 5	KBD-300A, RS-485, 9600 baud, odd parity, 8 data bits, 1 stop bit
PTZ (Port 6)	PTZ-P, RS-422, 4800 baud, no parity, 8 data bits, 1 stop bit

### KBD960/KBR960 KEYBOARD

Configure the KBD960/KBR960 settings.

1. Set DIP switch 2 to the ON position.
2. Enter Setup Mode. Set the local address (1-8). (Note: the baud rate is set by default to 19200.) Each M device connected to the CM6800 must have a unique local address. Refer to the KBD960/KBR960 Keyboard Installation/Operation Manual for detailed setup instructions.
3. Return DIP switch 2 to the OFF position.
4. Press the EXIT icon on the keyboard LCD screen.

### GENEX MULTIPLEXER

Access the Camera programming screen and specify MUX control for all cameras connected to the CM6800 through the Genex Multiplexer.

Access the CM6800 Camera programming screen to configure the following camera control options for each camera connected to the CM6800 through the Genex Multiplexer:

- CONTROL: MUX
- PORT ADDRESS: assign the appropriate address. The port address must match the "Unit ID" assigned through the Genex programming screens.

You must also configure the Genex Multiplexer. Refer to the MX4000 Genex Series Simplex and Duplex Multiplexers Installation/Operation Manual for instructions on accessing the Advanced System Setup programming screen. Select the following options:

- SPOT MONITOR DISPLAY: TRACK MAIN
- UNIT ID (must match the port address assigned through the CM6800)
- COMM. TYPE: SLAVE (each multiplexer connected to the CM6800 must be in slave mode)



## MONITOR COLOR ADJUSTMENT:

Once you have connected all devices and powered the system, use the CM6800 color bars as a reference tool for adjusting the color on each monitor.

1. Enter 9999.
2. Press the CAM key. Broadcast quality color bars appear on the monitor.
3. Adjust color on each monitor as necessary until the color bars match the following color order on the monitor (for black and white monitors you can use the color bars to adjust brightness):

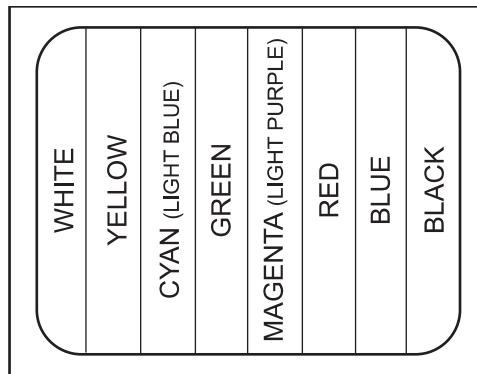

00630

**Figure 26.** CM6800 Color Bars

## PROGRAM PRESETS

Program presets as necessary for your system. Refer to the appropriate keyboard manual for instructions.

## ADDITIONAL PROGRAMMING

Refer to the *Programming* section for complete instructions on programming the CM6800.

## PROGRAMMING THE CM6800

The CM6800 is shipped from the factory with default programming settings. If the defaults are acceptable, the CM6800 can be operated without any user programming. However, you may want to program the following basic system settings:

- Time and date
- Camera titles
- PTZ control via hardwire data connections
- Alarm contacts  
Alarms must be enabled before they are functional.
- Access/Partitioning  
All access is set to YES by factory default.
- Communication ports  
To connect remote keyboards to COM 4 (the alternate connection shown in the Quick Start Guide), change the Port 4 settings.

Pelco provides two options for programming the CM6800 to your specifications:

- Password-protected, on-screen programming screens accessible directly from the Matrix Switcher
- PC-based CM6800-MGR software

Refer to the CM6800-MGR Quick Start Guide for instructions on accessing and using this software to program your system.





---

**NOTE:** Pelco strongly recommends uploading your programming settings to the CM6800-MGR to save settings in the event of an accidental reset.

---

The CM6800 allows system programming from only one monitor at a time. If programming from the CM6800-MGR is sent to the CM6800 at the same time that you are programming from a monitor screen, the system will exit the on-screen programming function.

## CM6800 PROGRAMMING MODE

1. If you have not already done so, select the monitor (KBD960/KBR960: if the Camera menu appears, press  to exit).
2. Press the PGM key or select  on the KBD960/KBR960). The Password screen appears.  
Note that on the KBD960/KBR960, you must first select  and . Then enter the Define PIN (Default: 1234), and select .

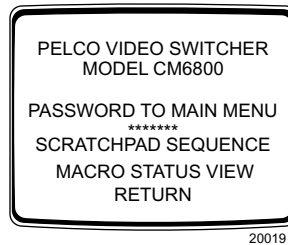

Figure 27. CM6800 Password Screen

3. At the \*\*\*\*\* prompt, enter the DEFAULT PASSWORD: 2899100

The Main Menu appears.

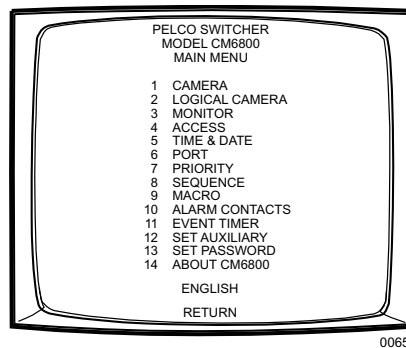



Figure 28. CM6800 Programming Main Menu

### Select Language

If necessary, select the appropriate language.

















1. Navigate to the language displayed below the menu options.
2. Scroll through the languages and select the language appropriate for your system.
3. Navigate to the RETURN field and navigate left or right to return to the Main Menu.





## Exit Programming Mode

KBD100/200A/300A Keyboards	KBD960/KBR960 Keyboards
<p>To return to active video you can:</p> <ul style="list-style-type: none"> <li>• Press the PGM key once while in the Main Menu.</li> <li>• Press the PGM key twice from anywhere else in the programming screens.</li> <li>• Navigate to the RETURN field and navigate left or right to return to the previous screen or menu.</li> </ul>	<p>To return to active video you can:</p> <ul style="list-style-type: none"> <li>• Select  once while in the Main Menu.</li> <li>• Select  twice from anywhere else in the programming screens.</li> <li>• Navigate to the RETURN field and navigate left or right to return to the previous screen or menu.</li> </ul>

## NAVIGATE AND SELECT OPTIONS/FIELD ENTRIES IN PROGRAMMING MODE

During programming, a menu appears on the monitor screen. The currently selected field blinks. Use the following keys or joystick on your keyboard to navigate the programming screens.

Function	Keyboard
<p>Navigate programming screens.</p>	<p><b>KBD100</b> Use the sequence and macro keys.</p> <p>Left      Right      Up      Down              </p> <p><b>KBD200A</b> Use the Pan/Tilt positioning keys.</p> <p>Left      Right      Up      Down              </p> <p><b>KBD300A</b> Use the joystick.</p> <p>Left      Right      Up      Down              </p> <p><b>KBD960/KBR960</b> Use the joystick. (See above icons) <b>OR</b> Select the appropriate icon on the KBD960/KBR960 LCD SCREEN.</p> <p>Left      Right      Up      Down              </p>
<p>Access a screen from the Main Menu (or from a submenu).</p>	<p><b>All Keyboards</b></p> <ol style="list-style-type: none"> <li>1. Navigate down to the desired menu option.</li> <li>2. Navigate left or right to select the menu option.</li> </ol> <p><b>OR</b></p> <ol style="list-style-type: none"> <li>1. Using the numerical keypad, enter the number of the menu option.</li> <li>2. Press F1 on the KBD100/200A/300A keyboard or select  on the KBD960/KBR960 keyboard.</li> </ol>

Function	Keyboard
Scroll through options in programming fields.	<p data-bbox="906 191 1084 216"><b>KBD100/200A/300A</b></p> <p data-bbox="906 222 1438 279">Use F1 and F2. Or (KBD300A only) use the joystick to navigate left or right.</p> <div data-bbox="1101 296 1260 352" style="text-align: center;">   <p data-bbox="1117 338 1138 352">F1</p> <p data-bbox="1222 338 1243 352">F2</p> </div> <p data-bbox="906 375 1382 401"><b>NOTE:</b> The joystick does not scroll options in all fields.</p> <p data-bbox="906 432 1060 457"><b>KBD960/KBR960</b></p> <p data-bbox="906 470 1451 527">Select the  or  icons or use the joystick to navigate left or right.</p> <p data-bbox="906 548 1382 573"><b>NOTE:</b> The joystick does not scroll options in all fields.</p>
Select option in a programming field.	<p data-bbox="906 606 1040 632"><b>All keyboards</b></p> <ol data-bbox="906 638 1398 730" style="list-style-type: none"> <li>1. Scroll through the options until the appropriate entry appears in the field.</li> <li>2. Navigate to the next field or press PGM to exit.</li> </ol> <p data-bbox="906 741 1409 825"><b>NOTE:</b> On the Monitor and Time &amp; Date screens you must apply the changes (refer to <i>Time &amp; Date</i> or <i>Monitor</i> in this section).</p>
Enter a numerical value in an option field (not available in all fields).	<p data-bbox="906 858 1040 884"><b>All keyboards</b></p> <ol data-bbox="906 890 1446 1052" style="list-style-type: none"> <li>1. Using the numerical keypad, enter a number within the range of valid options (example: to enter an internal alarm contact you must enter a number between 1 and 8).</li> <li>2. Press F1 on the KBD100/200A/300A keyboard or select  on the KBD960/KBR960 keyboard.</li> </ol>
Access the HELP screen (Sequences, Macros, and Alarm Group screens).	<p data-bbox="906 1079 1040 1104"><b>All keyboards</b></p> <ol data-bbox="906 1110 1174 1173" style="list-style-type: none"> <li>1. Navigate to the HELP field.</li> <li>2. Press F1.</li> </ol>
Access the NEXT or PREVIOUS page of a list (not available on every screen).	<p data-bbox="906 1209 1040 1234"><b>All keyboards</b></p> <ol data-bbox="906 1241 1295 1304" style="list-style-type: none"> <li>1. Navigate to the NEXT or PREVIOUS field.</li> <li>2. Press F1.</li> </ol>
Exit a screen.	<p data-bbox="906 1339 1040 1365"><b>All keyboards</b></p> <ol data-bbox="906 1371 1203 1434" style="list-style-type: none"> <li>1. Navigate to the RETURN field.</li> <li>2. Navigate left or right.</li> </ol> <p data-bbox="906 1444 935 1470"><b>OR</b></p> <p data-bbox="906 1476 1430 1501">Press the PGM key to return to the previous screen or menu.</p>

# ACCESS

The CM6800 supports the following system partitioning to control switching system access:

Keyboard to Monitor: Restrict a keyboard from accessing selected monitors.

Camera to Keyboard: Restrict a keyboard from calling selected cameras to monitors. Or video viewing only; permit the viewing of selected cameras while preventing pan and tilt control.

Camera to Monitor: Restrict the viewing of selected cameras on selected monitors.

All system access is set to YES by default.

**NOTE:** To restrict access for keyboards, all keyboard addresses must be within a range from 1-8.

**NOTE:** If you connect an ASCII keyboard/device to the CM6800 (COM port 1, 2, or 4), you can connect only one keyboard to a port. Specify access in the first column only (address 1).

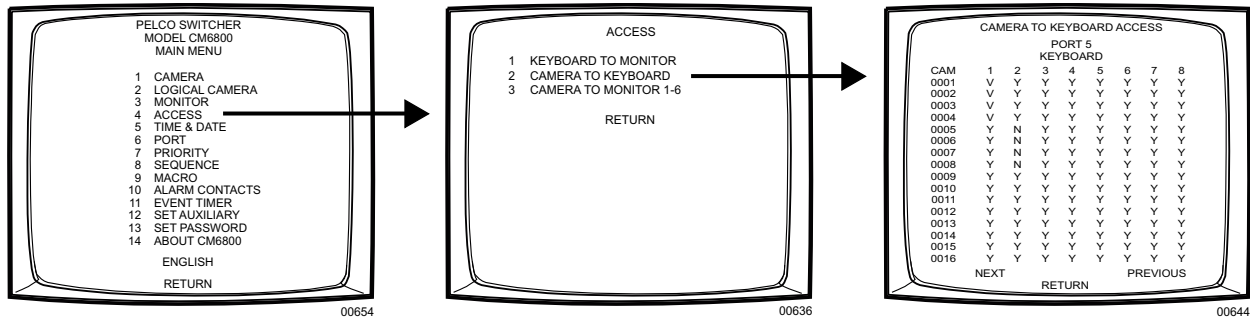

Figure 29. Sample Access Screen

1. Select the COM port number for which you are programming access control.
2. In the Access matrix, configure the specific access allowed for each device.

### Keyboard to Monitor

In each monitor row specify the access allowed for each keyboard to control each specific monitor.

Y = Yes; control is allowed

N = No; control is not allowed

### Camera to Keyboard

In each camera row specify the access allowed for each keyboard to view and control the specific logical camera number.

Y = Yes; viewing and control is allowed

N = No; viewing and control is not allowed

V = View only; camera can be viewed but not controlled

### Camera to Monitor

In each camera row specify the access allowed for each monitor to display the specific logical camera number.

Y = Yes; camera can be viewed

N = No; camera cannot be viewed

## ALARM PROGRAMMING

Alarmed cameras can be displayed on one or several monitors as part of one or several alarm groups (each monitor can display only one alarm group.)

Before programming alarm settings note the following precautions:

- Verify that no automated system functions are set to run, such as a macro that would arm or disarm an alarm.
- Ensure that system operators do not arm or disarm any alarms while you are programming alarm settings.

**NOTE:** You cannot access the Alarm Contacts screen when an alarm is active. If an alarm is triggered while you are in the CM6800 programming screens, the system will exit the on-screen programming function and display the alarm on the appropriate monitor(s).

Complete the following steps to program alarms:

1. Program the alarm display format for each alarm group. An alarm can include up to eight steps, so eight camera views could display as a part of each alarm. Refer to *Program Alarm Groups*.
2. Program the individual alarm contact. Refer to *Program an Internal or External Alarm Contact*.

### PROGRAM ALARM GROUPS

Use the Alarm Group screen to configure alarm groups to appear on system monitors. To display on a monitor, an alarm must be assigned to an alarm group.

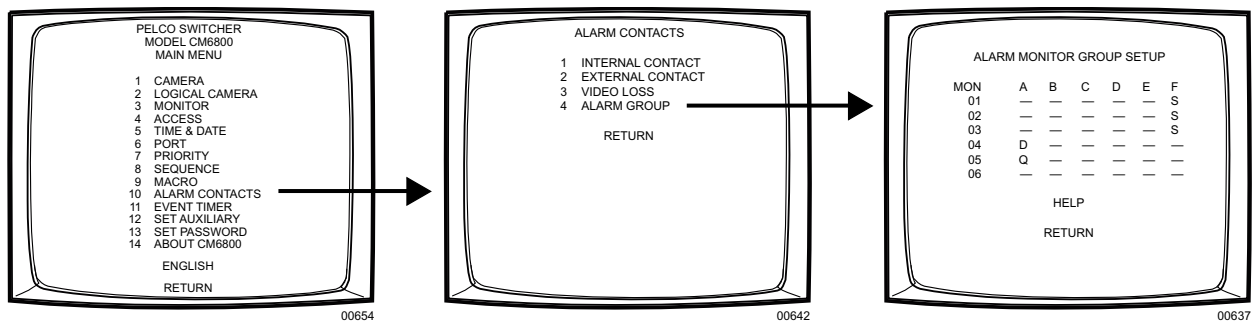

Figure 30. Program Alarm Groups

Specify the display option for up to six alarm groups. Refer to the on-screen Help or to the Alarm Group Display Options in the *Appendix* for a description of each display option.

Display Option Entry	Display Option Type	Number of Monitors Displaying Each Alarm Group
B	Block build	Up to six
D and Q	Chronological pair	One display monitor (D), one queue monitor (Q)
M and L	Reverse chronological pair	One display monitor (M), one queue monitor (L)
S	Salvo group	From two to six

## INTERNAL AND EXTERNAL ALARMS

Use the Alarm Contact screens to configure alarm inputs. When an alarm is triggered, the alarm icon and the alarm letter ("I" for internal; "E" for external) appear on monitors programmed through the Alarm Group screen to display the alarm.

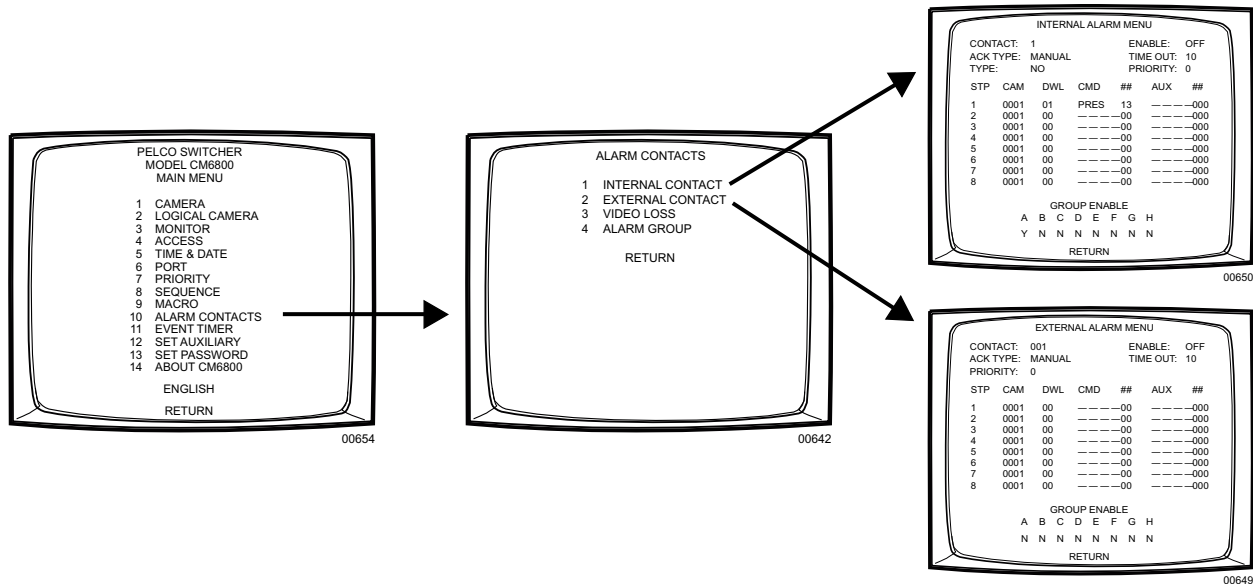

**Figure 31.** Program an Internal or External Alarm

1. Select the alarm input number in the CONTACT field.

Internal Alarm screen: Configure any of the eight internal alarm inputs on the CM6800 rear panel. Internal inputs are programmable to associate any camera to any input.

External Alarm screen: Configure any of the external alarms. A maximum of two external ALM2064 Alarm Interface Units can be connected to the CM6800-32X6, providing up to 128 external alarm inputs.

2. Select ON in the ENABLE field.
3. In the STP matrix, configure up to eight steps to be triggered as a result of this alarm.
  - a. In the CAM field select a camera (use the logical camera number) to be displayed on a system monitor.
  - b. In the DWL field, enter the amount of time the camera view is displayed in an alarm sequence; enter a dwell time between 1 and 99 seconds.
  - c. Optional:

In the CMD field, select a camera operation; if you select a macro, pattern, or preset, enter a valid macro, pattern, or preset number in the ## field:

MACRO = macro (only the first three steps can be used when selecting a macro; each step must call a macro)

PRES = preset

PATT = pattern

RSCN = random scan

FSCN = frame scan

SSCN = stop scan



In the AUX field, select an auxiliary to be activated.

GON = turn global auxiliary on  
GOFF = turn global auxiliary off  
CON = turn camera auxiliary on  
COFF = turn camera auxiliary off

---

**NOTE:** Activate the auxiliaries on the rear panel of the CM6800 by selecting global auxiliary numbers 1 or 2. The remaining global auxiliary numbers control auxiliaries in up to two REL2064 Relay Interface Units.

---

4. In the GROUP ENABLE field, select 0Y0 under the appropriate group letter to assign the alarm contact to one or more alarm groups. Refer to the Program Alarm Groups section for information on alarm group display options.

---

**NOTE:** Verify that the monitor specified by the alarm group has access to the camera view(s) triggered by this alarm. If an alarm is cued to a monitor that does not have access to the appropriate cameras, the camera views cannot be monitored.

---

5. **Optional:** The remaining alarm contact fields are configured with factory default settings; customize your system as necessary, by changing the following settings:

ACK TYPE: The alarm clearance type is set to MANUAL by default, requiring an operator to acknowledge an alarm from a system keyboard. If you select AUTO, the alarm will time out automatically after the interval specified in the TIME OUT field.

TYPE: Internal alarms are set by factory default as N.O. (normally open). Select N.C. for normally closed operation. Set the external alarm input type through the ALM2064 Alarm Interface Unit.

PRIORITY: Select 1 for a priority alarm, which appears on system monitors before a non-priority (0) alarm.

## PROGRAM A VIDEO LOSS ALARM

Use the Video Loss screen to program the CM6800 to detect video loss from any camera input and indicate the loss through alarm mode – the logical alarm number, the alarm icon and a “V” (for video loss) appear on system monitors as specified by alarm group assignment.

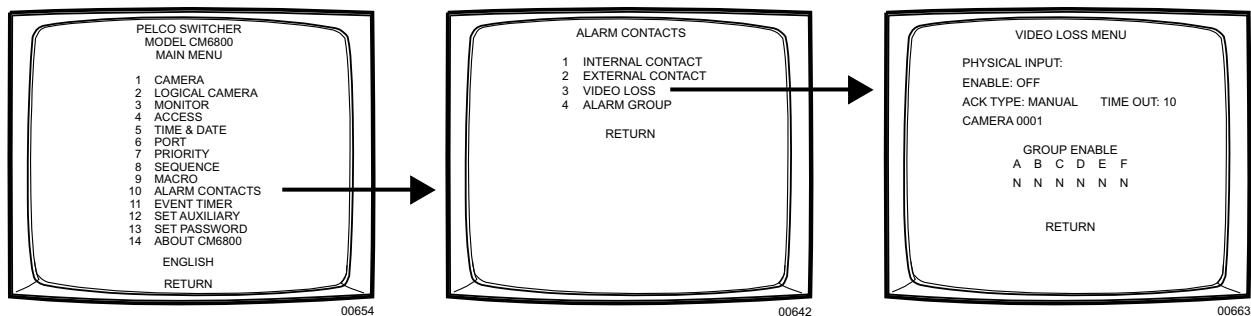

**Figure 32.** Program Video Loss Alarms

1. Select the PHYSICAL INPUT number; the logical camera number associated with the physical input appears in the CAMERA field.
2. Select ON in the ENABLE field.
3. In the GROUP ENABLE field, select “Y” under the appropriate group letter to assign the alarm contact to one or more alarm groups. Refer to the *Program Alarm Groups* section for information on alarm group display options.
4. **Optional:** The ACK TYPE (alarm clearance type) field is set to MANUAL by default, requiring an operator to acknowledge a video loss alarm from a system keyboard. If you select AUTO, the alarm will time out automatically after the interval specified in the TIME OUT field.

## AUXILIARY OUTPUTS

The two local auxiliary (AUX) outputs on the rear panel of the CM6800-32X6 can be operated manually from a system keyboard or automatically in response to an alarm.

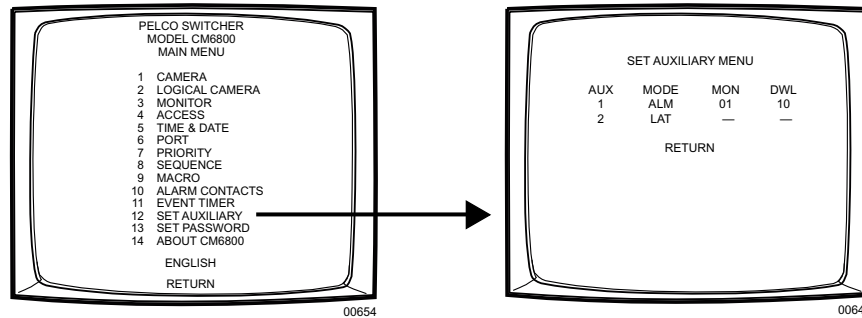

Figure 33. Program Auxiliary Outputs

### Latching or Momentary Operation

In the MODE field for each auxiliary, select either LAT or MOM.

### Alarm-based Operation

1. In the MODE field for each auxiliary, select ALM.
2. In the MON field, select the monitor the auxiliary will follow.
3. In the DWL field, enter the number of seconds the auxiliary will remain active after there is no longer an alarm displayed on a system monitor. The alarm is displayed on a monitor until
  - the alarm is acknowledged manually (if MANUAL is selected in the alarm contact ACK TYPE field),
  - the alarm contact times out (if AUTO is selected in the alarm contact ACK TYPE field).

Refer to the ACK TYPE description in *Program an Internal or External Alarm Contact*.

## CAMERA PROGRAMMING

Extended Coaxitron protocol receivers can be operated without any programming changes, other than changing the camera title, if necessary. For other receiver control protocols, you must select the control type for the device connected to each video input.

If necessary, first program logical camera number.

### PROGRAM LOGICAL NUMBERS

Default logical numbers start at 0001 and continue sequentially to 0032. To use a different numbering scheme, program new numbers on the Logical Camera Number screen.

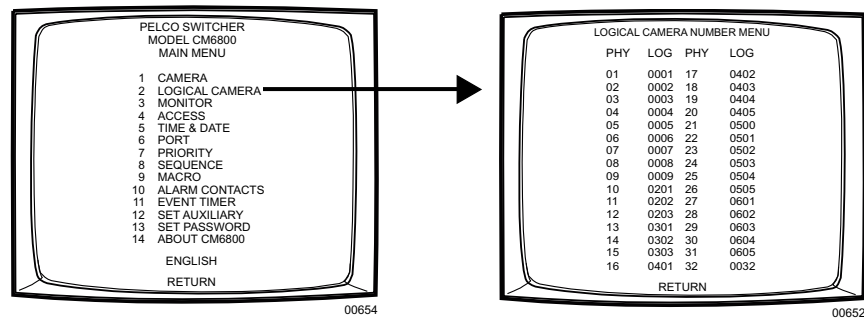

**Figure 34.** Program Logical Camera Numbers

The numbers in the PHY columns are the physical input numbers; each represents an actual BNC input on the rear panel of the CM6800 and cannot be changed.

In the LOG field for each physical camera input, assign a valid logical number (0001-9998). A valid number is any number from 0001 to 9998 that has not already been assigned to a physical camera input.

---

**NOTE:** If you change a logical number, you cannot control the camera until you select the new logical number from the keyboard.

---

## PROGRAM CAMERAS

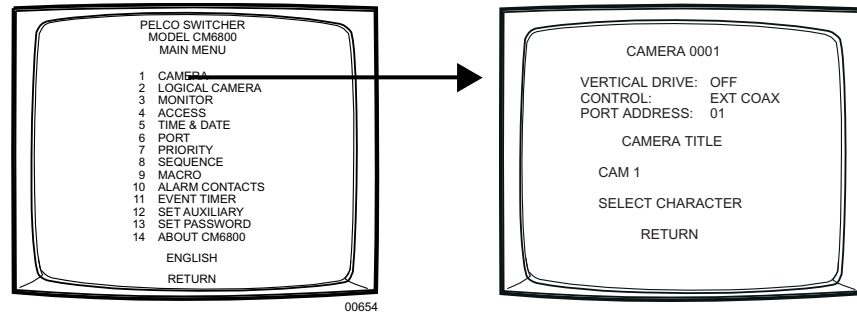

Figure 35. Program Cameras

1. In the CAMERA field, select the logical camera number of the video input to be defined.
2. In the CONTROL field, select the receiver control type.

EXT COAX: Coaxitron extended mode (32-bit)

STD COAX: Coaxitron standard mode (15-bit)

MUX: Genex multiplexer

PTZ-A: RS-422 Control Port A

M-02: Reserved for future use

M-08: Reserved for future use

---

**NOTE:** If you select PTZ-A you must also program Serial Port 6 (refer to Ports in this section).

---

3. The PORT ADDRESS field is required for Genex or RS-422 control only.

**Genex multiplexer:** Select the address of the multiplexer (01-32); this address must match the unit ID specified through multiplexer programming. Refer to the MX4000 Genex Series Simplex and Duplex Multiplexers Installation/Operation Manual.

**RS-422 cameras:** Select the camera/device address for RS-422 control (01-32). The port address must match the address setting configured through the camera/receiver DIP switch settings.

4. Select the camera title. This title (up to 20 characters) appears on the monitor during real-time camera display.
  - a. Navigate to the position in the camera title that you want to change.
  - b. Use F1 and F2 to scroll through the camera title characters; once you reach the desired character for that position, navigate to the next position.

The default title characters are 26 upper case letters and the numbers 0-9. You can add special characters through the Select Characters screen (described below), or through the CM6800-MGR.

**Select Character:**

- a. Navigate to the SELECT CHARACTER field and navigate left or right. The Select Character screen appears.
- b. To select a character for the first position in the camera title, navigate to the desired character in the font table, and then press F1.

The designated character is displayed in the first position, and the POSITION field increments to position number 02.

**Optional:** Navigate to the POSITION field and use F1 and F2 to scroll through the camera title position numbers.

- c. Navigate to the desired character in the font table for the next position, and then press F1. Continue until the camera title is complete.

---

**NOTE:** You must also configure the camera/receiver. Refer to the appropriate camera/receiver installation manual.

---

### **Program Vertical Drive Option (Optional)**

Select ON in the VERTICAL DRIVE field to provide the camera with a synchronization pulse via the coax cable.

---

**NOTE:** You can use the vertical drive option with any Pelco camera that supports the Pelco V-Sync feature.

---

## EVENT TIMERS

You can automate system operation to activate sequences or macros on specific monitors. Events can be scheduled on a daily or weekly basis, or on a specific date such as a holiday. If you set more than one timer to start at the same time, the timers will run in the following order of precedence: weekly, special, daily.

On each event timer screen:

- Two methods are provided for selecting the event time: scrolling through time values or entering a valid hour and minute.
- Each timer can activate either a macro or a sequence. Select a value for either the MACRO field or the SEQ field.
- A macro started by an event timer runs until the last step is completed (unless you specify a loop in the macro).
- A sequence started by an event timer runs continuously until another sequence or macro begins, or until a system operator selects a different camera.

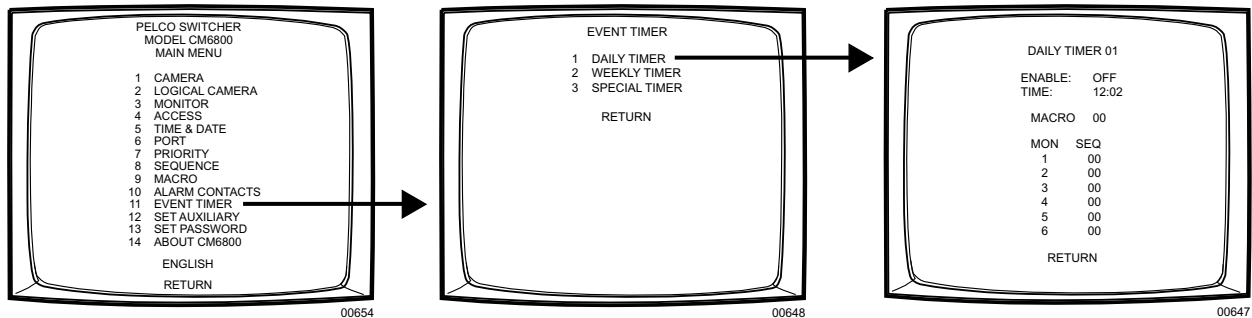

**Figure 36.** Sample Event Timer Programming

1. Select the timer number.
2. Select ON in the ENABLE field.
3. Set the hour and minute at which the event is to begin (24-hour time) in the TIME field.
4. Special timers only: select the date on which the event is to begin (DD-MM-YY).
5. Select the event to be activated by the event timer.

To select a macro, select a macro number. For a weekly timer specify the macro in the column under the desired day of the week.

To select a sequence, select a sequence number to run on a specific monitor. For a weekly timer specify the sequence in the column under the desired day of the week

## MACRO

Macros simplify operator control by grouping multiple functions into a single command.

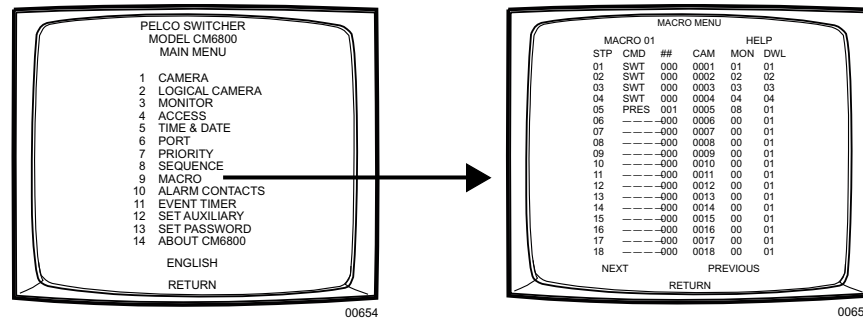

**Figure 37.** Access the Macro Screen

**MACRO:** Select the macro number you want to program.

**STP:** Each macro can include up to 72 steps. For each step select entries for the following fields as necessary:

**CMD:** Select a command. In addition, enter a valid number in the specified additional field(s); for example, if you select PATT, enter a pattern number in the Command # field, a camera number in the Camera field, and a monitor number in the Monitor field.

Refer to Table H in the *Appendix* for a description of each command and the additional fields required for each command.

**##:** If applicable, enter a valid number associated with the command selected.

**CAM:** If applicable, enter a logical camera number. To select logical numbers other than the default numbers (1 to 32), you must first program the logical numbering in the Logical Camera window. Refer to the *Logical Camera Numbers* section.

**MON:** If applicable, enter a monitor number.

**DWL:** If desired, enter a dwell time (1-99 seconds); the dwell time is the period the macro halts before continuing to the next step. The default dwell time is two seconds.

## MACRO STATUS VIEW SCREEN

The Macro Status View screen provides a status view of each system macro (1-32). For each active macro the current status (RUN or HOLD) and the number of the next macro step is displayed. If a macro is not running, the status is IDLE and the step number is 00.

A system operator can display the Macro Status View screen without entering password-protected programming screens.

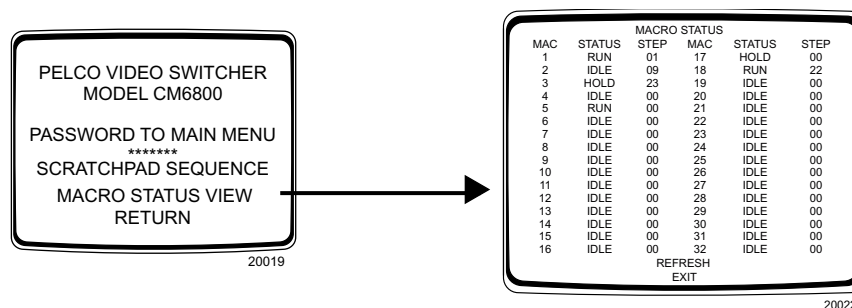

**Figure 38.** Macro Status View Screen

## MONITOR DISPLAY

Use the Monitor screen to adjust monitor display settings for your system. You can adjust settings for the current monitor only (CURRENT) or for all system monitors (ALL).

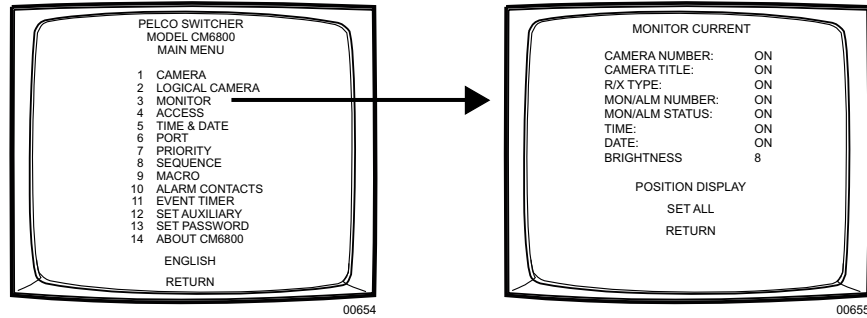
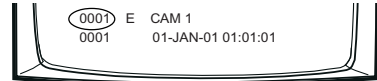

**Figure 39.** Access the Monitor Screen

**MONITOR:** Select CURRENT to program the monitor display for the monitor you are currently operating or ALL for all monitors connected to the CM6800.

If you select ALL, you must navigate left or right in the SET ALL field to apply programming changes (refer to the SET ALL field description).

**CAMERA NUMBER:** Enable (ON) or disable (OFF) on-screen display of the logical camera number.



**CAMERA TITLE:** Enable (ON) or disable (OFF) on-screen display of the camera title (maximum of 20 alphanumeric characters).

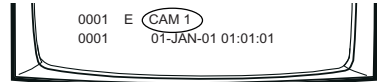

**R/X TYPE:** Enable (ON) or disable (OFF) on-screen display of the camera control type. The letter displayed on the monitor reflects the receiver control type selected in the CONTROL field on the Camera screen.

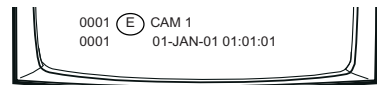

### R/X TYPE DISPLAY VALUES:

E = Coaxitron extended mode (32-bit)

S = Coaxitron standard mode (15-bit)

M = Genex multiplexer

P = PTZ-P (RS-422 through Control Port PTZ-A)

D = PTZ-D (RS-422 through Control Port PTZ-A)

**MON/ALM NUMBER:** Enable (ON) or disable (OFF) on-screen display of the monitor/ alarm number. During normal operation, the monitor number appears in this field. The monitor number is a fixed number, representing an actual BNC output on the rear panel of the CM6800. When an alarm is active, the alarm number appears in this field. The alarm number is either the physical alarm input number of an internal alarm contact, or the address of an external alarm contact as configured on the Alarm Interface Unit.

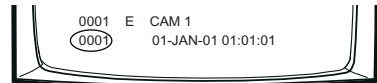



MON/ALM STATUS: Enable (ON) or disable (OFF) on-screen display of the monitor or alarm status.

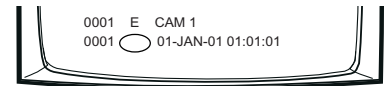

MONITOR STATUS DISPLAY VALUES:

Blank = normal status

H = hold

S = sequence

---

**NOTE:** If an operator presses the HOLD key while an alarm appears on the monitor, the H does not appear. The alarm icon and alarm status value blink to indicate the HOLD status.

---

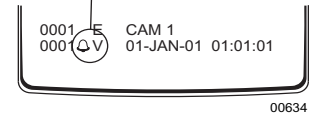

ALM STATUS DISPLAY VALUES:

I = internal alarm

E = external alarm

V = video loss alarm

TIME: Enable (ON) or disable (OFF) on-screen display of the time as programmed in the system.

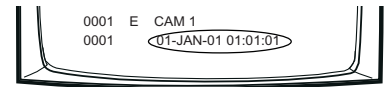

DATE: Enable (ON) or disable (OFF) on-screen display of the date as programmed in the system.

BRIGHTNESS: Select the brightness level of the on-screen display (1-8; 8 = white characters, 1 = black characters; 2-7 = shades of gray).

If you select CURRENT in the MONITOR field, you can see the brightness level change as you scroll through the options.

If you select ALL in the MONITOR field, the changes do not take effect until you apply changes in the SET ALL field.

POSITION DISPLAY: Navigate left or right to select the Test Positioning Menu.

The real-time camera display appears with Test Positioning Menu text superimposed on the screen. Use the position keys or joystick to move the text to the desired position on the screen. The text moves one line or character position at a time.



Press the PGM key to exit the test positioning menu.

SET ALL: To apply monitor display changes to all system monitors (if you selected ALL in the MONITOR field) you must navigate left or right in the SET ALL field; otherwise monitor display settings are not changed.

If you selected CURRENT in the MONITOR field, navigating left or right in the SET ALL field has no effect.

## PASSWORD

Use the Set Password screen to change the system password.

If you change the password and then forget the new one, you will have to reset the system to the factory defaults. All system programming will be lost. Pelco recommends uploading your programming settings to the CM6800-MGR before changing the password. This allows you to download the previous system settings, in the event of a system reset. If necessary, refer to the *Troubleshooting* section for the system reset procedure.

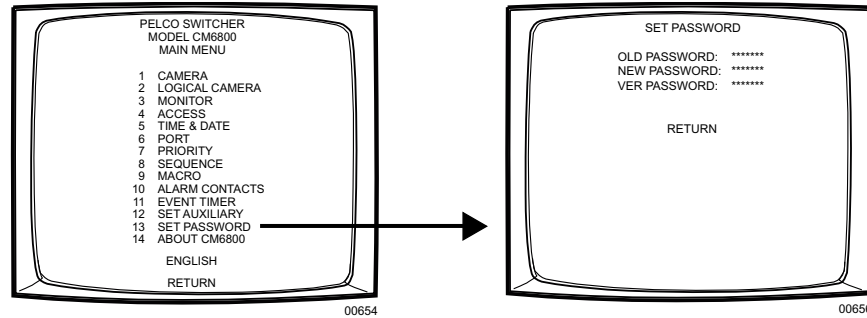

**Figure 40.** Access the Set Password Screen

Use the numerical keypad to enter the old and new passwords. The password must be seven digits.

1. Enter the current password (Default: 2899100).
2. Enter the new password.
3. Enter the new password again as a verification check.

Once the new password is accepted, the Main Menu appears.

## PORTS (SERIAL/COM PORTS)

Use the Port screen to configure the settings for each device connected to a Serial/COM port on the rear panel of the CM6800.

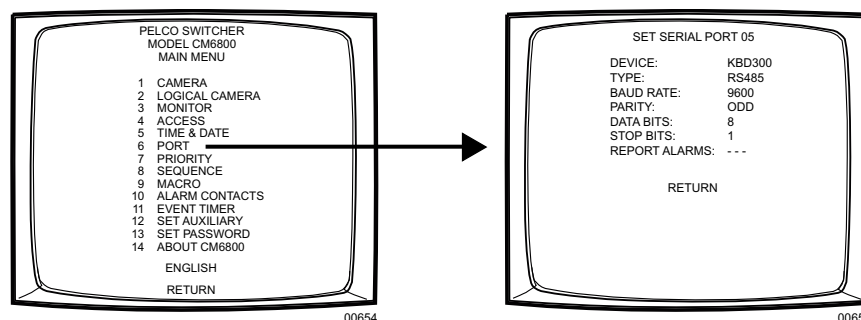

**Figure 41.** Access the Port Screen

1. Select the number of the desired Serial Port/COM port (01-06). The serial port numbers correspond to the communication ports on the CM6800-32X6 rear panel as follows:

Serial Port	Input on CM6800-32X6 rear panel
01	COM 1 DB9 input
02-05	COM 2-5 RJ-45 inputs
06	PTZ control input

2. Select the device connected to the COM port; the values in the TYPE, BAUD RATE, PARITY, DATA BITS, and STOP BITS fields change to the settings appropriate for the specific device.

---

**NOTE:** "KBD300" is used to refer to the KBD100, KBD200A, and KBD300A keyboards.

---

3. Optional: Some device options allow a choice of communication type, baud rate, and/or parity rate. If this is the case, select the desired settings.
4. Optional: If you select an ASCII device you can select ON in the Report Alarm field to set the CM6800 to report alarms to that device. The CM6800 reports the following alarm information:

Action	ASCII text
An alarm is triggered	#Ea
An alarm is cleared	#Ia
An alarm is acknowledged	#Ka

---

**NOTE:** The CM6800-32X6 reports the physical alarm number. If you use the eight internal alarm inputs on the rear panel, do not use the first eight inputs on any external alarm interface units (ALM2064), or you will have a numbering conflict.

---

## PRIORITY

The CM6800 provides eight levels of priority control. Each level defines the ability of a keyboard to control a pan/tilt/zoom (camera positioning system) and to access programming screens.

Priority level applies system wide; a keyboard assigned priority level 2 on COM port 5 has a higher priority than a keyboard assigned priority level 4 on COM port 4. A higher level keyboard takes precedence over a lower level keyboard when the keyboards are issuing control commands.

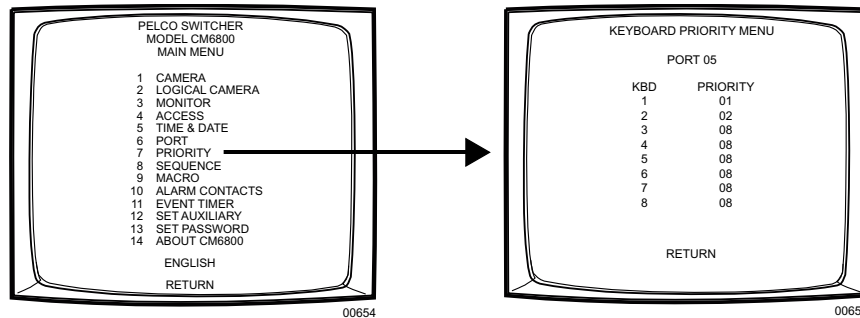

Figure 42. Access the Priority Screen

**PORT:** Select the COM port number for which you are programming priority control.

**PRIORITY:** For each keyboard connected to the specified port, assign a priority level (01-08).

**OPTIONS:**

Level 1 = highest priority

Level 8 = lowest priority

Levels 1 - 3 have the ability to access programming screens. Levels 4-8 cannot access programming screens. The lowest level or keyboards located at the same level will access devices on first-come, first-served basis.

---

**NOTE:** If you connect an ASCII keyboard/device to the CM6800 (COM port 1, 2, or 4), you can connect only one keyboard to a port. For ASCII keyboards, priority control is based on the entry for keyboard 1.

---

## SEQUENCE

The CM6800 provides two types of sequences:

- An operator can program a **scratchpad sequence** from an individual monitor, without accessing password-protected programming screens.
- **System sequences** are password-protected and can run on any system monitor.

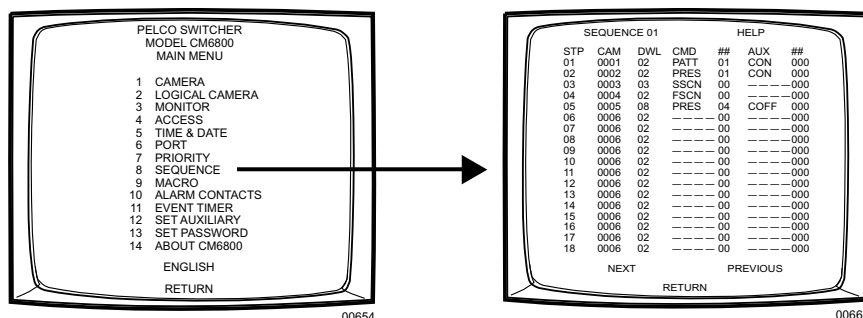
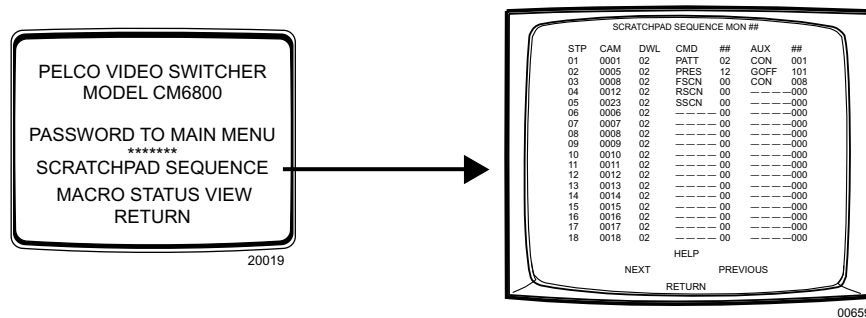

Figure 43. Sequence Screen



**Figure 44.** Scratchpad Sequence Screen

SEQUENCE: Select the sequence number you want to program.

STP: Each sequence can include up to 72 steps. For each step select entries for the following fields as necessary:

CAM: Enter the desired camera number (logical number).

DWL: Enter the dwell time (01-99 seconds).

CMD and ##: Select a command; if you select a pattern or a preset enter a valid pattern or preset number.

OPTIONS:

- PATT = pattern
- PRES = preset
- RSCN = random scan
- FSCN = frame scan
- SSCN = stop scan

AUX and ##: Select an auxiliary to be activated.  
Global = internal and external auxiliaries.

OPTIONS:

- GON = turn global auxiliary on
- GOFF = turn global auxiliary off
- CON = turn camera auxiliary on
- COFF = turn camera auxiliary off

---

**NOTE:** Activate the auxiliaries on the rear panel of the CM6800 by selecting global auxiliary numbers 1 or 2. The remaining global auxiliary numbers control REL2064 Relay Interface Unit auxiliaries.

---

## TIME AND DATE

Use the Time and Date screen to set the system time and date settings. The time and date displayed on the monitor during real-time camera display is the time set in the memory through this screen. The system time and date information is kept current in battery-backed RAM. New time and date information will be set when you apply the changes (refer to the SET TIME & DATE field description).

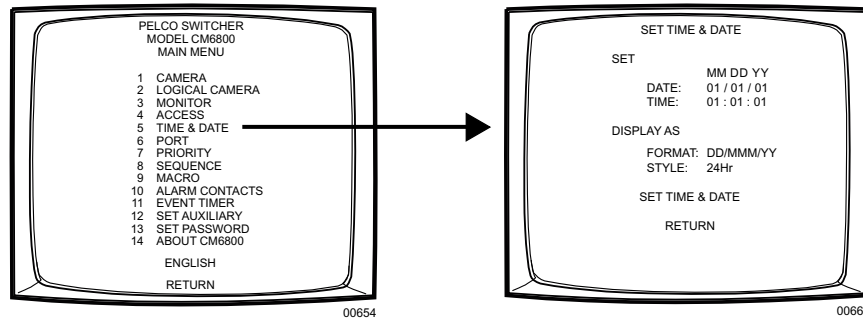

**Figure 45.** Access the Time and Date Screen

1. Select or enter the month, day, and year of the desired system date.
2. Select or enter the hour, minute, and second of the desired system time.
3. Select the on-screen date format.

OPTIONS:  
DD/MMM/YY  
MMM/DD/YY  
YY/MMM/DD  
DD/MM/YY  
MM/DD/YY  
YY/MM/DD

4. Select the on-screen time format. This setting affects the on-screen time displayed on system monitors only. System functions programmed through the event timers (refer to Event Timers in this section) are based on 24-hour time settings.

OPTIONS:  
24Hr  
AM/PM (12 Hr)

5. Navigate left or right in the SET TIME & DATE field to apply the changes.

## PATTERNS, PRESETS, AND ZONES

Special characters added through the CM6800-MGR may not be available with your camera positioning system. Preset, pattern, and zone labels containing special characters will appear on the monitor with blanks in place of the special characters.

Refer to the Operation section for instructions on creating patterns. Refer to your keyboard manual for instructions on programming presets and zones.

# OPERATION

## OVERVIEW

A brief description of CM6800 operation is provided here. Refer to the following sections for detailed instructions and options.

Install the CM6800E and connect all system devices.	Refer to the <i>Installation</i> section.
Power-up the system.	Refer to the <i>System Start-up</i> section.
Switch monitor.	<ol style="list-style-type: none"><li>1. Enter the monitor number.</li><li>2. Press the MON key.</li></ol>
Select camera.	<ol style="list-style-type: none"><li>1. Enter the camera number.</li><li>2. Press the CAM key.</li></ol>
Control PTZ receivers.	Use the appropriate PTZ control keys or joystick (depending on the keyboard used).  Extended Coaxitron protocol receivers can be operated without any programming changes. Other receiver control protocols require programming changes.
Call a preset.	Program the preset through the keyboard. <ol style="list-style-type: none"><li>1. Enter the preset number.</li><li>2. Press the PRESET key or Prst/Lock key (depending on the keyboard used).</li></ol>
System does not function.	Refer to the Troubleshooting section.

## OPERATING THE CM6800

The CM6800 can be operated with a KBD100, KBD200A, KBD300A, KBD960, or KBR960 keyboard. Operation instructions are provided below, but you should become familiar with the detailed instructions provided in the appropriate keyboard manual.

The CM6800 can also be controlled with ASCII commands. Refer to the *ASCII Operating Commands* section.



### SWITCH MONITORS

If you select a restricted monitor, the monitor does not switch; the keyboard LED displays the previously selected monitor number.

<b>ALL KEYBOARDS</b>
<ol style="list-style-type: none"><li>1. Enter the monitor number.</li><li>2. Press the MON key. The keyboard LED displays the selected monitor number.</li></ol>

## SELECT CAMERAS

If you select a restricted camera view, the camera view does not appear on that monitor. The previously selected, unrestricted camera view remains on the monitor.

KBD100/200A/300A KEYBOARDS	KBD960/KBR960 KEYBOARDS
1. Enter the camera number. 2. Press the CAM key.  OR  Press the BWD or FWD key to scroll through the available cameras.	1. Enter the camera number. 2. Press the CAM key.  OR  Press the PREV or NEXT key to scroll through the available cameras.  OR  From the Camera Menu, select  or  to scroll through the available cameras.

## CONTROL RECEIVERS

Select a suitable camera and operate a PTZ function. A keyboard with “view-only” access can view the signal from the specified camera but cannot control the camera.

Extended Coaxitron protocol receivers can be operated without any programming changes. Other receiver control protocols require programming changes. Refer to the *Programming* section.

Receiver control is not available with the KBD100 keyboard.

### KBD200A KEYBOARD

Pan/Tilt/Zoom	Lens Control: Focus, Iris
Press and hold the appropriate pan/tilt key until the camera reaches the desired position. To change the speed of movement, press a number (1-9) key first (1=slowest, 9=fastest). Press and hold the appropriate zoom key until the desired effect is seen.	Press and hold the appropriate lens control key until the desired effect is seen.

### KBD300A KEYBOARD

Pan/Tilt/Zoom	Lens Control: Focus, Iris
Move the joystick until the camera reaches the desired position. To increase the speed of movement, move the joystick farther from center.  Twist the joystick clockwise to zoom in, counterclockwise to zoom out.	Press and hold the appropriate lens control key until the desired effect is seen.

### KBD960/KBR960 KEYBOARDS













Pan/Tilt/Zoom	Lens Control: Focus, Iris
Move the joystick until the camera reaches the desired position. To increase the speed of movement, move the joystick farther from center or press the T key to pan at turbo speed.  Twist the joystick clockwise to zoom in, counterclockwise to zoom out. Or use the IN/OUT key to zoom in or out.	Use the NEAR/FAR key to focus near or far.  Use the OPEN/CLS key to open or close the iris.



## OPERATE SEQUENCES













You can run a scratchpad sequence from an individual monitor or a system sequence on any monitor accessible from the keyboard. When running a sequence, any cameras not accessible to the keyboard will be bypassed.

A sequence runs continuously until a system operator selects a different camera, or an event timer starts another sequence or macro.

KBD100/200A/300A KEYBOARDS	KBD960/KBR960 KEYBOARDS
<p><b>Run a Sequence</b></p> <ol style="list-style-type: none"> <li>1. Enter a sequence number (1-32). Skip this step to run a scratchpad sequence.</li> <li>2. Press and hold the NEXT or PREV key to move forward or backward through the sequence.</li> </ol> <p><b>To move through the sequence one camera at a time:</b>            Press the NEXT key to move forward.            Press the PREV key to move backward.</p>	<p><b>Run a Sequence</b></p> <ol style="list-style-type: none"> <li>1. Select .</li> <li>2. Enter a sequence number (1-32 for a system sequence; 0 for the scratchpad sequence).</li> <li>3. Select  to start the sequence.</li> </ol> <p>OR</p> <ol style="list-style-type: none"> <li>1. Select .</li> <li>2. Select  to enter the Sequence Menu.</li> <li>3. Enter a sequence number (1-32).</li> </ol> <p><b>OR</b></p> <p>Select  or  to scroll through available sequences.</p> <ol style="list-style-type: none"> <li>4. Select  or  to start the sequence.</li> </ol> <p><b>NOTE:</b> You can define a function key to run a sequence. Refer to the KBD960 Keyboard Installation/Operation Manual for instructions.</p>
<p><b>Pause a Sequence</b></p> <ol style="list-style-type: none"> <li>1. Press the HOLD key; monitor displays H.</li> <li>2. Press the HOLD key to resume.</li> </ol>	<p><b>Pause a Sequence</b></p> <ol style="list-style-type: none"> <li>1. Select .</li> <li>2. Select  or  to resume.</li> </ol>
<p><b>Stop a Sequence</b></p> <ol style="list-style-type: none"> <li>1. Enter a camera number.</li> <li>2. Press the CAM key.</li> </ol>	<p><b>Stop a Sequence</b></p> <ol style="list-style-type: none"> <li>1. Select .</li> </ol> <p>OR</p> <ol style="list-style-type: none"> <li>1. Enter a camera number.</li> <li>2. Press the CAM key.</li> </ol>





## RUN A MACRO

A macro runs until the last step is completed (unless you specify a loop in the macro).

KBD100/200A/300A KEYBOARDS	KBD960/KBR960 KEYBOARDS
<b>Run a Macro</b>	
<ol style="list-style-type: none"> <li>1. Enter the macro number.</li> <li>2. Press the MACRO key.</li> </ol>	<ol style="list-style-type: none"> <li>1. Select .</li> <li>2. Enter a macro number.</li> <li>3. Select  to start the macro.</li> </ol>
<b>Stop a Macro</b>	
<ol style="list-style-type: none"> <li>1. Enter the number of the running macro.</li> <li>2. Press the MACRO key.</li> </ol>	<p><b>OR</b></p> <ol style="list-style-type: none"> <li>1. Select .</li> <li>2. Select  to enter the Macro Menu.</li> <li>3. Enter a macro number.</li> </ol> <p><b>OR</b></p> <p>Select  or  to scroll through available macros.</p> <ol style="list-style-type: none"> <li>4. Select  or  to start the macro.</li> </ol> <p><b>NOTE:</b> You can define a function key to run a macro. Refer to the KBD960 Keyboard Installation/Operation Manual for instructions.</p>
<b>Pause a Macro</b>	
<ol style="list-style-type: none"> <li>1. Select .</li> <li>2. Select  or  to resume.</li> </ol>	
<b>Stop a Macro</b>	
<ol style="list-style-type: none"> <li>1. Select .</li> </ol> <p><b>OR</b></p> <ol style="list-style-type: none"> <li>1. Enter a camera number.</li> <li>2. Press the CAM key.</li> </ol>	

## ACKNOWLEDGE AN ALARM

When an alarm is triggered, an alarm icon appears on the monitors programmed to show that alarm.

KBD100/200A/300A KEYBOARDS	KBD960/KBR960 KEYBOARDS
<ol style="list-style-type: none"> <li>1. Enter the monitor number.</li> <li>2. Press the MON key.</li> <li>3. Press the ACK key. The alarm is removed from the selected monitor.</li> <li>4. Repeat for each alarm.</li> </ol>	<ol style="list-style-type: none"> <li>1. Select .</li> <li>2. Select  to reset the alarm on the individual monitor.</li> </ol> <p><b>OR</b></p> <p>Select  to reset the alarm on all monitors.</p> <p>You can also select  to mute the alarm.</p> <p><b>NOTE:</b> You can define a function key to acknowledge an alarm. Refer to the KBD960 Keyboard Installation/Operation Manual for instructions.</p>







## CALL A PRESET

Program the preset through the keyboard. Refer to the appropriate keyboard manual for instructions. Presets are not available with the KBD100 keyboard.

KBD200A/300A KEYBOARDS	KBD960/KBR960 KEYBOARDS
<ol style="list-style-type: none"> <li>1. Enter the preset number.</li> <li>2. Press the PRESET key.</li> </ol>	<ol style="list-style-type: none"> <li>1. Enter the preset number.</li> <li>2. Press the Prst/Lock key.</li> </ol> <p><b>OR</b></p> <p>Select the PRST icon.</p>

## CREATE AND RUN A PATTERN

Patterns are not available with the KBD100 keyboard.

KBD200A/300A KEYBOARDS	KBD960/KBR960 KEYBOARDS
<p><b>Create a Long Pattern</b></p> <ol style="list-style-type: none"> <li>1. Enter a camera number.</li> <li>2. Enter 0.</li> <li>3. Press and hold the PATTERN key for two seconds.</li> <li>4. The monitor will indicate the programming function is active. Move the camera position as desired for the pattern.</li> <li>5. Press the ACK key to close the programming function.</li> </ol> <p><b>Create a Short Pattern</b></p> <ol style="list-style-type: none"> <li>1. Enter a camera number.</li> <li>2. Enter the short pattern number (1 or 2).</li> <li>3. Press and hold the PATTERN key for two seconds.</li> <li>4. The monitor will indicate the programming function is active. Move the camera position as desired for the pattern.</li> <li>5. Press the ACK key to close the programming function.</li> </ol> <p><b>Run a Long Pattern</b></p> <ol style="list-style-type: none"> <li>1. Press the PATTERN key.</li> <li>2. Move the joystick or call a preset to stop the pattern.</li> </ol> <p><b>Run a Short Pattern</b></p> <ol style="list-style-type: none"> <li>1. Enter the short pattern number (1 or 2).</li> <li>2. Press the PATTERN key.</li> <li>3. Move the joystick or call a preset to stop the pattern.</li> </ol>	<p>Refer to the KBD960 Keyboard Installation/Operation manual for instructions on creating a pattern.</p> <ol style="list-style-type: none"> <li>1. Select  to display the Preset Menu.</li> <li>2. Select  to start a pattern.</li> </ol> <p><b>OR</b></p> <ol style="list-style-type: none"> <li>1. Select  to display the Preset Menu.</li> <li>2. Enter 1.</li> <li>3. Select  to run the first pattern of previously defined half-patterns.</li> </ol> <p><b>OR</b></p> <ol style="list-style-type: none"> <li>1. Select  to display the Preset Menu.</li> <li>2. Enter 2.</li> <li>3. Select  to run the second pattern of previously defined half-patterns.</li> </ol>

## OPERATE AUXILIARIES/RELAYS





Local auxiliaries are the outputs on the rear panel of the CM6800. External auxiliaries are available by connecting an REL2064 Relay Interface Unit to the CM6800 through COM port 3.

### Operate a Local Auxiliary

KBD100/200A/300A KEYBOARDS	KBD960/KBR960 KEYBOARDS
<p>Auxiliary 1 relay: Press F1 to activate/deactivate.</p> <p>Auxiliary 2 TTL output: Press F2 to activate/deactivate.</p>	<p>Auxiliary 1 relay: Press F12* to activate/deactivate.</p> <p>Auxiliary 2 TTL output: Press F24* to activate/deactivate.</p> <p>* F12 and F24 are the default auxiliary control function keys; user-selected function keys can be defined through the Key Define Menu. Refer to the KBD960 Keyboard Installation/Operation Manual for instructions.</p> <p><b>NOTE:</b> If you connect REL2064 Relay Interface Units (up to two) to the CM6800E, operation of the two relays on the rear panel of the CM6800E-32X6 will also operate the first two relays on the first external unit (unless you number the external relays starting at 64).</p>





### Operate an External Auxiliary

The CM6800 can control up to two REL2064 Relay Interface Units connected to the system. Each unit provides 64 relays. Refer to the REL2064 Relay Interface Unit Installation/Operation Manual for detailed information. External relays cannot be operated with the KBD100.

KBD200A/300A KEYBOARDS	KBD960/KBR960 KEYBOARDS
<p>The KBD200A/300A keyboards (firmware version 4.2 and later) can operate external relays.</p> <p>Refer to the KBD200A Keyboard Installation/Operation Manual or the KBD300A Keyboard Installation/Operation Manual for instructions.</p> <p><b>NOTE:</b> External relays cannot be operated with KBD200A/300A keyboard firmware versions prior to 4.2.</p>	<ol style="list-style-type: none"> <li>Enter the GPI number for the appropriate relay output.</li> <li>Press .</li> <li>Press the desired AUX number icon to activate the relay and associated peripheral device. (Press  to access AUX 5-8.)</li> <li>If  is highlighted, the operation is momentary. If  is not highlighted, the operation is latching. Refer to the KBD960 Keyboard Installation/Operation Manual for instructions.</li> </ol>











### Operate an Auxiliary in a Receiver

Receiver auxiliary control is not available with the KBD100.

KBD200A/300A KEYBOARDS	KBD960/KBR960 KEYBOARDS
<p>Press AUX ON/F4 to activate.</p> <p>Press AUX OFF/F5 to deactivate.</p> <p>OR</p> <p>To control a momentary function:</p> <ol style="list-style-type: none"> <li>Enter the auxiliary number.</li> <li>Press and hold AUX ON/F4, and then release.</li> </ol>	<p>From the Camera Menu, press , and then release to control an AUX 1 momentary function on the selected camera.</p> <p>Press  to control an AUX 2 momentary function. Press  to access  through .</p>

## CONTROL GENEX MULTIPLEXER AND GENEX MULTIPLEXER DISPLAYS

Multiplexer control is not available with the KBD100.

KBD200A/300A KEYBOARDS	KBD960/KBR960 KEYBOARDS
<ol style="list-style-type: none"><li>1. Enter the number of the multiplexer input.</li><li>2. Press the CAM key.</li><li>3. Press the SHIFT key. When the SHIFT LED is lit, the keyboard can be used to operate the following Genex multiplexer function keys:  F1: Digital zoom F2: PIP display F3: Quad display AUX ON/F4: 9-screen display AUX OFF/F5: 16-screen display  To select a camera through the multiplexer:<ol style="list-style-type: none"><li>a. Enter the desired camera number (1-16, based on the camera assignments set through the multiplexer).</li><li>b. Press the CAM key.</li></ol></li><li>4. Press the SHIFT key to return to normal keyboard operation.  When the SHIFT LED is off, you can control the currently selected PTZ camera through the multiplexer.  To return to camera selection controlled by the CM6800E:<ol style="list-style-type: none"><li>a. Select the desired camera number.</li><li>b. Press the CAM key.</li><li>c. Move the joystick as necessary.</li></ol></li></ol>	<ol style="list-style-type: none"><li>1. Enter a MUX input number and press . Each MUX input is associated with a camera input. Figure 43 shows MUX 1 being controlled.</li><li>2. Select . MUX Menu 1 appears.  should be highlighted, which means you have MUX control.</li><li>3. Cycle through the 16 picture inserts (if you have a 16-channel multiplexer) by entering the camera number and selecting .</li><li>4. Select  again to zoom into the MUX camera. You can move the joystick to view a specific area.</li><li>5. Select  to bring up MUX Menu 2. The icons for a picture-in-picture display, 4-camera display, 9-camera display, and 16-camera display appear.</li><li>6. Select  to view four of the available 16 cameras on one monitor. You can cycle through all 16 cameras, four at a time, by repeatedly selecting .</li><li>7. Select  to view nine of the available 16 cameras on one monitor. Select again to see the remaining seven cameras.</li><li>8. Select  to view all 16 available cameras on one monitor.  Note that  does not work on a 9-channel multiplexer.</li></ol>

## OPERATE SCANNING FUNCTIONS

Operation of the scanning functions depends on the kind of receiver or pan/tilt mechanism you have. Refer to the appropriate keyboard manual for detailed instructions on operating scanning functions.

## DETECT VIDEO LOSS

The CM6800 detects video loss from any system camera. If video is lost from a camera, the CM6800 blue screen appears on any monitor viewing that camera. When video is restored to that camera, the camera view appears on the monitor(s) again. If the system is programmed for a video loss alarm, the alarm icon appears.

## DEFINE ZONES

A zone is a user-defined, physical location to which (1) a label is attached and (2) a camera is associated. When the associated camera is panned through or remains within this defined zone the zone label appears on the monitor.

Refer to the appropriate keyboard manual for detailed instructions on defining zones.

# APPENDIX

## CM6800 DIP SWITCHES

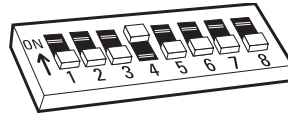

Figure 46. CM6800 DIP Switches – Factory Default Settings

Table G. CM6800 DIP Switch Settings

CM6800 DIP Switch		Default Settings
Switch 1	OFF (0) = NTSC ON (1) = PAL	CM6800-32X6: OFF CM6800-32X6-X: ON
Switch 2	RESERVED – must be in the OFF position for proper operation	OFF
Switch 3	RESERVED – must be in the OFF position for proper operation	OFF
Switch 4	RESERVED – must be in the ON position for proper operation	ON
Switch 5	RESERVED – must be in the OFF position for proper operation	OFF
Switch 6	RESERVED – must be in the OFF position for proper operation	OFF
Switch 7	USED TO RESET SOFTWARE. REFER TO THE SOFTWARE RESET SECTION <b>CAUTION: Resetting the software restores the system software to original settings, programmed by Pelco. All user programming is lost.</b>	OFF
Switch 8	RESERVED – must be in the OFF position for proper operation	OFF

## ALARM GROUP DISPLAY OPTIONS

To display on a monitor, an alarm must be assigned to an alarm group (A-F). Before programming alarms you may want to determine the alarm display format for each alarm group. An alarm can include up to eight steps, so eight camera views could display as a part of each alarm.

A priority alarm appears on system monitors before non-priority alarms, despite the order specified by the alarm group assignment. In the following examples, all alarms are at the same priority level. Refer to the PRIORITY description in *Program Internal and External Alarms*.

### Block Build

Alarmed cameras are displayed across a block of alarm monitors in a sequential order. All steps programmed for the alarm contact appear on the designated monitor.

Example: Seven alarms set to display on monitors 02-06 will appear in the following order:

Monitor	1st Display Cycle	Next Display Cycle	Acknowledging Alarms 1 & 2	Next Display Cycle
02 B	1st alarm	1st and 7th alarms cycle	Acknowledge 1st alarm	7th alarm
03 B	2nd alarm	2nd and 8th alarms cycle	Acknowledge 2nd alarm	8th alarm
04 B	3rd alarm	3rd alarm	3rd alarm	3rd alarm
05 B	4th alarm	4th alarm	4th alarm	4th alarm
06 B	5th alarm	5th alarm	5th alarm	5th alarm
07 B	6th alarm	6th alarm	6th alarm	6th alarm

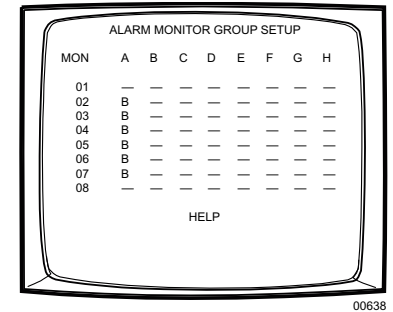

New alarms display on the lowest monitor number with the fewest alarms cycling.

### Chronological Pair: D and Q

The oldest alarm of a specific group is displayed on one designated monitor, while all other alarms in the group are sequenced on the second designated monitor. All steps programmed for the alarm contact appear on the designated monitor.

Example: Four alarms set to display on monitors 04 and 05 will appear in the following order:

Monitor	1 Alarm	2 Alarms	3 Alarms	4 Alarms
04 D	1st alarm	1st alarm	1st alarm	1st alarm
05 Q		2nd alarm	2nd and 3rd alarms cycle	2nd, 3rd, and 4th alarms cycle

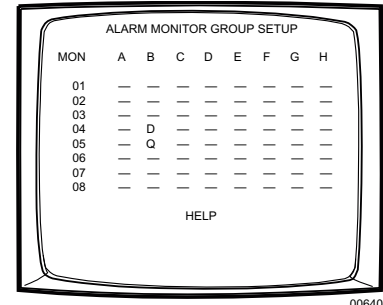

You must acknowledge alarms in a chronological pair from the display monitor (D). Then the next oldest alarm moves to the display monitor and the remaining alarms continue to cycle through the queue monitor (Q). This format requires you to acknowledge each alarm in the order in which they occur.

Acknowledging alarms in this example:

Monitor	1st Cycle	Next Cycle	Next Cycle	Next Cycle
04 D	Acknowledge 1st alarm	Acknowledge 2nd alarm	Acknowledge 3rd alarm	Acknowledge 4th alarm
05 Q	2nd, 3rd, and 4th alarms cycle	3rd and 4th alarms cycle	4th alarm	

## Reverse Chronological Pair: M and L

The most recent alarm of a specific group is displayed on one designated monitor, while all other alarms in the group are sequenced on the second designated monitor. All steps programmed for the alarm contact appear on the designated monitor.

Example: Four alarms set to display on monitors 04 and 05 will appear in the following order:

Monitor	1 Alarm	2 Alarms	3 Alarms	4 Alarms
06 M	1st alarm	2nd alarm	3rd alarm	4th alarm
07 L		1st alarm	1st and 2nd alarms cycle	1st, 2nd, and 3rd alarms cycle

You must acknowledge alarms in a reverse chronological pair from the display monitor (M). Then the next most recent alarm moves to the display monitor and the remaining alarms continue to cycle through the queue monitor (L). This format requires you to acknowledge each alarm in the reverse order from which they occurred.

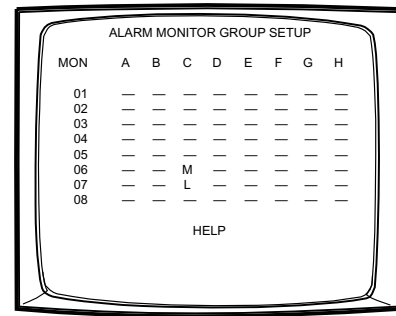

00641

Acknowledging alarms in this example:

Monitor	1st Cycle	Next Cycle	Next Cycle	Next Cycle
06 M	Acknowledge Alarm 4	Acknowledge Alarm 3	Acknowledge Alarm 2	Acknowledge Alarm 1
07 L	Alarms 1, 2, and 3 cycle	Alarms 1 and 2 cycle	Alarm 1	

## Salvo Group

Multiple camera views within the alarm contact programming (the "steps") are displayed simultaneously as a group across a set of monitors. When a new alarm triggers, all monitors switch to the new alarm at the same time.

When programming a Salvo Group:

- Program the Salvo Group to display across a number of monitors equal to the number of steps in the alarm contact(s); for example if the alarm contact has six steps, set the Salvo Group to display on six monitors. If an alarm contact contains more steps than monitors defined for the Salvo Group, the additional steps do not appear on a monitor during the alarm.
- Each alarm contact assigned to the Salvo Group should contain the same number of steps.
- The Salvo Group switches based on the dwell time entered for the first step in the alarm contact.

Example: Two alarm contacts with three steps set to display on three monitors will appear as follows:

Monitor	1 Alarm	2 Alarms	Next Display Cycle	After Acknowledging 1st Alarm
06 S	1st alarm, step 1	2nd alarm, step 1	1st alarm, step 1	2nd alarm, step 1
07 S	1st alarm, step 2	2nd alarm, step 2	1st alarm, step 2	2nd alarm, step 2
08 S	1st alarm, step 3	2nd alarm, step 3	1st alarm, step 3	2nd alarm, step 3

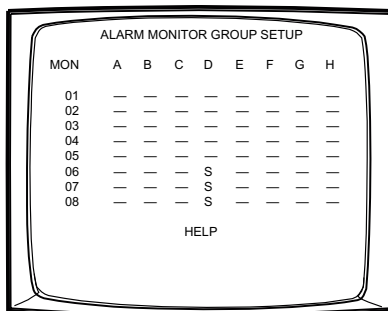

00639



## MACRO COMMANDS

Table H provides a description of each macro command and the additional fields required for each command. Refer to the *Macro* section for instructions on programming macros.

**Table H. Macro Commands**

Command	Description	Specify	Field(s)
GON	Activate an auxiliary.	Auxiliary	Command #
GOFF	Turn off an auxiliary.	Auxiliary	Command #
<b>Auxiliary Notes:</b>			
<ul style="list-style-type: none"> <li>• “Global” includes both internal and external auxiliaries.</li> <li>• Auxiliaries on the rear panel of the CM6800 Matrix Switcher are activated by global auxiliary numbers 1 and 2.</li> </ul>			
CON	Activate a camera auxiliary.	Camera auxiliary	Command #
		Camera	Camera
		Monitor	Monitor
COFF	Turn off a camera auxiliary.	Camera auxiliary	Command #
		Camera	Camera
		Monitor	Monitor
SEQ	Start a sequence. A sequence runs continuously until a system operator selects a different camera, or an event timer starts another sequence or macro.	Sequence	Command #
		Monitor	Monitor
SWT	Switch a camera to a monitor.	Camera	Camera
		Monitor	Monitor
COPY	Copy a camera view to a monitor.	Monitor to copy from	Command #
		Monitor to copy to	Monitor
GO TO	Go to step number specified.	Step	Command #
LOOP	Loop a macro.	0 = loop continuously 1-999 = loop the specified number of times	Command #
?AUX	Check a local auxiliary; if the auxiliary is active, the next step is executed; if the auxiliary is not active, the next step is skipped.	Local auxiliary	Command #
?ALM	Check an internal alarm; if the alarm is active, the next step is executed; if not, the next step is skipped.	Alarm	Command #
?SW	Check whether a camera is displayed on a monitor; if it is, the next step is executed; if not, the next step is skipped.	Camera	Camera
		Monitor	Monitor
STPM	Stop a macro.	Macro	Command #
END	Exit the macro; no further steps are executed. Any macro or sequence started by this macro will continue to run.	None	None
DON	Displays on-screen text on the specified monitor.	Monitor	Monitor
DOFF	Removes on-screen text from the specified monitor.	Monitor	Monitor
MSWT	Switch a camera connected through the multiplexer.	Camera to switch♦	Command #
		Multiplexer input	Camera
		Monitor	Monitor
PIPB	Display multiplexer picture-in-picture view with the designated camera in the background.	Background camera♦	Command #
		Multiplexer input	Camera
		Monitor	Monitor
PIPF	Display multiplexer picture-in-picture view with the designated camera in the foreground.	Foreground camera♦	Command #
		Multiplexer input	Camera
		Monitor	Monitor

♦ For multiplexer functions, the camera number is the number of the video input on the multiplexer. The multiplexer input number is the number of the video input on the rear panel of the CM6800.

**Table H. Macro Commands (Continued)**

Command	Description	Specify	Field(s)
PIPO	Turn off multiplexer picture-in-picture view.	Multiplexer input	Camera
		Monitor	Monitor
QUAD	Display multiplexer four-camera mode.	Camera group*	Command #
		Multiplexer input	Camera
		Monitor	Monitor
NANO	Display multiplexer nine-camera mode.	Camera group*	Command #
		Multiplexer input	Camera
		Monitor	Monitor
HEX	Display multiplexer sixteen-camera mode.	Multiplexer input	Camera
		Monitor	Monitor
ZOOM	Zoom multiplexer camera view.	1 = zoom once 2 = zoom twice	Command #
		Multiplexer input	Camera
		Monitor	Monitor
AAI	Arm internal alarm.	Internal alarm	Command #
DAI	Disarm internal alarm.	Internal alarm	Command #
AAE	Arm external alarm.	External alarm	Command #
DAE	Disarm external alarm.	External alarm	Command #
AAV	Arm video loss detection for a camera.	Physical camera number OR Logical camera number	Command #  Camera
DAV	Disarm video loss detection for a camera.	Physical camera number OR Logical camera number	Command #  Camera
MACR	Start a specific macro. A macro runs until the last step is completed (unless you specify a loop in the macro).	Macro	Command #
PATT	Start a pattern.	Pattern**	Command #
		Camera	Camera
		Monitor	Monitor
PRES	Start a preset.	Preset**	Command #
		Camera	Camera
		Monitor	Monitor
RSCN	Start a random scan.	Camera	Camera
		Monitor	Monitor
FSCN	Start a frame scan.	Camera	Camera
		Monitor	Monitor
SSCN	Stop a scan.	Camera	Camera
		Monitor	Monitor

\* Refer to the MX4000 Genex Series Simplex and Duplex Multiplexers Installation/Operation Manual for information on multiple camera displays.

\*\* The number of patterns and presets available is determined by the camera positioning system. Refer to the appropriate camera positioning system manual.

## ASCII OPERATING COMMANDS

ASCII protocol uses the ASCII character set to transmit and receive commands between an ASCII device (such as a personal computer (PC) or ASCII keyboard) and the CM6800.

The ASCII protocol communicates in a standard asynchronous, byte-oriented protocol that includes: 1 start bit, 8 data bits, 1 parity bit (odd parity), and 1 stop bit. The default communication rate is 9600 baud.

A lowercase "a" ends each command. The ASCII translator acknowledges accepted commands and rejected commands with the following responses:

AKa      command accepted  
 NAa      command rejected or the ASCII translator does not recognize the command

If the command requires a numeric value, enter the number first.

Table I provides examples of ASCII commands. Table J lists all of the commands.

**Table I. Examples of ASCII Commands**

Functional Procedure	Commands	Result
Select a pan and tilt device labeled "CAMERA # 16" and switch it to monitor # 3.	3Ma16#a	Switch camera 16 to currently selected monitor 3.
Manipulate the pan and tilt device.	1Ma3#a	Switch camera 3 to monitor 1.
	5Ma2#a3a	Go to camera 2, preset 3, on monitor 5.
	47Ra33Da	Pan right at speed 47, tilt down at speed 33.
	sa	Stop all image motion.
Switch a camera.	1Ma3#a	Switch camera 3 to monitor 1.
Call a preset.	5Ma2#a3a	Go to camera 2, preset 3, on monitor 5.
Pan and tilt.	47Ra33Da	Pan right at speed 47, tilt down at speed 33.

**Table J. ASCII Commands**

Number ranges are enclosed in brackets – do not enter the brackets. When you control a fixed speed pan and tilt, omit the speed information.

**NOTE:** In a 96 x 16 system the numbers for cameras, monitors, alarms, and relays can be doubled.

Desired Action	Command	Result
Select monitor	[1-9999]Ma	Calls a monitor to use for camera operation.
Select camera Next camera Previous camera	[1-9999]#a +a -a	Selects a camera to display on the current operating monitor. The NEXT key (+) and PREV key (-) commands switch to the next numbered camera in the system.
Start a sequence forward	[1-99]qa	Starts the selected sequence going forward (incrementing camera numbers).
Start a sequence backward	[1-99]ba	Starts the selected sequence going backward (decrementing camera numbers).
Hold a sequence	ea	Places the running sequence on hold, freezing the currently selected camera on the monitor. It lets you control the camera or switch. The sequence is still "armed" on the monitor, but inactive.
Hold a macro	[1-64]ea	Places the running macro on hold.
Pan left Pan right Stop pan left Stop pan right	[1-64]La [1-64]Ra ~La ~Ra	Moves the currently selected pan and tilt device left or right at the speed indicated. If you omit the speed, some devices move at their default speed and others move at their slowest possible speed. Speed information has no effect on fixed speed devices.
Tilt up Tilt down Stop tilt up Stop tilt down	[1-63]Ua [1-63]Da ~Ua ~Da	Moves the currently selected pan and tilt device up or down at the speed indicated. If you omit the speed, some devices move at their default speed and others move at their slowest possible speed. Speed information has no effect on fixed speed devices.
Zoom telephoto Zoom wide Stop zoom telephoto Stop zoom wide	Ta Wa ~Ta ~Wa	Makes the currently selected camera zoom in (close up view) or zoom out (wide view).
Focus near Focus far Stop focus near Stop focus far	Na Fa ~Na ~Fa	Changes the good focus range nearer or farther on the currently selected camera.
Iris open Iris close Stop iris open Stop iris close	Oa Ca ~Oa ~Ca	Opens (brighter image) or closes (darker image) the iris on the currently selected camera.
Stop all PTZ motion	sa	Stops all image motion (stops pan, tilt, zoom, focus, and iris). Does not stop a pattern.
Record pattern Execute pattern End pattern	[1-99]/a [1-99]pa [1-99]na	On receivers that do patterns, these commands let you record your motions and operations (for a limited time) and then have the system repeat them.
Go to preset position	[1-99]a	Recalls a stored preset position.
Set preset with a label	la[string]!a [1-9999]^a	Sets a preset location with an embedded label, where the ASCII string <b>must be UPPERCASE characters</b> . The [string] is an alphanumeric label up to 20 characters long and [1-9999] is the associated preset number. <b>NOTE:</b> All transmitted characters <b>must be ASCII</b> .
Set preset without a label	[1-9999]-^a	Sets a preset location without an embedded label.
Begin zone	[1-8]a	Begins a zone without a label.
Begin zone with a label	la[string]!a[1-8]a	Begins a zone with an embedded label. The ASCII string must be uppercase characters.
End zone	[1-8]a	Ends the zone program

**Table J. ASCII Commands (Continued)**

Desired Action	Command	Result
Begin random scan Begin frame scan Stop scan	1@a 2@a ~@a	These commands start and stop scans.
Auxiliary on Auxiliary off	[1-256]xa [1-256]~xa	Auxiliaries are relay outputs that can be controlled through the protocol. 1-2 operate the AUX 1 and F2 auxiliaries on the rear panel of the CM6800 (and the first two auxiliaries on an external REL2064). 3-128 operate the external auxiliaries on up to two REL2064 Relay Interface Units.
Camera auxiliary on Camera auxiliary off	[1-8]Aa [1-8]Ba	Operates auxiliaries at the camera (receiver).
Start macro	[1-64]Sa	Starts the selected macro.
Stop macro	[1-64]Ha	Stops the selected macro.
Acknowledge alarm	[1-9999]!a	Acknowledges an existing alarm.
Arm internal alarm Arm external alarm Arm video loss alarm Disarm internal alarm Disarm external alarm Disarm video loss alarm	[1-8]Jia [1-256]Jea [1-48]Jva [1-8]~Jia [1-256]~Jea [1-48]~Jva	These commands arm and disarm system alarms.
Trigger an alarm Clear an alarm Acknowledge an alarm	#Ea #!a #Ka	An ASCII device can send these commands through the CM6800 to control alarms in an external alarm device, such as an ALM2064 Alarm Interface Unit. <b>NOTE:</b> These commands do not affect internal alarms on the CM6800 rear panel.
An alarm is triggered An alarm is cleared An alarm is acknowledged	#Ea #!a #Ka	If you configure a CM6800 Port to report alarms to an ASCII device, the CM6800 reports the alarm information using these commands. <b>NOTE:</b> The CM6800-32X6 reports the physical alarm number. If you use the eight internal alarm inputs on the rear panel, do not use the first eight inputs on any external alarm interface units (ALM2064), or you will have a numbering conflict.
Select a MUX camera Display picture-in-picture view Display four-camera mode Display nine-camera mode Display 16-camera mode Digital mode zoom Digital mode pan left Digital mode pan right Digital mode tilt up Digital mode tilt down	[1-9999]#m im um om xm ym dLm dRm dUm dDm	These commands control a Genex multiplexer connected to the CM6800.
Send camera title	[1-48]Ya[string]!a	Sends a camera title to the matrix switching system. You can only send one camera title at a time.  Valid characters in the string are A-Z, a-z, space, and 0-9 in ASCII representation. Strings are limited to 20 characters.
Version	va	Returns the version number of the device.
Set date and time	ZaMM/DD/YY/HH: MM:Ssa	Sets the date and time. Since the date and time string could be confused with other commands, the command <b>Za</b> comes first. This puts the receiving device into a mode that can accept the specialized string.  <b>NOTE:</b> All transmitted characters <b>must be ASCII</b> .

# TROUBLESHOOTING

## GAINING INITIAL CONTROL

If you are having problems gaining control of your system for the first time:

- Confirm that all system equipment is plugged in and has power.
- Confirm that each keyboard and peripheral device in your system has a unique local address. Refer to the *Switch Settings* section in the appropriate keyboard manual.
- Be sure data cables have not been mixed up.
- Cycle the data cable to the keyboard:
  1. Unplug the data cable from the rear of the keyboard.
  2. Plug the data cable back into the rear of the keyboard.
  3. WAIT AT LEAST FIVE SECONDS.
  4. Select a monitor.

If you still cannot gain control of the system:

- Confirm the wiring is correct and the user-supplied cable between wall jacks is appropriate for the application.
- Confirm that when the keyboard data cable is cycled, the keyboard LED flashes momentarily (indicating power).

If you still cannot gain control of the system, call Pelco's 24-hour technical support at 1-800-289-9100 or 1-559-292-1981.

---

**NOTE:** There are no userserviceable parts inside the CM6800. Only authorized service personnel may open the unit.

---

## SOFTWARE RESET

**Pelco strongly recommends** uploading system settings to the CM6800-MGR before the software reset – this will allow you to restore system settings after the software reset.



**CAUTION:** Resetting the software restores the system to default settings.

1. Remove the two screws and the DIP switch cover plate from the rear of the matrix switcher.
2. Move DIP switch 7 to the ON position (to "0").
3. Cycle power.

The switcher will go through a software clear cycle and reset to factory defaults.

4. Move DIP switch 7 to the OFF position.

Failure to move DIP switch 7 to the OFF position could result in loss of system settings during a power outage.

5. Re-initialize keyboards by entering the monitor number and then pressing the MON key.
6. Download your previous system settings (revise settings as necessary) from the CM6800-MGR.

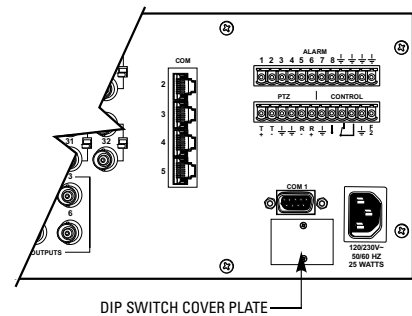

**Figure 47.** Dip Switch Cover Plate



SWITCH 7:  
ON = SOFTWARE RESET  
OFF = NORMAL SYSTEM  
OPERATION

**Figure 48.** CM6800 DIP Switch 7

## SOLUTIONS TO COMMON PROBLEMS

Refer to Table K for a list of common problems and their solutions.

**Table K. Solutions To Common Problems**

<b>Problem</b>	<b>Remedy</b>
CM6800 does not have power.	Make sure the power cord is plugged in.
You can see some cameras and not others from your location.	Confirm that the camera is properly connected and has power. The keyboard and monitor may have been denied access to the cameras.
The CM6800 does not respond to keyboard commands.	Confirm that the monitor the keyboard is addressing is the same as the monitor in front of you. Access to that monitor may be restricted from that keyboard. Select another monitor.
Pressing the PGM key displays a P on the keyboard LED, but the Password menu does not appear on the monitor. (KBD100/200A/300A Keyboards only)	Confirm that the keyboard transformer is plugged in and all electrical connections are in order. Confirm that the monitor the keyboard is addressing is the same as the monitor in front of you.
Keyboards do not function after installation and initial power-up.	Confirm that all wiring is correct and that keyboards have power and are connected. Confirm that each keyboard has been set for a unique address.
Previous system control has been lost.	<p><b>SOLUTION 1</b> Initialize the keyboard:</p> <ol style="list-style-type: none"> <li>1. Enter the monitor number.</li> <li>2. Press the MON key.</li> </ol> <p><b>SOLUTION 2</b></p> <ol style="list-style-type: none"> <li>1. Unplug the data cable from the rear of the keyboard.</li> <li>2. Plug the data cable back into the rear of the keyboard.</li> <li>3. Wait five seconds.</li> <li>4. Re-initialize the keyboard.</li> </ol> <p><b>SOLUTION 3</b></p> <ol style="list-style-type: none"> <li>1. Power down the CM6800.</li> <li>2. Power up the system.</li> <li>3. Wait five seconds.</li> <li>4. Re-initialize keyboards.</li> </ol> <p><b>SOLUTION 4</b> Perform a software reset (refer to Software Reset in this section). <b>CAUTION:</b> <i>Resetting the software restores the system to default settings. All user programming is lost. Uploading system settings to the CM6800-MGR before the software reset allows you to restore system settings after the software reset.</i></p> <p><b>SOLUTION 5</b> Call Pelco's 24-hour technical support at 1-800-289-9100 or 1-559-292-1981.</p>
The unit malfunctions and you cannot restore it to satisfactory operation.	Perform a software reset (refer to Software Reset in this section). <b>CAUTION:</b> <i>Resetting the software restores the system to default settings. All user programming is lost. Uploading system settings to the CM6800-MGR before the software reset allows you to restore system settings after the software reset.</i>

# KBD960/KBR960 ICON/BUTTON LEGEND

LOG OFF	JOYSTICK ADJUST	AUX 4, RELAY 4	MUX QUAD
LOG OFF YES	ADVANCE MENUS	AUX 5, RELAY 5	MUX NINE
LOG OFF NO	SERIAL PORT TEST	AUX 6, RELAY 6	MUX SIXTEEN
SETUP/DEFINE PIN	KEYBOARD DOWNLOAD	AUX 7, RELAY 7	MUX LIVE
SAVE SELECTION	KEYBOARD UPLOAD	AUX 8, RELAY 8	MUX CAMERA CONTROL
DELETE	TEST GRAPHIC PAGE 0	RESET ALARM	SEQUENCE MENU
MORE MENU	TEST GRAPHIC PAGE 1	RESET ALL ALARMS	CAMERA PRESET
EXIT	TEST GRAPHIC PAGE 2	MUTE	PATTERN
CAMERA SELECTION	TEST TEXT PAGE 0	ALARM	ZONE
MONITOR SELECTION	PARITY	GPI MENU	DEFINE MENU
SCROLL UP SCROLL FIELD UP	DIP SWITCH TEST	RELAY MOMENTARY	PROGRAM MENU
SCROLL DOWN SCROLL FIELD DOWN	DISPLAY BRIGHTNESS	MACRO SELECT	DEFINE NUMBER
PLAY FWD SCROLL RIGHT	COM PORT 1	DEVICE PAUSE	PROGRAMMING MENU
PLAY BWD SCROLL LEFT	COM PORT 2	STOP	
SCROLL OPTION UP	COM PORT 3	MUX MENU	
SCROLL OPTION DOWN	AUX 1, RELAY 1	MUX TAPE	
KEYBOARD SELECT	AUX 2, RELAY 2	MUX ZOOM	
KEYBOARD KEY TEST	AUX 3, RELAY 3	MUX PIC IN PIC	

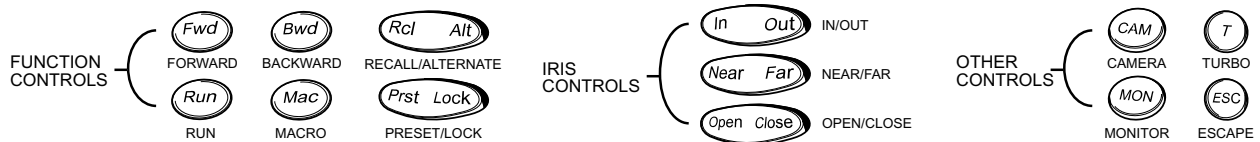

00665

Figure 49. Icon/Button Legend



## GLOSSARY

<b>Term</b>	<b>Definition</b>
Access	The CM6800 allows you to restrict system control by (1) limiting the monitors or cameras a keyboard can access, or (2) limiting the cameras that can be viewed on a monitor.
Alarm display format	The CM6800 Matrix Switcher provides four formats for displaying alarmed cameras on system monitors: Block Build, Chronological Pair, Reverse Chronological Pair, and Salvo Group.
Alarm group	To display on a monitor, an alarm must be assigned to one or more alarm groups. The CM6800-32X6 Matrix Switcher provides six alarm groups (A through F). Refer to Alarm Groups and Alarm Group Display Options.
Alarm priority	A priority alarm appears on system monitors before a non-priority alarm. Refer to the Priority description under Internal and External Alarms.
ASCII	The binary, 7-bit, 128-character set implemented as the standard in communications.
Auxiliary	Output relays can be used to control external devices based on matrix switcher activities. External devices can include VCRs, alarm devices, and triggers for audio circuits.
Baud rate	In video, the greater the speed, the larger amount of information passed. In digital systems, this capacity is given in bits per second, or baud rates.
Bit	An abbreviation for "binary digit" – the smallest unit of information a computer can use. A bit is either a 1 or a 0 (a high or low voltage state).
Byte	An abbreviation for "binary term" – bytes are strings of bits, operated upon as a unit. A byte is equal to eight bits (256 possibilities) and is large enough to hold one character (like an "A" or the number "1".)
Camera auxiliary	Some cameras contain an auxiliary output relay, which can be used to operate a device connected to the relay.
Coaxitron	This is Pelco's "up the coax" control technology. Control signals are sent back up the coaxial cable that the video signal travels down on.
COM port	This is a communication port input on the rear panel of the matrix switcher.
Daisy-chain	This is a way of providing multiple connections in a series, from one source. A daisy-chain configuration connects multiple, linked devices from one output. When connecting PTZ cameras to a matrix switcher, for example, one set of cables connects the matrix switcher to each receiver, and then each receiver is connected to the next receiver.
Dwell	This is the amount of time something happens in the system, such as the amount of time a camera view displays on a monitor, or an auxiliary is on.
Event timer	The matrix switcher can automatically initiate macros or sequences based on time and date.
Extended Coaxitron	This is Pelco's Coaxitron control technology that uses 32 bits to send a command.
Frame scan	A three-second camera scan followed by a three-second pause.
Latching operation	The auxiliary device remains on until a command is given (by a system operator or system automation) to turn it off.
Logical camera number	A user-selectable, variable number, which is associated with an actual physical camera input on the rear panel of the matrix switcher.
Macro	A sequence of commands or steps. Macros can be operated automatically or manually. Automatic operation can be based on specific times or dates (set through the Event Timer).

Matrix switcher	This is also known as a cross-point switcher. The cross-points are actually electronic switches that select any video input onto any video output at any one time, preserving the video impedance matching. One video signal can simultaneously be selected on more than one output. More than one video input can be selected on one output, in a sequential switching between inputs (unless the input is routed through a multiplexer, which allows more than one input to be viewed on the output monitor at any one time).
Momentary operation	The auxiliary output operation is activated briefly and then turns off.
Multiplexer (MUX)	A multiplexer allows an operator to view more than one video signal (usually either four, nine or sixteen signals) at one time on a single monitor. A multiplexer can also send these multiple images to the video recorder, switching rapidly between image from each camera.
NTSC	The American color TV standard, used in North America, Japan, and a few other countries. It specifies 525 lines/screen, and 29-30 frames/sec.
Null modem cable	A null modem cable allows you to connect your PC to another nearby PC or serial device by "crossing over" (reversing) their respective pin contacts. (A null modem cable is limited to 30 feet in length.)
PAL	The color TV standard (50Hz) used by European, Asian, and some Latin American countries. It specifies 768 pixels/line, 576 lines/screen and 25 frames/sec.
Parity type	The parity bit is used to identify whether the bits being moved arrived successfully. Parity bit checking can be based on odd or even bits. No parity means that a parity bit is not transmitted or checked.
Pattern	A pattern is a user-defined, viewable camera path with a definite beginning and end. The pattern can consist of any standard pan and tilt or lens command. Once defined, the pattern is easily activated by a system operator or through an automated event. The pattern will run continuously until it is deactivated. The number and time length of patterns varies with different positioning systems.
Physical input	A number representing an actual BNC camera input on the rear panel of the matrix switcher. This number cannot be changed.
Preset	A preset allows operators to direct a PTZ (camera positioning system) to move to a predetermined scene on keyboard command or as a result of an alarm. In addition to moving the camera, a descriptive title can appear on the screen. The type of camera positioning system determines the number of presets available.
Priority control	This is the level of priority a system keyboard has to control a PTZ camera positioning system and to access CM6800 Matrix Switcher on-screen programming menus.
PTZ	This is a camera positioning system with pan, tilt, and zoom capabilities.
Random scan	This is a camera scan moving in a random pattern.
RJ-45 wall block	This is a wall block with eight terminals for connecting RS-232, RS-422, and RS-485 communication lines. (This is Pelco part number CON12J00820360Z.)
RS-232	This is an Electronics Industry Association (EIA) interface standard used for data communication; the normal connection distance is 50 feet (15 m). Pelco uses this standard for communication from a controller to a PC or RS-232 network. The Pelco three-wire connection provides one wire for transmit, one wire for receive, and one wire for common.

RS-422	<p>This is an Electronics Industry Association (EIA) interface standard. Pelco uses this standard for communication from a controller to one or more camera receivers (on the same line); the maximum recommended distance is 4,000 feet (1,219 m).</p> <p>The four-wire connection provides two wires for transmit and two wires for receive. Pelco receiver/driver communication uses only the two transmit wires (commands are sent from the controller to the receiver only; the receiver does not “talk” back to the controller). Pelco keyboard communication uses all four wires.</p> <p><i>NOTE: The electrical communication scheme used by Pelco is a direct-coupled method, not an AC-coupled method. Therefore, if the ground potential of the wire at its two end points is different (other than zero volts), an additional wire is required as a ground.</i></p>
RS-485	<p>This is an Electronics Industry Association (EIA) interface standard used for communication between multiple transmitters and receivers; the maximum recommended distance is 4,000 feet (1,219 m). The four-wire connection provides two wires for transmit and two wires for receive.</p> <p><i>NOTE: The electrical communication scheme used by Pelco is a direct-coupled method, not an AC-coupled method. Therefore, if the ground potential of the wire at its two end points is different (other than zero volts), an additional wire is required as a ground.</i></p>
Scratchpad sequence	<p>A scratchpad sequence can be run on an individual system monitor, without entering the password-protected CM6800 Matrix Switcher on-screen programming menus. You can program scratchpad sequences from the CM6800 Matrix Switcher on-screen programming menus only, not from the CM6800-MGR software.</p>
Sequence	<p>Allows an operator to see a routine of 72 camera views on any system monitor, over and over again. The sequence can be operated automatically or manually. The order in which the camera views appear and the time each view remains can be programmed.</p>
Standard Coaxitron	<p>This is Pelco’s Coaxitron control technology that uses 15 bits to send a command.</p>
Star configuration	<p>This is a way of providing multiple direct connections from one source. A star configuration uses a separate cable for each direct connection, with all of the cables connected to a central device. When connecting PTZ cameras to a matrix switcher, for example, the central device can be a code distribution unit, such as the CM9760-CDU-T. Each camera has a direct connection to the CM9760-CDU-T, which is the central device.</p>
Synchronize	<p>Since the CM6800 can be programmed from either the CM6800-MGR software or the CM6800 programming menus, the two programming sources could potentially have different settings. Pelco recommends that you always synchronize programming changes between the CM6800-MGR and the CM6800. Refer to <i>Transmit Programming Settings</i> in the CM6800-MGR Installation/Operation Manual.</p>
System keyboard	<p>This is a keyboard compatible with and connected to the matrix switcher, allowing a system operator manual control over the system.</p>
System reset	<p>This restores the system to the default settings, as shipped from the factory.</p>
Vertical drive/synchronization	<p>This option sends a timing pulse from the matrix switcher to a compatible camera. The camera aligns the vertical synchronization with the timing pulse.</p>
Zone	<p>A zone is a user-defined, physical location to which (1) a label is attached and (2) a camera is associated. When the associated camera is panned through or remains within this defined zone, the zone label appears on the monitor. With some camera systems, a zone can be blanked to prevent viewing while the camera is positioned in the zone.</p>

# INDEX

## A

- Access 9
- Access (partitioning) 38
- Addressing
  - KBD100/200/300 series keyboards 20
  - KBD960/KBR960 series keyboards 32
  - M devices 22
- Alarms
  - acknowledge 58
  - alarm contact programming 39
  - alarm groups 39, 63
  - alarm inputs 9, 16, 40
  - ALM2064 9, 16, 22, 24, 25
  - block build 39, 63
  - chronological pair 39, 63
  - display 39, 63
  - normally open/normally closed 16
  - priority level 63
  - reverse chronological pair 39, 64
  - salvo group 39, 64
  - video loss 41, 49, 61, 66
- ALM2064 10
- ASCII commands 67
- ASCII device 67
- AUX 1 relay 29
- Auxiliaries
  - automatic activation 53
  - connection 9
  - global 53
  - installation 29
  - operation 60
  - programming 42
  - REL2064 9, 10, 22, 24, 25, 29, 60

## C

- Camera
  - access 56, 57
  - camera title 48
  - camera/receiver control 56
  - connection 12, 14
- CM6800-MGR software 27, 34, 50, 70
- CM9760-CDU-T 10, 14
- CM9760-MDA 10
- Coaxitron 8, 12, 48
- Color bars (monitor) 33
- Communication ports
  - connections 17, 18
  - port settings 18, 32
  - programming 51

## D

- D protocol 8, 14, 48
- Date
  - display 49
  - programming 54
- Defaults
  - access 38
  - DIP switches 62
  - port 18
  - terminating switch 13
- Defaults, system 50, 70
- DIP switches
  - ALM2064 24
  - KBD100/200/300 series keyboards 20
  - KBD960/KBR960 series keyboards 32
  - matrix switcher 62
  - REL2064 24
- Dwell 47, 53
- E**
- Event timers 46
- Exit (programming) 36

## F

- F2 relay 30

## G

- Genex multiplexer
  - installation 28
  - operation 61
  - programming 32
- Global auxiliaries 53

## H

- Help screens 37

## I

- Installation
  - alarms 16
  - auxiliaries 29
  - cameras 12, 14
  - Genex multiplexers 28
  - M devices 22
  - monitors 15
  - PC 27
- Interface control 8

## K

- KBD100/200/300 series keyboards
  - address 20
  - description 10
  - DIP switches 20
  - direct-powered connection 19
  - remote connection 21
- KBD960/KBR960 series keyboards
  - address 32
  - description 10
  - DIP switches 32
  - multiple keyboard connection 25
  - single keyboard connection 23
- KBDKIT(-X) 10, 19, 21
- Keyboard
  - initialize 31

## L

- Language, select 35
- Logical camera number
  - display (on monitor) 48

## M

- M devices
  - addressing 22
  - installation 22
- M protocol 8, 22
- Macro
  - automatic activation 46
  - description 8
  - operate 58
  - programming 47, 65
  - status 47
- Models 10
- Monitor
  - alarm display 39, 63
  - color bars 33
  - installation 15
  - programming (display settings) 48
  - mounting 11

## N

- NTSC 62

## O

Open collector (TTL) output 30

### Operation

- alarms 58
- auxiliaries 60
- cameras 56
- Genex multiplexer 61
- macros 58
- monitors 55
- overview 55
- patterns 59
- presets 59
- PTZ control 56
- sequences 57

## P

P protocol 8, 14, 48

PAL 62

Partitioning (access) 38

### Password

- password screen 35
- programming 50

### Patterns

- automatic activation 47, 53
- description 8
- labels 54
- operation 59

### PC

installation 27

Port address (camera) 32

Power (matrix) 9, 31

### Presets

- automatic activation 53
- description 8
- labels 54
- operation 59

Priority control 9, 52

Problems 70, 71

### Programming

- access 38
- alarms 39
- auxiliaries 42
- date 54
- event timers 46
- exit 36
- Genex multiplexer 32
- macros 47, 65
- main menu 35
- monitor display settings 48
- navigation 36
- password 50
- ports 51
- priority control 52
- sequences 52
- time 54

PTZ control 12, 14, 56

## R

R/X type 48

Rack ears 11

Receiver control 56

REL2064 10, 22, 24, 25, 29, 60

Reset, matrix switcher software 70

reversed cable (identifying) 22

RS-422 14

## S

Scratchpad sequence 52

### Sequence

- automatic activation 46
- description 8
- operate 57
- programming 52
- scratchpad 52

### Software

- CM6800-MGR 27, 34, 50, 70
- matrix switcher 70

straight cables (identifying) 22

System defaults 50, 70

## T

Terminating switch 13

### Time

- display 49
- format 54
- programming 54

Timers (event) 46

Troubleshooting 70, 71

TTL (open collector) output 30

## V

Video Loss 66

### Video loss

- alarm 41, 49
- detection 12, 61

Video sources 12

## Z

### Zones

- description 8, 61
- labels 54

# SPECIFICATIONS

## GENERAL

Memory Protection:	Lithium battery, five years of data protection
Keyboards:	Ten: Eight KBD100/200A/300A Series keyboards and two KBD960/KBR960 Series keyboards. (Switcher can provide power for one KBD100/200A/300A Series keyboard. Additional keyboards will require a remote power supply.)
Receiver/Dome Control:	Coaxitron and RS-422
Alarm Inputs:	Eight individually programmable for N.O. or N.C. on rear panel (plus an additional 128, via ALM2064, Alarm Interface Units, providing a total of 136 possible)
Control Outputs on Rear Panel	
AUX 1:	One relay (SPDT), rated at 0.5 amp @ 125 V, 1 amp @ 30 VDC, 60 milliohms contact resistance
F2:	One open collector (TTL); 15 VDC maximum, 25 mA maximum
Additional Outputs:	Two REL2064, Relay Interface Units, may be connected to expand relay outputs to a maximum of 128
Communication Ports:	Five data ports, one PTZ control port, flexible configuration options; one port provides power for keyboard

## ELECTRICAL

Input Power:	120 V or 230 V, 50/60Hz
Power Consumption:	25 W

## SWITCHER CHARACTERISTICS

Video Inputs, Looping:	32 BNC, terminating or looping (individually selectable per camera), .5 to 2.0 Vp-p composite video, video loss detection
Video Outputs:	Six outputs, BNC
Switching Type:	Cross-point video matrix, NTSC and PAL compatible
Switching Method:	Vertical interval switching
Switching Time:	Less than 16 milliseconds (typical)

## VIDEO

Bandwidth:	15 MHz
Frequency Response:	Flat to 8 MHz, $\pm 1$ dB to 13 MHz
Signal-to-Noise Ratio:	-50 dB (peak-to-peak vs. RMS noise)
Adjacent Channel Crosstalk:	-55 dB typical at 3.58 MHz
Differential Gain:	0.03% typical
Differential Phase:	0.24° typical
Gain:	Unity ( $\pm 1$ dB)
DC Output:	Zero volts

## CHARACTER GENERATION

Character Type:	White with black outline; adjustable brightness
Camera Identification:	Two lines, twenty-character title, plus camera number, monitor number, date (four formats) and time (24-hour or AM/PM formats)
Programmable:	On-screen, menu-driven
Character Set:	128 ASCII characters

## ENVIRONMENTAL

Ambient Operating Temperature:	20° to 120°F (-7° to 49°C)
Humidity:	10-90% non-condensing

## MECHANICAL

Dimensions:	17.40 (W) x 5.25 (H) x 12.25 (D) inches (without rack ears) (44.20 x 13.34 x 31.12 cm)
Mounting:	Factory-configured for EIA rack mount (3 RU); rack ears can be removed for versatile wall mount or freestanding applications
Unit Weight:	12.7 lb (5.76 kg)

*(Design and product specifications subject to change without notice.)*

## REGULATORY NOTICES

This device complies with part 15 of the FCC Rules. Operation is subject to the following two conditions: (1) this device may not cause harmful interference, and (2) this device must accept any interference received, including interference that may cause undesired operation.

### RADIO AND TELEVISION INTERFERENCE

This equipment has been tested and found to comply with the limits of a Class B digital device, pursuant to part 15 of the FCC rules. These limits are designed to provide reasonable protection against harmful interference in a residential installation. This equipment generates, uses, and can radiate radio frequency energy and, if not installed and used in accordance with the instructions, may cause harmful interference to radio communications. However there is no guarantee that the interference will not occur in a particular installation. If this equipment does cause harmful interference to radio or television reception, which can be determined by turning the equipment off and on, the user is encouraged to try to correct the interference by one or more of the following measures:

- Reorient or relocate the receiving antenna.
- Increase the separation between the equipment and the receiver.
- Connect the equipment into an outlet on a circuit different from that to which the receiver is connected.
- Consult the dealer or an experienced radio/TV technician for help.

You may also find helpful the following booklet, prepared by the FCC: "How to Identify and Resolve Radio-TV Interference Problems." This booklet is available from the U.S. Government Printing Office, Washington D.C. 20402.

Changes and Modifications not expressly approved by the manufacturer or registrant of this equipment can void your authority to operate this equipment under Federal Communications Commission's rules.

### WARRANTY AND RETURN INFORMATION

#### WARRANTY

Pelco will repair or replace, without charge, any merchandise proved defective in material or workmanship for a period of one year after the date of shipment. Exceptions to this warranty are as noted below:

- Five years on the following fixed camera models: CC3701H-2, CC3701H-2X, CC3751H-2, CC3651H-2X, MC3651H-2, and MC3651H-2X.
- Three years on all other fixed camera models (including Camclosure® Integrated Camera Systems) and Genex® Series (multiplexers, server, and keyboard).
- Two years on all standard motorized or fixed focal length lenses.
- Two years on Legacy®, CM6700/CM6800/CM6800E/CM8500/CM9500/CM9700 Series Matrix, DF5 and DF8 Series Fixed Dome products.
- Two years on Spectra®, Esprit®, and PS20 Scanners, including when used in continuous motion applications.
- Two years on Esprit® and WW5700 series window wiper (excluding wiper blades).
- Eighteen months on DX Series digital video recorders and NVR300 network video recorders.
- One year (except video heads) on video cassette recorders (VCRs). Video heads will be covered for a period of six months.
- Six months on all pan and tilts, scanners or preset lenses used in continuous motion applications (that is, preset scan, tour and auto scan modes).

Pelco will warrant all replacement parts and repairs for 90 days from the date of Pelco shipment. All goods requiring warranty repair shall be sent freight prepaid to Pelco, Clovis, California. Repairs made necessary by reason of misuse, alteration, normal wear, or accident are not covered under this warranty.

Pelco assumes no risk and shall be subject to no liability for damages or loss resulting from the specific use or application made of the Products. Pelco's liability for any claim, whether based on breach of contract, negligence, infringement of any rights of any party or product liability, relating to the Products shall not exceed the price paid by the Dealer to Pelco for such Products. In no event will Pelco be liable for any special, incidental or consequential damages (including loss of use, loss of profit and claims of third parties) however caused, whether by the negligence of Pelco or otherwise.

The above warranty provides the Dealer with specific legal rights. The Dealer may also have additional rights, which are subject to variation from state to state.

If a warranty repair is required, the Dealer must contact Pelco at (800) 289-9100 or (559) 292-1981 to obtain a Repair Authorization number (RA), and provide the following information:

1. Model and serial number
2. Date of shipment, P.O. number, Sales Order number, or Pelco invoice number
3. Details of the defect or problem

If there is a dispute regarding the warranty of a product which does not fall under the warranty conditions stated above, please include a written explanation with the product when returned.

Method of return shipment shall be the same or equal to the method by which the item was received by Pelco.

#### RETURNS

In order to expedite parts returned to the factory for repair or credit, please call the factory at (800) 289-9100 or (559) 292-1981 to obtain an authorization number (CA number if returned for credit, and RA number if returned for repair).

All merchandise returned for credit may be subject to a 20% restocking and refurbishing charge.

Goods returned for repair or credit should be clearly identified with the assigned CA or RA number and freight should be prepaid. Ship to the appropriate address below.

*If you are located within the continental U.S., Alaska, Hawaii or Puerto Rico send the goods to:*

Service Department  
Pelco  
3500 Pelco Way  
Clovis, CA 93612-5699

*If you are located outside the continental U.S., Alaska, Hawaii or Puerto Rico and are instructed to return goods to the USA, you may do one of the following:*

If the goods are to be sent by a COURIER SERVICE, send the goods to:

Pelco  
3500 Pelco Way  
Clovis, CA 93612-5699 USA

If the goods are to be sent by a FREIGHT FORWARDER, send the goods to:

Pelco c/o Expeditors  
473 Eccles Avenue  
South San Francisco, CA 94080 USA  
Phone: 650-737-1700  
Fax: 650-737-0933

### REVISION HISTORY

Manual #	Date	Comments
C1522M	10/01	Preliminary version for software version 2.00 Beta.
	1/02	Original version.
	2/02	Updated certifications.
C1522M-A	5/03	Updated with additional functionality (such as Macros triggered by alarms).
C1522M-B	6/04	Removed reference to use 18-gauge wire for EIA RS-485 communication. Updated <i>Important Safeguards and Warnings</i> . Revised Tables B, G, and J, and Figures 46 and 48.
C1522M-C	2/05	Added information on new feature allowing the use of macros for up to three alarm steps; revised memory protection timeframe (as a result of ECO #04-10477). Revised Figure 14 and replaced Figure 20 with previous version from C1522M-A.

Pelco, the Pelco logo, Spectra, Genex, Legacy, Camclosure, Esprit, and Coaxitron are registered trademarks of Pelco.

© Copyright 2005, Pelco. All rights reserved.

C1522M-C (2/05)

79



Worldwide Headquarters  
3500 Pelco Way  
Clovis, California 93612 USA

USA & Canada  
Tel: 800/289-9100  
Fax: 800/289-9150

International  
Tel: 1-559/292-1981  
Fax: 1-559/348-1120

**[www.pelco.com](http://www.pelco.com)**

**ISO9001**

United States | Canada | United Kingdom | The Netherlands | Singapore | Spain | Scandinavia | France | Middle East



## Free Manuals Download Website

<http://myh66.com>

<http://usermanuals.us>

<http://www.somanuals.com>

<http://www.4manuals.cc>

<http://www.manual-lib.com>

<http://www.404manual.com>

<http://www.luxmanual.com>

<http://aubethermostatmanual.com>

Golf course search by state

<http://golfingnear.com>

Email search by domain

<http://emailbydomain.com>

Auto manuals search

<http://auto.somanuals.com>

TV manuals search

<http://tv.somanuals.com>