



PelcoNet™ Multimedia Transmission Via Networks



NET104A Series



G2900M-B (1/03)

CONTENTS

Section	Page
IMPORTANT SAFEGUARDS AND WARNINGS	8
UNPACKING INSTRUCTIONS	8
INSTRUCTIONS FOR THE NETWORK ADMINISTRATOR	9
THE TRANSMITTER	9
THE BROWSER	10
MINIMUM REQUIREMENTS	10
WHAT IS THE PELCONET NET104A TRANSMISSION SYSTEM?	11
HOW DO LANS AND WANS WORK?	11
WHO SHOULD INSTALL THE PELCONET NET104A TRANSMISSION SYSTEM?	11
OVERVIEW	12
DESCRIPTION	12
SOFTWARE VERSION	13
PACKAGE CONTENTS	13
MODELS	13
FRONT PANEL LEDS	14
REAR PANEL CONNECTORS	15
QUICK INSTALLATION GUIDE	16
STEP 1: CONNECTING A CAMERA OR MONITOR	16
STEP 2: CONNECTING ADDITIONAL ITEMS	17
STEP 3: CONNECTING TO THE LAN PORT	17
STEP 4: CONNECTING POWER	18
STEP 5: SELECTING AN IP ADDRESS FOR YOUR NETWORK	19
STEP 6: USING A PC'S WEB BROWSER TO CONFIGURE THE NETWORK	19
STEP 7: WHAT IS NEXT?	19
TYPICAL APPLICATIONS	20
DISPLAYING REMOTE VIDEO ON A WEB BROWSER	20
DISPLAYING VIDEO VIA A TRANSMITTER-TO-RECEIVER CONNECTION	22
DIAGRAMS OF TYPICAL APPLICATIONS	24
HARDWARE INSTALLATION	30
CONNECTING VIDEO SOURCES OR DISPLAYS	30
CONNECTING AUDIO EQUIPMENT	30
CONNECTING DATA TERMINALS	31
USE AS CONTROL TERMINAL PORT	31
USE AS TRANSPARENT DATA PORT	32
CONNECTING EXTERNAL SENSORS	33
CONTROLLING PERIPHERAL DEVICES	34
CONNECTING TO A LAN	34

CONFIGURATION	34
CONFIGURATION USING A TERMINAL PROGRAM	34
TYPICAL SESSION	35
COMMAND REFERENCE	36
CONFIGURATION USING A WEB BROWSER	38
WEB SERVER CONCEPT	38
NET-MANAGER	38
QUICK GUIDE TO THE MENU STRUCTURE	39
PELCONET NET104A HOME PAGE	40
GENERAL CONFIGURATION PAGE	42
NETWORK SETTINGS CONFIGURATION PAGE	46
VIDEO SETTINGS CONFIGURATION PAGE	48
AUDIO SETTINGS CONFIGURATION PAGE	52
ALARM SETTINGS CONFIGURATION PAGE	54
INTERFACE SETTINGS CONFIGURATION PAGE	60
LIVE VIDEO AND SERVER PUSH VIDEO PAGES	62
WEB BROWSER CONTROL PAGES	63
ACCESSING THESE PAGES	63
CONTROLLING THE DISPLAY	64
MATRIX CONTROL LIVE VIDEO/SERVER PUSH PAGE CONTENTS	65
GENEX LIVE VIDEO/SERVER PUSH PAGE CONTENTS	66
SPECTRA LIVE VIDEO/SERVER PUSH PAGE CONTENTS	68
ESPRIIT LIVE VIDEO/SERVER PUSH PAGE CONTENTS	69
ADVANCED FEATURES	70
AUTOMATIC CONNECTION FEATURE	70
VIDEO MOTION DETECTION FEATURE	70
ALARM NOTIFICATION BY E-MAIL	71
RECORD AND PLAY BACK THE DISPLAY ON A PC	71
RECORDING THE DISPLAY	72
PLAYING BACK THE RECORDING	72
FIRMWARE UPLOAD	73
TROUBLESHOOTING	74
BASIC FUNCTIONING	74
GREEN POWER LED	74
ETHERNET LEADS	75
COM LED	75
OUTPUT LEADS	75
INPUT LEADS	75
VIDEO LEADS	76
TERMINAL PROGRAM	76
TROUBLESHOOTING A TCP/IP NETWORK USING A PING UTILITY	76
TROUBLESHOOTING CONNECTION PROBLEMS	77
TROUBLESHOOTING THE VIDEO CONNECTION	77
TESTING THE AUDIO CONNECTION	78
TEST BETWEEN NET104A AND NET101R-A	78
TEST BETWEEN NET104A AND PC	78

SPECIFICATIONS	79
GLOSSARY	81
APPENDIX A – CONNECTING PELCONET NET104A TO VARIOUS COMPONENTS	84
CONNECTING PELCONET TO VARIOUS COMPONENTS WITH ASSORTED KEYBOARDS	85
CONNECTION SCENARIO 1	85
CONNECTION SCENARIO 2	87
CONNECTION SCENARIO 3	89
CONNECTING PELCONET TO THE COM IN RS-232 PORT ON A GENEX MULTIPLEXER	91
CONNECTING A PELCONET RECEIVER TO A SYSTEM CM9502	92
CONNECTING PELCONET TO A CM9502 ASCII SERIAL PORT	93
CONNECTING PELCONET TO A CM6700 AND KBD200A FOR REMOTE ASCII CONTROL	94
CONNECTING PELCONET TO A CM6700 ASCII PORT	95
CONNECTING PELCONET TO A CM9760-DT FOR REMOTE BROWSER CONTROL	96
CONNECTING PELCONET TO CM9760 EQUIPMENT FOR REMOTE COMMUNICATION	97
CONNECTING A PELCONET TRANSMITTER TO THE CM6800 ASCII PORT	99
CONNECTING PELCONET TO A CM6800 AND KBD200A FOR REMOTE ASCII CONTROL	102
APPENDIX B – FREQUENTLY ASKED QUESTIONS (FAQS)	105
INDEX	108
WARRANTY AND RETURN INFORMATION	111

LIST OF ILLUSTRATIONS

Figure		Page
1	Front Panel LEDs	14
2	Rear Panel Connectors	15
3	Connecting Cameras Or Monitor	16
4	Connecting To The LAN Port	17
5	Connecting Power	18
6	PelcoNet NET104A Home Page	21
7	Configuration For Box-To-Box Connections	22
8	LAN Box-To-Box Connection (Transmitter, Receiver, Fixed Camera)	24
9	LAN Box-To-Box Connection (Transmitter, Receiver, Spectra III™)	24
10	LAN Browser-To-Box Connection (Transmitter, Browser, Fixed Camera)	25
11	LAN Browser-To-Box Connection (Transmitter, Browser, Spectra III)	25
12	LAN Browser-To-Box Connection (Transmitter, Browser, Spectra III, Genex®)	26
13	WAN Box-To-Box Connection (Transmitter, Receiver, Fixed Camera)	26
14	WAN Box-To-Box Connection (Transmitter, Receiver, Spectra III)	27
15	WAN Box-To-Box Connection (Transmitter, Receiver, Spectra III, Genex)	27
16	WAN Browser-To-Box Connection (Transmitter, Browser, Fixed Camera)	28
17	WAN Browser-To-Box Connection (Transmitter, Browser, Spectra III)	28
18	WAN Browser-To-Box Connection (Transmitter, Browser, Spectra, Genex)	29
19	Control Terminal Port Pin Assignments in RS-232 Mode	31
20	Data Port Pin Assignments In RS-232 Mode	32
21	Alarm Connections	33
22	PelcoNet NET104A Menu Tree	39
23	PelcoNet Home Page	40
24	PelcoNet NET104A Transmission System Setup Page	41
25	General Settings Configuration Page	42
26	Screen For Entering The Password	45
27	Network Settings Configuration Page	46
28	Video Settings Configuration Page	48
29	Audio Settings Configuration Page	52
30	Alarm Settings Configuration Page	54
31	Interface Settings Configuration Page	60
32	ActiveX Dialog Box	62
33	Device Controls Page	63
34	Matrix Control Page	65
35	Genex Control Page	66
36	Spectra Control Page	68
37	Esprit Control Page	69
38	DB9 Cable Wire Splicing	84
39	KBD300A (Direct Mode) Connected to a Receiver or Spectra Dome System	85
40	KBD4000 Connected to a Multiplexer	87
41	CM9760KBD Connected to a CM9760-CC1 Controller	89
42	Connecting PelcoNet to Genex Using the COM IN RS-232 Port	91
43	Using PelcoNet with CM9505 to Provide Remote Control	92
44	Using PelcoNet with CM9502 to Provide Remote Control	93
45	Using PelcoNet with CM6700 to Provide Remote Control	95

- 46 Using PelcoNet with CM9760-DT to Provide Remote Control of a 9760 Monitor Output .. 96
- 47 Using PelcoNet to Transmit Data and Video Between 9760 Nodes 97
- 48 Using PelcoNet to Receive Data and Video Between 9760 Nodes 98
- 49 Using PelcoNet with CM6800 to Provide Remote Control 100
- 50 Manager Screen 101
- 51 Menu Screen 101
- 52A Using PelcoNet with CM6800 and KBD200A to Provide Remote Control 103
- 52B Using PelcoNet with CM6800 and KBD200A to Provide Remote Control 104

LIST OF TABLES

Table	Page
A Terminal Command Reference	36
B General Settings	43
C Network Settings	46
D Video Settings	49
E Audio Settings	53
F Alarm Settings	55
G Interface Settings	61

IMPORTANT SAFEGUARDS AND WARNINGS

Observe the following WARNINGS before installing and using this product.

1. Installation and servicing should be done only by qualified service personnel and conform to all local codes.
2. Unless the unit is specifically marked as a NEMA Type 3, 3R, 3S, 4, 4X, 6, or 6P enclosure, it is designed for indoor use only and it must not be installed where exposed to rain and moisture.
3. If the unit requires 100/230 VAC and does not have an on/off switch, the input power circuit must have a circuit breaker.
4. The installation method and materials should be capable of supporting four times the weight of the unit.

The product and/or manual may bear the following marks:



This symbol indicates that dangerous voltage constituting a risk of electric shock is present within this unit.



This symbol indicates that there are important operating and maintenance instructions in the literature accompanying this unit.

CAUTION:
RISK OF ELECTRIC SHOCK. DO NOT OPEN.

Please thoroughly familiarize yourself with the information in this manual prior to installation and operation.

UNPACKING INSTRUCTIONS

Unpack and inspect all parts carefully. Save the shipping carton, boxes, and inserts. They are the safest manner in which to make future shipments.

If an item appears damaged in shipment, replace it properly in its box and contact the factory at 1-800-289-9100 or 1-559-292-1981 for a replacement. (International customers fax 1-559-348-1120 for authorization and instructions.)

If an item needs to be returned to the factory for repair, consult the WARRANTY AND RETURN section of this manual for instructions.

INSTRUCTIONS FOR THE NETWORK ADMINISTRATOR

The PelcoNet™ NET104A Multimedia Transmission System allows live video transmission to be viewed over TCP/IP-based networks. This section is intended to help the network administrator know what is involved with installing this product and how it will affect the network. The person installing the product will need the following information about the network to make the product function properly.

THE TRANSMITTER

- A valid IP address* for each PelcoNet NET104A Transmission System unit
- Subnet mask*
- Default gateway (if applicable)
- E-mail server's IP address (if applicable)
- Dedicated maximum allowable amount of bandwidth for live video**

* = Required for the PelcoNet NET104A Transmission System to function properly.

** = The PelcoNet NET104A Transmission System requires a continuous amount of bandwidth to display true live video. Pelco recommends using switching hubs with the product so the amount of bandwidth available to each unit is constant and reliable.

THE BROWSER

If you plan to use a web browser to view live video across the network, there are procedures to complete before you can use the browser. If you installed Internet Explorer 5.5 from the CD that came with the PelcoNet NET104A Transmission System, you can skip the following. Otherwise, complete the following before trying to use the browser.

1. Internet Explorer 5.5 or higher must be installed before continuing.
2. Set the computer's display settings to use 16- or 32-bit color. (This is required for the live video feature to function properly.)
3. Click the **Start** menu in Windows®.
4. Click **Run**.
5. In the open box, type **D:/PACTIVEX.EXE** (where D:/ = your CD ROM drive letter).
6. Click **OK**.
7. Follow the on-screen setup instructions to finish installing the plug-in.

MINIMUM REQUIREMENTS

- PC with Windows 95/98/NT/2000/XP
- Gateway to the network
- Microsoft® Internet Explorer 5.5 or free serial interface and terminal program or PelcoNet receiver and video monitor
- Screen resolution of 800 x 600 pixels or higher, 16- or 32-bit pixel color resolution

WHAT IS THE PELCONET NET104A TRANSMISSION SYSTEM?

The PelcoNet NET104A Transmission System is technology that lets you view video from four sources in **real time** across a LAN (local area network) and even WANs (wide area networks). This technology is based on the TCP/IP protocol suite and Ethernet technology, providing compatibility with today's networking standards.

(See the *Glossary* section for definitions of terms used in this manual.)

HOW DO LANs AND WANs WORK?

- A LAN consists of multiple computers connected together, sharing information. This information could be files, e-mail, printers, or—with the PelcoNet NET104A Transmission System—even live video and audio.
- A WAN consists of multiple LANs connected over a great distance (for example, the Internet).
- In any network environment, each computer needs an address so other computers on the network know how to reach it.

It is similar to a city with street addresses. For the post office to deliver mail to your house, you need a unique street address for the mail carrier to find you. A network is like the city. Like a street address, the IP address on your computer is your address on the network. The IP address is how other computers can find you on the network.

Remember that the **IP address must be unique on the network**.

- When there are multiple networks and you are using the TCP/IP protocol, there must be a way to communicate between the two networks. A physical device called a router is required. The router's IP address is referred to as the default gateway IP address.
- A cable that connects one computer to another is like a city street you can use to get from one house to another. The cable lets you communicate with each other on the network. This cable is Category 5 cable with RJ-45 connectors at each end. (It looks like a phone cord, only slightly larger.)

WHO SHOULD INSTALL THE PELCONET NET104A TRANSMISSION SYSTEM?

NOTE: Consult your network administrator if you need help.

Installation is a matter of configuring an IP address using a standard terminal program or any Internet browser and connecting the PelcoNet NET104A Transmission System to the Ethernet network. You should have the following background and experience to configure and install these units:

- Working knowledge of basic network management concepts and terminology
- Working knowledge of tools and procedures for installing and operating sensitive electronic equipment

OVERVIEW

NOTE: This manual refers to the PelcoNet NET104A Transmission System when discussing features, functions, or specifications that apply to the transmitter. "Receiver," as used in this manual, refers to a PelcoNet NET101R/R-A Transmission System receiver unless otherwise noted.

DESCRIPTION

The four-channel PelcoNet NET104A Transmission System lets you transmit live video, audio, and data from four sources over existing Ethernet computer networks (either intranet or Internet) using the TCP/IP protocol. The NET104A can multiplex to provide a single view or quad view. You can view the pictures on a CCTV or PC monitor.

The NET104A is a transmitter and is the only unit required to use the PelcoNet NET104A Transmission System. The transmitter connects any four NTSC or PAL video sources (cameras, for example) to the computer network.

Depending on how you want to display the video, you can use a transmitter and a PC or a transmitter and a NET101R/RA receiver. There are two ways to display remote video:

- A hardware receiver and attached standard NTSC or PAL monitor
- Web browser using any PC on the network to display the video

A NET104A transmitter and NET101R receiver can form a standalone system for data transfer without a PC. The system can be extended to include additional transmitters and receivers so video sequences from one transmitter can be received by several receivers simultaneously.

Transmitters and receivers are identified by IP addresses, just like any other equipment connected to a computer network.

There is a bi-directional serial interface for remote control of peripherals like PTZ cameras. The NET104A transmits full-duplex audio.

In appropriately configured networks, the multicast function permits the simultaneous video transmission in real time to several NET101R/RA receivers. For this to work, the ICMP (multicasting protocol) must be implemented in the network.

SOFTWARE VERSION

This manual documents PelcoNet NET104A software version 5.70.

PACKAGE CONTENTS

The following are supplied:

Qty	Description
1	NET104A model with plug-in power pack
1	Power cord
1	Power supply adapter (model specified with order; refer to the Specifications section in this manual for model number)
1	PelcoNet peripheral device control cable
1	Wall mount kit
1	1 Mount bar
2	Machine screws
4	Wood screws
4	Plastic molly fasteners
1	CD

Keep the carton, including the original packaging material, to repack the equipment if you need to return it for repair.

MODELS

NET104A Four-channel video transmitter with integrated Ethernet connection. The NET104A has a separate plug-in power pack. The NET104A functions as a data server only for transmitting data.

Optional Compatible Products

NET101R Single-channel video receiver with integrated Ethernet connection

NET101R-A Single-channel video receiver with bi-directional audio and integrated Ethernet connection

FRONT PANEL LEDs

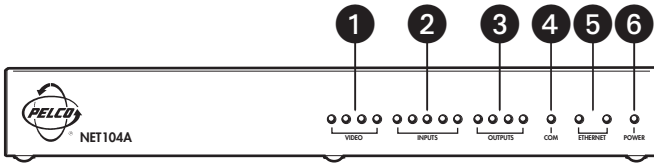

Key:

- 1 = Video LEDs light green when the corresponding input is active.
- 2 = Input LEDs light red with active alarm and light green when ready.
- 3 = Output LEDs light green when the corresponding relay is switched.
- 4 = COM LED lights yellow when data is transmitted over the serial interface.
- 5 = One Ethernet LED lights green when the unit is connected to the network. The other flashes yellow when data packages are transmitted.
- 6 = Power LED lights green when ready.

Figure 1. Front Panel LEDs

REAR PANEL CONNECTORS

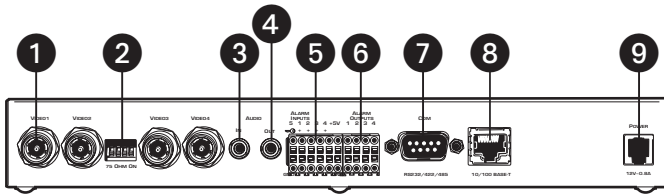

Key:

- 1 = Four BNC video inputs for connecting the video sources
- 2 = DIP switches (75 ohms when ON) for terminating the corresponding video input if the video signal is not connected to additional video equipment
- 3 = 3.5 mm monaural audio input jack for connecting the audio source
- 4 = 3.5 mm monaural audio output jack for connecting a loudspeaker
- 5 = Input terminals for connecting alarm sensors or switches
- 6 = Output terminals for switching external devices (for example, lamps)
- 7 = COM serial interface—9-pin D-sub connector (male)—for transmitting control data and for configuring with the terminal program
- 8 = Ethernet RJ-45 jack for connecting with the network
- 9 = Power jack for connecting the plug-in power supply

Figure 2. Rear Panel Connectors

NOTE: Use only the supplied power plug. If the cable or connector show any sign of damage, do not use the plug. Send it in for repair or replacement. Never try to use any power plug except the supplied one.

QUICK INSTALLATION GUIDE

Follow the next six steps for the fastest way to get your product operating.

STEP 1: CONNECTING A CAMERA OR MONITOR

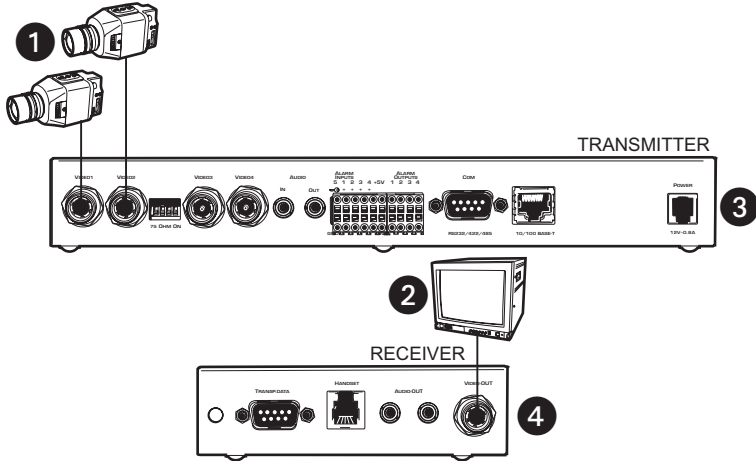

Key:

- 1 = Cameras or other video sources with composite PAL or NTSC output
- 2 = Video monitor with composite PAL or NTSC input
- 3 = NET104A transmitter
- 4 = NET101R/RA Receiver

Figure 3. Connecting Cameras Or Monitor

- To connect the cameras, plug one end of a standard coaxial cable into a BNC connector (start with video 1) on the rear of the NET104A and the other end into the camera. You can use any video source with a composite PAL or NTSC output.
- Set the DIP switches on the NET104A to position 75 OHM ON (down) to terminate the inputs when the video signal is not connected to additional video equipment through a T-connection.
- To connect a monitor to the NET101R/R-A receiver, plug one end of a standard coaxial cable into the BNC connector on the NET101R/R-A and the other end into the monitor. You can use any PAL or NTSC video monitor with a composite PAL or NTSC input.

For more information about video sources and monitors, see the *Hardware Installation* section.

STEP 2: CONNECTING ADDITIONAL ITEMS

Connect any additional items, such as alarms, audio, etc.

STEP 3: CONNECTING TO THE LAN PORT

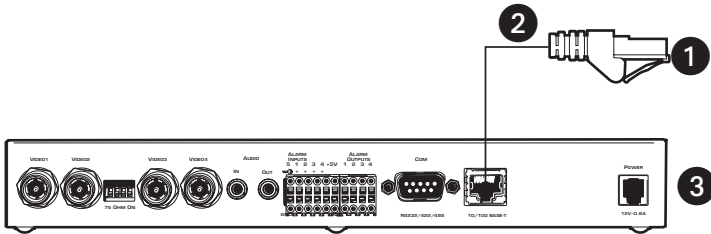

Key:

- 1 = Ethernet (10BASE-T) LAN connection to hubs, network, PCs (RJ-45 connector)
- 2 = Ethernet Cat5 cable
- 3 = Transmitter

Figure 4. Connecting To The LAN Port

To connect to the Ethernet network, use a standard UTP Cat5 cable with RJ-45 connectors. Plug one end of the cable into the RJ-45 receptacle labeled "Ethernet." The connection to a 10BASE-T network can be made directly via a hub or switch.

STEP 4: CONNECTING POWER

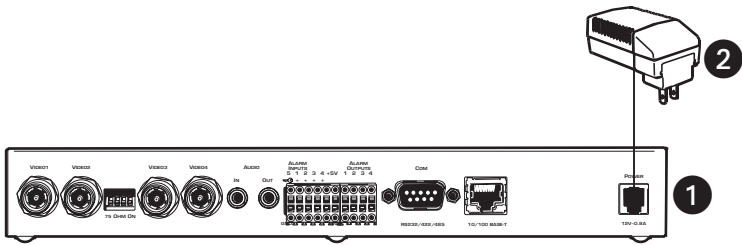

Key:

- 1 = Transmitter
- 2 = AC power plug adapter

Figure 5. Connecting Power

The transmitter and receiver have no main power switch. Insert the power cable plug into the power jack on the unit until it latches. Plug the other end into the wall socket.

The green POWER LED on the front of the unit lights up, showing the unit is ready for operation. When the network is connected properly, the green ETHERNET LED lights.

STEP 5: SELECTING AN IP ADDRESS FOR YOUR NETWORK

NOTE: Consult your network administrator for a valid IP address.

The NET104A comes with the default address 192.168.0.1, while a NET101R/R-A receiver's default address is 192.168.0.2. Before operating the system inside your own network, you need to set a valid IP address.

Use a terminal program attached at the RS-232 control terminal port to change the IP address.

Refer to the *Configuration Using A Terminal Program* section for a description of IP address configuration using a terminal program.

STEP 6: USING A PC'S WEB BROWSER TO CONFIGURE THE NETWORK

Configure the network using a web browser. Start your web browser and connect to the URL **http://IP-Address**, where IP-Address is the IP address of the unit you want to configure. Use the standard dot-separated format (x.x.x.x.) to enter the address.

Refer to the *Configuration Using A Web Browser* section for detailed configuration instructions.

STEP 7: WHAT IS NEXT?

The system essentially is ready to use at this point. What you do now is up to you. For example, you can connect to the web browser to watch one or more camera views or configure additional options (alarms, default gateways, etc.) on the configuration pages.

TYPICAL APPLICATIONS

DISPLAYING REMOTE VIDEO ON A WEB BROWSER

The NET104A transmitter uses Motion-JPEG video compression or high performance H.323 coding for transmitting across the network. This enables transmission to standard web browsers of either live video (Live Video mode) or a stream of still images (Server Push mode).

- To activate the Live Video feature, click **Live Video** above the video window on the PelcoNet NET104A Transmission System home page (see Figure 6). The unit transmits using the H.323 coding format for display in the browser.

To stop Live Video, click any other option at the top of the page.

- To activate the Server Push feature, click **Server Push** above the video window on the home page. The unit continuously grabs snapshots to be JPEG encoded, transferred, and displayed continuously by the browser.

To stop Server Push, click any other option at the top of the page.

The PelcoNet NET104A Transmission System can display live video to an infinite number of users at a time (multicasting) or up to five users at a time (multi-unicasting). A sixth user connecting to the same transmitter in a multi-unicast configuration cannot receive live video. In a unicast configuration, only one user at a time can receive live video.

Server Push can support multiple users simultaneously on the same transmitter. Image quality is good with an update rate of one image about every 2 to 10 seconds depending on the number of users and available bandwidth.

Browsers that do not support live video technology can display an updated still image or a stream of images in Server Push mode.

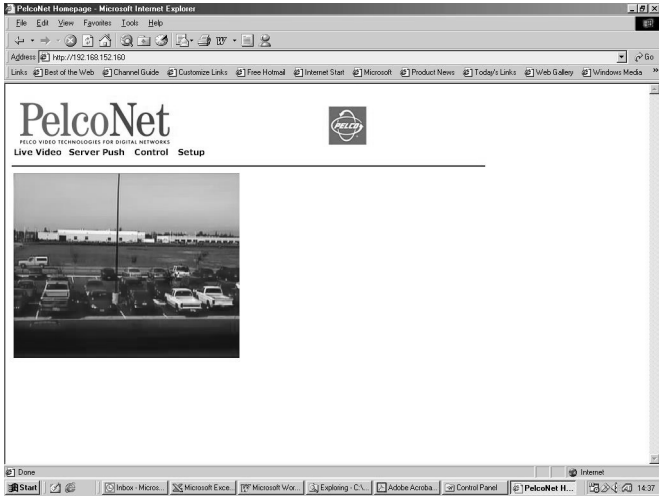

Figure 6. PelcoNet NET104A Home Page

DISPLAYING VIDEO VIA A TRANSMITTER-TO-RECEIVER CONNECTION

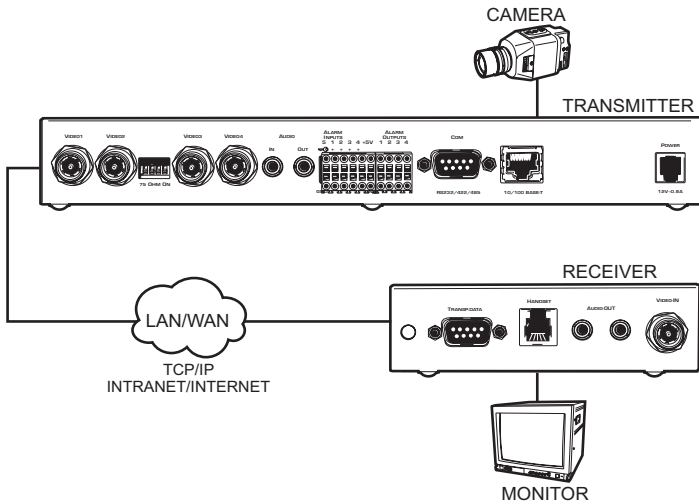

Figure 7. Configuration For Box-To-Box Connections

There are two ways to make a high performance multimedia transmission system for computer networks:

- One way is to use just the NET104A transmitter and connect it through the computer network to a PC with a web browser at the receiving end.
- Another way is to connect the NET104A transmitter through the computer network to a NET101R/R-A receiver. This is often called a box-to-box connection because it uses two PelcoNet units.

In either case, routing dedicated cables from a camera to a monitor is not required because you can use the existing computer network for that purpose.

The following explains a box-to-box connection.

1. First, transmitter (NET104A) and receiver (NET101R/R-A) need to be configured appropriately. If the units are supposed to be operated in different subnets, a gateway IP address must be configured. Use the alarm IP address field to address the destination. Also, the transmitter's video standard must be set to H.261. Enter the settings using either a terminal program or a web browser.

You also must disable Internet proxy settings. To do so: In Internet Explorer, click the **Tools** button, **Internet Options**, the **Connections** tab, and the **LAN Settings** button. Then remove the check mark in the **Use a proxy server** box. Click **OK**, and then **OK** again.

2. Once all addresses are configured, type **c** in the terminal window to establish the actual connection or program the live video receive IP and enable the live auto connect setting through the web browser. Make sure the alarm IP address in the unit that will initiate the connection points to the destination unit. After a few seconds, video transmission begins and the camera scene appears on the monitor attached to the receiver.

Instead of using a terminal program for establishing a connection, you can attach a contact to the alarm input. Make sure the alarm input is enabled.

You can use a web browser to connect to either of the two units, even during an active box-to-box connection. This way you can make changes to the configuration and immediately see the result of the setting (for example, when changing video quality). If you are connected to the transmitter, the camera pictures are sent to the receiver and web browser simultaneously. There will be a short break in the video display on the receiver monitor whenever the web browser requests a new frame. This is especially noticeable with the Server Push feature.

Full-duplex audio can be transmitted in parallel with the video transmission in units equipped to handle audio. To do so, you need to use the web browser to enable audio on the Audio Settings configuration page.

Transparent data is always transmitted automatically between the two units as soon as the connection becomes active. Data bytes entering the interface are transported to the other end transparently. There is no flow control mechanism for the data channel. Overflowing the serial interface will cause data loss.

To sever the connection from either end, type **d** in the respective terminal window (or disable the alarm).

DIAGRAMS OF TYPICAL APPLICATIONS

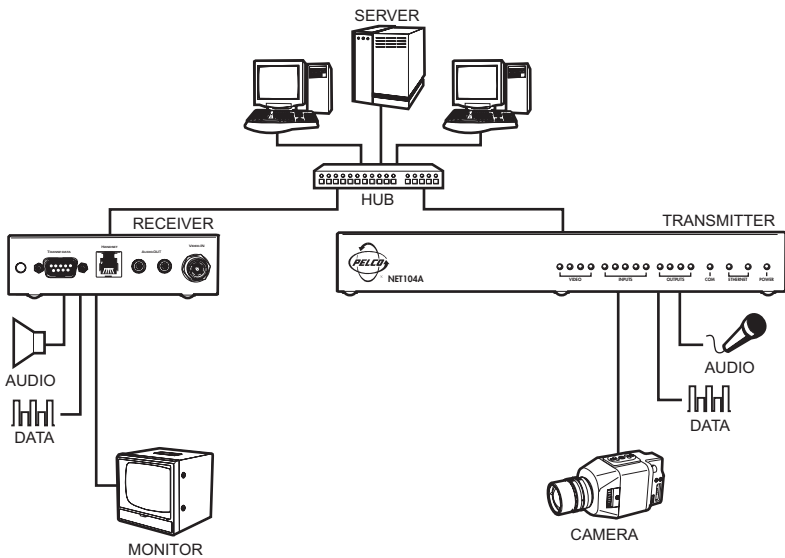

Figure 8. LAN Box-To-Box Connection (Transmitter, Receiver, Fixed Camera)

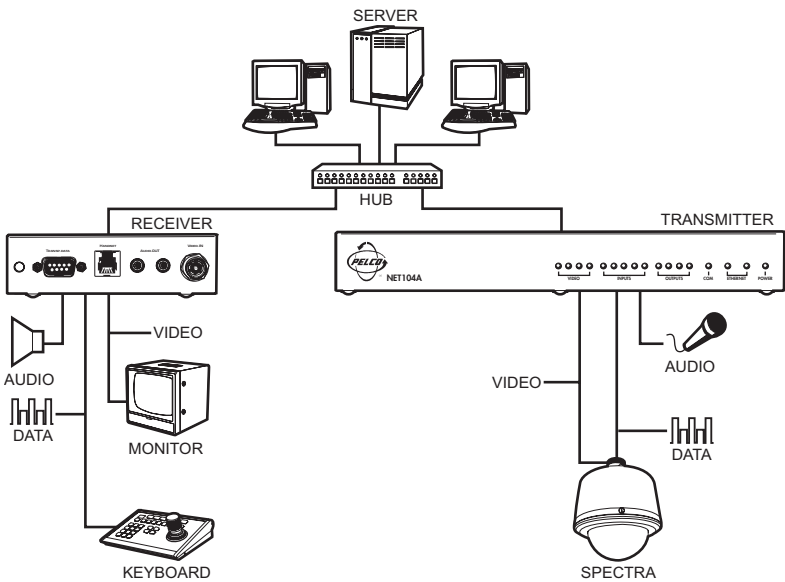

Figure 9. LAN Box-To-Box Connection (Transmitter, Receiver, Spectra)

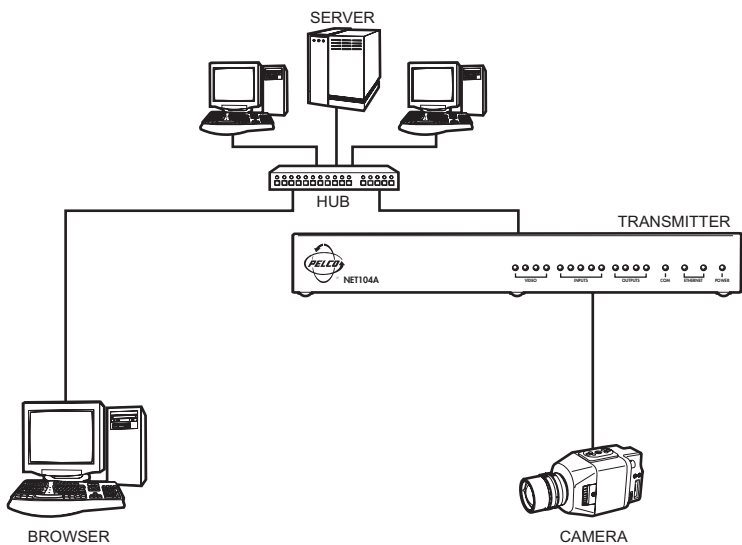

Figure 10. LAN Browser-To-Box Connection (Transmitter, Browser, Fixed Camera)

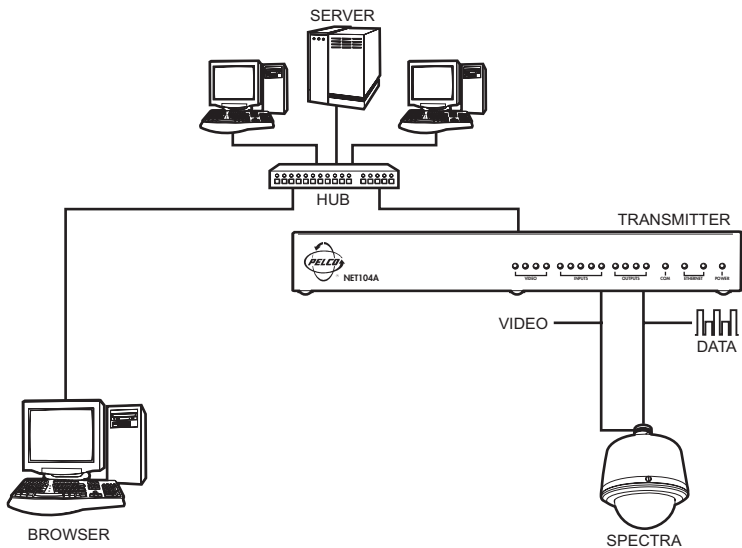

Figure 11. LAN Browser-To-Box Connection (Transmitter, Browser, Spectra)

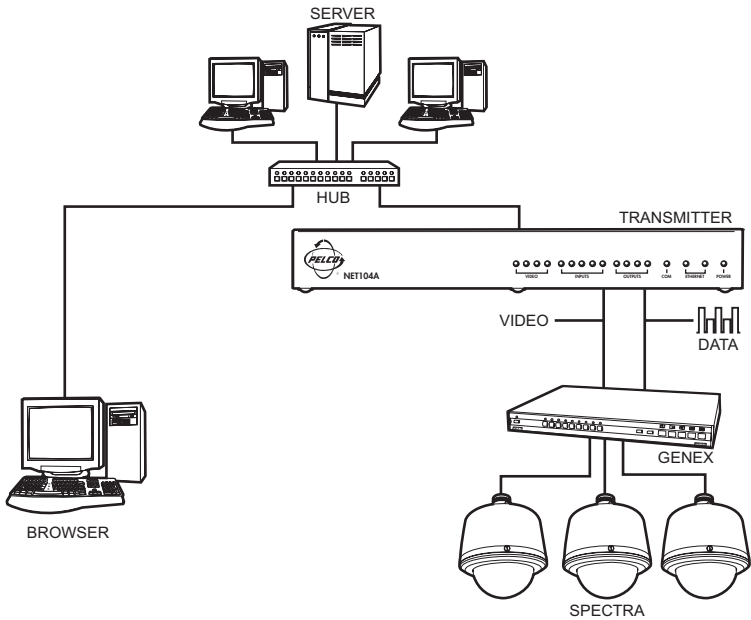

Figure 12. LAN Browser-To-Box Connection (Transmitter, Browser, Spectra, Genex®)

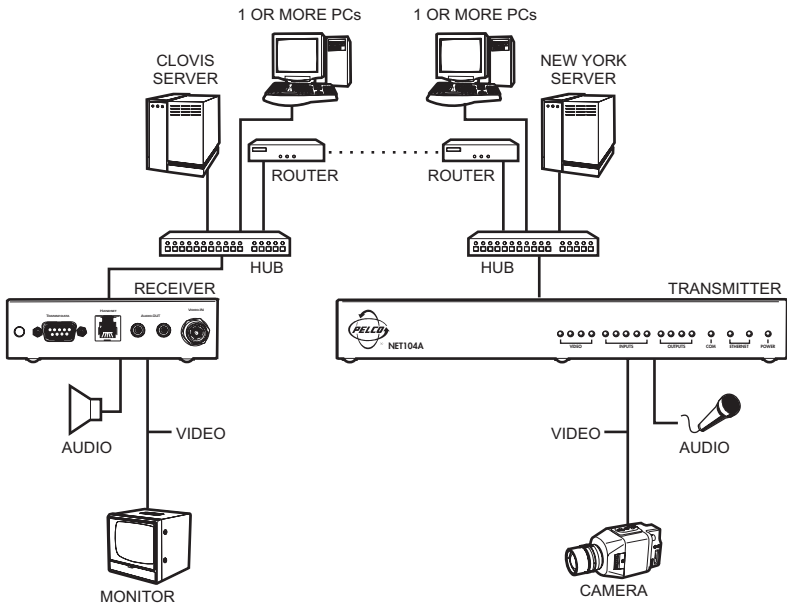

Figure 13. WAN Box-To-Box Connection (Transmitter, Receiver, Fixed Camera)

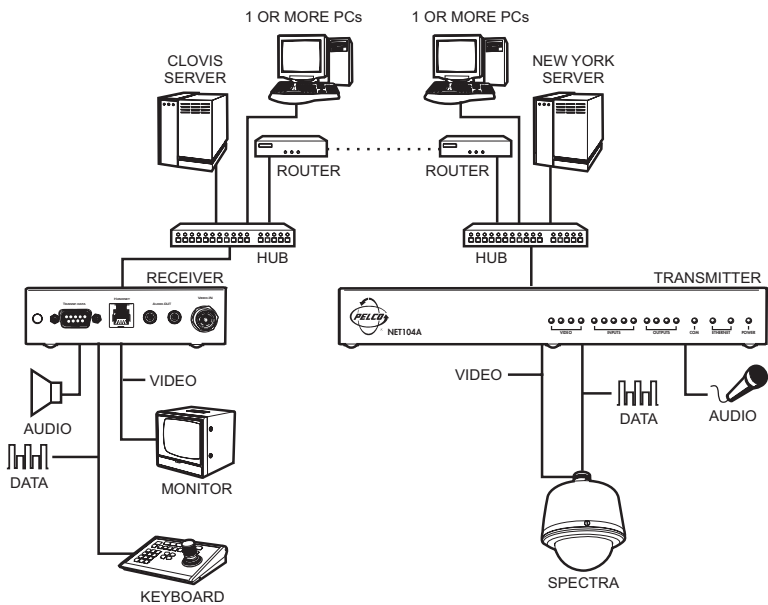

Figure 14. WAN Box-To-Box Connection (Transmitter, Receiver, Spectra)

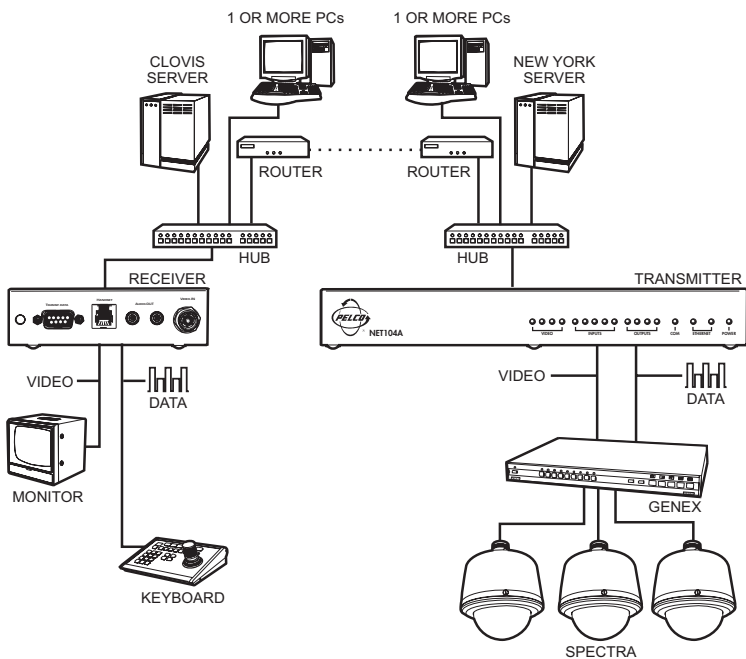

Figure 15. WAN Box-To-Box Connection (Transmitter, Receiver, Spectra, Genex)

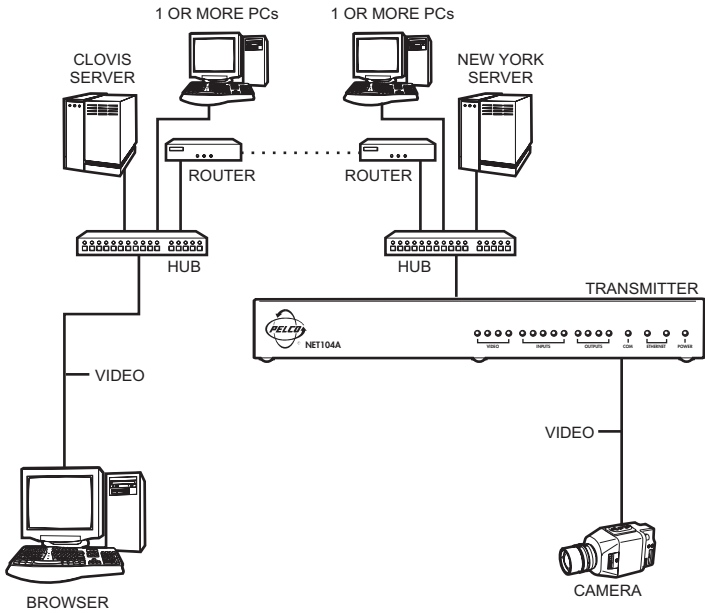

Figure 16. WAN Browser-To-Box Connection (Transmitter, Browser, Fixed Camera)

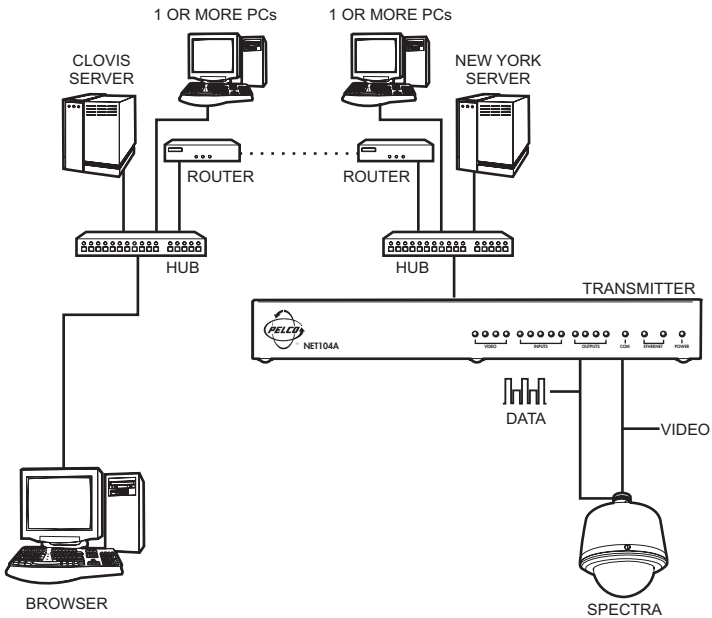

Figure 17. WAN Browser-To-Box Connection (Transmitter, Browser, Spectra)

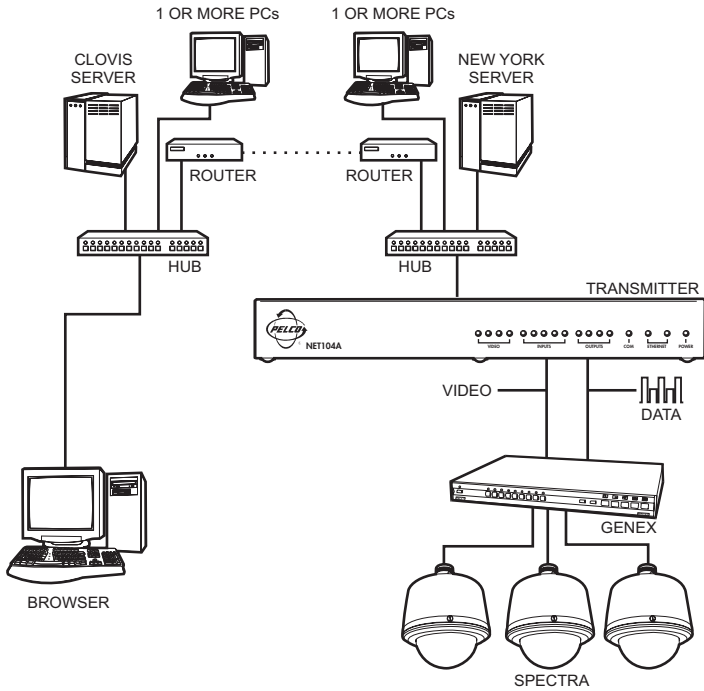

Figure 18. WAN Browser-To-Box Connection (Transmitter, Browser, Spectra, Genex)

HARDWARE INSTALLATION

Refer to *Appendix A – Connecting PelcoNet NET104A To Different Components* for diagrams that show various connections.

CONNECTING VIDEO SOURCES OR DISPLAYS

Up to four video sources can be connected to the NET104A.

1. To connect cameras, plug a standard coaxial cable into a BNC connector (start with video 1) on the rear of the NET104A and the other end into the camera. You can use any video source (for example, a VCR) with a composite PAL or NTSC output. The inputs accept color or black and white sources and automatically detect whether they are PAL or NTSC. The video inputs have an internal termination of 75 ohms.
2. Set the DIP switches to position 75 OHM ON (down) to terminate the inputs when the video signal is not connected to additional video equipment through a T-connection.

CONNECTING AUDIO EQUIPMENT

The NET104A provides an audio channel via the audio in and out jacks.

1. Connect the microphone to the AUDIO IN jack.
2. Connect the loudspeaker to the AUDIO OUT jack. (This is not required if you are using the speakers on your PC.)

The audio signals are transmitted bi-directionally and simultaneously with the video signals. This allows control of a loud speaker or door intercom system, for example, at the monitored location.

CONNECTING DATA TERMINALS

The NET104A has a serial interface that can be configured on the Interface Settings configuration page for terminal control or transparent data: RS-232 or RS-485, etc.

Use As Control Terminal Port

For local control and configuration of the unit, you can connect a data terminal (for example, a PC running a standard terminal program) to the serial interface labeled COM on the NET104A. The 9-pin D-sub connector can be connected to a PC's COM port.

You can use a standard terminal program to communicate with the unit. The default parameters are set to 19200 baud, 8 bits of data, 1 stop bit, and no parity (8N1).

To access the online help, type ? (a question mark) in the terminal window. For more information on the command set, see the *Configuration* section. This mode allows the control port to be used to send serial data that requires flow control.

You can configure the RS-485 half-duplex mode in the web browser. The RTS and CTS signals are enabled for flow control.

If this RS-485 mode is chosen, the camera control data is transferred to this port. Certain cameras with fixed data length require the buffered RS-485 mode. (This half-duplex mode is not required for interfacing to any Pelco product.)

Pin	Name	Direction	Description
1	DCD	Input	Data Carrier Detect
2	RXD	Input	Receive Data
3	TXD	Output	Transmit Data
4	DTR	Output	Data Terminal Ready
5	GND		Ground
6	DSR	Input	Data Det Ready
7	RTS	Output	Ready To Send
8	CTS	Input	Clear To Send
9	—	—	—

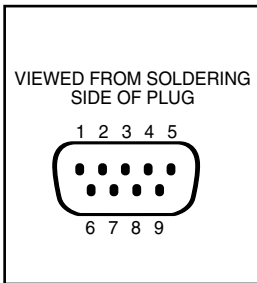

Figure 19. Control Terminal Port Pin Assignments in RS-232 Mode

Use As Transparent Data Port

The serial interface offers a transparent serial data channel between the receiver and the transmitter. A typical application for transparent data is remote control of peripheral equipment (for example, a dome system with PTZ functions). You also can use this channel to control remotely any external device with a serial interface. The serial data is transferred in parallel to the video and audio data.

Transmission of transparent data is enabled only after a video connection has been established. Also, the RS-232 interface for the transparent data port does not support hardware flow control.

For proper operation, you must configure the following in a way that they fit the associated unit: baud rate, parity of the interface of the PelcoNet NET104A Transmission System unit, and number of data and stop bits. Use a web browser to configure these parameters at the unit with the configuration side.

The transparent data interface is used to control PTZ cameras remotely, to transmit data transparently between two units, or to control equipment connected to a PC COM port. Transmission of transparent data is possible only when the units are connected. Only the data transmitting signals are provided at this port.

	Pin	Name	Direction	Description
 <p>VIEWED FROM SOLDERING SIDE OF PLUG</p>	1	–		N.C.
	2	RXD	Input	Receive Data
	3	TXD	Output	Transmit Data
	4	–		N.C.
	5	GND		Ground
	6	–		N.C.
	7	–		N.C.
	8	–		N.C.
	9	–		N.C.

Figure 20. Data Port Pin Assignments In RS-232 Mode

CONNECTING EXTERNAL SENSORS

The unit has four alarm inputs that let you connect external signaling devices, like door contacts or motion detectors. If configured accordingly, an alarm trigger can, for example, set up an automatic connection between NET104A and the remote station. You can connect switches or contacts directly without a separate power supply.

Connection INPUT 5 is a master alarm. This connection lets you activate or bar (for example, by means of a key-operated switch) all the alarm triggers.

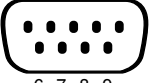
NOTE: Do not connect the ground terminals to earth ground. External switching voltage must not exceed 12 VDC.

The four alarm inputs are optically isolated from the other components of the NET104A via optocouplers and require a voltage of 5-12 VDC for switching.

Do the following to connect external sensors. Refer to Figure 21.

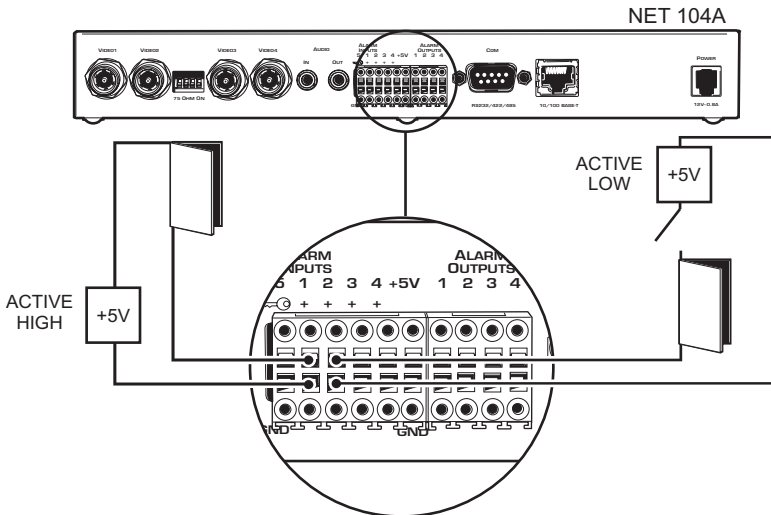

Figure 21. Alarm Connections

1. Pull the terminal block INPUTS from its plug-in base.
2. Attach the conductors to the alarm input and ground terminals. (Push a small screwdriver or similar instrument into the square opening. This opens the circular opening. Insert the wire into the circular opening, and then remove the screwdriver.)
3. Push the terminal block back on to the plug-in base.

CONTROLLING PERIPHERAL DEVICES

The NET104A has four relay outputs for switching external devices (for example, lights or sirens). The relays can be operated interactively, during an active connection, or automatically to coincide with certain events. Settings for the relay must be configured (see the *Configuration* section).

Typical applications of the relay outputs are activating electric door openers or switching of lights and other electrical devices. Do not exceed the maximum rating of 24V and 0.8A.

Do the following to connect peripheral devices. Refer to Figure 2.

1. Pull the terminal block OUTPUTS from its plug-in base.
2. Attach the conductors to the pairs of relay terminals.
3. Push the terminal block back on to the plug-in base.

CONNECTING TO A LAN

To connect to a 10BASE-T network, plug a standard UTP/Cat5 cable with RJ-45 connectors into the receptacle labeled ETHERNET on the NET104A. You can connect directly to the Ethernet network. The green Ethernet LED on the front of the unit (refer to Figure 1) lights as soon as the connection to the network is correct physically and synchronized with the LAN. Check the cable or see the *Troubleshooting* section if the LED does not light.

The second Ethernet LED flashes yellow when data packages are transmitted.

CONFIGURATION

There are two ways to configure your system:

- The most basic control and configuration is accomplished by connecting a terminal to the RS-232 terminal port.
- A more convenient, complete configuration and display of video is through the built-in HTTP server, which connects to any standard web browser. This is the recommended method.

CONFIGURATION USING A TERMINAL PROGRAM

Using a terminal program (for example, the Windows application HyperTerminal) connected to the RS-232 terminal port on the unit's rear panel provides limited configuration and control capabilities (null modem cable required). Ensure that the PC's COM port is set up properly (default parameters are 19200 baud, 8N1) and that the local terminal echo is disabled.

All commands consist of single characters you type inside the terminal window. Enter only one command at a time and do not terminate this input by pressing the Enter key. After entering a value (for example, an IP address), check the entered characters again and only then press Enter to transmit the values to the NET104A.

Do the following:

1. First, disconnect the NET104A from the network.
2. Connect the D-sub COM jack on the NET104A to a free serial port on the PC.
3. Click the **Start** button on your PC's desktop, and then select **Programs** from the Start menu.
4. Highlight **Accessories**. Click **HyperTerminal**.
5. Double-click **Hypertrm.exe** to open HyperTerminal.
6. Type the name for the new connection in the **Name** field. Click **OK**.

7. Change the **Connect using** field to the COM port of the computer to which you have connected the serial cable. Click **OK**.
8. Change the **Bits per second** field to **19200**.
9. Change the **Flow control** field to **None**. Click **OK**.
10. Hold the **Shift** key and press the **?** key to bring up the Help menu.
11. Press the **I** key to set the IP address. Type the new IP address PelcoNet will be using on the network. Press **ENTER**.
12. Press the **S** key to set the subnet mask. Type the new subnet mask. Press **ENTER**.
13. Press the **G** key to set the gateway IP address. Type the new gateway IP address. Press **ENTER**.
14. Close HyperTerminal. If prompted to save settings, click **OK**.

The following section shows a typical terminal session.

Typical Session

The help screen appears as follows in the terminal window:

```

*****
Help menu
?  this site
i  set the IP address
s  set the subnet mask
g  set the gateway IP address
a  set the alarm IP
c  connect to alarm IP
d  disconnect from alarm IP
D  disconnect all connections
m  display MAC address
v  display version information
b  display current transmission data rate
t  toggle DHCP on/off

```

disable 'local echo' for a better display!

```
*****
```

NOTE: You cannot use backspace during a terminal session—if you mistype a character, end your entry by pressing Enter and try again. If you see duplicate characters on any entry, the “local echo” feature of your PC’s terminal program is not disabled.

If you are using the terminal to set up the unit’s IP address, just type **i** and you are prompted to enter a new IP address:

```

i
->Enter new IP address (old:192.168.0.1): 192.168.0.5 (Enter)
->IP address set to 192.168.0.5

```

If you want to establish a live video connection to a remote unit, you have to specify the remote IP address by typing **a** and entering the remote IP address in the same manner as the unit IP address as shown in the example above.

To establish a connection, type **c**; to disconnect, type **d**.

Command Reference

The following table gives an overview of all available commands. (Enter the appropriate information where indicated by the quotation marks below. Do not enter the quotation marks.)

Table A. Terminal Command Reference

Cmd	Description
?	Displays the help screen.
i	Set up a new IP address. -> Enter new IP address (old:192.168.152.160): 'new IP address' [Enter] -> IP address set to <new IP address>
s	Set up a new subnet mask. -> Enter new subnet mask (old:255.255.255.0): 'new subnet mask' [Enter] -> subnet mask set to <new subnet mask>
g	Set up a new gateway IP address. -> Enter new gateway IP address (old:192.168.0.10): 'new gateway IP address' [Enter] -> gateway IP address set to <new gateway IP address>
a	Set up a new alarm IP to connect to. -> Enter new alarm IP address (old:192.168.0.3): 'new alarm IP address' [Enter] -> Alarm IP address set to <new alarm IP address>
c	Connects a live video to the specified alarm IP. -> connecting . . . PelcoNet tries to call the alarm IP host connected PelcoNet has established the connection
d	Disconnects any pending video connection. -> disconnecting . . . PelcoNet disconnects disconnected PelcoNet has disconnected

D	<p>Closes the connection from the connecting IP address.</p> <p>-> Close connection from <IP address></p>
m	<p>Display the unit's MAC address.</p> <p>-> MAC address: <unit' s MAC address></p>
v	<p>Display version information.</p> <p>-> HW version: <version number> SW version: <version number></p>
b	<p>Displays the current transmission data rate. The display is updated continuously.</p>
t	<p>Toggles the DHCP (Dynamic Host Configuration Protocol) on/off.</p> <p>-> DHCP on</p> <p>-> DHCP started</p> <p>-> DHCP BOUND <IP address, subnet, gateway></p> <p>or</p> <p>-> DHCP off</p>

CONFIGURATION USING A WEB BROWSER

In addition to the aforementioned configuration using a terminal program, which only covers the most basic settings, a web browser is the tool of choice for a more complete configuration. To accomplish this, the system features a complete HTTP server.

Microsoft Internet Explorer 5.5 is the recommended browser.

Web Server Concept

1. Start your web browser.
2. Connect to the URL **http://IP-Address**, where IP-Address is the IP address of the unit you want to configure. Use the standard dot-separated format (x.x.x.x.) to enter the address. The home page is displayed with the video from input 1 being shown.

The HTTP server provides six separate pages for configuration.

You can return to the home page from any other page by clicking on the PelcoNet logo on the left side. Clicking the Pelco® logo while on the home page immediately transfers you to the Pelco Internet home page, provided the network allows for Internet access.

In order for live video images to be decoded, the special ActiveX control file must be installed on your PC. The latest version of ActiveX comes on the PelcoNet CD.

NET-Manager

NET-Manager is a program that can make it easier to configure PelcoNet units in local networks. The program and manual (C2901M) are on the resource CD that comes with your PelcoNet unit. Refer to the manual for instructions.

Quick Guide To The Menu Structure

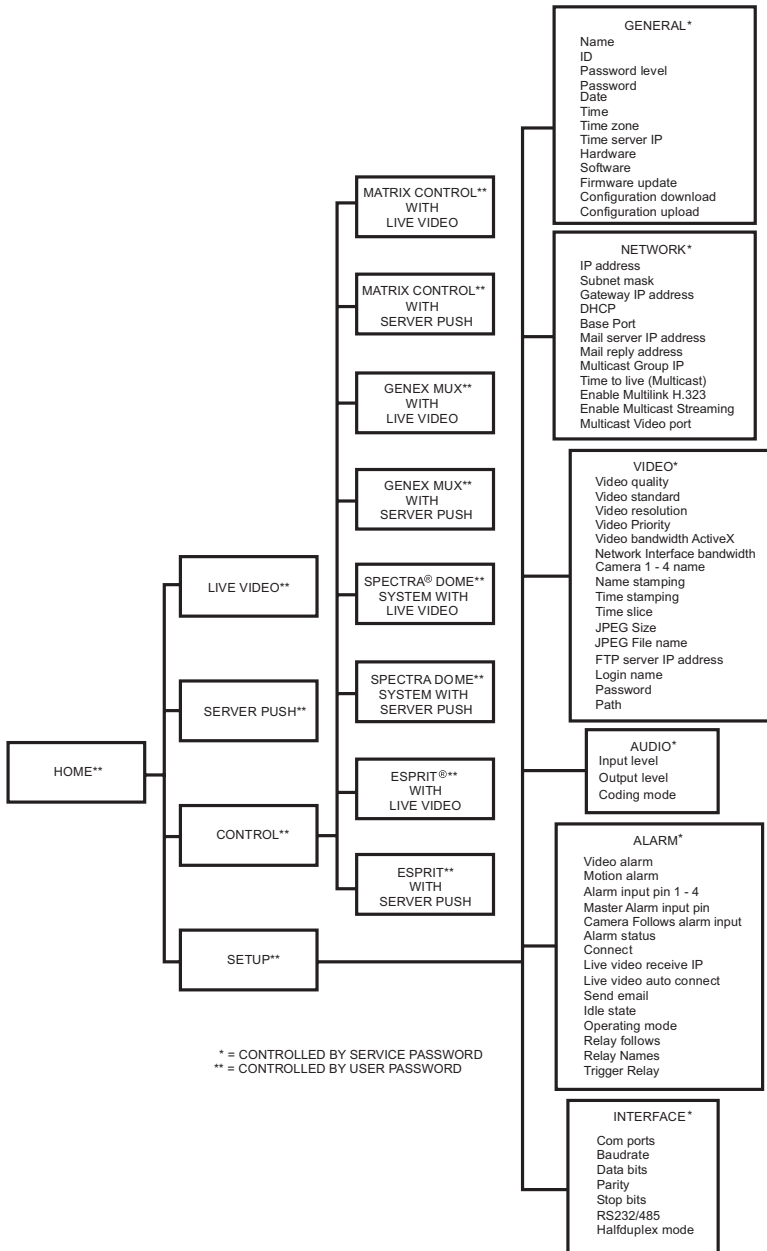

00944

Figure 22. PelcoNet NET104A Menu Tree

PelcoNet NET104A Home Page

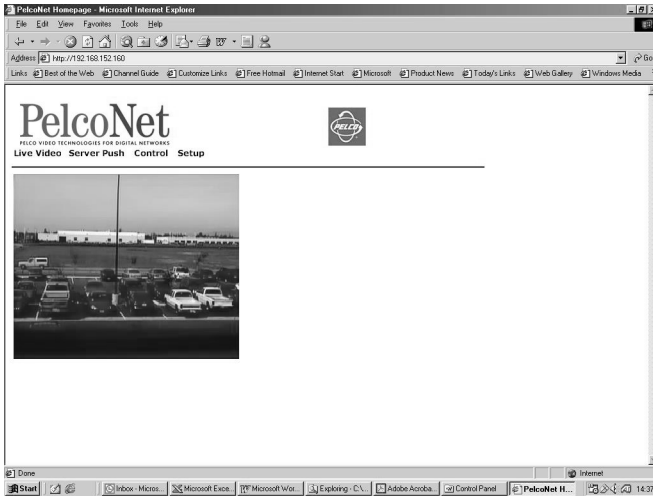

Figure 23. PelcoNet Home Page

The home page is the starting point for any configuration.

The window in the center of the screen is the display area for decoded video.

- Clicking the Pelco logo on any page connects you to the Pelco Internet home page (provided the LAN supports Internet access).
- Click **Live Video** to choose a live display or **Server Push** for periodically updated stills.
- Click **Control** to access an options screen with links to pages where you can see and control the displayed view. (Refer to the *Web Browser Control Pages* section.)
- Click **Setup** to access an options screen with links to configuration pages. Click any icon on the side to transfer to the desired page.



Figure 24. PelcoNet NET104A Transmission System Setup Page

NOTE: When changing any configuration item in one of the following pages, make sure to change a single item at a time. Then click the respective Set button. If more than one item needs to be changed, execute the procedure repeatedly. If more than one item is changed without clicking the Set button in between, only the entry associated with the clicked button is actually changed. All other entries return to their previous settings.

All configuration items are stored in non-volatile memory so they are kept when the unit is powered down.

Some configurations apply only to transmitters (for example, camera settings) while others apply to receivers. Also, the settings require a receiver unit with the audio option (NET101R-A). All settings not expressly restricted to certain models apply to all.

General Configuration Page

The unit name and ID, as well as password settings, comprise the General Settings configuration page.

All units have a real-time clock set during manufacture. However, time and date can be changed any time; for example, when the units are operated in different time zones.

Version numbers for the hardware and the firmware are for information only. Whenever you need technical support, have these numbers ready.

The screenshot shows a web browser window titled "PelcoNet General Settings - Microsoft Internet Explorer". The address bar shows the URL "http://192.168.152.155/general.htm". The page content is titled "General Settings" and contains several sections of configuration options:

- Unit Identification:** Name: Pelconet 104, ID: PN104.
- Password level:** Password: [empty], confirm: [empty]. A note below says "No password set".
- Time & Date:** Date: Wednesday, 06 . 03 . 2002, Time: 12 : 47 : 51, Time zone: Synchronize.
- Time server IP:** 0.0.0.0.
- Version Information:** Hardware: 60513241, Software: 10000570.
- Firmware updates:** [empty] with a "Browse" button and an "Upload" button.
- Configuration download:** [empty] with a "Download" button.
- Configuration upload:** [empty] with a "Browse" button and an "Upload" button.

The browser's status bar at the bottom shows the address "192.168.152.155" and the system tray includes icons for Start, Internet, and a clock showing 12:48.

Figure 25. General Settings Configuration Page

Table B. General Settings

Configuration Item	Default Setting	Description
(Unit) Name	none	<p>The unit Name and unit ID identify the device from a distance; for example, in the event of an alarm call. The name helps when there are many PelcoNet units on the network.</p> <p>Enter a name (nine characters maximum) for the NET104A that lets the device be easily identified. With appropriate configuration, the name will be displayed in the video window.</p>
(Unit) ID	none	<p>The ID serves as a machine-readable name. The ID can be read at any time. Reading is facilitated remotely via UDP/IP, letting a management system monitor the unit.</p>
Password level	none	<p>Transmitters operate at two authorization levels: service or user. This field lets you set the password at either level.</p> <p>At the service level, you can change all the configuration settings. At the user level, you can operate but not configure the device. You can have a live picture or see the configuration settings but you cannot change them.</p>
Password	none	<p>The unit can be password-protected to prevent unauthorized tampering with the configuration. The password needs to be repeated correctly in the confirm box before password protection is activated. If the device is not protected with a password, "No password set" will be displayed.</p> <p>Once password protection is enabled, you need to log in before the configuration pages can be accessed (Figure 26).</p> <p>You can only change one of the two passwords. To change the other, you have to access this configuration page again.</p> <p>NOTE: If you forget the password and cannot access the unit, refer to the red caution sheet that came with the unit. The sheet details procedures for resetting the unit to allow access. Your settings will be erased.</p>
Date	n/a	<p>Enter the current date in DD/MM/YYYY format. This is the system date, driven by the internal real-time clock. The day of the week (first entry box) need not be entered and will be automatically adjusted based on the given date.</p>
Time	n/a	<p>Enter the current time or click the Synchronize button to synchronize the NET104A with your computer's system time. The system time is driven by the internal real-time clock.</p>
Time zone	Greenwich Mean Time	<p>Use the pull-down menu to select the time zone for the current time.</p>

(Continued on next page)

Table B. General Settings (Continued)

Configuration Item	Default Setting	Description
Time server IP	0.0.0.0	Enter the IP address of an Internet server that will supply accurate time for your PelcoNet unit(s). Or synchronize to a piece of equipment on your network.
Hardware	n/a	Read-only version number of the hardware. This contains unique serial number, type of hardware, and revision.
Software	n/a	Read-only firmware version number. This is important information should you need technical support.
Firmware update	n/a	Enter the name of the file containing new firmware, or locate it using the Browse button. Then click the Upload button to upload the firmware and install it on the system.
Configuration download	n/a	Clicking the Download button saves the current configuration of the PelcoNet NET104A Transmission System to a PC file.
Configuration upload	n/a	This copies a file from a PC to the NET104A. Enter the name of the file containing the configuration, or locate it using the Browse button. Then click the Upload button to overwrite the configuration with the configuration stored in the named file.

When password protection is on, as described in Table B, the program displays the following password screen if any attempt is made to configure the unit (that is, selecting one of the configuration pages).

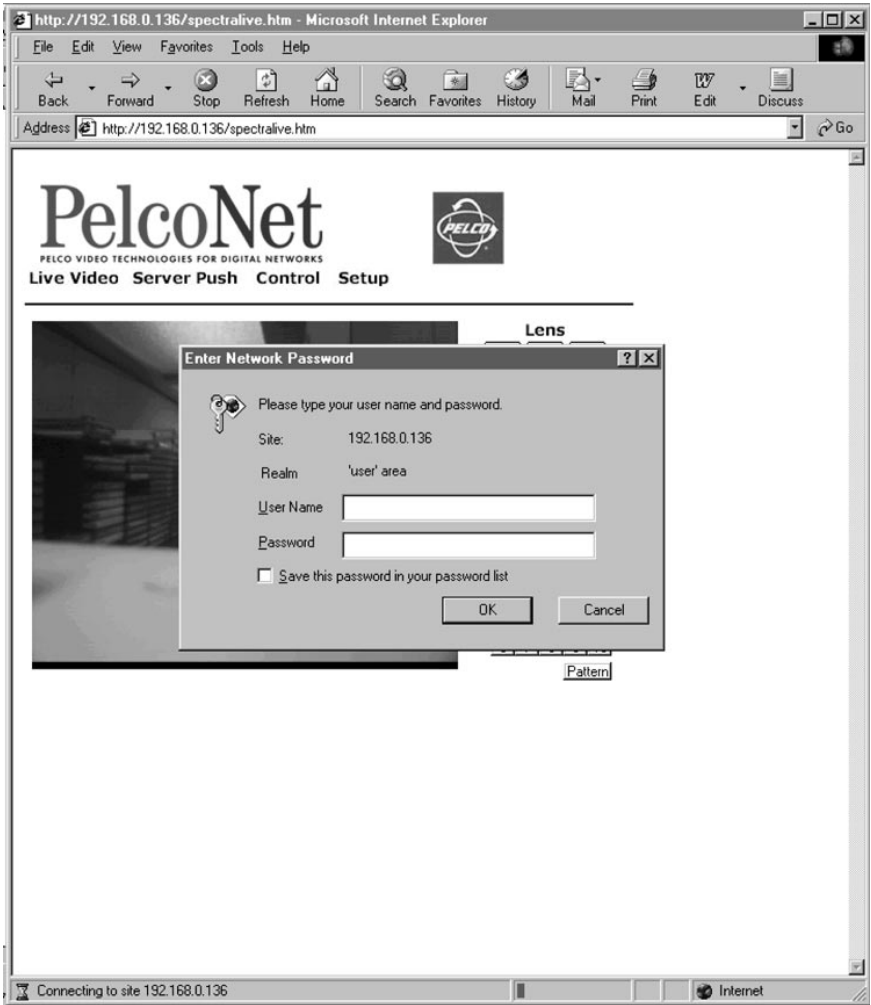

Figure 26. Screen For Entering The Password

Network Settings Configuration Page

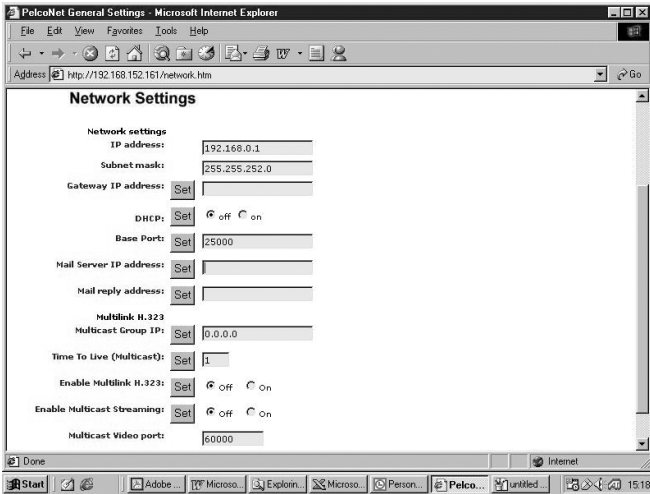

Figure 27. Network Settings Configuration Page

Network and routing information make up the Network Settings configuration page. The following table describes the configuration items.

Table C. Network Settings

Configuration Item	Default Setting	Description
IP address	192.168.0.1	Enter a unique IP address that is valid for your network. The pre-configured default IP address allows for easy configuration in closed environments. You can use a crossed cable to directly connect to a PC. Also, the PC's IP address and subnet mask must match the default IP address. NOTE: Changing the IP address also affects the current browser connection. You will have to enter the new URL to regain connectivity to the unit.
Subnet mask	255.255.255.0	Enter a valid subnet mask for your network, if subnets are in use.
Gateway IP	none	Enter the IP address of the router. This is typically used in a WAN environment.

(Continued on next page)

Table C. Network Settings (Continued)

DHCP	off	Dynamic Host Configuration Protocol. When set to on , the network DHCP server automatically assigns your computer an IP address. When set to off , you must assign it yourself.
Base Port	25000	Enter a setting to designate which TCP/IP ports PelcoNet uses for transmission, video, audio, and control. For example, the default setting of 25000 means PelcoNet will use TCP ports 25000-25001 and UDP ports 25002-25011 (12 ports total) for all video and control data.
Mail server IP address	none	Entry is only required if the mail-sending feature is to be used. Outgoing e-mail is sent to the mail server (SMTP server) at this IP address.
Mail reply address	none	Enter a name for the NET104A that lets the device be easily identified. This is similar to the unit identification Name field on the General Settings configuration page. This field identifies the device from a distance. The name helps when there are many PelcoNet units on the network. The recipient of the e-mail can identify the e-mail's sender by this entry.
Multicast Group IP	0.0.0.0	This is the Multicast IP Address. (Network hardware—such as switches, hubs, routers, etc.—must support the multicasting protocol, ICMP.) This field sets PelcoNet to use the multicasting protocol, which allows more efficient use of bandwidth. The IP range is 224.0.1.0 through 238.255.255.255.
Time To Live (Multicast)	1	This setting specifies how many routers an information packet can go through before it expires.
Enable Multilink H.323	Off	When set to On , this setting lets the PelcoNet unit support five simultaneous live video connections.
Enable Multicast Streaming	Off	This setting, in conjunction with the Multicast Group IP and Enable Multilink H.323 settings, can allow an unlimited number of live video connections. The Enable Multilink H.323 field, as well as this field, must both be set On for this to work.
Multicast Video port	60000	This setting designates the TCP/IP port PelcoNet uses for video when using the multicasting protocol.

Video Settings Configuration Page

The Video Settings configuration page lets you modify all video-related parameters. Some items apply only to transmitters while others require a receiver. The screen capture below belongs to a transmitter.

Refer to Table D for default settings and descriptions.

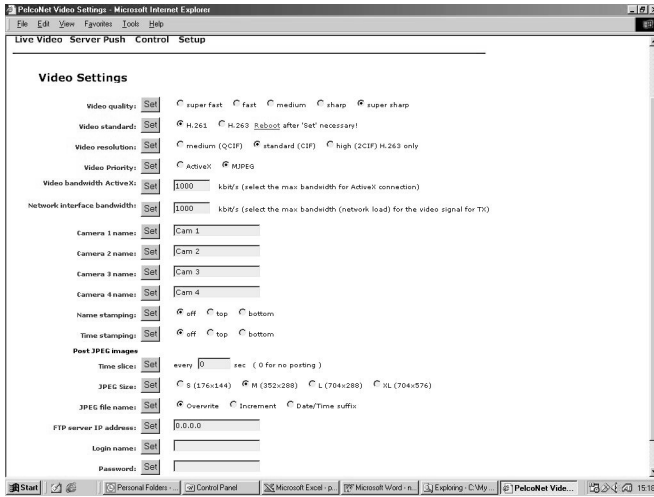

Figure 28. Video Settings Configuration Page

The following table details the configuration items.

Table D. Video Settings

Configuration Item	Default Setting	Description
Video quality	super fast	<p>You can set the quality of the video. On restricted bandwidth channels, you need a compromise between optimum image sharpness and quick reproduction of movements in the image. With increasing bandwidth, the effect of this setting diminishes, as best quality and fast motion can be maintained simultaneously.</p> <p>With a high image refresh rate, sharpness deteriorates with increasing movement in the field of view.</p> <p>If movement is expected in a small area only, you can give preference to sharpness. The intelligent compression process then is able to refresh the affected areas in the image. The unchanged rest of the image will be reproduced with optimum sharpness.</p> <p>With high bandwidths in the local network (above 200 Kb), you can work with maximum image quality without the refresh rate suffering noticeably.</p>
Video standard	H.263	<p>This field sets the video standard for the transmission. If you intend to do a box-to-box connection, set this to H.261, click the Set button, and then click the <u>Reboot</u> link to reboot the unit. An hour glass symbol indicates the command is being processed. This symbol remains on the screen (regardless of whether or not the reboot is finished) until you click another function. The POWER LED flashes when the reboot is finished.</p> <p>If you are not near the unit, wait at least one minute to ensure the reboot finishes. If you click another function before the reboot concludes, the program responds with a retry or firewall message. Delete the message, exit the program, and restart.</p>
Video resolution	standard (CIF)	<p>Choose medium (QCIF) or standard (CIF) video resolution. Common Intermediate Format (CIF) is at 352 x 288 picture elements. For very restricted channels (for example, wireless or low speed modem transmission) it may be advantageous to switch to medium (QCIF) resolution at 176 x 144 pixels for decent image rates.</p>

(Continued on next page)

Table D. Video Settings (Continued)

Configuration Item	Default Setting	Description
Video Priority	ActiveX	<p>This field controls whether performance of the device is optimized for MJPEG or ActiveX (H.261/H.263).</p> <p>If you select MJPEG mode, a sequence of still images (for example, a fresh image every second) is displayed in the browser. This setting does not require any plug-ins or ActiveX installation and may be advisable for severely limited channels (for example, the Internet).</p> <p>PelcoNet recommends choosing ActiveX for best video performance. This provides the best quality and lowest data rate consumption. When you choose this the first time, the corresponding ActiveX is downloaded automatically to your PC from the Pelco home page.</p>
Video bandwidth ActiveX	1000	<p>This field controls the transmitter bandwidth setting for live video. This value relates only to the video transmission rate (without audio and protocol). Receivers can log into the transmitter with a lower or same data rate.</p> <p>In streaming mode, this value indicates the data transmission rate of the video. Select a video transmission rate between 10 Kb/sec and 1 Mb/sec.</p>
Network interface bandwidth	1000	<p>This field lets you adjust the maximum data rate that will be sent over the network.</p> <p>Enter the data transmission rate in kbits per second. Valid entries are 10 through 1000.</p> <p>The value is the maximum bandwidth for the video data. Also, transmission bandwidth is needed for data; to control cameras, for example. Therefore, an actual transfer value can be over or under the adjusted value.</p>
Camera 1-4 names	n/a	<p>Enter the desired camera names (nine characters maximum for each). Camera 1 is video 1 input. In addition to the unit name, the camera names help the user identify the locations or the visible scenes.</p>

(Continued on next page)

Table D. Video Settings (Continued)

Name stamping	off	<p>Name Stamping is a combination of unit name and camera name (18 characters maximum). This identifier can be stamped on the video image.</p> <p>Choose top for upper left corner or bottom for lower left corner to display the name information inside the video image. Choose off if you do not want the names displayed. (Note that when Name Stamping and Time Stamping are assigned to the same position, Name Stamping has priority and will partially obscure Time Stamping.)</p>
Time stamping	off	<p>Similar to name stamping, date and time information can be stamped on the live video image at either the upper or lower right corner. Stamping occurs at the transmitter before the actual coding takes place. Therefore, the name and date/time information are an integral part of the coded and transmitted data.</p>
Time slice	0	<p>Enter the time interval in seconds at which single images should be sent for storage on an FTP server. These images can be accessed later (for example, to reconstruct alarm events). Enter 0 if no single images are to be stored.</p>
JPEG Size	M	<p>This field designates the size of each JPEG image that will be posted to the FTP server for storage.</p>
JPEG file name	Overwrite	<p>When you save a snapshot to your PC's hard disk, this field specifies whether the file gets overwritten by the next save, or another file is created with a higher number (Increment), or another file is created with a Date/Time designator. The file name's root is always "snap."</p>
FTP server IP address	0.0.0.0	<p>Enter the IP address of the FTP server on which the images will be stored.</p>
Login name	n/a	<p>Enter the login name used to access the FTP server.</p>
Password	n/a	<p>Enter the password used to access the FTP server.</p>
Path	n/a	<p>Enter the directory under which the images are to be stored on the FTP server.</p>

Audio Settings Configuration Page

Audio configuration settings apply only to the NET104A transmitter and to the NET101R-A receiver.

You can set the input and output levels (from 0-100%) on this configuration page. You can use the Coding Mode menu item to set the sending side's coding mode.

The audio decoder automatically follows the transmitter's selected audio coding. If the receiver cannot decode the selected mode, an automatic fall-back to the next available audio mode occurs.

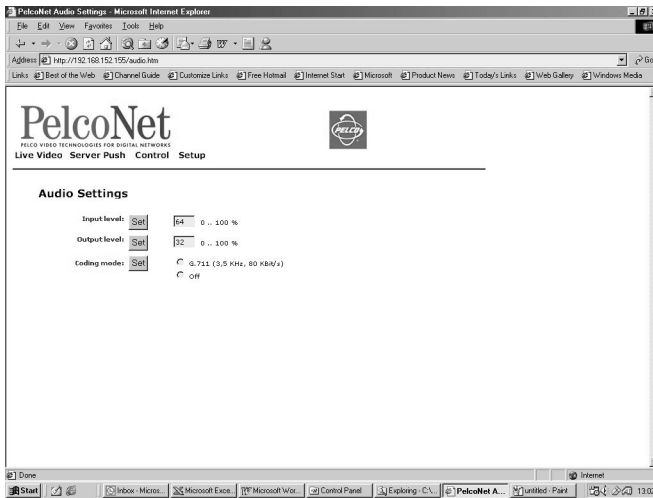

Figure 29. Audio Settings Configuration Page

The table below details available configuration items.

Table E. Audio Settings

Configuration Item	Default Setting	Description
Input level	64%	Enter the sensitivity of the audio input. You need to adapt the input sensitivity to the level of the audio source to avoid overdriving the signal, causing distortion. Experiment for the best setting.
Output level	32%	Enter the sensitivity of the audio output. Adapt the output level to the requirements of connected audio equipment.
Coding mode	off	Select the coding mode for audio data. Mode G.711 supports all systems. Pick G.711 or off to work without coding.

Alarm Settings Configuration Page

The PelcoNet NET104A Transmission System is not only a multimedia gateway but also a security device and, therefore, has many features related to security applications. The Alarm Settings configuration page lets you configure your unit for video surveillance applications. This page basically applies to transmitters only. However, receivers do provide the same features. In most surveillance-related applications, the receiver is located in a secure alarm center-type environment while the transmitter is mounted inside or at the location to be monitored. Refer to the *Typical Applications* section for more information about remote video surveillance.

The screenshot shows the 'Alarm Settings' configuration page in a Microsoft Internet Explorer browser window. The page is titled 'PelcoNet Alarm Settings - Microsoft Internet Explorer'. The main content area is titled 'Alarm Settings' and contains several sections of configuration options:

- Alarm inputs:** Includes 'Video alarm' (radio buttons for on/off), 'Motion alarm' (radio buttons for on/off and a 'Configuration' button), and four 'Alarm input pin' settings (pin 1 to pin 4). Each pin setting has radio buttons for 'on/off' and 'active high/low', and a text input field for 'active low Name'.
- Master Alarm input pin:** Radio buttons for 'on/off' and 'active high/low'.
- Camera follows alarm inputs:** Radio buttons for 'on/off'.
- On screen display:** Radio buttons for 'on/off', 'on alarm', 'hold display', and 'hold off'.
- Alarm status:** Radio buttons for 'no/yes'.
- Alarm action:** Radio buttons for 'no/yes'.
- Live video receive IP:** Text input field for IP address (0.0.0.0) and 'Remote password' field.
- Live video auto connect:** Radio buttons for 'on/off' and a note 'connect always - no alarm event necessary!'
- Send email:** Radio buttons for 'on/off' and a text input field for 'receiver email address'.
- Relay outputs:** Radio buttons for '1 open/1 closed', '2 open/2 closed', '3 open/3 closed', and '4 open/4 closed'.
- Idle state:** Radio buttons for '1 open/1 closed', '2 open/2 closed', '3 open/3 closed', and '4 open/4 closed'.
- Operating modes:** Four dropdown menus, each set to 'Bistable'.
- Relay follows:** Four dropdown menus, each set to 'None'.
- Relay Names:** Four text input fields labeled 'Relay 1', 'Relay 2', 'Relay 3', and 'Relay 4'.
- Trigger Relay:** Four buttons labeled 'Relay 1', 'Relay 2', 'Relay 3', and 'Relay 4'.

The browser's status bar at the bottom shows the Start button, navigation icons, and the address bar containing 'Personal Folds', 'Control Panel', 'Microsoft Exce...', 'Microsoft Wov...', 'Exploring C:\', 'PelcoNet A...', and 'Untitled - Part...'. The system clock shows 15:22.

Figure 30. Alarm Settings Configuration Page

The set of video surveillance features is explained below.

Table F. Alarm Settings

Configuration Item	Default Setting	Description
Video alarm	off	If you select on , the signal from the video source (the camera in most cases) is monitored constantly for interruption. If no signal is received, the NET104A triggers the alarm.
Motion alarm	off	<p>The system has a video motion detection feature. The video scene is monitored constantly for relevant motion.</p> <p>To set motion detection, do the following:</p> <ol style="list-style-type: none"> 1. Select on to trigger an alarm in the event of movement. 2. Click the Configuration button to access the Motion Detection screen. If you want to accept the factory settings, click the Defaults button. 3. Use the Camera input pull-down menu to select the camera view you want motion detection on. 4. Click the Select area button to display a window with a grid superimposed on it. Select the cells in the image you want the system to monitor for motion. To set an individual cell, click it with the left mouse button (it will turn red). Click with the right button to deselect a cell (which will turn white). Select or deselect multiple cells by holding down the left or right mouse button and dragging. Release when finished. 5. Use the Motion tracking pull-down menu to turn on/off tracking. 6. The Tracker box indicates and controls the direction of motion detection. You can set motion detection to operate in one direction only by removing the check marks in the opposite direction.

(Continued on next page)

Table F. Alarm Settings (Continued)

Configuration Item	Default Setting	Description
		<p>7. Use the Local sensitivity slide bar to set detection sensitivity. You need to adapt sensitivity to the respective environment and the acceptable false alarm rate: for a lower false alarm rate select a lower sensitivity and vice versa. Experiment to find the best setting. Use of the motion detection feature is recommended only indoors and under controlled lighting conditions.</p> <p>8. Use the Average n[frames] slide bar to define for how long or over how many pictures motion in the scene must be detected before an alarm will be released. If the value is low, even movement over a small period triggers an alarm. If the value is high, movement over a longer period is required to trigger an alarm.</p> <p>9. Use the Object min size [nxn blocks] slide bar to designate the minimum number of cells in the frame a moving object must fill to trigger an alarm. You can set the value between 1*1 and 6*6 (2*2 is recommended). If the size of the object in the picture exceeds the value you set, motion detection triggers an alarm.</p> <p>10. The Alarm indicator box lets you set a threshold so an alarm is triggered only if the sensitivity of the video sensor is exceeded. Thus, something such as background noise caused by the camera can be filtered to avoid unwanted alarms.</p> <p>Pull up or down on the blue line to observe the motion detector. Set it straight above the basic deviation of the red curve.</p> <p>11. Press Default to get the default settings for motion detection.</p> <p>The following conditions must be met for motion detection to function:</p> <ul style="list-style-type: none"> • Motion detection must be activated. • At least one cell must be activated. • Sensitivity must be set higher than zero. • The master alarm may also have to be activated.

(Continued on next page)

Table F. Alarm Settings (Continued)

Alarm input pin 1-4	off	<p>If external sensors or simple contacts or switches will be used with the system, you need to select the alarm input.</p> <p>Click on to activate alarm triggering via an external sensor for the selected pin. Otherwise, click off.</p> <p>You also can specify whether the alarm is triggered by the voltage level active high (normally open) or active low (normally closed).</p> <p>In addition, you can enter a name (nine characters maximum) for the selected pin in the Name field.</p>
Master Alarm input pin	off	<p>You can use alarm input 5 as a master alarm; for example, if a key switch is used to arm the system. If you choose on, alarm input 5 must be active to enable all other alarms.</p>
Camera follows alarm input	off	<p>Select on to display the image of the corresponding camera automatically when an alarm is triggered. Choose off to keep the current camera display.</p>
Alarm status	off	<p>Current alarm activation status can be shown in the video image (similar to the name, date, and time stamping discussed in Table D).</p> <p>If configured to be on, the status of the activated alarms, namely, video, motion, and input, is shown in the upper left corner of the video image. Or, the display can be activated as soon as an alarm condition is reached (choose on alarm). This way, the video image corresponding to the alarm condition is clearly marked.</p> <p>Also, there is a choice to keep the status display, once an alarm has been triggered, even when the original cause of the alarm is no longer present (choose hold display), or to have the status display follow the alarm condition (choose hold off).</p>

(Continued on next page)

Table F. Alarm Settings (Continued)

Configuration Item	Default Setting	Description
Connect	no	<p>The alarm functions would have little effect without automatically triggering corresponding actions. Select yes for automatic connection to the given IP address. The idea is to provide a remote monitoring station with live video in case of an alarm.</p> <p>This feature can be useful even for many applications not related to alarm conditions. One example is a video-equipped door entry system: when the doorbell is pressed, a contact closes and the connected transmitter autonomously connects to a receiver. Full-duplex audio can provide verbal communication, while the relay output can open the door remotely.</p> <p>On receivers, the default alarm connection IP address is set to 192.168.0.1 (default IP of transmitter).</p>
Live video receive IP	0.0.0.0	<p>Enter the IP address of the transmitter or receiver to be notified in the event of an alarm. If that remote unit has a password, enter it in the Remote Password field below so the two units can communicate with each other.</p>
Remote password	empty	<p>If applicable, enter the password to access a transmitter (refer to the Live Video Receive IP field above).</p>
Live video auto connect	off	<p>Select on if at each restart an active connection should be set up automatically to the IP address defined above. Otherwise, select no.</p> <p>The auto connect feature guarantees an active connection to the given alarm IP address even after connection breakdown or network failures. If you select auto connect, the network cable can be pulled at any time. As soon as the network comes back alive, the connection is reinstated. On a receiver, this feature is enabled to establish a connection to a transmitter automatically.</p>
Send email	off	<p>Select on to send an alarm e-mail in the event of an alarm. A person who does not have a video reception device can thus be informed via an attached JPEG image sent to the predefined e-mail address.</p>

(Continued on next page)

Table F. Alarm Settings (Continued)

Receiver email address	empty	If applicable, enter the e-mail address where you want an e-mail sent in the event of an alarm.
Idle state	open	You can configure the switching behavior of each built-in relay output at idle: open (N.O. at zero current) or closed (N.C. at zero current).
Operating mode	Bistable	Select an operating mode for each relay. <ul style="list-style-type: none">• When you select the default Bistable mode, the relay will stay in the idle or active state for an indefinite period. (For example, select Bistable if a floodlight activated by an alarm is to remain switched on at the end of the alarm.)• When you select Monostable mode, the relay automatically falls back to the idle state after a predefined period expires. (For example, select Monostable 10s if a siren triggered by an alarm is to sound for a period of 10 seconds.)
Relay follows	None	If necessary, select a particular event from the pull-down menu that will trigger the relay. A typical application is having the relay following the status of the connection; for example, to power peripheral equipment or even the camera itself. Select from the following: <ul style="list-style-type: none">• Motion alarm: Triggering by motion alarm• Input pin: Triggering by external alarm sensor• Video loss: Triggering by video signal alarm• Connection: Triggering at each connection setup• Remote input pin: Triggering by switching contact of the remote station• None: No relay triggering by events
Relay Names	Relay 1-4	Assign a relay name to each output.
Trigger Relay	n/a	Clicking the appropriate Relay button switches that relay by hand. Typical applications are opening remote doors or operating lights.

Interface Settings Configuration Page

You can use the Interface Settings configuration page to configure the parameters of the communication ports.

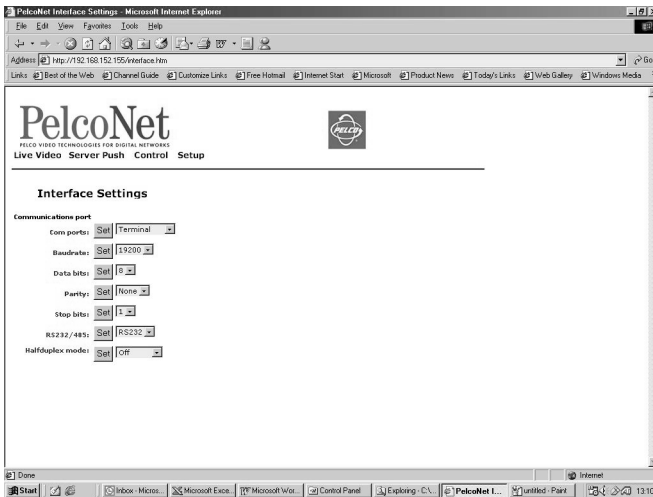

Figure 31. Interface Settings Configuration Page

The default parameters of the transparent data port agree with the most commonly used settings, as shown in the following table.

Table G. Interface Settings

Configuration Item	Default Setting	Description
Com ports	Terminal	This port can be set to Terminal mode, which is used to program the unit through HyperTerminal. Or, it can be set to Transparent , which allows control of devices such as a digital video recorder (DVR) or pan/tilt/zoom camera, etc. When set to Transparent PelcoNet cannot be accessed through HyperTerminal.
Baudrate	19200	Select any transmission rate from 300 to 19200 baud.
Data bits	8	Select the number of data bits (7 or 8) per character.
Parity	None	Select the type of parity check (Odd, Even, or None).
Stop bits	1	Select the number of stop bits (1 or 2) per character.
RS232/485	RS232	Select the required protocol for the port.
Halfduplex mode	off	If you choose this RS-485 mode, camera control data is transferred automatically to the control port, which is a serial interface on the unit's rear panel to which you can connect a PC. This mode supports flow control. NOTE: In the "on" or "buffered" mode, transparent data is rerouted to the control terminal port; terminal functions are provided on the transparent data port.

LIVE VIDEO AND SERVER PUSH VIDEO PAGES

The Live Video page shows a real-time picture of a camera view with update rates and image quality similar to a box-to-box configuration. It can be configured for bandwidth use and for various image quality settings. The Server Push page shows still pictures that are updated periodically, and image quality is fixed.

1. To access the PelcoNet NET104A Transmission System home page, you must first connect to the Internet/intranet network and open Internet Explorer (the browser).
2. Then, enter the default address **192.168.0.1** in the address box. If this address has been changed, enter the application address. The home page appears.
3. Click either **Live Video** or **Server Page** on the home page.

To exit either page, click an option at the top of the page.

The program displays dialog boxes when you try to view live video under any of the following conditions:

- With a browser other than Internet Explorer
- Without first installing ActiveX (Figure 32)
- When your computer display is not set for 16- or 32-bit color
(To change: right click the desktop, and then click **Properties**, the **Settings** tab, and select **High Color [16 bit]** or **True Color [32 bit]**. For NT, select **65536 Colors**.)
- When Microsoft Virtual Machine is not enabled.
(To enable: on the Tools menu select **Internet Options**, select the **Advanced** tab, locate **Microsoft VM**, checkmark **Java Console Enabled** and **JIT compiler for virtual machine enabled**. Reboot your PC.)

With any of these conditions, you can only view the video as a series of still images.

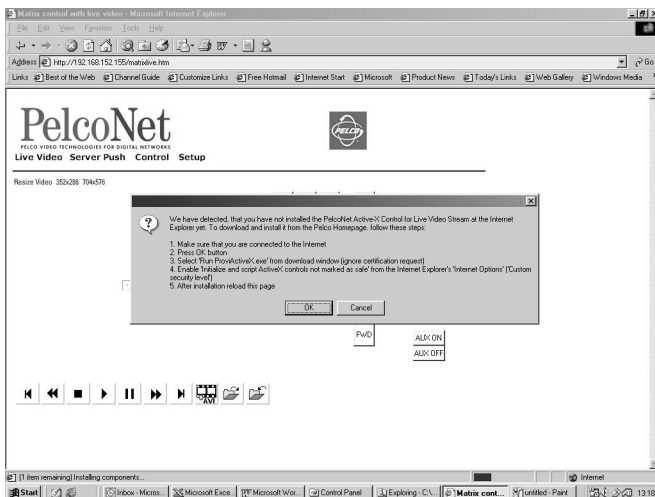

Figure 32. ActiveX Dialog Box

WEB BROWSER CONTROL PAGES

ACCESSING THESE PAGES

1. To access the PelcoNet NET104A Transmission System home page, you must first connect to the Internet/intranet network and open Internet Explorer (the browser).
2. Then, enter the default address **192.168.0.1** in the address box. If this address has been changed, enter the application address. The home page appears.
3. Click **Control** to access the Device Controls page.
4. The Device Controls page has underlined links to the control pages. To access, click one.

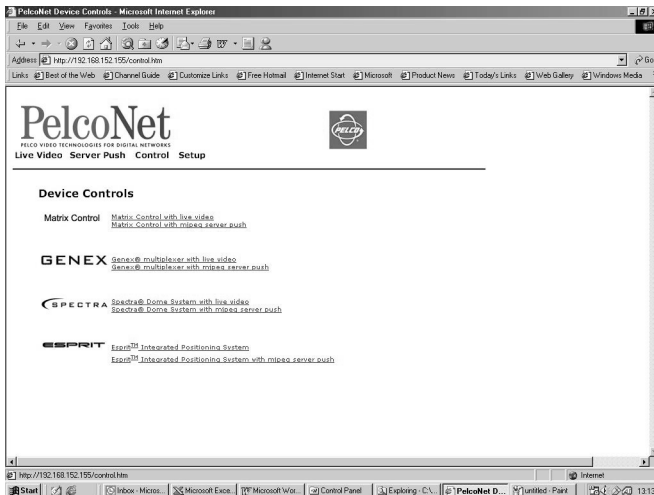

Figure 33. Device Controls Page

CONTROLLING THE DISPLAY

The live video control pages include representations of keys that let you control various functions (in addition to showing the camera display). Use the mouse pointer and click the left mouse button to enable options and operate controls on the screen. Click outside of the options to disable a radio button or selection button.

Live video pages let you choose the size of the video viewing area. Click either **352x288** (small) or **704x576** (large) in the Resize Video field.

Live video pages also let you record and play back camera views on a PC's hard drive. Refer to the *Record and Play Back the Display on a PC* section for details.

On the Spectra and Esprit live video control pages, you can control the following:

- **Presets** – To program a preset: select the camera by clicking its button, position the camera, click the **Set** check box, and click a preset number button.

To activate a preset: click the camera button and then click a preset number button.

- **Patterns** – You can program only one pattern per camera through PelcoNet. To program a pattern: select the camera by clicking its button, click the **Set** check box, then click **Start**, and then use the arrow buttons to position the camera. Click **Stop** to halt pattern programming.

To operate a pattern: select the camera, click **Start** to begin the pattern and **Stop** to halt.

- **Programming Menus** – To access the programming menus: select the camera by clicking its button, click the **Set** check box, and then click the **95** button. Use the camera arrow keys to move up/down the menus. Use the open iris icon to open menus and set options. Use the open iris icon in conjunction with the **Exit** option to move backward through menu layers and to exit programming mode.

NOTE: If you installed Internet Explorer from the PelcoNet NET104A Transmission System CD, ActiveX is already installed. Otherwise, you must install ActiveX before you can view the video. Refer to the *Instructions for the Network Administrator* section.

NOTE: PTZ control always defaults to camera 1. Therefore, if you are viewing and controlling camera 2, 3, or 4 and then exit, you will not have control of that camera when you return. You must select again the camera you want to control.

MATRIX CONTROL LIVE VIDEO/SERVER PUSH PAGE CONTENTS

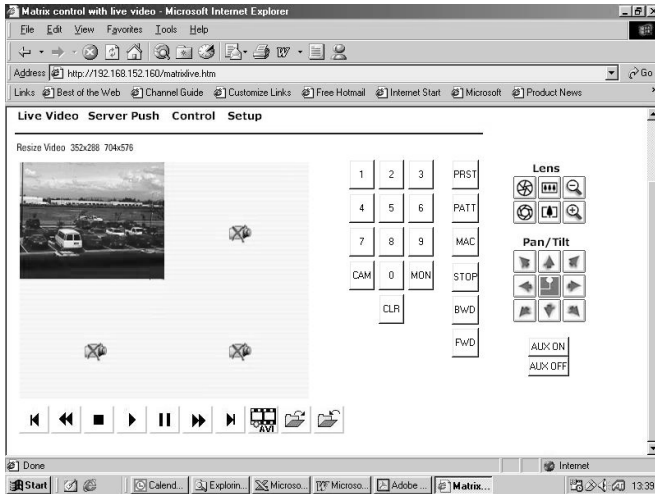

Figure 34. Matrix Control Page

The Matrix Control pages contain the following:

- Ten numbered buttons
- CAM (camera) button
- MON (monitor) button
- CLR (clear) button
- PRST (preset) button
- PATT (pattern) button
- MAC (macro) button
- STOP button
- BWD (backward) button
- FWD (forward) button
- PC hard drive record/playback control buttons beneath the live screen (refer to the *Record and Play Back the Display on a PC* section for more information)

The following are arrayed under “Lens”:

- Iris open and close buttons
- Focus far and near buttons
- Zoom out and in buttons

The following are arrayed under “Pan/Tilt”:

- Eight direction arrow buttons
- Home button in the center returns the camera to its starting position (preset 1 must be set for the button to function)

The page also contains the following:

- AUX ON button
- AUX OFF button

GENEX LIVE VIDEO/SERVER PUSH PAGE CONTENTS

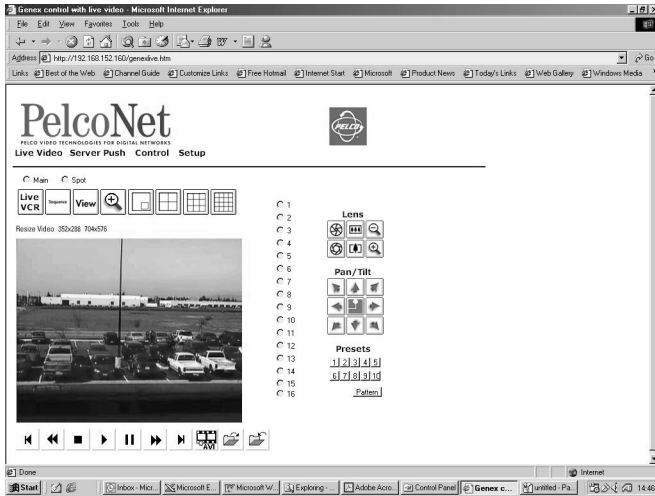

Figure 35. Genex Control Page

The Genex pages contain the following across the top of the page:

- Main and Spot monitor selection radio buttons
- A Live/VCR button
- A Sequence button
- A View button
- A zoom button
- A picture-in-picture button
- Buttons for 4-, 9-, and 16-screen display

The following are arrayed down the right side of the page:

- Radio buttons for 16 cameras
- Iris open and close buttons
- Focus far and near buttons
- Zoom out and in buttons
- Eight direction arrow buttons with a home button in the center
- Ten numbered buttons to use with the Pattern button (enter preset number and click **Pattern**)
- A Pattern button

PC hard drive record/playback control buttons are arrayed beneath the live screen (refer to the *Record and Play Back the Display on a PC* section for more information).

NOTE: You may not have control of the desired camera when switching between the spot and main monitor radio buttons.

To control a camera and view it on the spot monitor:

1. Make sure you are viewing video on the main monitor.
2. Click the radio button for the camera you want to view on the spot monitor.
3. Click the radio button for the spot monitor.

If you do not follow this procedure, you may not have control of—or be viewing—the desired camera on the spot monitor.

The following example shows what can happen **if you do not follow the procedure:**

1. Select camera 16 on the main monitor.
2. Select the spot monitor. You will view and control camera 16.
3. Select the main monitor. You will view camera 16.
4. Select camera 7. You will view camera 7 on the main monitor.
5. Select the spot monitor. You will view camera 7 on the spot monitor but control camera 16. To view camera 16, return to the main monitor and select camera 16, then select the spot monitor. Now you can view and control camera 16. If you select another camera (for example, 8), you can control camera 8 but not view it. Return to the main monitor, select camera 8, and then select the spot monitor. Now you can control and view camera 8.

NOTE: The View button on this page does not function the same way as the View button on the Genex unit. You cannot enter multiplexer setup with the PelcoNet View button. You can, however, enter multiplexer setup with the View button on the multiplexer unit, and then on the PelcoNet screen you can use the arrow buttons to navigate and the iris open button to make changes.

SPECTRA LIVE VIDEO/SERVER PUSH PAGE CONTENTS

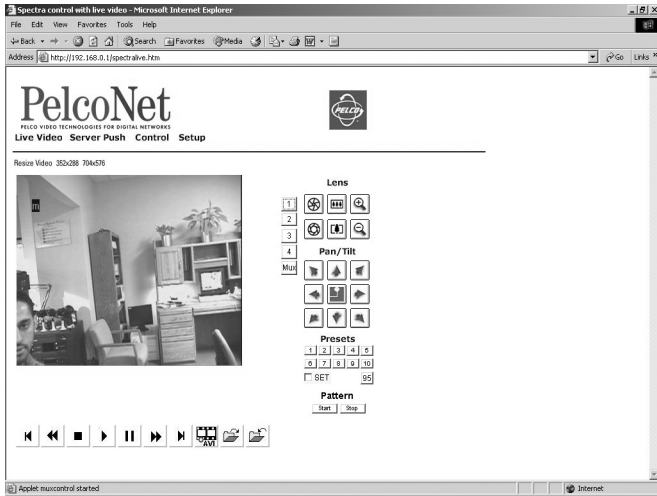

Figure 36. Spectra Control Page

The Spectra pages contain the following arrayed down the left side:

- Four camera selection buttons
- A Mux button for putting the screen into quad view

The following are arrayed down the right side under “Lens”:

- Iris open and close buttons
- Focus far and near buttons
- Zoom out and in buttons

The following are arrayed under “Pan/Tilt”:

- Eight direction arrow buttons
- Home button in the center returns the camera to its starting position (preset 1 must be set for the button to function)

The following are arrayed under “Presets”:

- Ten numbered preset buttons
- A Set check box
- A preset 95 button for entering the programming menus

The following are arrayed under “Pattern”:

- A Start pattern button
- A Stop pattern button

PC hard drive record/playback control buttons are arrayed beneath the live screen (refer to the *Record and Play Back the Display on a PC* section for more information).

NOTE: When returning to this page, camera radio buttons 1-4 and the Mux button always show camera button 1 selected even if another camera is being viewed.

ESPRIT LIVE VIDEO/SERVER PUSH PAGE CONTENTS

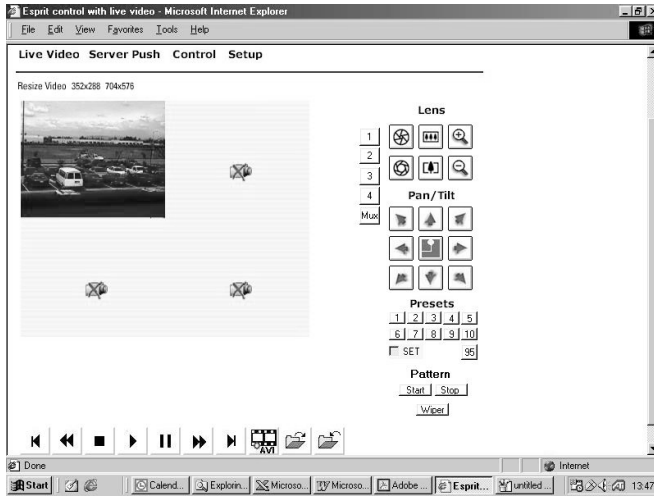

Figure 37. Esprit Control Page

The Esprit pages contain the following arrayed down the left side:

- Four camera selection buttons
- A Mux button for putting the screen into quad view

The following are arrayed down the right side under “Lens”:

- Iris open and close buttons
- Focus far and near buttons
- Zoom out and in buttons

The following are arrayed under “Pan/Tilt”:

- Eight direction arrow buttons
- Home button in the center returns the camera to its starting position (preset 1 must be set for the button to function)

The following are arrayed under “Presets”:

- Ten numbered preset buttons
- A Set check box
- A preset 95 button for entering the programming menus

The following are arrayed under “Pattern”:

- A Start pattern button
- A Stop pattern button
- A Wiper button

PC hard drive record/playback control buttons are arrayed beneath the live screen (refer to the *Record and Play Back the Display on a PC* section for more information).

ADVANCED FEATURES

AUTOMATIC CONNECTION FEATURE

The advantage of conventional dedicated cabling lies in guaranteed performance and availability. The PelcoNet NET104A Transmission System's auto-connect feature is designed to provide the same level of guaranteed connectivity expected from analog coaxial video cables.

IT networks commonly experience short breakdowns and congestion. Protocols used for computer communication (for example, TCP/IP) are designed to cope with missing data and interruptions. With the PelcoNet NET104A Transmission System, once a video connection is established, the video stream normally terminates gracefully when a network connector is pulled or the network is otherwise disrupted.

The system can be configured to reconnect automatically to guarantee connectivity. To activate this feature, click the **Connect** radio button to **On** (in the Alarm Settings configuration page) and confirm this choice by clicking the **Set** button. Now the unit will try to connect to the specified alarm IP address every time. The receiving station (alarm IP address) can be another receiver.

VIDEO MOTION DETECTION FEATURE

The transmitter can check video input automatically for significant motion in the scene and trigger an alarm if the motion exceeds a preset threshold. Activate motion detection by setting **Motion Detection** to **on** in the Alarm Settings configuration page.

Click the **Configuration** button to select parameters for motion detection. You need to tailor these parameters to the particular application. Experiment to find the best settings. For example, higher sensitivity may lead to erroneous detection and increase false alarms.

You can restrict motion detection to certain areas in the scene. Select the cells you want the system to monitor for motion. To set an individual cell, click it with the left mouse button (the cell will turn red). Click with the right mouse button to deselect a cell (which will turn white). Select or deselect multiple cells by holding down the left or right mouse button and dragging. Release when finished.

ALARM NOTIFICATION BY E-MAIL

The e-mail feature lets you send an e-mail message to a recipient on any alarm event. This could be used to signal an alarm to people who cannot be reached with a video-based notification.

To activate this feature, enable at least one of the alarm inputs, configure a receiver e-mail address, and activate the **Send Email** button. Remember to configure a mail server and gateway IP addresses on the General Settings configuration page.

Now the system will send an e-mail to the specified recipient on every alarm event. There will be a timeout of at least 30 seconds before the same alarm event generates another e-mail message.

The e-mail will contain the status of the four alarm inputs so you can see which event triggered the e-mail.

RECORD AND PLAY BACK THE DISPLAY ON A PC

Live video control pages let you record the camera display on a PC's hard drive and play it back later. The file is recorded on the hard drive of the PC on which you are viewing the picture. The controls are a row of buttons beneath the screen.

NOTE: Audio is not saved to the AVI file. Consequently, there is no audio on playback.



– These buttons jump the display to the beginning or ending of the recording in playback mode.



– These buttons incrementally move the display backward and forward while the display is paused in playback mode.



– This button stops the recording or playback.



– This button pauses the recording or playback.



– This button plays the recording.



– This button starts the recording.





– This button is used to designate a location for saving the recording.



– This button is used to load a recorded file for playback.



Recording The Display







Do the following to record the camera display:



1. Access a live video control page (by clicking **Control** on the Home page, and then clicking one of the underlined links to a live video control page).
2. Select a camera.
3. Position the camera as desired (if it has PTZ capability).
4. Click the  button. The Choose Directory window opens.
5. Select a location in which to save the recording. Click **OK**.
6. Click the  button to begin recording.
7. Click the  button to halt recording. The recording is saved automatically.

Playing Back The Recording

You can play back the camera recording either through the Windows Media Player or in PelcoNet through the browser. Do the following to play back the camera recording through the browser:

1. Access a live video control page (by clicking **Control** on the Home page, and then clicking one of the underlined links to a live video control page).
2. Click the  button. A directory window opens.
3. Select the directory where the file you want is located. Click the file to select it, and then click **Open**.
4. Click the  button to begin playback.

To advance or reverse the playback, first click the  button. Each click of a  or  button moves the recording a few frames. To move to the beginning or end of the recording, click a  or  button. Click the  button to resume playback.

5. Click the  button to halt playback and return to live video. You can replay the recording by clicking the  button.

FIRMWARE UPLOAD

Units have flash EPROMs for firmware upgrades in the field. These upgrades can be done directly from the web browser.

Do the following to upload firmware using the web browser:

1. Obtain the latest PelcoNet NET104A Transmission System firmware from Pelco (<http://www.pelco.com>).
2. Use the browser to select the General Settings configuration page of your unit.
3. Use the **Browse** button in the **Firmware** update field to select the correct new firmware file.
4. Click the **Upload** button.
5. After about 30 seconds you should get a feedback message from the connected unit.
6. The message "upload complete – WAIT" confirms the correct upload of the new firmware, which is now being installed. The alarm input LEDs will flash back and forth between red and green to indicate installation.

WARNING: Do not disconnect power to the unit for any reason while firmware is being installed. Disrupting the cycle will damage the flash EPROM. If this occurs, you will have to return the unit for repair.

When all the alarm input LEDs turn green, reprogramming is complete and the unit cycles power.

7. If you try to upload an invalid firmware file, you will get the message "Upload Failed."
8. If you revisit the General Settings configuration page after the firmware is uploaded successfully, you will see the message "New Firmware Installed."

TROUBLESHOOTING

If the following instructions fail to solve your problem, contact Pelco Technical Support at 1-800-289-9100 for help. You should have the serial number from the bottom of the unit and the firmware version ready in case they are needed.

Do not try to personally repair a unit. Opening it immediately voids any warranty. Leave maintenance and repairs to qualified technical personnel. Swap a defective unit with a replacement unit and return the defective one for repair.

BASIC FUNCTIONING

LEDs on the unit indicate its condition. The following sections describe malfunctions indicated by the LEDs.

Green Power LED

Green Power LED Is Off

If the green power LED on the front panel is off and you believe it should be blinking, check the following:

- Make sure the enclosed power supply is connected correctly to the power plug socket.
- Make sure the power supply is connected correctly to a functioning power outlet.
- Check the power cord for apparent damage.
- Check the power supply for a 5 VDC output. If it is correctly connected and the green power LED still does not light, exchange the power supply for a new one.

Green Power LED Blinks Slowly

This does not indicate a malfunction but means a connection exists between one unit and another. Connections with a web browser have no effect on this LED, so there will be no blinking light during configuration.

Green Power LED Lit

This indicates the NET104A is on but there is no connection.

Green Power LED Stays Off After Firmware Upload And Reprogramming

If the power LED does not come back on after a firmware upload, there may have been a problem during upload. Return the system to the dealer.

Closely follow the instructions for the firmware upload. Especially do not disconnect the power supply during firmware upload and reprogramming.

Ethernet LEDs

The green Ethernet LED should light when the Ethernet connection is made. If this LED is off:

Green Ethernet LED Is Off

- Make sure the network cable is firmly connected to the hub or switch.
- Does the hub or switch work correctly in the network? Check the power supply of the hub or switch.
- Use a Cat5 straight-through cable to connect to a normal hub. Check the cable for physical damage.
- Use a crossover cable if connecting a unit directly to a PC without a hub.

Yellow Ethernet LED Is Flashing

The yellow LED flashes briefly whenever a unit transmits a data packet (for example, when accessing the unit with a web browser). If this LED fails to come on, perform the following checks:

- Are all units connected correctly with the power supply? Check power supplies and connections.
- Did you configure the correct IP address for your unit?
- Is your web browser configuration correct?
- Is the TCP/IP protocol installed on your PC operating system, and is an IP address assigned to the PC?
- Are the subnet mask and gateway properly set up?

Contact your network administrator if you have problems installing your network.

Com LED

This green LED should flash when data is transmitted via serial interface.

Output LEDs

If green LED is lit, then the alarm output is switched. If not lit, then the output is inactive (idle state).

Input LEDs

If the LED is not lit, then the alarm input is inactive.

If the LED is lit green, then the alarm input is activated. If lit red, then the alarm is triggered.

If the LED changes from red to green, then program memory is being deleted (during firmware upload). The programming progress is indicated by the alternating green lighting of all five LEDs.

Video LEDs

When lit green, these LEDs indicate the corresponding video input is selected. (In multiplexer mode, the LEDs change automatically in quick succession.)

TERMINAL PROGRAM

If the terminal program fails to connect to the unit's terminal port, check the following:

- Is the right COM-port interface on the PC selected for the terminal program, and are the settings correct? Is the cable connected to the terminal and **not** the data port on the unit? Program default settings are 19200 kb/s, 8 data bits, no parity, 1 stop bit (8N1) for the terminal program.
- If the data exchange between the terminal program and the system still does not work, check the serial cable. Does the system answer when you enter a question mark?
- Disable the local echo if you see duplicate characters on your screen.

TROUBLESHOOTING A TCP/IP NETWORK USING A PING UTILITY

(Enter the appropriate information where indicated by the quotation marks below. Do not enter the quotation marks.)

To see if a unit in your network can be reached, try to ping your unit by typing the following command in a DOS window:

```
c:\>ping 'unit IP address'
```

If it is reached, there will be a response like the following:

```
Reply from <IP address>: bytes=32 time=NN ms TTL=xxx
```

If the LAN path is malfunctioning, the ping command will time out. If so, you could have one of the following problems:

- Wrong physical connections. Make sure the green Ethernet LED is on. See the *Basic Functioning* section for more information.
- Wrong network connection. Verify the IP address is entered correctly and that subnet mask and gateway address are set properly.

Otherwise, ask your network administrator.

TROUBLESHOOTING CONNECTION PROBLEMS

If you fail to connect to a system from a hardware receiver, check the following to pinpoint the problem:

- Do not connect two units of the same type (for example, receiver to receiver).
- Make sure network connectivity is available (for example, by using the ping command as described above).

TROUBLESHOOTING THE VIDEO CONNECTION

If no video or a distorted video image is displayed at the receiver during a connection to a transmitter:

- Make sure to use the right unit for your application: a camera can be connected only to a transmitter, never to a receiver.
- Make sure the camera is switched on and the coaxial cable is connected to the transmitter.
- Check the camera cable and connect a video monitor to the camera to check that the camera is functioning correctly.
- At the receiving system, make sure the monitor is switched on and the coaxial cable is connected to the receiver.
- Check the monitor cable and the selection of the monitor channel, if the monitor features more than one video channel.
- If the monitor can display only a single video standard (PAL or NTSC), check the setting of the video output format on the Video Settings configuration page.

TESTING THE AUDIO CONNECTION

This test procedure applies **only** to NET104A and NET101R-A units.

Test Between NET104A And NET101R-A

1. Connect a microphone (via a preamplifier) to the Audio In jack and a loudspeaker to the Audio Out jack on the NET104A. Connect a microphone to the Line-In RCA jack and a loudspeaker to the Line-Out cinch connectors on the NET101R-A.
2. Make sure the correct menu items are set on the Audio Settings configuration page of both systems; that is, select the appropriate interface (line I/O).
3. Switch the coding mode to G.711 or G.728.
4. Select a volume above zero.
5. After establishing the Ethernet connection, audio should be transmitted both ways.
6. Be sure the level is not set too low and that the right interface is selected.
7. If you cannot hear any audio, check the microphone and loudspeaker together with other audio equipment, and make sure the microphone is switched on if it has a power switch.

Test Between NET104A And PC

1. Connect a microphone (via a preamplifier) to the Audio In jack on the PelcoNet unit. Connect a microphone to the PC.
2. Make sure the correct menu items are set on the Audio Settings configuration page; that is, select the appropriate interface (line I/O).
3. Switch the coding mode to G.711 or G.728.
4. Select a volume above zero.
5. Connect a loudspeaker to the PC's sound card. Connect another loudspeaker to the Audio Out jack on the PelcoNet unit. After establishing the Ethernet connection, audio should be transmitted both ways. Press the F12 key on the PC and speak into the microphone; audio should be heard on the PelcoNet loudspeaker. Release the key to hear audio from the PelcoNet unit.
6. Be sure the level is not set too low and that the right interface is selected.
7. If you cannot hear any audio, check the microphone and loudspeaker together with other audio equipment, and make sure the microphone is switched on if it has a power switch.

SPECIFICATIONS

NETWORK PROTOCOL AND STANDARDS COMPATIBILITY

Internet Configuration	IP, TCP, UDP, ICMP, ARP, DHCP, HTTP, FTP, IGMP
Video Coding	H.261/263, H.323 (M-JPEG in Server Push mode only), G.711
Video Frame Rate	Up to 30 images/second

INTERFACES

Video Input (transmitter)	4 BNC, PAL/NTSC, 75 ohms, 1 Vp-p, RS-170, CCIR-601
Audio Input	RCA phono jack, -32 dBm0, variable
Audio Output	RCA phono jack, -10 to 0 dBm0, 600 ohms
LAN Interface	UTP (10/100BASE-T auto-sensing), RJ-45
LAN Data Rate	10 Kbps up to 1 Mbps
Data Interface	1 RS-232C/RS-422/RS-485, bi-directional (9-pin, D-sub)
Alarm Inputs	4 terminals for direct connection of controls, 1 master alarm input
Alarm Output	4 relays, maximum 24V, 0.8A

VIDEO

Video Standards	PAL, NTSC
Video Image Size	704 x 576 pixels (high resolution) 352 x 288 pixels (CIF)

POWER ADAPTER

Type	Plug power adapter
Input Voltage	100-240 VAC, 50/60 Hz
Output Voltage	12 VAC, 800 mA
Country-Specific Adapters	US (default), Australia, Europe, and UK. (<u>Specify when ordering.</u>)

NOTE: For countries other than the United States, you must also specify the appropriate transformer adapter when ordering. Please refer to the list below. (Adapter will be sent at no charge.)

NETPLUG4-AU	Transformer adapter, Australian.
NETPLUG4-EU	Transformer adapter, European.
NETPLUG4-UK	Transformer adapter, United Kingdom.
NETTRANS4	Replacement transformer, 100-240 VAC.

MISCELLANEOUS

LED Displays 17 LEDs (video, inputs, outputs, Ethernet, connection, power)

ENVIRONMENTAL

Operating Temperature 41° to 104°F (5° to 40°C)
Operating Humidity 80% maximum relative humidity, non-condensing
Storage Temperature -4° to 140°F (-20° to 60°C)
Storage Humidity 95% maximum relative humidity, non-condensing

GENERAL

Dimensions 1.4 (H) x 10.2 (W) x 6.5 (D) inches (3.5 x 26.0 x 16.5 cm)
Unit Weight 2.8 lb (1.3 kg), without power supply
Shipping Weight 4.1 lb (1.9 kg), with power supply

CERTIFICATIONS

- CE, Class B
- cTUVus
- FCC, Class A

OPTIONAL ACCESSORIES

NET101R Single-character video receiver with integrated Ethernet connection
NET101R-A Same as NET101R plus audio function

GLOSSARY

10BASE-T	IEEE 802.3 specification for 10 Mbs Ethernet
ARP	Address Resolution Protocol
b/s	Bits per second, the actual data rate
Cat5 Cable	Type of cable used on a LAN to connect computers, printers, and transmitters and receivers to a hub on the network
CIF	Common Intermediate Format; video format with 352 x 288 pixels
Default Gateway	The router's IP address (for example, 192.168.0.1)
DHCP	Dynamic Host Configuration Protocol
DNS	Domain Name Service
FTP	File Transfer Protocol
Full Duplex	Simultaneous data transmission in both directions
G.711, G.728	Standard audio coding algorithms defined by ITU-T
H.224	Standard protocol for data communication and remote control
H.261	Standard motion video coding algorithm defined by ITU-T
H.323	Standard for M-JPEG video and audio compression defined by ITU-T
HTTP	Hypertext Transfer Protocol
HTML	Hypertext Markup Language
Hub	A device on the network that connects multiple computers together to form a LAN
ICMP	Internet Control Message Protocol
ID	Identification: machine-readable number or name
IEEE	Institute of Electrical and Electronics Engineers
Internet Protocol	The main protocol used on the Internet. Forms—in conjunction with the Transfer Control Protocol (TCP)—the TCP/IP protocol suite

IP	See Internet Protocol
IP Address	A unique four-byte number that identifies each unit on the Internet or network. Usually written in dotted-decimal notation with periods separating the bytes. This address is required to communicate on the network (for example, 192.168.0.100).
ISP	Internet Service Provider
JPEG	Joint Photographic Expert Group (procedure to encode still images)
LAN	See Local Area Network
Local Area Network	Multiple computers linked together into a network to share information within a limited geographic area (such as a building or a campus) controlled by a network operating system and using a transport protocol
MAC Address	Media Access Control/hardware address
NAT	See Network Address Translator
Network Address Translator	A proposal for IP address re-use where the local IP address is mapped to a globally unique address
Picture	A video picture that has been digitized at a particular resolution
PPP	See Point-To-Point Protocol
Point-To-Point Protocol	A protocol allowing a computer using TCP/IP to connect directly to the Internet
Router	A physical device that connects multiple LANs
QCIF	Quarter CIF, video format with 176 x 144 pixels
Server Push	A continuous stream sent from the transmitter to the web browser
Subnet Mask	A mask that explains which part of an IP address is the network address and which part composes the host address. It is usually expressed in dotted-decimal notation (for example, 255.255.255.192).
TCP	Transfer Control Protocol
UDP	User Datagram Protocol
URL	Uniform Resource Locator

UTP	Unshielded Twisted Pair
WAN	See Wide Area Network
Wide Area Network	Multiple LANs connected together, usually over a great distance

APPENDIX A – CONNECTING PELCONET NET104A TO VARIOUS COMPONENTS

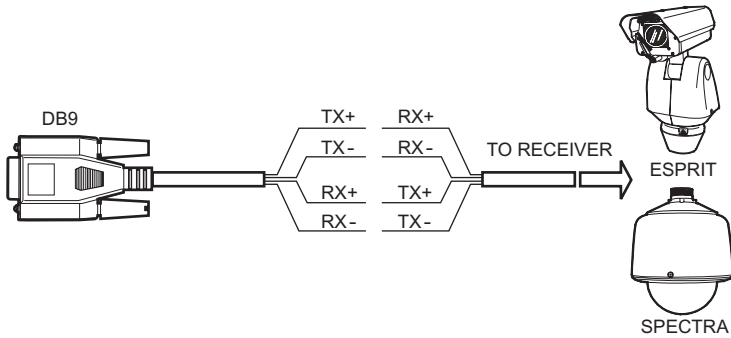

PIN	RS-232	RS-422/RS-485
	1	DCD (DATA CARRIER DETECT)
2	RXD (RECEIVE DATA)	RXD- (RECEIVE DATA MINUS)
3	TXD (TRANSMIT DATA)	TXD- (TRANSMIT DATA MINUS)
4	DTR (DATA TERMINAL READY)	
5	GND (GROUND)	GND
6	DSR (DATA SET READY)	
7	RTS (READY TO SEND)	TXD+ (TRANSMIT DATA PLUS)
8	CTS (CLEAR TO SEND)	RXD+ (RECEIVE DATA PLUS)
9		

Figure 38. DB9 Cable Wire Splicing

CONNECTING PELCONET TO VARIOUS COMPONENTS WITH ASSORTED KEYBOARDS

Connection Scenario 1

Refer to Figure 39 and the instructions that follow.

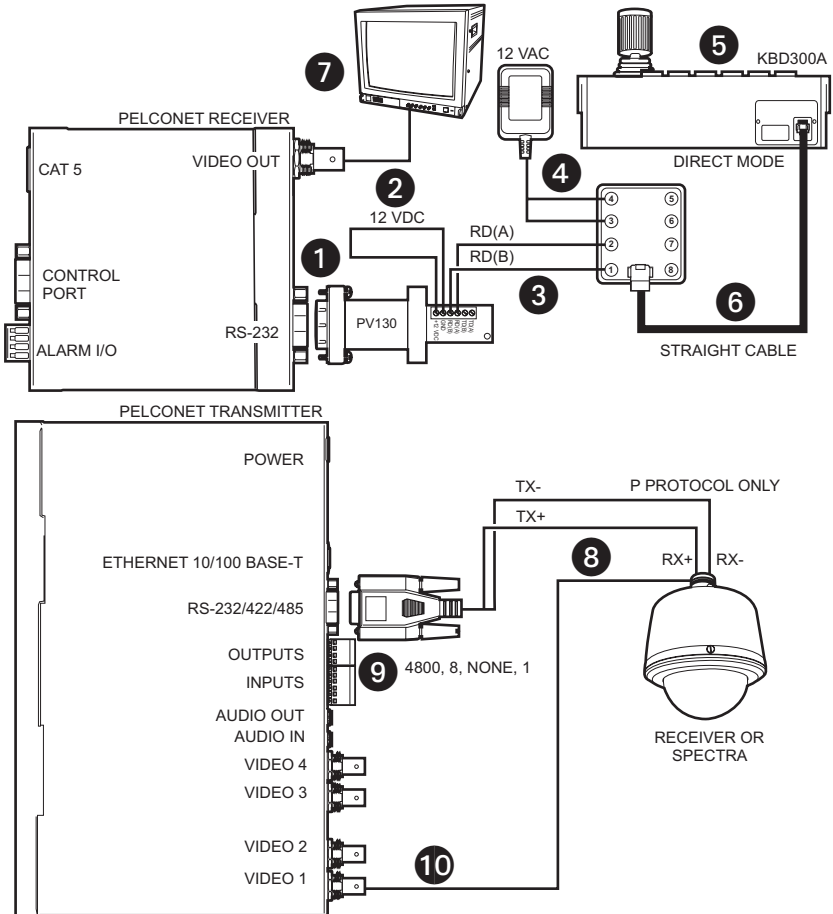

Figure 39. KBD300A (Direct Mode) Connected to a Receiver or Spectra Dome System

- 1 Connect a PV130 Converter to the RS-232 port on the front of the NET101R/R-A receiver. The data format should be 4800 baud, 8 data bits, no parity, and 1 stop bit.
- 2 Connect the black and white striped wire from the power supply that comes with the converter to the converter's +12 VDC terminal and the solid black wire to the GND terminal.
- 3 Connect RD(A) on the converter to terminal 2 on the wall block. Connect RD(B) on the converter to terminal 1 on the wall block.
- 4 Connect a 12 VAC power supply to terminals 3 and 4 on the wall block.
- 5 Set DIP switch 6 on the KBD300A to ON to enable turbo pan operation or OFF to disable that feature. The KBD300A will recognize Direct Mode automatically.
- 6 Connect the wall block to the KBD300A with an RJ-45 straight cable.
- 7 Connect the monitor.
- 8 Refer to Figures 38 and 39. Splice the supplied DB9 cable into the Spectra/Esprit or receiver cable. Use P protocol only.

To connect multiple Spectras/Esprits or receivers to the transmitter, daisy chain them in a series through the TX- and TX+ cable and attach the video cables to inputs 2 through 4.

- 9 Plug the supplied DB9 cable into the COM port on the transmitter. The data format should be 4800 baud, 8 data bits, no parity, and 1 stop bit.
- 10 Connect the camera's video to the transmitter.

Connection Scenario 2

Refer to Figure 40 and the instructions that follow.

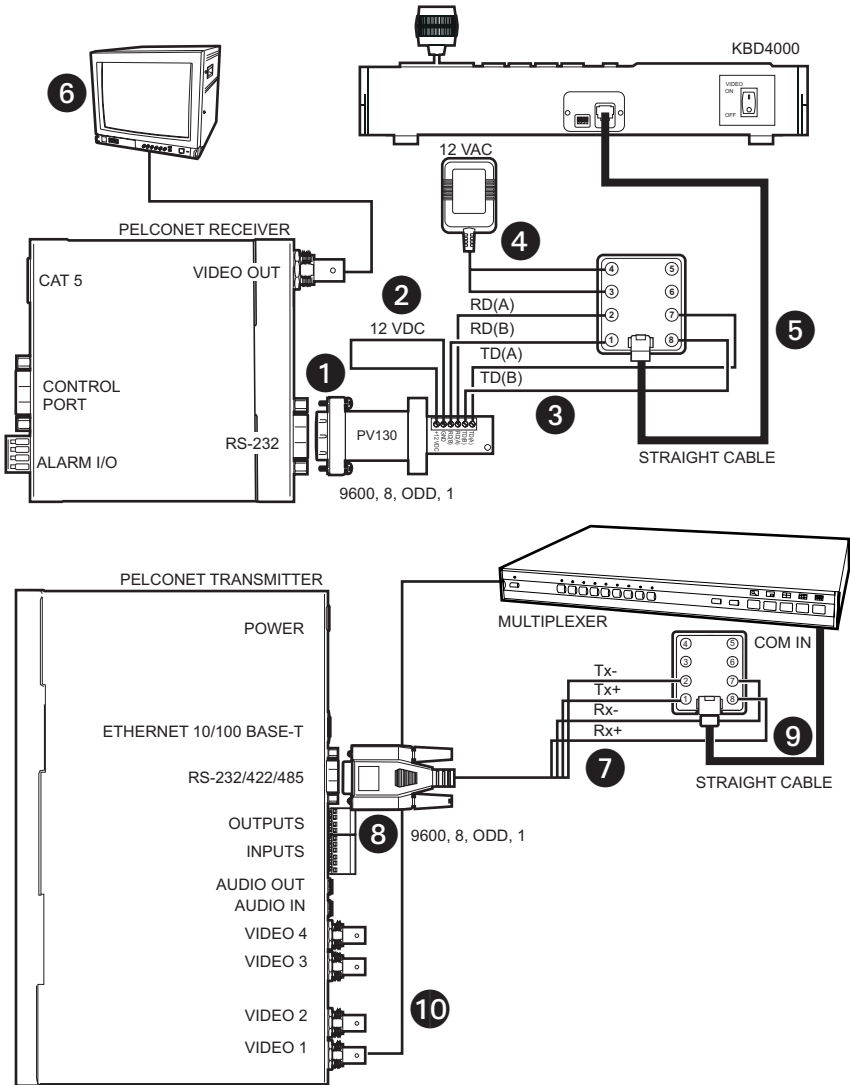

Figure 40. KBD4000 Connected to a Multiplexer

- 1 Connect a PV130 Converter to the RS-232 port on the front of the NET101R/R-A receiver. The data format must be 9600 baud, 8 data bits, odd parity, and 1 stop bit.
- 2 Connect the black and white striped wire from the power supply that comes with the converter to the converter's +12 VDC terminal and the solid black wire to the GND terminal.
- 3 Connect TD(A) on the converter to terminal 7 on the wall block. Connect TD(B) on the converter to terminal 8 on the wall block. Connect RD(A) on the converter to terminal 2 on the wall block. Connect RD(B) on the converter to terminal 1 on the wall block.
- 4 Connect a 12 VAC power supply to terminals 3 and 4 on the wall block.
- 5 Connect the wall block to the KBD4000 with an RJ-45 straight cable.
- 6 Connect the monitor.
- 7 Refer to Figures 38 and 40. Splice the supplied DB9 cable into the multiplexer wall block. Connect TX- from the NET104A to terminal 2 on the wall block, TX+ to terminal 1, RX- to terminal 7, and RX+ to terminal 8.
- 8 Plug the supplied DB9 cable into the COM port on the transmitter. The data format must be 9600, 8, odd, 1.
- 9 Connect the wall block to COM IN on the multiplexer with an RJ-45 straight cable.
- 10 Connect MAIN video output from the multiplexer to the transmitter.

Connection Scenario 3

Refer to Figure 41 and the instructions that follow.

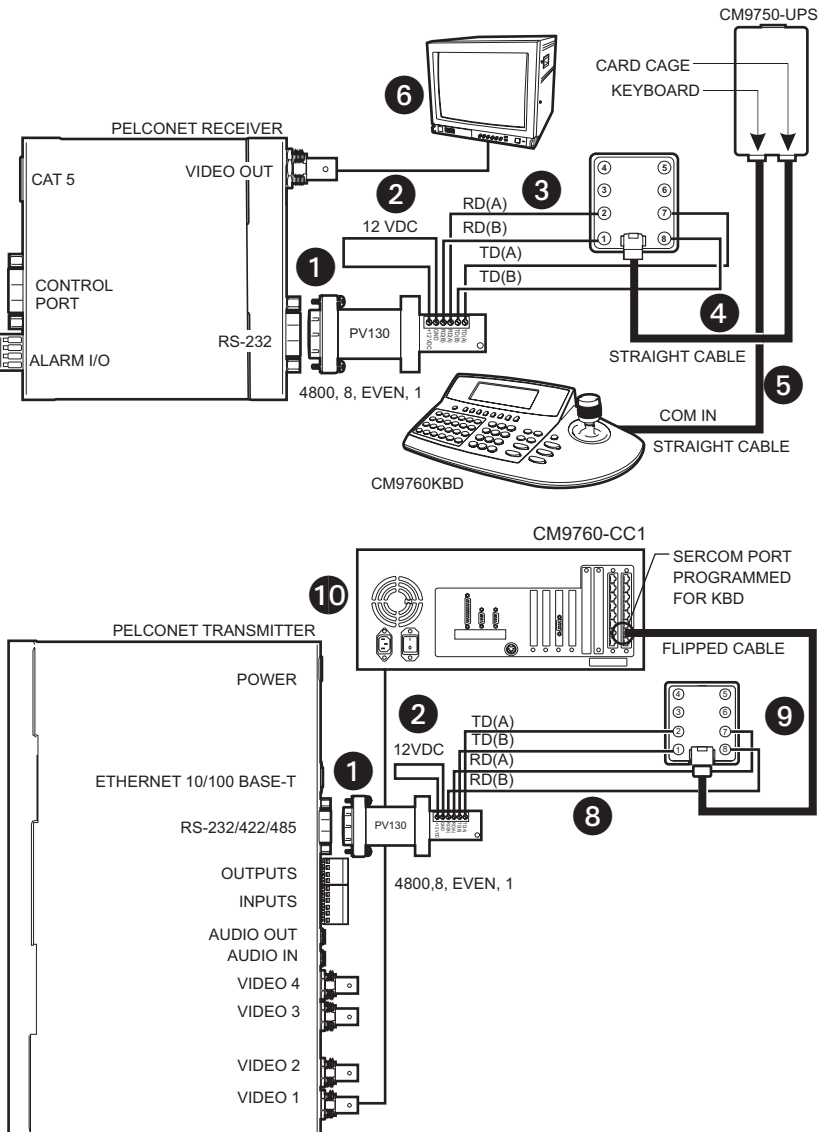

Figure 41. CM9760KBD Connected to a CM9760-CC1 Controller

- 1 Connect a PV130 Converter to the RS-232 port on the front of the NET101R/R-A receiver. The data format must be 4800 baud, 8 data bits, even parity, and 1 stop bit.
- 2 Connect the black and white striped wire from the power supply that comes with the converter to the converter's +12 VDC terminal and the solid black wire to the GND terminal.
- 3 Connect TD(A) on the converter to terminal 7 on the wall block. Connect TD(B) on the converter to terminal 8 on the wall block. Connect RD(A) on the converter to terminal 2 on the wall block. Connect RD(B) on the converter to terminal 1 on the wall block.
- 4 Connect an RJ-45 straight cable from the wall block to the supplied Pelco power pack.
- 5 Connect an RJ-45 straight cable from the keyboard input connector on the power pack to COM 1 on the keyboard.
- 6 Connect the monitor.
- 7 Refer to Figures 38 and 41. Splice the supplied DB9 into the CM9760-CC1 wall block. Connect TX- from the NET104A to terminal 2 on the wall block, TX+ to terminal 1, RX- to terminal 7, and RX+ to terminal 8.
- 8 Plug the supplied DB9 cable into the COM port on the transmitter. The data format must be 4800, 8, even, 1.
- 9 Connect an RJ-45 flipped cable from the wall block to Sercom port 5 on the CC1's rear panel.
- 10 Connect one of the three monitor outputs on the rear of the controller to the transmitter.

CONNECTING PELCONET TO THE COM IN RS-232 PORT ON A GENEX MULTIPLEXER

Refer to Figure 42 and the instructions that follow.

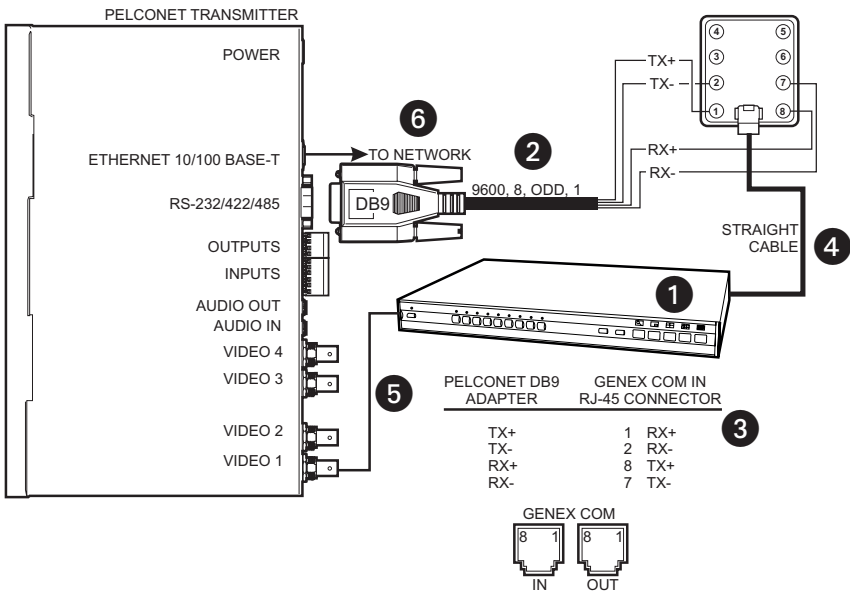

Figure 42. Connecting PelcoNet to Genex Using the COM IN RS-232 Port

- 1 Verify that the multiplexer has Version 4.1 firmware. (The version number flashes on the monitor when power is applied to the multiplexer.)
- 2 Set the NET104A data port to **Transparent, 9600 baud, 8 data bits, none** (for parity), **1 stop bit, RS-232**, and half duplex mode **off** if it is not so set already.
- 3 Create a cable using the above diagram.
- 4 Attach the cable's DB9 connector end to PelcoNet's data port. Connect the cable's RJ-45 connector end to COM OUT on the back of the multiplexer.
- 5 Connect the MAIN video output from the multiplexer to the NET104A transmitter.
- 6 Connect PelcoNet's Ethernet port to the network using a Cat5 Ethernet patch cable.

CONNECTING A PELCONET RECEIVER TO A SYSTEM CM9502

Refer to Figure 43. This configuration lets an operator view and control cameras with a CM9505 keyboard.

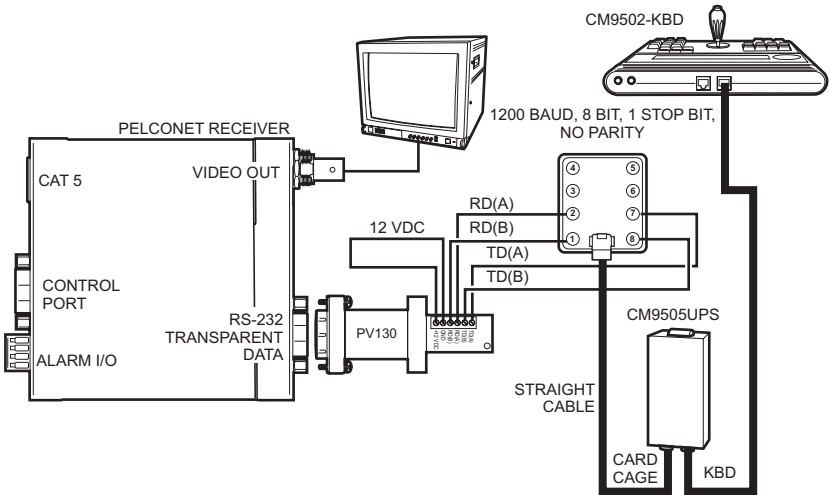

Figure 43. Using PelcoNet with CM9505 to Provide Remote Control

CONNECTING PELCONET TO A CM9502 ASCII SERIAL PORT

Refer to Figures 38 and 44. This configuration lets an operator view and control cameras from a PC using a web browser. (The operator's PC is not shown on the diagram.)

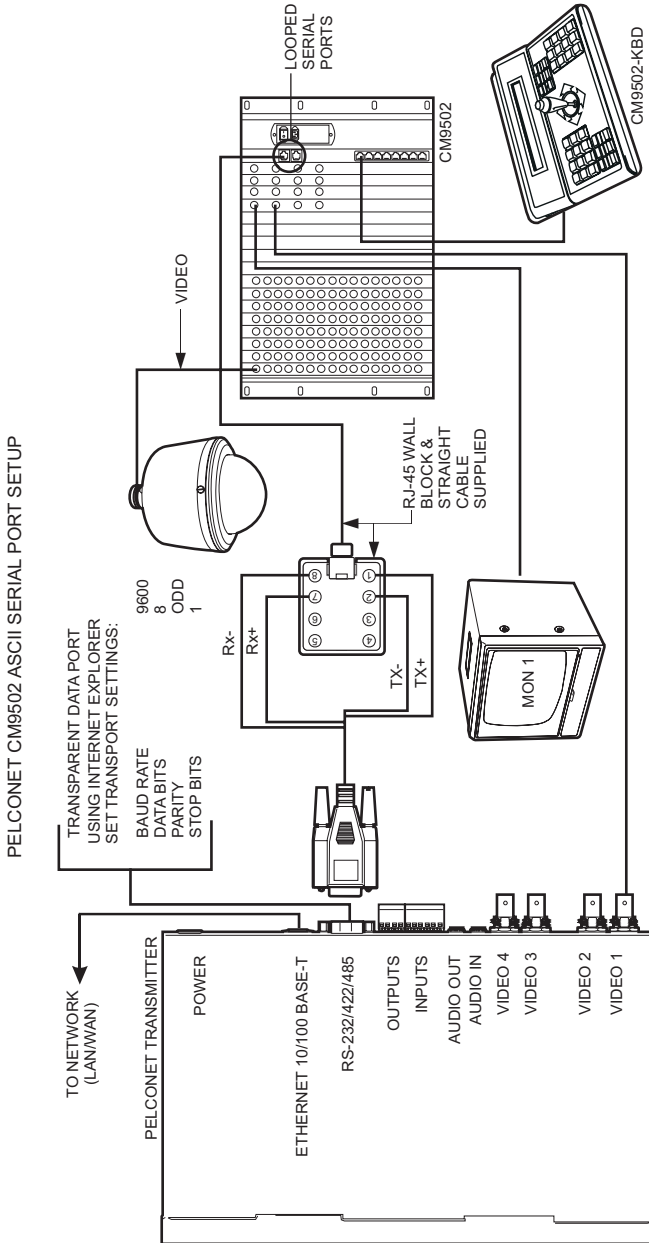

Figure 44. Using PelcoNet with CM9502 to Provide Remote Control

CONNECTING PELCONET TO A CM6700 AND KBD200A FOR REMOTE ASCII CONTROL

Refer to Pelco Tech Tip 00-3042 for an illustration (available on Pelco's web site). This configuration lets an operator view and control cameras with a remote KBD200A keyboard.

CONNECTING PELCONET TO A CM6700 ASCII PORT

Refer to Figure 45. This configuration lets an operator view and control cameras from a PC using a web browser. (The operator's PC is not shown on the diagram.)

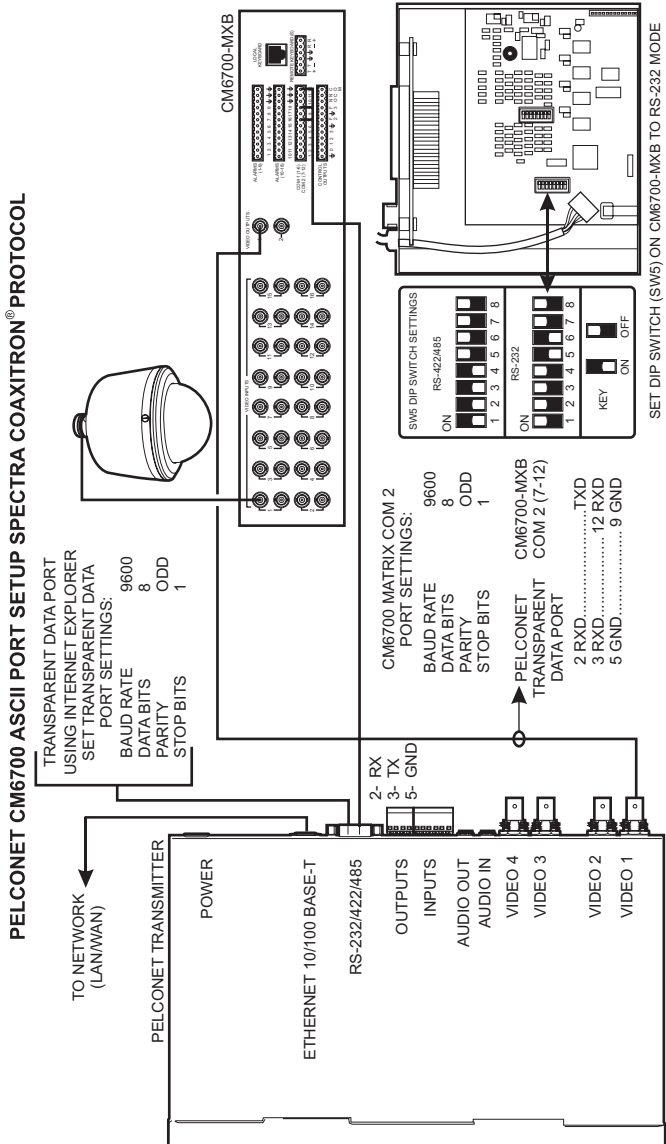

Figure 45. Using PelcoNet with CM6700 to Provide Remote Control

CONNECTING PELCONET TO A CM9760-DT FOR REMOTE BROWSER CONTROL

Refer to Figure 46. This configuration lets an operator view and control cameras on a PC using a web browser. (The operator's PC is not shown on the diagram.)

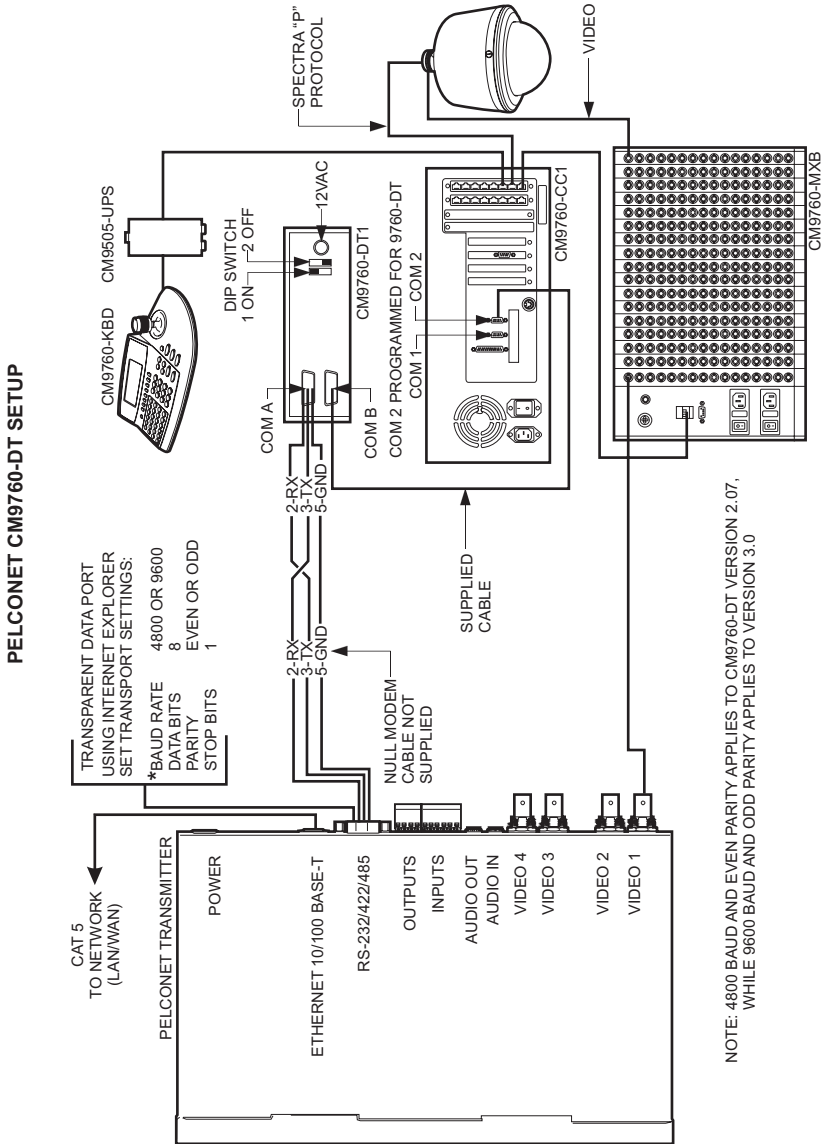

Figure 46. Using PelcoNet with CM9760-DT to Provide Remote Control of a 9760 Monitor Output

CONNECTING PELCONET TO CM9760 EQUIPMENT FOR REMOTE COMMUNICATION

Refer to Figures 38, 47, and 48. These configurations let an operator remotely view and control cameras connected to the CM9760.

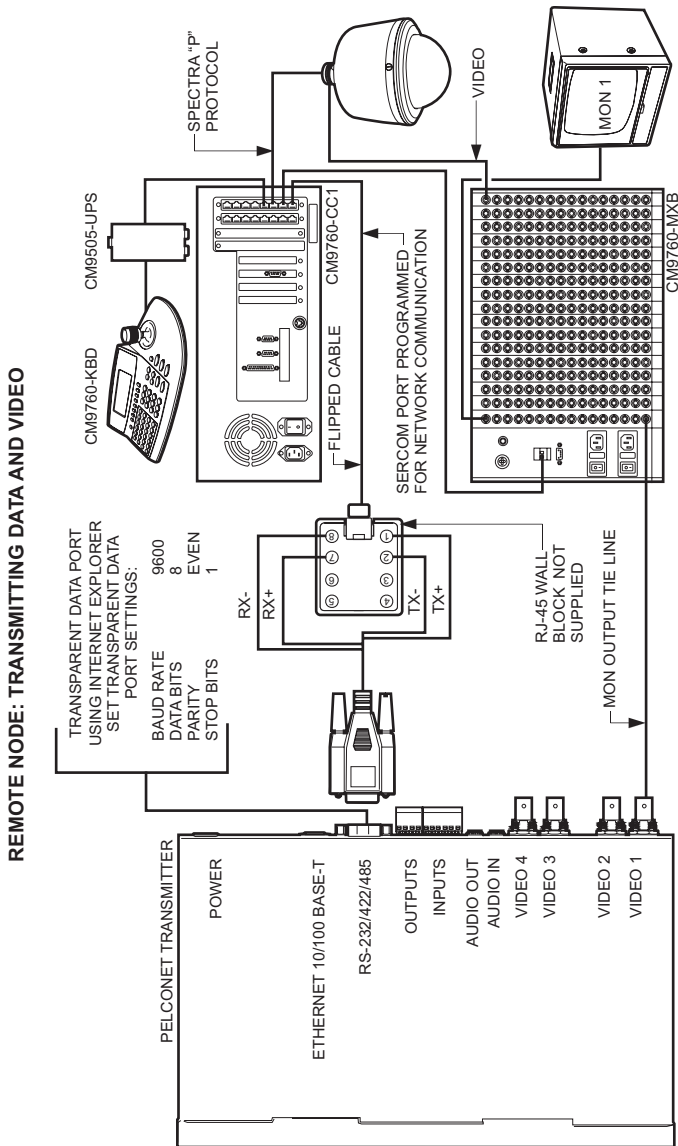

Figure 47. Using PelcoNet to Transmit Data and Video Between 9760 Nodes

LOCAL NODE: RECEIVING DATA AND VIDEO

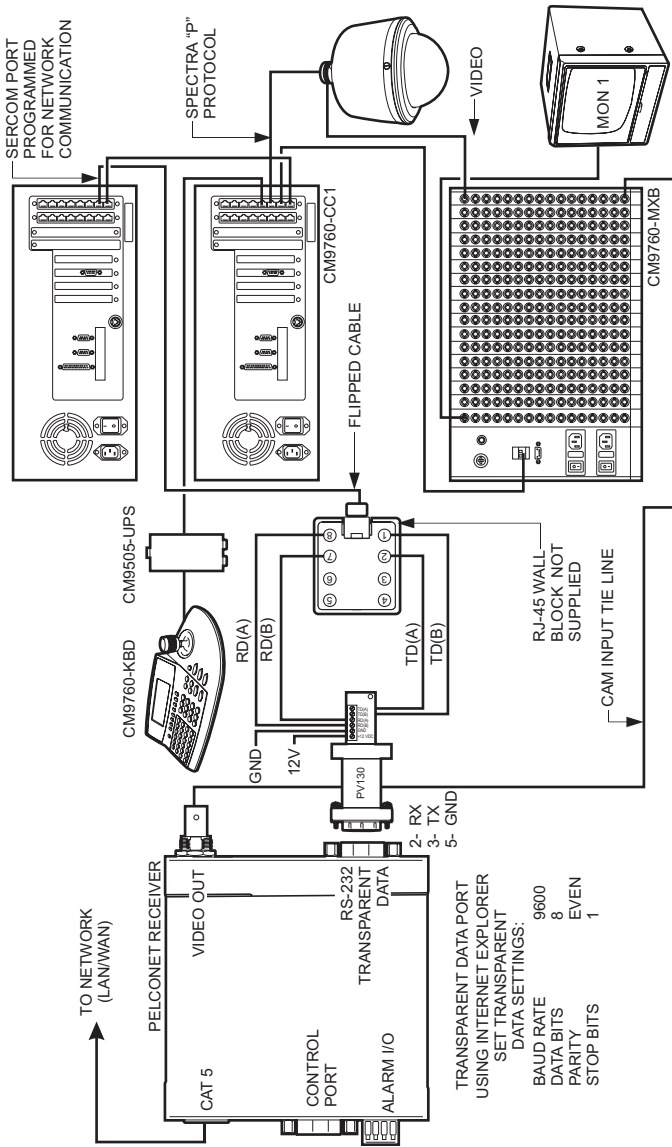

Figure 48. Using PelcoNet to Receive Data and Video Between 9760 Nodes

CONNECTING A PELCONET TRANSMITTER TO THE CM6800 ASCII PORT

Refer to Figure 49. This configuration lets an operator view and control cameras with a PC using a web browser. (The operator's PC is not shown on the diagram.) All settings are done in the CM6800 manager program or through a CM6800 menu. Note the following:

- Port 2 defaults to ASCII and RS-232.
- Ports 7 and 8 can be set to ASCII and RS-232 by using the CM6800 manager program (refer to Figure 50) or by using a CM6800 menu (refer to Figure 51).

Pelco recommends using Port 2.

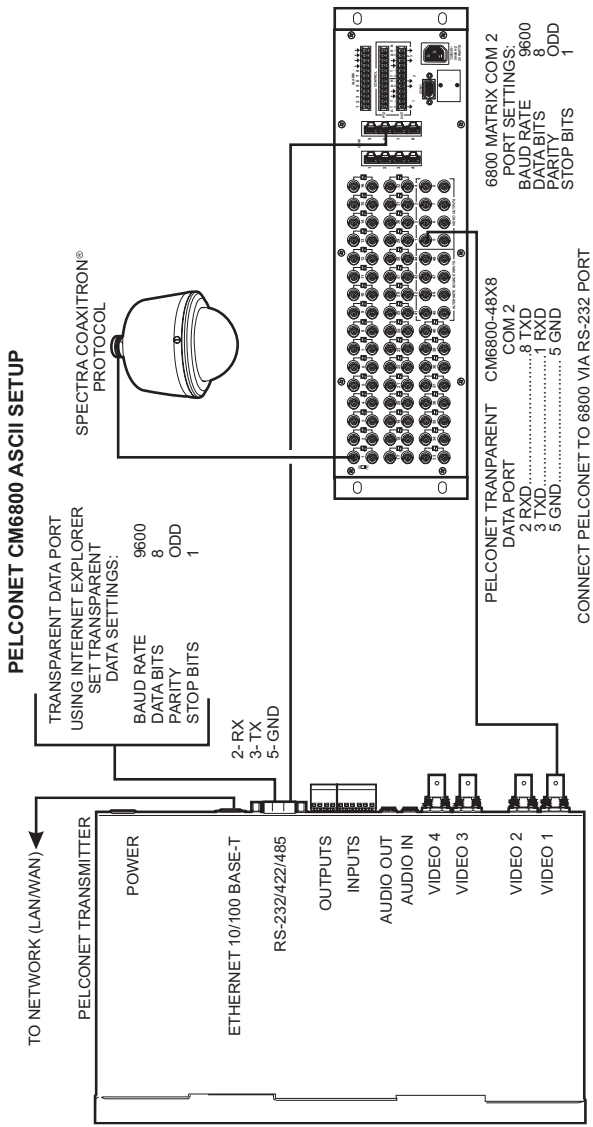

Figure 49. Using PelcoNet with CM6800 to Provide Remote Control

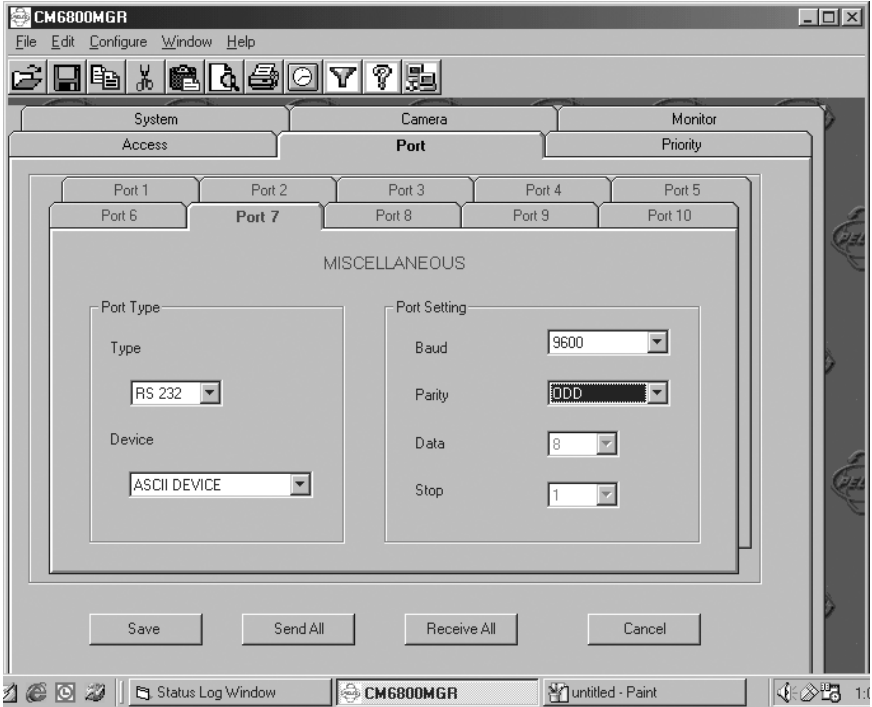

Figure 50. Manager Screen

```

SET SERIAL PORT 07

DEVICE:      ASCII
TYPE:        RS232
BAUD RATE:   9600
PARITY:      ODD
DATA BITS:   8
STOP BITS:   1

RETURN

```

Figure 51. Menu Screen

CONNECTING PELCONET TO A CM6800 AND KBD200A FOR REMOTE ASCII CONTROL

Refer to Figure 52A and Figure 52B. This configuration lets an operator view and control cameras with a remote KBD200A keyboard. All settings are done in the CM6800 manager program or through a CM6800 menu. Note the following:

- Port 2 defaults to ASCII and RS-232.
- Ports 7 and 8 can be set to ASCII and RS-232 by using the CM6800 manager program (refer to Figure 50) or by using a CM6800 menu (refer to Figure 51).

Pelco recommends using Port 2.

PELCONET REMOTE KBD200A ASCII MODE SETUP

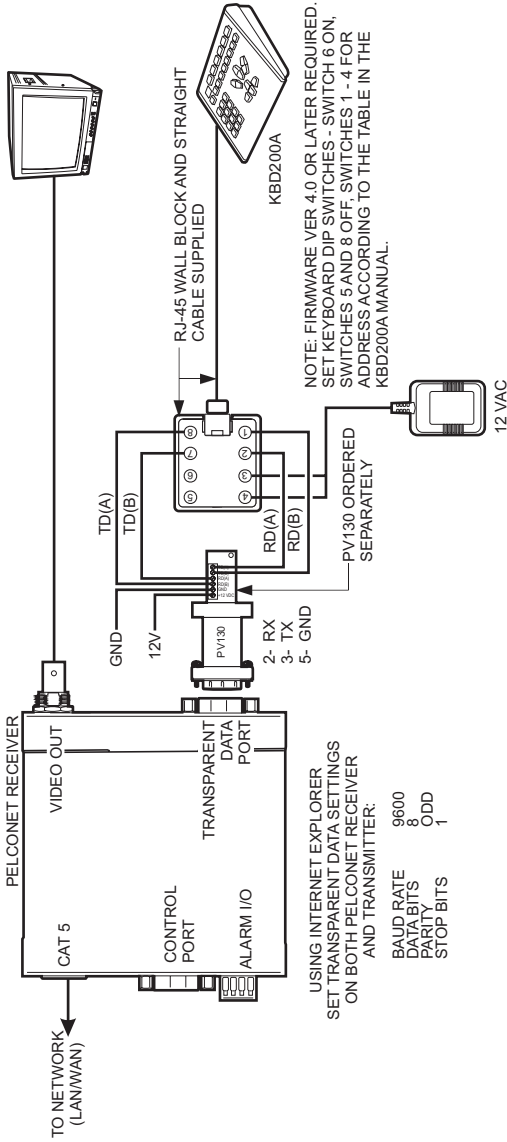

Figure 52A (Part 1). Using PelcoNet with CM6800 and KBD200A to Provide Remote Control

PELCONET CM6800 ASCII SETUP

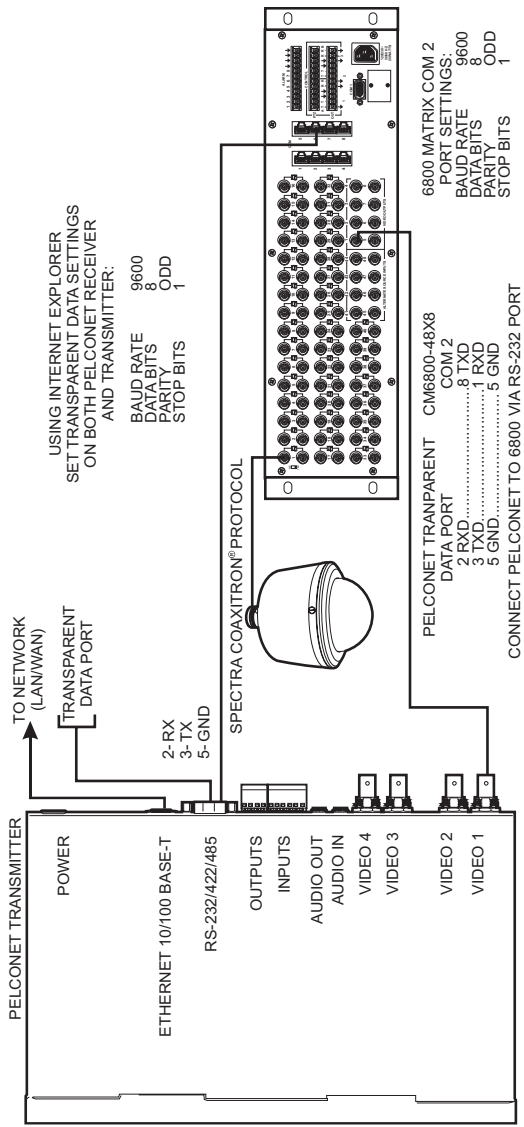

Figure 52B (Part 2). Using PelcoNet with CM6800 and KBD200A to Provide Remote Control

APPENDIX B – FREQUENTLY ASKED QUESTIONS (FAQs)

1. **What Pelco devices can I control from my computer with the PelcoNet NET104A Transmission System?**

PelcoNet can control the following from Internet Explorer:

- Spectra and Esprit
- Genex multiplexer
- CM9760 matrix (requires CM9760 data translator)
- CM9740 matrix (requires CM9760 data translator)
- CM9502 matrix (through integrated ASCII port)
- CM8500 matrix (requires latest CM8500 data translator)
- CM6700 matrix (through integrated ASCII port, COM 2)
- CM6800 matrix

2. **What TCP/IP ports does PelcoNet use?**

PelcoNet lets you select which base port to use. The default is 25000. This means PelcoNet will use TCP ports 25000-25001 and UDP ports 25002-25011 (12 ports total) for all video and control data. The ports must be open for PelcoNet to function properly.

3. **Can I view PelcoNet over the Internet?**

Yes. You will need a static IP address and enough bandwidth to view live video. Pelco recommends a minimum of 250 Kbps for medium image quality. Also check with your ISP to verify the correct TCP and UDP ports are open through any routers or firewalls through which you will connect. The base ports are adjustable in PelcoNet. For example, if you choose port 25000 (default), it will use TCP ports 25000-25001 and UDP ports 25002-25011 (12 ports total) for all communication: video and control.

4. **How many connections does PelcoNet support? Can more than one receiver connect to a transmitter at the same time?**

Yes. PelcoNet can support an unlimited number of receivers. To do so, all hubs, switches, and routers must support multicasting (IGMP), and PelcoNet must be configured to use multicasting. If the network hardware does not support this, then the maximum number of simultaneous connections is five.

5. **Can I enlarge the picture size in the browser?**

Yes. You can select from two different image sizes in PelcoNet with the browser: 288 x 352 or 576 x 704.

6. **What software does PelcoNet require?**

PelcoNet works with Internet Explorer 5.5 or higher. An ActiveX plug-in is also required for Internet Explorer to get live video. All software is included.

7. Can I control other manufacturers' equipment from the browser?

Not at this time.

8. Can I record video with PelcoNet?

Yes. PelcoNet can record video to the hard drive of the viewing PC. The video is recorded in AVI format, which allows playback through either the browser or Windows Media Player.

9. Everything is wired correctly but I do not have any control from the browser. What else could be wrong?

The transparent data port settings must be set to match the equipment to which PelcoNet is connected.

Also, in Internet Explorer, the Microsoft Virtual Machine must be enabled. To do so: on the Tools menu, select Internet Options. Then select the Advanced tab. Locate the option Microsoft VM. Place a check mark next to Java Console Enabled and JIT compiler for virtual machine enabled. Reboot your computer.

These options are required for the Java applets in PelcoNet to function properly.

10. Can I control the Genex multiplexer from the browser and have a local KBD4000?

Yes. You must have Genex Version 4.1 or higher. This version lets you connect a KBD4000 to the Genex COM IN port and PelcoNet to the Genex COM OUT. This gives you both local and remote control. Refer to *Connecting PelcoNet to the COM OUT RS-422 Port on a Genex Multiplexer* in Appendix A for detailed information.

11. Can I control the Genex multiplexer server?

Not at this time.

12. Can I use DHCP (dynamically assigned IP address) with PelcoNet?

Yes.

13. What type of compression does PelcoNet use?

PelcoNet uses the H.323 standard. H.323 is an industry standard for video teleconferencing over the Internet. It provides the most effective use of bandwidth with excellent video quality.

14. I do not get live video in the browser but server push is working. What could be wrong?

Verify that the ActiveX plug-in is installed and that your video is set to 16-bit color. Also check with your network administrator to verify that the TCP/IP ports PelcoNet uses are not being filtered and that you have enough bandwidth.

15. How do I program PelcoNet with HyperTerminal?

Using a null modem cable, connect a COM port on your PC to the COM port on NET104A. Open HyperTerminal and set the port to use to 19200, 8, N, 1, and No Flow Control. Type **?**, and follow the help menu.

16. How much bandwidth does PelcoNet use?

PelcoNet's bandwidth is adjustable. You can set it from 10 Kbps up to 1 Mbps. Pelco recommends a minimum of 250 Kbps for live video at medium image quality. Check with your network administrator for how much bandwidth to use.

17. Can I use PelcoNet with a DSL or cable connection?

Yes. You will need a static IP address from your provider. Also verify what kind of bandwidth you will get since it varies by location. Verify that your provider is not filtering the TCP/IP ports that PelcoNet uses.

Symbols

10BASE-T 17, 34

A

ActiveX 50, 62
ActiveX control file 38
Alarm connect 58
Alarm indicator 56
Alarm input active high/low 57
Alarm input pins 57
Alarm IP address 58, 70
Alarm IP set command 35
Alarm settings configuration page 54
Alarm status 57
Audio coding mode 53
Audio input level 53
Audio line in/out 30
Audio output level 53
Audio settings configuration page 52
Average n[frames] 56

B

Base port 47
Baud rate 61
Bistable mode 59
Buttons for recording/playback 71

C

Camera follows alarm input 57
Camera names 50
Coding mode 53
Com ports 61
Command reference 36
Common Intermediate Format (CIF) 49
Configuration download 44
Configuration pages 38
 alarm settings 54
 audio settings 52
 general settings 42
 interface settings 60
 network settings 46
 video settings 48
Configuration upload 44
Connect (to IP address) 58
Connect to alarm IP command 35
Country specific adapters 79

D

Data bits 61
Date (system) 43
Default address 19
Defaults button (motion detection) 56
DHCP 47
Disconnect 23
Disconnect commands 35
Display MAC address command 35
Display version information command 35
Door entry system 58

E

Email alarm notification 71
Email notification 58
Enable multicast streaming 47
Enable multilink h.323 47
Esprit live video/server push page contents 69

F

Firmware update 44
Firmware upload 73
Flash EPROM 73
FTP server IP address 51
Full duplex audio 23, 58

G

G.711/G.728 audio compression standards 53
Gateway IP address 23, 46
Gateway IP address set command 35
General settings configuration page 42
Genex live video/server push page contents 66

H

Halfduplex mode 61
Hardware version number 44
Hardware-to-hardware 22
Help menu command 35
HTTP server 38

I

Idle state 59
Input level 53
Interface settings configuration page 60
Internet 38, 40
IP address 11
IP address set command 35
IP address setting 46

J

JPEG 58, 71
JPEG file name 51
JPEG size 51

L

Live video auto connect 58
Live video receive IP 58
Local sensitivity 56
Login name 51

M

Mail reply address 47
Mail server IP address 47
Master alarm input pin 57
Matrix Control live video/server push page
 content 65
Menu tree 39
Microsoft Internet Explorer 38
Monostable 59
Motion alarm 55
Motion detection 55, 70
Motion tracking 55
Motion-JPEG 20
Multicast group IP 47
Multicast video port 47

N

Network administrator instructions 9
Network interface bandwidth 50
Network settings configuration page 46
Non-volatile memory 41

O

Object min size [n*n blocks] 56
Operate relay 59
Output level 53

P

Parity 61
Password (field) 43
Password (server field) 51
Password level 43
Password setting 43
Path 51
Patterns 64
Pelco Internet home page 38
Playback buttons 71
Playing the recording 72
Presets 64
Programming menus 64
PTZ cameras 12

Q

QCIF (Quarter Common Intermediate Format)
 49

R

Real-time clock 42
Receiver email address 59
Recording buttons 71
Recording the display 72
Relay (operate) 59
Relay follows 59
Relay idle state 59
Relay names 59
Remote password 58
RS-232 interface flow control mechanism 23
RS-232/485 61
RS-485 converter support 61

S

- Select area 55
- Send email 58
- Sensitivity of motion detection 70
- Server Push 20
- Set button 41
- SMTP server 47
- Software version number 44
- Spectra live video/server push page contents
68
- Status of alarm inputs 71
- Stop bits 61
- Subnet mask 46
- Subnet mask set command 35

T

- Terminal program commands 34
- Time (system) 43
- Time server IP 44
- Time slice 51
- Time stamping 51
- Time to live (multicast) 47
- Time zone 43
- Timeout for email messages 71
- Tracker box 55
- Transmission rate 50
- Trigger relay 59

U

- Unit ID 43
- Unit name 43

V

- Version numbers for hardware/software 42
- Video alarm 55
- Video bandwidth ActiveX 50
- Video priority 50
- Video quality 49
- Video resolution 49
- Video settings configuration page 48
- Video standard 30, 49

W

- Web browser 10, 23, 38

WARRANTY AND RETURN INFORMATION

WARRANTY

Pelco will repair or replace, without charge, any merchandise proved defective in material or workmanship for a period of one year after the date of shipment. Exceptions to this warranty are as noted below.

- Five years on Pelco manufactured cameras (CC3500/CC3600/CC3700 and MC3500/MC3600 Series); two years on all other cameras.
- Three years on Genex® Series (multiplexers, server, and keyboard) and 090 Series Camclosure® Camera System.
- Two years on 100/150, 200 and 300 Series Camclosure® Camera Systems.
- Two years on all standard motorized or fixed focal length lenses.
- Two years on Legacy®, CM6700/CM6800/CM8500/CM9500/CM9740/CM9760 Matrix, DF5 and DF8 Series Fixed Dome products.
- Two years on Spectra®, Esprit®, and PS20 Scanners, including when used in continuous motion applications.
- Two years on Esprit and WW5700 series window wiper (excluding wiper blades).
- Eighteen months on DX Series digital video recorders.
- One year (except video heads) on video cassette recorders (VCRs). Video heads will be covered for a period of six months.
- Six months on all pan and tilts, scanners or preset lenses used in continuous motion applications (that is, preset scan, tour and auto scan modes).

Pelco will warrant all replacement parts and repairs for 90 days from the date of Pelco shipment. All goods requiring warranty repair shall be sent freight prepaid to Pelco, Clovis, California. Repairs made necessary by reason of misuse, alteration, normal wear, or accident are not covered under this warranty.

Pelco assumes no risk and shall be subject to no liability for damages or loss resulting from the specific use or application made of the Products. Pelco's liability for any claim, whether based on breach of contract, negligence, infringement of any rights of any party or product liability, relating to the Products shall not exceed the price paid by the Dealer to Pelco for such Products. In no event will Pelco be liable for any special, incidental or consequential damages (including loss of use, loss of profit and claims of third parties) however caused, whether by the negligence of Pelco or otherwise.

The above warranty provides the Dealer with specific legal rights. The Dealer may also have additional rights, which are subject to variation from state to state.

If a warranty repair is required, the Dealer must contact Pelco at (800) 289-9100 or (559) 292-1981 to obtain a Repair Authorization number (RA), and provide the following information:

1. Model and serial number
2. Date of shipment, P.O. number, Sales Order number, or Pelco invoice number
3. Details of the defect or problem

If there is a dispute regarding the warranty of a product which does not fall under the warranty conditions stated above, please include a written explanation with the product when returned.

Method of return shipment shall be the same or equal to the method by which the item was received by Pelco.

RETURNS

In order to expedite parts returned to the factory for repair or credit, please call the factory at (800) 289-9100 or (559) 292-1981 to obtain an authorization number (CA number if returned for credit, and RA number if returned for repair).

All merchandise returned for credit may be subject to a 20% restocking and refurbishing charge.

Goods returned for repair or credit should be clearly identified with the assigned CA or RA number and freight should be prepaid. Ship to the appropriate address below.

If you are located within the continental U.S., Alaska, Hawaii or Puerto Rico:

Service Department
Pelco
3500 Pelco Way
Clovis, CA 93612-5699

If you are located outside the continental U.S., Alaska, Hawaii or Puerto Rico:

Intermediate Consignee

American Overseas Air Freight
320 Beach Road
Burlingame, CA 94010
USA

Ultimate Consignee

Pelco
3500 Pelco Way
Clovis, CA 93612-5699
USA

© Pelco, the Pelco logo, Spectra, Genex, Legacy, Esprit, and Camclosure are registered trademarks of Pelco.
© Windows is a registered trademark of Microsoft Corporation.
© Copyright 2002, Pelco. All rights reserved.

REVISION HISTORY

Manual #	Date	Comments
C2900M	8/02	Original version.
C2900M-A	10/02	Revised Figure 13. Added notes about the View button and about viewing and controlling cameras on the spot and main monitors to the <i>Genex Live Video/Server Push Page Contents</i> section. Added note about the camera buttons to <i>Spectra Live Video/Server Push Page Contents</i> section. Added material about the reboot link on the Video Settings page.
C2900M-B	1/03	Revised Figures 38 and 42.

C2900M-B (1/03)

111



World Headquarters
3500 Pelco Way
Clovis, California 93612 USA

USA & Canada
Tel: 800/289-9100
Fax: 800/289-9150

International
Tel: 1-559/292-1981
Fax: 1-559/348-1120

www.pelco.com

ISO9001

Orangeburg, New York | Las Vegas, Nevada | Eindhoven, The Netherlands | Wokingham, United Kingdom | Montreal, Canada

Free Manuals Download Website

<http://myh66.com>

<http://usermanuals.us>

<http://www.somanuals.com>

<http://www.4manuals.cc>

<http://www.manual-lib.com>

<http://www.404manual.com>

<http://www.luxmanual.com>

<http://aubethermostatmanual.com>

Golf course search by state

<http://golfingnear.com>

Email search by domain

<http://emailbydomain.com>

Auto manuals search

<http://auto.somanuals.com>

TV manuals search

<http://tv.somanuals.com>