

INSTALLATION



FT8308/FR8308 Fiber Transmitter and Receiver



Eight-Channel Digitally Encoded Video

C1647M-A (6/06)

Contents

Important Safety Instructions	4
Regulatory Notices	6
Product Overview	7
Description	7
Models	8
Optional Accessories	8
Front Panel	9
Front Panel - FT8308 Transmitter	9
Front Panel - FR8308 Receiver	10
Rear Panel	11
Rear Panel - FT8308 Transmitter	11
Rear Panel - FR8308 Receiver	12
Installation	13
Package Contents	13
Mounting	13
Mounting the Transmitter/Receiver into a Rack	13
Mounting the Transmitter/Receiver to a Wall	14
Connections	16
Troubleshooting	17
Specifications	20

List of Illustrations

1	Eight-Channel Video FT8308 Transmitter and FR8308 Receiver	7
2	Front Panel of FT8308 Transmitter	9
3	Front Panel of FR8308 Receiver	10
4	Rear Panel of FT8308 Transmitter	11
5	Rear Panel of FR8308 Receiver	12
6	Mounting the FT8308 Transmitter/FR8308 Receiver Using the Wall Clip	15
7	FT8308 Transmitter/FR8308 Receiver Connections	16

List of Tables

A	Troubleshooting with Front-Panel Indicators	17
---	---	----

Important Safety Instructions

1. Read these instructions.
2. Keep these instructions.
3. Heed all warnings.
4. Follow all instructions.
5. Do not use this apparatus near water.
6. Clean only with dry cloth.
7. Do not block any ventilation openings. Install in accordance with the manufacturer's instructions.
8. Do not install near any heat sources such as radiators, heat registers, stoves, or other apparatus (including amplifiers) that produce heat.
9. Do not defeat the safety purpose of the polarized or grounding-type plug. A polarized plug has two blades with one wider than the other. A grounding type plug has two blades and a third grounding prong. The wide blade or the third prong are provided for your safety. If the provided plug does not fit into your outlet consult an electrician for replacement of the obsolete outlet.
10. Protect the power cord from being walked on or pinched particularly at plugs, convenience receptacles, and the points where they exit from the apparatus.
11. Only use attachments/accessories specified by the manufacturer.
12. Use only with the cart, stand, tripod, bracket, or table specified by the manufacturer, or sold with the apparatus. When a cart is used, use caution when moving the cart/apparatus combination to avoid injury from tip-over.
13. Refer all servicing to qualified service personnel. Servicing is required when the apparatus has been damaged in any way, such as power-supply cord or plug is damaged, liquid has been spilled or objects have fallen into the apparatus, the apparatus has been exposed to rain or moisture, does not operate normally, or has been dropped.
14. Apparatus shall not be exposed to dripping or splashing and that no objects filled with liquids, such as vases shall be placed on the apparatus.
15. **WARNING:** To reduce the risk of fire or electric shock, do not expose this apparatus to rain or moisture.
16. Installation should be done only by qualified personnel and conform to all local codes.
17. Use only installation methods and materials capable of supporting four times the maximum specified load.
18. A CCC-approved power cord must be used to power this equipment when used in China.
19. **CAUTION:** These servicing instructions are for use by qualified service personnel only. To reduce the risk of electric shock do not perform any servicing other than that contained in the operating instructions unless you are qualified to do so.

The product and/or manual may bear the following marks:



This symbol indicates that dangerous voltage constituting a risk of electric shock is present within this unit.



This symbol indicates that there are important operating and maintenance instructions in the literature accompanying this unit.

CAUTION:

RISK OF ELECTRIC SHOCK.
DO NOT OPEN.

Regulatory Notices

This device complies with Part 15 of the FCC Rules. Operation is subject to the following two conditions: (1) this device may not cause harmful interference, and (2) this device must accept any interference received, including interference that may cause undesired operation.

RADIO AND TELEVISION INTERFERENCE

This equipment has been tested and found to comply with the limits of a Class B digital device, pursuant to Part 15 of the FCC Rules. These limits are designed to provide reasonable protection against harmful interference in a residential installation. This equipment generates, uses, and can radiate radio frequency energy and, if not installed and used in accordance with the instructions, may cause harmful interference to radio communications. However there is no guarantee that the interference will not occur in a particular installation. If this equipment does cause harmful interference to radio or television reception, which can be determined by turning the equipment off and on, the user is encouraged to try to correct the interference by one or more of the following measures:

- Reorient or relocate the receiving antenna.
- Increase the separation between the equipment and the receiver.
- Connect the equipment into an outlet on a circuit different from that to which the receiver is connected.
- Consult the dealer or an experienced radio/TV technician for help.

You may also find helpful the following booklet, prepared by the FCC: "How to Identify and Resolve Radio-TV Interference Problems." This booklet is available from the U.S. Government Printing Office, Washington D.C. 20402.

Changes and Modifications not expressly approved by the manufacturer or registrant of this equipment can void your authority to operate this equipment under Federal Communications Commission's rules.

This Class B digital apparatus complies with Canadian ICES-003.

Cet appareil numérique de la classe B est conforme à la norme NMB-003 du Canada.

Product Overview

DESCRIPTION

The FT8308/FR8308 fiber transmitter and receiver provide the ability to transmit up to eight composite video channels over one optical fiber (refer to Figure 1).



Figure 1. Eight-Channel Video FT8308 Transmitter and FR8308 Receiver

Features of the FT8308/FR8308 fiber optic transmission system include the following:

- 8-bit digitally encoded video for high-quality multichannel video transmission over a single fiber
- Multimode fiber support for distances up to 1 km (0.6 mi)
- Single-mode fiber support for distances up to 30 km (18.6 mi)
- Exceeds all requirements for the RS-250C Medium-Haul Transmission specification
- Compatible with NTSC, PAL, and SECAM video standards
- Meets NEMA TS 2 and Caltrans traffic signal control equipment standards for ambient operating temperature, mechanical shock and vibration, humidity with condensation, high-line/low-line voltage conditions, and transient voltage protection

NOTE: Conformal coating is required for operation in environments with relative humidity above 95% (condensing).

- No performance adjustments required
- 12 VDC or 24 VAC power supply
- Stand-alone and rack-mountable modular design
- LED indicators for monitoring of signal status, laser status, and operating power

The FT8308 transmitter/FR8308 receiver is a Class 1 laser product that complies with FDA radiation performance standard 21CFR Subchapter J and with IEC 60825-1 Edition 1.2, 2001-08.

MODELS

The FT8308/FR8308 fiber transmitter and receiver consist of the following series of models:

Multimode Models:*

- FT8308MSTR Eight-channel fiber optic video transmitter; multimode, ST connector
- FR8308MSTR Eight-channel fiber optic video receiver; multimode, ST connector

Single-Mode Models:*

- FT8308SSTR Eight-channel fiber optic video transmitter; single-mode, ST connector
- FR8308SSTR Eight-channel fiber optic video receiver; single-mode, ST connector
- FT8308SFCR Eight-channel fiber optic video transmitter; single-mode, FC connector
- FR8308SFCR Eight-channel fiber optic video receiver; single-mode, FC connector

*For conformal coated models, replace the first letter *F* in the model number with the letter *C*.
The conformal coated version of FT8308MSTR, for example, is CT8308MSTR.

OPTIONAL ACCESSORIES

The following optional accessories are available:

- WM5002-3U Wall mount base kit for double-width module
- WM5002-3UEXP Wall mount expansion kit for double-width module
- RK5000-3U 19-inch rack mount chassis for 14 slots (no power), 3 RUs
- RK5000PS-3U 19-inch rack mount chassis for 12 slots with power, 3 RUs
- EPS5000-120 External rack power supply, 1 RU, dual 120 W power outputs
- RK5001B-3U Blank filler panel, single width
- RK5002B-3U Blank filler panel, double width
- RK5002-1UEXP Adapter kit that allows a 3 RU double-width fiber optic module to be used in RK5000PS-5U rack mount chassis

FRONT PANEL

The front panel of the FT8308 transmitter and the FR8308 receiver provides LED indicators that allow you to monitor signal status, laser status (transmitter only), and operating power. The following sections provide a view of the front panel of the FT8308 transmitter and the FR8308 receiver.

FRONT PANEL - FT8308 TRANSMITTER

Figure 2 illustrates the front panel of the FT8308 transmitter.

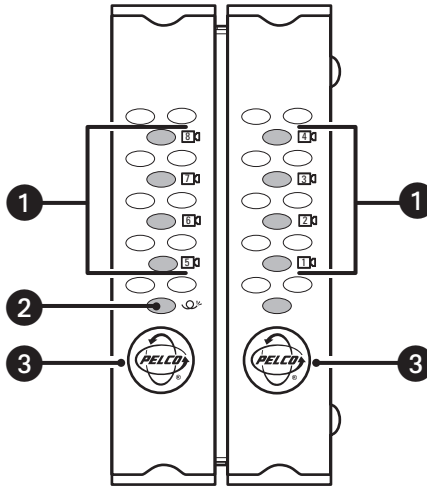

Figure 2. Front Panel of FT8308 Transmitter

- ❶ VIDEO PRESENT LEDs 1-8
- ❷ OPTIC FAULT LED, laser status indicator
- ❸ POWER LED (Pelco badge)

For detailed information about the front-panel indicators, refer to the *Troubleshooting* section.

FRONT PANEL - FR8308 RECEIVER

Figure 3 illustrates the front panel of the FR8308 receiver.

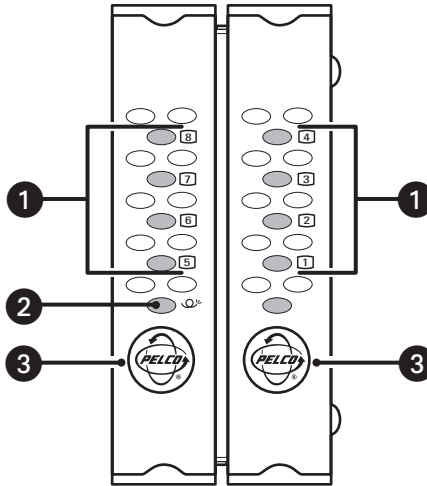

Figure 3. Front Panel of FR8308 Receiver

- ❶ VIDEO PRESENT LEDs 1-8
- ❷ OPTIC FAULT LED, optical signal status indicator
- ❸ POWER LED (Pelco badge)

For detailed information about the front-panel indicators, refer to the *Troubleshooting* section.

REAR PANEL

Connections to the FT8308 transmitter and the FR8308 receiver are made to the rear panel of the modules. The following sections provide a view of the rear panel of the FT8308 transmitter and the FR8308 receiver.

REAR PANEL - FT8308 TRANSMITTER

Figure 4 illustrates the rear panel of the FT8308 transmitter.

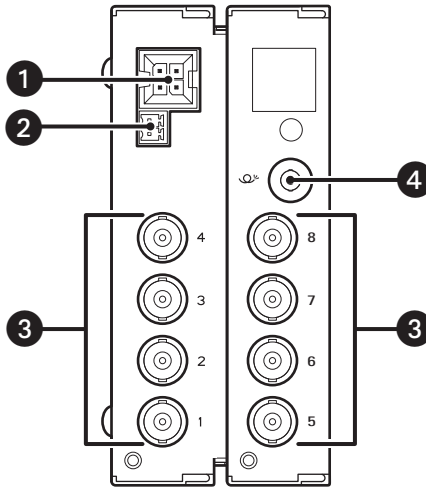

Figure 4. Rear Panel of FT8308 Transmitter

- ❶ RACK POWER/ALARM CONNECTOR, 4-pin connector for power/alarm connection of rack-mounted module
- ❷ STAND-ALONE POWER CONNECTOR, 2-pin connector for power connection of stand-alone module; removable mating connector with screw terminals (not shown)
- ❸ VIDEO IN CONNECTORS 1-8, 75-ohm BNC analog video input
- ❹ FIBER OPTIC CONNECTOR, ST or FC (dependent on FT8308 model)

For additional information about rear-panel connections, refer to the *Installation* section.

REAR PANEL - FR8308 RECEIVER

Figure 5 illustrates the rear panel of the FR8308 receiver.

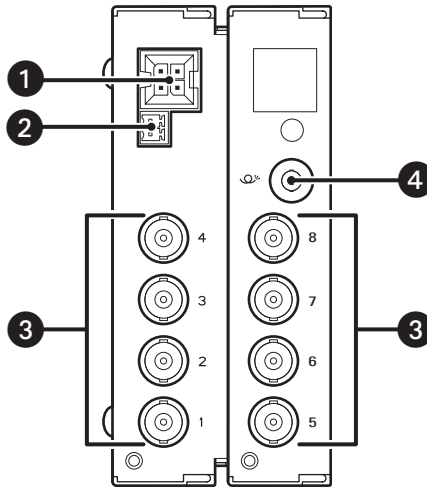

Figure 5. Rear Panel of FR8308 Receiver

- ❶ RACK POWER/ALARM CONNECTOR, 4-pin connector for power/alarm connection of rack-mounted module
- ❷ STAND-ALONE POWER CONNECTOR, 2-pin connector for power connection of stand-alone module; removable mating connector with screw terminals (not shown)
- ❸ VIDEO OUT CONNECTORS 1-8, 75-ohm BNC analog video output
- ❹ FIBER OPTIC CONNECTOR, ST or FC (dependent on FR8308 model)

For additional information about rear-panel connections, refer to the *Installation* section.

Installation

PACKAGE CONTENTS

The following items are supplied:

- 1 FT8308 transmitter or FR8308 receiver
- 1 Regulated switching power supply with four plug adapters (North American, Australian, U.K., and European configurations); 100-240 VAC, 50-60 Hz input, 12 VDC output
- 1 Wall clip with two 4-40 x 0.250-inch Phillips pan head screws with lock washers (for attachment of single module to wall)
- 1 FT8308/FR8308 Fiber Transmitter and Receiver Installation manual (this manual)

MOUNTING

The FT8308 transmitter/FR8308 receiver can be mounted into a rack or can be used as a stand-alone module. As a stand-alone module, the unit can be placed on a desktop or can be mounted to a wall.

MOUNTING THE TRANSMITTER/RECEIVER INTO A RACK

The FT8308 transmitter/FR8308 receiver can be installed into an RK5000 Series rack mount chassis, which can be mounted into an industry-standard 19-inch (48.26 cm) equipment rack. The RK5000 Series rack mount chassis includes the following models:

- **RK5000PS-3U and RK5000-3U:** Designed to accommodate fiber optic modules as follows:
 - The RK5000PS-3U rack mount chassis provides 12 single-width module slots and a power supply.
 - The RK5000-3U rack mount chassis provides 14 single-width module slots (a power supply is not included). Power to the modules can be supplied using the optional external power supply (EPS5000-120).

For additional information, refer to the RK5000PS-3U/RK5000-3U Fiber Rack Mount Chassis Installation manual.

- **RK5000PS-5U:** Designed to accommodate Endura™ modules but can also accommodate fiber optic modules with the use of the appropriate adapter kit. The RK5002-1UEXP adapter kit is required for installation of the FT8308 transmitter/FR8308 receiver into the RK5000PS-5U chassis.

For information about the RK5000PS-5U chassis, refer to the RK5000PS-5U Rack Mount Chassis Installation manual.

NOTE: The FT8308 transmitter/FR8308 receiver is a double-width fiber optic module that occupies two slots in the RK5000PS-3U, RK5000-3U, and RK5000PS-5U chassis.

MOUNTING THE TRANSMITTER/RECEIVER TO A WALL

The FT8308 transmitter/FR8308 receiver can be mounted to a wall in the following ways:

- Using the supplied wall clip for attachment of a single module to a wall. For installation instructions, refer to the *Mounting the Transmitter/Receiver Using the Wall Clip* section below.
- Using the optional WM5002 wall mount kits, which are designed for mounting of double-width fiber optic modules. The WM5002-3U base kit allows mounting of a single module to a wall. The WM5002-3UEXP expansion kit allows mounting of an additional module. It is recommended that a maximum of one expansion kit be used with the base kit, allowing a maximum of two double-width modules to be attached to a wall.

NOTE: The WM5002 wall mount kits can be used with the WM5001 wall mount kits, which are designed for mounting of single-width fiber optic modules. If mounting a mix of single-width and double-width modules is desired, it is recommended that a maximum of two single-width modules and one double-width module be mounted in combination with one another.

For mounting instructions using the wall mount kits, refer to the WM5000 Series Wall Mount Kit Installation manual.

Mounting the Transmitter/Receiver Using the Wall Clip

NOTE: Before mounting the FT8308 transmitter/FR8308 receiver to a wall, ensure that there is adequate space at both ends for viewing the front-panel LEDs and for making the various rear-panel cable connections.

To attach the FT8308 transmitter/FR8308 receiver to a wall using the supplied wall clip, refer to Figure 6 and do the following:

1. Using the two vertical or horizontal wall-mounting holes, attach the wall clip to a wall using two screws (not provided).
2. Slide the module into the clip until the two holes on the bottom of the module align with the two holes on the lower flange of the clip.
3. Attach the module to the clip using the two Phillips pan head screws provided for the clip.

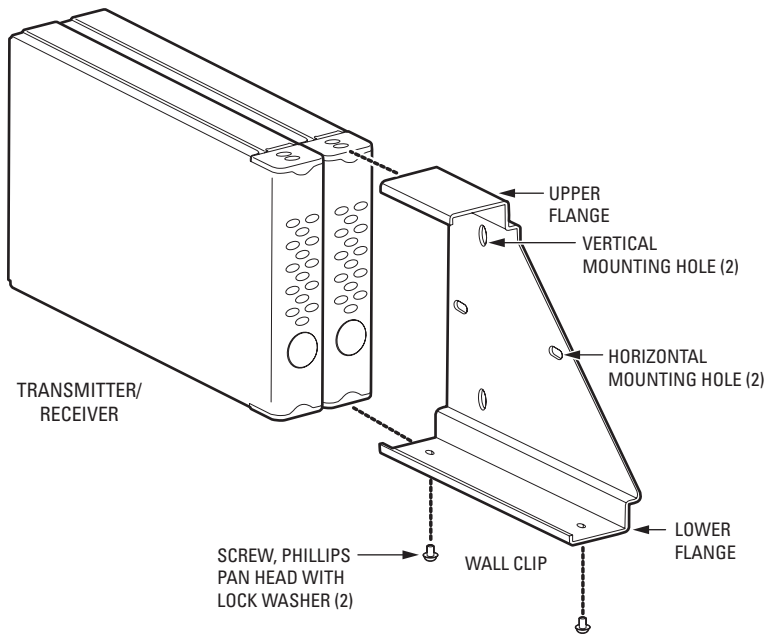

Figure 6. Mounting the FT8308 Transmitter/FR8308 Receiver Using the Wall Clip

CONNECTIONS

Connections to the FT8308 transmitter and the FR8308 receiver are made on the rear panel of the modules and consist of the following:

- Power connection

NOTES:

- A 12 VDC or 24 VAC power supply can be used to power the transmitter/receiver when used as a stand-alone module. A 12 VDC power supply is provided. If a 24 VAC power supply is used, the power supply must be a Listed Direct Plug-In Power Unit marked as Class 2 and rated as 24 VAC, 500 mA (minimum output).
- In extreme temperature conditions, it is recommended that an industrial-rated outdoor power supply such as the Pelco WCS1-4 power supply be used.

- Fiber connection
- Video input connections (transmitter only)
- Video output connections (receiver only)

Figure 7 provides an illustration of FT8308 transmitter/FR8308 receiver connections.

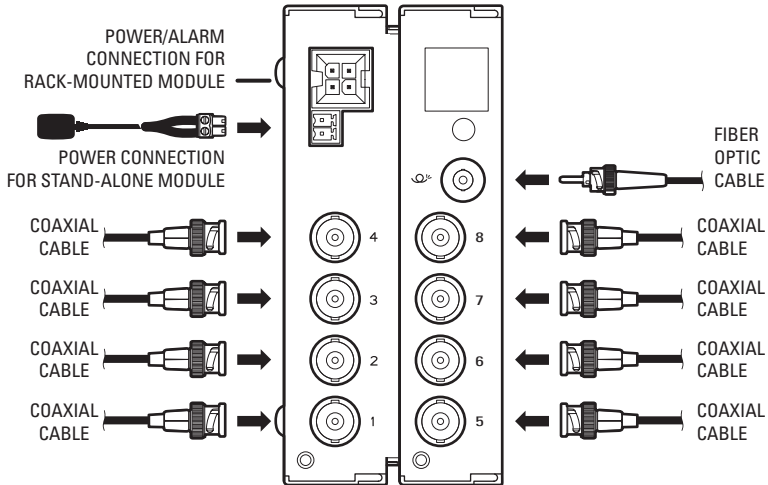

Figure 7. FT8308 Transmitter/FR8308 Receiver Connections

Troubleshooting

LED indicators on the front panel of the FT8308 transmitter/FR8308 receiver (refer to Figure 2 and to Figure 3, respectively) allow you to monitor signal status, laser status (transmitter only), and operating power. Table A provides information about the front-panel indicators and associated troubleshooting guidelines.

Table A. Troubleshooting with Front-Panel Indicators

Indicator Color	Meaning	Possible Cause	Corrective Action
Power LED (Pelco badge)			
Blue Pelco logo lights.	Power is being applied to the module.	—	No action required.
Blue Pelco logo does not light.	Power is not being applied to the module.	Power connection is faulty.	Check power connection. If module is rack mounted, reseal module or power supply as necessary.
		Power supply has failed.	Replace power supply.
		Loss of power occurs due to tripped circuit breakers, blown fuses, or faulty electrical service.	Check circuit breakers, fuses, or electrical service as necessary.
Video Present LED			
Green	Incoming video signal is present on the channel.	—	No action required.
Red on transmitter	Incoming video signal is not present on the channel.	Video source is not powered on.	Check power connection to the video source.
		Video source is not connected to the transmitter.	Check BNC connections.
		Coaxial cable is defective.	Replace cable.

(Continued on next page)

Table A. Troubleshooting with Front-Panel Indicators (Continued)

Indicator Color	Meaning	Possible Cause	Corrective Action
Video Present LED (Continued)			
Red on receiver	Incoming video signal is not present on the channel.	Optical signal is not being received from the transmitter. Optic Fault LED is also red.	Refer to the <i>Optic Fault LED - Receiver</i> section in this table.
		Video source is not powered on.	Check power connection to the video source.
		Video source is not connected to the transmitter.	Check BNC connections.
		Coaxial cable connected to the transmitter is defective.	Replace cable.
Optic Fault LED - Transmitter			
Green	Laser is operating properly.	–	No action required.
Flashing red	Laser has shut down.	Transmitter is operating in extreme environmental conditions; for example, operating temperature is below or above recommended range as stated in the <i>Specifications</i> section.	Ensure that transmitter operates according to operating conditions stated in the <i>Specifications</i> section, and then cycle the power. If problem persists, contact Product Support.
		Laser has reached end of life.	Cycle the power. If problem persists, contact Product Support.

(Continued on next page)

Table A. Troubleshooting with Front-Panel Indicators (Continued)

Indicator Color	Meaning	Possible Cause	Corrective Action
Optic Fault LED - Receiver			
Green	The optical signal is being received from the transmitter.	—	No action required.
Red	The optical signal is not being received from the transmitter.	Transmitter is not powered on.	Check power connections. Replace power supply if necessary.
		Fiber optic cable is not connected.	Check fiber optic connections.
		Fiber optic cable connectors are dirty or are damaged.	Clean, polish, or replace fiber optic cable connectors as necessary.
		Fiber optic cable is defective.	Replace cable.
		Optical dB losses in the fiber optic installation exceed the optical power budget specification stated in the <i>Specifications</i> section.	Check for problems with the fiber optic installation, for example, excessive dB losses in connectors, splices, patch panels, cables, and so on.
		Optical dB losses in the fiber optic installation meet the optical power budget specification stated in the <i>Specifications</i> section; however, the receiver may be defective.	Contact Product Support.

Specifications

VIDEO

Number of Channels	8
Modulation Type	Pulse code modulation, 8-bit resolution
Video Input (FR8308)/ Video Output (FR8308)	1.0 Vp-p, 75 ohms; NTSC, PAL, and SECAM
Bandwidth	6.5 MHz
Gain	Unity
Crosstalk	-50 dB typical at 3.58 MHz
Differential Gain	<1%
Differential Phase	<1.2°
Tilt	<1%
Signal-to-Noise Ratio	>60 dB (CCIR weighted)

GENERAL

Operating Temperature	-40° to 167°F (-40° to 75°C)
Input Power Requirements	12 VDC or 24 VAC, 460 mA
LED Indicators	Video Present (per channel) Optic Fault Power
Dimensions	8.75" D x 2.28" W x 4.81" H (22.23 x 5.79 x 12.22 cm)
Unit Weight	2.64 lb (1.20 kg)

MECHANICAL

Connectors	
Video	BNC (per channel)
Rack Power/Alarm	4-pin connector
Stand-Alone Power	2-pin connector, screw terminal
Fiber Optic	ST for multimode fiber ST or FC for single-mode fiber

OPTICAL POWER BUDGET, TRANSMISSION DISTANCE, AND LASER CLASS 1 LIMIT

Model No.		Wavelength	Optical Power Budget	Maximum Transmission Distance	Laser Class 1 Limit*
Transmitter	Compatible Receiver				
Multimode (62.5/125 μm)					
FT8308MSTR	FR8308MSTR	1310 nm	20 dB [†]	1 km (0.6 mi) [‡]	<15.6 mW
Single-Mode (9/125 μm)					
FT8308SSSTR	FR8308SSSTR	1310 nm	20 dB	30 km (18.6 mi) [§]	<15.6 mW
FT8308SFCR	FR8308SFCR	1310 nm	20 dB	30 km (18.6 mi) [§]	<15.6 mW
<p>* The FT8308 transmitter and the FR8308 receiver are classified by the FDA as Class 1 laser products.</p> <p>[†] When using 50/125 μm multimode fiber, subtract 3 dB from the optical power budget.</p> <p>[‡] Maximum transmission distance is limited by fiber bandwidth.</p> <p>[§] Maximum transmission distance is based on attenuation of 0.5 dB/km plus a 5 dB buffer for connector and splice losses.</p> <p>NOTES:</p> <ul style="list-style-type: none"> • For conformal coated models, replace the first letter <i>F</i> in the model number with the letter <i>C</i>. The conformal coated version of FT8308MSTR, for example, is CT8308MSTR. • For models with higher optical power budgets, contact the factory. 					

 **Green** The materials used in the manufacture of this document and its components are compliant to the requirements of Directive 2002/95/EC.



This equipment contains electrical or electronic components that must be recycled properly to comply with Directive 2002/96/EC of the European Union regarding the disposal of waste electrical and electronic equipment (WEEE). Contact your local dealer for procedures for recycling this equipment.

PRODUCT WARRANTY AND RETURN INFORMATION

WARRANTY

Pelco will repair or replace, without charge, any merchandise proved defective in material or workmanship **for a period of one year** after the date of shipment.

Exceptions to this warranty are as noted below:

- Five years on FR/FT/FS Series fiber optic products and TW3000 Series unshielded twisted pair transmission products.
- Three years on Genex® Series products (multiplexers, server, and keyboard).
- Three years on Camclosure® and fixed camera models, except the CC3701H-2, CC3701H-2X, CC3751H-2, CC3651H-2X, MC3651H-2, and MC3651H-2X camera models, which have a five-year warranty.
- Three years on PMCL200/300/400 Series LCD monitors.
- Two years on standard motorized or fixed focal length lenses.
- Two years on Legacy®, CM6700/CM6800/CM9700 Series matrix, and DF5/DF8 Series fixed dome products.
- Two years on Spectra®, Esprit®, ExSite™, and PS20 scanners, including when used in continuous motion applications.
- Two years on Esprit® and WW5700 Series window wiper (excluding wiper blades).
- Two years (except lamp and color wheel) on Digital Light Processing (DLP®) displays. The lamp and color wheel will be covered for a period of 90 days. The air filter is not covered under warranty.
- Eighteen months on DX Series digital video recorders, NVR300 Series network video recorders, and Endura™ Series distributed network-based video products.
- One year (except video heads) on video cassette recorders (VCRs). Video heads will be covered for a period of six months.
- Six months on all pan and tilts, scanners or preset lenses used in continuous motion applications (that is, preset scan, tour and auto scan modes).

Pelco will warrant all replacement parts and repairs for 90 days from the date of Pelco shipment. All goods requiring warranty repair shall be sent freight prepaid to Pelco, Clovis, California. Repairs made necessary by reason of misuse, alteration, normal wear, or accident are not covered under this warranty.

Pelco assumes no risk and shall be subject to no liability for damages or loss resulting from the specific use or application made of the Products. Pelco's liability for any claim, whether based on breach of contract, negligence, infringement of any rights of any party or product liability, relating to the Products shall not exceed the price paid by the Dealer to Pelco for such Products. In no event will Pelco be liable for any special, incidental or consequential damages (including loss of use, loss of profit and claims of third parties) however caused, whether by the negligence of Pelco or otherwise.

The above warranty provides the Dealer with specific legal rights. The Dealer may also have additional rights, which are subject to variation from state to state.

If a warranty repair is required, the Dealer must contact Pelco at (800) 289-9100 or (559) 292-1981 to obtain a Repair Authorization number (RA), and provide the following information:

1. Model and serial number
2. Date of shipment, P.O. number, Sales Order number, or Pelco invoice number
3. Details of the defect or problem

If there is a dispute regarding the warranty of a product which does not fall under the warranty conditions stated above, please include a written explanation with the product when returned.

Method of return shipment shall be the same or equal to the method by which the item was received by Pelco.

RETURNS

In order to expedite parts returned to the factory for repair or credit, please call the factory at (800) 289-9100 or (559) 292-1981 to obtain an authorization number (CA number if returned for credit, and RA number if returned for repair).

All merchandise returned for credit may be subject to a 20% restocking and refurbishing charge.

Goods returned for repair or credit should be clearly identified with the assigned CA or RA number and freight should be prepaid. Ship to the appropriate address below.

If you are located within the continental U.S., Alaska, Hawaii or Puerto Rico, send goods to:

Service Department
Pelco
3500 Pelco Way
Clovis, CA 93612-5699

If you are located outside the continental U.S., Alaska, Hawaii or Puerto Rico and are instructed to return goods to the USA, you may do one of the following:

If the goods are to be sent by a COURIER SERVICE, send the goods to:

Pelco
3500 Pelco Way
Clovis, CA 93612-5699 USA

If the goods are to be sent by a FREIGHT FORWARDER, send the goods to:

Pelco c/o Expeditors
473 Eccles Avenue
South San Francisco, CA 94080 USA
Phone: 650-737-1700
Fax: 650-737-0933

REVISION HISTORY

Manual #	Date	Comments
C1647M	3/05	Original version.
C1647M-A	6/06	Added conformal coating and Optic Fault LED laser status information (ECO 06-14132). Updated regulatory notices, power supply recommendations, and product specifications.

Pelco, the Pelco logo, Camclosure, Esprit, Genex, Legacy, and Spectra are registered trademarks of Pelco.
Endura and ExSite are trademarks of Pelco.
DLP is a registered trademark of Texas Instruments, Inc.

©Copyright 2006, Pelco.
All rights reserved.



Worldwide Headquarters
3500 Pelco Way
Clovis, California 93612 USA

USA & Canada
Tel: 800/289-9100
Fax: 800/289-9150
International
Tel: 1-559/292-1981
Fax: 1-559/348-1120

www.pelco.com

ISO9001

United States | Canada | United Kingdom | The Netherlands | Singapore | Spain | Scandinavia | France | Middle East

Free Manuals Download Website

<http://myh66.com>

<http://usermanuals.us>

<http://www.somanuals.com>

<http://www.4manuals.cc>

<http://www.manual-lib.com>

<http://www.404manual.com>

<http://www.luxmanual.com>

<http://aubethermostatmanual.com>

Golf course search by state

<http://golfingnear.com>

Email search by domain

<http://emailbydomain.com>

Auto manuals search

<http://auto.somanuals.com>

TV manuals search

<http://tv.somanuals.com>