

**System 9760[®]
CM9760-HS
Hot Switch**

**Installation/
Operation Manual**

C578M-A (4/05)

Pelco • 3500 Pelco Way • Clovis, CA 93612-5699 USA • www.pelco.com
USA and Canada: Tel (800) 289-9100 • FAX (800) 289-9150
International Customers: Tel +1(559) 292-1981 • FAX +1(559) 348-1120

CONTENTS

SECTION 1.0: INTRODUCTION

1.1 HS DEFINED	6
1.2 CC1 CONNECTION GROUPS	7
1.3 HS HARDWARE THUMBNAIL	8
1.4 SUBUNIT HIGHLIGHTS	8
THE CCC (COMPUTER CHANGEOVER CONTROL)	9
THE CPS (COMPUTER PERIPHERAL SWITCH)	10
THE SEU (SERIAL EXPANSION UNIT)	12
MASTER/SLAVE STATUS FOR CC1	13
1.5 INSTALLATION PREVIEW	14
OTHER REMARKS:	14
INSTALLATION CHECKLIST:	14

SECTION 2.0: INSTALLATION

2.1 PHYSICAL	16
9700-CC1 TO CCC (CONTROL GROUP)	16
9700-CC1 TO CPS (DIAGNOSTIC GROUP)	17
9700-CC1 TO SEU (EXPANSION GROUP)	18
DIP SWITCH SETTINGS	19
2.2 POWER-UP AND INITIALIZATION	20

SECTION 3.0: OPERATION

3.1 PRELIMINARY REMARKS	21
3.2 TERMS AND DEFINITIONS	21
3.3 OPERATOR TOOLS	22
LEDS	22
FRONT PANEL BUTTONS	23
3.4 OPERATOR RESPONSES AND METHODS	25
SYSTEM FAULTS	25
DIAGNOSTIC MONITOR AND SYSTEM WINDOW USE	26
SYSTEM UPDATE PROCEDURE	29

SECTION 4.0: APPENDICES

INTRODUCTORY REMARKS	31
APPENDIX 4.1 HS ADDITION TO AN EXISTING CONFIGURATION (No Hot Switch Currently Installed)	31
APPENDIX 4.2 HS UPDATE (PREVIOUS MODEL OF HOT SWITCH INSTALLED)	32
APPENDIX 4.3 HS UPDATE (CURRENT MODEL HOT SWITCH INSTALLED)	33
APPENDIX 4.4 HS AND NETWORK-INTERFACED CONFIGURATIONS	34
APPENDIX 4.5 DATA CABLE PARAMETERS	36

SECTION 5.0: GENERAL

5.1 SPECIFICATIONS	40
5.2 SEU CONNECTION TEMPLATE	42

LIST OF ILLUSTRATIONS

SECTION 1.0: INTRODUCTION

1-1. HS Block Diagram	6
1-2. CC1 Connection Groups	7
1-3. HS Rear Views and CCC Subunit Front Panel	8
1-4. Data Cable Identification	9
1-5. Data Cable Wiring	9
1-6. COM 2 Port Options	11
1-7. SEU Port Relationships	12
1-8. Port Connection Mnemonic	13
1-9. RJ-45 Pin Detail	13
1-10. SEU Master/Slave Wiring Diagram	13
1-11. Basic Hookup, Wire Routes	15

SECTION 2.0: INSTALLATION

2-1. Data Cable Wiring Detail	
2-2. Diagnostic Group, Cabling Detail	17
2-3. External Expansion Cabling Detail	18
2-4. DIP Switch Configuration	19
2-5. Initialization Status, Default	20

SECTION 3.0: OPERATION

3-1. System Window Online Status	26
--	----

SECTION 4.0: APPENDICES

A4-1. Hot Switch Comparison Summary	32
A4-2. HS-NIU Connections	34
A4-3. Hot Switch Interfaced NIU	35
A4-4. Data Rate vs. Cable Length	36
A4-5. Keyboard (Local Hookup)	37
A4-6. Remote Wiring a CM9760-KBD	38

SECTION 5.0: GENERAL

5-1. CM9760-HS Dimension Drawing	41
--	----

LIST OF TABLES

SECTION 3.0: OPERATION

A LED Activity	23
B Front Panel Button Operation	24
C System FAULT Response	25
D Diagnostic Displays	27
E System Update of Hardware/Software, Starting from Default Mode	29

SECTION 4.0: APPENDICES

Table A4-A. (TIA/EIA-422*) Cable Example	39
--	----

(This page intentionally left blank.)

IMPORTANT SAFEGUARDS AND WARNINGS

Prior to installation and use of this product, the following WARNINGS should be observed.

1. Installation and servicing should only be done by qualified service personnel and conform to all local codes.
2. Unless the unit is specifically marked as a NEMA Type 3, 3R, 3S, 4, 4X, 6, or 6P enclosure, it is designed for indoor use only and it must not be installed where exposed to rain and moisture.
3. The installation method and materials should be capable of supporting four times the weight of the unit and equipment.
4. Only use replacement parts recommended by Pelco.
5. After replacement/repair of this unit's electrical components, conduct a resistance measurement between line and exposed parts to verify the exposed parts have not been connected to line circuitry.
6. If the unit has fuses, replace fuses only with the same type fuses for continued protection against risk of fire.

The product and/or manual may bear the following marks:



This symbol indicates that dangerous voltage constituting a risk of electric shock is present within this unit.



This symbol indicates that there are important operating and maintenance instructions in the literature accompanying this unit.

CAUTION:

RISK OF ELECTRIC SHOCK. DO NOT OPEN.

Please thoroughly familiarize yourself with the information in this manual prior to installation and operation.

REGULATORY NOTICES

This device complies with Part 15 of the FCC Rules. Operation is subject to the following two conditions: (1) this device may not cause harmful interference, and (2) this device must accept any interference received, including interference that may cause undesired operation.

RADIO AND TELEVISION INTERFERENCE

This equipment has been tested and found to comply with the limits of a Class B digital device, pursuant to Part 15 of the FCC Rules. These limits are designed to provide reasonable protection against harmful interference in a residential installation. This equipment generates, uses, and can radiate radio frequency energy and, if not installed and used in accordance with the instructions, may cause harmful interference to radio communications. However there is no guarantee that the interference will not occur in a particular installation. If this equipment does cause harmful interference to radio or television reception, which can be determined by turning the equipment off and on, the user is encouraged to try to correct the interference by one or more of the following measures:

- Reorient or relocate the receiving antenna.
- Increase the separation between the equipment and the receiver.
- Connect the equipment into an outlet on a circuit different from that to which the receiver is connected.
- Consult the dealer or an experienced radio/TV technician for help.

You may also find helpful the following booklet, prepared by the FCC: "How to Identify and Resolve Radio-TV Interference Problems." This booklet is available from the U.S. Government Printing Office, Washington D.C. 20402.

Changes and modifications not expressly approved by the manufacturer or registrant of this equipment can void your authority to operate this equipment under Federal Communications Commission's rules.

This Class B digital apparatus complies with Canadian ICES-003.

Cet appareil numérique de la classe B est conforme à la norme NMB-003 du Canada.

9760 HS COMMUNICATIONS PARAMETERS	
CC1 to HS Interface:	
(Comm Parameters)	
Equipment #	16
Baud Rate	9600
Parity	EVEN
NIU to HS Interface:	
(Comm Parameters)	
Equipment #	41
Baud Rate	9600
Parity	EVEN

20052

NOTE: For those familiar with device attachment to 9700 Systems, a convenient reference box is provided in the left margin that lists the communication parameters for hot-switch-interfaced nodes (CC1 to HS), and for hot-switch-interfaced NIUs (NIU to HS). Refer to Appendix 4.4, HS and Networked Interfaced Configurations, for more information.

IMPORTANT NOTE: Users upgrading from previous hot switch models should consult Appendix 4.2 HS Update (Previous Model of Hot Switch Installed), where important differences between previous and current models are highlighted.

SECTION 1.0: INTRODUCTION

1.1 HS DEFINED

The CM9760-HS (Hot Switch) provides single-node, switching control between two CM9700-CC1 matrix switches. The default HS package consists of three subunits*, interconnected via in out, DB37, male-to-male, molded cables that form a common bus for the subunits. These units provide the interfaced system with operational redundancy.

Failure of the controlling matrix switch (designated the Master) passes control to the backup (designated the Slave). Conversely, if the Slave unit fails, control remains with the Master unit. Any system failure generates a system error that lights the FAULT LED (visual), and turns on an accompanying audible tone. The audible signal is automatic unless turned off by DIP switch 1-1 (see Figure 2-4, DIP Switch Configuration). Figure 1-1 depicts the basic physical relationship between the HS, the interfaced CC1s, and the external devices connected to the CPS and SEU output ports.

* The Serial Expansion Unit (SEU) is one of these units. However, it varies in number from one (default), up to a possible eight units, depending on system configuration. Additional SEU units are physically added to the hot switch via the HS common bus. Two SEU units are needed to interface a fully populated CC1 (four Sercom cards containing a total of 32 ports). Future development may require more than 32 Sercom ports to be interfaced. When that happens, SEU units (up to eight total) can be added to the common bus to accommodate the increase in Sercom port population.

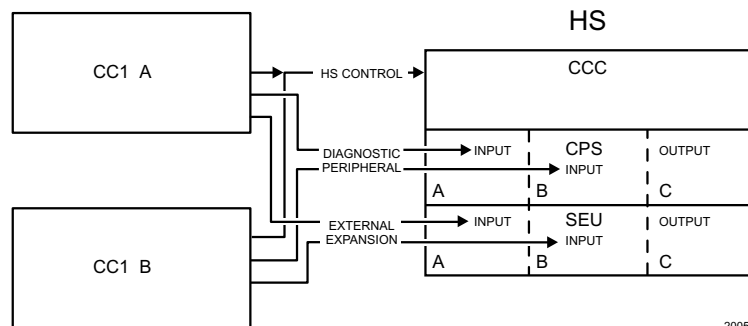

Figure 1-1. HS Block Diagram

Diagnostic equipment connected to CPS output ports display the status of HS health. Other devices, connected to SEU output ports are under CC1 A or CC1 B control. For this reason, the interfaced matrix switches must be hardware-software clones of each other in order for either to control the same set of devices and to ensure a smooth transfer if a control transition (changeover) occurs.

Matrix switch equality is assured in the following manner:

- Both switches must physically interface the HS in the same way. All cables and connections on the A-side, switch-to-HS interface, are duplicated on the B-side. Basic interface requirements are discussed in installation subsection 2.1 *Physical*. Additional installation issues, beyond basic setup, are discussed in *Section 4.0 Appendices*.
- The physical equivalence of the matrix switches is likewise mirrored in their respective software configuration file sets (Comms, Monitor, Camera, etc.) that are used to initialize and operate each switch. Both sets must be identical.

Refer to the CM9700-MGR Getting Started Software Guide, on-screen help, or Online Help for information about programming configuration files.

1.2 CC1 CONNECTION GROUPS

The rear view of a matrix switch (referenced in the block diagram of Figure 1-1) is shown in Figure 1-2. Outputs destined for HS connections can be categorized, corresponding to the designated functions of the subunits to which they are attached on the hot switch. For discussion purposes, these outputs are partitioned into three groups: the Control group, the Diagnostic-Peripheral group and the External Expansion group.

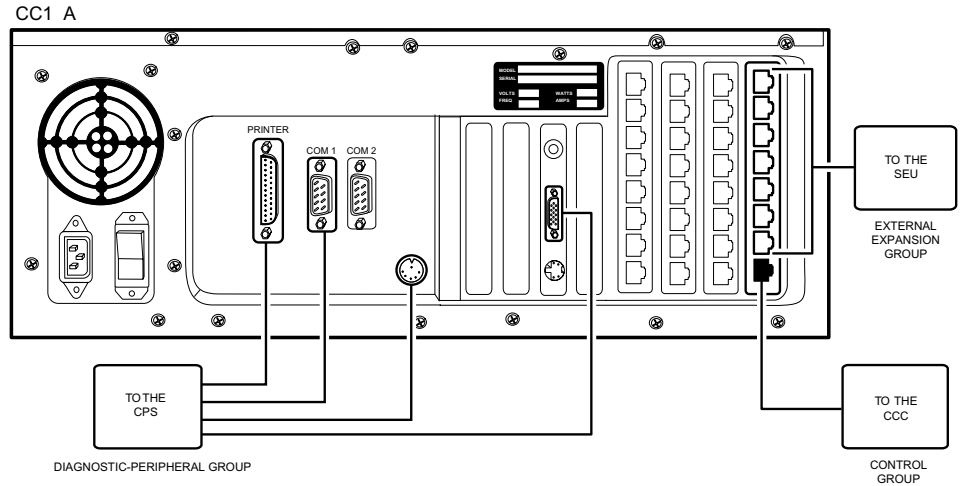

Figure 1-2. CC1 Connection Groups

20058

1.3 HS HARDWARE THUMBNAIL

Figure 1-3 expands the HS portion of Figure 1-1 to illustrate an uncluttered, thumbnail rear view of the hot switch subunits that comprise a default HS configuration. Connection cable destinations from each CC1 (matrix switch), referenced in the previous figure, are attached to the appropriate side (CC1 'A' or CC1 'B') of the hot switch subunits. The subunit acronyms have the following meanings: the CCC (Computer Changeover Control), the CPS (Computer Peripheral Switch) and the SEU (Serial Expansion Unit).

Note that the CCC front panel is included in this illustration. Operation buttons for the user are located there. Also shown is the 37-pin, D-type, molded cable, used to create common bus connectivity between the subunits. (Except for the CPS, one DB37 cable is supplied with each subunit). Front panels for the CPS and SEU are similar to that shown for the CCC (minus the operation buttons), with labeling appropriate to each unit.

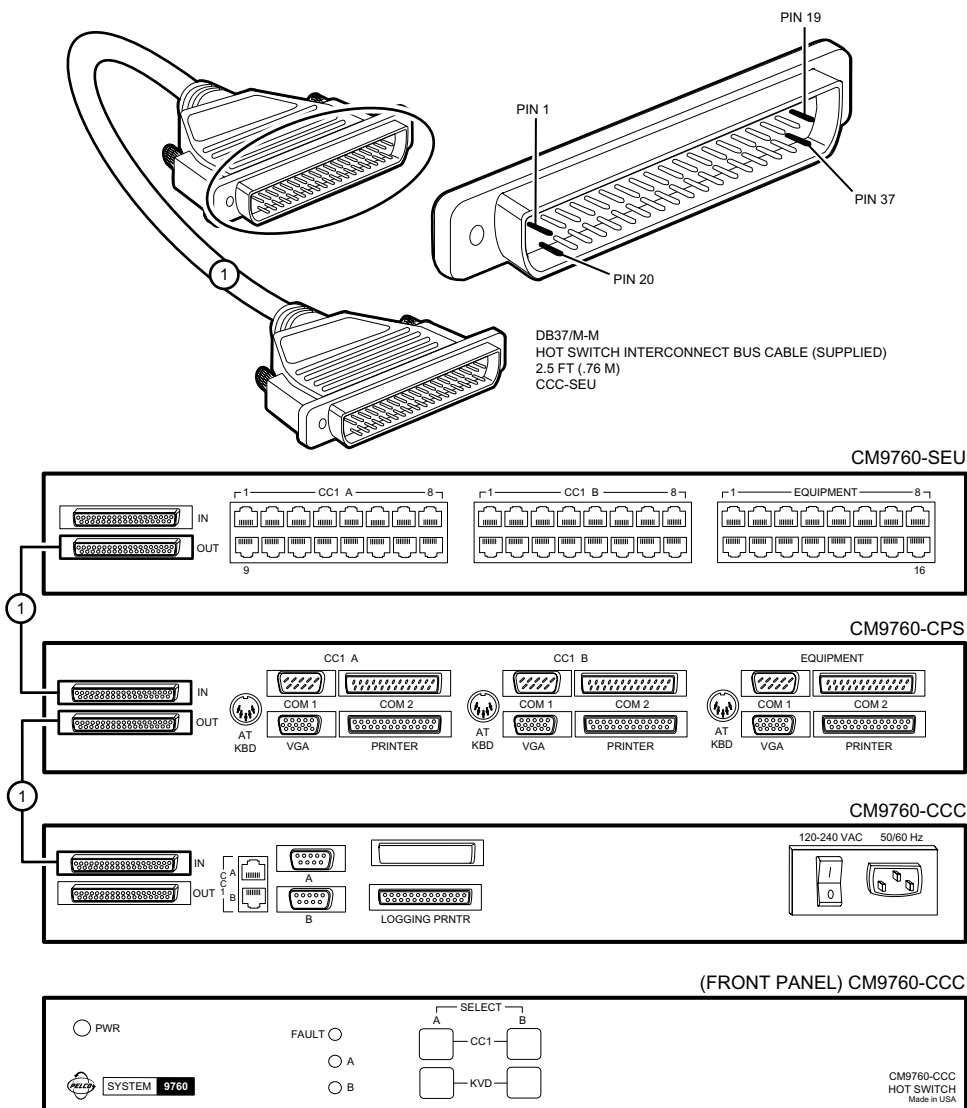
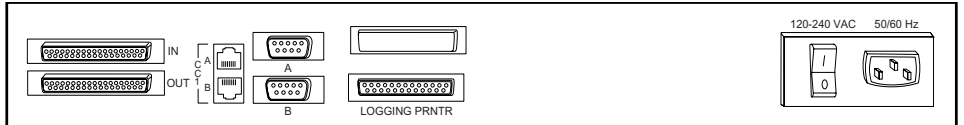

Figure 1-3. HS Rear Views and CCC Subunit Front Panel

1.4 SUBUNIT HIGHLIGHTS

The main characteristics and functions of each subunit of the HS are discussed in the following paragraphs. Important points that need to be understood for a successful installation are discussed.

THE CCC (Computer Changeover Control)



20053

NOTE: When upgrading to the current hot switch from a previous model, note the following. The data cable, previously used to connect RJ-45 port 5 on each switch and the corresponding COM 1 [S1] and COM 2 [S2] ports on the hot switch, cannot be substituted here.

The CCC subunit is the heart of the hot switch. Data connections between the interfaced CC1s (matrix switches) and the HS are located here. Two connector types that correspond to two communication types for the data line to the CCC are provided: RJ-45 or DB9. You can use either, but the connector type chosen determines the communication protocol you must use and vice versa. Both are illustrated in Figure 1-5. In the top portion of Figure 1-5, the RJ-45 data line connection (one from each switch) is shown. If RS-422 communication is chosen, the data cable from a port on matrix switch CC1 'A' (an RJ-45 Sercom port, usually port 5) is run to the RJ-45 CC1 A port on the CCC. A similar cable is run from CC1 'B' to the RJ-45 CC1 B port on the same CCC. These cables are reversed or "flipped" and utilize pins 1, 2, 7, and 8 as depicted in Figure 1-4. Alternately, in the bottom portion of Figure 1-11, the RS-232 data line connection is shown. A DB9 cable is run from either the COM 1 or COM 2 port (on the respective CC1 'A' or CC1 'B' switch) to the appropriate (CC1 A or B) DB9 port on the CCC. The cables for the DB9 data connection runs are not supplied. Pelco recommends that RS-422 communication be used whenever possible. The cables for the RS-422 data connections are provided.

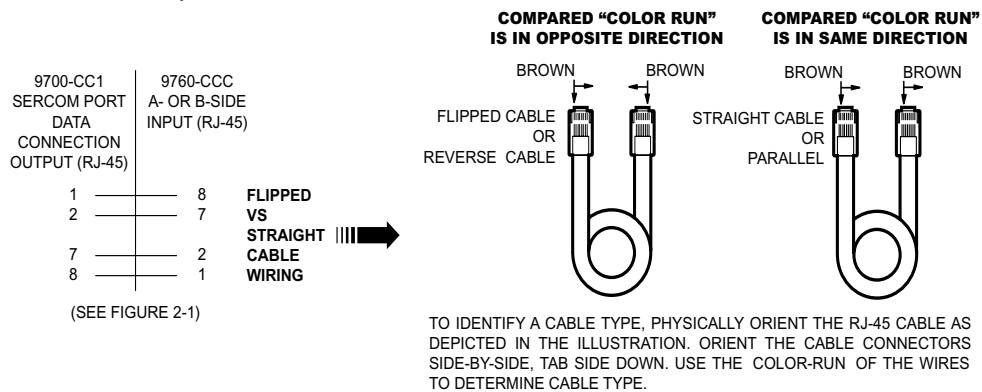

Figure 1-4. Data Cable Identification

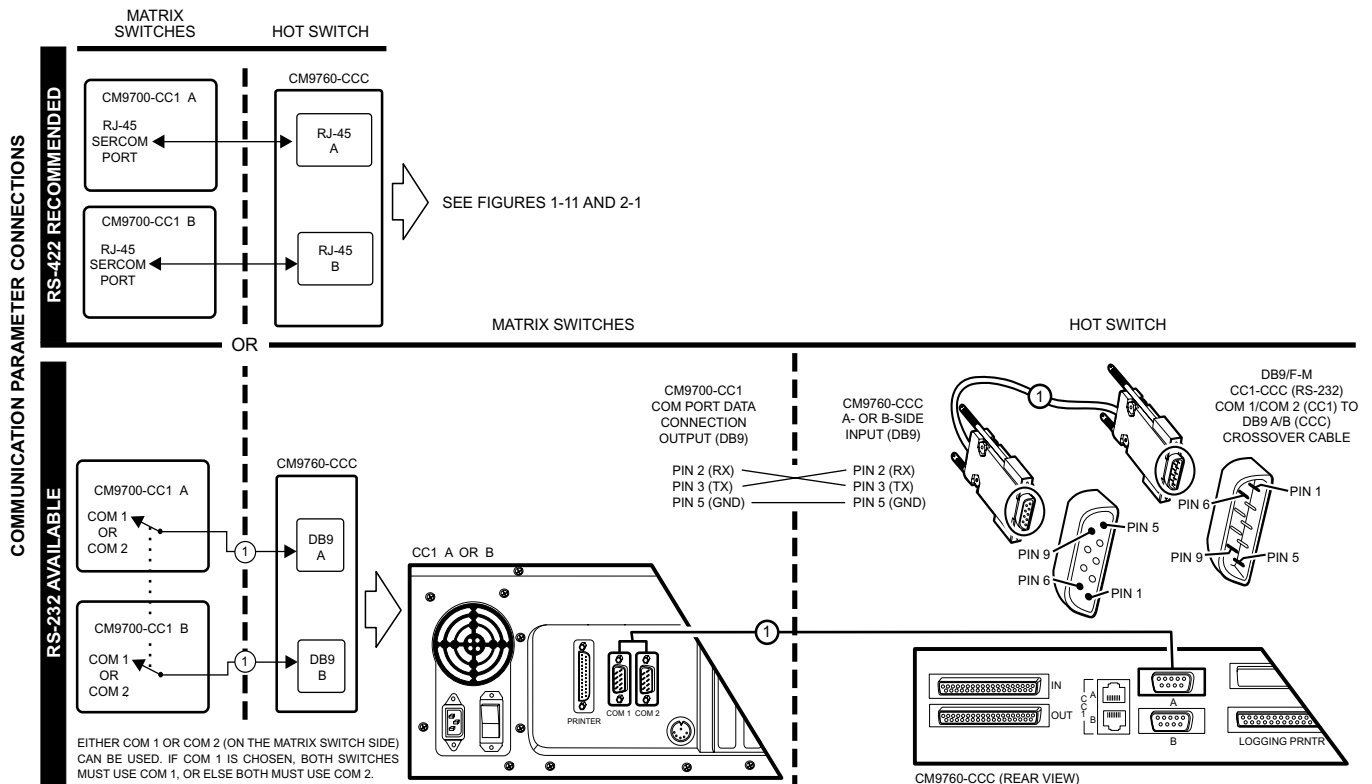

Figure 1-5. Data Cable Wiring

In addition to communications, there are number of additional functions handled by the CM9760-CCC.

POWER The power-input connector, fuse, and ON/OFF switch are located here. Input power for the entire HS originates here. Power is distributed to the CPS and SEU subunits via DB37 common bus connections.

LOGGING
PRINTER PORT This is used, if desired, as an output logging device for system or status reports related to hot switch operation only. The port supports dot matrix printers capable of IBM or Epson emulation modes, such as the Okidata 320 (non-turbo) and the Okidata 390 (turbo) or 391 (turbo).

LEDs The FAULT, A, and B LEDs are located on the front panel of the unit. These give visual indications of system status with respect to control, mode of operation, and system failure. See the *LEDs* section of 3.3 *Operator Tools*.

FRONT PANEL
BUTTONS The front panel buttons are utilized by the operator for responding to system errors, for checking system status, and for operational control when changes are made to system hardware and/or software. See the *Front Panel Buttons* section of 3.3 *Operator Tools*.

THE CPS (Computer Peripheral Switch)

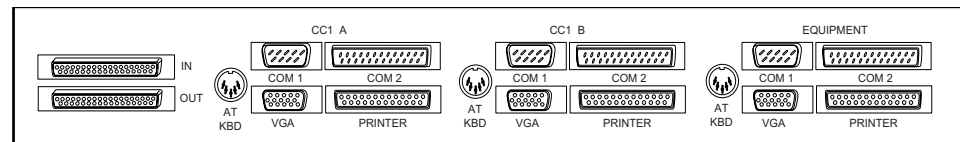

The connectors on the rear of the CPS are divided into three duplicate sections. Each section contains

an AT KBD connector,
a VGA connector,
a PRINTER connector,
a COM 1 connector (port), and
a COM 2 connector (port).

Each duplicate section is labeled. From left to right, they are the CC1 'A' section, the CC1 'B' section, and the EQUIPMENT section. The first two (CC1 'A' and CC1 'B') are connection input destinations for the corresponding switch it interfaces—one from the A-side, and one from the B-side switch. The third section (EQUIPMENT) provides the connectors to which the following standard diagnostic devices can be attached:

1. An AT keyboard (to the AT KBD connector)
2. A VGA monitor (to the VGA connector)
3. A system printer (to the PRINTER connector)
4. A PC W/Pelco MGR software (to the COM 1 port)

As a user, you are always connected (through either one matrix switch or the other) to the diagnostic tools that are attached to the EQUIPMENT output ports. The switch through which you operate (the one in control and designated the Master) is normally granted automatic access to those devices (default). If control is switched, the backup switch (Slave) becomes the designated Master, roles are reversed, and the output diagnostic connections change to follow suit. This happens automatically if DIP switch 1-2 is ON and DIP 1-6 is OFF (default). See Figure 2-4, DIP Switch Configuration.

Note that only four diagnostic devices are listed for the five available output ports. Two of the five output ports deserve further comment.

COM 1 is reserved for the connection of the PC with MGR software (see Figure 1-11).

COM 2 can be used in two ways:

1. As a "user" defined configuration for the connection of devices and/or electronic equipment to the COM 2 A and B inputs and to the COM 2 EQUIPMENT output port. The COM 2 ports are D-type, 25-pin connectors, and can be used for the connection of user-optional equipment. Applied voltages to COM 2 connector pins should not exceed 25 VDC. For this use, the operation of the COM 2 port is not necessary for the successful operation of any function of the HS. Insert A of Figure 1-6 is a diagrammatic drawing of the wiring of the COM 2 connectors.
2. For the connection (to the EQUIPMENT section's COM 2 output port) of an RS-232, DT (Data Translator). As part of the CPS package, three DB25 (female) to DB9 (male) adapters are provided for this purpose (along with the associated cabling for the A- and B-side inputs to these adapters).

This allows users with existing RS-232 DT devices to retain that configuration capability in the new HS. Figure 1-6 highlights the geometry of this hookup.

Additional DTs of the same type must be connected to CC1 Sercom ports (via SEU output ports of the HS) and require RS-232 to -422 converters.

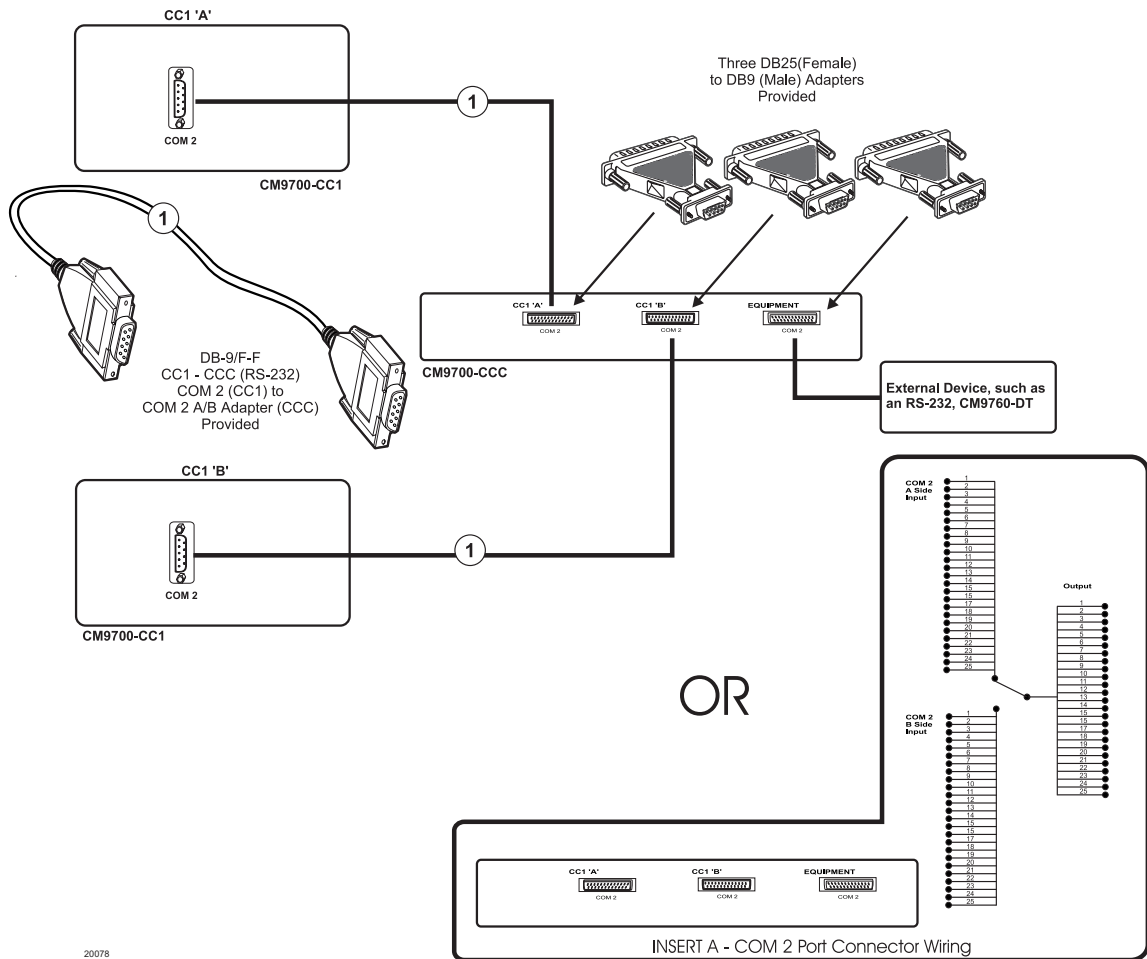
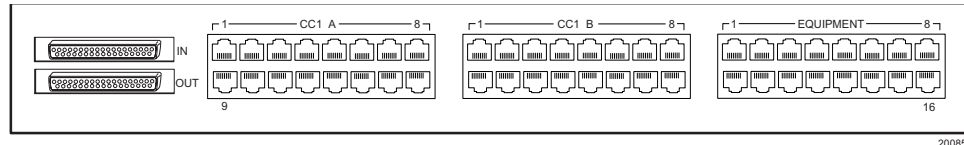

Figure 1-6. COM 2 Port Options

A couple of working rules with respect to diagnostic tool availability are in order here. During default operation (see Figures 2-4 and Figure 2-5) diagnostic tools attached to EQUIPMENT output ports "follow" the switch in control. Under these conditions, the following results can be expected when the described operation is performed:

1. You can view, at will, the diagnostic activity for either switch (Master or Slave) regardless of the operational mode (including default) as long as that switch is online. This is done by pressing the KVD (Keyboard, Video, Data) A (or B) button located on the front panel of the CM9760-CCC for the A- or B-side diagnostic view you want to see (see Table B, Front Panel Button Operation). When the KVD button is pressed, you will view the devices connected to the AT KBD, and VGA port connections for the side (A or B), (Master or Slave) that you selected. It is important to note that the PRINTER, COM 1, and COM 2 ports do not follow KVD activity under any circumstances.
2. If the diagnostic view is switched manually via the KVD button, as in (1), it remains there until
 - (a) the operator manually switches back to the opposite side, or until
 - (b) the system forces a change due to a system fault. A system fault may or may not result in a return to the original diagnostic view. That depends on which switch becomes the designated Master when the changeover, if deemed necessary, occurs. This is determined by the HS itself. It occurs automatically as the result of configuration settings and is not under user control.
3. Any system change (as noted in 2b) co-opts any existing diagnostic view and any resulting change occurs under the control of the HS and not the operator. Moreover, the HS controls and automatically transfers ALL ports (including COM 1 and COM 2) to the control of the designated Master in the event of a system failure.

THE SEU (Serial Expansion Unit)



The SEU subunit of the HS, like that of the CPS, is also divided into three sections. Devices connected to the SEU EQUIPMENT output ports are under the control of only one CC1 at a time. The controlling switch is designated the Master, regardless of mode (synchronous or asynchronous). Unlike the CPS, however, there are no predefined port designations for SEU Sercom input ports that physically correspond to the port designations as they are defined by physical location on any 9760-CC1 matrix switch. On the matrix switch, port 5 is port 5 and is always located at the "port 5" position, and so on.

The physical relationship between matrix switch Sercom outputs and the A/B inputs on the SEU are defined by the following statements:

1. The function of each Sercom input port on the SEU (CC1 'A' or CC1 'B') is characterized by whatever is plugged into it.
2. A specific physical relationship (depicted in Figure 1-7) exists internally between SEU Sercom inputs (A or B) and associated SEU EQUIPMENT outputs.

The Sercom ports on the SEU shown in Figure 1-7 are isolated and numbered (for explanatory purposes); the ports on the SEU are physically related as illustrated.

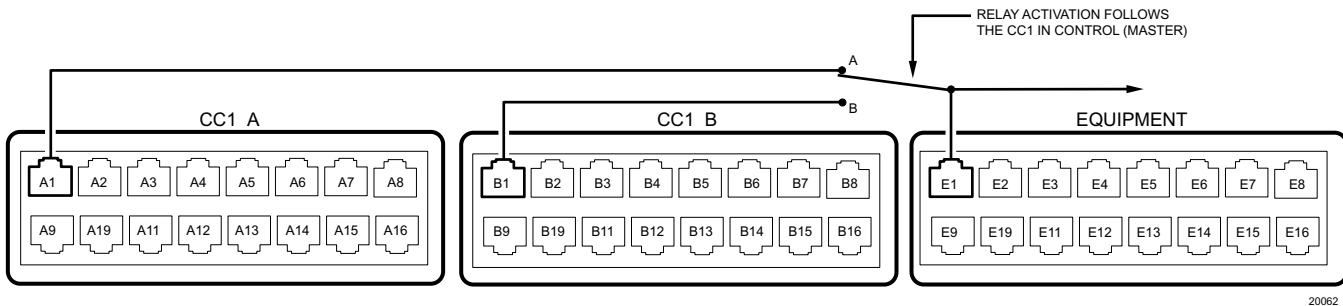

Figure 1-7. SEU Port Relationships

The depiction above shows CC1 'A' input A1, connected to the output device attached to E1.

The physical relationship depicted above is repeated for all corresponding physical port locations; that is, A2 is related to B2 and the output E2 in the same way that A1 is related to B1, and the E1 output.

This relationship holds true for the remaining port locations: A3-A16, B3-B16, and E3-E16.

In line with the port relationship just discussed, you must also maintain corresponding equipment integrity with respect to the input port locations chosen for attaching A- and B-side input cables. This is so that output control, from either matrix switch, of a device connected to a specific SEU output port, corresponds, in fact, to the same physical device.

For example: If a matrix bay is hardware-software configured for attachment to port 7 on 9700-CC1 A, then it also must be configured the same for port 7 on 9700-CC1 B, since the CC1s must be hardware-software clones of each other. If you then run a cable from 9700-CC1 A, port 7, to the CC1 'A' side of the SEU and attach it to the A1 port, then you must also run a corresponding cable from 9700-CC1 B, port 7, to the CC1 'B' side of the SEU and attach it to port B1. The matrix bay itself, is connected to the corresponding output port, E1, on the SEU.

As indicated above, the configured outputs of 9700-CC1 ports can be plugged into any input port on the appropriate SEU, as long as you allow for the physical constraint illustrated in Figure 1-7, above.

A NOTE OF CAUTION: Random attachment of cabling between CC1s and SEUs can lead to confusion about what is attached where. It is suggested that you map the physical port arrangement found in your CC1 outputs to those utilized on the SEU (as far as that is possible). One method is to mentally rotate the SEU (clockwise or counterclockwise, it does not matter) and associate the port locations you use on the SEU to those existing on the CC1. In Figure 1-8, the CC1 'A' side of the SEU is shown rotated counterclockwise. You can extend the use of this visual mnemonic to the SEU's B side, the output, and additional SEUs, if needed (also see the NOTE in Figure 1-8).

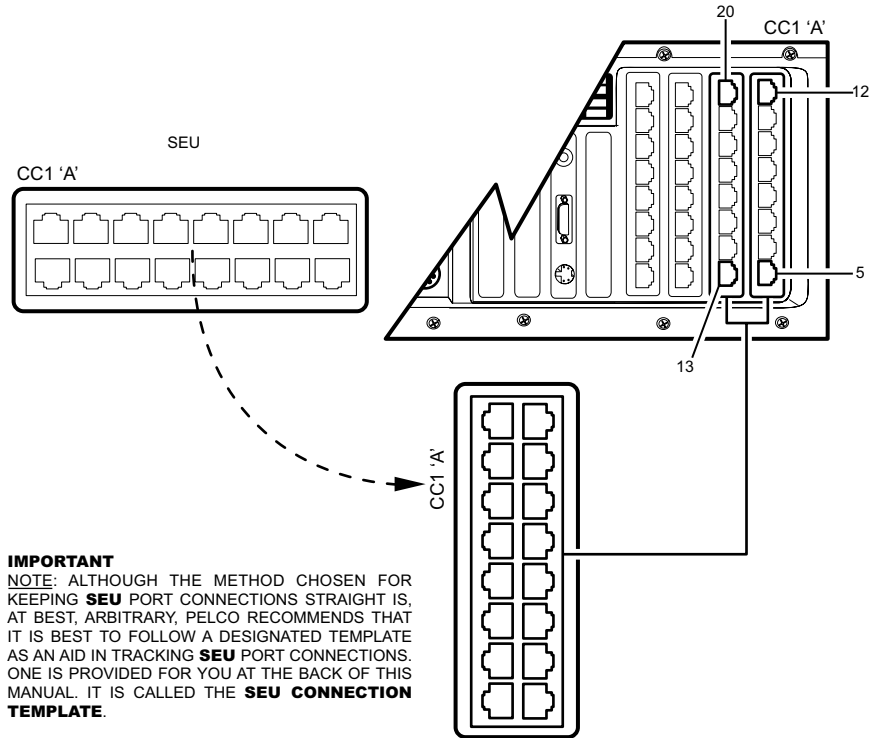

IMPORTANT
NOTE: ALTHOUGH THE METHOD CHOSEN FOR KEEPING **SEU** PORT CONNECTIONS STRAIGHT IS, AT BEST, ARBITRARY, PELCO RECOMMENDS THAT IT IS BEST TO FOLLOW A DESIGNATED TEMPLATE AS AN AID IN TRACKING **SEU** PORT CONNECTIONS. ONE IS PROVIDED FOR YOU AT THE BACK OF THIS MANUAL. IT IS CALLED THE **SEU CONNECTION TEMPLATE**.

Figure 1-8. Port Connection Mnemonic

MASTER/SLAVE STATUS FOR CC1

Sercom port 1 on the CC1-A or CC1-B side of the SEU subunit may be wired to provide the current status of the CM9760-HS. This wiring connection will allow for monitoring that alerts the user to primary (master) CPU (CC1) failure. When the secondary (slave) CPU assumes primary control, the user can be alerted remotely via the closure of an external alarm. This connection is made by constructing an RJ-45 terminated wire (not provided) and shorting pins 1 and 2 (CC1-A) or pins 7 and 8 (CC1-B) together on the CC1 side *only*. The CC1 port (A or B) is connected to the EQUIPMENT side port 1. See Figures 1-9 and 1-10.

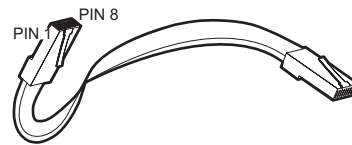

Figure 1-9. RJ-45 Pin Detail

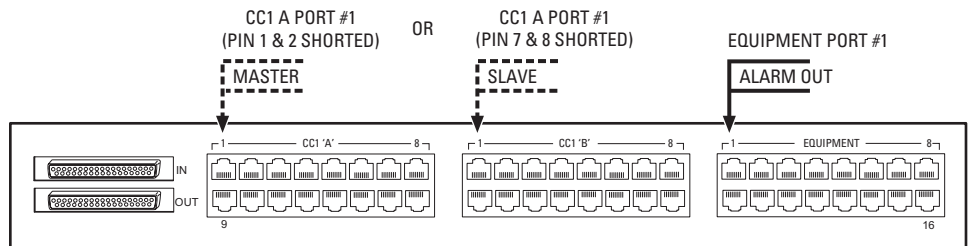

Figure 1-10. SEU Master/Slave Wiring Diagram

1.5 INSTALLATION PREVIEW

Figure 1-11 combines elements of previous illustrations into what is essentially a wire routing of the block diagram of Figure 1-1. This is an overview of the physical geometry of an HS integrated into a basic, default system configuration. *Section 2.1 Physical* in *Section 2.0 Installation*, breaks up Figure 1-11 into its logical component groupings, where cabling requirements for each section are isolated and examined in detail. Cabling in the current model hot switch is rather straightforward.

Other Remarks:

In addition to basic hookup, which covers the information needed for a new, single-node installation, the following configuration processes are discussed in *Section 4.0 Appendices*.

- HS addition to an existing configuration, (no hot switch currently installed)
- HS update, (previous model of hot switch installed)
- HS update (current model hot switch installed)
- HS and networked configurations

Installation Checklist:

The basic install process for integrating a hot switch within a single system node can be broken down into the following steps:

1. Mount the components of the hot switch (standard rack-mount) in such a way as to take advantage of the equipment that will attach to each unit. At the same time, be mindful of the relatively short interconnect cables that form the common bus between the subunits of the HS. Install the interconnect cables that form the common bus (see Figure 1-3 for a picture of this cabling). Install the power cord on the CM9760-CCC, but do not apply power to the unit.
2. Connect all remaining cabling that is required for your system node. Follow, in order, all items of *2.1 Physical* in *Section 2.0 Installation* of the manual, for instructions. Configure DIP switch one and two located behind the front panel of the CM9760-CCC subunit (see Figure 2-4).
3. Install all required software. Ensure that duplicate sets of configuration files for the interfaced matrix switches are installed on the respective hard drives of each switch. Check to make sure that port references to attached equipment match the equipment actually attached to those ports. Refer to the appropriate sections of the latest version of the MGR programming for general information on filling out configuration files. Refer to the appropriate sections of the latest revision of the matrix switch manual (C541M), for information on installing configuration files and other items related to file manipulation. Be sure to add the hot switch to the COMMS configuration file, if not already done.
4. After all cabling and software is installed, apply power to the HS and all attached equipment and let the systems initialize (see *2.2 Power-up and Initialization* in *Section 2.0 Installation*).

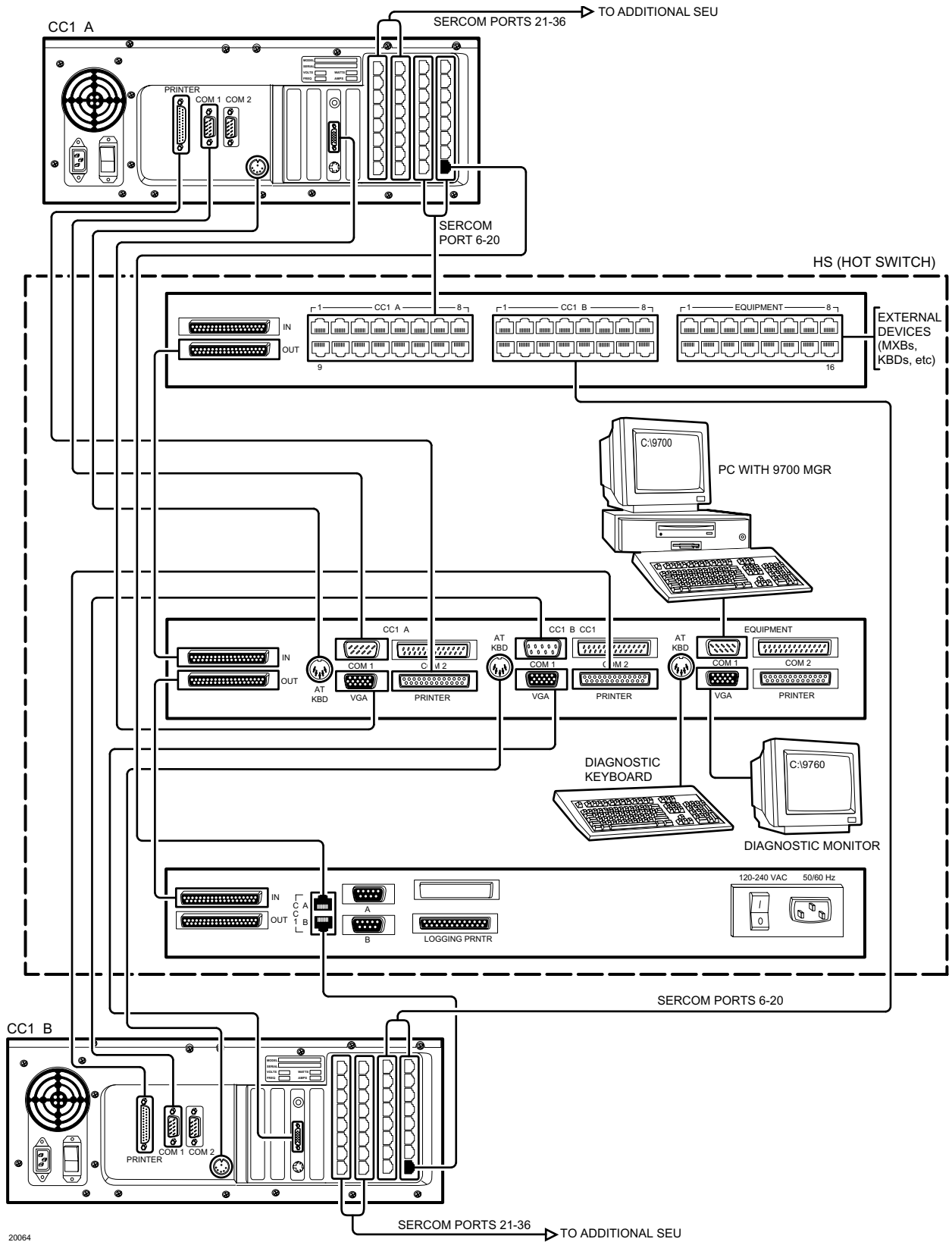

20064

Figure 1-11. Basic Hookup, Wire Routes

SECTION 2.0: INSTALLATION

2.1 PHYSICAL

As previously stated, the connections from 9700-CC1s (CC1-A and -B) to the HS are duplicates of each other. Except where noted, all the plugs and connectors found on the rear of the CC1 have corresponding port representations on the subunits of the HS.

9700-CC1 TO CCC (Control Group)

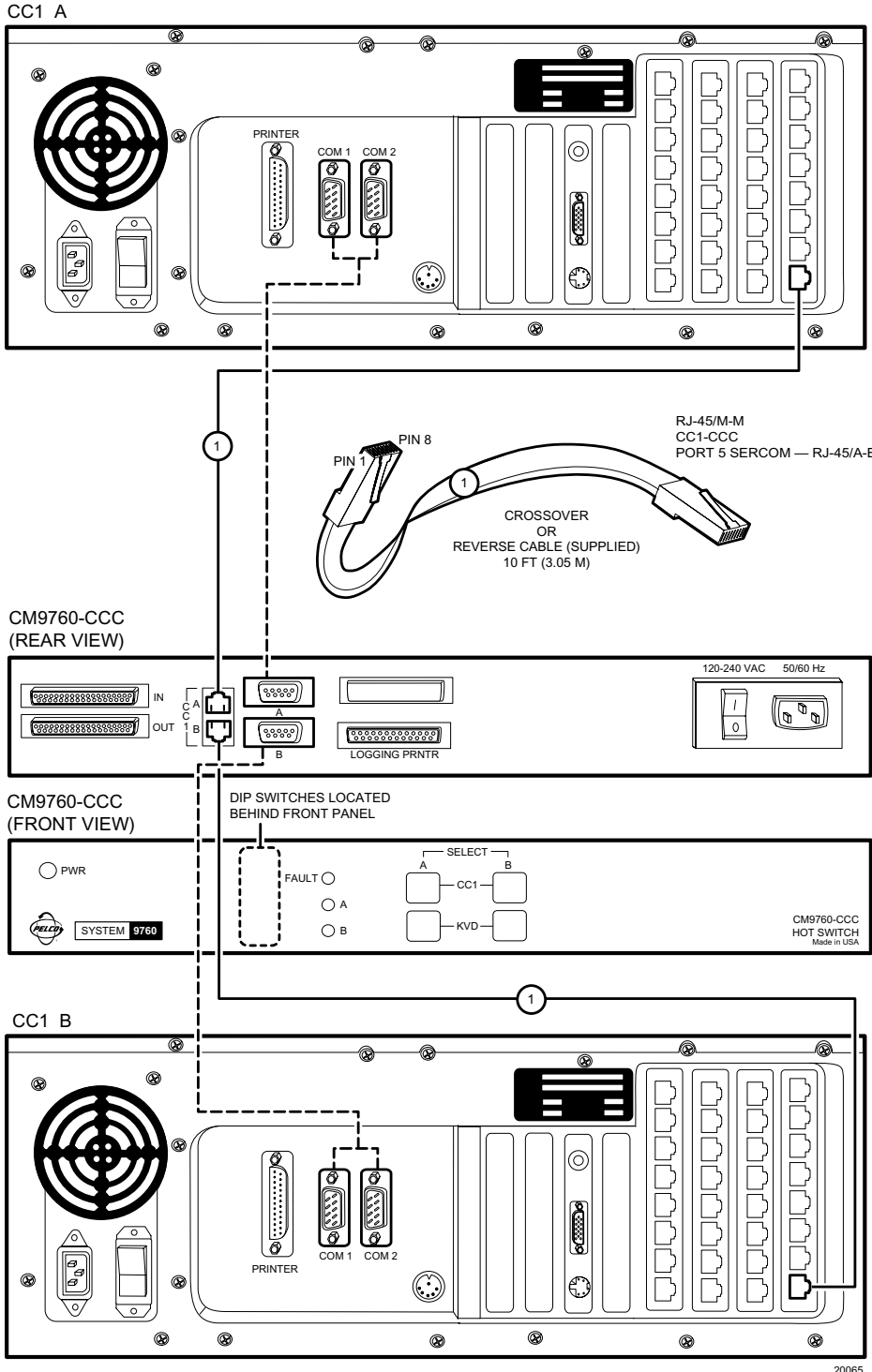

- RJ-45 (A & B) DATA LINE INPUT PORTS ARE RS-422; THE DB9, (A & B) PORTS ARE RS-232.
- RECOMMENDED, DATA CABLE HOOKUP IS THAT REFERENCED AS (1) IN FIGURE 2-1 (CABLE PROVIDED).
- THE ALTERNATE HOOKUP (INDICATED BY THE DOTTED LINE) IS DETAILED IN FIGURE 1-5.
- YOU SHOULD USE THE SAME CABLE CONFIGURATION FOR EACH ATTACHED CC1.
- DIP SWITCH 2 SETTINGS MUST REFLECT THE COMMUNICATION PROTOCOL OF THE DATA PATH CHOSEN. (SEE FIGURE 2-4).
- PORT ATTACHMENT OF THE HS DATA LINE CONNECTION TO SERCOM PORT 5 IS REFLECTED IN THE COMMS FILE.
- PORT ATTACHMENT REQUIREMENTS FOR HS-NIU CONFIGURATIONS ARE DISCUSSED IN APPENDIX 4.4, HS AND NETWORKED CONFIGURATIONS.

Figure 2-1. Data Cable Wiring Detail

9700-CC1 TO CPS (Diagnostic Group)

The connection points for diagnostic and monitor tools for hot switch and system status are shown in Figure 2-2. Note that COM 1 on either CC1 (the normal connection point for the PC w/MGR in a stand-alone CC1 configuration) is run to the appropriate COM 1 input connector on the CPS. COM 1 output on the CPS is reserved for the PC w/MGR connection. If a CC1 COM port on the switch is defective, the other port can be used, but you must still connect to COM 1 on the CPS. Moreover, you must follow suit on any change in physical COM port configuration in the duplicate CC1. In addition, any port changes must be reflected in the COMMS file.

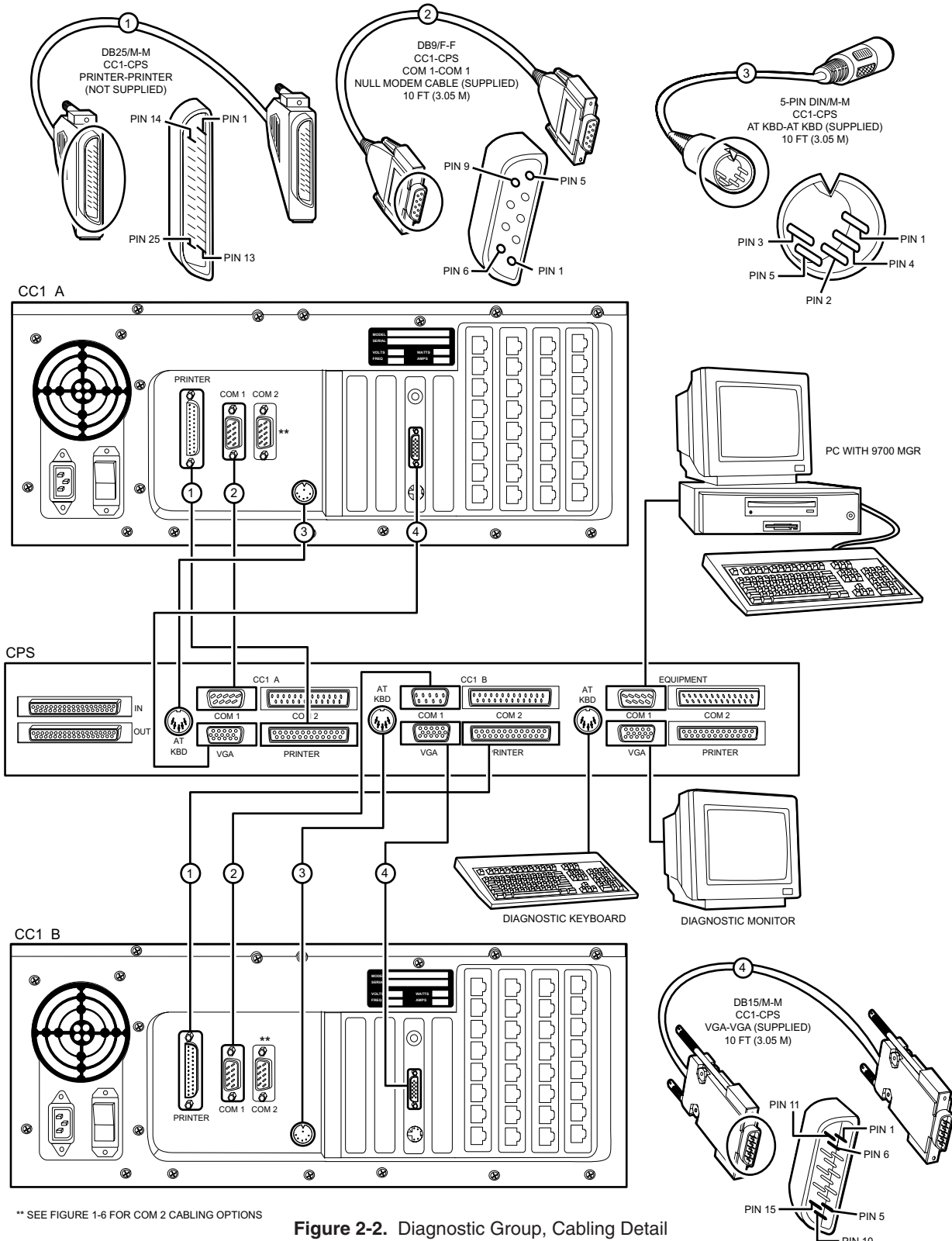

Figure 2-2. Diagnostic Group, Cabling Detail

9700-CC1 TO SEU (Expansion Group)

Devices connected to the EQUIPMENT output port (which the designated Master switch has access to) are implemented here. Port destinations for cable connection inputs from the matrix switches are not predefined. This was discussed in the SEU portion of 1.4 Subunit Highlights in Section 1.0 Introduction. It is recommended that the SEU connection template (located at the back of the manual) be utilized here. All interconnecting cables are RJ-45, M-M, RS-422, and are provided for the input (CC1 'A' and 'B') connections.

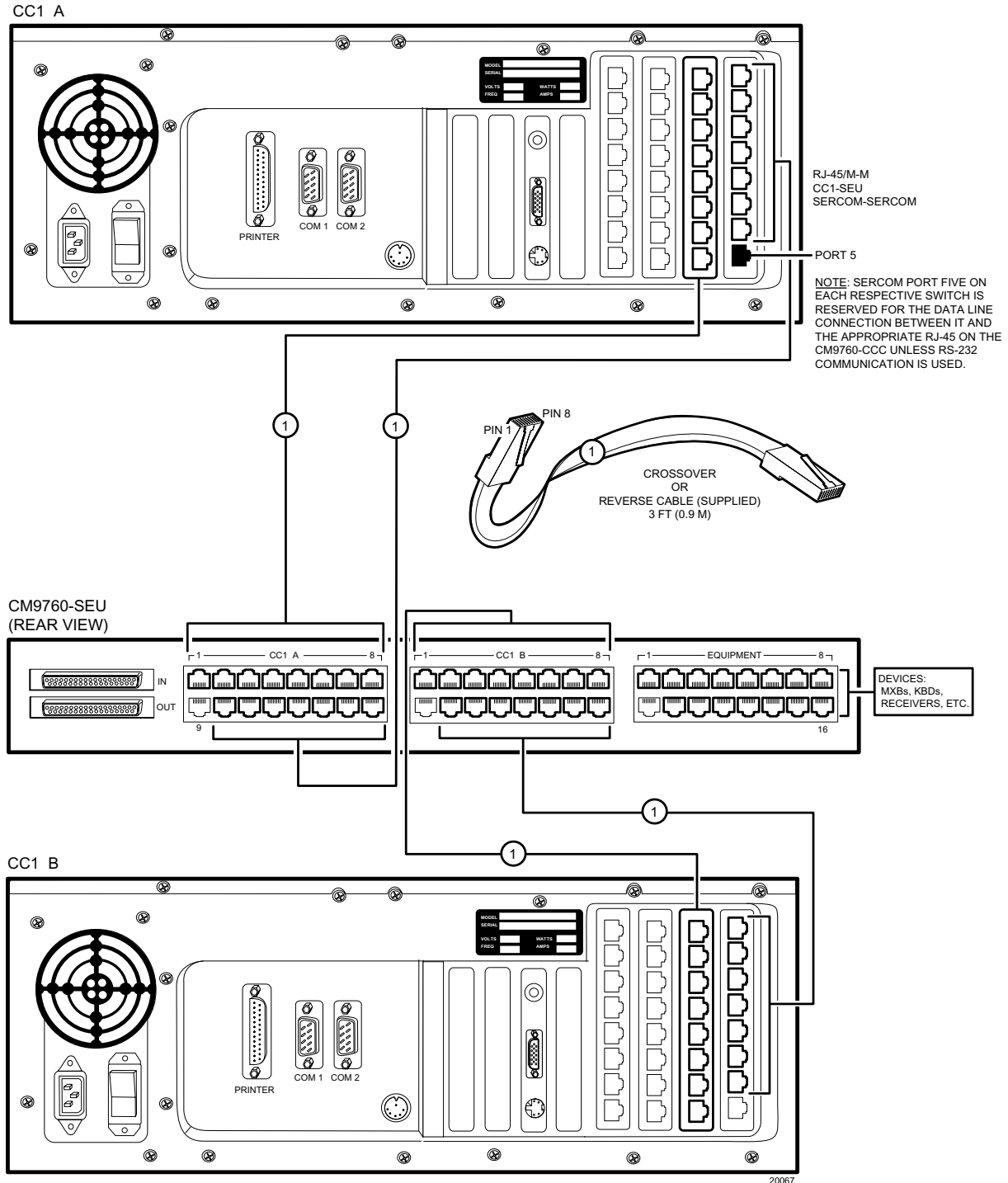
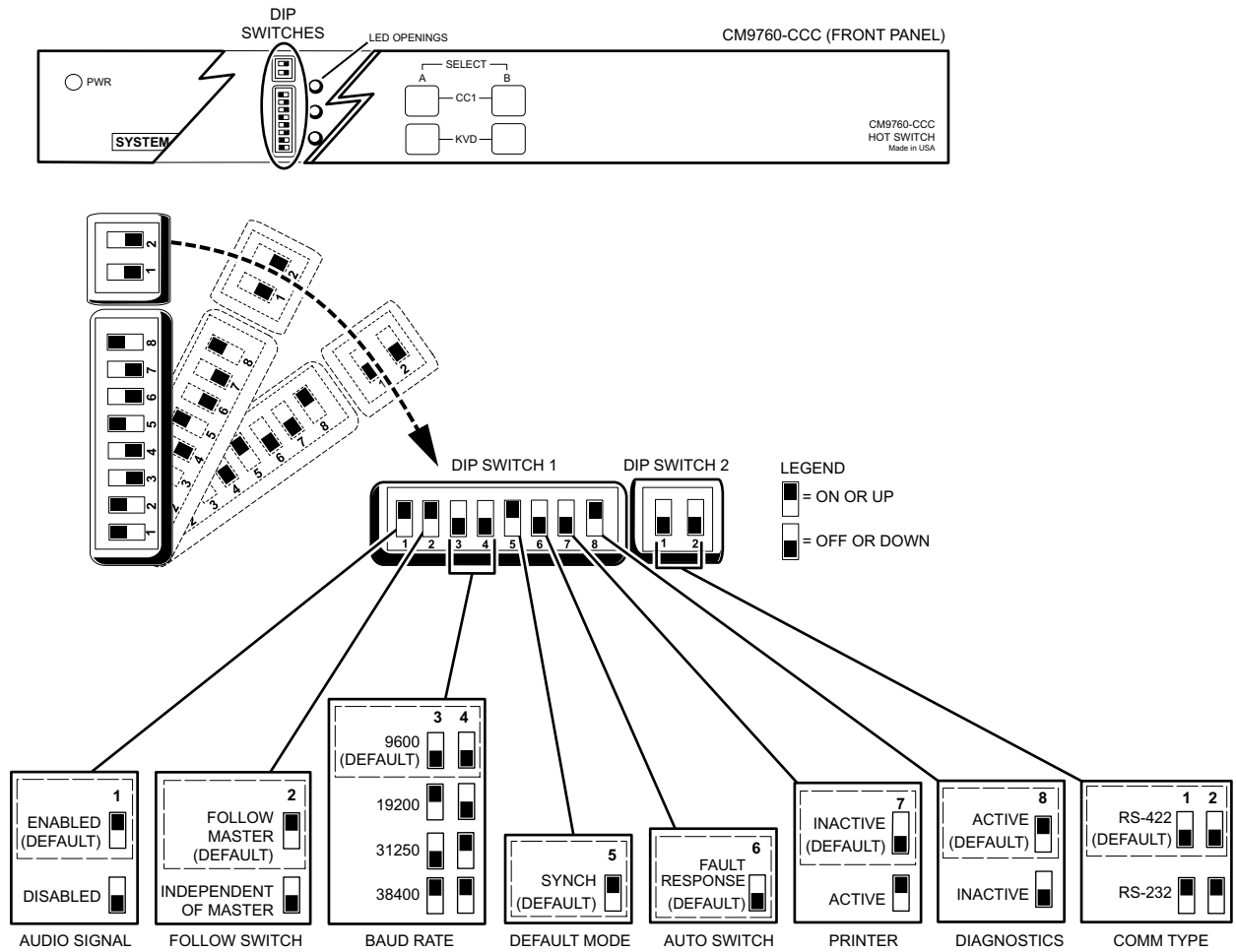

Figure 2-3. External Expansion Cabling Detail

DIP SWITCH SETTINGS

Some HS operating parameters are determined via two DIP switches, which are physically located to the left of the front panel LED displays, but behind the front panel of the CCC itself. Figure 2-4 illustrates all DIP switch settings. Factory default is indicated.



20068

DIP SWITCH 1

AUDIO SIGNAL

THIS TURNS OFF THE TONE (DIP 1-1, DOWN) HEARD WHENEVER A SYSTEM **FAULT** OCCURS. IT DOES NOT AFFECT THE TWO-BEEP TONE HEARD WHEN A USER REASSERTS ASYNCHRONOUS MODE.

FOLLOW SWITCH

THE DIAGNOSTIC TOOLS ATTACHED TO CPS EQUIPMENT OUTPUT PORTS FOLLOW (DIP 1-2, UP) THE CC1 SWITCH IN CONTROL (MASTER) IF A CHANGE-OVER OCCURS.

BAUD RATE

THE BAUD RATE SELECTED HERE (9600 IS DEFAULT) AND THAT ENTERED INTO THE COMMS FILE FOR THE PORT TO WHICH THE CCC IS ATTACHED MUST AGREE.

DEFAULT MODE

ALWAYS SET TO SYNCHRONOUS (DEFAULT = ON). OFF SETTING IS FOR FACTORY USE.

AUTO SWITCH

IF MASTER FAILS, SYSTEM WILL SWITCH TO SLAVE (DEFAULT = OFF). IF ON, SYSTEM WILL NOT SWITCH.

PRINTER

SET TO **INACTIVE** (DEFAULT). IF YOU CONNECT A PRINTER TO THE CCC LOGGING PRINTER PORT, SET THE SWITCH TO THE **ACTIVE** (DIP 1-8, UP) POSITION. THE PRINTER PORT SUPPORTS DOT MATRIX PRINTERS CAPABLE OF IBM OR EPSON EMULATION MODES, SUCH AS THE OKIDATA 320 (NON-TURBO) AND THE OKIDATA 390 (TURBO) OR 391 (TURBO).

DIAGNOSTICS

DEFAULT IS ACTIVE. DIAGNOSTIC TOOLS SHOULD BE ACCESSIBLE.

DIP SWITCH 2

COM TYPE

SET TO CORRESPOND TO THE DATA COMMUNICATIONS TYPE CHOSEN. RS-422 IS THE DEFAULT.

Figure 2-4. DIP Switch Configuration

2.2 POWER-UP AND INITIALIZATION

Once configuration files have been programmed and loaded and all connection cabling has been run, then the associated CC1s, the hot switch and all connected devices can be turned on.

The order of equipment turn-on is immaterial; however, if the HS is turned on before either CC1 finishes initialization, the online LEDs (A and B) on the front panel of the CCC will alternate rapidly back and forth. In addition, if the HS is ON and one CC1 finishes initialization ahead of the other, you might notice that it will temporarily be made the Master and the mode will be Asynchronous. This is no cause for concern; it is normal. When the entire system finally initializes, the CCC determines whether default operating conditions are possible, and, if they are, the system will enter synchronous, A-Side (Master) control, with B-Side (Slave). A visual check of successful initialization appears on appropriately connected diagnostic monitors; however, the primary indicator of successful initialization is a visual check of the LEDs located on the front panel of the CCC. Figure 2-5 illustrates this.

INITIALIZATION AND DEFAULT STATUS INDICATORS

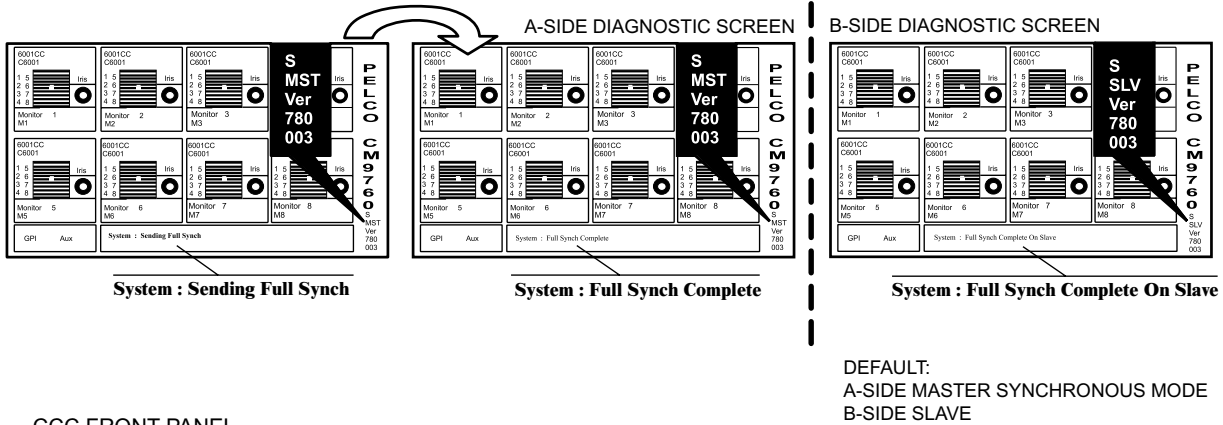

CCC FRONT PANEL

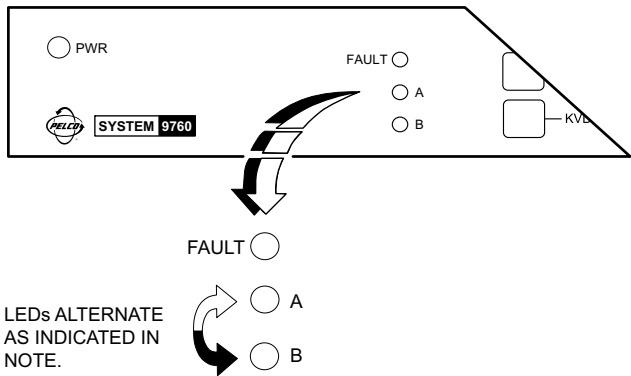

NOTE: LEDs **A** AND **B** ALTERNATE (OR PING-PONG) BACK AND FORTH. WHEN LED **A** IS ON, LED **B** IS OFF FOR THE SAME PERIOD OF TIME. THE LED FOR THE SIDE HAVING MASTER CONTROL (IN THIS CASE, **A**) IS ON ABOUT FOUR TIMES AS LONG AS THE **B** LED. IF THE B-SIDE WERE MASTER, THE OPPOSITE WOULD OCCUR.

20070

Figure 2-5. Initialization Status, Default

SECTION 3.0: OPERATION

3.1 PRELIMINARY REMARKS

There are two modes of HS operation. One is termed the synchronous mode and the other, the asynchronous mode. Synchronous mode, of course, is the desired mode of operation. It is the optimal mode of operation and the one the HS is designed to operate under. It is also the default mode of operation and the only mode that provides proper backup to the system. The asynchronous mode, on the other hand, is the mode the system reverts to (from synchronous mode) when a system error occurs, for whatever reason. It is important to point out, however, that even in asynchronous mode, the system is still up. In that sense, the asynchronous mode is also a successful mode because it means that the HS successfully passed control to the working CC1 and that the interfaced system is still operational. Once faults are corrected, the operator can manually return the system to its designed optimal, default configuration. This process, among others, is discussed in detail in Table E.

3.2 TERMS AND DEFINITIONS

The following terms are used extensively in the next few sections. We list a working definition of each term to reduce confusion about their meaning when used in conjunction with the hot switch.

Synchronous – A hot switch operational mode that is the primary, default mode of HS operation. It normally occurs at the end of a successful start-up. Once enabled, synchronous-mode control can be switched from one matrix switch to the other by pressing the appropriate CC1 A or CC1 B button once.

Asynchronous – A hot switch operational mode in which the side in control is not synchronized with the other side. It occurs as a result of any of the following:

1. A CC1-generated failure report to the HS. The HS FAULT LED is lit.
2. Manual intervention by an operator via front panel switches (pressing and holding CC1 A or CC1 B button for two beeps). The HS FAULT LED is not lit.
3. A CC1 failure detected by the HS that one of the two CC1s is not operational. FAULT LED is lit.

When asynchronous mode is entered, the following may occur (dependent on the state of the system at the time the action occurs):

1. A snapshot of the current state of the primary CC1 (if it has failed) is made and passed on to the backup CC1.
2. The auto-changeover sequence is initiated and control is passed to the backup CC1, which is automatically put into asynchronous mode.
3. If the backup fails, control remains with the primary Master unit. It is automatically put into asynchronous mode.

Synchronization – An ongoing dynamic process wherein the current camera-monitor-user status of the primary (Master or control side) is continually updated to the secondary (Slave or back-up) side. The internal dynamics of the process is not under user control.

Changeover – A word that describes the automatic process of passing from synchronous to asynchronous or from asynchronous to asynchronous mode because of the failure of either CC1 (primary or backup), while in synchronous or asynchronous mode, respectively. Of course, the appropriate DIP switch settings must be configured to allow this.

The HS implements an automatic changeover for the following reasons:

1. There is a primary COM failure with either CC1.
2. A secondary problem with either CC1 that results in its failure.

Either of the above results in the system FAULT LED being lit.

Additionally, changeovers can be manually initiated by the operator (see Table B). The FAULT LED is not lit.

3.3 OPERATOR TOOLS

LEDs

A visual check of LED activity should be the top item on your checklist for determining the operational status of the HS and the attached system. LED status tells you the following:

- Which mode (synchronous or asynchronous) the HS is operating in
- Which side (A or B) is in control (synchronous mode)
- Which side (A or B) is in control (asynchronous mode)
- Which side is in control after an equipment failure
- Which side caused the system FAULT

An operational system is always in synchronous or asynchronous mode; otherwise, the system is down. There are no intermediate operational states.

Table A relates LED activity to the function listed in the left-hand column for the given operational modes.

We use the following visual icons to represent (to the user) the visual state of the front panel LEDs.

LED LEGEND:

RELATIVE LED LOCATION AND IDENTIFICATION
MIRRORS THAT USED ON THE CCC FRONT PANEL.

RELATIVE LED LOCATION

- FAULT
- A
- B

LED STATES

- LED LITE IS **OFF**
- LED LITE IS **ON (SOLID)**
- ◐ LED LITE IS **ON (LONG), OFF (SHORT)** AND THE SIDE REPRESENTED IS IN CONTROL (MASTER).
- ◑ LED LITE IS **ON (SHORT), OFF (LONG)** AND THE SIDE REPRESENTED IS NOT IN CONTROL (SLAVE).

LED ACTIVITY ALLOWS YOU TO IMMEDIATELY DETERMINE



Table A. LED Activity

20084

MODE ▶	SYNCHRONOUS			ASYNCHRONOUS	
FAULT	○	○		○	○
A	◐	◑		●	○
B	◑	◐		○	●
CONTROL STATUS ▶	A-Side Master, B-Side Slave	B-Side Master A-Side Slave		A-Side in Control	B-Side in Control
FAULT STATUS ▶	NONE		FAULT	●	●
			A	●	○
			B	○	●
				FAULT LED ON, A-Side in Control	FAULT LED ON, B-Side in Control

FRONT PANEL BUTTONS

Front panel buttons (CC1 [A or B]) are used to respond to HS detected system errors and for direct implementation of other HS functions when needed or required, such as troubleshooting or update procedures.

When used in conjunction with LED readouts and other diagnostic tools, an operator can pinpoint current system status and/or implement appropriate corrective action, as needed. Using the front panel buttons, an operator can

1. Acknowledge a system FAULT (turn it off)
2. Change from asynchronous to synchronous mode or its converse
3. Switch primary system control from one CC1 to the other
4. Switch diagnostic view from the A- to the B-side and vice versa

The following table illustrates how to implement these actions for the HS. Included are pertinent “before and after” visual changes associated with the action along with applicable notes about system operation. The shorthand, visual icons used in the LED “legend” and Table A of the preceding section are also applicable here.

Table B. Front Panel Button Operation

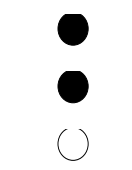
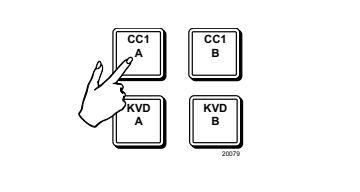
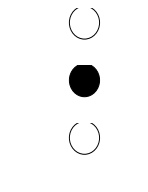
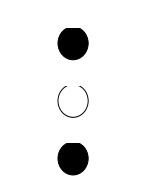
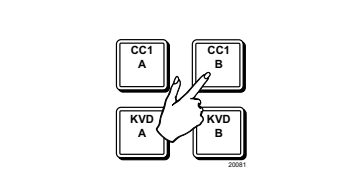
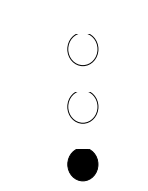
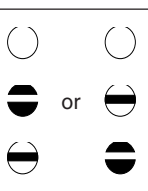
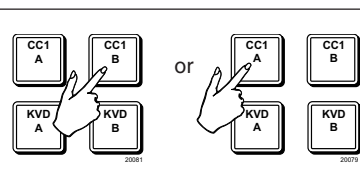
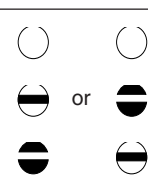
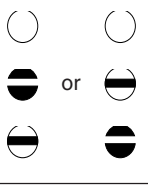
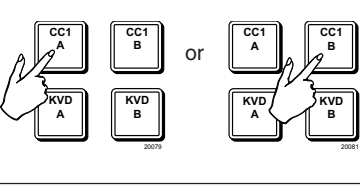
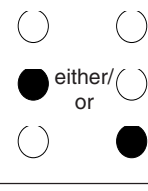
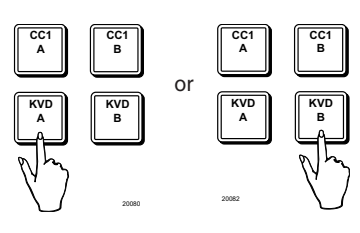
FUNCTION	START LED STATUS	FP BUTTON ACTION	REMARKS	END LED STATUS	COMMENTS
FAULT Acknowledging A-Side Control			Any successful HS auto-response to an alarm results in a changeover** to asynchronous mode. Press and hold CC1 A button for two audible beeps.		A-Side Asynchronous mode is reasserted and the alarm has been acknowledged.
FAULT Acknowledging B-Side control			Any successful HS auto-response to an alarm results in a changeover** to asynchronous mode. Press and hold CC1 B button for two audible beeps.		B-Side Asynchronous mode is reasserted and the alarm has been acknowledged.
**All HS initiated system FAULT responses are associated with a changeover, but all changeovers are not necessarily associated with a system FAULT. An operator-initiated changeover is a case in point.					
Change Control			To change control from A- to B-side, press CC1 B once; or conversely, press CC1 A once.		LED attributes change accordingly.
Change Mode (synchronous to asynchronous or visa versa)			Press and hold (for two beeps), either the CC1 A or CC1 B button.		You can start from either A- or B-side, synchronous mode and change to either A- or B-side asynchronous mode.
Change Diagnostic View A to B or B to A	N/A		By default, the diagnostic view follows the side in control (Master) because DIP switch 1-2 is ON. You may, however, view the diagnostic of either side (A or B) any time you want by performing the indicated action. If the DIP switch is set to default (follow Master) and you have switched to view the diagnostic screen of the Slave unit, that view will remain on the monitor until either (1) you manually reassert Master side control, (2) press the Master-side KVD button or (3) a Slave-side failure occurs and the HS reverts to asynchronous mode, Master.		

3.4 OPERATOR RESPONSES AND METHODS

User interaction with the HS is necessary when (1) a system error occurs, which generates a FAULT LED, and (2) when a software/hardware change or upgrade to the system must be made. System FAULTS are discussed first.

SYSTEM FAULTS

Although error response is addressed in the previous table, not all FAULT situations are covered there.

Any alarm results in the FAULT LED being lit. An associated audible notification also occurs if optioned via DIP switch. You can turn off audible notification (default) by setting DIP switch 1-1 to the OFF position (see Figure 2-4). Note that this does not affect the audible two-beep tone associated with manually asserting asynchronous mode.

In any FAULT situation, system control is passed to or remains with the “working” CC1, which then automatically reverts to or remains in asynchronous mode. The following table summarizes system operation and the necessary user response to any FAULT variation, given the stated initial conditions:

Table C. System FAULT Response

IF THE CONTROLLING SIDE IS:	AND THE MODE IS:	AND SIDE	THE RESULT IS:	The FAULT LED is Lit and the ___ LED is On	TO ACK the FAULT LED (and the audible, if ON), PRESS & HOLD CC1 ___ for two beeps:
A	Synchronous	A Fails	B goes to Asynchronous	B	B
A	Synchronous	B Fails	A goes to Asynchronous***	A	A
A	Asynchronous*	A Fails	B goes to Asynchronous**	B	B
A	Asynchronous	B Fails	A remains in Asynchronous	N/A	N/A
B	Synchronous	B Fails	A goes to Asynchronous	A	A
B	Synchronous	A Fails	B goes to Asynchronous***	B	B
B	Asynchronous	A Fails	B remains in Asynchronous	N/A	N/A
B	Asynchronous*	B Fails	A goes to Asynchronous**	A	A

* In this instance, the side in question is in asynchronous mode as the result of operator action, not because the opposite side had previously failed.

** If you are in A or B, asynchronous mode because the opposite side previously failed and now the side in question fails before the opposite side is repaired and brought back up, then the entire system is down.

*** The “RESULT” mode indicated here will not appear on the diagnostic monitor until the FAULT LED is acknowledged.

The above cases of FAULT activity can be summarized in the following statements:

- If both interfaced matrix switches (CC1s) are working, any system error leaves one of the two CC1s in control.
- Any error always puts the system in asynchronous mode, if it is not there already.
- In each case, to turn OFF or ACK the FAULT, you must manually reassert asynchronous mode for the side in control after the error occurs (the LED light for the side in control [A or B] is ON solid). Hold the CC1 A or CC1 B front panel button until the audible two-beep tone is heard.

DIAGNOSTIC MONITOR AND SYSTEM WINDOW USE

Normal Operation

During normal startup, the diagnostic screen on the monitor (attached to the VGA output of the CPS- see Figure 1-11) reflects successful hot switch initialization. Likewise, the system window of the PC with MGR that is attached to the COM 1 output port of the CPS reflects the online status of the system node (see Figure 3-1 below), but gives no additional information. In fact, the system window indicates nothing amiss even if only one of the two available CC1s boots, and comes online successfully. Although the system window reflects the status of the CC1 currently in control, it is not the tool of choice for information regarding hot switch operation. To the MGR, hot switch operation is essentially transparent.

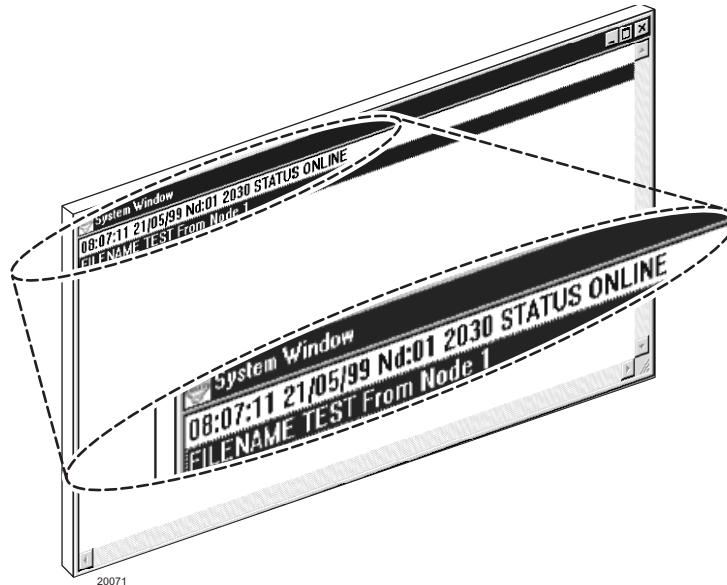

Figure 3-1. System Window Online Status

On the other hand, diagnostic screen displays, in addition to those associated with initialization, are useful (see Figure 2-5). Diagnostic screen information, combined with LED activity, are the primary sources of information on the status of hot-switch interfaced systems. Operationally, the diagnostic screen supplies the following information:

1. It reflects the status of the controlling CC1 (if DIP switch 1-2 is ON**)
2. If DIP switch 1-2 is OFF, it reflects the status of the last selected CC1 (normally operator-selected via the KVD button).

** This does not prevent the operator, if he wants, from viewing the diagnostic screen of the non-controlling CC1. If the diagnostic view is changed by the operator to the non-controlling CC1, that view will remain on-screen until an event occurs that updates system parameters or until the operator changes the view back to the original, controlling CC1. The default DIP switch setting is meant to automatically switch the diagnostic monitor to view the currently active CC1 in the event a changeover occurs. A changeover is an HS-controlled event that occurs because one of the CC1s is no longer operational. The result is an HS system error that is accompanied by an audible alarm tone and a visual LED FAULT light.

The most important area of the diagnostic screen to watch is located in the lower right-hand portion of the display. There, you can read off the current mode of operation, which CC1 is in control, and the software version of the system executable. These items are highlighted in Table D.

Diagnostic screen displays change as the result of direct operator action or because of automatic HS response to system failure. Table D addresses those changes. Table D is similar to Table B, except that in Table D, diagnostic screen display information, rather than LED activity, is related to the implementation of the function listed in the left-hand column. The starting point is the diagnostic display for default initialization. The diagnostic screens for both the A- and B-side matrix switches are shown. The screen seen during normal default operation is the one associated with the controlling switch (unless you opt to view the non-controlling diagnostic by pressing the appropriate KVD button). That is why both diagnostic screens are illustrated.

Table D. Diagnostic Displays

		A-SIDE DIAGNOSTIC	B-SIDE DIAGNOSTIC	COMMENTS
<p>Starting point-initialization screens (normal start-up) →</p>		<p>20086 System : Full Synch Complete</p>	<p>20087 System : Full Synch Complete On Slave</p>	<p>DIP 1-2 is ON. The diagnostic screens illustrated here are those seen prior to the implementation of each function listed, unless noted otherwise.</p>
OPERATOR SELECTED ACTIONS				
FUNCTION	A-SIDE DIAGNOSTIC	B-SIDE DIAGNOSTIC	COMMENTS	
Change Control	<p>20087 System : Full Synch Complete On Slave</p>	<p>20086 System : Full Synch Complete</p>	<p>Gone from A- to B-side control. Data synchronized to primary.</p>	
Change Mode	<p>20088 System : Full Synch Complete</p>	<p>20089 System : Full Synch Complete On Slave</p>	<p>A-side selected as asynchronous primary. CC1s no longer synchronized. B-side is still online.</p>	
SYSTEM ERROR DISPLAY				
FUNCTION	A-SIDE DIAGNOSTIC	B-SIDE DIAGNOSTIC	COMMENTS	
System FAULT	<p>20090 System : Full Synch Complete</p>	<p>20091 System : Port 6 Error Max Retry</p>	<p>Side B fails. System switches to A-side, Asynchronous Master. B-side is "DWN" and HS diagnostic shows communication error. CC1s not synchronized.</p>	

Table D. Diagnostic Displays (continued)

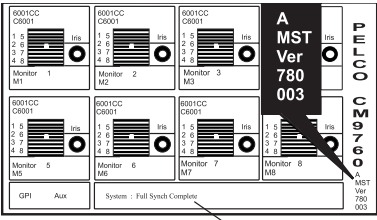
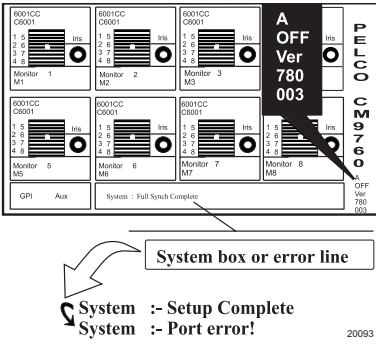
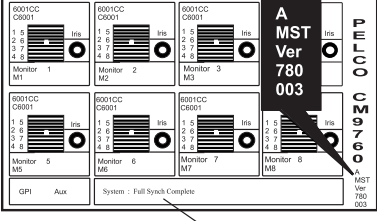
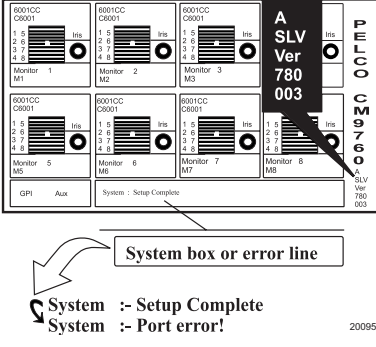
INITIALIZATION ERROR DISPLAY			
FUNCTION	A-SIDE DIAGNOSTIC	B-SIDE DIAGNOSTIC	COMMENTS
<p>Initialization failure. One side fails to boot up or establish communication with the HS</p>	 <p>20092</p> <p style="text-align: center;">System : Full Synch Complete</p>	 <p>20093</p>	<p>B-side fails. B-side diagnostic will initially show "Setup Complete" and then revert to a port error readout. It never comes online (A-OFF). The A-Side is online (A-MST), asynchronous mode. System box or error line initially shows "Setup Complete" and then shows port error. If you try to synch with B-side at this time (B-side off-line) System box will display "Full Synch Complete", meaning it tried to sync. System error (FAULT LED lit) will automatically be generated.</p>
RECOVERY DISPLAY EXAMPLE			
FUNCTION	A-SIDE DIAGNOSTIC	B-SIDE DIAGNOSTIC	COMMENTS
<p></p>	 <p>20094</p> <p style="text-align: center;">System : Full Synch Complete</p>	 <p>20095</p>	<p>If you take B-side completely offline, fix, and reboot, then B-side diagnostic will show it as online (A-SLV) with "Setup Complete" displayed in the System box or error line. HOWEVER, THE B-SIDE IS NOT YET SYNCHRONIZED (look at LEDs). Press CC1 A once for synchronization.</p>

SYSTEM UPDATE PROCEDURE

Table E (see NOTE at end of Table) describes the procedure to follow when it is necessary to update, change, or add any hardware/software item associated with a hot-switched, online system node. The procedure, explicitly detailed in Table E, proceeds through the following steps:

1. Manually puts A- or B-side into asynchronous mode (Table E starts with A-side), and takes the opposite side offline.
2. Repairs or updates to components of the offline system are made.
3. Power is applied to the offline unit, it is then synchronized, after which asynchronous mode is asserted on the same side.
4. The opposite side is taken offline where the same updates and changes are made, the unit is powered up, and then the system is resynchronized.

Table E. System Update of Hardware/Software, Starting from Default Mode

<u>Abbreviations and References Used</u>	Mstr	= Master	<u>Front Panel SELECT Buttons</u>	CC1	A
	Slv	= Slave		CC1	B
	Sync	= Synchronous		KVD	A
	Async	= Asynchronous		KVD	B
	S mode	= Synchronous mode			
	A mode	= Asynchronous mode			
	FP	= Front Panel			

COMMENTS	FP Button (User Action)	SIDE	STATUS	MODE	LEDs (A/B)	FAULT LED
		A-side	Mstr/Slv	MODE = Async/Sync Asynchronous/ Synchronous; else Offline	LEDs A and B alternate in S mode. LED for primary is On long, Off short; LED for secondary is Off long and On short. In A mode, the controlling units LED is ON solid.	FAULT On or Off
		B-side	Mstr/Slv	MODE = Async/Sync Asynchronous/ Synchronous; else Offline		
1 Default Operating Mode		A	Mstr	Sync	A On long	FAULT Off
		B	Slv	Sync	B On short	

- If you are in **B-side Master**, Synchronous Mode, switch to **A-side Master**, synchronous mode (as above) to follow the procedure presented.
- Place DIP switch 1-2 (see Figure 2-4) to the **Off** position so that all CPS diagnostic tools (VGA monitor, etc.) are under user control during the update process.

2	Press and hold CC1 A for two beeps (forces A side to Async mode; B-side is still online, but not synched).	CC1 A [2 beeps]	A	Mstr	Async	A On solid	FAULT Off
			B		Online	B Off	
3	Press KVD B, so that diagnostic tools are available for the B-side update, which will be done first (equipment and/or software).	KVD B	A	Mstr	Async	A On solid	FAULT Off
			B		Online	B Off	
4	A "Ctrl + Q" keypad operation on B-side takes it offline. The diagnostic screen should show the DOS prompt on the B-side.		A	Mstr	Async	A On solid	FAULT Off
			B		Offline	B Off	

With the B-side offline, you can do any or all of the following:

Hardware: Physically move, add, or delete hardware.

Software: Upgrade the system software on the CC1 and/or the MGR software located on the external PC.
Amend, update, or replace configuration files to correspond to the new equipment configuration using the MGR program.
Transfer updated configuration files to the appropriate hard-drive directory on the B-side CC1.

When changes are complete, initialize the B-side CC1 to "Setup Complete." **THE B-SIDE WILL NOW BE ONLINE, BUT NOT SYNCHED.**

Table E. System Update of Hardware/Software, Starting from Default Mode (Continued)

			SIDE	STATUS	MODE	LEDs (A/B)	FAULT LED
5	Press CC1 A once to synch A to B. This is done so that currently logged on KBDs will not go offline whenever control is switched to the B-side.	CC1 A	A	Mstr	Sync	A On long	FAULT Off
			B	Slv	Sync	B On short	
6	Press and hold CC1 B for two beeps (forces B-side to Async mode; A-side is still online, but not synched).	CC1 B [2 beeps]	A		Online	A Off	FAULT Off
			B	Mstr	Async	B On solid	
7	Press KVD A button, so that diagnostic tools are available for the A-side update.	KVD A	A		Offline	A Off	FAULT Off
			B	Mstr	Async	B On solid	
8	"Ctrl + Q" keypad operation on A-side takes it offline. The diagnostic screen should be at the DOS prompt on the A-side.		A		Offline	A Off	FAULT Off
			B	Mstr	Async	B On solid	
9	Make changes on A-side. Update software, configuration files, etc. Power up. Press CC1 B once to synch B-side to A-side.	CC1 B	A	Slv	Sync	A On short	FAULT Off
			B	Mstr	Sync	B On long	
10	Press CC1 A to return to original starting point, if desired.	CC1 A	A	Mstr	Sync	A On long	FAULT Off

NOTE: Table E can also be applied (with slight modification, beginning with step 4) as a procedure for handling an equipment repair when a system error has occurred (system's FAULT LED ON, and node is in asynchronous mode). First, set DIP switch 1-2 to the OFF position so that diagnostic control reverts to the user, then, in Step 4, take the side that generated the error offline (if not already done). Next, acknowledge the alarm (to turn it off) and then, follow steps 5 and 6 of Table E, substituting the appropriate-side button presses (it depends on which side was initially taken offline), and then skip to Step 10.

SECTION 4.0: APPENDICES

INTRODUCTORY REMARKS

All appendices (except *Appendix 4.5*), focus on specific installation issues or various situations of interest to the user. Each deals with a separate aspect of integrating the current HS into the described system environment. For completeness, all possibilities of interest are listed here, although some of the topics have already been discussed thoroughly in the manual.

Appendix 4.5 extends the brief data cable parameter statement made in *Section 1.0 Introduction, 1.4 Subunit Highlights*. Additional items related to data port cable specifications are covered.

APPENDIX 4.1 HS ADDITION TO AN EXISTING CONFIGURATION (No Hot Switch Currently Installed)

Adding a hot switch to an existing system configuration that has no hot switch can increase the number of Sercom ports required beyond the obvious one-port increase needed when the hot switch is added. Issues associated with Sercom port requirements are discussed in the first section below. The second section deals with SEU port requirement issues based upon the final Sercom port population.

Sercom Port Requirements

The "final count" for the number of Sercom ports required (on each duplicate switch**) can vary depending upon your current system configuration (prior to adding a hot switch). At a minimum, the final Sercom port count will increase by one, as noted in the previous paragraph.

If an existing CC1 has two Sercom cards, and all 16 ports are used, then adding a hot switch will require the addition of another Sercom card. That means three Sercom cards are installed in each switch.

The number of Sercom ports required (starting from your current base count) increases by "one" for each of the following circumstances that apply:

- Addition of the hot switch = 1 port
- Connection to a network (NIU) = 1 port
If your standalone configuration is to become one of several nodes on a network, the connection to the NIU will require a Sercom port. If your configuration was already a node on a network, that port was included as part of your current base count.
- Access Control Device = 1 port
Any access control device, formerly connected to a CC1 COM port, must now be connected to a Sercom port on the CC1 unless you have utilized the COM 2 port option described in Figure 1-6 (see item [1] of *Appendix 4.2* for additional information).

If each circumstance above is applicable, the final Sercom port count will be three more than the starting base number. If the increase in Sercom ports required exceeds the number of ports available, it will be necessary to add another Sercom card to the 9700-CC1 (as well as to the duplicate switch).

** Keep in mind that an additional 9700-CC1 is required when a hot switch is added to a configuration. The added CC1 is configured as a duplicate backup of the current switch.

SEU Port Requirements

With one exception, the general statement can be made that one SEU port is needed to interface one Sercom port. The exception arises because all cabling from each Sercom port does not go to an equal number of SEU input ports. The one-port exception is the data line connection where the hot switch is attached to the CC1. The addition of the hot switch does use a Sercom port (port 5 on the CC1) on the CC1-side of the Sercom-SEU port interface. However, the data line coming from that connection does not go to an SEU port at all. Instead, it goes to a communication port on the CM9760-CCC subunit of the hot switch. The result is that the total number of SEU ports needed to interface the total number of Sercom ports on a switch is one less than the Sercom port "final count" (determined above).

NOTE: An interesting example occurs if you configure a basic CC1 that already utilizes 16 ports. The addition of a hot switch requires 16 + 1 or 17 Sercom ports, which, in turn, requires the addition of another Sercom card to the CC1. However, you still need only one SEU unit to interface this configuration (16 ports) as one of the 17 Sercom ports on the CC1-side is not reflected in the total number of ports required for duplication at the SEU-side. Under this unique circumstance, an additional SEU unit is not required.

Concluding Remarks

Other than considering port requirements for the CC1, the SEU, and related equipment items, a duplicate CC1 is necessary (already mentioned). Once all equipment requirements are met, cabling is installed according to the instructions in the manual. Likewise, identical configuration files are programmed and loaded onto the interfaced CC1 units. Once these items are taken care of, system power can be applied and the hot switch will, if configured for default, engage the system in A-side control (Master), B-side backup (Slave), synchronous-mode operation.

APPENDIX 4.2 HS UPDATE (Previous Model of Hot Switch Installed)

The previous model of the hot switch has existed for some time. Those acquainted with its operational characteristics know the uses and characteristics of a hot switch. This is an advantage, on one hand, compared to those not so acquainted. On the other hand, that advantage is somewhat eroded by the fact that there are some major differences involved in the hookup and use of the new HS. Ingrained familiarity with the previous model can lead to simple mistakes in installing and operating the current model.

To ease the transition process for those migrating to the current hot switch, Figure A4-1 highlights the connection similarities and differences between previous and current HS models.

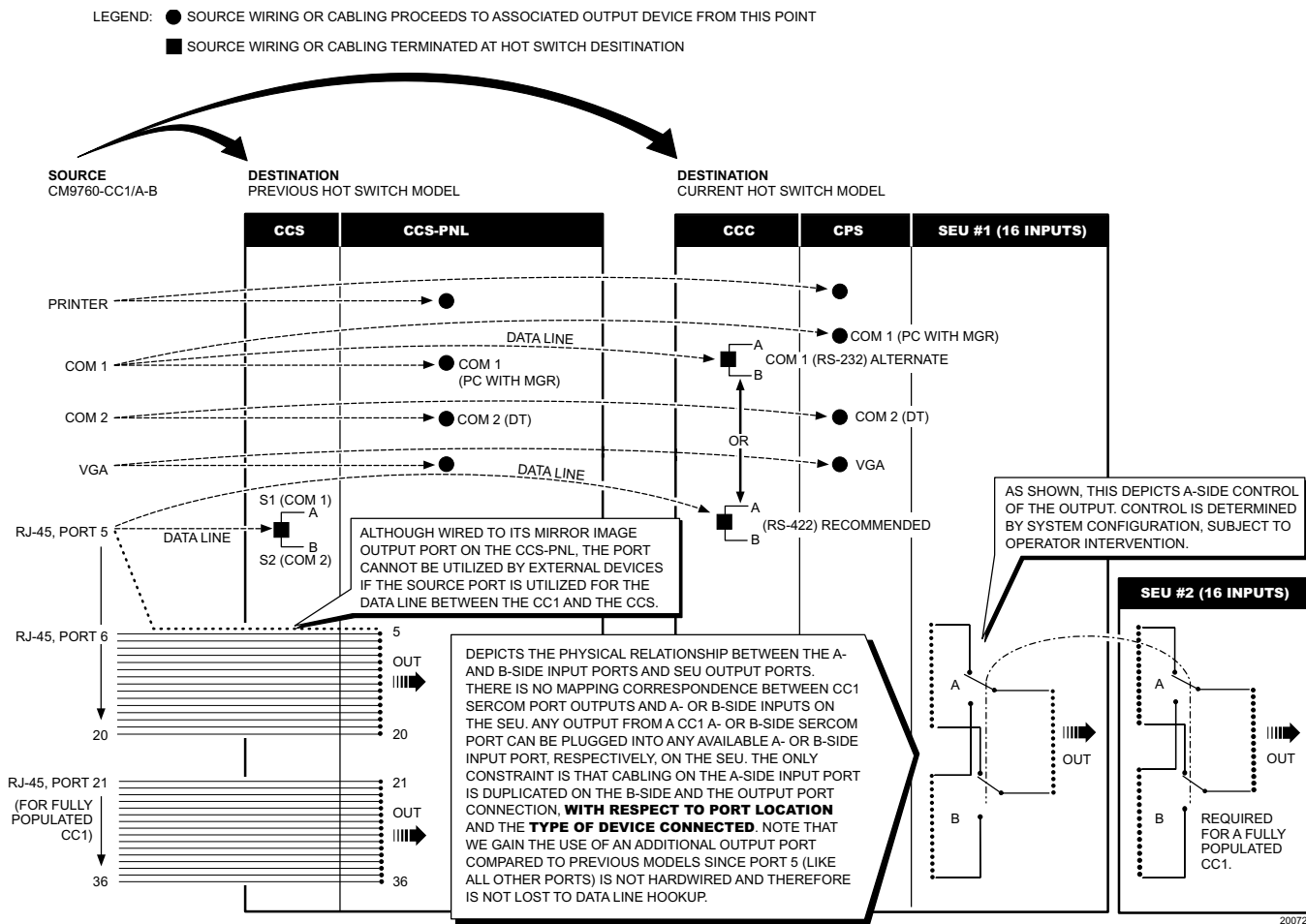

Figure A4-1. Hot Switch Comparison Summary

The intervening connections between CC1 Source and HS Destination outputs in the previous hot switch were implemented using a combination of specialized cabling and hardwired paths. This resulted in a more or less fixed relationship between the Source and Destination connections.

The Source and Destination relationships in the current hot switch are defined by the connection cabling alone. The result is a more flexible hot switch. This flexibility can be seen in Figure A4-1.

Even so, you can set up the Source-Destination relationships of the connectors for the current hot switch in the exact same manner as was done in the previous hot switch. This relationship equivalency can between the previous and current hot switch can be read off directly from Figure A4-1 for the current hot switch as follows:

VGA -----> VGA
PRINTER -----> PRINTER
RS-422 DATA LINE -----> RS-422 DATA LINE
COM 1 -----> COM 1 (PC W/MGR)
COM 2 -----> COM 2 (DT OR RS-232 ASCII DEVICE CONNECTION).

Figure A4-1 also highlight the two major differences between the current and previous hot switch:

1. COM Port Flexibility

The COM 1 and COM 2 Destination ports for the previous hot switch allowed for the connection of the PC w/MGR and, if desired, an ASCII Control Device interfaced via a Pelco DT, for example. The same relationship can be repeated in the current HS via the COM 1 and COM 2 Destination ports (located on the CPS) for the devices just mentioned, which are shown in Figure A4-1. Note that COM 1 is usually reserved for the connection of the PC w/MGR in the current HS. What is new is that the current HS allows an alternate choice (RS-232 instead of RS-422) for the Data Line connection between the Source COM ports and the CC1 (A & B) DB9 ports located in the CCC. This choice was not available for the previous hot switch.

If you make this choice, however, the COM 2 (DT) Destination connection located on the CPS and shown in Figure A4-1 cannot be used. This is because one of the Source COM ports must be available for the connection of the PC w/MGR. The choices available for COM 2 port use are covered in Figure 1-6.

2. Sercom Port Expansion

Six more SEUs (in addition to the two referenced in Figure A4-1) can be added by simply connecting them to the hot switch common bus. This generously allows for any future expansion of Sercom port use.

APPENDIX 4.3 HS UPDATE (Current Model Hot Switch Installed)

The steps described in Table E of the manual contain the general procedure to follow when updating the hardware and/or software of an existing hot switch configuration. The following comments supplement the information found there:

1. The "NOTE" located at the end of Table E identifies the steps in the table to follow as a general procedure in case of a failure of one or the other CC1.
2. Be mindful of the considerations raised in Appendix 4.1. Is the node environment changing from single to multi-node? Are other equipment changes being made that affect configuration files or equipment cabling?
3. Once satisfied that the impact of all changes are accounted for, then the side under repair or update can be powered up.
4. It should be noted that it is possible to update one side of a hot switch configuration at a time without bringing the entire system down.

APPENDIX 4.4 HS AND NETWORK-INTERFACED CONFIGURATIONS

Below are node-specific connections of NIU configurations, where each node is hot-switched. Note the following points, which are also reflected in Figure A4-2:

1. Each CC1 port connection to the HS (on its respective node) stays at port 5 (standalone configuration) while the NIU connection (via the SEU) is connected to port 6 on each CC1.
2. The port 6 Sercom connection of the NIU from each CC1 node (in ascending node order) is attached to the system NIU (in ascending node order), starting at NIU Sercom-port 5. It arrives there via routing through the SEU, as shown in Figure A4-2.
3. Each node, with respect to the HS, is essentially independent of the NIU. That is, any node, at any time, can be taken off the network without bringing the network down. Node-specific procedures, such as those described in this manual, can be performed without affecting NIU operation. It should be noted, however, that the PC w/MGR, along with the diagnostic keyboard and monitor are normally connected to the "NIU" CC1. This means that available diagnostic screen information is less informative than that available when the diagnostic peripherals are attached directly to the node in question.

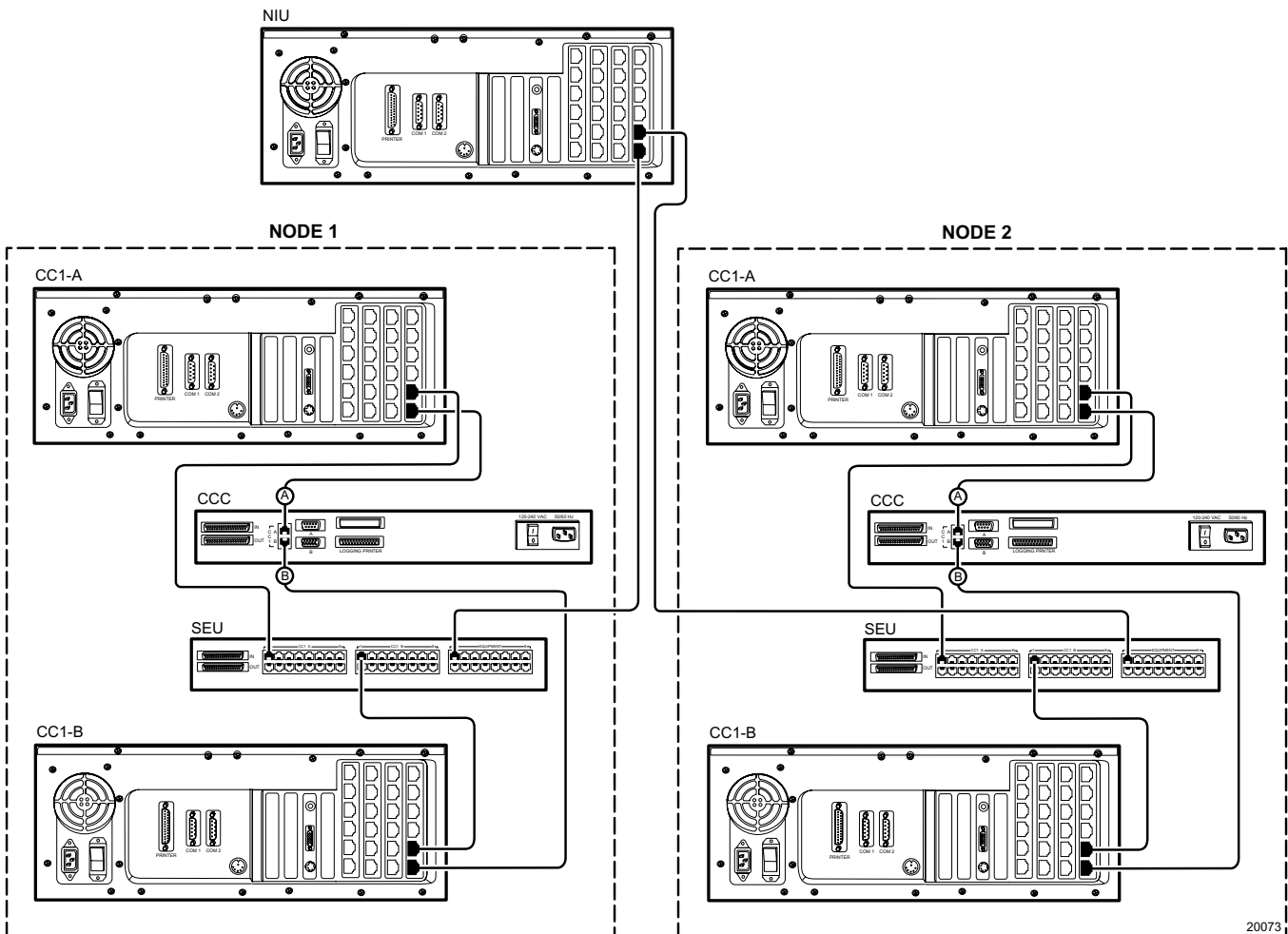

Figure A4-2. HS-NIU Connections

Interfacing network nodes with a hot switch (illustrated in Figure A4-2) can be extended to include the NIU itself. Figure A4-3 keeps the same node structure shown in Figure A4-2, except that now a hot switch interfaces the NIU. Note that the equipment numbers for hot switches contained in the respective port definition files for the NIU and the Nodes themselves are different. These are equipment numbers chosen for that specific configuration in order to differentiate between a hot switch hooked to a controlling Network NIU from one connected to a regular node (interfacing CC1s) within a network.

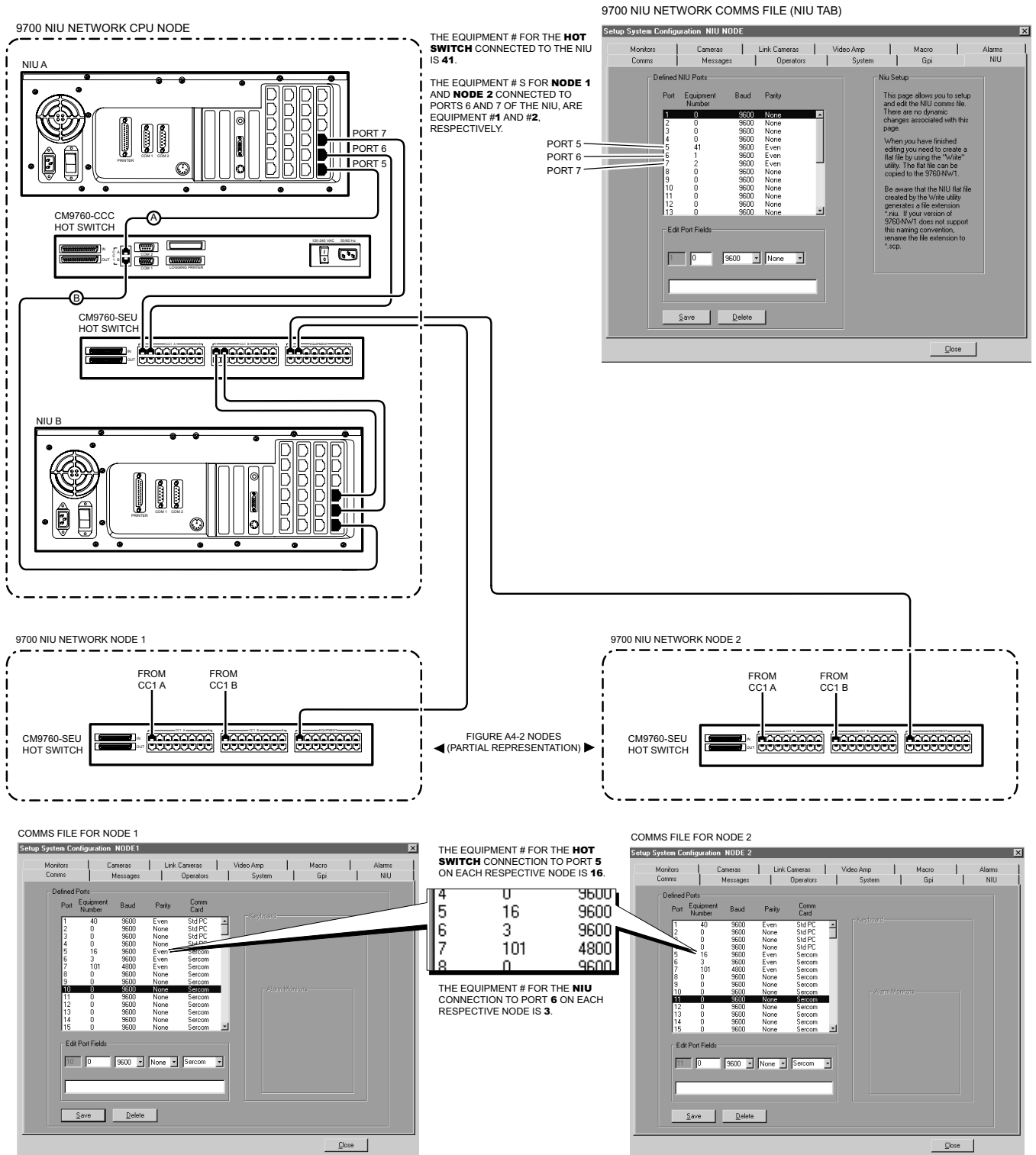

Figure A4-3. Hot Switch Interfaced NIU

APPENDIX 4.5 DATA CABLE PARAMETERS

NOTE: For short distances that exceed the cable length supplied, you might consider the use of CAT 5 cable (for distances up to 300 feet). This cable is RS-422 compliant (up to the length mentioned) and is used primarily for Ethernet connections within networks. Moreover, it is readily available (because of demand) and cost is reasonable (because it is less difficult to manufacture).

Figure A4-4 INFORMATION BOX

BPS or bps means =
bits per second

Baud =
of signal changes per second

In the recent past, bps and baud rate were equivalent, that is, 300 bps and 300 baud, for example, were the same. Two things happened which eventually separated the use of bps and baud as being equal.

1. It became physically possible to transmit more than one bit per signal change through variations in amplitude, frequency, and/or phase.
2. A physical bandwidth limit on voice-grade phone lines made it difficult to reach baud rates greater than 2400. Almost all modems do not operate at a speed greater than this.

Therefore, a modem operating at a Pelco referenced baud rate of 9600 is, most likely, a 2400 baud modem operating at 9600 bps (or a 4:1 compression ratio or $4 \times 2400 = 9600$) because of the bps manipulation mentioned above. Therefore, for higher speed modems and for the chart illustrated in Figure A4-4, modem speeds are normally listed and referenced at a bps rate. For convenience, Pelco refers to modem speeds in all its communication parameter lists, by using the term baud rate (a misnomer), even though the numerical portion of the reference is actually in "bps". In Figure A4-4 the approximate baud rate range of Pelco equipment is highlighted against the bps per distance chart.

Data communication **cables** are used in the CM9760 system to connect required equipment to appropriate data communication ports on the CC1, which are RS-232 or RS-422 driven.

The characteristics of the cable chosen (if not supplied) depends, first of all, on the driver type it interfaces.

- For RS-232 driven ports, such as COM 1 and COM 2 found on the CM9700-CC1, the cable used must meet less stringent communication requirements than that required for RS-422 driven ports. The cable must support for RS-232 communications must support the following driver characteristics:
 1. It is single ended – one driver and one receiver.
 2. It is unbalanced-a voltage level with respect to system ground drives the communications link.
 3. It is limited to low data rates.
 4. It is limited to local use: 50 feet or less for synchronized data; 100 to 200 feet for asynchronous data.
- For RS-422 driven ports, such as the 32 Sercom ports on the rear of the CC1, the cable chosen by the user must support the following driver characteristics:
 1. It is single ended, multi-drop capable.
 2. It is balanced-a differential voltage drives the communications link.
 3. It handles relatively high data rates. There is a trade off between data rate and cable length (theoretically, up to 4,000 feet [1,220 m] @ 100Kbps) (see Figure A4-6).

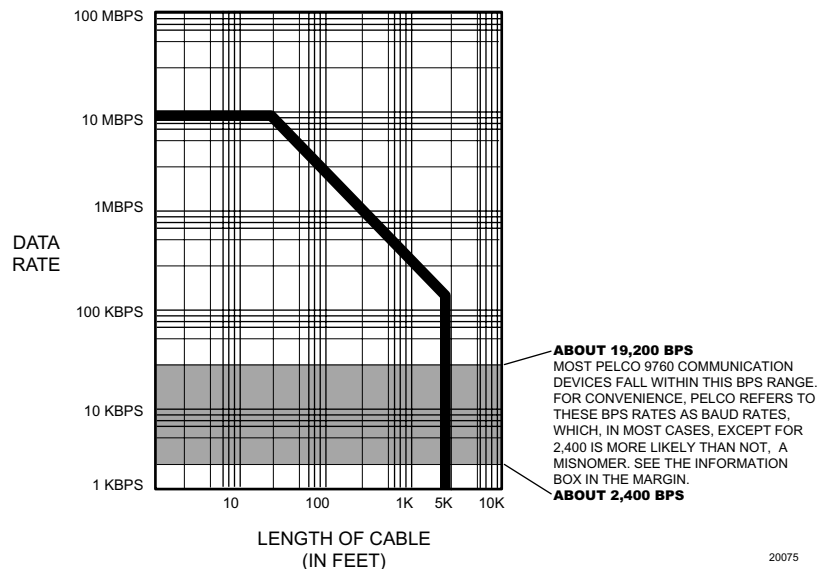

Figure A4-4. Data Rate vs. Cable Length

4. It is used for both local and remote hookup of system devices; for example, remote hookup of 9760 keyboards attached to the CC1.

Most of the time, connection cables are supplied with the device. As long as the supplied cable is appropriate, no problem arises. If the cable length needed is greater than that supplied, a problem arises for the installer/specifier as to the type of cable to use. One of the most common hookup extensions is the example already referred to: the remote hookup of a 9760 keyboard. The following highlights the issues involved and ends with some recommendations.

Remote Hookup of the CM9760-KBD

The 9760 keyboard comes with associated cables and a CM9505UPS (universal power supply) to supply the 12V needed to power the keyboard. The standard hookup for the keyboard to the matrix switch (CC1) is shown in Figure A4-5.

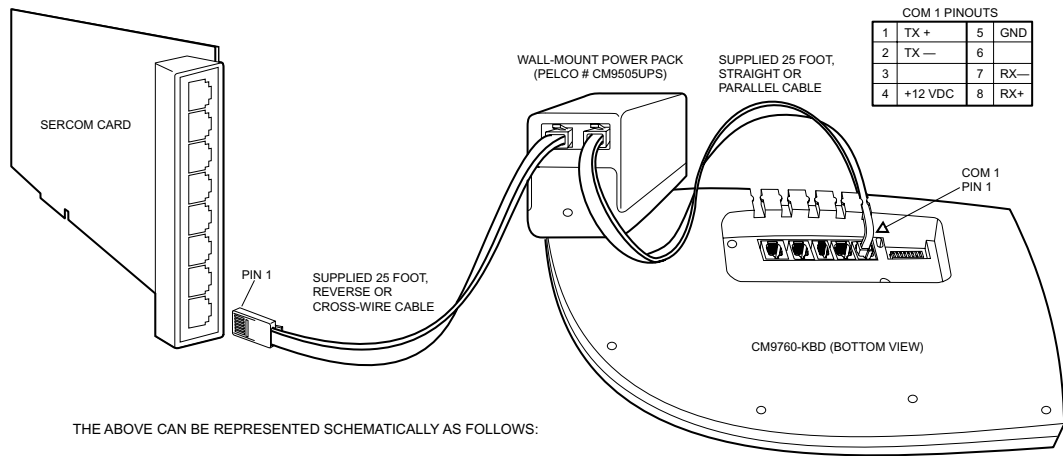

THE ABOVE CAN BE REPRESENTED SCHEMATICALLY AS FOLLOWS:

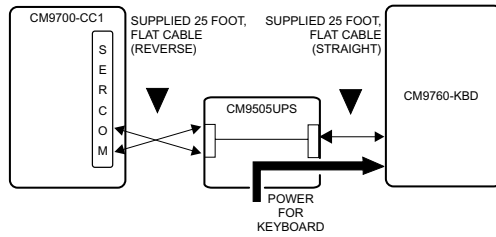
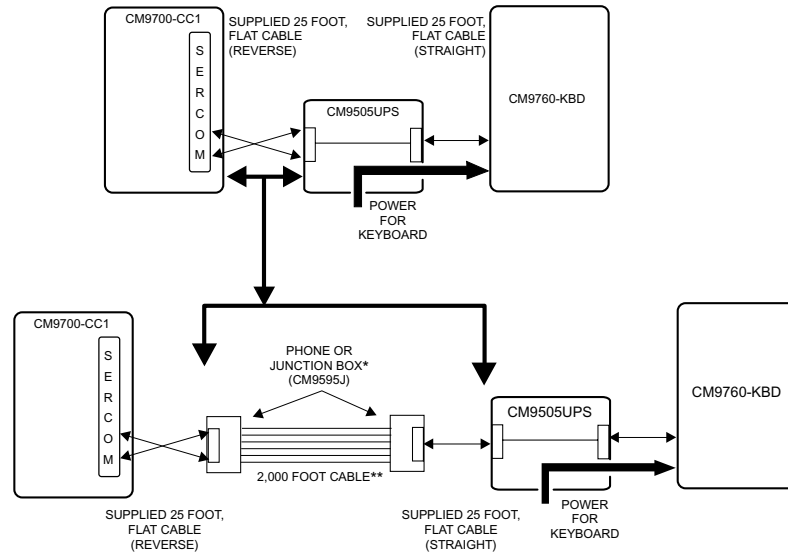

Figure A4-5. Keyboard (Local Hookup)

For remote installation of the keyboard, the user must supply a cable of appropriate length that supports the TIA/EIA-422-B (RS-422) communication standard. The example in Figure A4-6 shows a keyboard placed 2,000 feet (610 m) from the CC1 via the user-supplied cable. Junction boxes (phone boxes) are used to facilitate the RJ-45-to-cable connection points at either end of the run. Note that only signal wires and ground are run through the cable itself (five of the six available wires are used in the example). The transformer serves to pass on the data signal and to supply power to the keyboard at the keyboard end.



** RECOMMENDED CABLE:
BELDEN 9843 OR SIMILAR CABLE THAT SUPPORTS
THE TIA/EIA-422-B (RS-422) STANDARD.
THE CHARACTERISTICS OF THIS CABLE ARE
GIVEN IN TABLE A4-A.

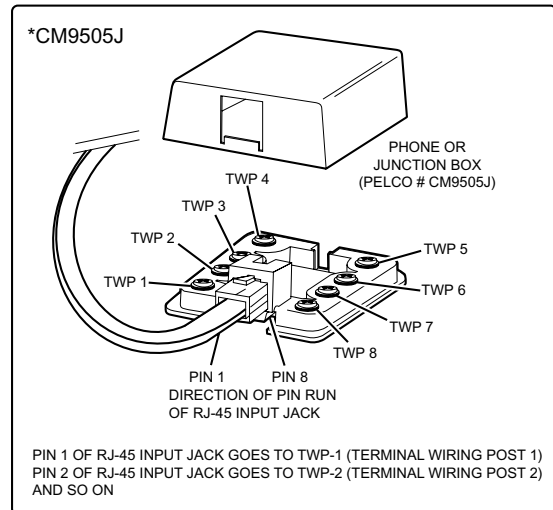
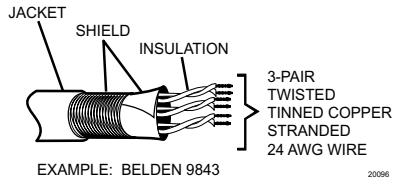

Figure A4-6. Remote Wiring a CM9760-KBD

Although the communication link can be as far away as 4,000 feet (1,220 m) (per Figure A4-4), this is theoretical and Pelco recommends that for distances greater than 2,000 feet (610 m) a CM9505UPS-422 power supply with data repeater be used.

In either case, Pelco recommends using a cable similar to Belden 9843, that meets or exceeds the support requirements for TIA/EIA-422 applications. Table A4-A is taken directly from the FULL TECHNICAL SPECS page in Belden's Cable Catalog located on their company web site.

Table A4-A. (TIA/EIA-422*) Cable Example



9843

AWG	STRANDED	TYPE	INSULATION
24	(7 X 32)	TC – Tinned Copper	PE – Polyethylene
SHIELD	JACKET	# PAIR	# TRIADS
Aluminum Foil-Polyester Tape/Braid Shield	PVC – Polyvinyl Chloride	3	0

NOMINAL OD (in.)	INSULATION THICKNESS (in.)	JACKET THICKNESS	NOMINAL CAPACITANCE (pF/ft)	NOMINAL CONDUCTOR DCR (/M')	NOMINAL VELOCITY OF PROPAGATION (%)	NOMINAL IMPEDANCE (ohms)
.3600	.00000	.0000	12.800	24.000	66.0	120.0

* TIA/EIA-422-B is the full name of the current standard for what is commonly referred to as RS-422. The prefix "RS", which stands for "recommended standard", was used by the EIA (Electronic Industries Association) as the name for some of its standards. The "RS-" prefix was dropped by the EIA in 1986 and standards were simply referred to with the EIA- prefix. In 1988 TIA (Telecommunication Industries Association) was a working group of the EIA and the reference evolved to a combined EIA/TIA- prefix. When TIA became ANSI (American National Standards Institute) accredited, the acronym order was reversed to TIA/EIA-. In 1992 TIA spun off from EIA and merged with US Telecommunications Suppliers Association (USTSA). From about that time to the present, the full standard has been referenced as ANSI/TIA/EIA-422-B, where "B" is the latest revision of the standard. Normally the standard is written simply as TIA/EIA-422. In all probability, that will be shortened to just TIA-422, at some point in the future. However, everyone has used the "RS-" prefix reference for so long that it may be some time before its use disappears, if at all.

SECTION 5.0: GENERAL

5.1 SPECIFICATIONS

MODELS

CM9760-HS (consists of three subunits)	Computer Changeover System-hot switch interface unit for redundant system backup
CM9760-CCC:	Computer Changeover Control
CM9760-CPS:	Computer Peripheral Switch
CM9760-SEU:	Serial Expansion Unit

ELECTRICAL

CM9760-HS	
CM9760-CCC	
Input Voltage:	120 - 240 VAC (auto-switching, euro-plug supplied)
Power:	10W
Fusing	2A, fast acting
Power Indicator:	LED, green
CM9760-CPS	
Power Indicator:	LED, green
CM9760-SEU	
Power Indicator:	LED, green

PORTS

CM9760-CCC	
Input (data):	Two (Side-A and Side-B) RS-422, RJ-45 connectors (female) DIP switch selectable baud rate and communication type Two (Side-A and Side-B) RS-232, DB9 connectors (female) DIP switch selectable baud rate and communication type
Common Bus:	Two (one IN, one OUT), DB37 connectors (female)
Keyboard:	One DB25 (male), capped, not used
Logging Printer:	One DB25 (female)

CM9760-CPS	
Common Bus:	Two (one IN, one OUT), DB37 connectors (female)
Input (Side-A):	One mini-DIN, 5-pin connector One DB9, COM 1 connector (male) One DB15, VGA connector (female) One DB25 printer connector (female) One DB25 COM 2 connector (male) or One DB9 COM 2 connector (male) (if DB25 to DB9 adapter is used)
Input (Side-B):	Same configuration as Side-A, input
Output:	Same configuration as Side-A, input

CM9760-SEU	
Common Bus:	Two (one IN, one OUT), DB37 connectors (female)
Input (Side-A):	16, RJ-45 connectors (female)
Input (Side-B):	Same as Side-A configuration
Output:	Same as Side-A configuration

MECHANICAL

Connectors

CM9760-CCC	
Power:	3-wire, # 18 AWG
RJ-45:	Two, female
DB9:	Two, female
DB25:	Two, one male (capped, not used); one female
DB37:	Two, both female
CM9760-CPS	
Mini-DIN, 5-pine:	Three, female
DB9:	Three, male
DB15:	Three, female
DB25:	Six, three male; three female
DB37:	Two, both female
CM9760-SEU	
RJ-45:	48, all female
DB37:	Two, both female

GENERAL

CM9760-HS

Operating Temperature:	32° to 122°F (0° to 50°C)
Construction:	Aluminum
Finish:	Black, polyester powder coat
Mounting (each subunit):	Fits 19-inch (48.26 cm) EIA standard rack
	1 RU
Dimensions (all units):	1.73 (H) x 19.0 (W) x 7.923 (D) inches (4.39 x 48.26 x 20.124 cm) (See Figure 5-1)
Unit Weight	
CM9760-CCC:	5.8 lb (2.63 kg)
CM9760-CPS:	5.3 lb (2.40 kg)
CM9760-SEU:	5.2 lb (2.36 kg)

OPTIONAL ACCESSORIES

Additional SEU units may be added to the HS (up to eight total)

CM9760-SEU Includes:	One, SEU unit, boxed
Cables:	One DB37 cable 32, 8-conductor, RJ-45, flat cables, 3 ft (0.9 m) each

(Design and product specifications subject to change without notice.)

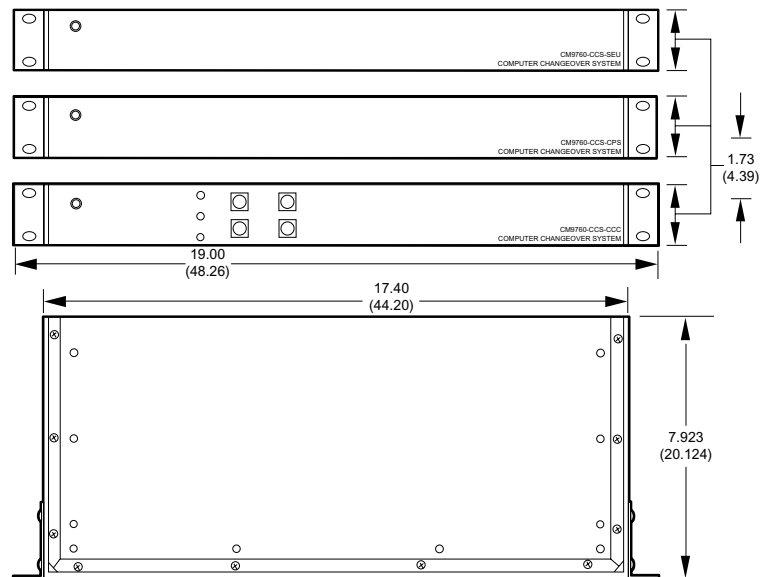

NOTE: VALUES IN PARENTHESES ARE CENTIMETERS;
ALL OTHERS ARE IN INCHES.

20083

Figure 5-1. CM9760-HS Dimension Drawing

5.2 SEU CONNECTION TEMPLATE

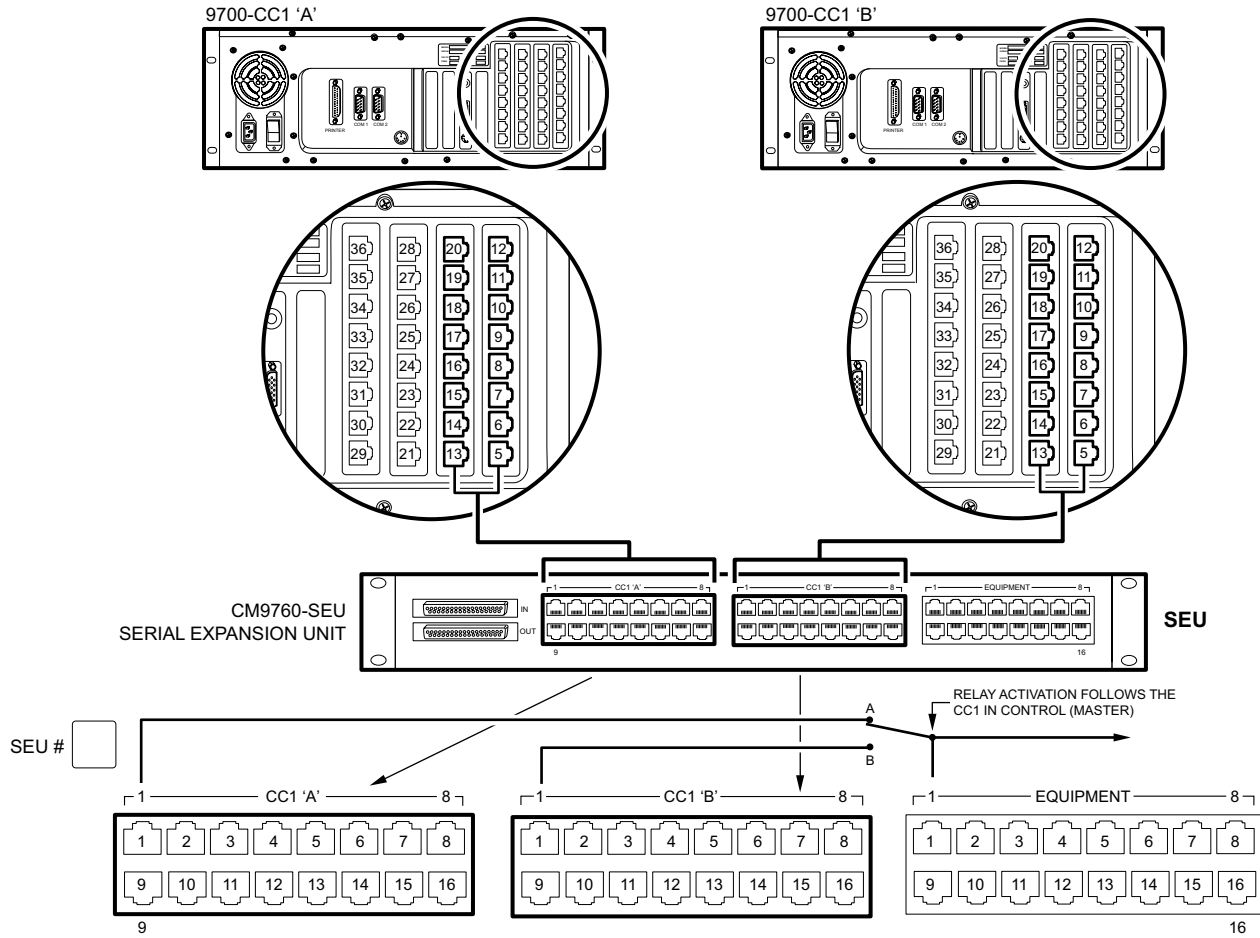

CC1 A CC1 B (9700 SERCOM)	CC1 'A' CC1 'B' (SEU)	EQUIPMENT PORT (SEU)	EQUIPMENT DESCRIPTION
	1	1	
	2	2	
	3	3	
	4	4	
	5	5	
	6	6	
	7	7	
	8	8	
	9	9	
	10	10	
	11	11	
	12	12	
	13	13	
	14	14	
	15	15	
	16	16	

PRODUCT WARRANTY AND RETURN INFORMATION

WARRANTY

Pelco will repair or replace, without charge, any merchandise proved defective in material or workmanship **for a period of one year** after the date of shipment.

Exceptions to this warranty are as noted below:

- Five years on FR/FT/FS Series fiber optic products and TW3000 Series unshielded twisted pair transmission products.
- Three years on Genex® Series products (multiplexers, server, and keyboard).
- Three years on Camclosure® and fixed camera models, except the CC3701H-2, CC3701H-2X, CC3751H-2, CC3651H-2X, MC3651H-2, and MC3651H-2X camera models, which have a five-year warranty.
- Three years on PMCL200/300/400 Series LCD monitors.
- Two years on standard motorized or fixed focal length lenses.
- Two years on Legacy®, CM6700/CM6800/CM9700 Series matrix, and DF5/DF8 Series fixed dome products.
- Two years on Spectra®, Esprit®, ExSite™, and PS20 scanners, including when used in continuous motion applications.
- Two years on Esprit® and WW5700 Series window wiper (excluding wiper blades).
- Two years (except lamp and color wheel) on Digital Light Processing (DLP®) displays. The lamp and color wheel will be covered for a period of 90 days. The air filter is not covered under warranty.
- Eighteen months on DX Series digital video recorders, NVR300 Series network video recorders, and Endura™ Series distributed network-based video products.
- One year (except video heads) on video cassette recorders (VCRs). Video heads will be covered for a period of six months.
- Six months on all pan and tilts, scanners or preset lenses used in continuous motion applications (that is, preset scan, tour and auto scan modes).

Pelco will warrant all replacement parts and repairs for 90 days from the date of Pelco shipment. All goods requiring warranty repair shall be sent freight prepaid to Pelco, Clovis, California. Repairs made necessary by reason of misuse, alteration, normal wear, or accident are not covered under this warranty.

Pelco assumes no risk and shall be subject to no liability for damages or loss resulting from the specific use or application made of the Products. Pelco's liability for any claim, whether based on breach of contract, negligence, infringement of any rights of any party or product liability, relating to the Products shall not exceed the price paid by the Dealer to Pelco for such Products. In no event will Pelco be liable for any special, incidental or consequential damages (including loss of use, loss of profit and claims of third parties) however caused, whether by the negligence of Pelco or otherwise.

The above warranty provides the Dealer with specific legal rights. The Dealer may also have additional rights, which are subject to variation from state to state.

If a warranty repair is required, the Dealer must contact Pelco at (800) 289-9100 or (559) 292-1981 to obtain a Repair Authorization number (RA), and provide the following information:

1. Model and serial number
2. Date of shipment, P.O. number, Sales Order number, or Pelco invoice number
3. Details of the defect or problem

If there is a dispute regarding the warranty of a product which does not fall under the warranty conditions stated above, please include a written explanation with the product when returned.

Method of return shipment shall be the same or equal to the method by which the item was received by Pelco.

RETURNS

In order to expedite parts returned to the factory for repair or credit, please call the factory at (800) 289-9100 or (559) 292-1981 to obtain an authorization number (CA number if returned for credit, and RA number if returned for repair).

All merchandise returned for credit may be subject to a 20% restocking and refurbishing charge.

Goods returned for repair or credit should be clearly identified with the assigned CA or RA number and freight should be prepaid. Ship to the appropriate address below.

If you are located within the continental U.S., Alaska, Hawaii or Puerto Rico, send goods to:

Service Department
Pelco
3500 Pelco Way
Clovis, CA 93612-5699

If you are located outside the continental U.S., Alaska, Hawaii or Puerto Rico and are instructed to return goods to the USA, you may do one of the following:

If the goods are to be sent by a COURIER SERVICE, send the goods to:

Pelco
3500 Pelco Way
Clovis, CA 93612-5699 USA

If the goods are to be sent by a FREIGHT FORWARDER, send the goods to:

Pelco c/o Expeditors
473 Eccles Avenue
South San Francisco, CA 94080 USA
Phone: 650-737-1700
Fax: 650-737-0933

 The materials used in the manufacture of this document and its components are compliant to the requirements of Directive 2002/95/EC.



This equipment contains electrical or electronic components that must be recycled properly to comply with Directive 2002/96/EC of the European Union regarding the disposal of waste electrical and electronic equipment (WEEE). Contact your local dealer for procedures for recycling this equipment.

REVISION HISTORY

Manual #	Date	Comments
C578M	1/02	Original version.
C578M-A	4/05	Added master/slave wiring information for SEU subunit. Changed CM9760-CC1 references to CM9700-CC1. Revised Figure 2-3 and Specifications to change data SEU cable length from 10 feet to 3 feet per ECO 05-10902.

Pelco, the Pelco logo, Spectra, Esprit, Camclosure, Genex, Legacy, and System 9760 are registered trademarks of Pelco.
Endura and ExSite are trademarks of Pelco.
DLP is a registered trademark of Texas Instruments, Inc.

© Copyright 2005, Pelco
All rights reserved.



Worldwide Headquarters
3500 Pelco Way
Clovis, California 93612 USA

USA & Canada
Tel: 800/289-9100
Fax: 800/289-9150

International
Tel: 1-559/292-1981
Fax: 1-559/348-1120

www.pelco.com

ISO9001

United States | Canada | United Kingdom | The Netherlands | Singapore | Spain | Scandinavia | France | Middle East

Free Manuals Download Website

<http://myh66.com>

<http://usermanuals.us>

<http://www.somanuals.com>

<http://www.4manuals.cc>

<http://www.manual-lib.com>

<http://www.404manual.com>

<http://www.luxmanual.com>

<http://aubethermostatmanual.com>

Golf course search by state

<http://golfingnear.com>

Email search by domain

<http://emailbydomain.com>

Auto manuals search

<http://auto.somanuals.com>

TV manuals search

<http://tv.somanuals.com>