

**TLR2168S
Time-Lapse VCR**

**Installation/
Operation Manual**

C649M (7/99)

Pelco • 3500 Pelco Way, Clovis • CA 93612-5699 USA • www.pelco.com
In North America and Canada: Tel (800) 289-9100 or FAX (800) 289-9150
International Customers: Tel (1-559) 292-1981 or FAX (1-559) 348-1120

CONTENTS

Section	Page
1.0 GENERAL	5
1.1 SAFEGUARDS, WARNINGS, CAUTION, AND CARE	6
1.2 REGULATORY NOTICES	8
1.3 UNPACKING INSTRUCTIONS	8
2.0 OVERVIEW	9
2.1 INTRODUCTION TO TIME-LAPSE RECORDERS	9
2.2 TLR2168S FEATURES AND FUNCTIONS	9
3.0 QUICK START	11
3.1 BASIC START	11
3.2 ADDITIONAL ITEMS	11
4.0 INSTALLATION	12
4.1 PRE-INSTALLATION CAUTIONS	12
4.1.1 Securing the VCR Controls	12
4.1.2 Monitor Tips	12
4.2 INSTALLATION	12
4.3 CONNECTING THE VCR TO A MULTIPLEXER	14
5.0 CONTROLS	15
5.1 FRONT PANEL	15
5.2 FLUORESCENT DISPLAY	16
5.3 REAR PANEL	17
6.0 PROGRAMMING	19
6.1 GENERAL PROGRAMMING INSTRUCTIONS	19
6.2 QUICK GUIDE TO TLR2168S MENU STRUCTURE	20
6.3 MAIN MENU	21
6.4 DISPLAY MENU	21
6.4.1 Display Mode	21
6.4.2 Time Date Size	21
6.4.3 Background Color (Blue Back)	21
6.5 TIME DATE SEARCH MENU	22
6.6 TIMER PROGRAM MENU	23
6.7 RECORDING SET UP MENU	23
6.8 REAR TERMINAL MENU	24
6.9 MAINTENANCE MENU	25
6.10 FIRST TIME SET UP MENU	26
6.10.1 Day and Time Display Modes	27
6.10.2 Set the Day and Time	28
7.0 LOADING/UNLOADING/PROTECTING THE TAPE CASSETTE	30
7.1 LOADING	30
7.2 UNLOADING	30
7.3 PREVENTING ACCIDENTAL ERASURE	30
8.0 RECORDING	31
8.1 MANUAL RECORDING	31
8.1.1 Recording Mode	32
8.1.2 Record Check Function	32
8.1.3 Audio Recording	32
8.1.4 Repeat Recording	32
8.1.4.1 Number of Tape Uses	33
8.1.4.2 Recommended Number of Tape Uses	33
8.1.5 Series Recording	34
8.1.6 One-Shot/Interval Recording	34
8.1.7 Synchronous Recording	35

<u>Section</u>	<u>Page</u>
8.2	TIMER RECORDING 36
8.2.1	Programming Procedure 36
8.2.2	Special DW Settings 36
8.2.3	Avoid Mistakes When Using the Timer 37
8.3	ALARM RECORDING 37
8.3.1	Alarm Recording Connection 38
8.3.2	External Time Clock Adjustment 38
8.3.3	Programming For Alarm Recording 39
8.3.4	Emergency Recording 40
8.3.5	Alarm Record Time Display 40
8.3.5.1	Reset The Alarm Recording List 40
8.4	RECORDING AFTER A POWER FAILURE 40
9.0	PLAYBACK 41
9.1	PLAYBACK PROCEDURE 41
9.1.1	Playback Mode 42
9.1.2	Audio Playback 42
9.1.3	End Of Tape 42
9.2	SPECIAL EFFECTS PLAYBACK 42
9.2.1	Shuttle Ring 43
9.2.2	Direct Shuttle Ring 43
9.2.3	Still Picture 44
9.2.4	Frame-by-Frame Playback 44
9.3	LOCATING THE START OF ALARM RECORDINGS 44
9.3.1	Index Search 44
9.3.2	Skip Search 45
9.4	ADJUSTMENT DURING PLAYBACK 45
9.4.1	Tracking Adjustment 45
9.4.2	Picture Quality Adjustment 46
9.4.3	Vertical Adjustment 46
10.0	ADDITIONAL FUNCTIONS AND FEATURES 47
10.1	COUNTER 47
10.1.1	Counter Memory 47
10.1.2	Tape Counter 47
10.1.3	Counter Reset 47
10.2	MEMORY BACKUP IN CASE OF POWER FAILURE 47
10.3	POWER FAILURE TIME DISPLAY 47
10.4	ELAPSED TIME DISPLAY 48
11.0	TESTING 49
11.1	INITIAL SYSTEM TESTING 49
11.2	REGULAR SYSTEM TESTING 49
12.0	TROUBLESHOOTING 50
12.1	SELF-DIAGNOSTIC FUNCTION AND WARNING DISPLAY 50
12.2	BEFORE CALLING FOR SERVICE 51
13.0	SPECIFICATIONS 52
14.0	WARRANTY AND RETURN INFORMATION 56

LIST OF ILLUSTRATIONS



<u>Figure</u>	<u>Page</u>
1	Typical System Setup 13
2	Connecting VCR To Multiplexer 14
3	Front View 15
4	Fluorescent Display 16
5	Rear View 17
6	Not Used
7	Menu Tree 20
8	Main Menu 21
9	Display Menu 21
10	Time Date Search Menu 22
11	Timer Program Illustration 23
12	Recording Set Up Menu 23
13	Rear Terminal Menu 24
14	Maintenance Menu 25
15	First Time Set Up Menu 26
16	Display Mode 1 27
17	Display Mode 2 27
18	Manual Recording Steps 31
19	Connecting VCRs in Series 34
20	Synchronous Recording Sequence 35
21	Connection for Synchronous Recording 35
22	Switching From Normal To Alarm Mode And Back 37
23	Alarm Recording Connection 38
24	Time Clock Adjustment Connection 38
25	Playback Controls 41
26	SHUTTLE Ring Speed Settings 43
27	Direct SHUTTLE Ring Speed Settings 43
28	Index Searching 44
29	Skip Searching 45
30	Tracking Adjustment 45
31	Picture Quality Adjustment 46
32	Vertical Picture Adjustment 46

LIST OF TABLES

<u>Table</u>	<u>Page</u>
A	Not Used
B	Call Out/Tape End 24
C	Recording Times in Hours 32
D	When Tape End is Reached 32
E	Recommended Number of Tape Uses 33
F	Numbers of VCRs and Cameras 36
G	Timer Recording Troubleshooting 37
H	Audio Playback Availability 42
I	End of Tape Actions 42
J	Warning Display and Actions 50

REVISION HISTORY

<u>Manual #</u>	<u>Date</u>	<u>Comments</u>
C649M	6/99	Original version.
	7/99	Removed material on the optional remote control.

	WARNING RISK OF ELECTRIC SHOCK DO NOT OPEN	
<p>WARNING: TO REDUCE THE RISK OF ELECTRIC SHOCK DO NOT REMOVE COVER (OR BACK) NO USER-SERVICEABLE PARTS INSIDE REFER SERVICING TO QUALIFIED SERVICE PERSONNEL.</p>		

	AVERTISSEMENT DANGER D'ÉLECTROCUTION NE PAS OUVRIR	
<p>AVERTISSEMENT: POUR ÉLIMINER TOUT RISQUE D'ÉLECTROCUTION, NE PAS OUVRIR LE COUVERCLE (OU LA PARTIE ARRIÈRE). AUCUNE PIÈCE RÉPARABLE PAR L'UTILISATEUR NE SE TROUVE À L'INTÉRIEUR. POUR TOUTE INTERVENTION D'ENTRETIEN OU DE RÉPARATION SE CONFIER AUX TECHNICIENS QUALIFIÉS.</p>		



The lightning flash with arrowhead symbol, within an equilateral triangle, is intended to alert the user to the presence of uninsulated dangerous voltage within the product's enclosure that may be of sufficient magnitude to constitute a risk of electric shock.



La flèche symbolisant l'éclair dans un triangle équilatéral a pour objet de tirer l'attention de l'utilisateur sur le fait, qu'il y a des tensions dangereuses non-isolées à l'intérieur de l'enceinte du produit qui peuvent être suffisamment importantes pour conduire au risque d'électrocution.



The exclamation point within an equilateral triangle is intended to alert the user to the presence of important operating and maintenance (servicing) instructions in the literature accompanying the equipment.



Le point d'exclamation au sein d'un triangle équilatéral a pour objet de tirer l'attention de l'utilisateur sur le fait qu'il y a des instructions de mise en service et d'entretien (de réparation) dans les fiches descriptives de l'appareil qui doivent obligatoirement être respectées.

AVERTISSEMENT:

WARNING:
TO PREVENT FIRE OR SHOCK HAZARD, DO NOT EXPOSE THIS EQUIPMENT TO RAIN OR MOISTURE.

CAUTION:
TO PREVENT ELECTRIC SHOCK DO NOT USE THE POLARIZED PLUG WITH AN EXTENSION CORD, RECEPTACLE OR OTHER OUTLET UNLESS THE BLADES CAN BE FULLY INSERTED TO PREVENT BLADE EXPOSURE.

AFIN D'ÉVITER TOUT RISQUE D'INCENDIE OU D'ÉLECTROCUTION, NE PAS EXPOSER CET APPAREIL À LA PLUIE NI À L'HUMIDITÉ.

ATTENTION:
POUR PRÉVENIR LES CHOCS ÉLECTRIQUES NE PAS UTILISER CETTE FICHE POLARISÉE AVEC UN PROLONGATEUR, UNE PRISE DE COURANT OU UNE AUTRE SORTIE DE COURANT, SAUF SI LES LAMES PEUVENT ÊTRE INSÉRÉES À FOND SANS EN LAISSER AUCUNE PARTIE À DÉCOUVERT.

1.1 SAFEGUARDS, WARNINGS, CAUTION, AND CARE

Observe the following WARNINGS before installing and using this product. Follow all warnings and instructions marked on the VCR.

Instructions

Read all the safety and operating instructions before operating the VCR. Keep the instructions for future reference. Follow all operating and use instructions. Heed all warnings on the equipment and in the operating instructions.

Installation/Serviceing

Installation and servicing should be done by qualified service personnel only and conform to all local codes. Do not try to service this VCR yourself. Opening or removing covers may expose you to dangerous voltage or other hazards.

Damage Requiring Service

Unplug the VCR from the wall outlet and refer servicing to qualified service personnel under the following conditions:

1. When the power cord or plug is damaged.
2. If liquid has been spilled, or objects have fallen into the VCR.
3. If the VCR does not operate normally when following the operating instructions.

Adjust only those controls covered by the operating instructions. Improper adjustment of other controls may cause damage and will often require extensive work by a qualified technician to restore the VCR to normal operation.

4. If the VCR was dropped or the cabinet damaged.
5. When the VCR shows a distinct change in performance—this indicates a need for service.

Replacement Parts

Be sure the service technician uses only replacement parts Pelco recommends, or which have the same characteristics as the original part. Unauthorized substitutions may cause fire, electric shock, or other hazards.

Safety Check

Upon completion of any service or repair to the VCR, ask the service technician to perform safety checks to determine whether it is in safe operating condition.

Water/Moisture/Condensation

Do not use this VCR near water. It is designed for indoor use only and must not be installed where exposed to rain and moisture.

Do not place objects containing water, such as drinks, on top of the VCR.

If the VCR is exposed to a rapid increase in temperature (such as warming a cold room or after moving it from a cold location to a warm one), condensation may form on the tape transport mechanism inside the VCR. To prevent damage to the VCR or tapes, plug the VCR into the AC outlet and turn the power on for about two hours. Do not play back or record on the VCR during this time.

Condensation is likely to occur when:

1. The VCR is moved from a cold room to a warm room or from outdoors to indoors.
2. A cold room is heated quickly.
3. The humidity is very high.

Avoid using the VCR where cold air (such as from an air conditioner) will blow directly on it.



WARNING: *The included power cord is used for 120 VAC, 60 Hz. Never connect to any outlet or power supply having a different voltage or frequency.*

Cleaning

Unplug the VCR from the wall outlet before cleaning. Do not use liquid or aerosol cleaners. Clean with a soft cloth slightly moistened with mild detergent and water. Wipe dry. NEVER USE PETROLEUM-BASED SOLUTIONS.

Attachments

Do not use attachments not recommended by Pelco as they may cause hazards.

Accessories

Do not place the VCR on an unstable cart, stand, tripod, bracket, or table. The VCR may fall, seriously injuring a person or damaging the equipment. Use only with a cart, stand, tripod, bracket, or table recommended by Pelco, or sold with the VCR. Follow Pelco's instructions when mounting equipment, and use a mounting accessory recommended by Pelco.

Use care when moving equipment on a cart. Quick stops, excessive force, and uneven surfaces may overturn the VCR and cart combination.

Do Not Place Anything Heavy On The VCR

Heavy objects placed on the VCR will cause damage.

Ventilation

Slots and openings in the cabinet provide ventilation and ensure reliable operation of the VCR and protect it from overheating. Do not block or cover these openings. Never place the VCR near or over a radiator or heat register. Do not place it in a built-in installation such as a rack unless proper ventilation is provided or Pelco's instructions have been followed. There are many ventilation holes on the bottom of the VCR—for maximum ventilation, place it on a hard level surface only.

Power Sources

Operate this VCR only from the type of power source indicated on the marking label. If you are unsure of the type of power supply, consult your equipment dealer or local power company.

Grounding or Polarization

This VCR is equipped with a three-wire grounding-type plug—a plug having a third (grounding) pin. This plug only fits into a grounding-type outlet. This is a safety feature. If you cannot insert the plug into the outlet, contact an electrician to replace the obsolete outlet. Do not defeat the safety purpose of the grounding-type plug.

Power Cord Protection

Do not damage the power cord; it may cause fire or shock hazard. Route the power cord so it is not likely to be walked on or pinched by items placed on or against it. Pay particular attention to the cord at the wall plug or convenience receptacle and the point where it connects to the VCR. When unplugging the power cord, grasp the plug and remove it carefully.

Lightning/Power Surges

Unplug the VCR from the wall outlet for its added protection during a lightning storm or when it is unused for long periods. This prevents damage to the VCR from lightning and power line surges. Pelco recommends using conditioned-output uninterruptible power supplies (UPS) and/or surge protected outlets to maximize protection of the VCR.

When Not In Use

When you finish operating the VCR, always unload the cassette and turn off the power.

Overloading

Do not overload wall outlets and extension cords as this increases the risk of fire and electric shock.

Object and Liquid Entry

Never push objects of any kind into the VCR through openings. They may touch dangerous voltage points or short out parts that could result in a fire or electric shock. It can also cause extensive damage to the mechanism. Never spill liquid of any kind on the VCR.

Care Of Video Cassette Tape

1. Avoid violent vibration or shock.
2. Do not place near a strong magnetic field (near a motor, transformer, or magnet).
3. Never place or store in direct sunlight.
4. Avoid dusty places.
5. Place the cassette in the cassette case and store vertically.
6. Never store tapes in a high humidity location.

1.2 REGULATORY NOTICES

NOTE: This equipment has been tested and found to comply with the limits of a Class B digital device, pursuant to part 15 of the FCC rules. These limits are designed to provide reasonable protection against harmful interference in a residential installation. This equipment generates, uses, and can radiate radio frequency energy and, if not installed and used in accordance with the instructions, may cause harmful interference to radio communications. However there is no guarantee that the interference will not occur in a particular installation. If this equipment does cause harmful interference to radio or television reception, which can be determined by turning the equipment off and on, the user is encouraged to try and correct the interference by one or more of the following measures:

- Reorient or relocate the receiving antenna.
- Increase the separation between the equipment and the receiver.
- Connect the equipment into an outlet on a circuit different from that to which the receiver is connected.
- Consult the dealer or an experienced radio/TV technician for help.

Changes or modifications not expressly approved by the party responsible for compliance could void the user's authority to operate the equipment.

INFORMATION

This Class B digital apparatus meets all requirements of the Canadian Interference Causing Equipment Regulations.

INFORMATION

Cet appareil numérique de la classe B respecte toutes les exigences du Règlement sur le matériel brouilleur du Canada.

1.3 UNPACKING INSTRUCTIONS

Unpack and inspect all parts carefully.

Be sure to save the shipping carton, boxes and inserts. They are the safest material in which to make future shipments.

If an item appears to have been damaged in shipment, replace it properly in its box and contact the factory at 1-800-289-9100 or 1-559-292-1981 for a replacement. (International customers fax 1-559-348-1120 for authorization and instructions.)

If an item needs to be returned to the factory for repair, consult the WARRANTY AND RETURN section of this manual for instructions.

2.1 INTRODUCTION TO TIME-LAPSE RECORDERS

Time-lapse recording permits longer than ordinary recording times. The primary reason for using time-lapse recording in a CCTV security system is that a single VCR tape can be used for an extended period of time beyond the standard recording time. The following explains how time-lapse recording works.

The actual recording on VCRs is a series of still pictures or fields. Standard consumer VHS recorders store 60 fields (30 frames) per second. A T-120 cassette lasts just two hours in this mode (SP mode). You can get slightly longer recording times (six hours) using the extended recording mode (EP mode). You can record even longer on a T-160 cassette in these modes: two hours and 40 minutes in SP mode and eight hours in EP mode. (Refer to the table in Section 8.1.1 for actual recording times in different modes.)

Time-lapse VCRs, however, use microprocessor-based techniques to record fewer fields per second than a normal VHS machine and extend recording time. This negates the need to change the tape every two hours—and also substantially reduces viewing time when the recording is played back, another important consideration.

In normal VCR operation, all video head scans (60 per second) are recorded. But in time-lapse mode the tape runs more slowly and records pictures periodically. In 12-hour mode, a normal time-lapse machine records 10 fields per second, and in 24-hour mode, it stores just five fields per second (for up to 12 and 24 hours on a tape, respectively). Longer times are possible by slowing the recording rate further.

At normal speed a picture is recorded every 1/60 of a second so there is little change over five frames. In longer time-lapse modes, however, a field is recorded intermittently over a longer period of time so changes are apparent from field to field.

The time-lapse recording can be played back at normal two-hour tape speed, which makes for rapid review—one of the time-lapse recorder's most important advantages. Action on the tape, however, appears faster than normal.

As an advanced feature, time-lapse recorders (like the TLR2168S) can automatically switch from time-lapse to real-time recording when an alarm condition occurs. This is important since the primary purpose of recording an event is identification, and real-time recording provides more detail.

2.2 TLR2168S FEATURES AND FUNCTIONS

The TLR2168S time-lapse video recorder is a powerful surveillance tool designed for industrial and security recording. In addition to ordinary two-hour (SP – standard play) and six-hour (EP – extended play) recording modes, its time-lapse modes permit recording of 18, 24, 48, 72, 96, 120, or 168 hours. (Linear modes are designated as L18H and L24H.) You can extend recording up to 64,800 hours (for T-120 tape) using one-shot recording with a three-minute time interval. The TLR2168S features frame-by-frame playback and high-speed playback of longer recordings. It is a six-head machine that can play back tapes recorded on virtually any VCR.

Audio Recording—Audio recorded in 2H, 6H, or L(inear)18H, L24H mode is played back only in its respective mode.

Resolution And Image Quality—This VCR has a high-quality circuit allowing more than 330 lines in B/W (black and white) recording and more than 300 lines in color recording in normal VHS mode. S-VHS ET and S-VHS mode resolution is even higher at more than 400 lines.

S-VHS Mode—This mode has higher resolution and picture quality than normal VHS mode when using S-VHS tape (over 400 lines).

S-VHS ET Mode—This mode, using VHS tape, has picture quality closer to S-VHS recording (over 400 lines).

High Density Recording - H-D<EP>—High density recording records three times more fields than normal density (SP). It reduces the time interval between pictures and makes for smoother time-lapse recording.

Tape Remaining Indicator—A bar indicator shows how much tape is left and/or that the tape has approximately three minutes (in 2H mode) left.

Automatic Head Cleaning—The VCR automatically removes foreign matter from the heads when a cassette is inserted for continuous smooth operation.

Easy Setup Using A Monitor—The on-screen menus simplify setup programming. You can select these menus even without inputting a video signal.

Easy Cueing With Alarm Recording—Index signals are automatically added at the beginning of alarm recording for easy cueing. You can confirm alarm starting time in the playback video on the monitor or in the alarm list on the Maintenance menu.

Time And Date Search System—You can search for a specific hour/minute and date to accurately locate an image on tape.

External Time Clock Adjustment—You can reset the on-screen clock to the nearest hour by applying a signal to the RST (reset) IN terminal at the rear of the VCR.

Record Check—You can confirm correct recording by pressing the PLAY button during recording.

Automatic Head Azimuth Selection—The VCR can automatically select playback heads for normal VHS-compatible time-lapse recordings, or older time-lapse recordings made using two same-azimuth video heads. Same-azimuth time-lapse recordings use VHS cassettes but cannot be played normally by VHS-compatible VCRs.

Special Playback Features—These include still images, speed search, reverse playback, frame-by-frame viewing in both directions, slow-motion, and high-speed viewing.

JOG Dial/SHUTTLE Ring—You can use these controls to search for the desired image. You can adjust the playback speed with the SHUTTLE ring and search for an image frame-by-frame with the JOG dial.

Recording Options—This versatile system offers a variety of recording options, including daily and weekly timer recording, repeat, and alarm recording.

Protection Against Power Failures—Recording data (including date, time, and timer setup) is stored in backup memory, so the system can resume recording after a power failure. The monitor displays the time of the failure.

Digital <ELAPSED TIME> Display—The elapsed time of recording and playback is stored in non-volatile memory. You can use the elapsed time display as a guide to when to do periodic maintenance.

Tape Use Counter—This counter displays how many times you have recorded on a tape. This helps you decide when you need to replace a tape.

Daylight Saving Time Setting—A daylight saving time setting is available. You can set the clock forward an hour by programming the menu.

NOTE: The battery backup is for memory only—the VCR does not continue recording if the power goes out. If you want to keep recording during an outage, make sure the VCR system is on your UPS (uninterruptible power supply) system.

3.1 BASIC START

NOTE: This section is intended for people experienced in working with time-lapse recorders and installing CCTV systems.

1. Decide where to locate the VCR. Do all system hookups first (camera, multiplexer, etc.) if you are installing the VCR in a location where you cannot access its rear panel.
2. Connect the VCR to other equipment (Sections 4.2 and 4.3).
3. Plug in the VCR and press the POWER button. You should see the time and date displayed on the monitor.
4. To reset the time/date (First Time Set Up menu), see Section 6.10.2. Skip if you do not want to reset the time/date.
5. Put in a T-120, T-160, ST-120, or ST-160 tape. Refer to Table C for recording times. Set the appropriate tape length if you want the approximate tape remaining indicator to work correctly (Section 6.10). If not, skip.
6. Set the S-VHS switch to on or off.
7. Put the VCR in the recording mode you want by pressing the REC/PLAY (+) and (-) buttons. Watch the fluorescent display. Set to 2H, L24H, 48H – 168H, or 0H mode for recording at SP speed. Set to 6H, L18H, 48H – 168H, or 0H for EP speed.
8. Press REC to begin recording.
9. Press STOP to stop. Turn the SHUTTLE ring right to fast forward and left to rewind. Press PLAY to play back the tape.
10. Refer to Section 11.1 for initial system testing information.

3.2 ADDITIONAL ITEMS

You can also incorporate the following programming steps for more than a basic quick setup.

1. If desired, set the tape end, quasi v-sync, playback head select, and buzzer options (Section 6.10) on the First Time Set Up menu.
2. If desired, set the display mode and time/date size options (Section 6.4) in the Display menu.
3. If desired, in the Timer Program menu (Section 6.6), program for timer recording (Section 8.2).
4. If desired, in the Recording Set Up menu (Section 6.7), program for alarm recording mode and duration (Section 8.3.3), emergency recording (Section 8.3.4), and one-shot recording (Section 8.1.6).
5. If desired, in the Rear Terminal menu (Section 6.8), program for call out (Section 8.1.5 for series recording), clock out (Section 8.1.7 for synchronous recording), operation of the mode out terminal, and operation mode of the REC IN terminal.

4.0 INSTALLATION

4.1 PRE-INSTALLATION CAUTIONS

1. Provide secure power to system components. Prevent overloading or shorting by dedicating power circuits to the surveillance equipment. Restrict access to the surveillance system circuit breakers, switches, and equipment power cords.
2. Surveillance system components must be operationally compatible. Time-lapse recording speeds and dwell times of any accessory switching equipment must be compatible with each other.
3. The TLR2168S time-lapse VCR provides several alarm recording speeds so it is important that alarm triggering of components be operationally compatible. Refer to Section 2.1 for information on time-lapse recording.
4. Complete all system hookups (camera, multiplexer, etc.) before installing the VCR in a location where you cannot access its rear panel.

4.1.1 Securing the VCR Controls

Protect surveillance equipment to forestall tampering. We recommend putting the recorder in a secure VCR cabinet. Pelco offers such units—the RM2000, which is a rack kit for a single VCR, and the RM2004, which is a rack kit for four VCRs.

4.1.2 Monitor Tips

- Pelco recommends using a CCTV monitor.
- Some monitors may cause picture vibration or picture distortion at the top or bottom of the image during still or normal playback. (Refer to Section 9.4.3 for information.)

A television may be unable to provide a stable picture without vibration or distortion.

4.2 INSTALLATION

1. Remove the VCR and all cables from the box.
2. Place the VCR in a suitable location.
 - If the location is unsecured, refer to Section 4.1.1 for information about products to lock up the VCR.
 - Do all system hookups (camera, multiplexer, etc.) before installing the VCR in a location where you cannot access its rear panel,
3. If installing in a rack, place the VCR in the rack before making cable and power connections. Refer to the documentation included with the rack kit for specific installation instructions.
4. If you are not using a switcher, refer to Figure 1.
 - Connect the camera (video output) to the rear of the VCR (video input BNC). Connect the VCR (video output BNC) to the monitor (video input).
 - Connect the alarm input to the VCR (SET IN and GND [ground] terminals).
 - If you are using a 600 Ω microphone, connect it to the VCR (MIC IN jack). Connect the VCR (audio output connector) to the monitor (audio input).
5. If you are using a switcher, refer to Section 4.3.

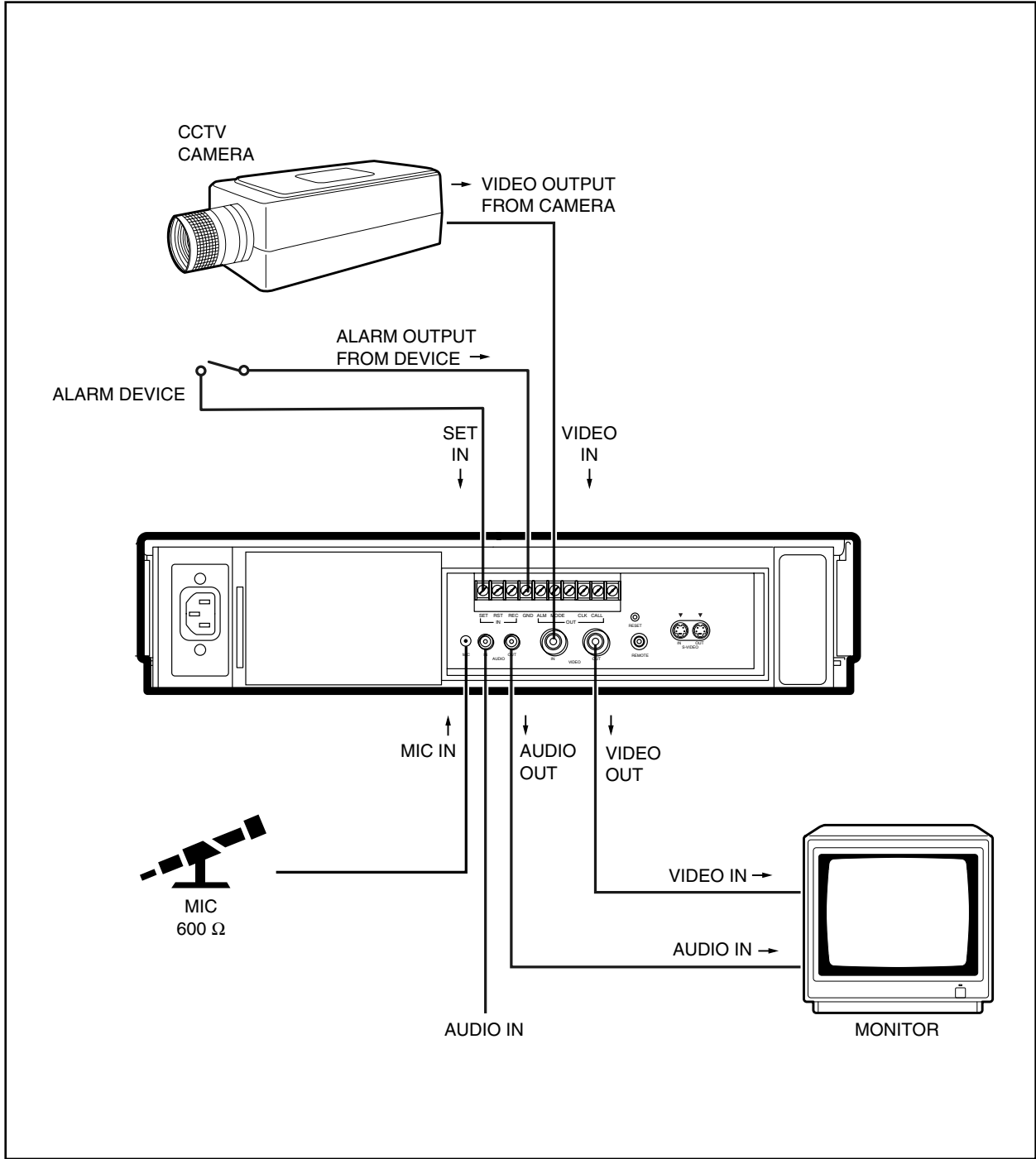

Figure 1. Typical System Setup

4.3 CONNECTING THE VCR TO A MULTIPLEXER

Figure 2 shows how to connect the VCR to an MX4000 Series Genex™ Multiplexer.

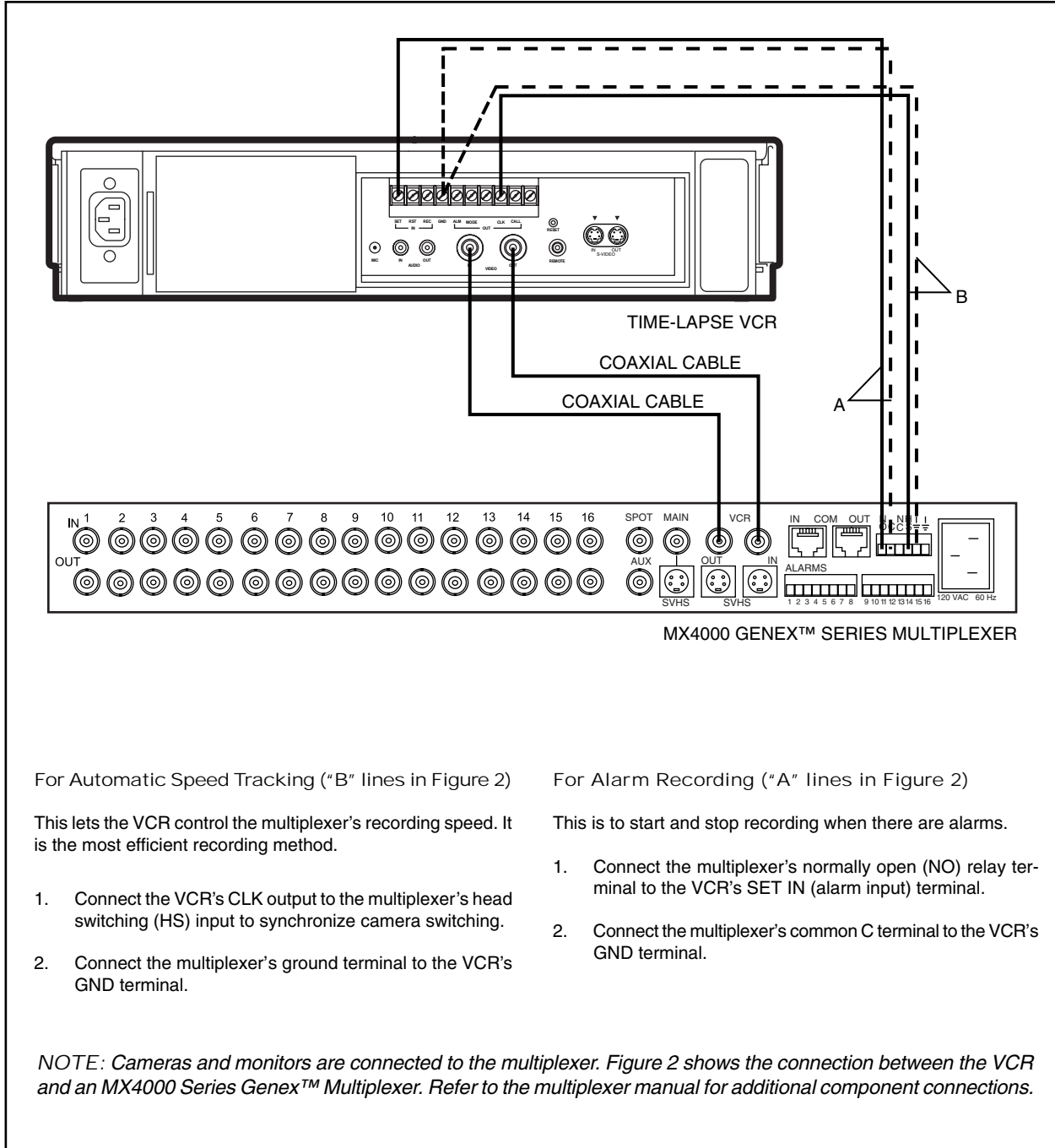
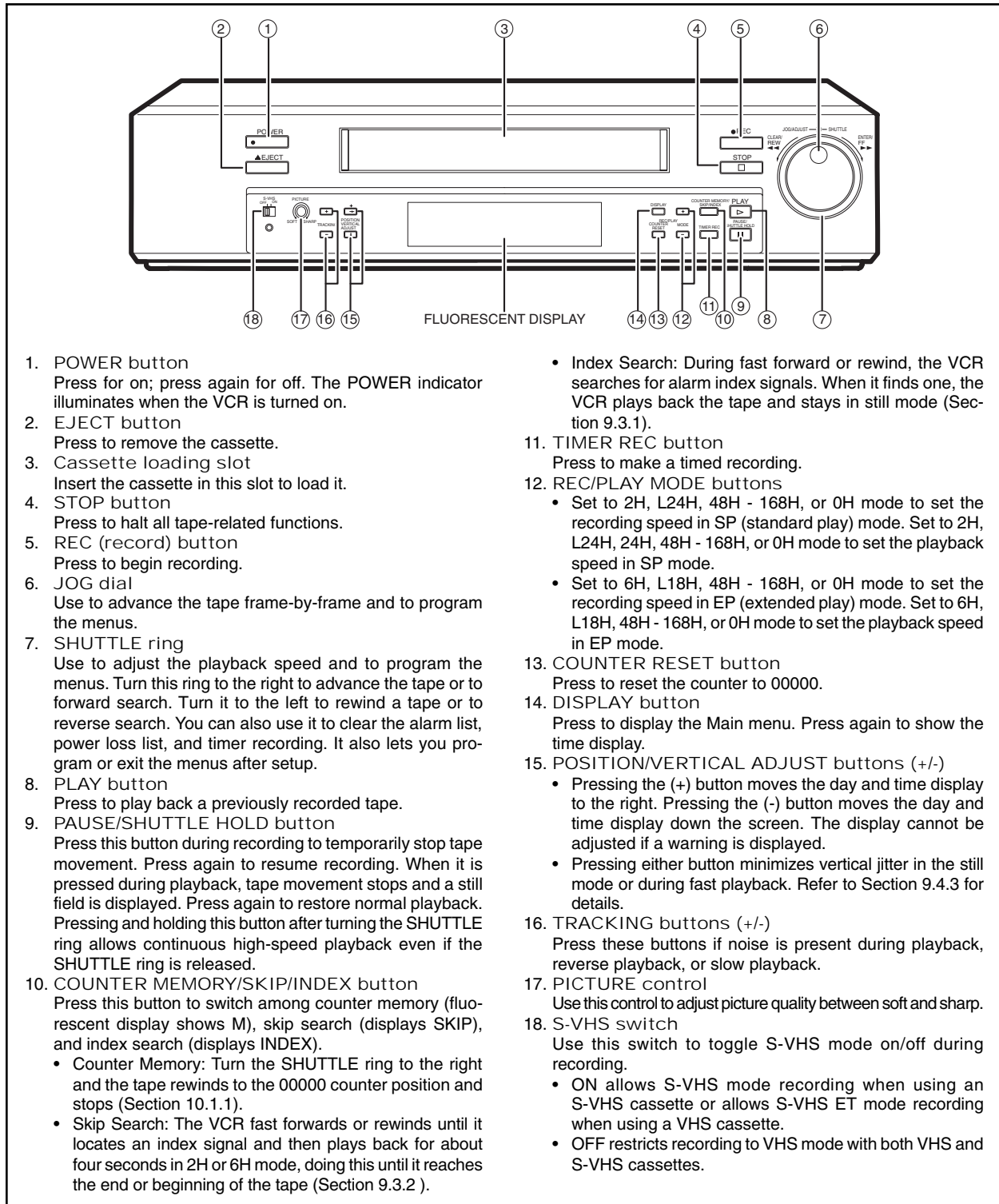

Figure 2. Connecting VCR To Multiplexer

5.1 FRONT PANEL



1. **POWER button**
Press for on; press again for off. The POWER indicator illuminates when the VCR is turned on.
2. **EJECT button**
Press to remove the cassette.
3. **Cassette loading slot**
Insert the cassette in this slot to load it.
4. **STOP button**
Press to halt all tape-related functions.
5. **REC (record) button**
Press to begin recording.
6. **JOG dial**
Use to advance the tape frame-by-frame and to program the menus.
7. **SHUTTLE ring**
Use to adjust the playback speed and to program the menus. Turn this ring to the right to advance the tape or to forward search. Turn it to the left to rewind a tape or to reverse search. You can also use it to clear the alarm list, power loss list, and timer recording. It also lets you program or exit the menus after setup.
8. **PLAY button**
Press to play back a previously recorded tape.
9. **PAUSE/SHUTTLE HOLD button**
Press this button during recording to temporarily stop tape movement. Press again to resume recording. When it is pressed during playback, tape movement stops and a still field is displayed. Press again to restore normal playback. Pressing and holding this button after turning the SHUTTLE ring allows continuous high-speed playback even if the SHUTTLE ring is released.
10. **COUNTER MEMORY/SKIP/INDEX button**
Press this button to switch among counter memory (fluorescent display shows M), skip search (displays SKIP), and index search (displays INDEX).
 - Counter Memory: Turn the SHUTTLE ring to the right and the tape rewinds to the 00000 counter position and stops (Section 10.1.1).
 - Skip Search: The VCR fast forwards or rewinds until it locates an index signal and then plays back for about four seconds in 2H or 6H mode, doing this until it reaches the end or beginning of the tape (Section 9.3.2).
 - Index Search: During fast forward or rewind, the VCR searches for alarm index signals. When it finds one, the VCR plays back the tape and stays in still mode (Section 9.3.1).
11. **TIMER REC button**
Press to make a timed recording.
12. **REC/PLAY MODE buttons**
 - Set to 2H, L24H, 48H - 168H, or 0H mode to set the recording speed in SP (standard play) mode. Set to 2H, L24H, 24H, 48H - 168H, or 0H mode to set the playback speed in SP mode.
 - Set to 6H, L18H, 48H - 168H, or 0H mode to set the recording speed in EP (extended play) mode. Set to 6H, L18H, 48H - 168H, or 0H mode to set the playback speed in EP mode.
13. **COUNTER RESET button**
Press to reset the counter to 00000.
14. **DISPLAY button**
Press to display the Main menu. Press again to show the time display.
15. **POSITION/VERTICAL ADJUST buttons (+/-)**
 - Pressing the (+) button moves the day and time display to the right. Pressing the (-) button moves the day and time display down the screen. The display cannot be adjusted if a warning is displayed.
 - Pressing either button minimizes vertical jitter in the still mode or during fast playback. Refer to Section 9.4.3 for details.
16. **TRACKING buttons (+/-)**
Press these buttons if noise is present during playback, reverse playback, or slow playback.
17. **PICTURE control**
Use this control to adjust picture quality between soft and sharp.
18. **S-VHS switch**
Use this switch to toggle S-VHS mode on/off during recording.
 - ON allows S-VHS mode recording when using an S-VHS cassette or allows S-VHS ET mode recording when using a VHS cassette.
 - OFF restricts recording to VHS mode with both VHS and S-VHS cassettes.

Figure 3. Front View

5.2 FLUORESCENT DISPLAY

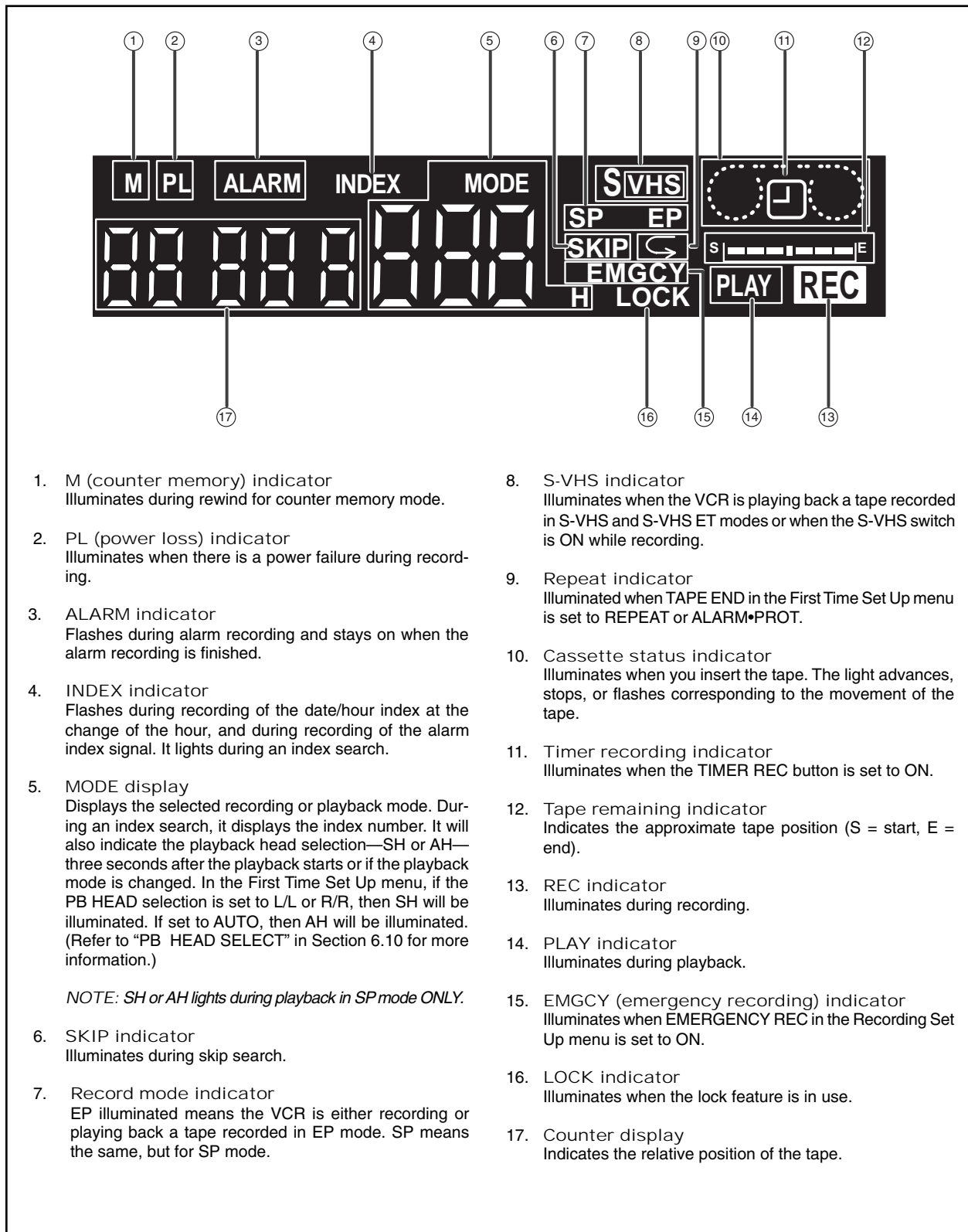

Figure 4. Fluorescent Display

5.3 REAR PANEL

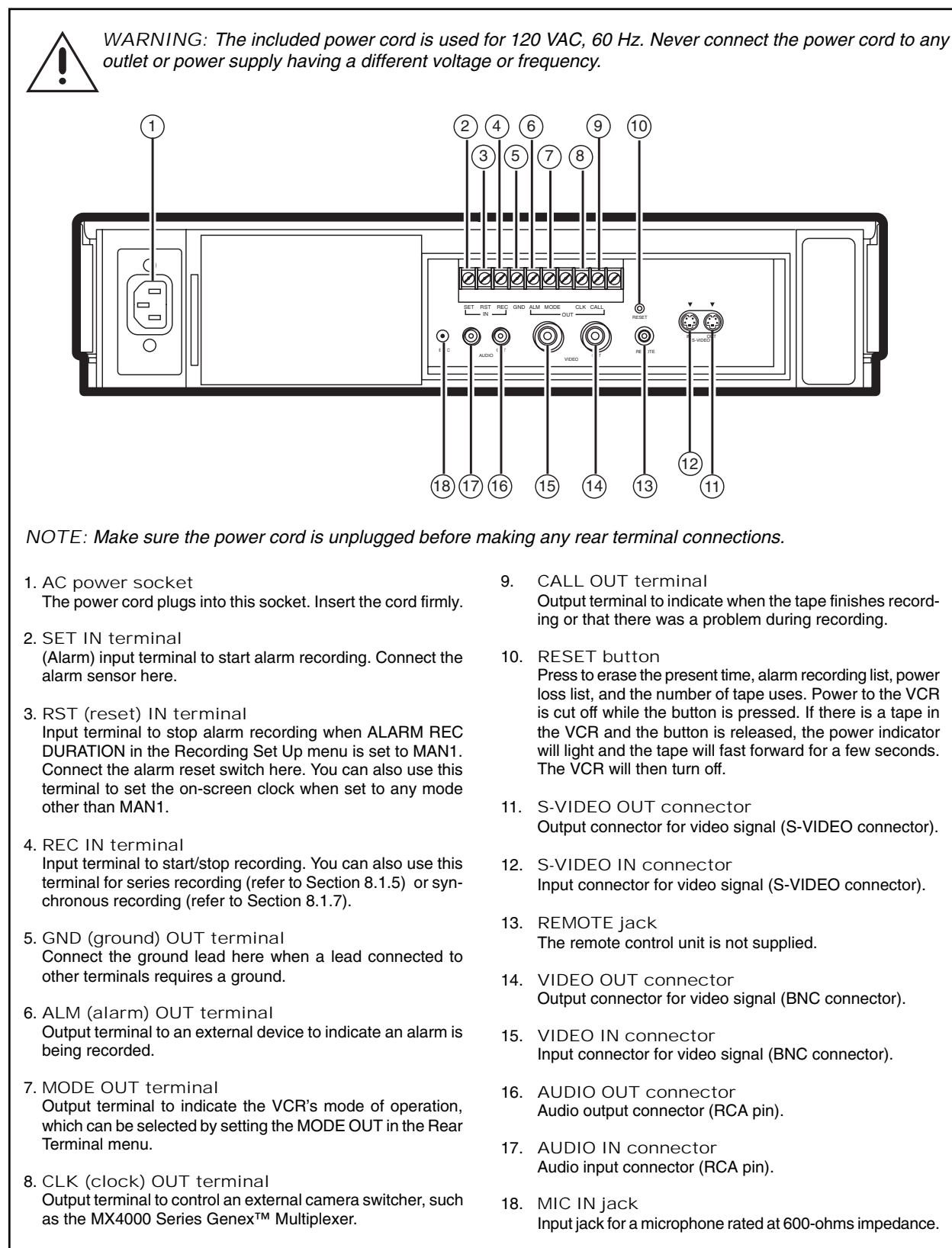

Figure 5. Rear View

(This page intentionally left blank.)

6.1 GENERAL PROGRAMMING INSTRUCTIONS

NOTE: If the VCR is connected to an MX4000 Series Genex™ Multiplexer, make sure the multiplexer is in the VCR mode and single-camera display. Momentarily press the VIEW button on the multiplexer, then press the DISPLAY button on the VCR.

The following is a universal procedure that shows how programming is done on the VCR. Use the JOG dial to select items, the SHUTTLE ring to the right to enter, and SHUTTLE ring to the left to exit.

1. Press the DISPLAY button. The Main menu is displayed.
2. Turn the JOG dial to select the desired item.
 - Turn it to the right to move the cursor downward.
 - Turn it to the left to move the cursor upward.
3. Turn the SHUTTLE ring to the right. The desired item is selected and the menu will appear.
4. Turn the JOG dial to select an item.
5. Turn the SHUTTLE ring to the right. The item will flash.
6. Turn the JOG dial to change the setting.
7. Turn the SHUTTLE ring to the right to enter.
8. Press the DISPLAY button. The present time display will appear.

6.2 QUICK GUIDE TO TLR2168S MENU STRUCTURE

The operating parameters of the VCR are set through various on-screen menus. Program your choices on the menus according to the instructions on the following pages.

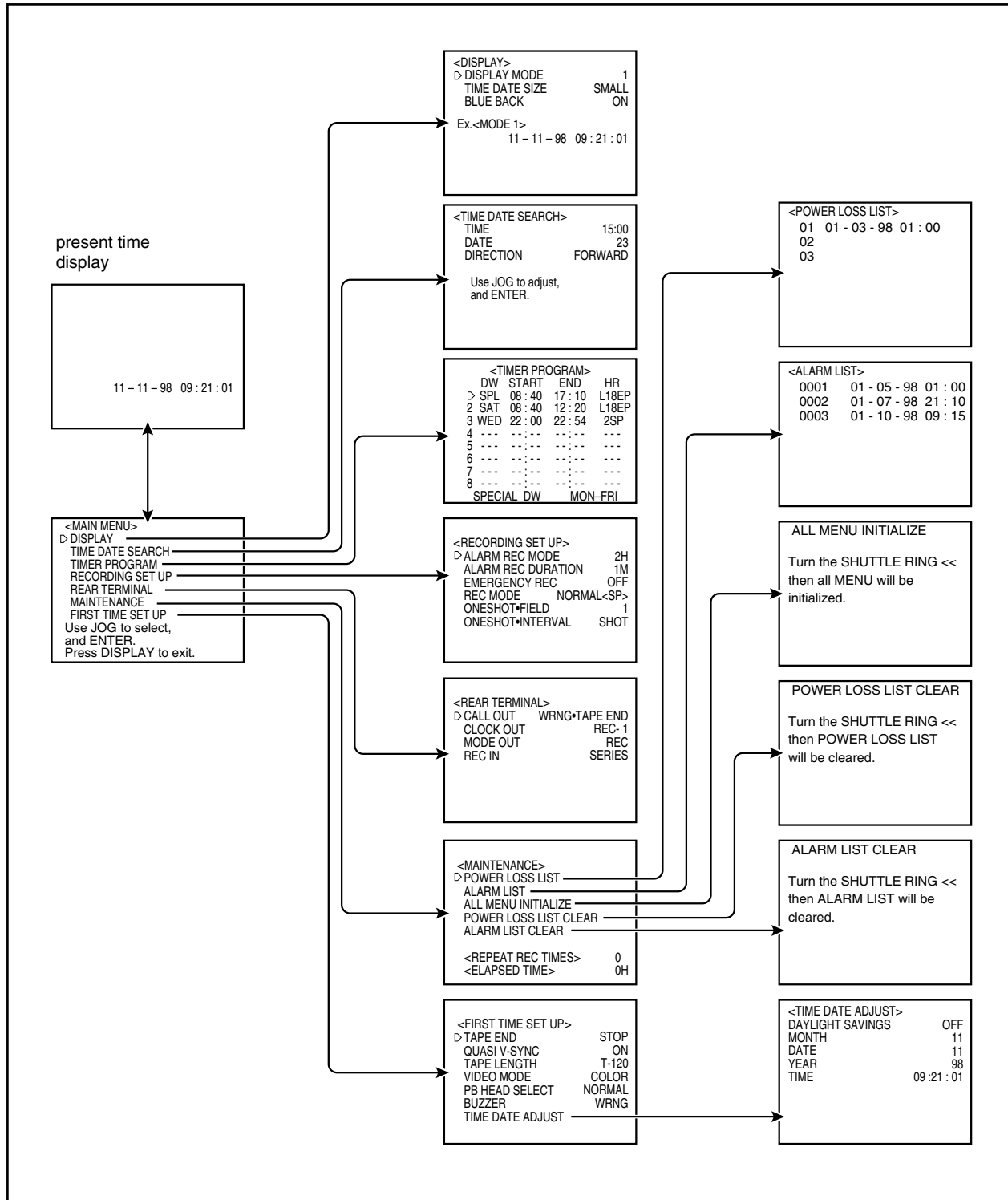

Figure 7. Menu Tree

6.3 MAIN MENU

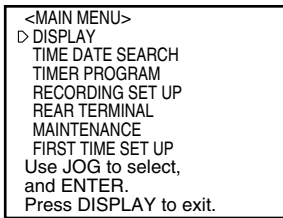

Figure 8. Main Menu

- DISPLAY
Sets the display format of the time and date on the monitor.
- TIME DATE SEARCH
Sets the time/date and direction to search for a desired location on a tape.
- TIMER PROGRAM
Sets the timed recordings.
- RECORDING SET UP
Sets the alarm recording mode, alarm recording duration, emergency recording, recording mode, and one-shot recording.
- REAR TERMINAL
Sets the number of frames or fields to record for CLK OUT, output signal of the CALL OUT terminal, and the MODE OUT terminal, etc.
- MAINTENANCE
Displays the power loss list and alarm list, etc. Initializes all menu settings. Clears the power loss list and alarm list.
- FIRST TIME SET UP
Sets the quasi v-sync, tape length, playback head selection, buzzer setting, time/date, and VCR operation when the end of the tape is reached.

6.4 DISPLAY MENU

6.4.1 Display Mode

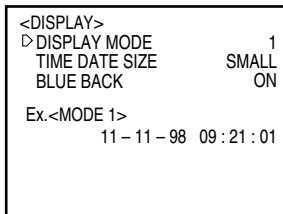

Figure 9. Display Menu

This is where you set the display mode. (Set the current date and time in the First Time Set Up menu. Refer to Sections 6.10.1 and 6.10.2.) The default is DISPLAY MODE 1.

- | | |
|----------------|--|
| DISPLAY MODE 1 | Displays date and time. |
| DISPLAY MODE 2 | Displays date, day of the week, present time, and recording mode. |
| DISPLAY MODE 3 | Displays nothing until an alarm recording starts—then date, alarm recording number, etc. is displayed. |
| DISPLAY MODE 4 | Displays nothing. Even in the case of alarm recording nothing is displayed on the monitor. |

During an alarm recording, the alarm recording number is displayed if the display mode is set from 1 to 3.

6.4.2 Time Date Size

This is where you set the size of the letters in the day and time display. The default is SMALL.

- | | |
|-------|---------------------------|
| SMALL | The letters become small. |
| LARGE | The letters become large. |

6.4.3 Background Color (Blue Back)

This is where you set a blue background on or off.

- | | |
|-----|--|
| ON | The blue screen overlays the recorded picture when the menu is displayed on the monitor. |
| OFF | There will be no blue screen. The menu display overlays the recorded picture. |

NOTE: This setting will also affect the background color when there is no recording input signal. When set to ON, the warning "NO SIGNAL" appears on the blue screen. When set to OFF, neither the blue screen nor the warning appears on the monitor.

6.5 TIME DATE SEARCH MENU

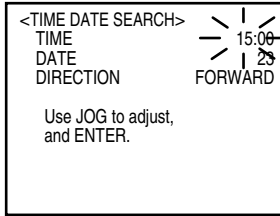

Figure 10. Time Date Search Menu

On this menu you set the date, time, and direction to search for the desired location on a tape.

TIME Turn the JOG dial to set the hour and minute to search for.

DATE Turn the JOG dial to set the day of the month to search for.

DIRECTION Turn the JOG dial to select the starting direction of the search (FORWARD or REVERSE).

To start the search, turn the SHUTTLE ring to the right. If the VCR does not find the specified part of the tape in one direction, it automatically searches in the opposite direction.

NOTES:

- The VCR writes an hour index mark on the tape on the hour, which it uses as a reference when searching. Because of this, a recorded tape must pass a time clock hour mark before this function can work. The time date search function begins after the first hour index mark.

Example 1: The VCR is set to record from 8:30 to 17:30. Times from 9:00 to 17:30 can be found.

Example 2: The VCR is set to record in one speed from 7:00 to 14:30, then in another speed until 18:00. Times from 7:00 to 14:30 and 15:00 to 18:00 can be found.

- The time and date search function only works for tapes recorded on this model VCR.

If the recording quality is poor, the VCR may fail to locate the desired part of the tape during a time date search.

6.6 TIMER PROGRAM MENU

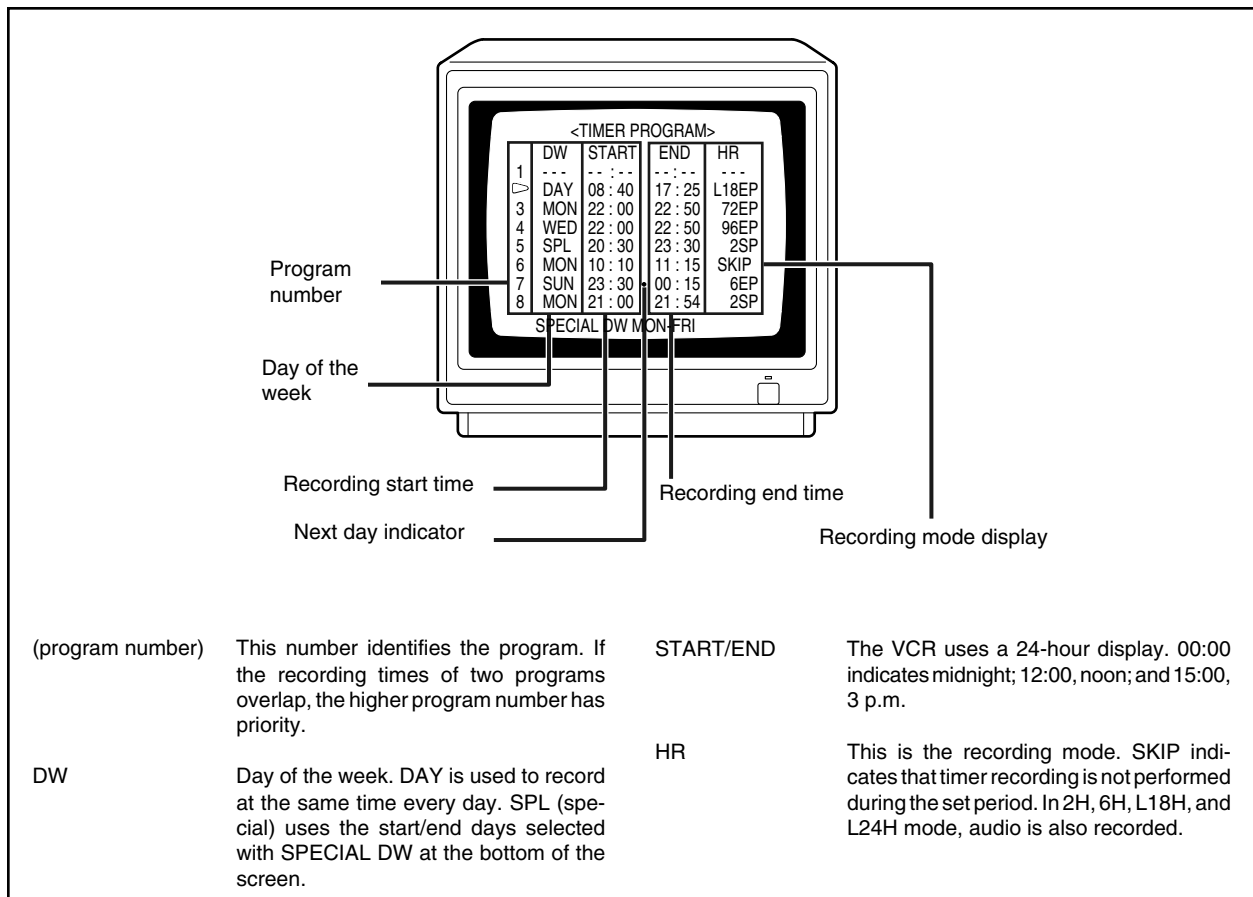

Figure 11. Timer Program Illustration

6.7 RECORDING SET UP MENU

<RECORDING SET UP>	
▷ ALARM REC MODE	2H
ALARM REC DURATION	1M
EMERGENCY REC	OFF
REC MODE	NORMAL<SP>
ONESHOT*FIELD	1
ONESHOT*INTERVAL	SHOT

Figure 12. Recording Set Up Menu

NOTE: Set the ALARM REC DURATION to MAN2 to use with the MX4000 Series Genex™ Multiplexer.

NOTE: When using the MX4000 Series Genex™ Multiplexer, make sure the EMERGENCY REC setting is ON if the VCR is to record alarms only.

ALARM REC MODE	Sets the alarm recording time mode. When you turn the JOG dial, the display switches in the following order: 2H, 6H, L18H, L24H, 2H. (Refer to Section 8.3.3 for programming instructions.) The default is 6H.
ALARM REC DURATION	Sets the length of the alarm recording period. When you turn the JOG dial, the display switches in the following order: 1M (minute), 2M, 5M, 10M, MAN1, MAN2, 15S (second), 30S, 45S, 1M. (Refer to Section 8.3.3 for programming instructions.) The default is 1M.
EMERGENCY REC	Sets the emergency recording mode, as follows: <ul style="list-style-type: none"> • OFF – Starts alarm recording when the alarm signal is received during recording. • ON – Starts alarm recording when the alarm signal is received, not only during recording but also when the power is OFF or when the tape is stopped. <p>The default is OFF. (Refer to Section 8.3.3 for programming instructions.)</p>

REC MODE	<p>Sets the recording mode.</p> <ul style="list-style-type: none"> NORMAL<SP> – Choose SP (standard play) when higher picture quality is desired. With this setting, the recording time mode is switched in the following order: 2H, L24H, 48H, 72H, 96H, 120H, 168H, 0H, 2H. H•D<EP> – Select the EP (extended play) setting to make high density recording. This provides three times more fields than normal density (SP). It reduces the time interval between pictures, providing more pictures for smoother time-lapse recording. With this setting, the recording time mode is switched in the following order: 6H, L18H, 48H, 72H, 96H, 120H, 168H, 0H, 6H.
ONESHOT• FIELD	<p>Sets the number of fields to record in the one-shot mode. When you turn the JOG dial to the right, the display switches in the following order: 1, 2, 3, 4, 5, 10, 20, 30, 1. The default is 1.</p>
ONESHOT• INTERVAL	<p>Sets the interval time in one-shot mode. When you turn the JOG dial to the right, the display switches in the following order: SHOT, 10S (second), 15S, 30S, 45S, 1M, 2M, 3M, SHOT. The default is SHOT.</p>

6.8 REAR TERMINAL MENU

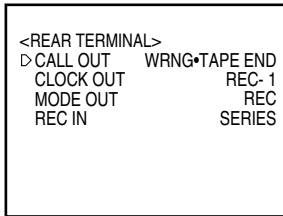

Figure 13. Rear Terminal Menu

CALL OUT	<p>Sets the call signal output at the end of the tape. Turns on or off the signal that comes from the CALL terminal when the end of the tape is reached during recording. If any problems occur during recording, a call signal is output from the CALL terminal on the rear panel regardless of the CALL OUT setting. The default is WRNG•TAPE END.</p> <ul style="list-style-type: none"> WRNG•TAPE END – A signal is output at the end of the tape or when a malfunction occurs. WRNG•REMAIN – The signal is output when a malfunction occurs in the VCR or when the tape has about three minutes left in 2H mode. WRNG – When a malfunction occurs in the VCR during recording, a call signal is output. <p>CALL OUT is used in conjunction with TAPE END (First Time Set Up menu) to determine when the call signal is output, as shown in Table B.</p>
----------	--

Table B. Call Out/Tape End

CALL OUT setting		WRNG•TAPE END	WRNG•REMAIN	WRNG
TAP E E N D s e t t i n g	STOP	Outputs a call signal at the end of the tape.	Outputs a call signal 3 minutes before the end of the tape	When a malfunction occurs in the VCR during recording, a call signal is output
	REWIND	Outputs a call signal at the end of the tape for 2 seconds.	(same as above)	(same as above)
	REPEAT	(same as above)	(same as above)	(same as above)
ALARM • PROT	When there are no alarm recordings during recording.	(same as above)	(same as above)	(same as above)
	When there are alarm recordings during recording.	Outputs a call signal at the end of the tape.	(same as above)	(same as above)

CLOCK OUT	<p>Sets the number of frames or fields to record (depending on the recording mode) at the CLOCK OUT terminal. The default is REC.</p> <ol style="list-style-type: none"> 1. First, set the recording mode for the CLOCK OUT pulse output in the Rear Terminal menu. <ul style="list-style-type: none"> • REC – When recording in any mode. • T/L-REC – When recording in time-lapse mode (L18H, L24H, 48H, 72H, 96H, 120H, 168H, or 0H). 2. Second, select the frequency interval by turning the SHUTTLE ring. When you turn the JOG dial, the display switches in the following order: 1, 2, 3, 4, 5, 10, 15, 20, 25, 30, 50, 60, F (field), 1. The numbers from 1 to 60 indicate the number of frames in 2H or 6H recording mode or the number of fields in time-lapse recording mode. One frame consists of two fields. One field is selected when it is set to “F” (field).
MODE OUT	<p>Sets the state in which the signal output at the MODE OUT terminal is switched to active. When you turn the JOG dial, the display switches in the following order: REC (recording), PLAY (playback), POWER (power on), TAPE IN (tape inserted), TAPE REMAIN (three minutes in 2H mode before the tape ends), CLOCK ADJ (output the signal for one second when the clock indicates 00[min]:00[sec]), REC. The default is REC.</p>
REC IN	<p>Sets the REC IN terminal's operation mode. The default is SERIES.</p> <ul style="list-style-type: none"> • SERIES – Recording starts when the REC IN terminal is short-circuited to ground or a low-level voltage (0 to +1.6V) is applied. • REC-START/STOP – Recording starts when the REC IN terminal is short-circuited to ground or a low-level voltage (0 to +1.6V) is applied. Recording stops if this connection is removed. • SYNC REC – The video signals from 3 or 13 cameras can be recorded separately by connecting a switcher. (Synchronous recording is available when recording in L18H or L24H mode.) Synchronous recording is explained (and the procedure listed) in Section 8.1.7.

6.9 MAINTENANCE MENU

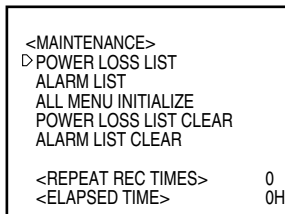

Figure 14. Maintenance Menu

POWER LOSS LIST	<p>To display the power loss list, turn the JOG dial to select POWER LOSS LIST. Turn the SHUTTLE ring to the right to display the list. Power failure start times are stored in memory, so you can confirm when they occurred. Up to three power failure start times will be displayed. If there were more than three, the first and last two power failure start times will be displayed.</p>
ALARM LIST	<p>To display the alarm list, turn the JOG dial to select ALARM LIST. Turn the SHUTTLE ring to the right to display the list. Alarm record start times are stored in memory, so you can confirm when they occurred. Up to three alarm record start times will be displayed. If there were more than three, the first and last two alarm record start times will be displayed.</p>

ALL MENU INITIALIZE	Turn the SHUTTLE ring to the right and the words ALL MENU INITIALIZE will be displayed. When you turn the SHUTTLE ring to the left, all settings (except the TIMER RECORDING setting) will be cleared. Turn the SHUTTLE ring to the right to return to the Maintenance menu.
POWER LOSS LIST CLEAR	Turn the SHUTTLE ring to the right and the words POWER LOSS LIST CLEAR will be displayed. When you turn the SHUTTLE ring to the left, the list will be cleared. Turn the SHUTTLE ring to the right to return to the Maintenance menu.
ALARM LIST CLEAR	Turn the SHUTTLE ring to the right and the words ALARM LIST CLEAR will be displayed. When you turn the SHUTTLE ring to the left, the list will be cleared. Turn the SHUTTLE ring to the right to return to the Maintenance menu.

6.10 FIRST TIME SET UP MENU

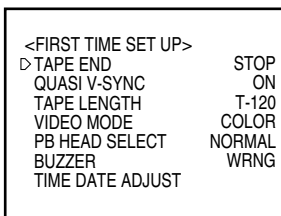

Figure 15. First Time Set Up Menu

NOTE: Some multiplexers may require Quasi V-Sync OFF to work properly. With the Pelco MX4000 Series Genex™ Multiplexer, setting Quasi V-Sync on or off has no apparent effect on playback.

TAPE END	<p>Sets the VCR's state of operation when the tape runs out during recording. The default is STOP.</p> <ul style="list-style-type: none"> • STOP – The tape stops. “End” appears on the fluorescent display and “Tape End” on the monitor. When CALL OUT is set to WRNG•TAPE END, a call signal is output from the CALL terminal. • REWIND – Rewinds the tape to the beginning and stops (except during timer recording). When CALL OUT is set to WRNG•TAPE END, a call signal is output for two seconds from the CALL terminal. • REPEAT – Rewinds the tape to the beginning and resumes recording. • ALARM•PROT – (Alarm Protection) If alarm recordings are on the tape, then the tape stops. “End” appears on the fluorescent display and “Tape End” on the monitor. When CALL OUT is set to WRNG•TAPE END, a call signal is output from the CALL terminal. If there are no alarm recordings, the tape is rewound and recording continues.
QUASI V-SYNC	<p>Sets Quasi V-Sync on or off. The default is ON.</p> <ul style="list-style-type: none"> • ON – Quasi V-Sync signal is inserted on the video output signal when in the special playback modes (still, slow motion, reverse, fast playback, speed search) and during normal playback in L18H, L24H, 24H – 168H, or 0H modes. • OFF – Quasi V-Sync signal is not inserted.
TAPE LENGTH	<p>Sets the tape length to match the tape so the tape remaining indicator works correctly. Set as follows:</p> <ul style="list-style-type: none"> • T-120 – When using T-120 tape. • T-160 – When using T-160 tape. <p>The default is T-120.</p>
VIDEO MODE	<p>Set as follows:</p> <ul style="list-style-type: none"> • COLOR — Select for color recording or playback. • B/W — Select for black and white recording or playback.

PB HEAD SELECT

Sets the heads for playback. When you turn the JOG dial to the right, the display switches in the following order: NORMAL, L/L (left/left), R/R (right/right), AUTO, NORMAL. The default is NORMAL.

The VCR has two pairs of SP (standard play) heads. Some VCRs make time-lapse recordings using same-azimuth heads, which are not VHS compatible. Playback of such tapes with the NORMAL setting will have picture/noise with a 30 Hz flicker, or just noise. For proper playback, adjust the setting to AUTO, or set to L/L or R/R. One setting will give normal play. After playing a tape with L/L or R/R settings, return the setting to NORMAL.

BUZZER

Sets the conditions for which the buzzer sounds. The default is WRNG.

- WRNG – The buzzer sounds when there is any malfunction in the VCR.
- WRNG•TAPE END – The buzzer sounds when there is any malfunction in the VCR or at the tape end.
- WRNG•REMAIN – The buzzer sounds when there is any malfunction in the VCR or when the tape (T-120 or T-160) has about three minutes left in 2H mode.
- OFF – The buzzer does not sound.

TIME DATE ADJUST

Sets the time, date, and Daylight Savings setting. Section 6.10.1 provides an explanation while Section 6.10.2 provides a procedure.

6.10.1 Day and Time Display Modes

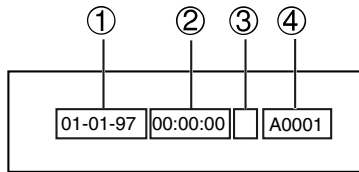

Figure 16. Display Mode 1

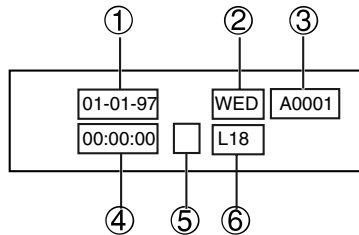

Figure 17. Display Mode 2

DISPLAY MODE 1

1. Month-Day-Year
2. Hour:Minute:Second
3. Daylight Savings Time symbol or power failure symbol
4. Alarm recording number
 - A 24-hour display is used: 00:00 indicates midnight; 12:00, noon; and 15:00, 3 p.m.
 - An alarm recording number is displayed during alarm recording.

DISPLAY MODE 2

1. Month-Day-Year
2. Day of the week
3. Alarm recording number
4. Hour:Minute:Second
5. Daylight Savings Time symbol or power failure symbol
6. Recording mode
 - A 24-hour display is used: 00:00 indicates midnight; 12:00, noon; and 15:00, 3 p.m.
 - The day of the week is automatically set.
 - An alarm recording number is displayed during alarm recording.

6.10.2 Set the Day and Time

```
<MAIN MENU>
▷ DISPLAY
TIME DATE SEARCH
TIMER PROGRAM
RECORDING SET UP
REAR TERMINAL
MAINTENANCE
FIRST TIME SET UP
Use JOG to select,
and ENTER.
Press DISPLAY to exit.
```

```
<MAIN MENU>
DISPLAY
TIME DATE SEARCH
TIMER PROGRAM
RECORDING SET UP
REAR TERMINAL
MAINTENANCE
▷ FIRST TIME SET UP
Use JOG to select,
and ENTER.
Press DISPLAY to exit.
```

```
<FIRST TIME SET UP>
▷ TAPE END          STOP
  QUASI V-SYNC      ON
  TAPE LENGTH       T-120
  VIDEO MODE        COLOR
  PB HEAD SELECT    NORMAL
  BUZZER            WRNG
  TIME DATE ADJUST
```

```
<FIRST TIME SET UP>
TAPE END          STOP
  QUASI V-SYNC      ON
  TAPE LENGTH       T-120
  VIDEO MODE        COLOR
  PB HEAD SELECT    NORMAL
  BUZZER            WRNG
▷ TIME DATE ADJUST
```

```
<TIME DATE ADJUST>
DAYLIGHT SAVINGS  OFF
MONTH             01
DATE              01
YEAR              97
TIME              00:00:00
```

```
<TIME DATE ADJUST>
DAYLIGHT SAVINGS  OFF
MONTH             01
DATE              01
YEAR              97
TIME              00:00:00
```

```
<TIME DATE ADJUST>
DAYLIGHT SAVINGS  OFF
MONTH             01
DATE              01
YEAR              97
TIME              00:00:00
```

1. Press the DISPLAY button to display the Main menu on the monitor.
2. Turn the JOG dial to select FIRST TIME SET UP.
3. Turn the SHUTTLE ring to the right. The First Time Set Up menu will appear.
4. Turn the JOG dial to select TIME DATE ADJUST.
5. Turn the SHUTTLE ring to the right. The Time Date Adjust menu will appear.
6. Do the following to advance the clock by one hour and set Daylight Savings to ON:

Turn the SHUTTLE ring to the right. The DAYLIGHT SAVINGS display will flash. Turn the JOG dial to select ON.

- The clock advances by one hour and the Daylight Savings Time symbol (☀) will be displayed next to the present time display.
- To cancel Daylight Savings Time, switch DAYLIGHT SAVINGS to OFF.

NOTE: If power goes out while Daylight Savings Time is selected, the power failure mark "X" will replace the Daylight Savings Time symbol. When the power failure mark "X" disappears, the Daylight Savings Time symbol (☀) will reappear.

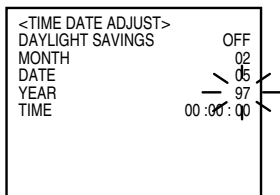
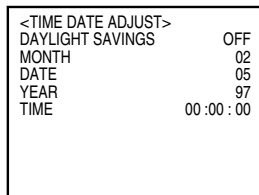
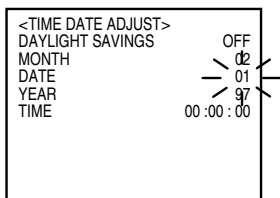
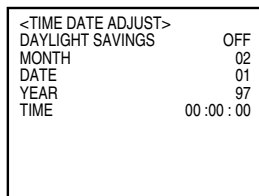
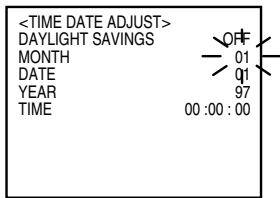

7. To set the month, turn the SHUTTLE ring to the right. The month display will flash. Turn the JOG dial to the right to set the MONTH.
8. To set the date, turn the SHUTTLE ring to the right. The date display will flash. Turn the JOG dial to the right to set the DATE.
9. To set the year, turn the SHUTTLE ring to the right. The year display will flash. Turn the JOG dial to the right to set the YEAR. The year digits can be set from 97 (for year 1997) to 27 (for 2027).
10. To set the time, turn the SHUTTLE ring to the right. The hour digits of the time display will flash. Turn the JOG dial to the right to set the hour digits. Set the minute digits in a similar fashion.

To set the time to the exact second, do the following. When you set the minute digits, the digit on the right will flash and the seconds digits stay at 00. Turn the SHUTTLE ring to the right when the time signal reaches 00 seconds of the time you set. The time will begin counting from 00.

11. Turn the SHUTTLE ring to the right if you did not already do so in step 10. Programming is now complete.
12. Press the DISPLAY button. The time display will appear.

NOTE: The POWER button will not operate if any menu display is flashing.

7.0 LOADING/UNLOADING/PROTECTING THE TAPE CASSETTE

You can load video cassette tapes into your VCR as long as it is plugged into a power source. Loading a cassette automatically turns the VCR on even if its power switch is turned off. Use only video cassette tapes marked VHS.

Use only standard grade VHS cassette tapes for reliable video recording. Do not use Pro, Hi-Fi, and High Grade tapes—they may damage the video heads.

Do not use a T-160 or ST-160 tape when recording in 48H – 168H or 0H modes.

7.1 LOADING

NOTE: The VCR's protection circuit will eject the tape if it is loaded improperly. If the VCR ejects the tape you are trying to load, remove it and check that the contents label is facing you and the clear plastic window showing the tape faces up. Try again.

1. To position the cassette properly before inserting it in the cassette slot, hold the cassette so the long narrow edge with the contents label faces you. The hinged narrow edge should face the VCR. The clear plastic window showing the tape should face up.
2. Line up the cassette squarely with the cassette slot and gently push the video tape in until the VCR pulls it in.

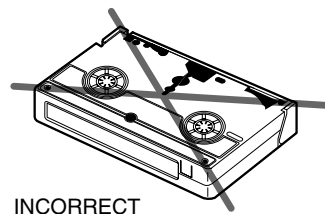
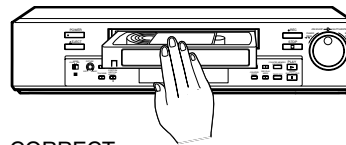

7.2 UNLOADING

NOTE: The VCR will eject a video cassette even if it is in STANDBY mode. When you press the EJECT button, the VCR will automatically turn on, eject the tape, and turn off. You cannot eject a tape while recording without first pressing the STOP button, or while the VCR is locked.

1. Press the EJECT button on the front of the VCR.
2. Remove the cassette.

7.3 PREVENTING ACCIDENTAL ERASURE

NOTE: We recommend taking any torn or broken cassette tape requiring repair only to professionals who specialize in such procedures. The adhesives on many common types of tape could damage the head on the VCR.

Video cassettes come with an erasure prevention tab. When it is removed it stops the tape's contents from being erased or recorded over. The VCR will automatically eject a cassette if you try to record over it with the erasure prevention tab removed.

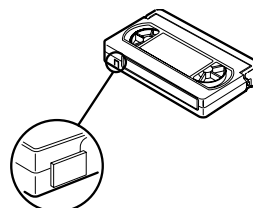

8.1 MANUAL RECORDING

NOTES:

- Press the PAUSE/SHUTTLE HOLD button to momentarily stop recording. Press the button again to resume recording.
- To protect the tape, the pause mode is automatically released after about five minutes.
- The REC button will not function unless the tape is in the stop or pause mode.
- If the cassette you insert in the VCR has the erasure prevention tab removed, the VCR will automatically eject it if you try to record on it.
- Both 2-hour (SP) and 6-hour (EP) tapes are VHS compatible with other VCRs. Time-lapse recordings can be played correctly by other VHS-compatible time-lapse recorders when the recording interval and head type (SP/EP) matches the recording.

1. Load a cassette with the erasure prevention tab intact.
2. Set the S-VHS switch to on or off.
3. Press the REC/PLAY MODE buttons (+/-) to select the desired recording mode. If necessary, change the recording mode, as follows:
 - NORMAL <SP> – Choose SP (standard play) when a higher picture quality is desired. With this setting, the recording time mode is switched in the following order: 2H, L24H, 48H, 72H, 96H, 120H, 168H, 0H, 2H.
 - H•D<EP> – Select the EP (extended play) setting to make high density recordings. This provides three times more fields than normal density (SP). It reduces the time interval between pictures, providing more pictures for smoother time-lapse recording. With this setting, the recording time mode is switched in the following order: 6H, L18H, 48H, 72H, 96H, 120H, 168H, 0H, 6H.
4. Set VIDEO MODE in the First Time Set Up menu for either color or black and white recording. (Do not connect color and black and white cameras together.)
5. To record the day and present time, display the day and present time on the monitor. (If you are not using a switcher and the time/date do not appear on the monitor and you want them to be recorded on the tape, you must turn them on using the VCR's menu system. If you already have time/date supplied by a switcher, you will probably not want them turned on via the VCR's menu.)
6. Press the REC button to begin recording.
7. Press the STOP button to stop recording.

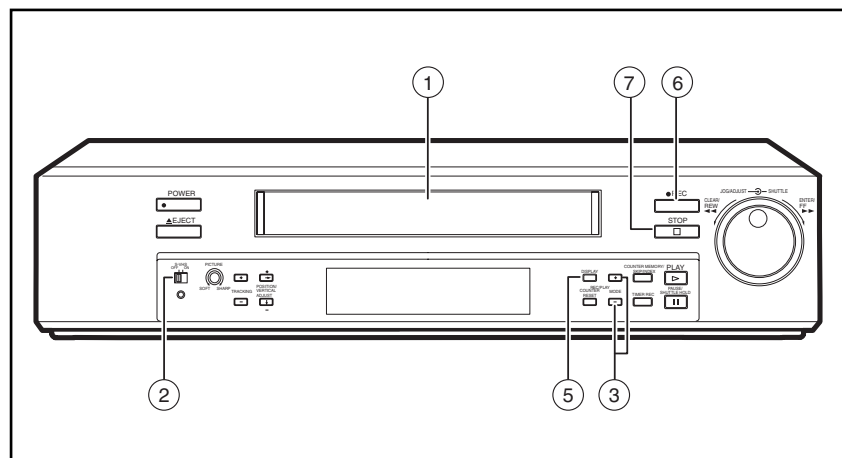

Figure 18. Manual Recording Steps

8.1.1 Recording Mode

NOTE: Do not use a T-160/ST-160 tape when recording in 48H – 168H modes. T-160/ST-160 tape in lengthy time-lapse recording can stretch, resulting in poor playback or no playback.

- Pressing the REC/PLAY MODE button in SP mode, switches the recording mode in the following order: 2H, L24H, 48H, 72H, 96H, 120H, 168H, 0H, 2H.
- Pressing the REC/PLAY MODE button in EP mode, switches the recording mode in the following order: 6H, L18H, 48H, 72H, 96H, 120H, 168H, 0H, 6H.
- In recording mode, the VCR indicates the recording time with a T-120 or ST-120 cassette. Table C shows recording times with T-120, ST-120, T-160, and ST-160 cassettes.

Table C. Recording Times in Hours

	REC MODE	2H	6H	L18H	L24H	48H	72H	96H	120H	168H
T-120/ ST-120	SP	2	–	–	26	50	74	98	122	170
	EP	–	6	18	–	54	78	102	126	174
T-160/ ST-160	SP	2h40m	–	–	34h40m	X	X	X	X	X
	EP	–	8	24	–	X	X	X	X	X

("X" = not recommended; "–" = not allowed)

8.1.2 Record Check Function

When the VCR is recording, press the PLAY button for more than 1.5 seconds and then release. The tape rewinds a little and then plays back the recording just made. When the tape reaches the spot where you pressed the PLAY button, the VCR returns to record mode.

8.1.3 Audio Recording

Either apply the specified line input signal to the AUDIO IN connector or connect the microphone to the MIC IN jack. If both are connected, the microphone is given priority.

Normal sound is played back only when a tape recorded in 2H, 6H, L18H, or L24H mode is played back in its respective mode.

The longer the recording time mode, the worse the sound quality becomes. In L18H and L24H modes, the sound quality is such that speech can be heard.

8.1.4 Repeat Recording

NOTE: On ALARM•PROT mode, a tape with alarm recordings can be used for repeat recording by ejecting and re-inserting the tape.

When TAPE END on the First Time Set Up menu is set to REPEAT or ALARM•PROT and the repeat recording mode is set (the REPEAT indicator is lit), the tape will automatically rewind to the start when the end of the tape is reached. Recording will begin again.

Table D shows what automatically happens when the tape ends during recording:

Table D. When Tape End is Reached

	STOP	REWIND	REPEAT	ALARM•PROT
When there are alarm recordings on the tape.	The tape stops.	The tape rewinds automatically to the beginning and then stops.	The tape rewinds automatically to the beginning and recording resumes.	The tape stops.
When there are no alarm recordings on tape.				The tape rewinds automatically to the beginning and recording resumes.

<REPEAT REC TIMES>	0
<ELAPSED TIME>	0H

8.1.4.1 Number of Tape Uses (Repeat Recording Times)

Displays the number of times a tape has been used when the TAPE END setting is set to REWIND, REPEAT, or ALARM•PROT.

1. Press the DISPLAY button. The Main menu will appear.
2. Turn the JOG dial to select MAINTENANCE and turn the SHUTTLE ring to the right. MAINTENANCE will appear on the display. REPEAT REC TIMES indicates how many times a tape has been recorded on.
 - The number of tape uses increments by one when the tape ends.
 - The number of tape uses is kept even if the AC power is disconnected, provided the backup battery is fully charged.
 - The number of tape uses is reset when you replace the current tape with another.
3. Press the DISPLAY button. The time will be displayed.

8.1.4.2 Recommended Number of Tape Uses

Video tape wears during use. Use a new cassette according to Table E. (T-160 tape in lengthy time-lapse recording can stretch, resulting in poor playback or no playback.)

Table E. Recommended Number of Tape Uses

Recording Time Mode	Number of Repeat Tape Uses		Recording Time Mode	Number of Repeat Tape Uses	
	T-120/ST-120 Tape	T-160/ST-160 Tape		T-120/ST-120 Tape	T-160/ST-160 Tape
2H,6H	100	50	72H, 96H	15	—
L18H	60	30	120H	10	—
L24H	35	17	168H	8	—
48H	20	—			

("—" means not recommended)

8.1.5 Series Recording

NOTES:

- *Series recording may have a short pause (up to five seconds) when going from recorder A to recorder B. However, if you set CALL OUT in the Rear Terminal menu to WRNG•REMAIN, this delay is eliminated.*
- *When set in the above configuration and the second VCR reaches the end of the tape, the first VCR automatically begins recording. Connect the line marked by [*1] in Figure 19 only if you want the first VCR to begin recording again. If not, do not connect it.*
- *If a problem occurs (for example, the motor malfunctions during recording) in the first VCR, the second VCR automatically begins recording.*
- *Series recording will not work during timer recording.*
- *When recording in series, set CALL OUT in the Rear Terminal menu to a mode other than WRNG.*

You can do series recording by connecting two or more TLR2168S VCRs together. When the tape in the first VCR reaches the end during recording, the tape in the second VCR automatically begins recording.

1. Set REC IN on the Rear Terminal menu to SERIES.
2. Set CALL OUT on the Rear Terminal menu to WRNG•TAPE END.
3. Set TAPE END on the First Time Set Up menu to REWIND.

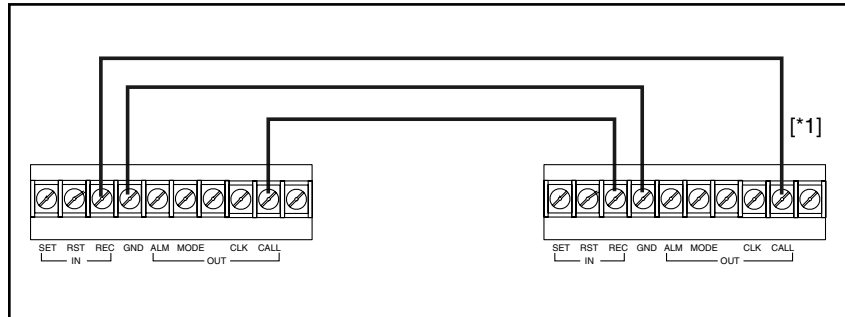

Figure 19. Connecting VCRs in Series

8.1.6 One-Shot/Interval Recording

You can do one-shot recording or interval recording when the recording mode is set to 0H.

1. Press the REC/PLAY MODE button to set the recording mode to 0H.
2. Set the number of fields in ONESHOT•FIELD in the Recording Set Up menu.
3. For one-shot recording, select SHOT in ONESHOT•INTERVAL.

For interval recording, choose the interval time from 10S (seconds) to 3M (minutes) in ONESHOT•INTERVAL.

4. Press the REC button.

One-shot recording will be in standby mode. Interval recording begins with the preset interval time.

5. To start one-shot recording, press the REC button or switch the REC IN terminal on the rear panel to ground.

8.1.7 Synchronous Recording

Several camera images can be mixed together through a camera switcher and then recorded separately onto several VCRs. To do so, assign a camera to each VCR. The VCR records only the camera image assigned to it. This allows recording without gaps.

If you have three VCRs, the video signals from the three cameras can be recorded separately by connecting the switcher as shown in Figure 21.

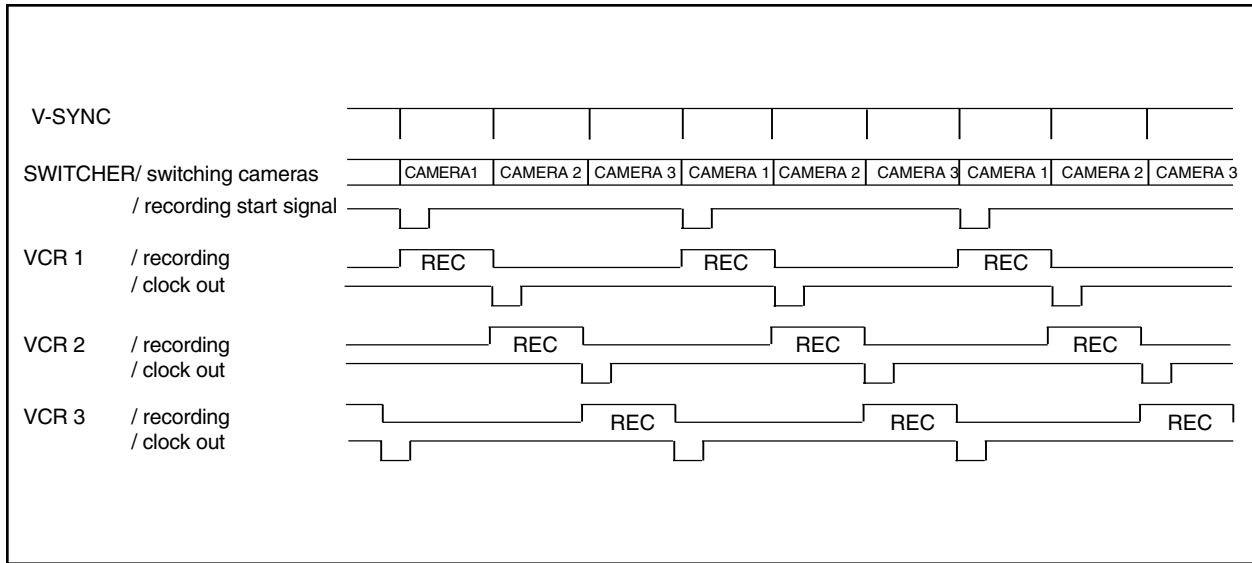

Figure 20. Synchronous Recording Sequence

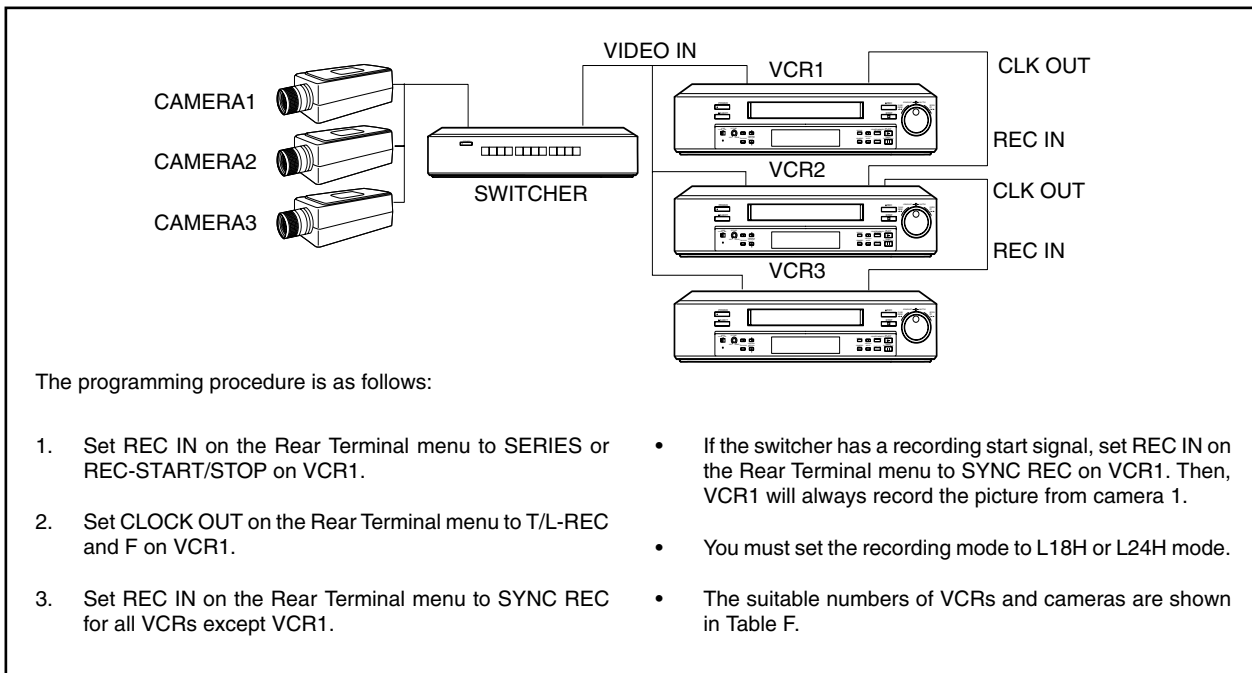

Figure 21. Connection for Synchronous Recording

Table F. Numbers of VCRs and Cameras

Recording Mode	VCR	Camera
L18H	3	Multiple of 3
L24H	13	Multiple of 13

8.2 TIMER RECORDING

8.2.1 Programming Procedure

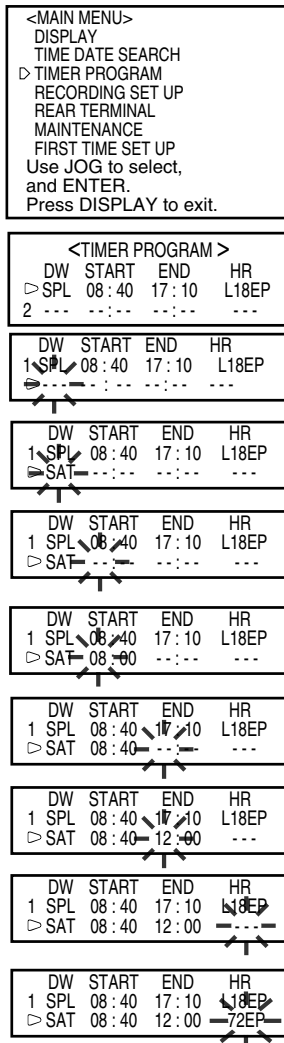

1. Press the DISPLAY button to display the Main menu on the monitor.
2. Turn the JOG dial to select TIMER PROGRAM and turn the SHUTTLE ring to the right. The TIMER PROGRAM display will appear. See Figure 11.
3. Turn the JOG dial to select the program number and turn the SHUTTLE ring to the right. The day of the week display flashes.
4. To set the day of the week (DW), turn the JOG dial to select the day and turn the SHUTTLE ring to the right.
5. To set the START recording time, turn the SHUTTLE ring to select the recording start time display. Turn the JOG dial to set the recording start time.
6. To set the END recording time, turn the SHUTTLE ring to select the recording end time display. Turn the JOG dial to set the recording end time.
7. To set the recording mode (HR), turn the SHUTTLE ring to select the recording mode display. Turn the JOG dial to set the recording mode.
8. Turn the SHUTTLE ring to the right. The display stops flashing. If the program has not been completely set, the flashing will not stop.
 - If the END time is the same or earlier than the START time, the next day indicator (*) is automatically displayed. This indicates the recording will run continuously from the START time on the first day to the END time on the next day.
 - When setting another program, turn the SHUTTLE ring to set and repeat steps 3-8. You can schedule eight programs maximum.
 - To erase the program setting, select the program number to be erased. Turn the SHUTTLE ring to the right to flash the day of the week, then turn the SHUTTLE ring to the left.
9. Press the DISPLAY button to show the day and time on the monitor.
10. Press the TIMER REC button. The TIMER REC indicator will light.

8.2.2 Special DW Settings

Set the recording period by specifying the start and end day of the week for timer recording.

1. Access the TIMER PROGRAM setting display.
2. Turn the JOG dial to select SPECIAL DW and turn the SHUTTLE ring to the right.
3. Turn the JOG dial to set the start day and turn the SHUTTLE ring to the right.
4. Turn the JOG dial to set the end day and turn the SHUTTLE ring to the right. The start and end day cannot be set to the same day.

8.2.3 Avoid Mistakes When Using the Timer

Refer to Table G if you get an error when pressing the TIMER REC button.

Table G. Timer Recording Troubleshooting

SYMPTOM	FAULT	ACTION
TIMER REC indicator flashes.	<ul style="list-style-type: none"> A tape is not inserted. A tape is loaded with the erasure prevention tab removed. Date, time, or timer recording time is not set. A menu is being programmed. 	<ol style="list-style-type: none"> Press the TIMER REC button. Correctly set the timer program. Press the TIMER REC button and confirm the TIMER REC indicator () is illuminated.

8.3 ALARM RECORDING

You can switch from all recording modes to the 2H – L24H alarm recording mode by applying an alarm signal to the SET IN (alarm input) terminal on the rear panel.

- You can switch to alarm recording by applying the alarm input signal from the alarm sensor during recording in 2H, 6H, L18H, L24H, 48H – 168H, or 0H modes.
- Set the alarm recording mode and alarm recording period in the Recording Set Up menu. Refer to Section 6.7 for instructions.
- The index signal is automatically recorded when alarm recording begins (INDEX indicator flashes on the fluorescent display).
- To record the index signal, the first 15 seconds of the alarm recording are in 2H or 6H mode.
- If another alarm input signal is applied to the SET IN (alarm input) terminal while the index signal is being recorded (for 15 seconds), a new alarm recording will not be triggered.

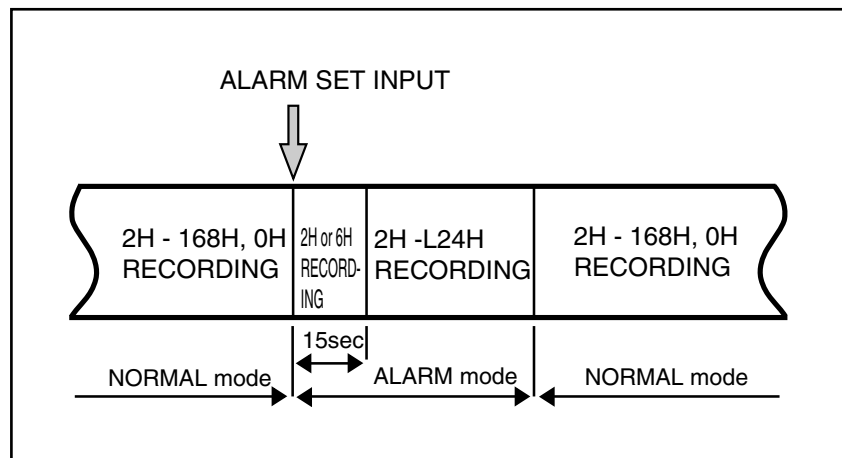

Figure 22. Switching From Normal To Alarm Mode And Back

8.3.1 Alarm Recording Connection

You can confirm an alarm from a distance by connecting the ALM (alarm) OUT terminal to an existing alarm system panel or other external device such as a buzzer.

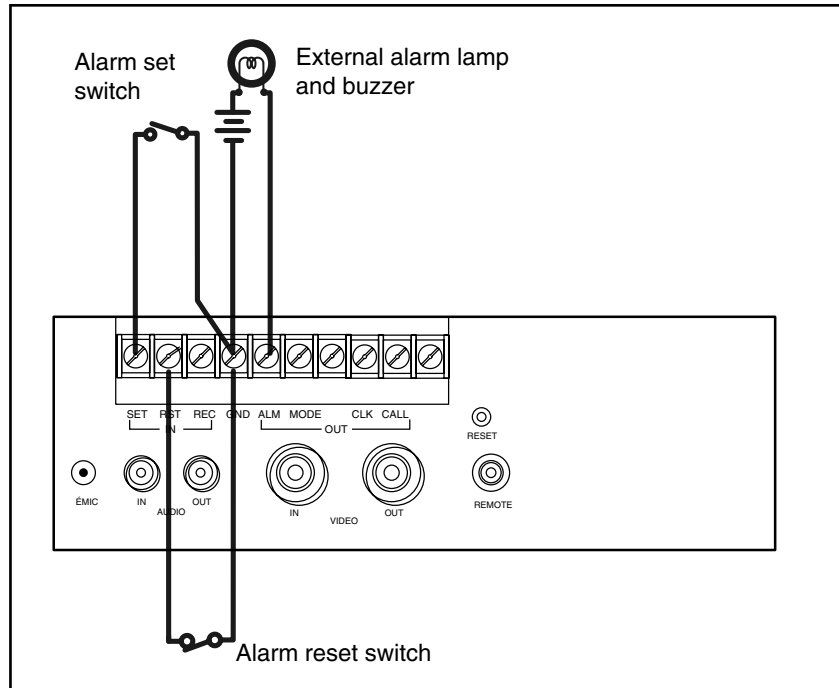

Figure 23. Alarm Recording Connection

8.3.2 External Time Clock Adjustment

If ALARM REC DURATION in the Recording Set Up menu is set to other than MAN1, the on-screen clock can be reset to the nearest hour by applying a signal to the RST (reset) IN terminal. For example, if the current time is 11:29:59, it will be reset to 11:00:00; and if the current time is 11:30:00, it will be reset to 12:00:00.

*1 If the MODE terminal of the first VCR is connected to the RST (reset) IN terminal of the second VCR and if MODE OUT in the Rear Terminal menu is set to CLOCK ADJ, the second VCR's on-screen clock will automatically be adjusted to that of the first VCR.

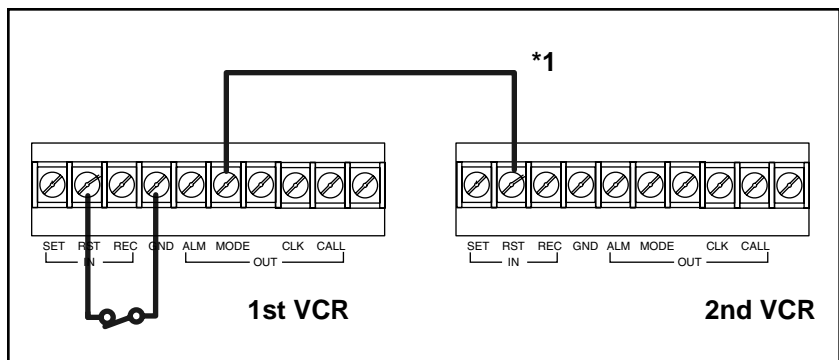

Figure 24. Time Clock Adjustment Connection

8.3.3 Programming For Alarm Recording

```

<MAIN MENU>
DISPLAY
TIME DATE SEARCH
TIMER PROGRAM
▷ RECORDING SET UP
REAR TERMINAL
MAINTENANCE
FIRST TIME SET UP
Use JOG to select,
and ENTER.
Press DISPLAY to exit.
    
```

```

<RECORDING SET UP>
▷ ALARM REC MODE      2H
  ALARM REC DURATION  1M
  EMERGENCY REC       OFF
    
```

```

<RECORDING SET UP>
  ALARM REC MODE      2H
▷ ALARM REC DURATION  1M
  EMERGENCY REC       OFF
    
```

```

<RECORDING SET UP>
  ALARM REC MODE      2H
  ALARM REC DURATION  1M
▷ EMERGENCY REC       ON
    
```

NOTES:

- If an alarm input is received during alarm recording, a new alarm recording will start with the new input signal. If one alarm input signal is received within 15 seconds of another, the later alarm input signal will be ignored and a new alarm recording will not take place.
- Alarm recording will continue for the period set in the ALARM REC DURATION field, even if a timer recording has reached its end time.
- Alarm recording stops when the end of the tape is reached.

Alarm recording speeds up recording when the VCR is recording in one of the time-lapse modes. Alarm recording provides more pictures during the alarm. Emergency recording activates alarm recording even if the VCR is off, stopped, or in timer recording/standby. You should set the alarm recording mode in the Recording Set Up menu before using alarm recording.

1. Press the DISPLAY button to display the Main menu.
2. Turn the JOG dial to select RECORDING SET UP and turn the SHUTTLE ring to the right. The Recording Set Up menu will appear.
3. Turn the JOG dial to select ALARM REC MODE and turn the SHUTTLE ring to the right.
4. Turn the JOG dial to set the alarm recording mode (2H, 6H, L18H, L24H) and turn the SHUTTLE ring to the right.
5. Turn the JOG dial to select ALARM REC DURATION and turn the SHUTTLE ring to the right.
 - If ALARM REC DURATION is set to MAN1, alarm recording will continue until a signal is received at the RST (reset) IN terminal. If that signal is within the first 15 seconds of alarm recording, alarm recording will continue for 15 seconds and then stop.
 - If ALARM REC DURATION is set to MAN2, alarm recording will continue until the signal received at the SET IN (alarm input) terminal is removed. If that signal is removed within 15 seconds of the start of alarm recording, alarm recording will continue for 15 seconds and then stop.
 - The internal time clock can be adjusted if a signal is applied to the RST (reset) IN terminal when ALARM REC DURATION is set to other than MAN1.
7. Turn the JOG dial to select EMERGENCY REC and turn the SHUTTLE ring to the right. Turn the JOG dial to select ON.
8. Press the DISPLAY button. The time display will appear.
 - During alarm recording, the alarm recording count will be displayed automatically except when Display Mode 4 is selected.
 - The alarm recording count display counts up to 9999 alarm recordings and then resets to 0000 and continues counting.
 - When initializing the alarm recording list, the alarm recording count display will be reset.
 - The alarm indicator flashes during alarm recording and lights steadily when the alarm recording finishes.
 - When the alarm recording finishes, the VCR resumes recording in the same mode as before the alarm recording.
 - If you are programming on any of the menus and an alarm input signal is received at the SET IN (alarm input) terminal, alarm recording will begin and the menu being programmed will disappear from the screen.

8.3.4 Emergency Recording

Emergency alarm recording can start when an alarm is triggered even if the VCR is stopped or is programmed for timer recording.

1. Turn the JOG dial to select EMERGENCY REC and turn the SHUTTLE ring to the right.
2. Turn the JOG dial to select ON for emergency recording, or OFF to disable it.

EMGCY lights up on the fluorescent display when EMERGENCY REC in the Recording Set Up menu is set to ON.

8.3.5 Alarm Record Time Display

```
<ALARM LIST>
0001 01 - 05 - 98 01 : 00
0002 01 - 07 - 98 21 : 10
0003 01 - 10 - 98 09 : 15
```

When alarm recordings begin, the start times are stored in memory so you can confirm when they occurred. Select ALARM LIST in the Maintenance menu and the alarm list will be displayed.

Up to three alarm recording start times can be stored in memory. If there are more, then the first and last two will be displayed.

8.3.5.1 Reset The Alarm Recording List

1. Select ALARM LIST CLEAR in the Maintenance menu.
2. Turn the SHUTTLE ring to the right. ALARM LIST CLEAR will be displayed.
3. Turn the SHUTTLE ring to the left. The alarm list will be cleared.

8.4 RECORDING AFTER A POWER FAILURE

```
01-01-97      WED
00:00:00X    L18
```

If there is a power failure during recording and the power comes back on, the VCR will begin recording in the same record mode as before the power failure. After the power comes back on, an "X" will be displayed next to the present time for about a minute.

If there is a power failure during playback, the VCR will be in stop mode when the power comes back on.

9.1 PLAYBACK PROCEDURE

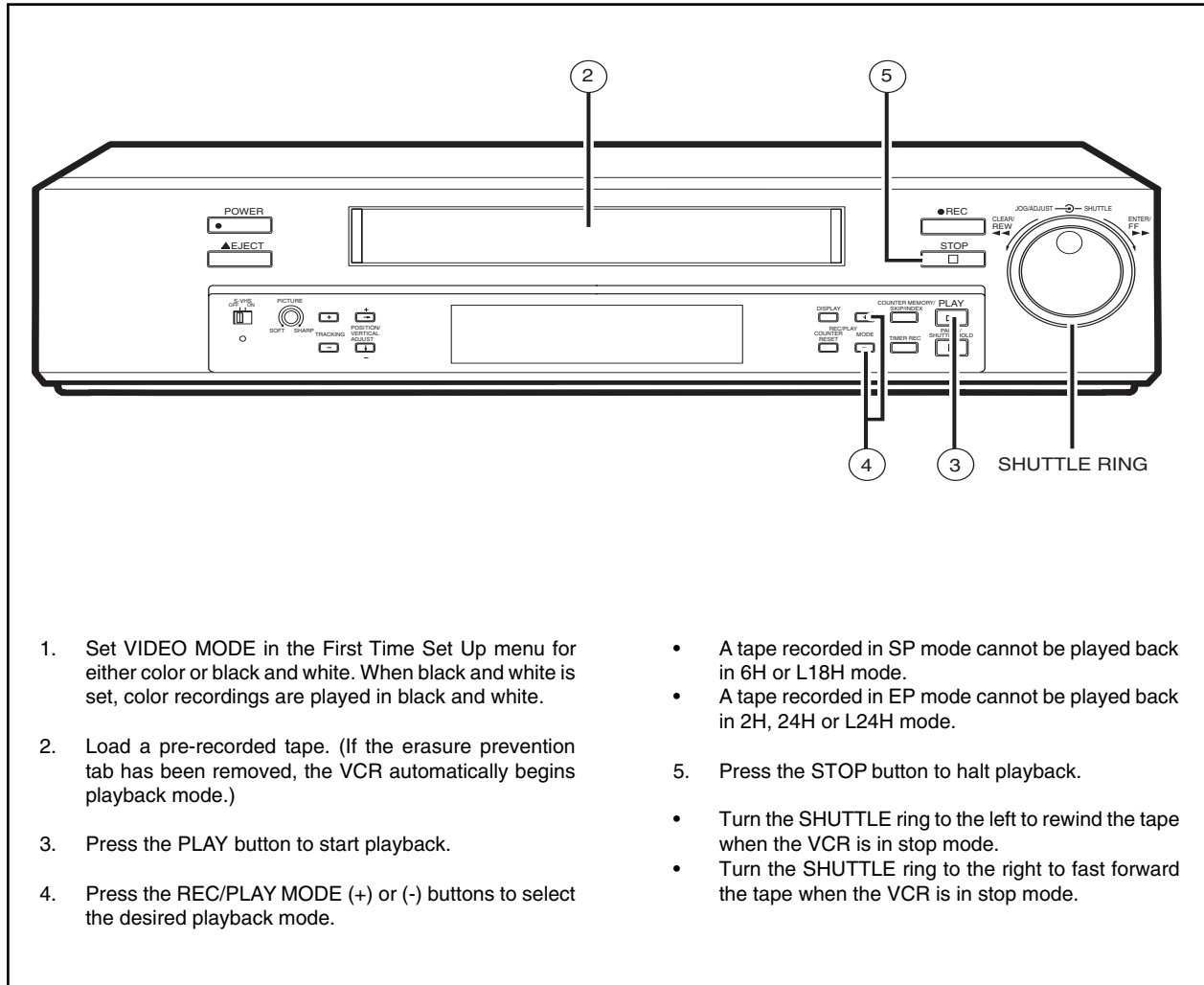

1. Set VIDEO MODE in the First Time Set Up menu for either color or black and white. When black and white is set, color recordings are played in black and white.
2. Load a pre-recorded tape. (If the erasure prevention tab has been removed, the VCR automatically begins playback mode.)
3. Press the PLAY button to start playback.
4. Press the REC/PLAY MODE (+) or (-) buttons to select the desired playback mode.
 - A tape recorded in SP mode cannot be played back in 6H or L18H mode.
 - A tape recorded in EP mode cannot be played back in 2H, 24H or L24H mode.
5. Press the STOP button to halt playback.
 - Turn the SHUTTLE ring to the left to rewind the tape when the VCR is in stop mode.
 - Turn the SHUTTLE ring to the right to fast forward the tape when the VCR is in stop mode.

Figure 25. Playback Controls

9.1.1 Playback Mode

- Tape recorded in SP mode:

When you press the REC/PLAY MODE button, playback mode is switched in the following order: 2H, L24H, 24H, 48H, 72H, 96H, 120H, 168H, 0H, 2H.

- Tape recorded in EP mode:

When you press the REC/PLAY MODE button, playback mode is switched in the following order: 6H, L18H, 48H, 72H, 96H, 120H, 168H, 0H, 6H.

9.1.2 Audio Playback

Modes with the letter "L" (L18H or L24H) are for audio recording and playback on the linear track.

Table H. Audio Playback Availability

Playback Mode	2H	6H	L18H	L24H	24H – 168H
Audio Playback	Available	Available	Available	Available	Not Available
Picture Quality	Good	Good	Vibrating	Vibrating	Less Vibrating

NOTES:

- *There is normal sound playback only when a tape recorded in 2H – L24H modes is played back in its respective mode.*
- *If a recording is played back in a higher mode than that in which it was recorded, the picture is played back in slow motion. If played back in a lower mode than that in which it was recorded, the picture is played back in fast motion.*
- *The picture may move up/down or noise may occur when a tape is played back in L18H, L24H, 24H - 168H mode (even if the tape was recorded in L18H, L24H, 48H - 168H mode).*

9.1.3 End Of Tape

When the end of the tape is reached, the following functions are performed automatically during playback or fast forwarding.

Table I. End of Tape Actions

Tape End Selected	REPEAT or ALARM•PROT	STOP or REWIND
Playback	The tape automatically rewinds to the beginning and stops.	Stop
Fast Forward	Stop	Stop

9.2 SPECIAL EFFECTS PLAYBACK

The VCR features the following convenient functions. Audio output is muted during special effects playback.

9.2.1 Shuttle Ring

NOTES:

- Releasing the SHUTTLE ring returns it to the center position and resumes still mode.
- Pressing the PAUSE/SHUTTLE HOLD button while turning and holding the SHUTTLE ring (as in step 3) continues the playback speed you selected even though the SHUTTLE ring is released.

You can use the SHUTTLE ring to adjust the playback speed.

1. Press the PLAY button to begin playback.
2. Press the PAUSE/SHUTTLE HOLD button to get a still picture.
3. Turn the SHUTTLE ring to the appropriate angle for the playback speed you want.

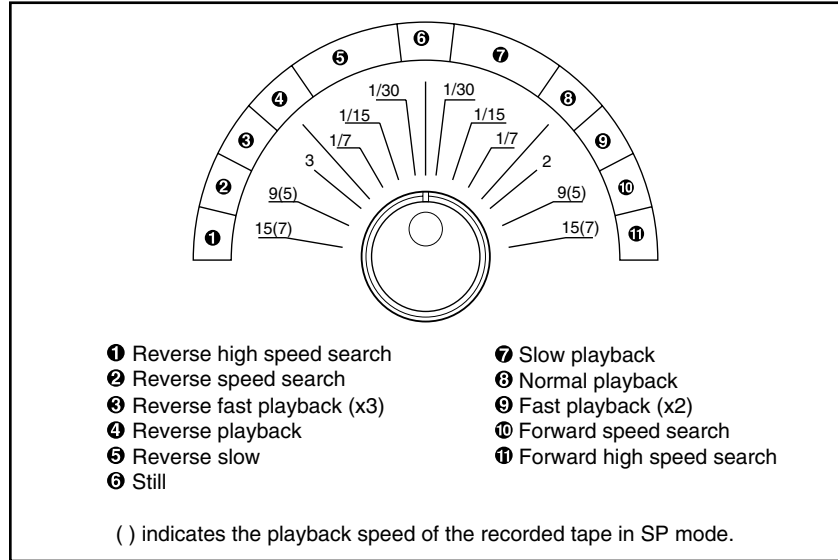

Figure 26. SHUTTLE Ring Speed Settings

9.2.2 Direct Shuttle Ring

You can also change the playback speed without entering pause mode by turning the SHUTTLE ring during playback. Releasing the SHUTTLE ring returns it to the center position and resumes normal playback.

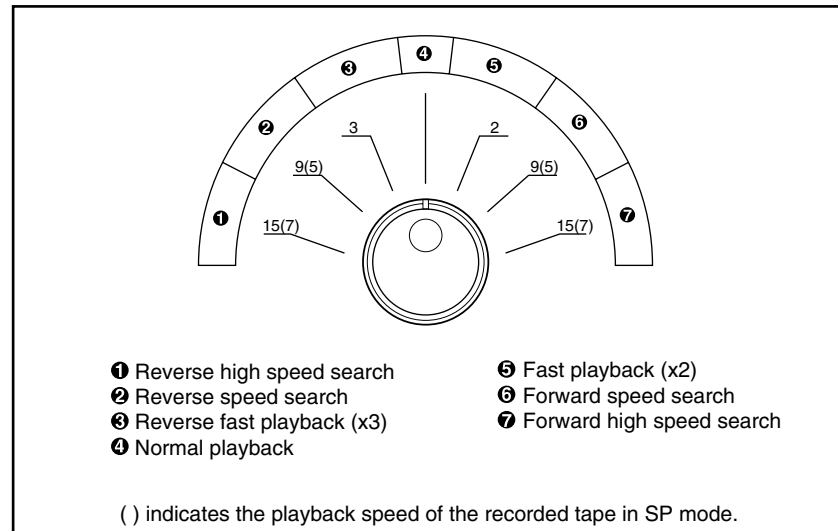

Figure 27. Direct SHUTTLE Ring Speed Settings

9.2.3 Still Picture

NOTE: A few noise bars or vertical movement may appear during still playback.

You can get a still picture by pressing the PAUSE/SHUTTLE HOLD button during playback. Press it again to resume normal playback.

9.2.4 Frame-by-Frame Playback

NOTES:

- Noise bars may appear on the picture when switching between forward and reverse playback.
- A few noise bars or vertical movement may appear during frame-by-frame playback.

You can use the JOG dial to advance the tape frame by frame.

1. While the VCR is playing the tape, press the PAUSE/SHUTTLE HOLD button to freeze the picture.
2. Slightly rotate the JOG dial clockwise to advance the tape, or counterclockwise to reverse the tape. To get a continuous frame-by-frame picture, keep rotating the JOG dial.
3. Press the PLAY button to resume normal playback.

9.3 LOCATING THE START OF ALARM RECORDINGS

The VCR automatically inserts an index signal at the beginning of each alarm recording, so the start of each alarm can be located.

9.3.1 Index Search

During fast forward or rewind, the VCR will search for alarm index signals. When it finds one, it plays back the tape and stays in still mode.

1. Press the COUNTER MEMORY/SKIP/INDEX button to illuminate INDEX on the fluorescent display. The number indicator will also be illuminated.
2. Turn the JOG dial to display the number (1-15) corresponding to the alarm index you want to find.
3. Turn the SHUTTLE ring to the right (forward direction) or left (reverse direction). The index number will decrease as each index signal passes. (The index signal may be hard to find in some recording conditions.)

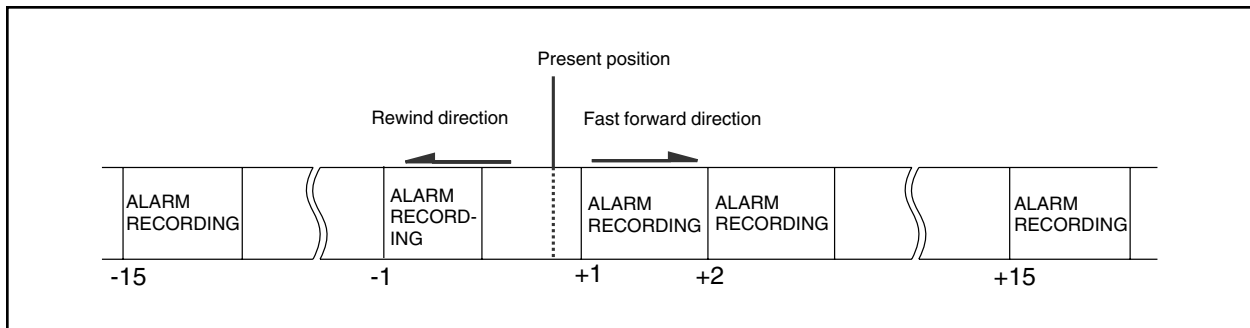

Figure 28. Index Searching

9.3.2 Skip Search

The VCR will fast forward or rewind until it finds an index signal. It then plays back for about four seconds in 2H or 6H mode. It repeats this process until reaching the end or beginning of the tape.

1. Press the COUNTER MEMORY/SKIP/INDEX button to illuminate SKIP on the fluorescent display.
2. Turn the SHUTTLE ring to the right or left.
3. Press the PLAY button when the desired location is found. Or, press the STOP button to end the skip search.

The index signal may be hard to find in some recording conditions.

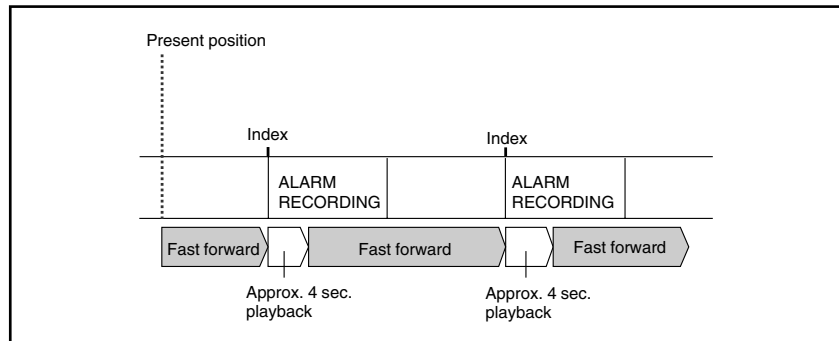

Figure 29. Skip Searching

9.4 ADJUSTMENT DURING PLAYBACK

9.4.1 Tracking Adjustment

NOTES:

- Noise bars may appear when in reverse playback or reverse slow mode.
- Noise bars will move continuously through the picture when pressing and holding a TRACKING button (except in L24H playback mode).
- Noise bars will move through the picture each time a TRACKING button is pressed (in L24H playback mode).
- Noise may appear when a tape recorded in 2H mode is played back in L24H mode, despite adjustment with the TRACKING buttons.

If noise appears in the picture during playback, fast playback, reverse playback, or forward/reverse slow playback, adjust the TRACKING buttons (+ and -) for the best picture.

Press the PAUSE/SHUTTLE HOLD button while turning and holding the SHUTTLE ring to adjust the tracking in fast playback, reverse playback, or forward/reverse slow playback.

To return tracking to its initial setting, press the TRACKING buttons at the same time during playback, reverse playback, or forward/reverse slow playback,

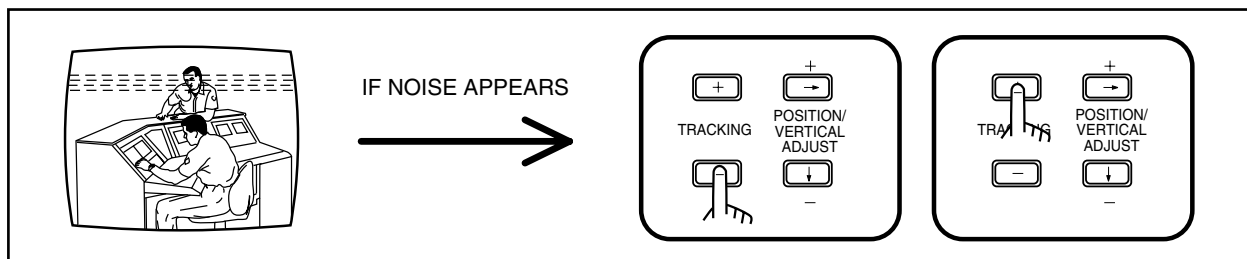

Figure 30. Tracking Adjustment

9.4.2 Picture Quality Adjustment

NOTE: This control is effective only during playback.

This control lets you adjust the playback picture so the outline is sharper or softer.

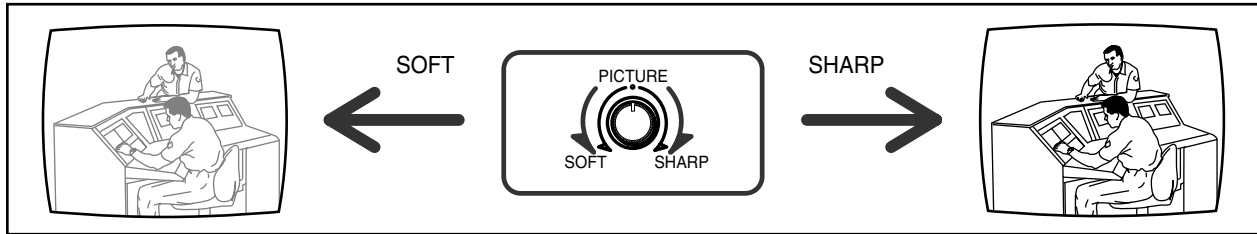

Figure 31. Picture Quality Adjustment

9.4.3 Vertical Adjustment

NOTES:

- *Picture vibration in L18H playback mode is not adjustable with the POSITION/VERTICAL ADJUST buttons.*
- *Horizontal vibration is not adjustable with the POSITION/VERTICAL ADJUST buttons.*
- *To return vertical adjustment to its initial setting, press the POSITION/VERTICAL ADJUST buttons (+ or -) at the same time during still playback.*

Do the following to reduce or eliminate picture vibration at the top and bottom.

1. If the vibration occurs in still, slow motion, fast playback (x2), or normal playback in 24H – 168H or 0H mode, play a tape recorded in 2H or 6H mode on this VCR and press the PAUSE/SHUTTLE HOLD button.

If the vibration occurs during normal playback in L24H mode, play a tape in its playback mode.
2. Press the POSITION/VERTICAL ADJUST buttons (+ or -) to reduce or eliminate picture vibration.

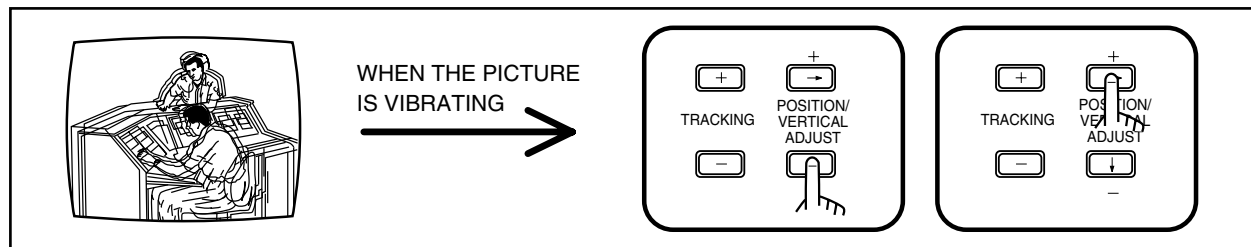

Figure 32. Vertical Picture Adjustment

10.0 ADDITIONAL FUNCTIONS AND FEATURES

10.1 COUNTER

10.1.1 Counter Memory

NOTE: The counter display is stored in memory when the power is turned off, so the same numbers will be displayed when the power is restored.

Press the COUNTER MEMORY/SKIP/INDEX button repeatedly until the "M" indicator appears on the fluorescent display. Turn the SHUTTLE ring to the right and the tape will rewind to the 00000 position of the counter and stop. (The rewind to 00000 is slightly inaccurate.)

10.1.2 Tape Counter

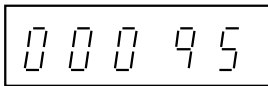

A five-digit counter indicates the relative position on the recorded portion of the tape. If a portion of the tape is not recorded on, the counter will not increase or decrease during play, FF/RWD, or search modes.

EEE EE illuminates to show VCR power is in standby mode.

10.1.3 Counter Reset

Press the COUNTER RESET button to reset the counter to 00000.

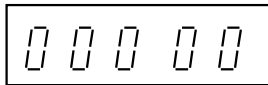

10.2 MEMORY BACKUP IN CASE OF POWER FAILURE

NOTE: The backup is for memory only—the VCR will not continue recording during a power outage unless connected to a UPS.

The VCR includes a built-in memory backup so the presets for time/date, alarm list, power loss list, and the number of tape uses will remain in memory if there is a power failure or if the power cord is disconnected from the AC outlet. Presets remain in memory for a maximum of 31 days provided the VCR has been connected to AC power for at least 40 hours per week. Connection charges the battery backup.

Check the time if there has been a power failure or if the power cord has been disconnected from AC power for a prolonged period.

10.3 POWER FAILURE TIME DISPLAY

```
<POWER LOSS LIST>
01 03 - 01 - 98 01 : 00
02
03
```

Power failure start times are stored in memory, so you can confirm the start times.

1. Press the DISPLAY button to display the Main menu.
2. Turn the JOG dial to select MAINTENANCE and turn the SHUTTLE ring to the right. The Maintenance menu will appear.
3. Turn the JOG dial to select POWER LOSS LIST and turn the SHUTTLE ring to the right. POWER LOSS LIST will appear.

Up to three power failure start times will be displayed. If more than three failures occurred, the first and last two times will be displayed.

To reset the power loss list, select POWER LOSS LIST CLEAR in the Maintenance menu and turn the SHUTTLE ring to the right. The POWER LOSS LIST CLEAR screen will appear. Turn the SHUTTLE ring to the left.

10.4 ELAPSED TIME DISPLAY

<REPEAT REC TIMES>	0
<ELAPSED TIME>	0H

The elapsed time of recording and playback is stored in memory. Use the elapsed time as a guide for periodic replacement of parts.

1. Press the DISPLAY button to display the Main menu.
2. Turn the JOG dial to select MAINTENANCE and turn the SHUTTLE ring to the right. The elapsed time (counted up to 89,999 hours) is displayed.
3. Press the DISPLAY button. The time display will appear.

11.1 INITIAL SYSTEM TESTING

Before using the newly-installed surveillance system, do the following:

- Make test recordings at the time-lapse speeds you will be using. Test how the system performs with alarms.
- Interrupt electrical power to check your installed power backup system (if applicable).
- On playback, verify picture quality and that you can see the time/date display under normal and alarm conditions.

11.2 REGULAR SYSTEM TESTING

Every day check that the system is operating. Is the REC indicator lit? Does the COUNTER display indicate movement? Does the monitor show proper camera sequencing and time/date information?

Check for recorded alarms. Multiple alarms could make the tape run out early. Make sure there is enough tape to record at least five minutes of alarm activity at the selected speed.

Regularly verify picture quality and operation under normal and alarm conditions. Play a tape recorded recently under normal conditions, which also includes an alarm condition that you triggered manually.

Regularly replace tapes (refer to Table E for a schedule). Check tapes for head scarring. Replace damaged tapes. Always store tapes in their boxes; away from magnetic fields, heat, direct sunlight, and dust.

12.0 TROUBLESHOOTING

12.1 SELF-DIAGNOSTIC FUNCTION AND WARNING DISPLAY

The VCR uses self-diagnostics to detect internal malfunctions during recording. If one occurs, the VCR indicates it on the monitor and in the VCR's fluorescent display.

Table J shows the type of malfunction corresponding to the warning display and the action to take.

Table J. Warning Display and Actions

FLUORESCENT DISPLAY	MONITOR	CAUSE	REMEDY	TO TURN OFF THE INDICATION
End	TAPE END	The tape ends during recording.	Rewind the tape and press the EJECT button.	Turn off the indication on the fluorescent display and on the screen by pressing the EJECT button or rewinding the tape.
–	NO SIGNAL	Lack of video signal input*.	Check for loose connections.	When a video signal is restored or the record mode is cleared, the indication on the screen turns off.
–	CHECK	Tape/deck trouble.	First, check the cassette. If there seems to be nothing wrong with it, try recording again. If "CHECK" is still displayed, change the cassette with a new one and try recording again. Otherwise, unplug the power cord and contact the dealer.	

* Lack of video input signal.

If the VCR is set to record and it does not detect an input signal, NO SIGNAL appears on the monitor and the call signal is output from the rear terminal.

Check that the cable from the camera is not broken and the camera's power has not been lost.

12.2 BEFORE CALLING FOR SERVICE

Symptom	Remedy
VCR does not operate.	<ul style="list-style-type: none"> • Is the LOCK indicator illuminated? • Is the power cord disconnected from the AC output? • Is the TIMER REC indicator illuminated?
The VCR power is on but unit does not operate.	<ul style="list-style-type: none"> • Is the LOCK indicator illuminated? • Safety devices are operating. Press the RESET button on the rear panel using a ballpoint pen or pencil.
No picture appears on the monitor.	<ul style="list-style-type: none"> • Is the video cable connected properly, or is the cable defective?
No operation when any tape operation button is pressed.	<ul style="list-style-type: none"> • Is the LOCK indicator illuminated? • Is a cassette inserted?
Recording does not work.	<ul style="list-style-type: none"> • Is the LOCK indicator illuminated? • Is the cassette's erasure prevention tab broken off? • Has the tape run out?
Recording cannot be stopped by pressing the STOP button.	<ul style="list-style-type: none"> • Is the LOCK indicator illuminated? • Is the TIMER REC indicator illuminated?
Timer recording does not work.	<ul style="list-style-type: none"> • Are the present time and recording time set accurately?
No operation when the PLAY button is pressed.	<ul style="list-style-type: none"> • Is the LOCK indicator illuminated? • Has the tape run out? • Is a cassette inserted?
Noise bars in the picture during playback.	<ul style="list-style-type: none"> • Has the TRACKING control been adjusted?
The picture vibrates at the top and bottom when in the still picture mode.	<ul style="list-style-type: none"> • Has the POSITION/VERTICAL ADJUST control been adjusted?
Clear camera pictures during recording but during playback the picture is not clear.	<ul style="list-style-type: none"> • This symptom may occur when the recorder has been used for a long period. During this time an oxide deposit has built up on the video heads, which must now be cleaned. Head cleaning requires expertise. Consult your dealer.
The picture is not clear.	<ul style="list-style-type: none"> • Is the camera focused?
The present time is incorrect even though the VCR is used everyday.	<ul style="list-style-type: none"> • Make sure the VCR has AC power supplied continuously for at least 40 hours per week.
The power cord was disconnected for less than 31 days but the present time has been reset.	<ul style="list-style-type: none"> • Make sure the VCR has AC power supplied continuously for at least 40 hours per week. • Contents stored in memory may be erased before the 31 days, depending on the charge time of the power failure compensation circuit. Set the present time again.
Repeat recording does not work.	<ul style="list-style-type: none"> • Is the repeat recording indicator illuminated? • Is the alarm recording started?
Alarm recording does not work.	<ul style="list-style-type: none"> • Is the external switch connected correctly?
Playback speed is fast or slow.	<ul style="list-style-type: none"> • Is the playback mode set to the desired mode with REC/PLAY MODE button?

13.0 SPECIFICATIONS

Power Source:	100-230 VAC, 50/60 Hz. (The included power cord is used for 120 VAC, 60 Hz)
Power Consumption:	Approximately 20 watts
Rating:	
ALM/CALL/MODE	Active: "Low" level, maximum current 50 mA (+5 VDC)/10 mA (+24 VDC) Non-active: Open, maximum voltage +24 VDC
SET/RST/REC	Active: When terminals are short-circuited or "Low" level voltage applied Non-active: Open, max. Voltage +17 VDC
CLK	Recording: A pulse of the frequency division ratio selected in REAR TERMINAL menu
Tape Format:	S-VHS/VHS 1/2" width high-density video cassette tape
Television System:	525 lines, 60 field NTSC-type color system
Video Recording System:	2 rotary heads, azimuth helical scanning system
Luminance Signal:	Frequency modulation recording
Color Signal:	Low frequency conversion, sub-carrier phase shift recording
Audio Track:	1 track
Tape Speed and Recording Time (with T-120 cassette):	

Record Mode	Record Time (T-120/ST-120 Tape)	Record Time (T-160/ST-160 Tape)	Field (Picture) Recording Rate	Tape Drive Mode	Audio Recording Capability
2H	2 Hrs.	2 Hrs.40 Mins.	60 Fields/Sec	Continuous	Yes
6H	6 Hrs.	8 Hrs.	60 Fields/Sec	Continuous	Yes
L18H	18 Hrs.	24 Hrs.	20 Fields/Sec	Continuous(Slow)	Yes
L24H	26 Hrs.	34 Hrs.40 Mins.	4.6 Fields/Sec	Continuous(Slow)	Yes
48H (SP)	50 Hrs.	Not Recommended	2.4 Fields/Sec	Time-lapse	No
48H (EP)	54 Hrs.	Not Recommended	6.7 Fields/Sec	Time-lapse	No
72H (SP)	74 Hrs.	Not Recommended	1.6 Fields/Sec	Time-lapse	No
72H (EP)	78 Hrs.	Not Recommended	4.6 Fields/Sec	Time-lapse	No
96H (SP)	98 Hrs.	Not Recommended	1.2 Fields/Sec	Time-lapse	No
96H (EP)	102 Hrs.	Not Recommended	3.5 Fields/Sec	Time-lapse	No
120H (SP)	122 Hrs.	Not Recommended	0.98 Fields/Sec	Time-lapse	No
120H (EP)	126 Hrs.	Not Recommended	2.9 Fields/Sec	Time-lapse	No
168H (SP)	170 Hrs.	Not Recommended	0.70 Fields/Sec	Time-lapse	No
168H (EP)	174 Hrs.	Not Recommended	2.1 Fields/Sec	Time-lapse	No
0H (one-shot)	1199Hrs.*	Not Recommended	0.10 Fields/Sec	Interval Time-lapse	No

* Programmed for: 1 Field-per-Shot @ 10-Second Interval Rate

Fast Forward/Rewind Time:	Approx. 140 sec. with T-120 cassette
Horizontal Resolution:	More than 240 lines (VHS mode) More than 400 lines (S-VHS, S-VHS ET modes)
Audio Frequency Response:	70 Hz-7 kHz (2H mode)
Signal-to-Noise Ratio:	Video: better than 42 dB Audio: better than 43 dB
Alarm Recording Time:	Timed: 15 sec/30 sec/45 sec/1 min./2 min./5 min./10 min. Manual 1: Until the alarm reset switch is switched on. Manual 2: Until the alarm set switch is switched off.
Display Format	(Month)-(Day)-(Year) (Day of week) (Hour) : (Minute) : (Second) (Recording mode) or (Month)-(Day)-(Year) (Hour) : (Minute) : (Second)
Display Position:	In any position
Timer Program:	8 programs; Daily start and stop time for one week
Memory Backup:	Lasts 31 days
Elapsed Time Indicator:	Maximum of 89,999 hours
Heads	
Video:	6 rotary single crystal heads
Audio/Control:	1 stationary head
Erase:	1 full-track head
Motors:	3 motors-drum/capstan direct drive system
Video Input:	0.5~2.0 Vp-p, 75-ohm S-connector (Y signal) and BNC plug; 0.15~0.6 Vp-p, 75-ohm S-connector (C signal)
Audio Input:	-8 dBs, 50k ohms, RCA plug
Microphone Input:	-67 dBs, 600 ohms, mini mic jack
Video Output:	1.0 Vp-p, 75-ohm S-connector (Y signal) and BNC plug; 0.3 Vp-p, 75-ohm S-connector (C signal)
Audio Output:	-6 dBs, 1k ohms, RCA plug
Connectors	
SET Input:	Screw terminal for starting alarm recording
RST Input:	Screw terminal for finishing alarm recording or for adjusting on-screen clock
REC Input:	Screw terminal for starting/finishing recording or for series recording or for synchronous recording
GND:	Screw terminal for ground
ALM Output:	Screw terminal for output while alarm recording is under way
CLK Output:	Screw terminal to command camera switching
MODE Output:	Screw terminal for indication of VCR selected mode
CALL Output:	Screw terminal for external warning device or for series recording
REMOTE Jack:	Jack for connecting the remote control unit
Operating Temperature:	41°F-104°F (5°C to 40°C)
Relative Humidity:	Maximum 80%
Dimensions:	3.7"H x 16.7"W x 12.4"D (Jog dial included) (9.3 x 42.5 x 31.5 cm)
Weight:	10 lb (4.5 kg)

(Design and product specifications subject to change without notice.)

NOTES

NOTES

14.0 WARRANTY AND RETURN INFORMATION

WARRANTY

Pelco will repair or replace, without charge, any merchandise proved defective in material or workmanship for a period of one year after the date of shipment.

Exceptions to this warranty are as noted below:

- Five years on FT/FR8000 Series fiber optic products.
- Three years on Genex® Series products (multiplexers, server, and keyboard).
- Three years on Camclosure® and fixed camera models, except the CC3701H-2, CC3701H-2X, CC3751H-2, CC3651H-2X, MC3651H-2, and MC3651H-2X camera models, which have a five-year warranty.
- Two years on standard motorized or fixed focal length lenses.
- Two years on Legacy®, CM6700/CM6800/CM9700 Series matrix, and DF5/DF8 Series fixed dome products.
- Two years on Spectra®, Esprit®, ExSite™, and PS20 scanners, including when used in continuous motion applications.
- Two years on Esprit® and WW5700 Series window wiper (excluding wiper blades).
- Eighteen months on DX Series digital video recorders, NVR300 Series network video recorders, and Endura™ Series distributed network-based video products.
- One year (except video heads) on video cassette recorders (VCRs). Video heads will be covered for a period of six months.
- Six months on all pan and tilts, scanners or preset lenses used in continuous motion applications (that is, preset scan, tour and auto scan modes).

Pelco will warrant all replacement parts and repairs for 90 days from the date of Pelco shipment. All goods requiring warranty repair shall be sent freight prepaid to Pelco, Clovis, California. Repairs made necessary by reason of misuse, alteration, normal wear, or accident are not covered under this warranty.

Pelco assumes no risk and shall be subject to no liability for damages or loss resulting from the specific use or application made of the Products. Pelco's liability for any claim, whether based on breach of contract, negligence, infringement of any rights of any party or product liability, relating to the Products shall not exceed the price paid by the Dealer to Pelco for such Products. In no event will Pelco be liable for any special, incidental or consequential damages (including loss of use, loss of profit and claims of third parties) however caused, whether by the negligence of Pelco or otherwise.

The above warranty provides the Dealer with specific legal rights. The Dealer may also have additional rights, which are subject to variation from state to state.

If a warranty repair is required, the Dealer must contact Pelco at (800) 289-9100 or (559) 292-1981 to obtain a Repair Authorization number (RA), and provide the following information:

1. Model and serial number
2. Date of shipment, P.O. number, Sales Order number, or Pelco invoice number
3. Details of the defect or problem

If there is a dispute regarding the warranty of a product which does not fall under the warranty conditions stated above, please include a written explanation with the product when returned.

Method of return shipment shall be the same or equal to the method by which the item was received by Pelco.

RETURNS

In order to expedite parts returned to the factory for repair or credit, please call the factory at (800) 289-9100 or (559) 292-1981 to obtain an authorization number (CA number if returned for credit, and RA number if returned for repair).

All merchandise returned for credit may be subject to a 20% restocking and refurbishing charge. Goods returned for repair or credit should be clearly identified with the assigned CA or RA number and freight should be prepaid. Ship to the appropriate address below.

If you are located within the continental U.S., Alaska, Hawaii or Puerto Rico, send goods to:

Service Department
Pelco
3500 Pelco Way
Clovis, CA 93612-5699

If you are located outside the continental U.S., Alaska, Hawaii or Puerto Rico and are instructed to return goods to the USA, you may do one of the following:

If the goods are to be sent by a COURIER SERVICE, send the goods to:

Pelco
3500 Pelco Way
Clovis, CA 93612-5699 USA

If the goods are to be sent by a FREIGHT FORWARDER, send the goods to:

Pelco c/o Expeditors
473 Eccles Avenue
South San Francisco, CA 94080 USA
Phone: 650-737-1700
Fax: 650-737-0933

Pelco, the Pelco logo, Camclosure, Esprit, Genex, Legacy, and Spectra are registered trademarks of Pelco. Endura and ExSite are trademarks of Pelco.

Copyright 1999, Pelco. All rights reserved.

Free Manuals Download Website

<http://myh66.com>

<http://usermanuals.us>

<http://www.somanuals.com>

<http://www.4manuals.cc>

<http://www.manual-lib.com>

<http://www.404manual.com>

<http://www.luxmanual.com>

<http://aubethermostatmanual.com>

Golf course search by state

<http://golfingnear.com>

Email search by domain

<http://emailbydomain.com>

Auto manuals search

<http://auto.somanuals.com>

TV manuals search

<http://tv.somanuals.com>