



KBD960/KBR960 Series Desktop Intelligent Keyboard



C1519M-E (6/06)

Contents

Regulatory Notices	6
Important Safeguards and Warnings	7
Description	8
Models	8
Reading This Manual	8
Keyboard Layout	9
LCD Display	9
Icon Keys	9
Keypad	9
Function Keys	9
Control Keys	10
Lens Keys	10
Joystick	10
Turbo Key	10
Escape Key	10
Installation	11
Connecting to the CM6800	11
Setup Mode	12
Activating Setup Mode	12
Calibrating the Joystick	13
Restoring Factory Default Settings	13
Creating a Setup Pin	13
Creating a Define Pin	14
Adjusting the Display Brightness	14
Configuring the COM Ports	15
Configuring the Function Keys	16
Exiting Setup Mode	16
Operation	17
Logging On	17
Logging Off	17
Accessing the KBD960 Menus	18
Sending/Receiving Keyboard Setups	29
Accessing the CM6800 Main Programming Menu	30
Diagnostic Mode	30
Testing the Display	31
Testing the Keyboard	31
Testing the Serial Ports	32
Testing the Dip Switches	32
Selecting Monitors	32
Main Menu 1	32
Monitor Menu	32
Function Key	33
Selecting Cameras	33
Main Menu 1	33
Camera Menu	33
Function Key	33
Operating PTZ Cameras	33
Advanced Operation	34
Presets	34
Creating Presets	34
Recalling Presets	34
Deleting Presets	34
Patterns	35
Creating Patterns	35

Pattern Length	36
Starting Patterns	36
Stopping Patterns	36
Zones	37
Rules to Follow When Creating Zones	37
Creating Zones	37
Partial Zone Overlap	38
Embedded Zones	39
Turning Zones On and Off	39
Erasing Zones	39
Macros	40
Starting Macros	40
Stopping Macros	40
Pausing Macros	41
Sequence	41
Starting Sequences	41
Stopping Sequences	41
Pausing Sequences	42
Operating Relays	42
Activating Relays Using F12	42
Activating Relays from the GPI Menus	42
Multiplexer Control	44
Video Loss	45
Alarms	45
Resetting Triggered Alarms	45
Appendix	46
Specifications	50

List of Tables

A	Function Key Defaults	16
B	Main Menu 1	18
C	Main Menu 2	19
D	Monitor Menu	19
E	Camera Menu 1	20
F	Camera Menu 2	20
G	MUX Menu 1	21
H	MUX Menu 2	22
I	Alarm Menu	22
J	GPI Menu 1	23
K	GPI Menu 2	24
L	Preset Menu	24
M	Macro Menu	25
N	Sequence Menu	25
O	Define Menu 1	26
P	Define Menu 2	26
Q	Define Preset Menu	27
R	Define Zone Menu	27
S	Setup LCD Menu	28
T	Programming Menu	28
U	Database Menu	29
V	Esprit Programming Menu	36
W	Relay Unit	43
X	Relay Unit 2	43
Y	Triggered Alarm Functions	45

List of Illustrations

1	KBD960/KBR960	9
2	Connecting to the CM6800	11
3	Enter Setup PIN	12
4	Setup Mode	12
5	Joystick Setup	13
6	Advance Setup 2	13
7	LCD Brightness Setup	14
8	Advance Setup 1	15
9	Key Define Mode	16
10	Logon Screen	17
11	Logoff Screen	17
12	Main Menu 1	18
13	Main Menu 2	18
14	Monitor Menu	19
15	Camera Menu 1	19
16	Camera Menu 2	20
17	MUX Menu 1	21
18	MUX Menu 2	21
19	Alarm Menu	22
20	GPI Menu 1	22
21	GPI Menu 2	23
22	Preset Menu	24
23	Macro Menu	24
24	Sequence Menu	25
25	Define Menu 1	26
26	Define Menu 2	26
27	Define Preset Menu	27
28	Define Zone Menu	27
29	Setup LCD Menu	27
30	Programming Menu	28
31	Database Menu	28
32	Password Screen	30
33	Main Programming Menu	30
34	Diagnostic Mode Menu	30
35	LCD Test	31
36	Keyboard Test	31
37	SIO Test	32
38	DIP Switch Test	32
39	Pattern Definitions	35
40	Basic Zone Creation	38
41	Partial Zone Overlap	38
42	Embedded Zones	39
43	MUX Control Menu	44
44	Icons Legend	46
45	Setup Mode Menu Tree (DIP Switch 2 ON)	47
46	Diagnostic Mode Menu Tree (DIP Switch 1 ON)	48
47	Operation Mode Menu Tree (DIP Switch 2 OFF)	49

Regulatory Notices

This device complies with Part 15 of the FCC Rules. Operation is subject to the following two conditions: (1) this device may not cause harmful interference, and (2) this device must accept any interference received, including interference that may cause undesired operation.

RADIO AND TELEVISION INTERFERENCE

This equipment has been tested and found to comply with the limits of a Class B digital device, pursuant to Part 15 of the FCC Rules. These limits are designed to provide reasonable protection against harmful interference in a residential installation. This equipment generates, uses, and can radiate radio frequency energy and, if not installed and used in accordance with the instructions, may cause harmful interference to radio communications. However there is no guarantee that the interference will not occur in a particular installation. If this equipment does cause harmful interference to radio or television reception, which can be determined by turning the equipment off and on, the user is encouraged to try to correct the interference by one or more of the following measures:

- Reorient or relocate the receiving antenna.
- Increase the separation between the equipment and the receiver.
- Connect the equipment into an outlet on a circuit different from that to which the receiver is connected.
- Consult the dealer or an experienced radio/TV technician for help.

You may also find helpful the following booklet, prepared by the FCC: "How to Identify and Resolve Radio-TV Interference Problems." This booklet is available from the U.S. Government Printing Office, Washington D.C. 20402.

Changes and modifications not expressly approved by the manufacturer or registrant of this equipment can void your authority to operate this equipment under Federal Communications Commission's rules.

In order to maintain compliance with FCC regulations, shielded cables must be used with this equipment. Operation with non-approved equipment or unshielded cables is likely to result in interference to radio and television reception.

This Class B digital apparatus complies with Canadian ICES-003.

Cet appareil numérique de la classe B est conforme à la norme NMB-003 du Canada.

Important Safeguards and Warnings

1. Read, keep, and follow these instructions.
2. Heed all warnings.
3. There are no user-serviceable parts inside this unit. Only authorized service personnel may open the unit.
4. Installation and servicing should only be done by qualified service personnel and conform to all local codes.
5. **WARNING:** To reduce the risk of fire or electric shock, do not expose this unit to rain or moisture if this unit is designed for indoor use only.
6. Unless this unit is specifically marked as a NEMA Type 3, 3R, 3S, 4, 4X, 6, or 6P enclosure, it is designed for indoor use only and it must not be installed where exposed to rain or moisture.
7. Do not expose this unit to dripping or splashing. Do not place objects filled with liquids, such as vases, on this unit.
8. Do not block any ventilation openings. Install in accordance with the manufacturer's instructions.
9. The installation method and materials should be capable of supporting four times the weight of the unit and equipment.
10. Do not install near any heat source.
11. Only use attachments/accessories specified by the manufacturer.
12. Clean only with dry cloth.
13. Do not defeat the safety purpose of the polarized or grounding-type plug.
14. Protect the power cord from being walked on or pinched, particularly at plugs, convenience receptacles, and the point where they exit from the unit.
15. Unplug this unit during lightning storms or when unused for long periods of time.
16. A CCC-approved power cord must be used to power this equipment when used in China.



This symbol indicates that dangerous voltage constituting a risk of electric shock is present within this unit.



This symbol indicates that there are important operating and maintenance instructions in the literature accompanying this unit.

CAUTION:
RISK OF ELECTRIC SHOCK. DO NOT OPEN.

Please thoroughly familiarize yourself with the information in this manual prior to installation and operation.

FOR QUALIFIED SERVICE PERSONNEL ONLY

1. Use only replacement parts recommended by Pelco.
2. After replacement/repair of this unit's electrical components, conduct a resistance measurement between line and exposed parts to verify the exposed parts have not been connected to line circuitry.

Description

The KBD960/KBR960 Keyboard includes Pelco's proprietary M protocol, allowing it to be used with all M devices, such as Pelco's latest matrix switch – the CM6800. You can program the keyboard, and you can create and execute macros. You have access to effective monitoring procedures for any CCTV application.

You can assign simple or complex functions to many of the keys. This allows you to configure the keyboard to suit a specific monitoring environment. Some of the keyboard features include the following:

- User-friendly, icon-driven design
- Select and monitor any connected camera or video input
- Control pan and tilt functions for cameras and configured receivers
- Control camera iris (zoom and focus) for configured equipment
- Control camera auxiliary functions for configured equipment
- Control peripheral devices, such as video printers, frame stores, and video multiplexers
- Select macros to execute complex procedures
- Store and recall camera presets for equipment with preset capabilities
- Download function key configurations to and from other keyboards

MODELS

KBD960-US	Programmable keyboard; 100-240 VAC, 50/60 Hz; comes with US-320-C5 power cord
KBD960-UK	Same as KBD960-US except for use in the United Kingdom with UK-320-C5 power cord
KBD960-AU	Same as KBD960-US except for use in Australia with AU-320-C5 power cord
KBD960-EU	Same as KBD960-US except for use in Europe with EU-320-C5 power cord
KBR960-US	Same as KBD960-US plus rack mountable
KBR960-UK	Same as KBD960-UK plus rack mountable
KBR960-AU	Same as KBD960-AU plus rack mountable
KBR960-EU	Same as KBD960-EU plus rack mountable

READING THIS MANUAL

Each icon key corresponds to an icon on the LCD display. Each icon represents a function.

You will be instructed to "Select [icon]" when reading this manual. Press the icon key that corresponds to the icon on the LCD.

The functions of the KBR960 are the same as the KBD960. The only difference is that the KBR960 models can be mounted onto a rack. Any reference in this manual to the KBD960 also applies to the KBR960 models.

You will read references to the CM6800. However, the M protocol allows this keyboard to be used with other M devices.

KEYBOARD LAYOUT

The KBD960 keyboard consists of the following:

- 1 LCD Display
- 2 Icon Keys
- 3 Keypad
- 4 Function Keys
- 5 Control Keys
- 6 Lens Keys
- 7 Joystick
- 8 Turbo Key
- 9 Escape Key

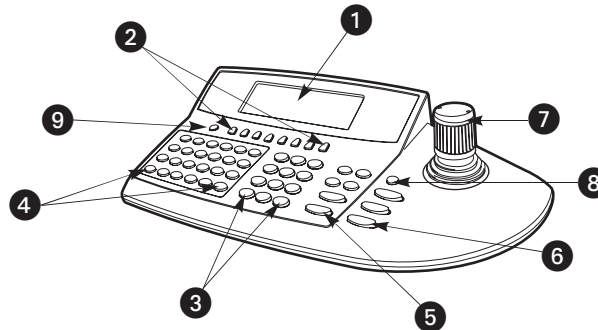

KBD960

00891

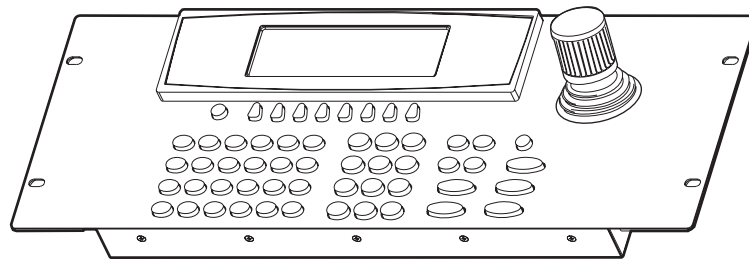

KBR960

Figure 1. KBD960/KBR960

LCD DISPLAY

The LCD is a four-line display. Each line displays different information.

- Line 1 Displays the video output (which is typically a monitor) and the video input source (which is typically a camera).
- Line 2 Displays the last number entered and the icon of the current menu.
- Line 3 Displays alarm messages and other prompts.
- Line 4 Displays the icons for the icon keys.

ICON KEYS

These eight blue keys correspond to the icons directly above on the LCD display. These icons change depending on the mode you are in.

KEYPAD





The keyboard has a standard numeric keypad with two additional keys for selecting cameras and monitors.

FUNCTION KEYS

The 24 function keys (F1-F24) can be programmed according to your application and the type of CCTV installation.



Refer to the *Installation* section for an explanation on how to program these keys. The supplied blank labels and punched LEXAN® decal overlay should be used.

CONTROL KEYS

-  Step backward through available camera selections
-  Step forward through available camera selections
-  Select and execute macros
-  **Rcl:** Recall previous selections
Alt: Reserved for future use
-  **Prst:** Recall preset
Lock: Reserved for future use

LENS KEYS

You can use these keys to control cameras equipped with motorized zoom lenses and motorized pan and tilt units. These keys are sometimes used to activate other functions. For example, the Open/Close key is also used when creating preset labels.

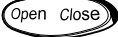
-  Zoom in/out
-  Focus near/far
-  Open/close the iris

JOYSTICK

The proportional joystick allows variable speed control. It gives you full control over the pan and tilt movements, from minimum to maximum speed. You should calibrate the joystick before setting up anything else.

TURBO KEY

Pressing this key while moving the joystick switches pan motors into high-speed mode on equipment that is capable of panning.

ESCAPE KEY

This key exits you from the mode you are in.

Installation

The following items are supplied:

- KBD960/KBR960 keyboard
- KBD-PS-1 universal power supply
- Two 25 ft (7.6 m) straight RJ-45 cables
- 10 blank labels and 10 punched LEXAN decal overlays
- One power cord (either US-320-C5, UK-320-C5, AU-320-C5, EU-320-C5)

CONNECTING TO THE CM6800

NOTE: Communication to the keyboards is RS-485. Pelco recommends using four-conductor, shielded, 18-gauge twisted pairs, such as Belden 9418, or a similar cable that meets or exceeds the basic requirements for EIA RS-485 applications.

1. Set all DIP switches OFF. The DIP switches are located on the bottom of the keyboard.
2. Connect the RJ-45 straight cable from COM 1 of the keyboard to the power supply. See Figure 2.
3. Connect the other RJ-45 straight cable from the power supply to COM 3 of the CM6800.
4. Plug in the power supply.

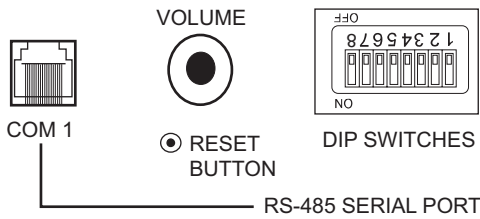

Main port used for power into keyboard, and for communication link to Pelco 6800. These I/O lines are connected to 8-pin RJ socket JP 1 as shown below. Incoming DC is also brought in via this COM port.

JP1 Pin	Function	JP1 Pin	Function
1	RS-485 Tx+	5	GND (0 VDC IN)
2	RS-485 Tx-	6	
3		7	RS-485 Rx-
4	+12 VDC IN	8	RS-485 R+

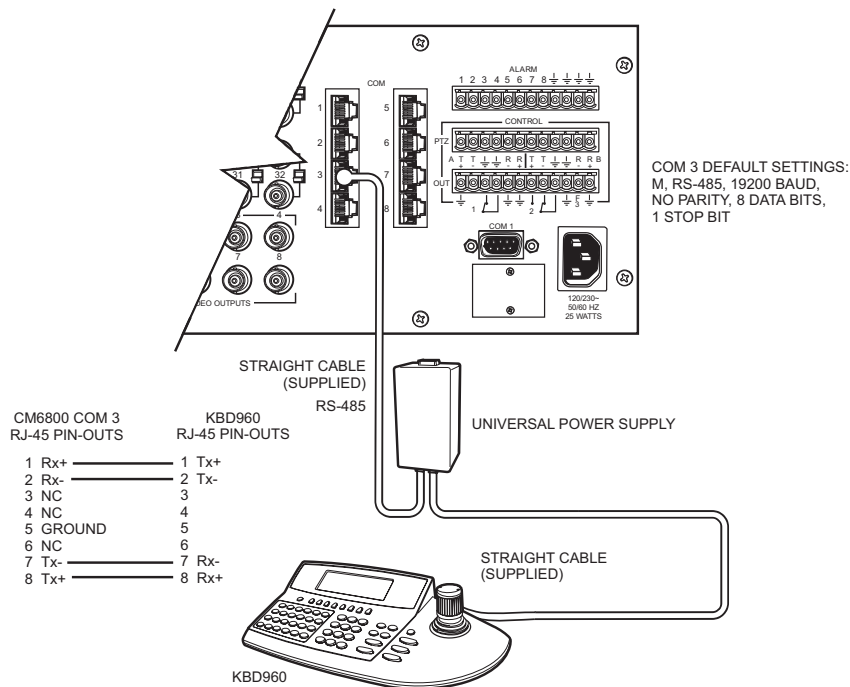

Figure 2. Connecting to the CM6800

SETUP MODE

You can configure the KBD960 in the Setup Mode. You can do the following:

- Create a Personal Identification Number (PIN) for entering the Setup Mode.
- Create a PIN that provides access to features on the Define Menu.
- Calibrate the joystick.
- Adjust the display brightness.
- Set the data transmission speeds for the keyboard's three COM ports.
- Define the function keys.
- Select a host port.

The default setup PIN is 1234. You can change it in the Setup Mode.

ACTIVATING SETUP MODE

1. Set DIP Switch 2 ON. "ENTER SETUP PIN" appears.

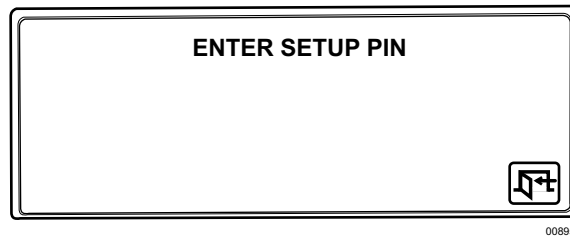

Figure 3. Enter Setup PIN

2. Enter your PIN number (the default number is 1234) and "SETUP MODE" appears.

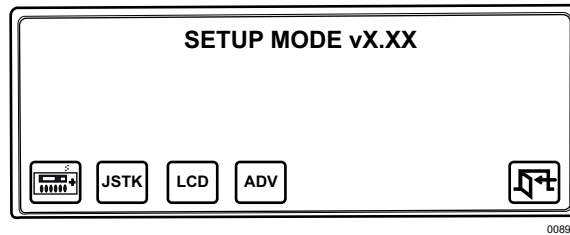

Figure 4. Setup Mode

CALIBRATING THE JOYSTICK

1. Select **JSTK** from Setup Mode. "JOYSTICK SETUP" appears on the LCD.

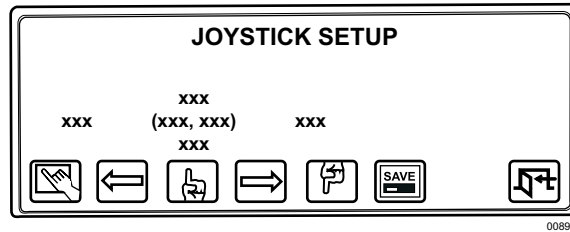









Figure 5. Joystick Setup

2. Select  with the joystick in the center default position.
3. Move the joystick completely to the left and select .
4. Move the joystick completely to the right and select .
5. Move the joystick completely down and select .
6. Move the joystick completely up and select .
7. Select  to save the joystick configuration.
8. Select  to return to the Setup Menu.



RESTORING FACTORY DEFAULT SETTINGS

1. Set DIP switches 1, 2, and 8 ON and recycle power.
2. Re-calibrate the joystick if using a keyboard version before 1.20.

For version 1.20 and later keyboards, the joystick is automatically calibrated during a factory default initialization.

CREATING A SETUP PIN

The factory settings for the KBD960 include the default setup PIN 1234. Follow these steps to change the default PIN:

1. Select **ADV** from Setup Mode.
2. Select  and/or  to locate Advance Setup 2.

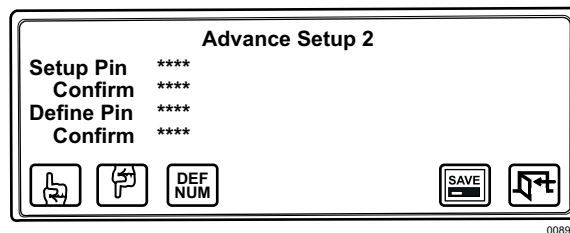



















Figure 6. Advance Setup 2

3. Select  and/or  to choose Setup PIN.
4. Select , enter a four-digit PIN, and select  once again.
5. Advance the cursor to the confirm row, select , re-enter your PIN, and select  once again. The menu indicates "OK" if confirmed.
6. Select  to save your PIN.

CREATING A DEFINE PIN

You also need a PIN to access the extended keyboard functions that are available in the Define Menu. The default define PIN is also 1234. Follow these steps to change it (refer to Figure 6):

1. Select  from Setup Mode.
2. Select  and/or  to locate Advance Setup 2.
3. Select  and/or  to choose Define PIN.
4. Select , enter a four-digit PIN, and select  once again.
5. Advance the cursor to the confirm row, select , re-enter your PIN, and select  once again. The menu indicates "OK" if confirmed.
6. Select  to save your PIN.

ADJUSTING THE DISPLAY BRIGHTNESS

1. Select  from Setup Mode.

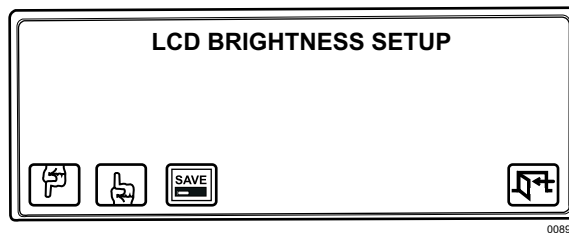







Figure 7. LCD Brightness Setup

2. Select  to make the display brighter or  to make the display dimmer.
3. Select  and then .

You can also adjust the display brightness by selecting  from the Define Menu. Refer to the *Operation* section of this manual.

CONFIGURING THE COM PORTS

1. Select  from Setup Mode and scroll to the Advance Setup 1 screen.

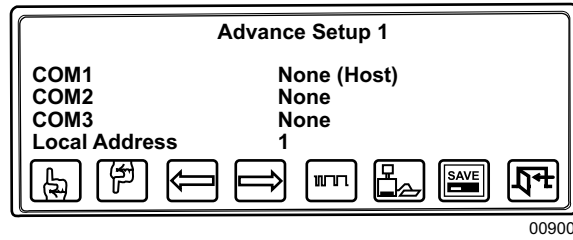













Figure 8. Advance Setup 1

2. Select  and/or  to navigate to the COM 1 row.
3. Select  and/or  to assign a baud rate.
4. Select  to set parity for the communications port.
5. Select  to set the Host.
6. Select  and/or  to navigate to the Local Address row.
7. Select  and/or  to assign an address.
8. Select  to save your configuration and then select  to return to the Setup Mode.

Default Settings

- COM 1 - 19200 baud, No Parity, Set as HOST
- Address -1

NOTES:

- COM 2 is functional, but only COM 1 is optimized for the protocol. COM 3 is not used for normal operation.
- Pelco recommends that you reserve addresses 1-8 for the KBD960/KBR960 keyboards. In System 6800, you should not use an address higher than 8.

CONFIGURING THE FUNCTION KEYS

1. Select  from Setup Mode to switch to the key define mode.

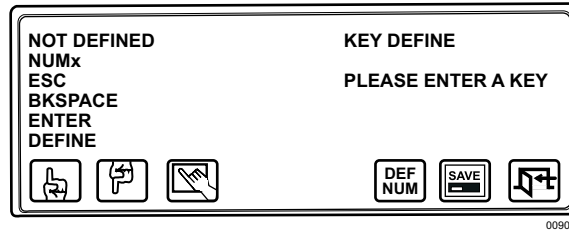









Figure 9. Key Define Mode

2. Press a function key you want to configure. If the key is already defined, its assigned function is shown. If not, "Def = NOT DEFINED" appears on the LCD screen.
3. Select  and/or  to scroll through the list of available functions.
4. Select  to choose a function.
5. Select  and enter the define number.
6. Select .
7. Select  and then .

NOTES:

- Refer to Table A for the factory default settings.
- Many of the functions do not require that you enter a define number. In those cases, skip steps 5 and 6.

Table A. Function Key Defaults

Function Key	Default Action	Function Key	Default Action
F1	Camera Auxilliary 1	F13	Multiplexer
F2	Camera Auxilliary 2	F14	Alarm Menu
F3	Camera Auxilliary 3	F15	Macro Menu
F4	Camera Auxilliary 4	F16	Sequence Menu
F5	Camera Auxilliary 5	F17	GPI Menu
F6	Camera Auxilliary 6	F18	Define Menu
F7	Camera Auxilliary 7	F19	Menu Forward
F8	Camera Auxilliary 8	F20	Menu Backward
F9	Camera Pattern 1	F21	Backspace
F10	Camera Pattern 2	F22	Enter
F11	Camera Pattern 3	F23	Clear
F12	External Relay 1	F24	---

NOTE: In the GPI Menu, F1-F8 are associated with the external relays in the current GPI.

EXITING SETUP MODE

1. Select .
2. Set DIP switch 2 OFF.

Operation

This section describes the operation of a CM6800 System using the KBD960 keyboard. Before you begin operating the KBD960, make sure you have completed the following:

1. Connections have been made and initial power-up has been completed.
2. CM6800 setup files have been programmed.
3. PINs have been set up to allow logging on, access to the setup functions, and access to the Define Menu.

You must also have the following information:

- The logical camera number list, complete with identification names
- The logical monitor number list, complete with identification names
- A list of all macros
- A list of all peripheral devices connected
- A list of alarms connected to the system
- A list of presets for each relevant camera

LOGGING ON

1. Set all DIP switches OFF.

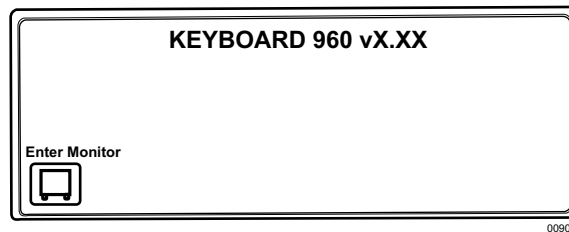





Figure 10. Logon Screen

2. Enter the monitor number and press .

LOGGING OFF

1. Select .
2. Select .

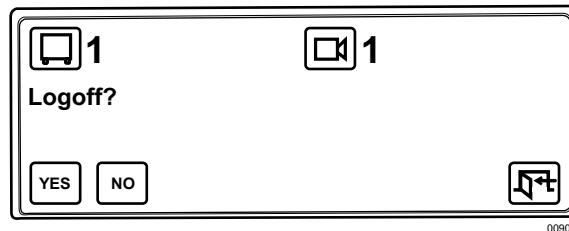



Figure 11. Logoff Screen

3. Select .

The keyboard goes offline for a short while before returning to the "Keyboard 960" display.

ACCESSING THE KBD960 MENUS

1. Set DIP switch 2 OFF.
2. Enter the number of the monitor and then press .
3. Press  and the Main Menu 1 icons appear.

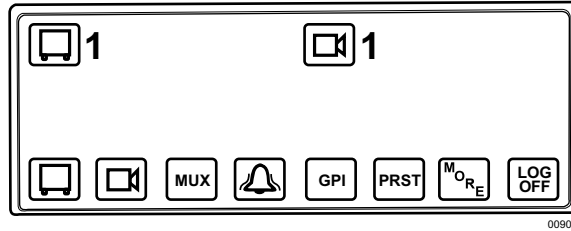









Figure 12. Main Menu 1

Table B. Main Menu 1

	Select to bring up the Monitor Menu. If you enter a number before selecting this icon, the monitor number changes to that number.
	Select to bring up the Camera Menu. If you enter a number before selecting this icon, the camera number changes and the camera switches on the current monitor without going into the Camera Menu.
	Select to bring up the MUX Menu. You can enter a number before selecting this icon. If you enter a number before selecting this icon, the multiplexer number changes and the system switches to that multiplexer without going into the MUX Menu.
	When an alarm is triggered, this icon appears on the keyboard screen. The current alarm shown on the user monitor is the alarm that appears when the Alarm Menu is selected.
	Select to bring up the GPI Menu. If you enter a GPI number before selecting this icon, control and data information are requested for the selected GPI.
	Select to bring up the Preset Menu. If you enter a number before selecting this icon, the preset is called without the Preset Menu being displayed.
	Select to bring up the next page (Main Menu 2).
	Select to log off the system.

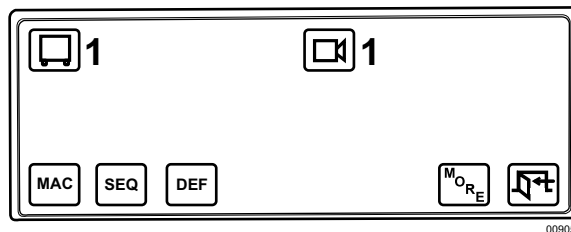









Figure 13. Main Menu 2

Table C. Main Menu 2

	Select to bring up the Macro Menu. If you enter a macro number before selecting this icon, the selected macro plays without having to go into the Macro Menu.
	Select to bring up the Sequence Menu. If you enter a sequence number before selecting this icon, the selected sequence plays without going into the Sequence Menu.
	Select to bring up Define Menu 1. You will see  and  . Enter your define PIN. You will not have to re-enter your define PIN unless the keyboard goes offline or you log off. When you enter your PIN, Define Menu 2 appears. You will also see  in Define Menu 2. You can adjust the display brightness in Define Menu 1 or Define Menu 2.
 or 	Selecting either one returns you to Main Menu 1.

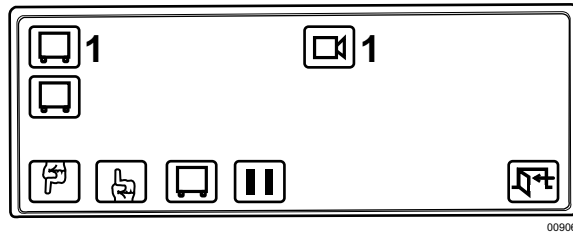







Figure 14. Monitor Menu

Table D. Monitor Menu

	Select to request the previous logical monitor number in the system and to grant control of the monitor if it is available. The logical monitor number range is 1-9999.
	Select to request the next logical monitor number in the system and to grant control of the monitor if it is available. The logical monitor number range is 1-9999.
	This icon indicates whether or not you have control of the monitor. A highlighted icon means you have control. Select this icon to request or release control of the selected monitor. If you enter a number before selecting this icon, the keyboard requests control of that monitor.
	Reserved for future use.
	Select this icon to return to Main Menu 1.

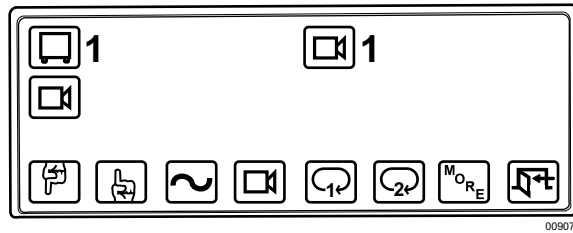









Figure 15. Camera Menu 1

Table E. Camera Menu 1

	Select to request the previous logical camera number in the system and grant control if it is available.
	Select to request the next logical camera number in the system and grant control if it is available.
	Select to run a selected pattern.
	This icon shows whether or not you have control of the selected camera. A highlighted icon means you have control. Select this icon to request or release control of the selected camera. If you enter a number before selecting this icon, the keyboard requests control of that camera.
	Select to send an AUX 1 set command to the selected camera. When you release the key, a clear command is sent.
	Select to send an AUX 2 set command to the selected camera. When you release the key, a clear command is sent.
	Select to bring up Camera Menu 2.
	Select to return to Main Menu 1.

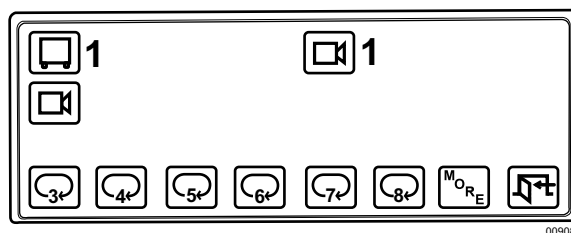









Figure 16. Camera Menu 2

Table F. Camera Menu 2

	Select to send an AUX 3 set command to the selected camera. When you release the key, a clear command is sent.
	Select to send an AUX 4 set command to the selected camera. When you release the key, a clear command is sent.
	Select to send an AUX 5 set command to the selected camera. When you release the key, a clear command is sent.
	Select to send an AUX 6 set command to the selected camera. When you release the key, a clear command is sent.
	Select to send an AUX 7 set command to the selected camera. When you release the key, a clear command is sent.
	Select to send an AUX 8 set command to the selected camera. When you release the key, a clear command is sent.
 or 	Select to return to Camera Menu 1

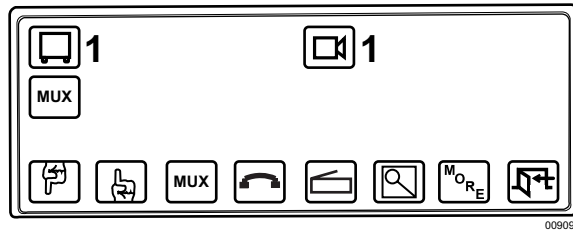

Figure 17. MUX Menu 1

Table G. MUX Menu 1

	Select to request the previous logical multiplexer number in the system and grant control of the multiplexer if it is available.
	Select to request the next logical multiplexer number in the system and grant control of the multiplexer if it is available.
	This icon shows whether or not you have control of the selected multiplexer. A highlighted icon means you have control. Select this icon to either request or release control of the selected multiplexer. If you enter a number before selecting this icon, the keyboard requests control of that multiplexer.
	Select to send a MUX TAPE command to the selected multiplexer.
	Select to send a MUX LIVE command to the selected multiplexer.
	Select to send a MUX ZOOM command to the selected multiplexer. If you enter a number before selecting this icon, the command sent to the multiplexer becomes a MUX SWITCH CHANNEL command to the specified channel.
	Select to bring up MUX Menu 2.
	Select to return to Main Menu 1.

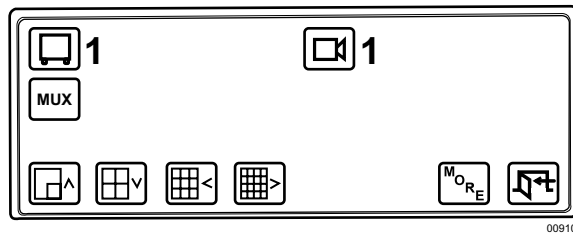







Figure 18. MUX Menu 2

Table H. MUX Menu 2

	Select to send a MUX PIP command to the selected multiplexer.
	Select to send a MUX 4-camera command to the selected multiplexer.
	Select to send a MUX 9-camera command to the selected multiplexer.
	Select to send a MUX 16-camera command to the selected multiplexer.
	Select to bring up MUX Menu 1.
	Select to return to Main Menu 1.

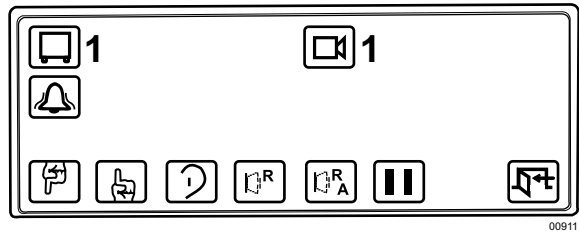









Figure 19. Alarm Menu

Table I. Alarm Menu

	Select to request the previous triggered logical alarm number in the system. The CM6800 matrix interprets this command as a Previous Alarm Step.
	Select to request the next triggered logical alarm number in the system. The CM6800 matrix interprets this command as a Next Alarm Step.
	Select to turn off the alarm siren of the keyboard.
	Select to send an ALARM RESET command for the currently displayed alarm.
	Select to send an ALARM RESET ALL command. The CM6800 matrix interprets this command as a Reset Current Alarm on all monitors.
	Select to pause an alarm that has been triggered.
	Select to return to Main Menu 1.

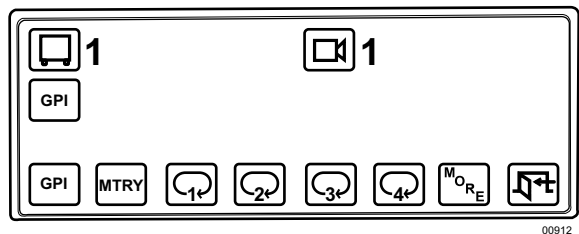









Figure 20. GPI Menu 1

Table J. GPI Menu 1

	<p>Select to set the current GPI to the input value. Select to request control of the selected GPI and send a message to gather information about the status of the auxiliaries within the GPI. You have control if this icon is highlighted.</p>
	<p>If this icon is highlighted, the auxiliary control method is momentary. If it is not highlighted, the auxiliary control method is latching. In momentary mode, selecting the icon sends an AUX ON command and releasing the key sends an AUX OFF command. The latching mode disables the AUX OFF command from being sent when the key is released. In latching mode, you can specify a number up to 6553 and then press the auxiliary number to set the auxiliary and have it unlatch at the specified time (1-6553 in seconds). If you do not enter a number, the auxiliary latches until an AUX OFF command is sent. You can issue an AUX OFF command by placing the keyboard in MTRY (momentary) mode again and pressing the key (when the key is released an AUX OFF is sent and the AUX ON when pressing the key is ignored).</p>
	<p>Select to send a set auxiliary command for the auxiliary within the selected GPI. Pressing the key sends an AUX ON and releasing it sends an AUX OFF in momentary mode.</p>
	<p>Select to send a set auxiliary command for the auxiliary within the selected GPI. Pressing the key sends an AUX ON and releasing it sends an AUX OFF in momentary mode.</p>
	<p>Select to send a set auxiliary command for the auxiliary within the selected GPI. Pressing the key sends an AUX ON and releasing it sends an AUX OFF in momentary mode.</p>
	<p>Select to send a set auxiliary command for the auxiliary within the selected GPI. Pressing the key sends an AUX ON and releasing it sends an AUX OFF in momentary mode.</p>
	<p>Select to bring up GPI Menu 2.</p>
	<p>Select to return to Main Menu 1.</p>

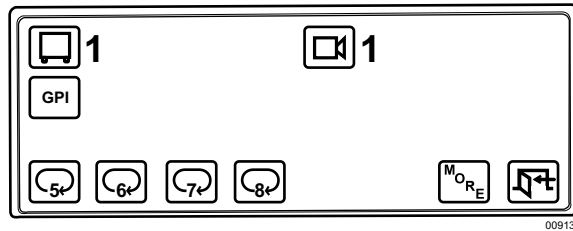







Figure 21. GPI Menu 2

Table K. GPI Menu 2

	Select to send a set auxiliary command for the auxiliary within the selected GPI. Pressing the key sends an AUX ON and releasing it sends an AUX OFF in momentary mode.
	Select to send a set auxiliary command for the auxiliary within the selected GPI. Pressing the key sends an AUX ON and releasing it sends an AUX OFF in momentary mode.
	Select to send a set auxiliary command for the auxiliary within the selected GPI. Pressing the key sends an AUX ON and releasing it sends an AUX OFF in momentary mode.
	Select to send a set auxiliary command for the auxiliary within the selected GPI. Pressing the key sends an AUX ON and releasing it sends an AUX OFF in momentary mode.
	Select to return to GPI Menu 1.
	Select to return to Main Menu 1.

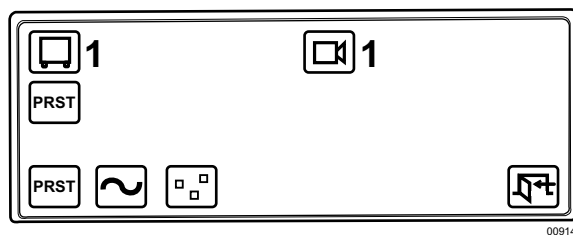





Figure 22. Preset Menu

Table L. Preset Menu

	Select to send a PRESET CALL command to the current camera.
	Select to send a PATTERN START command to the current camera. You can enter a number to initiate a specific pattern.
	Select to send a ZONE SCAN ON command to the current camera and display the "Zone On" text. When this text is displayed, you can select this icon again to send a ZONE SCAN OFF command, which displays the "Zone Off" text.
	Select to return to Main Menu 1.

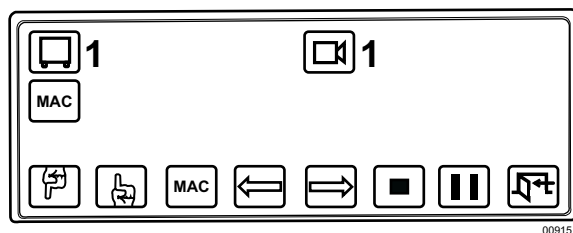









Figure 23. Macro Menu

Table M. Macro Menu

	Select to request the previous logical macro number in the system and grant control of the macro if it is available.
	Select to request the next logical macro number in the system and grant control of the macro if it is available.
	This icon shows whether or not the user has control of the selected macro. If the icon is highlighted, you have control. Select this icon to either request or release control of the selected macro. If you enter a number before selecting this icon, the keyboard requests control of that macro.
	Select to start or stop a macro.
	Select to start or stop a macro.
	Select to send a stop command to the selected macro.
	Select to send a MACRO PAUSE command to the selected macro.
	Select to return to Main Menu 1.

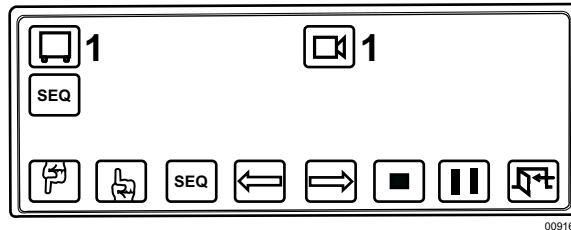









Figure 24. Sequence Menu

Table N. Sequence Menu

	Select to request the previous logical sequence number in the system and grant control of the sequence if it is available.
	Select to request the next logical sequence number in the system and grant control of the sequence if it is available.
	This icon shows whether or not you have control of the selected sequence. If the sequence is highlighted, you have control. Select this icon to request or release control of the selected sequence. If you enter a number before selecting this icon, the keyboard will request control of that sequence number.
	Select to send a SEQ PLAY BWD command to the selected sequence.
	Select to send a SEQ PLAY FWD command to the selected sequence.
	Reserved for future use.
	Reserved for future use.
	Select to return to Main Menu 1.

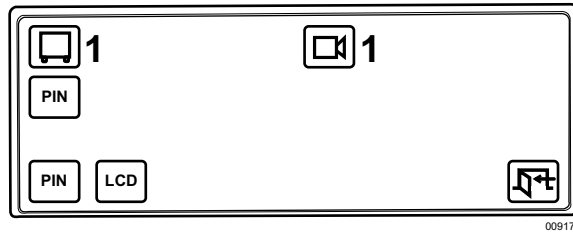



Figure 25. Define Menu 1

Table O. Define Menu 1

	Enter your PIN to bring up Define Menu 2. Define Menu 2 appears automatically if you have already entered your PIN. You will not have to re-enter your PIN unless the keyboard goes offline or you log off.
	Select to adjust the LCD display brightness.

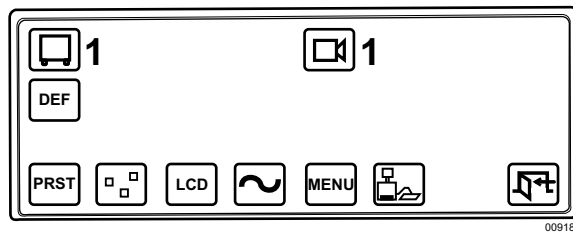









Figure 26. Define Menu 2

Table P. Define Menu 2

	Select to enter the Define Preset Menu.
	Select to enter the Define Zone Menu.
	Select to enter the Setup LCD Menu.
	Select to send a start pattern programming command to the current camera. A highlighted pattern symbol appears. Selecting pattern again stops the command and the pattern symbol becomes normal.
	Select to bring up the Programming Menu.
	Select to bring up the Database Menu.
	Select to return to Main Menu 1.

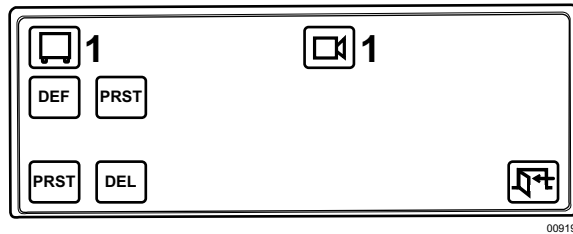





Figure 27. Define Preset Menu

Table Q. Define Preset Menu

	Select to send a set preset command and a preset label to the current camera. A preset number is required prior to selecting this icon.
	Reserved for future use.
	Select to return to the Define Menu.

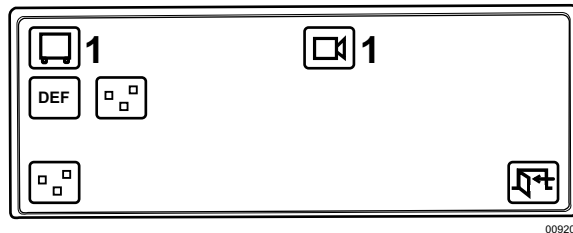



Figure 28. Define Zone Menu

Table R. Define Zone Menu

	Select to send a set zone command to the current camera.
	Select to return to the Define Menu.

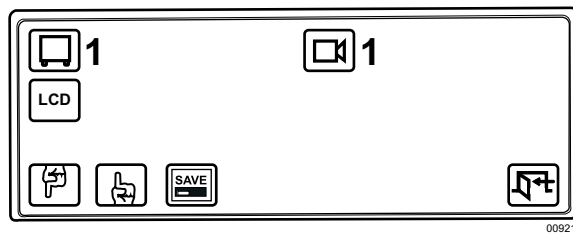





Figure 29. Setup LCD Menu

Table S. Setup LCD Menu

	Select to make the display brighter.
	Select to make the display dimmer.
	Select to save your settings.
	Select to return to the Define Menu.

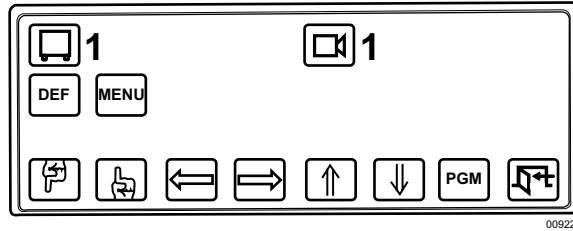









Figure 30. Programming Menu

Table T. Programming Menu

	Select to send a MENU ITEM DOWN command to the system master.
	Select to send a MENU ITEM UP command to the system master.
	Select to send a MENU ITEM LEFT command to the system master.
	Select to send a MENU ITEM RIGHT command to the system master.
	Select to increase the current item.
	Select to decrease the current item. Enter a number and select this icon to set the editing field.
	Select to display the program menu on your monitor.
	Select to return to the Define Menu.

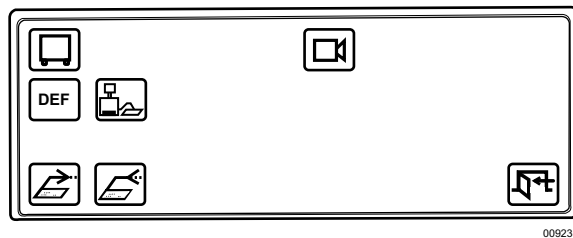





Figure 31. Database Menu

Table U. Database Menu



	Select to send the keyboard's key configuration to another keyboard. You must enter the local device address of the second keyboard. This is only sent to a device on the same bus as the keyboard.
	Select to receive another keyboard's key configuration database. You must enter the local device address of the second keyboard. This is only sent to a device on the same bus as the keyboard.
	Select to return to the Define Menu.

SENDING/RECEIVING KEYBOARD SETUPS

You can set up only one KBD960 keyboard and send the information to another keyboard. You can also receive the setup information from a connected keyboard.

The COM ports are located on the bottom of the keyboard.

Follow these steps to send or receive setup information between keyboards:

1. Select  from Define Menu 2 to bring up the Database Menu. See Figure 31.
2. Select  to send setup information to a connected keyboard.

"Sending Data" appears on the LCD. "Key Data Sent" appears on the LCD when the transfer is complete.

or

Select  to receive setup information from a connected keyboard.

"Receiving KeyDefs" appears on the LCD. "Keys Uploaded" appears on the LCD when the transfer is complete.

NOTES:

- COM 3 is RS-232 and is only used for sending/receiving settings between keyboards. It is not used for normal operation.
- To send/receive setup information, all KBD960 keyboards must be connected to the M bus. However, each keyboard must have a unique local M device address.

ACCESSING THE CM6800 MAIN PROGRAMMING MENU

1. Select **DEF**.
2. Enter your Define PIN.
3. Select **MENU**.
4. Select **PGM**. The following screen appears on your monitor.

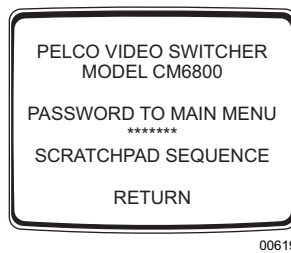

Figure 32. Password Screen

5. Enter your password (default is 2899100). The Main Programming Menu appears.

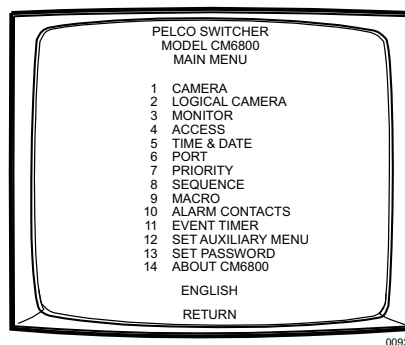

Figure 33. Main Programming Menu

Refer to the CM6800 Installation/Operation Manual for detailed instructions on setting the various items on the Main Programming Menu.

DIAGNOSTIC MODE

To activate the Diagnostic Mode set DIP switch 1 ON. This mode allows the following tests:

- LCD test
- Keyboard test
- Serial Input/Output (SIO) test
- DIP Switch test

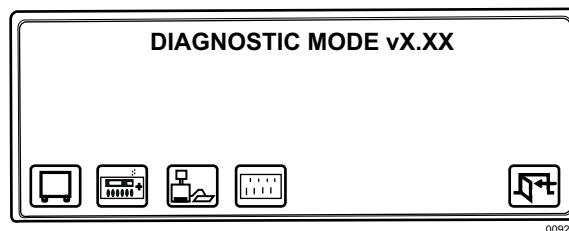







Figure 34. Diagnostic Mode Menu

TESTING THE DISPLAY

1. Select  while in the Diagnostic Mode.
2. Select  to test graphic page 0.
3. Select  to test graphic page 1.
4. Select  to test graphic page 2.
5. Select  to test the text page.
6. Select .

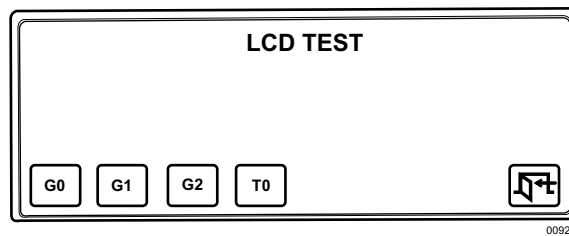



Figure 35. LCD Test

TESTING THE KEYBOARD

NOTE: If the software running on the KBD960 is v1.20 or later, then DIP switch 3 is used to indicate whether or not the software is taking A-to-D readings from the zoom axis of the joystick. If DIP switch 3 is OFF, you should see three readings (xxx, xxx, xxx) on the keyboard test screen. If the zoom A-to-D reading (the third reading) changes as you move the zoom top, DIP switch 3 should be OFF. If the zoom A-to-D reading does not change as you move the zoom top, DIP switch 3 should be ON.

1. Select .
2. Press each key to ensure that the display shows the correct key.
3. Select .

NOTE: Version 1.20 and later displays three joystick positions (xxx, xxx, xxx).

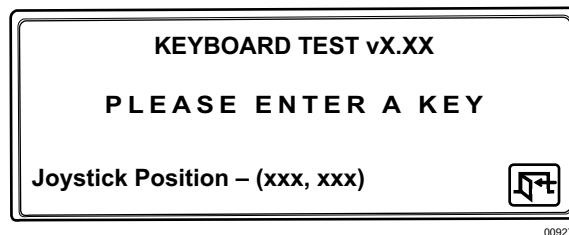

Figure 36. Keyboard Test

TESTING THE SERIAL PORTS

This test is reserved for factory use only.

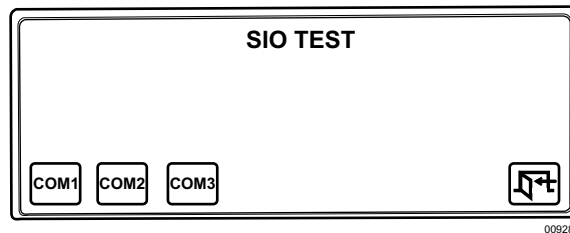



Figure 37. SIO Test

TESTING THE DIP SWITCHES

1. Select .
2. Beginning with switch 2, set each switch ON while observing the display.

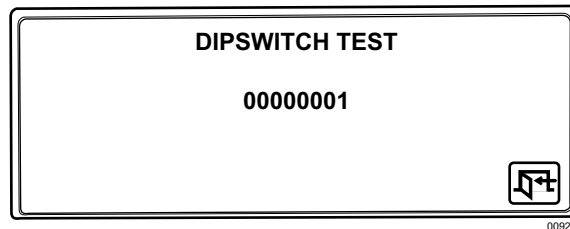





Figure 38. DIP Switch Test

SELECTING MONITORS



You can select up to eight monitors. There are several ways you can select monitors.



MAIN MENU 1

1. Enter the monitor number (1-8).
2. Press  or select .

The monitor number appears next to  on the keyboard LCD.

MONITOR MENU

1. Select  from Main Menu 1.
2. Cycle through the available monitors using  and/or .

You can also enter a monitor number and press  or select .

FUNCTION KEY

Follow these steps to select a monitor using F22:



1. Press .
2. Enter a monitor number.
3. Press F22.

NOTE: F22 is the “enter” default, but you can assign this function to one of the other function keys.



SELECTING CAMERAS



There are also several ways you can select cameras.

MAIN MENU 1

1. Enter a logical camera number (1-9999).
2. Press  or select . The camera number appears next to  on the keyboard LCD.

CAMERA MENU



1. Select  from Main Menu 1.
2. Cycle through the available cameras using  and/or .

You can also enter a camera number and press  or select .

FUNCTION KEY

Follow these steps to select a camera using F22:

1. Press .
2. Enter a camera number.
3. Press F22.

You can also use  and  to cycle through cameras.

NOTE: F22 is the “enter” default, but you can assign this function to one of the other function keys.

OPERATING PTZ CAMERAS

The controls for PTZ cameras are located on the right-hand side of the keyboard.

The proportional joystick allows variable speed drives. It gives you full control over the pan and tilt movements, from minimum to maximum speed. Speed is proportional to the amount by which you move the joystick from its center location.

Press  while moving the joystick to enable high speed operation.

The joystick only provides directional control when a fixed speed PTZ camera is installed.

The various functions of a PTZ camera can be controlled as follows:

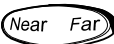
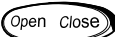
1. To zoom in or out, use .
2. To focus near or far, use .
3. To open or close the iris, use .

Advanced Operation

PRESETS

A preset camera position is a set of parameters which define pan, tilt, zoom, and focus adjustments. There are four ways you can recall a preset camera position:

- Manually using the keyboard
- Automatically as the result of an alarm condition
- From a macro command
- From a sequence command

NOTE: Presets are only possible when receivers or pan/tilt units have preset capability.

CREATING PRESETS

There are 64 available presets. For example, follow these steps to create Preset 1:

1. Move the joystick to the desired position.
2. Select **DEF** from Main Menu 2. Refer to Table C.
3. Select **PRST** to bring up the Preset Menu.
4. Enter 1 and select **PRST**. "PROGRAMMING PRESET 01 ENTER PRESET LABEL" appears on the monitor.
5. Press **Open Close** to scroll through the alphanumeric characters. Each preset label can have up to 20 characters. Move the joystick to the right to set each character.
6. Move the joystick to SET and then to the right.

NOTE: You are asked for your PIN only when you access the Define Menu for the first time after logon.

RECALLING PRESETS

Follow these steps to recall the preset you created:

1. Go to Main Menu 1.
2. Enter 1.
3. Select **PRST** or press **Prst Lock**. The camera moves to the preset position and the preset label appears on the monitor.

DELETING PRESETS



Follow these steps to delete the preset you created above:

1. Select **DEF** from Main Menu 2.
2. Enter 1 and select **PRST**. "PROGRAMMING PRESET 01 ENTER PRESET LABEL" appears on the monitor.
3. Move the joystick down to DELETE and then to the right.

PATTERNS

A pattern is a user-defined, viewable camera path with a definite beginning and end. You must create a pattern before the time-out clock expires. For example, the timer is 60 seconds. If you are using a Spectra II®, the timer is 1.5, 3, or 6 minutes. (See the section on *Pattern Length*.) You will not see the time-out clock on the monitor.

CREATING PATTERNS

1. Move the joystick to a desired starting point.
2. Select **DEF** from Main Menu 2. Refer to Table C.
3. Select . The icon becomes highlighted and "PROGRAMMING PATTERN" appears on the monitor.
4. Move the joystick to a desired end point before time-out.
5. Select  again to save the pattern. The icon returns to normal.

NOTE: Your pattern can be the same length as the time-out clock, or it can be less than the time-out clock.

Figure 39 shows a viewing area within which pattern definition can take place. The line segment shows one of many paths along which a pattern definition can be created.

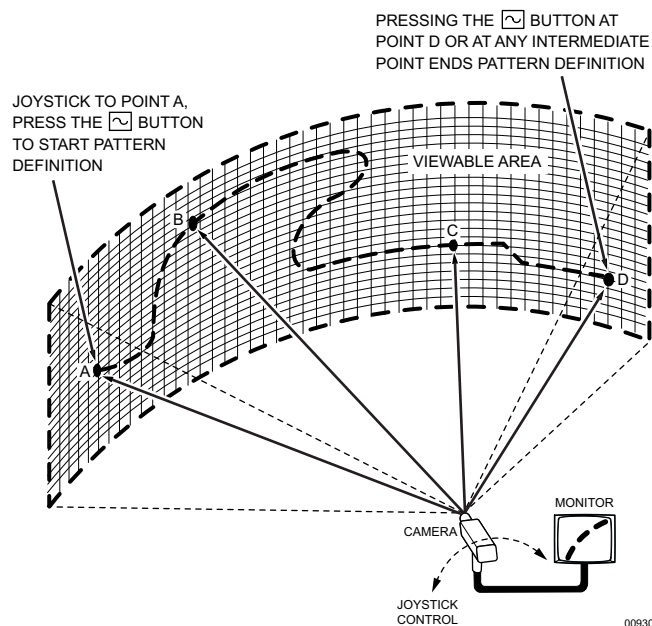
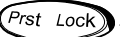

Figure 39. Pattern Definitions

PATTERN LENGTH

You can set three time values for single pattern lengths and three corresponding time values for two half-pattern lengths from the Esprit™ Programming Menu. The single pattern lengths are 1.5 minutes, 3 minutes, and 6 minutes. The corresponding half-pattern lengths are 0.75 minutes, 1.5 minutes, and 3 minutes.

Follow these steps to bring up the programming menu:

1. Go to Define Menu 2. Refer to Table C.
2. Enter 95 and press the Prst side of .

The monitor displays the Preset Label Menu. The Programming Menu appears when you click Set.



3. Perform the steps in Table V.

NOTE: If the Esprit programming menu shows no choices for pattern creation, then you have early models and are limited to creating and running patterns based on the time values of 60 seconds for full and 30 for half-patterns. Intercept® equipment also uses 60 seconds for a full pattern and 30 seconds for half-patterns.

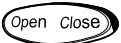
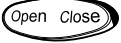
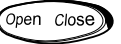
Table V. Esprit Programming Menu

1. Move the joystick to position the cursor beside Other.
2. Press the **Open** side of  to enter the submenu.
3. Position the cursor beside Pattern Length.
4. Press the **Open** side of .
5. Scroll through the available pattern lengths (1.5, 3, or 6). For two half-patterns of 0.75 minutes each, select 1.5; for two half-patterns of 1.5 minutes each, select 3; and for two half-patterns of 3 minutes each, select 6.
6. Press the Open side of  to make your time selection.
7. Exit the menu.

STARTING PATTERNS

1. Select  from Main Menu 1.
2. Select . "RUNNING PATTERN" appears on the monitor. The pattern runs from start to finish, returns to its start position, and begins again.

STOPPING PATTERNS

Move the joystick to stop a running pattern.

ZONES

A zone is a user-defined space to which a label is attached and a camera is associated. The camera used at the time the zone boundaries are defined is associated with the zone. The zone label appears on the selected monitor after zone definition if you move the camera within the defined zone. You can define and associate up to eight zones with the same camera. A priority level (1-8, with 8 being the highest) is assigned to each zone.





RULES TO FOLLOW WHEN CREATING ZONES

You must remember these points before you create a zone:

- Always move the joystick so that camera movement is from left to right. Refer to Figure 40.
- If you create eight equally spaced zones for a single camera, it would include an entire circle and each zone would cover an angular distance of about 45 degrees (if camera/receiver configuration and site geometry allow).
- Name each defined zone so that each zone priority can be easily identified.
- Plan physical placement and associated priority levels ahead of time if you anticipate creating many zones for a camera.
- You must assign a priority level (1-8) before you create a zone. Priority levels are hierarchical and are only relevant when multiple zones are being created.

CREATING ZONES

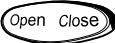
NOTE: To create zones when using Spectra III cameras, you must enable the zone label display in the Spectra III menus.

1. Move the joystick to Point A
2. Select  from Main Menu 2 and enter your PIN, if necessary.
3. Select .
4. Enter a zone priority level (1-8) and select  again. The icon becomes highlighted signaling the start of zone creation. "Edit label. Ack-set for left edge. Pan right. Press 81 & F5 for right edge." appears on the monitor.
5. Press  to scroll through the alphanumeric characters. Each zone label can have up to 20 characters. Move the joystick to the right to advance to the next character.
6. Move the joystick to SET and then to the right. The zone label appears on the monitor.
7. Move the joystick to Point B. You should move the joystick from left to right only.
8. Enter the priority level again and select . The icon returns to normal.

Repeat these steps if you want to create additional zones.

If you move the associated camera through the area defined by the zone (approaching the zone edges from either direction), the zone label appears on the selected monitor as you enter the zone and disappears as you exit the zone. Refer to Figure 40.

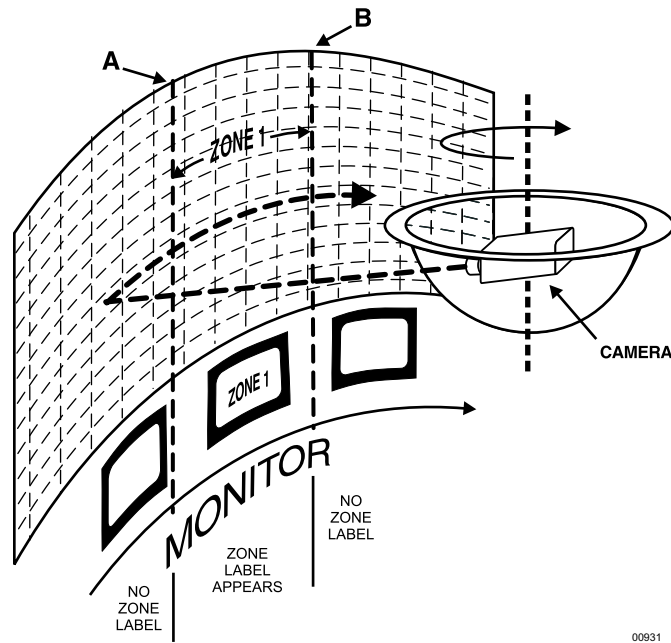

Figure 40. Basic Zone Creation

PARTIAL ZONE OVERLAP

Partial zone overlap occurs when the end of one zone overlaps with the beginning of another zone. The zone with the highest priority level appears at all times. Refer to Figure 41.

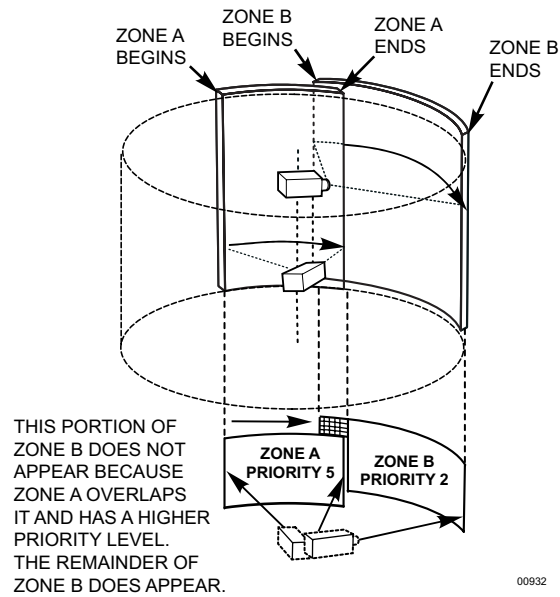

Figure 41. Partial Zone Overlap

EMBEDDED ZONES

An embedded zone is a zone that is between two other zones. In Figure 42, Zone C is embedded between Zone A and Zone B.

An embedded zone is not seen unless its priority level is higher than the priority level of the other zones. Since Zone C has a priority level of 6, portions of Zone A and Zone B are not seen.

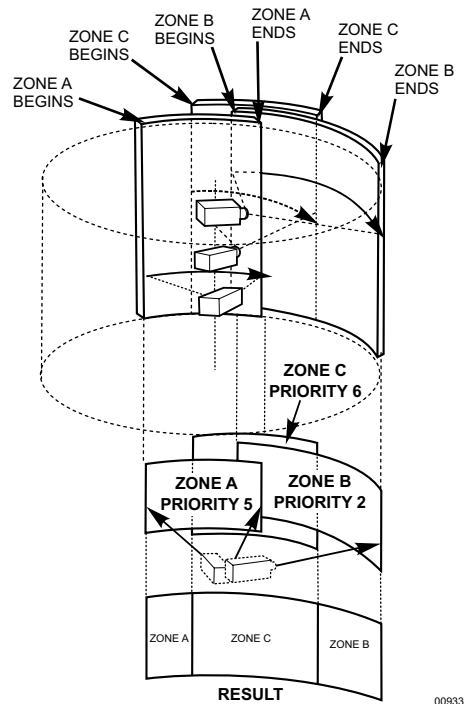

Figure 42. Embedded Zones

TURNING ZONES ON AND OFF

Follow these steps to turn zones on and off:

1. Select from Main Menu 1 to bring up the Preset Menu.
2. Select . "ZONES OFF" or "ZONES ON" appears.
3. Select again to either turn the zones off or on.

ERASING ZONES

1. Select from Main Menu 2.
2. Select .
3. Enter the priority level of a zone you want to erase and select again.
4. Move the joystick down and select SET. The zone is erased.

Repeat these steps to erase other zones. You can also use these steps to start over should you make a mistake during zone creation.

NOTE: DO NOT pan left or right while erasing zones.

MACROS

A macro is a sequence of commands or steps. When you run a macro, the steps programmed into that macro are performed. Macros can be run manually or automatically. Automatic operation can be the result of alarms or the reaching of specific times and dates.





If you want to start a macro, make sure no other keyboard has control of the PTZ on the monitor that you want the macro to start on.

When a macro completes all its steps, it stops and only runs again if restarted. A continuous macro runs until you clear it or stop it.

To set up a macro, you must bring up the CM6800 Programming Main Menu from the KBD960 or use the CM6800-MGR Program Manager.

STARTING MACROS

There are two ways you can start a macro. For example, follow these steps to start macro number 1:

1. Go to Main Menu 2.
2. Select .
3. Select  or  to scroll to macro number 1.
4. Select  or  to start the macro.

or





1. Go to Main Menu 2.
2. Enter 1.
3. Select .

STOPPING MACROS

There are two ways you can stop a macro. Follow these steps to stop macro number 1:





1. Go to Main Menu 2.
2. Enter 1.
3. Select .

or

1. Go to the Macro Menu.
2. Select  or  to scroll to macro number 1.
3. Select either , , or .

PAUSING MACROS

Follow these steps to pause macro number 1:

1. Go to Main Menu 2.
2. Select .
3. Select  or  to scroll to macro number 1.
4. Select  to pause the macro.
5. Select  again to restart the macro.

SEQUENCE

You can select up to 16 sequences. Camera number and title, sequence status, and time/date appear on the monitor when you select a sequence.

To set up a sequence, you must bring up the CM6800 Programming Main Menu from the KBD960 or use the CM6800-MGR Program Manager.

There can be 72 steps in a sequence. A sequence can consist of various commands (patterns, presets, random scan, frame scan, stop scan) and auxiliaries (global auxiliary on/off or camera auxiliary on/off).

STARTING SEQUENCES

You can start a sequence from Main Menu 2 or from the Sequence Menu:



1. Go to Main Menu 2.
2. Enter a sequence number (1-16).
3. Select .

or

1. Go to the Sequence Menu.
2. Select  or  to scroll through available sequences.
3. Select  or .

STOPPING SEQUENCES





There are two ways to start a sequence:

1. Go to the Sequence Menu.
2. Select  or  to scroll to the sequence number.
3. Select .

or

Enter a camera number.

PAUSING SEQUENCES

1. Go to Main Menu 2.
2. Select .
3. Select  or  to scroll to the sequence number.
4. Select  to pause the sequence.
5. Select  again to restart the sequence.

OPERATING RELAYS

To operate relays from a KBD960 keyboard, you must know which GPI to call and which auxiliary (AUX) to select on the keyboard.

You can cascade two relay units. Each relay unit has eight GPIs. Relay Unit 1 has a GPI range of 1-8, and Relay Unit 2 has a GPI range of 9-16. Refer to Tables W and X.

There are two ways you can operate relays from the KBD960.

ACTIVATING RELAYS USING F12

Follow these steps to activate a momentary relay:

1. Go to Main Menu 1.
2. Enter a logical relay contact number (1-128).
3. Press F12.

A momentary relay does not remain on. Only a latched relay remains on. If you want a latched relay, you must activate it from the GPI menus.





ACTIVATING RELAYS FROM THE GPI MENUS

You can activate relays from the GPI menus as momentary or latching. A momentary relay goes on briefly and then turns off. A latched relay remains on until you turn it off.

NOTE: You will hear a brief click from the relay unit whenever you activate a momentary or latching relay contact.

Momentary

To activate relay contact 4, for example, follow these steps:

1. Go to Main Menu 1 and enter 1 (GPI). GPI 1 is associated with relay contact 4. Refer to Table C.
2. Select  to bring up GPI Menu 1. This menu displays auxiliaries 1-4. Make sure  is highlighted. When  is highlighted, any relay you activate will be momentary.
3. Select .

Latching

To activate the same relay as latching, follow these steps:





1. Go to Main Menu 1 and enter 1 (GPI).
2. Select  to bring up GPI Menu 1.
3. Select  so that it is not highlighted. When  is not highlighted, any relay you activate latches (remains on).
4. Select . This icon becomes highlighted.
5. Select  and then the highlighted auxiliary icon to turn off the latched relay.

Table W. Relay Unit

GPI	Relay Contacts							
1	1	2	3	4	5	6	7	8
2	9	10	11	12	13	14	15	16
3	17	18	19	20	21	22	23	24
4	25	26	27	28	29	30	31	32
5	33	34	35	36	37	38	39	40
6	41	42	43	44	45	46	47	48
7	49	50	51	52	53	54	55	56
8	57	58	59	60	61	62	63	64
Associated AUX	1	2	3	4	5	6	7	8

Table X. Relay Unit 2

GPI	Relay Contacts							
9	65	66	67	68	69	70	71	72
10	73	74	75	76	77	78	79	80
11	81	82	83	84	85	86	87	88
12	89	90	91	92	93	94	95	96
13	97	98	99	100	101	102	103	104
14	105	106	107	108	109	110	111	112
15	113	114	115	116	117	118	119	120
16	121	122	123	124	125	126	127	128
Associated AUX	1	2	3	4	5	6	7	8

NOTE: In Relay Unit 2, GPI's 9-16 are associated with the physical relays (1-64) on the back of the unit. However, GPI's 9-16 are also associated with logical relays 65-128. For example, the physical relays for GPI 9 are 1-8 and the logical relays are 65-72.

An REL2064 relay unit set for GPI 1 overlaps with the internal relays on the CM6800. Auxiliary commands sent to external relays 1-3 also operate the internal relays on the CM6800. You can set the relay range of the REL2064 higher if you want to avoid overlapping the external relays with internal relays 1-3.

If you press F12 on the keyboard, auxiliary commands are sent to the CM6800 and operate the internal relays of the CM6800, as well as external relays.











Auxiliary commands sent from the GPI Menu go directly to the REL2064 to control the external relays only. However, if an REL2064 relay unit is not set for GPI 1, auxiliary commands sent from the GPI menu operate the CM6800 relays.

MULTIPLEXER CONTROL

You can also control multiplexers with the KBD960 keyboard. You can connect multiplexers to any input.

Refer to the CM6800 Installation/Operation Manual for instructions on setting the multiplexers for keyboard control.

Follow these steps to control multiplexers:

1. Enter a MUX input number and press . Each MUX input is associated with a camera input. Figure 43 shows MUX 1 being controlled.
2. Select . MUX Menu 1 appears.  should be highlighted, which means you have MUX control.
3. Cycle through the 16 picture inserts (if you have a 16-channel multiplexer) by entering the camera number and selecting .
4. Select  again to zoom into the MUX camera. You can move the joystick to view a specific area.
5. Select  to bring up MUX Menu 2. The icons for a picture-in-picture display, 4-camera display, 9-camera display, and 16-camera display appear.
6. Select  to view four of the available 16 cameras on one monitor. You can cycle through all 16 cameras, four at a time, by repeatedly selecting .
7. Select  to view nine of the available 16 cameras on one monitor. Select again to see the remaining seven cameras.
8. Select  to view all 16 available cameras on one monitor.

NOTE:  does not work on a 9-channel multiplexer.

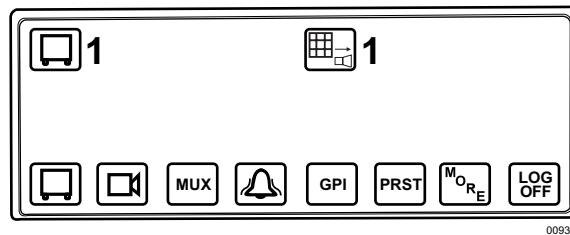

Figure 43. MUX Control Menu

VIDEO LOSS

The loss of a video signal may alert you or trigger an alarm. The alarm is reported back to the keyboard. Using the video loss function, faulty cameras can be disabled if necessary.

ALARMS





Alarms can be armed or disarmed from the KBD960 keyboard using the System 6800 menus.

RESETTING TRIGGERED ALARMS

A triggered alarm causes a continuous tone. The alarm volume can be altered using the level control on the bottom of the keyboard.

You cannot turn on an alarm that has been muted. It stays muted until all alarms on the current monitor are cleared or the user switches monitors. This alerts all operators who have access to the alarm.

Table Y. Triggered Alarm Functions

Flashing  with number	This means the specific alarm number has been triggered.
	Select this icon to mute the triggered alarm.
	Select to reset the triggered alarm.
	Select to reset all triggered alarms. This does not reset all alarms in CM6800.
	Select this icon to pause a triggered alarm.

Appendix



































































 LOG OFF	 JOYSTICK ADJUST	 AUX 4, RELAY 4	 4-CAMERA MUX
 LOG OFF YES	 ADVANCE MENUS	 AUX 5, RELAY 5	 9-CAMERA MUX
 LOG OFF NO	 SERIAL PORT TEST	 AUX 6, RELAY 6	 16-CAMERA MUX
 SETUP/DEFINE PIN	 SEND KEYBOARD SETUP	 AUX 7, RELAY 7	 LIVE MUX
 SAVE SELECTION	 RECEIVE KEYBOARD SETUP	 AUX 8, RELAY 8	 MUX CAMERA CONTROL
 DELETE	 TEST GRAPHIC PAGE 0	 RESET ALARM	 SEQUENCE MENU
 MORE MENU	 TEST GRAPHIC PAGE 1	 RESET ALL ALARMS	 CAMERA PRESET
 EXIT	 TEST GRAPHIC PAGE 2	 MUTE	 PATTERN
 CAMERA SELECTION	 TEST TEXT PAGE 0	 ALARM	 ZONE
 MONITOR SELECTION	 PARITY	 GPI MENU	 DEFINE MENU
 SCROLL UP SCROLL FIELD UP	 DIP SWITCH TEST	 RELAY MOMENTARY	 PROGRAM MENU
 SCROLL DOWN SCROLL FIELD DOWN	 DISPLAY BRIGHTNESS	 MACRO SELECT	 DEFINE NUMBER
 PLAY FWD SCROLL RIGHT	 COM PORT 1	 DEVICE PAUSE	 MENU
 PLAY BWD SCROLL LEFT	 COM PORT 2	 STOP	
 SCROLL OPTION UP	 COM PORT 3	 MUX MENU	
 SCROLL OPTION DOWN	 AUX 1, RELAY 1	 TAPE MUX	
 KEYBOARD SELECT	 AUX 2, RELAY 2	 ZOOM MUX	
 KEYBOARD KEY TEST	 AUX 3, RELAY 3	 PIC IN PIC MUX	

Figure 44. Icons Legend



00936

Figure 45. Setup Mode Menu Tree (DIP Switch 2 ON)

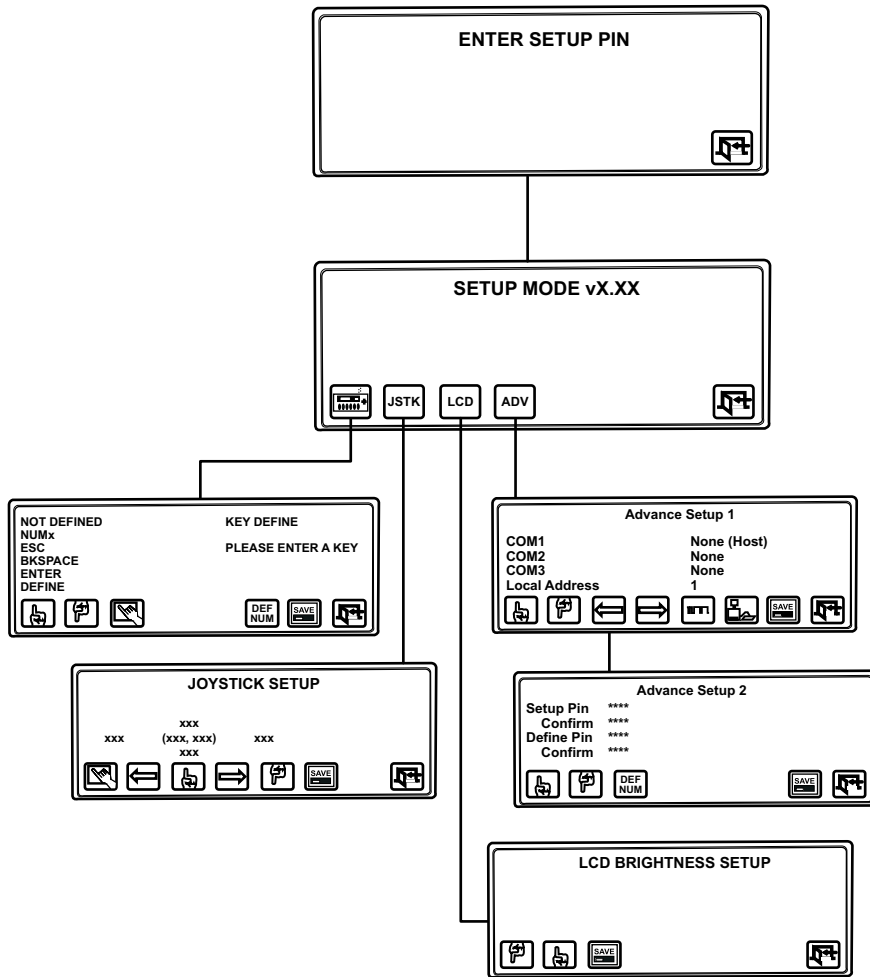
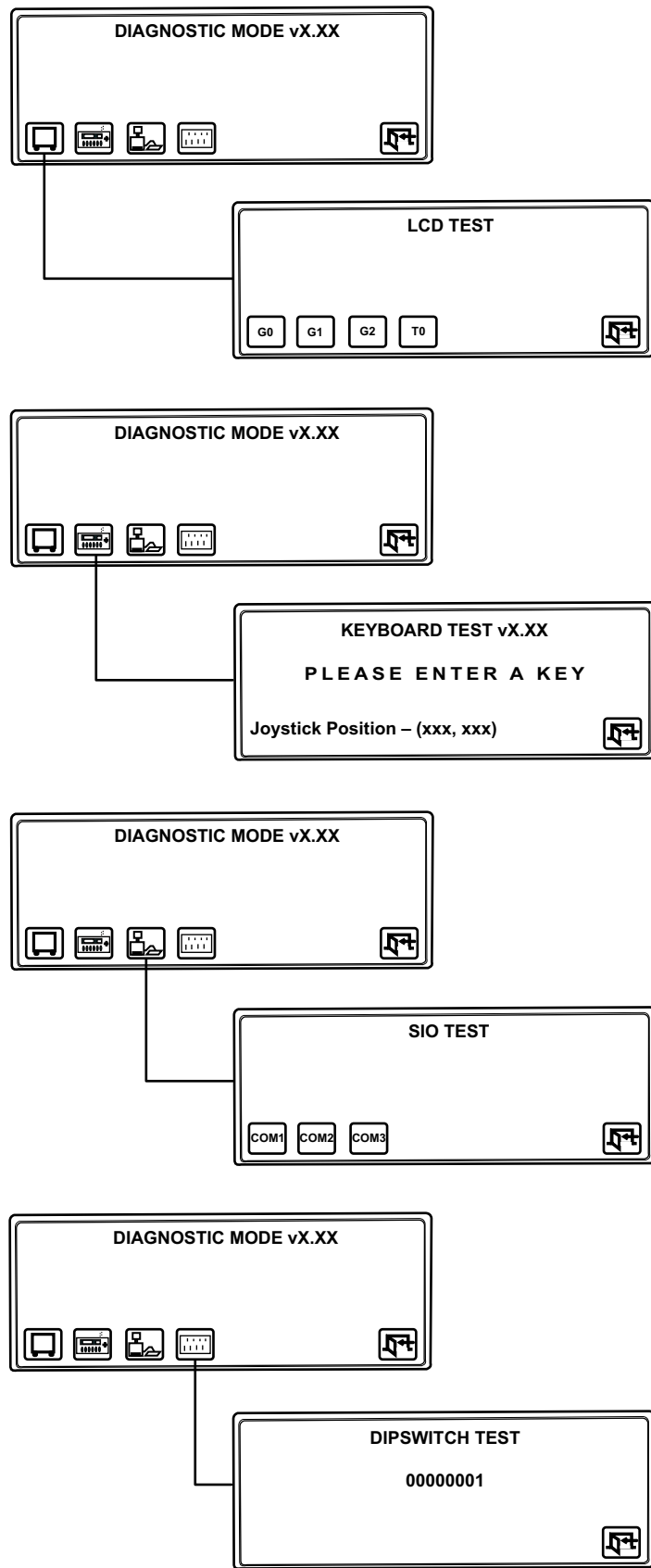

00937

Figure 46. Diagnostic Mode Menu Tree (DIP Switch 1 ON)

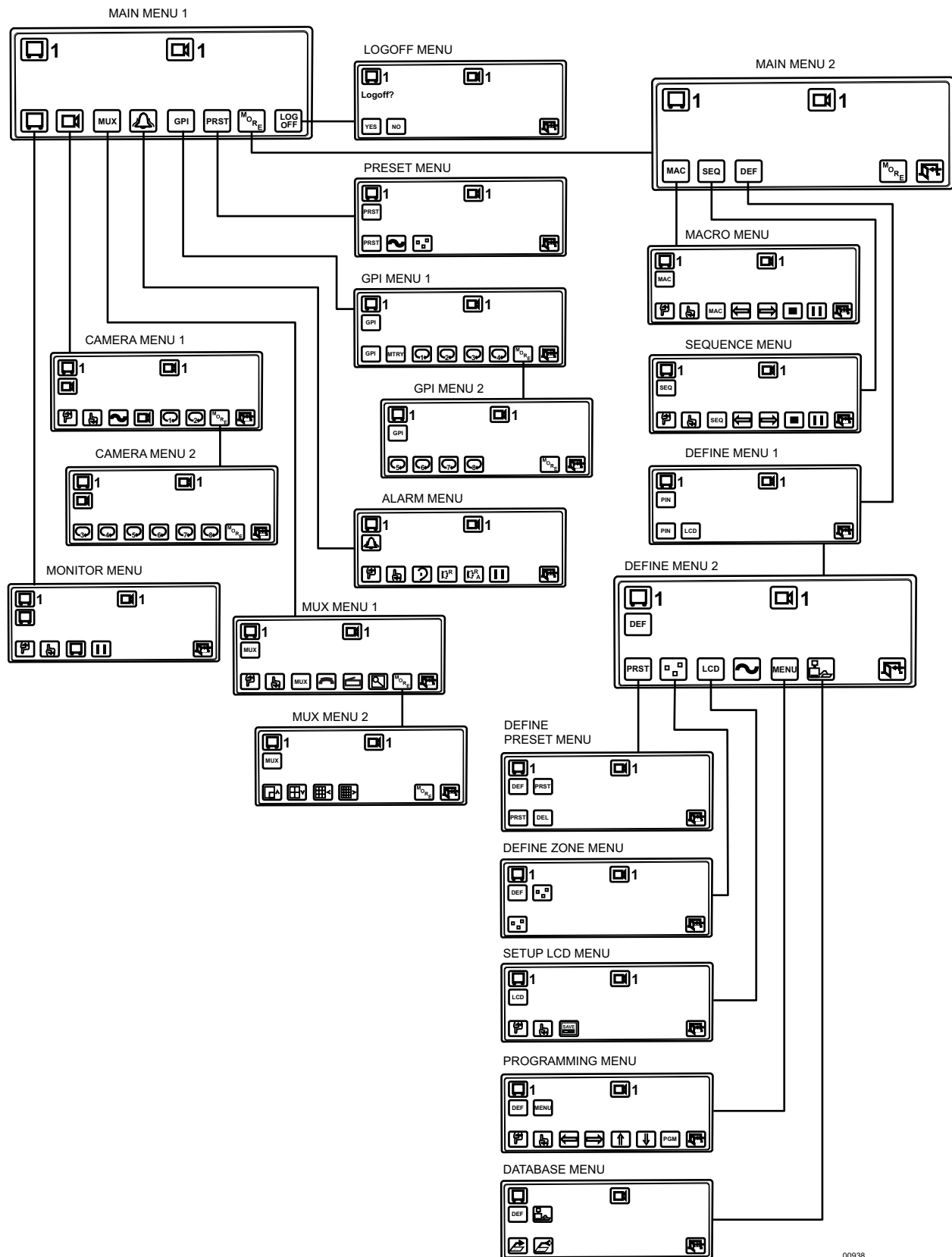

00938

Figure 47. Operation Mode Menu Tree (DIP Switch 2 OFF)

Specifications

ELECTRICAL

Input Voltage	100-240 VAC, 50/60 Hz
Power Consumption	10 watts
Communications	RS-485
Operating Distance	4,000 feet (1,219 m) on 24 AWG wire
Connectors	Two 8-pin, RJ-45 connectors (female); RS-485 serial ports One 4-pin, RJ-45 connector (female); RS-232 serial (diagnostic) port Two 6-pin RJ-45 connectors (female) not used

OPERATIONAL

Joystick	Proportional
Display	Four-line, backlit LCD for programming and control
LCD Menu Display	Eight icon keys for LCD menu selection
Numerical Input	Ten-key numeric keypad with two additional keys for camera and monitor selection
Function Keys	Twenty-four function keys
Control Keys	Six keys for control of various functions
Lens Keys	Three keys for zoom, iris, and focus control

GENERAL

Operating Temperature	32° to 120°F (0° to 49°C)
Dimensions	
KBD960	15.5 (W) x 3.3 (H) x 7.8 (D) inches (39.45 x 8.38 x 19.81 cm)
KBR960	6.96 (W) x 1.27 (H) x 19.00 (D) inches (17.68 x 3.23 x 48.26 cm)
Unit Weight	
KBD960	4.59 lb (2.08 kg)
KBR960	6.40 lb (2.90 kg)

PRODUCT WARRANTY AND RETURN INFORMATION

WARRANTY

Pelco will repair or replace, without charge, any merchandise proved defective in material or workmanship **for a period of one year** after the date of shipment.

Exceptions to this warranty are as noted below:

- Five years on FR/FT/FS Series fiber optic products and TW3000 Series unshielded twisted pair transmission products.
- Three years on Genex® Series products (multiplexers, server, and keyboard).
- Three years on Camclosure® and fixed camera models, except the CC3701H-2, CC3701H-2X, CC3751H-2, CC3651H-2X, MC3651H-2, and MC3651H-2X camera models, which have a five-year warranty.
- Three years on PMCL200/300/400 Series LCD monitors.
- Two years on standard motorized or fixed focal length lenses.
- Two years on Legacy®, CM6700/CM6800/CM9700 Series matrix, and DF5/DF8 Series fixed dome products.
- Two years on Spectra®, Esprit®, ExSite™, and PS20 scanners, including when used in continuous motion applications.
- Two years on Esprit® and WW5700 Series window wiper (excluding wiper blades).
- Two years (except lamp and color wheel) on Digital Light Processing (DLP®) displays. The lamp and color wheel will be covered for a period of 90 days. The air filter is not covered under warranty.
- Eighteen months on DX Series digital video recorders, NVR300 Series network video recorders, and Endura™ Series distributed network-based video products.
- One year (except video heads) on video cassette recorders (VCRs). Video heads will be covered for a period of six months.
- Six months on all pan and tilts, scanners or preset lenses used in continuous motion applications (that is, preset scan, tour and auto scan modes).

Pelco will warrant all replacement parts and repairs for 90 days from the date of Pelco shipment. All goods requiring warranty repair shall be sent freight prepaid to Pelco, Clovis, California. Repairs made necessary by reason of misuse, alteration, normal wear, or accident are not covered under this warranty.

Pelco assumes no risk and shall be subject to no liability for damages or loss resulting from the specific use or application made of the Products. Pelco's liability for any claim, whether based on breach of contract, negligence, infringement of any rights of any party or product liability, relating to the Products shall not exceed the price paid by the Dealer to Pelco for such Products. In no event will Pelco be liable for any special, incidental or consequential damages (including loss of use, loss of profit and claims of third parties) however caused, whether by the negligence of Pelco or otherwise.

The above warranty provides the Dealer with specific legal rights. The Dealer may also have additional rights, which are subject to variation from state to state.

If a warranty repair is required, the Dealer must contact Pelco at (800) 289-9100 or (559) 292-1981 to obtain a Repair Authorization number (RA), and provide the following information:

1. Model and serial number
2. Date of shipment, P.O. number, Sales Order number, or Pelco invoice number
3. Details of the defect or problem

If there is a dispute regarding the warranty of a product which does not fall under the warranty conditions stated above, please include a written explanation with the product when returned.

Method of return shipment shall be the same or equal to the method by which the item was received by Pelco.

RETURNS

In order to expedite parts returned to the factory for repair or credit, please call the factory at (800) 289-9100 or (559) 292-1981 to obtain an authorization number (CA number if returned for credit, and RA number if returned for repair).

All merchandise returned for credit may be subject to a 20% restocking and refurbishing charge.

Goods returned for repair or credit should be clearly identified with the assigned CA or RA number and freight should be prepaid. Ship to the appropriate address below.

If you are located within the continental U.S., Alaska, Hawaii or Puerto Rico, send goods to:

Service Department
Pelco
3500 Pelco Way
Clovis, CA 93612-5699

If you are located outside the continental U.S., Alaska, Hawaii or Puerto Rico and are instructed to return goods to the USA, you may do one of the following:

If the goods are to be sent by a COURIER SERVICE, send the goods to:

Pelco
3500 Pelco Way
Clovis, CA 93612-5699 USA

If the goods are to be sent by a FREIGHT FORWARDER, send the goods to:

Pelco c/o Expeditors
473 Eccles Avenue
South San Francisco, CA 94080 USA
Phone: 650-737-1700
Fax: 650-737-0933

 **Green** The materials used in the manufacture of this document and its components are compliant to the requirements of Directive 2002/95/EC.



This equipment contains electrical or electronic components that must be recycled properly to comply with Directive 2002/96/EC of the European Union regarding the disposal of waste electrical and electronic equipment (WEEE). Contact your local dealer for procedures for recycling this equipment.

REVISION HISTORY

Manual #	Date	Comments
C1519M	6/01	Original version.
C1519M-A	5/02	Added <i>Models</i> section. Added ferrite information to <i>Installation</i> section. Added Step 5 to <i>Configuring the COM Ports</i> . Revised default function for F9-F11 per ECO 01-7510. Revised Table M. Added <i>Deleting Presets</i> section. Revised <i>Macros</i> and <i>Sequence</i> sections. Updated <i>Regulatory Notices</i> .
C1519M-B	1/03	Revised <i>Calibrating the Joystick</i> section per ECO 02-8581 and ECO 02-8394.
C1519M-C	8/05	Revised manual per ECO 04-10657. Revised first note on page 12. Removed last note on page 12 and revised the <i>Calibrating the Joystick</i> section. Added two notes on page 27.
C1519M-D	3/06	Revised <i>Models</i> section. Revised list of supplied items. Revised input voltage and power consumption on <i>Specifications</i>
C1519M-E	6/06	Removed ferrite information from <i>Installation</i> section. Revised manual format.

Pelco, the Pelco logo, Camclosure, Esprit, Genex, Legacy, and Spectra are registered trademarks of Pelco.
Endura and ExSite are trademarks of Pelco.
DLP is a registered trademark of Texas Instruments, Inc.
Lexan is a registered trademark of General Electric Company.

©Copyright 2006, Pelco. All rights reserved.



Worldwide Headquarters
3500 Pelco Way
Clovis, California 93612 USA

USA & Canada
Tel: 800/289-9100
Fax: 800/289-9150

International
Tel: 1-559/292-1981
Fax: 1-559/348-1120

www.pelco.com

ISO9001

United States | Canada | United Kingdom | The Netherlands | Singapore | Spain | Scandinavia | France | Middle East

Free Manuals Download Website

<http://myh66.com>

<http://usermanuals.us>

<http://www.somanuals.com>

<http://www.4manuals.cc>

<http://www.manual-lib.com>

<http://www.404manual.com>

<http://www.luxmanual.com>

<http://aubethermostatmanual.com>

Golf course search by state

<http://golfingnear.com>

Email search by domain

<http://emailbydomain.com>

Auto manuals search

<http://auto.somanuals.com>

TV manuals search

<http://tv.somanuals.com>