

Micro Hi-Fi System

MC230
MC235

user manual
manuel d'utilisation
manual del usuario
benutzerhandbuch
gebruikershandleiding
manuale per l'utente

användar-handbok
brugermanual
käyttöoppaita
manual do usuário
εγχειρίδιο χρήσης



PHILIPS

Important notes for users in the U.K.

Mains plug

This apparatus is fitted with an approved 13 Amp plug. To change a fuse in this type of plug proceed as follows:

- 1 Remove fuse cover and fuse.
- 2 Fix new fuse which should be a BS1362 5 Amp, A.S.T.A. or BSI approved type.
- 3 Refit the fuse cover.

If the fitted plug is not suitable for your socket outlets, it should be cut off and an appropriate plug fitted in its place.

If the mains plug contains a fuse, this should have a value of 5 Amp. If a plug without a fuse is used, the fuse at the distribution board should not be greater than 5 Amp.

Note: The severed plug must be disposed of to avoid a possible shock hazard should it be inserted into a 13 Amp socket elsewhere.

How to connect a plug

The wires in the mains lead are coloured with the following code: blue = neutral (N), brown = live (L).

- As these colours may not correspond with the colour markings identifying the terminals in your plug, proceed as follows:
 - Connect the blue wire to the terminal marked N or coloured black.
 - Connect the brown wire to the terminal marked L or coloured red.
 - Do not connect either wire to the earth terminal in the plug, marked E (or \perp) or coloured green (or green and yellow).

Before replacing the plug cover, make certain that the cord grip is clamped over the sheath of the lead - not simply over the two wires.

Copyright in the U.K.

Recording and playback of material may require consent. See Copyright Act 1956 and The Performer's Protection Acts 1958 to 1972.

Italia

DICHIARAZIONE DI CONFORMITA'

Si dichiara che l'apparecchio MC230, MC235 Philips risponde alle prescrizioni dell'art. 2 comma 1 del D.M. 28 Agosto 1995 n. 548.

Fatto a Eindhoven

Philips Consumer Electronics
Philips, Glaslaan 2
5616 JB Eindhoven, The Netherlands

Norge

Typeskilt finnes på apparatens underside.

Observer: Nettbryteren er sekundert innkopleet. Den innebygde nettdelen er derfor ikke frakopleet nettet så lenge apparatet er tilsluttet nettkontaktene.

For å redusere faren for brann eller elektrisk støt, skal apparatet ikke utsettes for regn eller fuktighet.

CAUTION

Use of controls or adjustments or performance of procedures other than herein may result in hazardous radiation exposure or other unsafe operation.

VAROITUS

Muiden kuin tässä esitettyjen toimintojen säädön tai asetusten muutto saattaa altistaa vaaralliselle säteilylle tai muille vaarallisille toiminnoille.

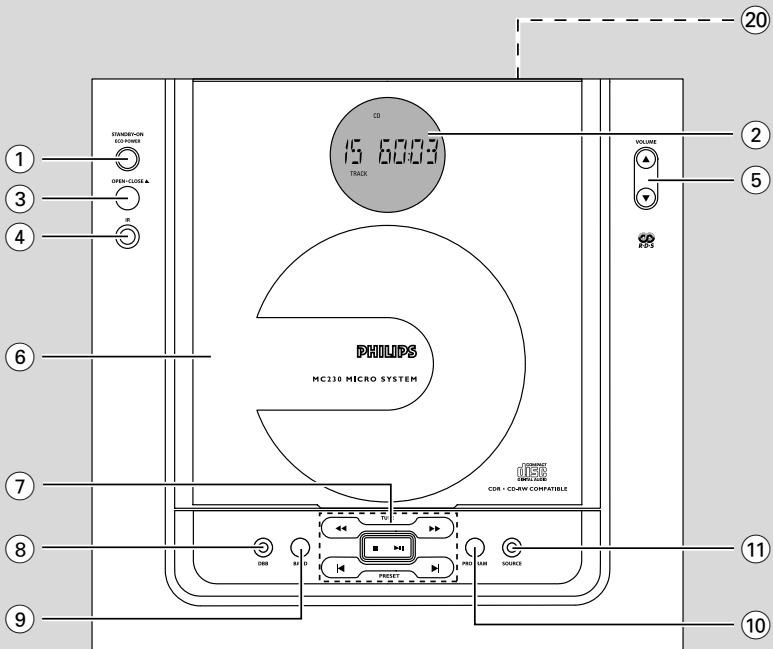
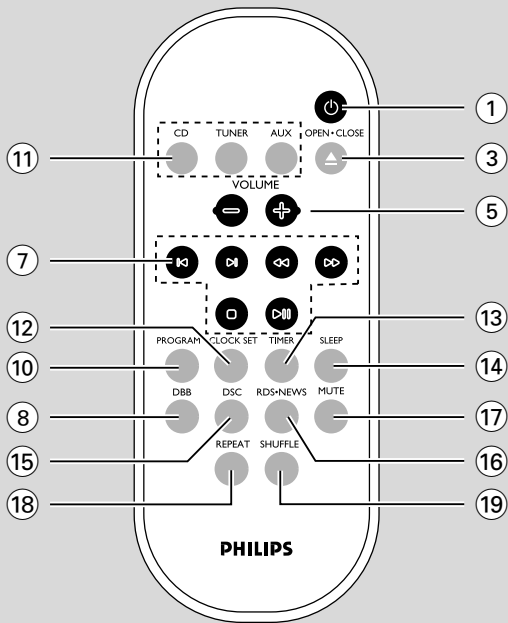

DK

Advarsel: Usynlig laserstråling ved åbning når sikkerhedsafbrydere er ude af funktion. Undgå udsættelse for stråling.

Bemærk: Netafbryderen er sekundært indkoblet og afbryder ikke strømmen fra nettet. Den indbyggede netdel er derfor tilsluttet til lysnettet så længe netstikket sidder i stikkontakten.

S

Klass 1 laseraparät

Varning! Om apparaten används på annat sätt än i denna bruksanvisning specificerats, kan användaren utsättas för osynlig laserstråling, som överskrider gränsen för laserklass 1.

Observera! Stömbrytaren är sekundärt kopplad och bryter inte strömmen från nätet. Den inbyggda nätdelen är därför ansluten till elnätet så länge stickproppen sitter i vägguttaget.

SF

Luokan 1 laserlaite

Varoitus! Laitteen käyttäminen muulla kuin tässä käyttöohjeessa mainitulla tavalla saattaa altistaa käyttäjän turvallisuusluokan 1 ylittävälle näkymättömälle lasersäteilylle.

Oikeus muutoksiin varataan. Laite ei saa olla alttiina tippu- ja roiskevedelle.

Huom. Toiminnanvalitsin on kytketty toisipuolelle, eikä se kytke laitetta irti sähköverkosta. Sisäänrakennettu verkko-osa on kytkettyä sähköverkkoon aina silloin, kun pistoke on pistorasiasassa.

English	6
Français	20
Español	35
Deutsch	49
Nederlands	64
Italiano	79
Svenska	94
Dansk	108
Suomi	123
Português	137
Ελληνικά	152

English

Français

Español

Deutsch

Nederlands

Italiano

Svenska

Dansk

Suomi

Português

Ελληνικά

Contents

General Information

Environmental information	7
Supplied accessories	7
Safety information	7

Preparations

Rear connections	8 – 9
Optional connection	9
Before using the remote control	9
Replacing battery (lithium CR2025) into the remote control	9

Controls

Controls on the system and remote control	10
---	----

Basic Functions

Switching the system on	11
Switch the system to	
Eco Power Standby mode	11
Power Saving Automatic Standby	11
Adjusting volume and sound	11

CD Operation

Playing a disc	12
Selecting a different track	12
Finding a passage within a track	12
Different play modes: Shuffle and Repeat	13
Programming track numbers	13
Reviewing the programme	13
Erasing the programme	13

Radio Reception

Tuning to radio stations	14
Programming radio stations	14
Tuning to preset radio stations	14
RDS	15
Setting the RDS clock	15
Searching programme type (PTY)	15
RDS News and Traffic Announcement (TA) .	16

Clock/Timer

Setting the clock	17
Viewing the clock	17
Setting the timer	17
Activating and deactivating TIMER	17
Activating and deactivating SLEEP	17

Specifications

18

Maintenance

18

Troubleshooting

19

This product complies with the radio interference requirements of the European Community.

Environmental Information

All unnecessary packaging has been omitted. We have tried to make the packaging easy to separate into three materials: cardboard (box), polystyrene foam (buffer) and polyethylene (bags, protective foam sheet).

Your system consists of materials which can be recycled and reused if disassembled by a specialized company. Please observe the local regulations regarding the disposal of packaging materials, exhausted batteries and old equipment.

Supplied accessories

- 2 speaker boxes
- remote control (with battery)
- AM loop antenna
- FM wire antenna
- stand
- screw and plug assembly

Safety Information

- Before operating the system, check that the operating voltage indicated on the typeplate (or the voltage indication beside the voltage selector) of your system is identical with the voltage of your local power supply. If not, please consult your dealer.
- Place the system on a flat, hard and stable surface.
- Place the system in a location with adequate ventilation to prevent internal heat build-up in your system. Allow at least 10 cm (4 inches) clearance from the rear and the top of the unit and 5 cm (2 inches) from each side.
- The ventilation should not be impeded by covering the ventilation openings with items, such as newspapers, table-cloths, curtains, etc.
- Do not expose the system, batteries or discs to excessive moisture, rain, sand or heat sources caused by heating equipment or direct sunlight.
- No naked flame sources, such as lighted candles, should be placed on the apparatus.
- No objects filled with liquids, such as vases, shall be placed on the apparatus.
- If the system is brought directly from a cold to a warm location, or is placed in a very damp room, moisture may condense on the lens of the disc unit inside the system. Should this occur, the CD player would not operate normally. Leave the power on for about one hour with no disc in the system until normal playback is possible.
- The mechanical parts of the set contain self-lubricating bearings and must not be oiled or lubricated.
- **When the system is switched to Standby mode, it is still consuming some power. To disconnect the system from the power supply completely, remove the AC power plug from the wall socket.**

Preparations

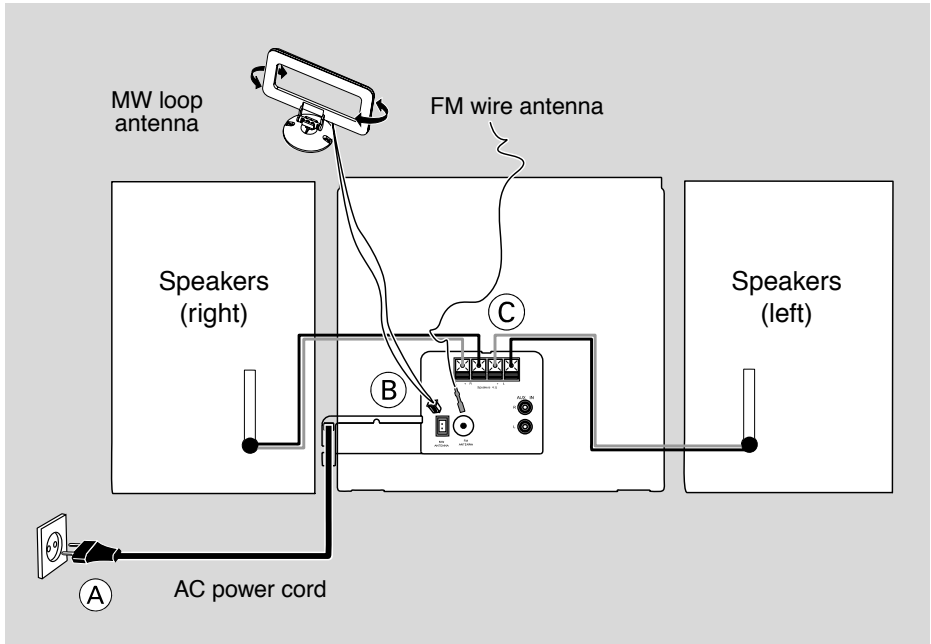

Rear connections

The type plate is located at the rear of the system.

For users in the U.K.: please follow the instructions on page 2.

A Power

Before connecting the AC power cord to the wall outlet, ensure that all other connections have been made.

WARNING!

- For optimal performance, use only the original power cable.
- Never make or change any connections with the power switched on.

To avoid overheating of the system, a safety circuit has been built in. Therefore, your system may switch to Standby mode automatically under extreme conditions. If this happens, let the system cool down before reusing it (not available for all versions).

B Antennas Connection

Connect the supplied AM loop antenna and FM antenna to the respective terminals. Adjust the position of the antenna for optimal reception.

AM Antenna

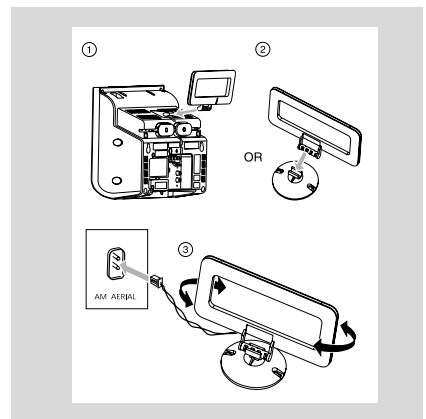

- Position the antenna as far as possible from a TV, VCR or other radiation source.

FM Antenna

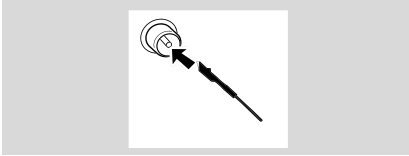

- For better FM stereo reception, connect an outdoor FM antenna to the FM AERIAL (FM ANTENNA) terminal.

C Speakers Connection

Front Speakers

Connect the speaker wires to the SPEAKERS terminals, right speaker to "RIGHT" and left speaker to "LEFT", colored (marked) wire to "+" and black (unmarked) wire to "-".

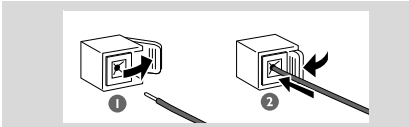

- Fully insert the stripped portion of the speaker wire into the terminal as shown.

Notes:

- For optimal sound performance, use the supplied speakers.
- Do not connect more than one speaker to any one pair of +/– speaker terminals.
- Do not connect speakers with an impedance lower than the speakers supplied. Please refer to the SPECIFICATIONS section of this manual.

Optional connection

The optional equipment and connecting cords are not supplied. Refer to the operating instructions of the connected equipment for details.

Connecting other equipment to your system

Connect the audio left and right OUT terminals of a TV, VCR, Laser Disc player, DVD player or CD Recorder to the **AUX-IN** terminals.

Note:

- If you are connecting equipment with a mono output (a single audio out terminal), connect it to the AUX left terminal. Alternatively, you can use a "single to double" cinch cable (the output sound still remain mono).

Before using the remote control

- 1 Pull out the plastic protective sheet.
- 2 Select the source you wish to control by pressing one of the source select keys on the remote control (for example CD, TUNER).
- 3 Then select the desired function (for example **▶▶**, **◀◀**, **▶▶**).

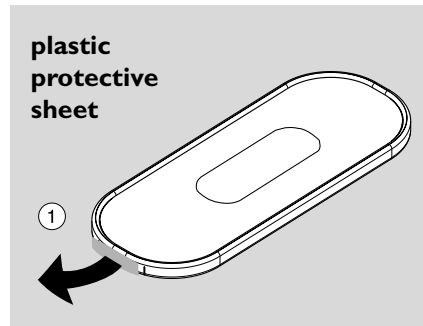

Replacing battery (lithium CR2025) into the remote control

- 1 Pull out the knob (A) slightly to the left.
- 2 Pull out the battery compartment (B).
- 3 Replace a new battery and fully insert the battery compartment back to the original position.

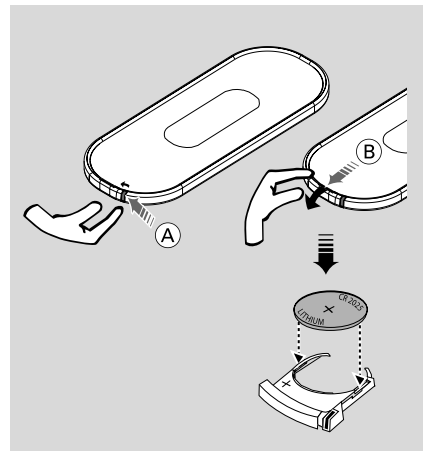

CAUTION!

Batteries contain chemical substances, so they should be disposed off properly.

Controls on the system and remote control

- ① **STANDBY-ON/ ECO POWER**
 - switches the system on or to Eco Power standby.
- ② **Display**
 - shows the status of the system.
- ③ **OPEN • CLOSE ▲**
 - opens/ closes the CD door.
- ④ **IR**
 - remote sensor
- ⑤ **VOLUME (▲ / ▼) (+ / -)**
 - adjusts the volume level.
- ⑥ **CD Door**
- ⑦ **Mode Selection**
 - SEARCH/TUNE (◀◀ / ▶▶)**
 - for TUNERtunes to a station
 - for CD fast searches back and forward within a track/ CD.
 - STOP ■** stops CD playback or erase a CD programme.
 - PLAY ▶▶** starts or interrupts playback.
 - PRESET (◀ / ▶)**
 - for TUNER selects a preset radio station.
 - for CD skips to the beginning of a current track/ previous/ subsequent track
- ⑧ **DBB (Dynamic Bass Boost)**
 - enhances the bass.
- ⑨ **BAND**
 - selects a waveband.
- ⑩ **PROGRAM**
 - for CD programmes tracks and reviews the programme.
 - for TUNER programmes tuner stations.
- ⑪ **SOURCE**
 - selects the respective sound source for CD/ TUNER/ AUX.
- ⑫ **CLOCK SET**
 - sets the clock function.
 - views the clock.
- ⑬ **TIMER**
 - activates/ deactivates or sets the timer function
- ⑭ **SLEEP**
 - activates/deactivates or selects the sleeper time.
- ⑮ **DSC (Digital Sound Control)**
 - selects sound characteristics: ROCK/ JAZZ/ POP/ CLASSIC.

- ⑯ **RDS.NEWS**
 - activates RDS news and Traffic Announcement.
 - for tuner; displays RDS information.
- ⑰ **MUTE**
 - interrupts and resumes sound reproduction.
- ⑱ **REPEAT**
 - repeats a track/ CD programme/ entire CD.
- ⑲ **SHUFFLE**
 - plays CD tracks in random order.
- ⑳ **🎧**
 - connects headphones

Notes for remote control:

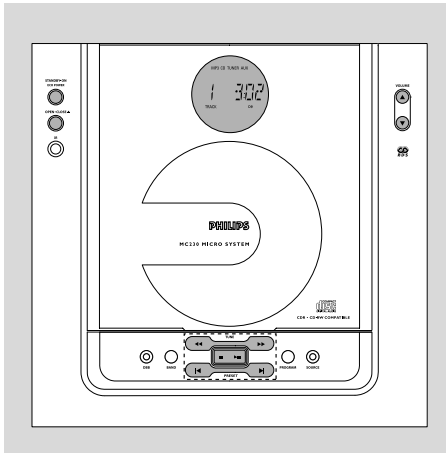

- **First select the source you wish to control by pressing one of the source select keys on the remote control (for example CD, TUNER).**
- **Then select the desired function (for example ▶▶, ◀◀, ▶).**



IMPORTANT!

Before you operate the system, complete the preparation procedures.

Switching the system on

- Press **STANDBY-ON** / .
 - The system will switch to the last selected source.
- Press **SOURCE** (or **CD**, **TUNER** or **AUX** on the remote control).
 - The system will switch to the selected source.
- Press **OPEN • CLOSE** .

Switch the system to ECO Power Standby mode

- Press **STANDBY-ON** / .
 - "ECO PWR" will be displayed, then the display screen will go blank.
 - The ECO POWER LED will be lighted.

Note:



- To view clock time in standby mode. Press and hold **STANDBY-ON** for more than 3 seconds, the clock time is displayed dimly.
- The Eco Power indicator goes off.

- The volume level (up to a maximum volume level of 20), interactive sound settings, last selected mode, source and tuner presets will be retained in the player's memory.

Power Saving Automatic Standby

As a power-saving feature, the system automatically switches to Eco Power/ Standby 15 minutes after a CD has reached the end and no control is operated.

Adjusting volume and sound

- 1 Press the **VOLUME**  /  (+ / -) control to decrease or increase the volume.
 - Display shows the volume level  and a number from MIN1, 2, ...30, 31 MAX.
 - 2 Press **DSC** repeatedly to select the desired sound effect: **ROCK** / **JAZZ** / **POP** / **CLASSIC**.
 - 3 Press **DBB** to switch bass enhancement on or off.
 - Display shows: DBB.
 - 4 Press **MUTE** on the remote control to interrupt sound reproduction instantly.
 - Playback will continue without sound and the display shows **MUTE**.
- To activate sound reproduction you can:
 - press **MUTE** again;
 - adjust the volume controls;
 - change source.

CD Operation

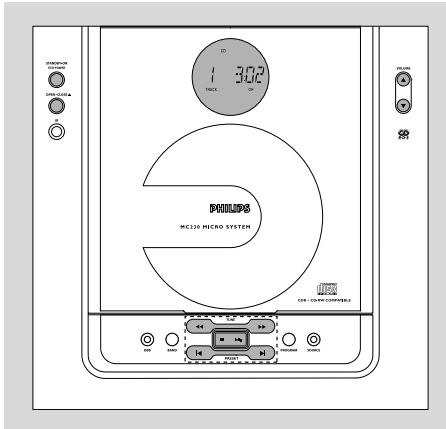

IMPORTANT!

The lens of the CD player should never be touched.

Playing a disc

- CD-ROM, CD-I, CDV, VCD, MP3, DVD or computer CDs, however, are not possible.

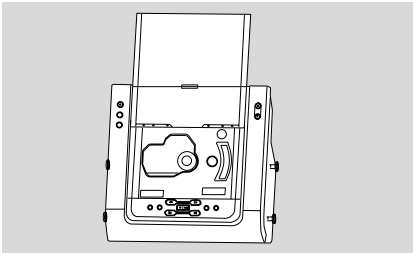

- 1 Press **SOURCE** to select CD.
- 2 Press **OPEN • CLOSE ▲** on the front panel of the system to open the CD compartment.
→ **OPEN** is displayed when the compartment cover slides up.
- 3 Insert a disc with the printed side facing up.
Press **OPEN • CLOSE ▲** again to close the compartment.
→ **READING** is displayed as the CD player scans the contents of the disc.
→ The total playing time and the total number of tracks are displayed.

- 4 Press **▶||** to start playback.
→ Current track number and elapsed playing time of the track are displayed during disc playback.
- 5 To interrupt playback press **▶||**. Press **▶||** again to resume play.
- 6 To stop disc playback, press **STOP ■**.
Note: CD play will also stop when;
 - the CD door is opened.
 - the disc has reached the end.
 - you select another source: **TUNER** or **AUX**.

Selecting a different track

- Press **◀** or **▶** once or repeatedly until the desired track number appears in the display.
- If you have selected a track number shortly after loading a disc or in the PAUSE position, you will need to press **▶||** to start playback.

Finding a passage within a track

- 1 Press and hold down on **◀◀** or **▶▶**.
→ The disc is played at high speed and low volume.
- 2 When you recognise the passage you want, release **◀◀** or **▶▶**.
→ Normal playback continues.

Different play modes: SHUFFLE and REPEAT

You can select and change the various play modes before or during playback. The REPEAT modes can also be combined with PROGRAM.

SHUFFLEtracks of the entire disc are played in random order

SHUFFLE and **REPEAT ALL**...to repeat the entire disc continuously in random order

REPEAT ALL ... repeats the entire disc/ program

REPEATplays the current track continuously

- 1 To select your play mode, press the **SHUFFLE** or **REPEAT** on the remote control before or during playback until the display shows the desired function. (SHUFFLE, REPEAT, REPEAT ALL)
- 2 Press **▶||** to start playback if in the STOP position.
→ If you have selected SHUFFLE, playback starts automatically.
- 3 To return to normal playback, press the respective **SHUFFLE** or **REPEAT** button until the various SHUFFLE / REPEAT modes are no longer displayed.
- You can also press **STOP ■** to cancel your play mode.

Programming track numbers

Program in the STOP position to select and store your disc tracks in the desired sequence. If you like, store any track more than once. Up to 40 tracks can be stored in the memory.

- 1 Press **PROGRAM** to enter the programming mode.
→ A track number is shown and **PROGRAM** flashes.
- 2 Use the **◀** or **▶** to select your desired track number.
- 3 Press **PROGRAM** to confirm the track number to be stored.
→ The number of tracks programmed and the total playing time of the programme are show briefly, then the selected track and *PRGG.*

- 4 Repeat steps 2-3 to select and store all desired tracks.
→ *FULL* is displayed if you attempt to program more than 40 tracks.

- 5 To start playback of your disc program, press **STOP ■** followed by **▶||** or press **▶||** directly.

Reviewing the program

In **STOP** mode, press and hold **PROGRAM**.

Until the display shows all your stored track number in sequence.

Erasing the program

You can erase the program by:

- pressing **STOP ■** once in the STOP mode;
- pressing **STOP ■** twice during playback;
- opening the CD compartment;
→ **PROGRAM** disappears.
→ *CLERR* is displayed briefly.

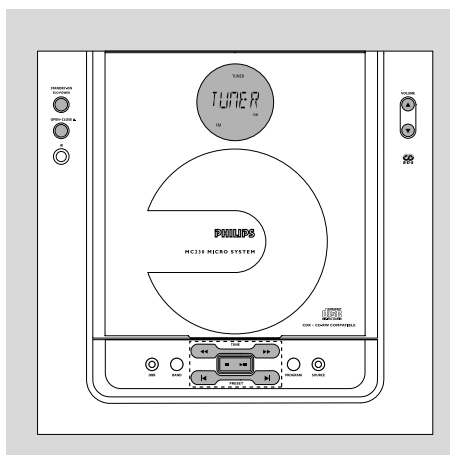

Tuning to radio stations

- 1 Press **SOURCE** to select **TUNER**.
→ **TUNER** is displayed briefly.
 - 2 Press **BAND** (or **TUNER** on the remote control) once or more to select your waveband (FM/ MW).
 - 3 Press and hold **TUNE** ◀◀ or ▶▶.
→ The radio automatically tunes to a station with sufficient reception. Display indication during automatic tuning: **SEARCH**.
 - 4 Repeat step 3 if necessary until you find the desired station.
- To tune to a weak station, press **TUNE** ◀◀ or ▶▶ briefly and repeatedly until you have found optimal reception.

Programming radio stations

You can store up to a total of 40 radio stations in the memory.

Automatic programming

Automatic programming will start with a chosen preset number. From this preset number upwards, former programmed radio stations will be overridden. The system will only program stations which are not in the memory already.

- 1 Press **PRESET** ◀ or ▶ to select the preset number where programming should start.

Note:

- If no preset number is selected, default is preset (1) and all your presets will be overridden.

- 2 Press **PROGRAM** for more than 2 seconds to activate programming.

→ **AUTO** is displayed and available stations are programmed in order of waveband reception strength: RDS, FM followed by MW. The last preset automatically stored will then be played.

Manual programming

- 1 Tune to your desired station (see "Tuning to radio stations").
 - 2 Press **PROGRAM** to activate programming.
 - 3 Press **PRESET** ◀ or ▶ to allocate a number from 1 to 40 to this station.
 - 4 Press **PROGRAM** again to confirm the setting.
→ The preset number and the frequency of the preset station are shown.
 - 5 Repeat the above four steps to store other stations.
- You can override a preset station by storing another frequency in its place.

Tuning to preset radio stations

- Press **PRESET** ◀ or ▶ until the desired preset station is displayed.

RDS

Radio Data System is a service that allows FM stations to show additional information. If you are receiving a RDS station, **RDS** and the station name are displayed.

When automatic programming is used, RDS stations will be programmed first.

Scrolling through different RDS information

- Press **RDS • NEWS** briefly and repeatedly to scroll through the following information (if available):
 - Station name
 - Programme type such as *NEWS, SPORT, POP M ...*
 - Radio text messages
 - Frequency

Note:

- If you press **RDS** and the RDS signal is not available **NO RDS** is displayed.

Setting the RDS clock

Some RDS radio station may be transmitting a real clock time at an interval of every minute. It is possible to set the clock by using a time signal which is broadcast together with the RDS signal.

- 1 Tuned to a RDS station from FM band (refer to "Tuning to radio stations").
- 2 Press and hold **CLOCK SET** until "SET CLOCK" is displayed.
- 3 Press **RDS • NEWS**.
 - "SEARCH RDS TIME" appears.
 - When RDS time is read, the current time will be stored.
 - If the RDS station does not transmit RDS time within 90 seconds, "NO RDS TIME" appears.

Note:

- Some RDS radio station may be transmitting a real time clock at a minute interval. The accuracy of the transmitted time depends on the transmitting RDS radio station.

Searching programme type (PTY)

PTY helps you find a desired programme type. To enable PTY, first programme RDS stations into the tuner memory (see Programming radio stations)

- 1 While receiving an RDS station, press **RDS • NEWS** briefly until the programme type is displayed.
- 2 Press **PRESET** ◀ or ▶ until the desired programme type is displayed.
- 3 Press and hold down on **TUNE** ◀◀ or ▶▶ to start searching.
 - The radio tunes to a RDS station broadcasting this programme type. If the programme type is not available **TYPE NOT FOUND** is displayed.

RDS Programme types

NO TYPE	No RDS programme type
NEWS	News services
AFFAIRS	Politics and current affairs
INFO	Special information programmes
SPORT	Sports
EDUCATE	Education and advanced training
DRAMA	Radio plays and literature
CULTURE	Culture, religion and society
SCIENCE	Science
VARIED	Entertainment programmes
POP M	Pop music
ROCK M	Rock music
MOR M	Light music
LIGHT M	Light classical music
CLASSICS	Classical music
OTHER M	Special music programmes
WEATHER	Weather
FINANCE	Finance
CHILDREN	Children's programmes
SOCIAL	Social Affairs
RELIGION	Religion
PHONE IN	Phone In
TRAVEL	Travel
LEISURE	Leisure
JAZZ	Jazz Music
COUNTRY	Country Music
NATION M	National Music
OLDIES	Oldies Music
FOLK M	Folk Music
DOCUMENT	Documentary
TEST	Alarm Test
ALARM	Alarm

Radio Reception

RDS News and Traffic Announcement (TA)

You may set up the tuner in such a way that listening to CD/AUX is interrupted by the NEWS on traffic announcement of a RDS station. This only works if the RDS station broadcasts a NEWS signal while sending the news.

- 1 Tune to the desired RDS station.
- 2 In **CD**, **AUX** or Standby mode, press **RDS • NEWS** once or more on the remote control to select the NEWS option.
 - **NEWS ON, TA ON** or **OFF** is displayed briefly.
 - **NEWS** is displayed if you have activated the NEWS or TA option. Changing listening source will not disarm the function.

Notes:

- *When you receive RDS news or traffic announcements during CD playback, playback will pause and you will be able to hear the news/TA. Playback resumes after the broadcast has finished.*
- *If you are using the RDS NEWS announcement, the whole network is searched for the respective news.*

Disarming RDS News and Traffic Announcement

There are a number of ways to disarm the news feature:

- Press **RDS • NEWS** on the remote control during reception of the news option.

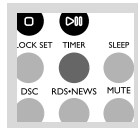

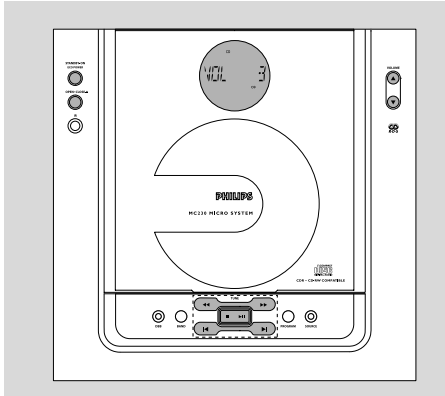

Setting the clock

- 1 In standby mode or system on, press and hold **CLOCK SET** on the remote control for more than 3 seconds.
→ **SET CLOCK** scrolls on the display.
→ The clock digits for the hours flash.
- 2 Press **VOLUME +/-** to set the hours.
- 3 Press **CLOCK SET** again.
→ The clock digits for the minutes flash.
- 4 Press **VOLUME +/-** to set the minutes.
- 5 Press **CLOCK SET** to confirm the time.

Note:

- The backlight for clock display is dim in standby.

Viewing the clock

Press **CLOCK SET**

- The clock time is displayed.

Setting the timer

- The system can be used as an alarm clock, whereby the CD, TUNER is switched on at a set time. The clock time needs to be set first before the timer can be used.
 - During setting, if no button is pressed within 90 seconds, the system will exit timer setting mode automatically.
- 1 In standby mode or system on, press and hold **TIMER** on the remote control for more than 3 seconds.
→ **SET TIMER** and **SELECT SOURCE** scrolls on the display.

- 2 Press **SOURCE** or **VOLUME +/-** to select sound source.
→ Display sequence shows **CD**, **TUNER**.
→  flashes.
- 3 Press **TIMER** to confirm your desired mode.
- 4 Press **VOLUME +/-** to set the hours.
- 5 Press **TIMER** again.
→ The clock digits for the minutes flash.
- 6 Press **VOLUME +/-** to set the minutes.
- 7 Press **TIMER** to confirm the time.
→ The timer is now set and activated.

Activating and deactivating TIMER

- Press **TIMER** on the remote to turn off the timer or turn on to the last setting again.
→ If activated, the timer information will display for a few seconds, then the system resumes to the last active source or stays in standby mode.
→ If deactivated, "OFF" appears.

Note:

- The system will exit timer setting mode if no button is pressed within 90 seconds.

Activating and deactivating SLEEP

The sleep timer enables the system to switch off by itself after a set period of time.

- Press **SLEEP** on the remote control once or more.
→ Display shows **SLEEP** and one of the sleep time options in sequence: **90, 75, 60, ..., 45, 30, 15, OFF, 90**. If you have selected a time. Once **SLEEP** is activated, **SLEEP** is displayed.
- To deactivate, press **SLEEP** on the remote control once or more until **OFF** is shown, or press **STANDBY-ON** on the system or remote control.
→ **OFF** is displayed.

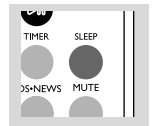

Specifications

AMPLIFIER

Output power 2 x 5 W RMS
..... 10 W + 10 W MPO
Signal-to-noise ratio ≥ 62 dBA
Frequency response 63 – 16000 Hz, ± 3 dB
Input sensitivity AUX 0.5 V (max. 2 V)
Impedance loudspeakers 4 Ω
Impedance headphones 32 Ω -1000 Ω
..... <0.5 W

CD PLAYER

Frequency range 30 – 16000 Hz
Signal-to-noise ratio 75 dBA

TUNER

FM wave range 87.5 – 108 MHz
MW wave range 531 – 1602 kHz
Sensitivity at 75 Ω
– mono, 26 dB signal-to-noise ratio 2.8 μ V
– stereo, 46 dB signal-to-noise ratio 61.4 μ V
Selectivity ≥ 28 dB
Total harmonic distortion $\leq 5\%$
Frequency response 63 – 12500 Hz (± 3 dB)
Signal-to-noise-ratio ≥ 50 dBA

SPEAKERS

Bass reflex system
Dimensions (w x h x d) 166 x 245 x 90 (mm)

GENERAL INFORMATION

AC Power 220 – 240 V / 50 Hz
Dimensions (w x h x d) 250 x 245 x 96 (mm)
Weight (with/without speakers) 9.4 / 4.8 kg
Standby power consumption <7 W
Eco power standby <1 W

Specifications and external appearance are subject to change without notice.

Maintenance

Cleaning the Cabinet

- Use a soft cloth slightly moistened with a mild detergent solution. Do not use a solution containing alcohol, spirits, ammonia or abrasives.

Cleaning Discs

- When a disc becomes dirty, clean it with a cleaning cloth. Wipe the disc from the centre out.
- Do not use solvents such as benzene, thinner, commercially available cleaners, or antistatic spray intended for analogue records.



Cleaning the disc lens

- After prolonged use, dirt or dust may accumulate at the disc lens. To ensure good playback quality, clean the disc lens with Philips CD Lens Cleaner or any commercially available cleaner. Follow the instructions supplied with cleaner.

WARNING

Under no circumstances should you try to repair the system yourself, as this will invalidate the warranty. Do not open the system as there is a risk of electric shock.

If a fault occurs, first check the points listed below before taking the system for repair. If you are unable to remedy a problem by following these hints, consult your dealer or Philips for help.

Problem	Solution
CD OPERATION	
"NO DISC" is displayed.	<ul style="list-style-type: none"> - Insert a disc. - Check if the disc is inserted upside down. - Wait until the moisture condensation at the lens has cleared. - Replace or clean the disc, see "Maintenance". - Use a finalised CD-RW or CD-R.
RADIO RECEPTION	
Radio reception is poor.	<ul style="list-style-type: none"> - If the signal is too weak, adjust the antenna or connect an external antenna for better reception. - Increase the distance between the Micro HiFi System and your TV or VCR.
GENERAL	
The system does not react when buttons are pressed.	<ul style="list-style-type: none"> - Remove and reconnect the AC power plug and switch on the system again.
Sound cannot be heard or is of poor quality.	<ul style="list-style-type: none"> - Adjust the volume. - Disconnect the headphones. - Check that the speakers are connected correctly. - Check if the stripped speaker wire is clamped.
The left and right sound outputs are reversed.	<ul style="list-style-type: none"> - Check the speaker connections and location.
The remote control does not function properly.	<ul style="list-style-type: none"> - Select the source (CD or TUNER, for example) before pressing the function button (▶ , ◀, ▶). - Reduce the distance between the remote control and the system. - Insert the battery with its polarities (+/- signs) aligned as indicated. - Replace the battery. - Point the remote control directly toward IR sensor on the front of the system.
The timer is not working.	<ul style="list-style-type: none"> - Set the clock correctly. - Press TIMER to switch on the timer.
The Clock/Timer setting is erased.	<ul style="list-style-type: none"> - Power has been interrupted or the power cord has been disconnected. Reset the clock/timer.

Free Manuals Download Website

<http://myh66.com>

<http://usermanuals.us>

<http://www.somanuals.com>

<http://www.4manuals.cc>

<http://www.manual-lib.com>

<http://www.404manual.com>

<http://www.luxmanual.com>

<http://aubethermostatmanual.com>

Golf course search by state

<http://golfingnear.com>

Email search by domain

<http://emailbydomain.com>

Auto manuals search

<http://auto.somanuals.com>

TV manuals search

<http://tv.somanuals.com>