

# DIGITAL SOLUTION

**HOME THEATER SYSTEM**

**INSTRUCTION  
MANUAL**

**polkaudio**  
the speaker specialists®

## Table of Contents

Safety Warnings .....	4
Digital Solution Features .....	5
Carton Contents .....	6
Quick Start Guide .....	6
Rear Panel Guide .....	7
System Hookup Overview Illustrations .....	8, 9
Hooking Up the System .....	10-13
Radio Antennas .....	10
DVD Player .....	10
DSS Receivers .....	11
VCR .....	11
CD Player .....	11
Audio Tape Deck .....	11
DVD-Audio/SACD Player .....	12
Television/Monitor .....	12
Subwoofer .....	12
Speakers .....	13
AC Power .....	13
Speaker Placement.....	14
Accessories .....	15
Preamp/Processor Front Panel Guide .....	16-17
Remote Control Guide .....	18-19
Calibration (optional) .....	20-21
How to Use the System .....	22-23
About Surround Sound, DVD-Audio and Super Audio CD .....	24
Multi-Room Hook Up and Use .....	25
Troubleshooting.....	26-27
Maintenance, Service and Warranty .....	28
Specifications .....	29
Overall System Hookup .....	30-31

## A Word from Matthew Polk

Dear Home Theater Buff,

Thank you for purchasing the Polk Audio Digital Solution System. Your new Digital Solution home theater system includes the very latest technologies—like DTS processing and DVD-Audio inputs—to assure outstanding performance and compatibility now, and into the future.

While we designed the Digital Solution to be very easy to set up and use, please read this manual thoroughly for detailed information on getting the greatest enjoyment from your new home theater system. Then, invite your friends over for a movie and gloat!

For the people at Polk Audio, myself included, designing high quality audio products is more than just a job—it's our passion. We are dedicated to your complete satisfaction and delight. Should you encounter any problem or question regarding this or any other Polk Audio product, consult your Polk Audio dealer or call our Customer Service Department at 800-377-7655 (US & Can only, 9am-6pm, M-F EST).

Happy Listening!

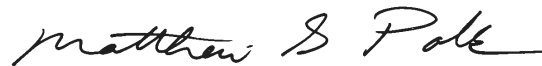

Matthew S. Polk

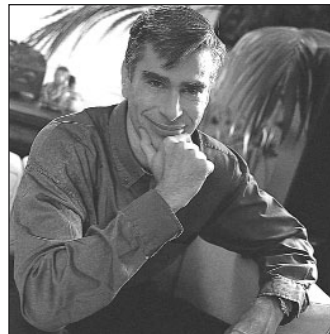

### About Polk Audio—A History of Excellence

Polk Audio was founded in 1972 by Matthew Polk and George Klopfer. Their dream was to make reasonably priced speakers that boasted the performance of the world's best speakers. Polk speakers have since earned the praise of audio experts the world over, as well as dozens of awards for innovative, high-quality design. Today, Polk Audio is still headquartered in Baltimore, Maryland, and is one of the world's largest manufacturers of loudspeakers for home, office and car. Polk's research has yielded over 20 patents for advances in loudspeaker performance and value. Polk Audio speakers are sold in audio/video specialist retailers throughout the US, Canada and over 50 other countries.

# ABOUT THE DIGITAL SOLUTION SYSTEM

## The Polk Performance Advantage

The Digital Solution is the ultimate integrated home theater system. It compromises nothing in the pursuit of performance and ease-of-use. And because it features Polk Audio loudspeakers, it boasts The Polk Performance Advantage over other “all-in-one” systems.

To make the Digital Solution system a reality, we knew that we had to design not only the speaker system but also the preamp, surround processor and amplifiers as well. By optimizing the

PERFORMANCE  
CONVENIENCE  
SIMPLICITY

speakers and electronics for each other—building them specifically to work together—we achieved “The Advantage”: a much higher level of performance than any previous “all-in-one” home theater sound system.

Now, we offer you the second generation Digital Solution. This system matches beautifully sculpted high performance Polk Audio loudspeakers with a high-

performance, multi-function, but simple to use Dolby Digital & DTS digital processor. The Digital Solution system is everything you need for absolutely thrilling high performance home theater. There’s no need to choose a receiver or separate surround processor or multi-channel power amplifier. With the Digital Solution, you already have them. They’re built-in. And, most importantly, they were designed specifically to work with each other, and with Polk Audio speakers, to deliver astounding home theater sound.

And you don’t need an advanced degree in digital electronics to get the most out of this system, either. We’ve done the work for you. Because the Digital Solution is a complete system, every possible internal setting is pre-set to achieve the best possible performance. No complicated setup procedures are required. You won’t need to navigate confusing menu screens with mysterious choices.

Simply plug everything into the Digital Solution, and sit back to enjoy The Polk Performance Advantage: a breathtaking high performance home theater system with Polk Audio speakers.



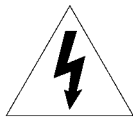

**RISK OF ELECTRIC SHOCK  
DO NOT OPEN**



**CAUTION: TO REDUCE THE RISK OF ELECTRIC SHOCK,  
DO NOT REMOVE COVER (OR BACK)  
NO USER-SERVICEABLE PARTS INSIDE  
REFER SERVICING TO QUALIFIED SERVICE PERSONNEL**



The lightning flash with arrowhead symbol, within an equilateral triangle, is intended to alert the user to the presence of uninsulated "dangerous voltage" within the product's enclosure that may be of sufficient magnitude to constitute a risk of electric shock to persons.



The exclamation point within an equilateral triangle is intended to alert the user to the presence of important operating and maintenance (servicing) instructions in the literature accompanying the appliance.

## WARNING

**TO REDUCE THE RISK OF FIRE OR ELECTRIC SHOCK,  
DO NOT EXPOSE THIS APPLIANCE TO RAIN OR MOISTURE.**

**CAUTION: TO PREVENT ELECTRIC SHOCK, MATCH WIDE  
BLADE OF PLUG TO WIDE SLOT, FULLY INSERT.**

**ATTENTION: POUR ÉVITER LES CHOCs ÉLECTRIQUES,  
INTRODUIRE LA LAME LA PLUS LARGE DE LA  
FICHE DANS LA BORNE CORRESPONDANTE DE LA  
PRISE ET POUSSER JUSQU'AU FOND.**

### NOTE TO CATV SYSTEM INSTALLER:

This reminder is provided to call the CATV (Cable-TV) system installer's attention to Article 820-40 of the NEC, that provides guidelines for proper grounding and, in particular, specified that the cable ground shall be connected to the grounding system of the building, as close to the point of cable entry as practical.

### NOTE:

This equipment has been tested and found to comply with the limits for a Class B digital device, pursuant to Part 15 of the FCC Rules. These limits are designed to provide reasonable protection against harmful interference in a residential installation. This equipment generates, uses and can radiate radio frequency energy and, if not installed and used in accordance with the instructions, may cause harmful interference to radio communications. However, there is no guarantee that interference will not occur in a particular installation.

If this equipment does cause harmful interference to radio or television reception, which can be determined by tuning the equipment off and on, the user is encouraged to try to correct the interference by one or more of the following measures:

- Reorient or relocate the receiving antenna.
- Increase the separation between the equipment and receiver.
- Connect the equipment into an outlet on a circuit different from that to which the receiver is connected.
- Consult the dealer or an experienced radio/TV technician for help.

### NOTE:

Changes or modifications may cause this unit to fail to comply with Part 15 of the FCC Rules and may void the user's authority to operate the equipment.

### IMPORTANT SAFETY INSTRUCTIONS READ BEFORE OPERATING EQUIPMENT

These products were designed and manufactured to meet strict quality and safety standards. There are, however, some installation and operation precautions which you should be particularly aware of.

1. Read Instructions—All the safety and operating instructions should be read before the system is operated.
2. Retain Instructions—The safety and operating instructions should be retained for future reference.
3. Heed Warnings—All warnings on the appliances and in the operating instructions should be adhered to.
4. Follow Instructions—All operating and use instructions should be followed.
5. Cleaning—Unplug the appliances from wall outlets before cleaning. Do not use liquid cleaners or aerosol cleaners. Use a damp cloth for cleaning.
6. Attachments—Do not use attachments not recommended by the product manufacturer as they may cause hazards.
7. Water and Moisture—Do not use these appliances near water—for example, near a bath tub, wash bowl, kitchen sink, or laundry tub, in a wet basement, or near a swimming pool, and the like.

8. Accessories—Do not place these appliances on an unstable cart, stand, tripod, bracket, or table. The audio/video products may fall, causing serious injury to a child or adult, and serious damage to the products. Use only with a cart, stand, tripod, bracket, or table recommended by the manufacturer, or sold with the appliances. Any mounting of the appliances should follow the manufacturer's instructions, and should use mounting accessories recommended by the manufacturer.

9. Ventilation—Slots and openings in the cabinet are provided for ventilation and to ensure reliable operation of the appliances and to protect them from overheating, and these openings must not be blocked or covered. The openings should never be blocked by placing the products on a bed, sofa, rug, or other similar surface. These products should never be placed near or over a radiator or heat register. These products should not be placed in a built-in installation such as a bookcase or rack unless proper ventilation is provided or the manufacturer's instructions have been adhered to.

10. Power Sources—These products should be operated only from the type of power source indicated on the marking labels. If you are not sure of the type of power supply to your home, consult your appliance dealer or local power company. For video products intended to operate from battery power, or other sources, refer to the operating instructions.

11. Grounding or Polarization—These products are equipped with polarized alternating-current line plugs (plugs having one blade wider than the other). This plug will fit into the power outlet only one way. This is a safety feature. If you are unable to insert the plug fully into the outlet, try reversing the plug. If the plug should still fail to fit, contact your electrician to replace your obsolete outlet. Do not defeat the safety purpose of the polarized plug.

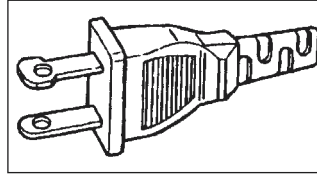

12. Power-Cord Protection—Power-supply cords should be routed so that they are not likely to be walked on or pinched by items placed upon or against them, paying particular attention to cords at plugs, convenience receptacles, and the point where they exit from the appliances.

13. Outdoor Antenna Grounding—If an outside antenna or cable system is connected to the product, be sure the antenna or cable system is grounded so as to provide some protection against voltage surges and built up static charges. Section 810 of the National Electrical Code, ANSI/NFPA No. 70-1984, provides information with respect to proper grounding of the mast and supporting structure, grounding of the lead-in wire to an antenna discharge unit, size of grounding conductors, location of antenna-discharge unit, connection to grounding electrodes, and requirements for the grounding electrode. [\[See Figure 1.\]](#)

14. Lightning—For added protection for these audio/video products during a lightning storm, or when they are left unattended and unused for long periods of time, unplug them from the wall outlet and disconnect the antenna or cable system. This will prevent damage to the products due to lightning and power-line surges.

15. Power Lines—An outside antenna system should not be located in the vicinity of overhead power lines or other electric light or power circuits, or where it can fall into such power lines or circuits. When installing an outside antenna system, extreme care should be taken to keep from touching such power lines or circuits as contact with them might be fatal.

16. Overloading—Do not overload wall outlets and extension cords as this can result in a risk of fire or electric shock.

17. Object and Liquid Entry—Never push objects of any kind into these products through openings as they may touch dangerous voltage points or short-out parts that could result in a fire or electric shock. Never spill liquid of any kind on these audio/video products.

18. Servicing—Do not attempt to service these products yourself as opening or removing covers may expose you to dangerous voltage or other hazards. Refer all servicing to qualified service personnel.

19. Damage Requiring Service—Unplug these products from wall outlets and refer servicing to qualified service personnel under the following conditions:

- a. When the power-supply cord or plug is damaged.
- b. If liquid has been spilled, or objects have fallen into the products
- c. If the products have been exposed to rain or water.
- d. If the products do not operate normally by following the operating instructions. Adjust only those controls that are covered by the operating instructions as an improper adjustment of other controls may result in damage and will often require extensive work by a qualified technician to restore the product to its normal operation.
- e. If the product has been dropped or the cabinet has been damaged.
- f. When the product exhibits a distinct change in performance—this indicates a need for service.

20. Replacement Parts—When replacement parts are required, be sure the service technician has used replacement parts specified by the manufacturer or have the same characteristics as the original part. Unauthorized substitutions may result in fire, electric shock or other hazards.

21. Safety Check—Upon completion of any service or repairs to these products, ask the service technician to perform safety checks to determine that the products are in proper operating condition.

22. Carts and Stands—The appliances should be used only with a cart or stand that is recommended by the manufacturer.

23. An appliance and cart combination should be moved with care. Quick stops, excessive force, and uneven surfaces may cause the appliance and cart combination to overturn.

Figure 1.

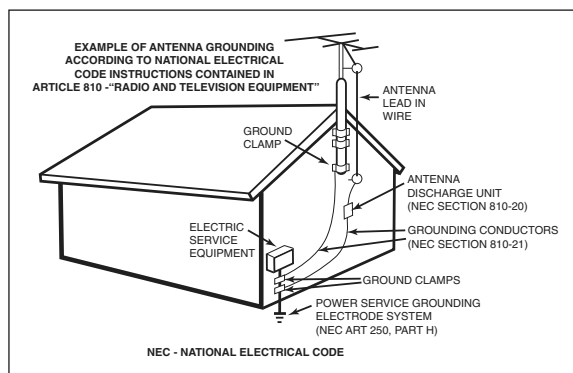

# POLK DIGITAL SOLUTION FEATURES AND BENEFITS

The Digital Solution system features the “Polk Performance Advantage.”™ There are many all-in-one home theater systems from which to choose. Electronics manufacturers build most of them, and the speakers are afterthoughts to the electronics. Only the Polk Digital Solution systems have speakers designed by “The Speaker Specialists” and the speakers come first. Ask any audiophile, the speakers make the system.

## Guaranteed Painless Performance

- Get the best digital surround performance from every DVD with the built-in Dolby Digital and DTS 5.1 surround processors.
- Your Digital Solution system is a fully integrated and performance optimized system. That means all the parts were designed together for a single purpose: to bring you the highest performance all-in-one home theater system on the planet.
- Plug n’ Play – the preamp/processor is pre-configured for the speakers to bring you high performance right out of the box, without the need for complicated set-up procedures.
- The perfectly matched front, rear and center speakers ensure seamless blending and life-like surround sound effects. You’ll feel like you are part of the action rather than a distant observer.
- Simple, intuitive operation. Everyone in the house, from kids to grandparents, can enjoy ultra high-performance home theater entertainment without reading this dopey manual.
- Got a big room to fill? Not to worry, Polk Digital Solution system has a robust 6 channel power amplifier built right into the subwoofer enclosure. This is an honest to goodness, high end, beefy power amp with all the features and buzzwords that send audiophiles into rapture - high current, dynamic headroom... Forget the jargon, this system plays loud and clean without strain even in large rooms.
- Home theater can be a group experience. The Polk speakers were designed to deliver broad, even dispersion of full response sound throughout the room. Everyone hears clean, clear dialog music and sound effects.

## Music In Other Rooms

- Would you like music in another room? No problem. The Digital Solution has independent Multi-Zone outputs that allow you to hear one source in a remote room while a different source is playing in the main room (requires an optional external stereo integrated amplifier and speakers for the second zone).

## Everything You Need

- The Polk Digital Solution also includes a sophisticated digital surround sound processor which hooks-up to the power amplifiers with a single convenient cable.
- You have lots of potential entertainment sources. The Digital Solution has enough analog (7) and digital (3) audio inputs to hook up any source – DVD Video, DVD-Audio, VCR, DSS, Tape, CD, Camcorder and Cable TV. No matter what new entertainment source comes along, you can hook it up to the Polk Digital Solution.
- The Digital Solution is equipped to accept 6 channel analog inputs from the latest SACD and DVD-Audio multi-channel format players that deliver superior high definition music reproduction.
- The Digital Solution comes with audiophile-grade cables for hooking up all the parts of the Digital Solution system.
- Is picture quality as important to you as the quality of sound? You’re going to love that the Digital Solution offers S-video inputs and outputs in addition to standard composite video. S-video cables provide better picture detail than conventional video cables. If your TV and video sources have S-video connections, use them.

## More Bass, Better Bass, Convenient Bass

- Some CDs have too much bass, some have too little. The same is true for movies. Most people like to adjust bass volume from CD to CD, movie to movie. We put the subwoofer volume control right on the remote to make it easy for you to get the right amount of bass without leaving your chair.
- Half of the world is looking for the meaning of life. The other half is looking for better bass. (This is as good as humor gets in the audio business.) If you are part of the latter half, we’ve got the subwoofer for you. The Digital Solution subwoofer uses our patented Power Port™ bass venting system to deliver deep, powerful bass with low distortion. Your friends will be green with envy.
- Most folks like more bass on movies than music. With the Polk Digital Solution once you have set the subwoofer level for a given mode (stereo or surround) the system remembers and returns to that setting. You can select a certain amount of bass for stereo and a different amount for surround. Every time you select that mode you get the same amount of bass you had last time you used it. We love this feature, we think you will too.



## GETTING STARTED

### Carton Contents

Your new Polk Audio Digital Solution system comes in multiple cartons. If you do not have any of the pieces listed below, or if any component seems damaged, contact your Polk Audio retailer immediately.

Two (2) front channel speakers  
Two (2) surround channel speakers  
One (1) center channel speaker  
One (1) subwoofer with built-in 6 channel amplifier  
One (1) Digital Solution Preamp/Processor  
One (1) Infrared remote control  
Two (2) AA batteries for remote  
Three (3) 20' (6M) speaker cables  
Two (2) 40' (12M) speaker cables  
One (1) 4 Meter DB-25 interconnect cable  
One (1) AM loop antenna  
One (1) FM dipole antenna  
One (1) FM antenna connector

### Quick Start Guide (see illustrations on pages 8 and 9)

1. Remove all of the components and accessories from the shipping cartons.
2. Connect sources such as DVD player, VCR, etc. to the Digital Solution audio and video inputs using coaxial (RCA-type) cables.
3. Connect the VIDEO TV output of the Polk Digital Solution preamp processor to a video input on your TV.
4. Connect the preamp/processor to the subwoofer with the supplied 4 meter DB-25 cable.
5. Using the supplied speaker wires, connect the speakers to the speaker terminals on the back of the subwoofer. Be sure to maintain correct polarity (+ to +, - to -) on all channels. Wires with a red band should always be connected to red terminals on the speakers and amplifier.
6. Plug the AC cords from the preamp/processor and subwoofer into 120V/60 Hz AC power outlets.
7. Turn the power switch on the subwoofer to the "Standby" position.
8. Press the power button on the preamp/processor front panel or remote control.
9. Select the input of your choice.
10. Set volume and bass level to taste and enjoy!

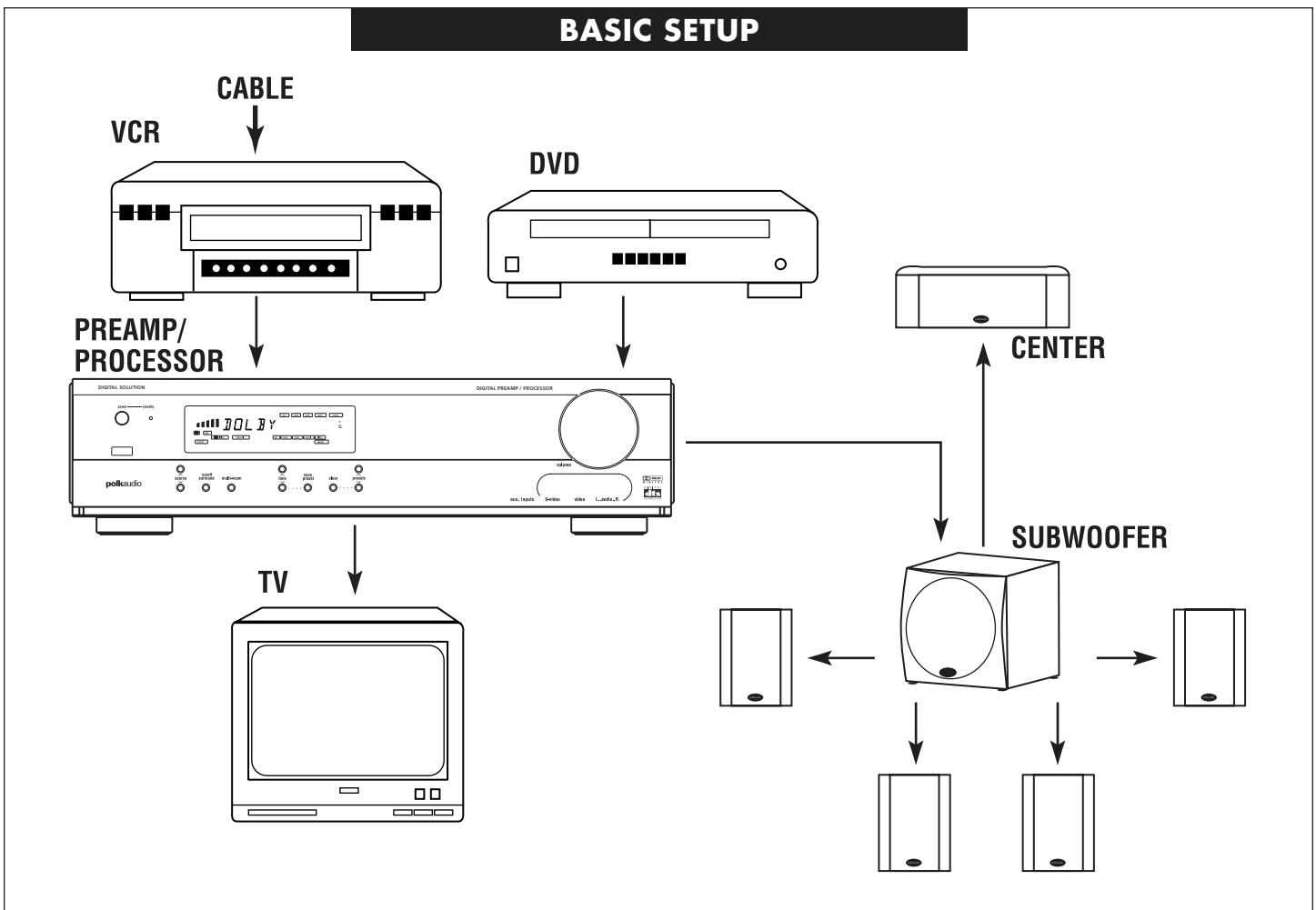

# REAR PANEL GUIDED TOUR

## Area A—Antenna Connections

This is where you hook up indoor or outdoor antennas for AM and FM radio reception.

## Area B—Audio Analog Inputs/Outputs

This is where connections are made for the analog audio outputs of sources such as CD player, DVD player, tape deck, etc. It is a good idea to connect the analog outputs of all sources, even digital sources, such as DVD, that have digital audio connections. Doing so allows tape recording of the audio output of the digital sources and the use of digital sources for multi-room sound.

## Area C—Multi-Room Outputs

These jacks allow you to use the sources (CD player, tape deck, etc.) connected to the Digital Solution as sources of sound in another room. See the section on "Using Multi-Room" on page 25 of this manual

## Area D—Video Inputs/Outputs

These jacks are used to feed the video signals of video players, such as VCR and DVD, into the preamp/processor and then out into your TV. This allows you to switch audio and video at the same time. For example, when you want to switch from watching the VCR to watching the DVD, you only have to push one button on the Digital Solution remote instead of two (one to switch audio on the Digital Solution remote and one to switch video on the TV remote).

There are two kinds of video jacks on the Digital Solution - standard "composite" and S-video. If a video source and your TV have S-video connectors, use them: you will get a picture with more detail and better color.

**IMPORTANT NOTE:** If you connect a video source to the Digital Solution with an S-video cable, you must connect the TV to the Digital Solution with an S-video cable, or you will not see the picture on your TV.

## Area E—Digital Inputs

This is where you connect sources with digital audio outputs, such as DVD, digital satellite receivers and other digital sources.

**IMPORTANT NOTE:** If you want to record from a digital source or use a digital source for multi-room audio, you must also connect the stereo analog outputs of the digital source to stereo analog inputs in Area B.

## Area F—Remote Control In/Out Connection

This feature is used only if you have a Polk Audio DVD player. It is useful when either the Polk DVD player or Digital Solution preamp/processor will be out of remote control range, such as in cases where one of the two is hidden behind a cabinet door. The Remote In/Out

feature allows one component to "feed" the other the remote control signals. If you have such a need, use a single coaxial RCA-type cable (not supplied) to connect the Remote Control Extension Out jack of the Digital Solution preamp/processor to the Remote Control In jack of the DP-1 CD/DVD/MP3 player.

## Area G—Multi-pin Connectors (on Preamp/Processor and Subwoofer)

These may look like connectors for computer printers, but they are not. This is the way the 6 channels of sound get from the preamp/processor to the 6 amplifiers that are built in to the subwoofer enclosure. We even supply the cable.

## Area H—Six Channel Analog Audio Inputs

Connect the analog outputs from any 6-channel source, such as a DVD-Audio or multi-channel SACD player, here.

## Area I—Speaker Connections (on Subwoofer)

This is where you hook up the speakers to the built-in amplifiers.

## Area J—AC Outlets (on pre-amp/processor)

Connect the power cables of components such as a cassette deck and CD player to these outlets. The one marked UNSWITCHED is always live as long as the Digital Solution preamp/processor is plugged into a live outlet. A component connected here may be left on permanently, or may be switched off with its own power switch. **Caution:** In order to avoid potential turn-off thumps, anything plugged in here should be turned on before the Digital Solution is turned on.

The outlet marked SWITCHED only delivers power if the Digital Solution is on. This is a good place to plug in any component that you want to turn on and off along with the Digital Solution system. Check the AC power rating of the components you want to plug into these outlets. If either component draws more 0.8 Amperes of current, do not use these outlets. Plug the component directly into a wall socket or power strip.

## Area K—Subwoofer power functions (on Subwoofer)

Once everything else is hooked up, set the switch to the "Standby" position. If the system fails to function, disconnect the subwoofer's power cord from the AC outlet, remove and inspect the fuse. Replace with the same fuse value as marked on the amplifier.

**SAFETY WARNING:** Never replace the fuse with one of a higher Ampere rating or wrap the fuse in metal foil.

## Area L—Pilot light (on Subwoofer)

When the subwoofer is plugged in to a live AC outlet and the power switch (K) is set to "Standby" this light will glow red while the preamp/processor is "off," and green when the preamp/processor is "on."

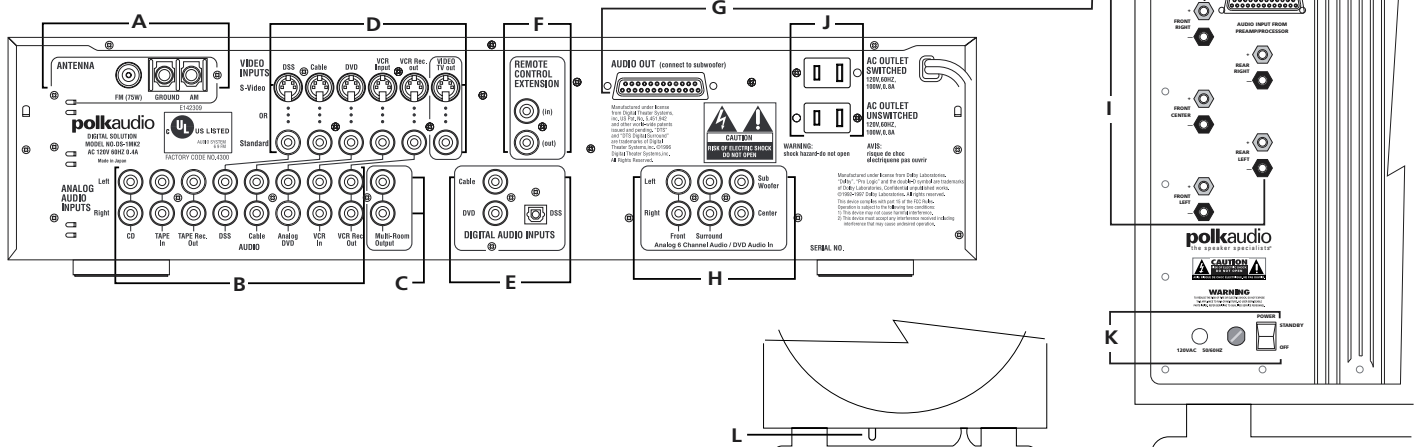

**Note:** Amplifier layout may be slightly different than that shown, depending on model of DS system.

# BASIC SYSTEM HOOK UP

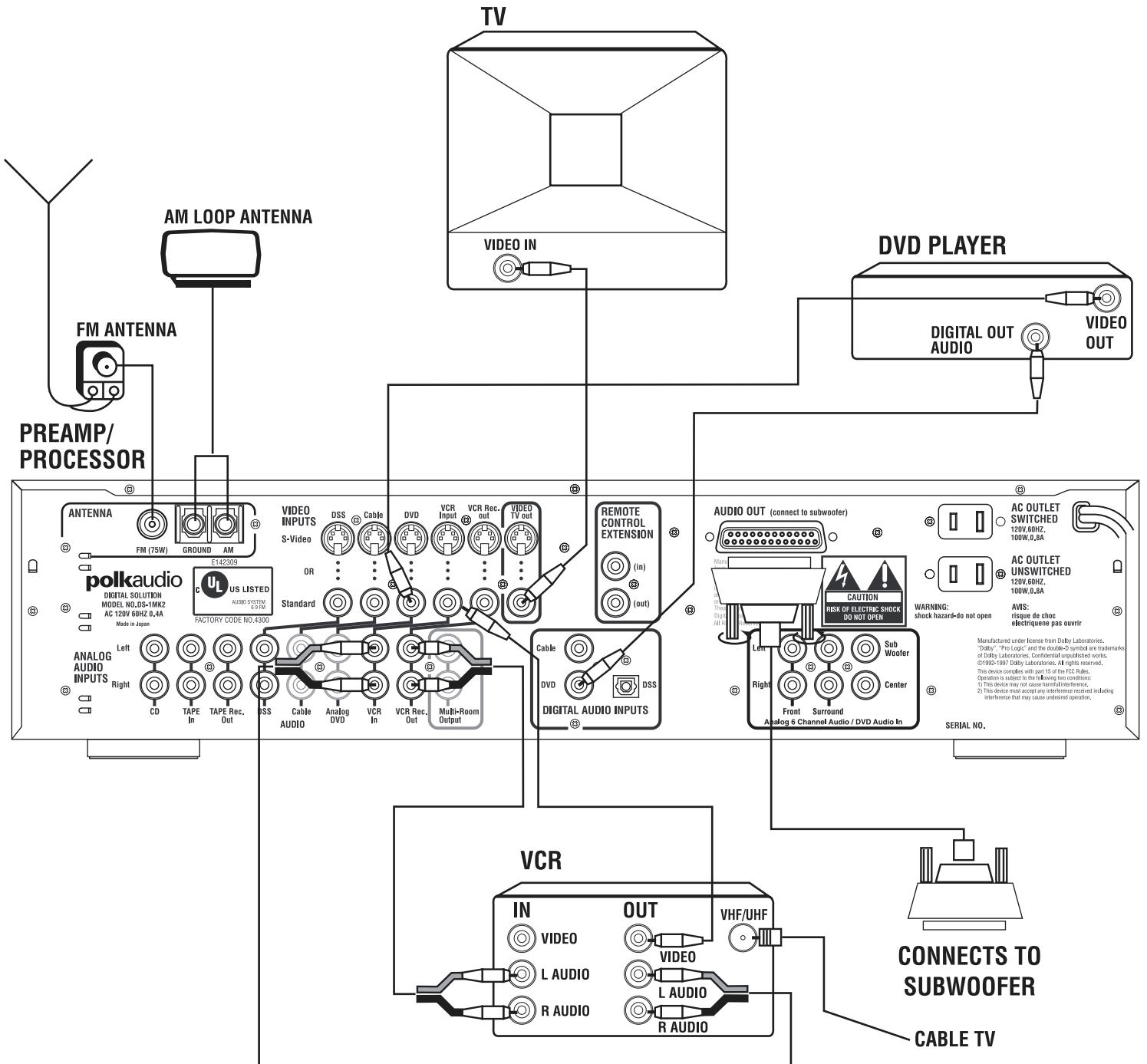



# SPEAKER HOOK UP

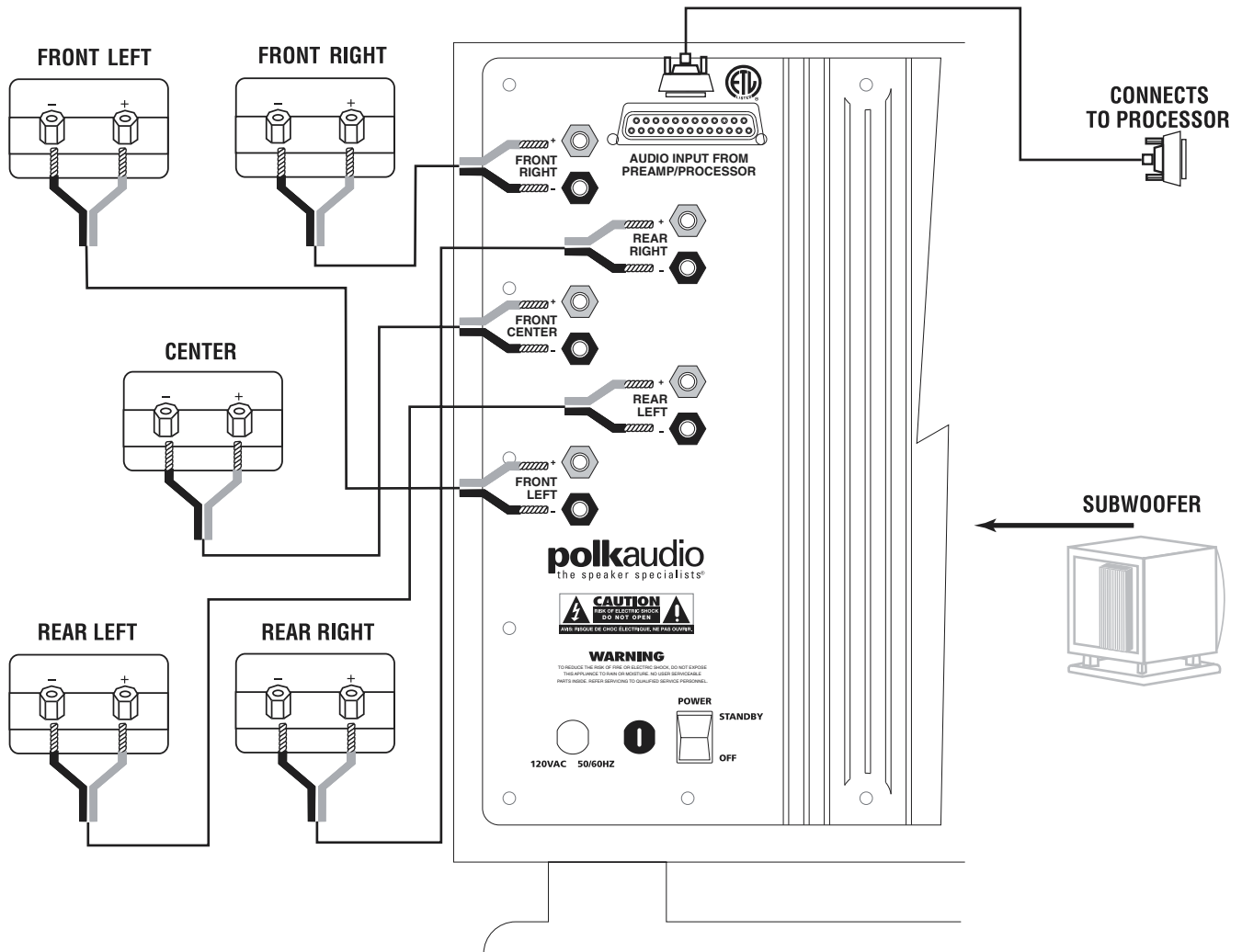

**Note: Amplifier layout may be slightly different than that shown, depending on model of DS system.**

# HOOKING UP THE SYSTEM

## Connection Precautions

- Do not plug the preamp/processor or subwoofer into AC outlets until all other connections have been made.
- When connecting video sources, use either standard composite (good) or S-Video (better) cables throughout. Do not use both composite and S-Video connections. Use the same type of cable between the preamp/processor and your TV.
- Connect one cable at a time observing the "input" and "output". This will avoid any cross connection between channels and signal inputs and outputs.
- Insert the plugs securely. Incomplete connections may result in noise or signal loss.
- We've included high quality pre-cut speaker wire and a 25-pin processor-to-subwoofer cable. To hook up your sources, we recommend you use high quality audio and video connecting cables. See your Polk Audio dealer for specific recommendations.
- Prior to connecting other audio and video equipment to the Digital Solution, please read their owner's manuals.

## Connecting Radio Antennas

Connect the supplied FM wire antenna to the FM (75 Ohm) F-type connector. For better reception connect an indoor or outdoor FM antenna.

The Polk Digital Solution comes supplied with an AM loop antenna that connects to the GROUND and AM terminals as illustrated. To find the best place to put the AM antenna, tune in a local AM radio station (see page 22) and move the AM loop antenna around until you get the clearest reception. You can secure the antenna to a wall or the inside wall of an equipment cabinet with screws.

## Connecting a DVD Player

Connect the coaxial digital output of the DVD player to the DVD DIGITAL AUDIO INPUT of the Digital Solution preamp/processor. (If you do not make this connection you will not hear 5.1 digital surround sound.) We recommend that you also connect the Left and Right analog outputs of the DVD player to the analog audio DVD inputs of the Digital Solution. You must first remove the black dummy plugs. This will allow you to tape record the audio output of the DVD player and use the DVD player as an audio source for a remote room.

Connect either the composite video or the S-video output of the DVD player to the corresponding DVD video input of the Digital Solution. If you use S-video connections here, you must connect your TV to the Digital Solution preamp/processor with an S-video cable in order to get a picture with this input. If your DVD player has "component" video outputs (three jacks), you must connect those directly to a TV that has corresponding "component" video inputs.

A very few DVD players do not have a coaxial (RCA type) digital output but only an optical cable output. In that case, hook up the DVD player into the DSS optical digital, analog audio and video inputs. Select "DSS" when you want to use your DVD player.

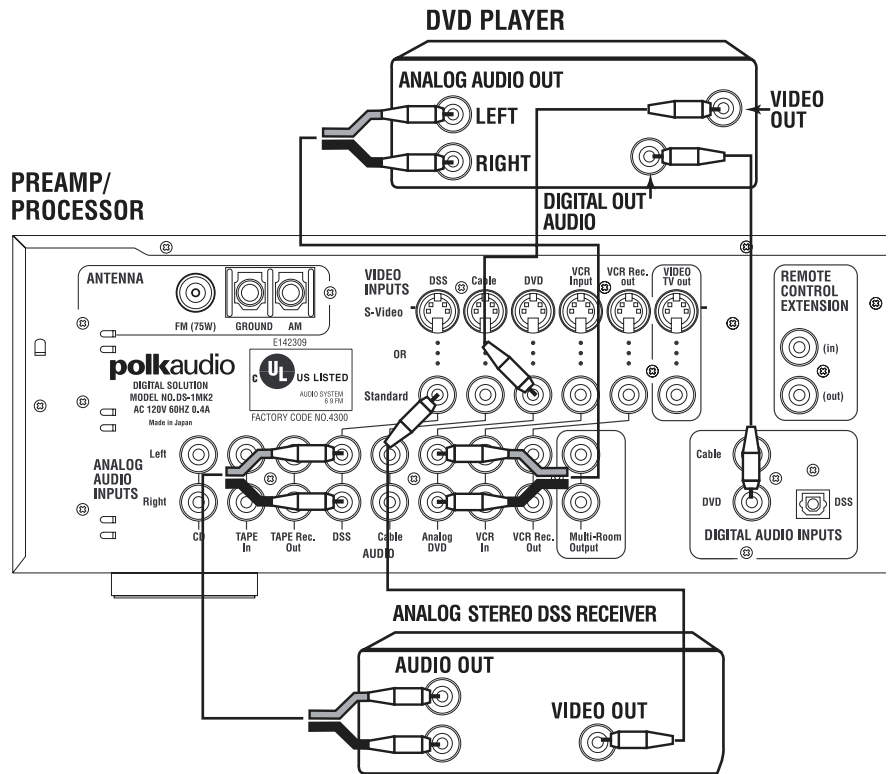
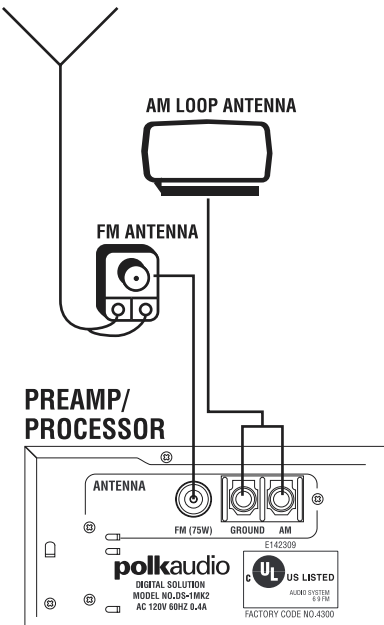

(See next page)

## Connecting an Analog DSS (satellite TV) Receiver (see diagram on previous page)

The first generation of DSS receivers (pre 1999) only have analog audio outputs and are not capable of delivering 5.1 channel digital surround sound. If your DSS receiver box only has Left and Right audio jacks and no jack marked "Digital Out" or "PCM Out," use this hook up method. DSS receivers made in 1999 or later with a "Digital Out," "Optical," "TOS Link" or "PCM Out" jack should be connected as described in "Connecting a Digital DSS Receiver" below. If you have any doubts as to which type of DSS receiver you have, contact your DSS dealer.

Connect the left and right audio outputs of the DSS receiver to the Left and Right DSS inputs on the Digital Solution preamp/processor. Connect either the composite video or the S-video output of the DSS receiver to the corresponding DSS video input of the Digital Solution. Do not use both composite and S-video connections. If you use S-video connections here, you must connect your TV to the Digital Solution preamp/processor with an S-video cable in order to get a picture with this input.

## Connecting a Digital DSS (satellite TV) Receiver

Connect the optical digital output of the DSS receiver to the DSS DIGITAL INPUT of the DIGITAL SOLUTION using a TOS LINK fiber-optic cable available at your Polk Audio dealer. We also recommend connecting left and right analog audio outputs of the DSS receiver to the Left and Right DSS inputs on the Digital Solution preamp/processor. This will allow you to record the audio output of the DSS on to a VCR.

If your DSS receiver does not have an optical digital output jack, connect your DSS receiver to the CABLE inputs and select the "Cable" input.

Connect either the composite video or the S-video output of the DSS receiver to the corresponding DSS video input of the Digital Solution. Do not use both composite and S-video connections. If you use S-video connections here, you must connect your TV to the Digital Solution preamp/processor with an S-video cable in order to get a picture with this input.

## Connecting a VCR

Connect the Left and Right audio outputs of the VCR to the Left and Right analog audio VCR In jacks of the DIGITAL SOLUTION. Connect the Left and Right audio inputs of the VCR to the Left and Right VCR Rec. Out jacks of the Digital Solution.

Connect either the composite video or the S-video output of the VCR to the corresponding VCR video input of the Digital Solution. Do not use both composite and S-video connections. If you use S-video connections here, you must connect your TV to the Digital Solution preamp/processor with an S-video cable in order to get a picture with this input.

## Connecting a CD Player

Connect the analog stereo outputs of your CD player to the Left and Right CD inputs of the Digital Solution preamp/processor.

## Connecting an Audio Tape Deck

Connect the outputs of the tape deck to the TAPE IN jacks of the Digital Solution. Connect the inputs of the tape deck to the TAPE REC. OUT jacks of the Digital Solution.

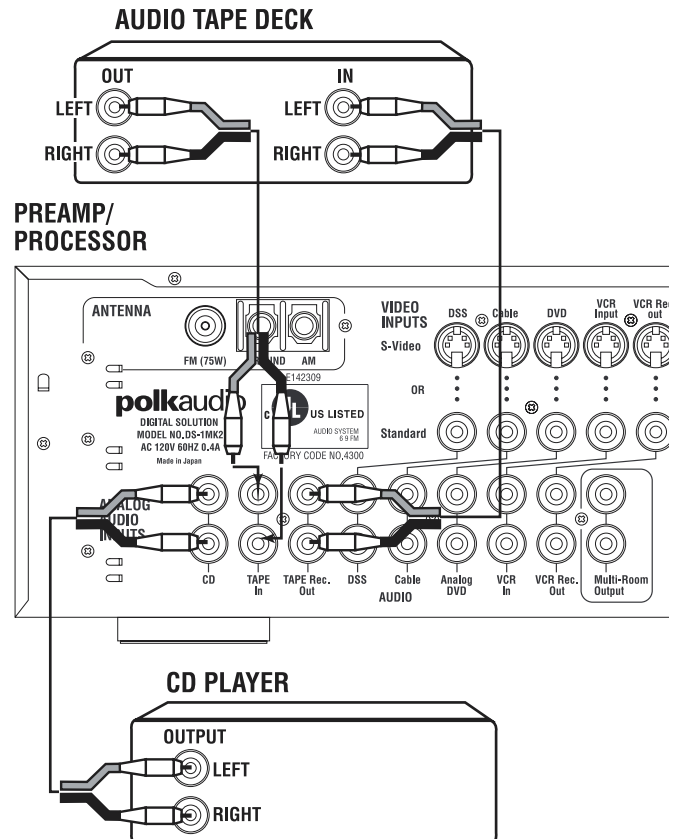
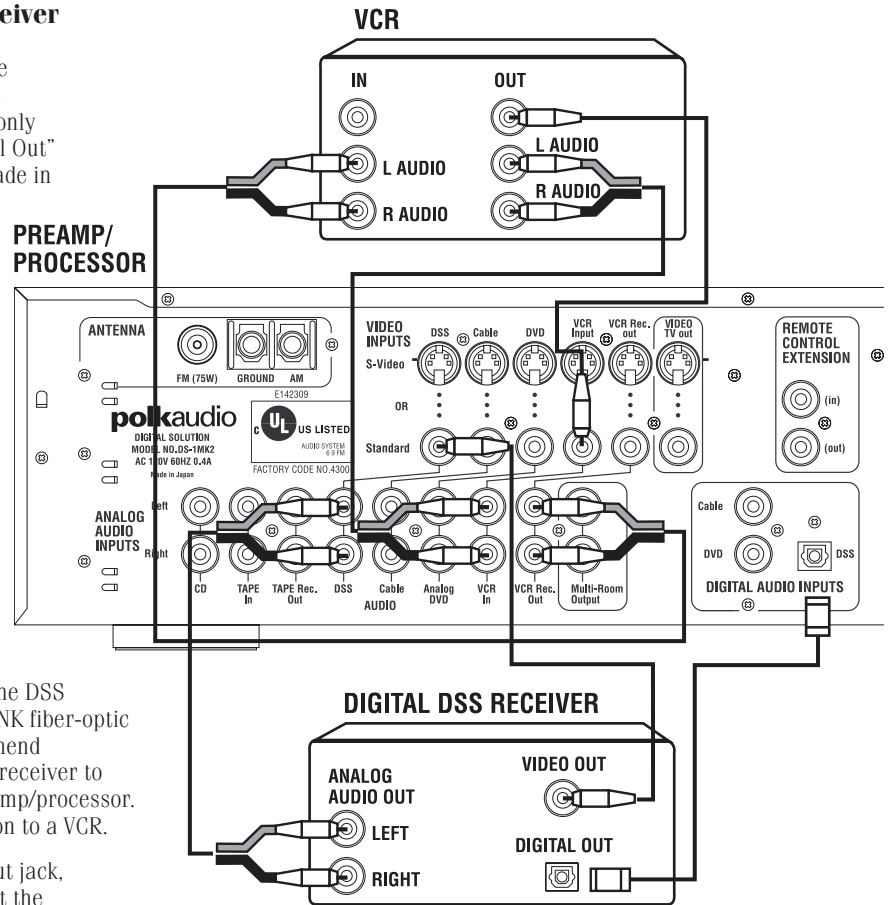

## Connecting a SACD or DVD-Audio Player

If you have a multi-channel SACD or DVD-Audio player that also serves as a DVD-Video and CD player, we suggest you make all of the connections described here.

Connect the six analog outputs from the multi-channel player to the corresponding analog 6 Channel Audio/DVD-Audio inputs on the Digital Solution preamp/processor. Connect the digital audio (PCM/Bitstream) output of the player to the DVD DIGITAL AUDIO INPUTS of the DS preamp/processor.

Also connect the stereo left and right analog audio outputs of the player to the ANALOG DVD Left and Right inputs on the Digital Solution preamp/processor. This will allow you to record the audio output of the player and use the player as a stereo audio source for a remote room.

Connect either the composite video or the S-video output of the player to the corresponding DVD VIDEO input of the Digital Solution. Do not use both composite and S-video connections. If you use S-video connections here, you must connect your TV to the Digital Solution preamp/processor with an S-video cable in order to get a picture with this input. If your DVD player has "component" video outputs (three jacks), you must connect those directly to a TV that has corresponding "component" video inputs.

## Connecting Your TV to the DIGITAL SOLUTION Preamp/Processor

If you are using only standard (composite) video inputs for your video sources and no S-video sources, connect the VIDEO TV out to any free composite video input of your TV. If you are using only S-Video video inputs for your video sources and no Standard (composite) sources, connect the VIDEO TV out to any free S-Video input of your TV. If you are using both standard composite and S-Video sources connect both Standard and S-Video TV outputs of the Digital Solution to different corresponding free inputs on your TV.

If you want the audio from your TV to play through the system, just connect its audio outputs to any unused set of analog input jacks on the Digital Solution, such as the CABLE inputs.

## Connecting the Preamp/Processor to the Subwoofer

Use the supplied 4 meter (13') audio cable to connect to the AUDIO OUT connector of the Digital Solution preamp/processor to the AUDIO IN 25 pin connector on the subwoofer. IMPORTANT NOTE: If the cable is not long enough, you may add a 4 meter Monster Cable brand DB HT Audio Interconnect cable (or equivalent) to increase the length to 8 meters (26'). Contact your Polk dealer or call Polk Audio Customer Service (800) 638-7276, Monday through Friday, Eastern Standard Time to order an extension cable. Do not use a computer printer cable to connect your Digital Solution system. A printer cable will fit but will degrade the sound quality of your system.

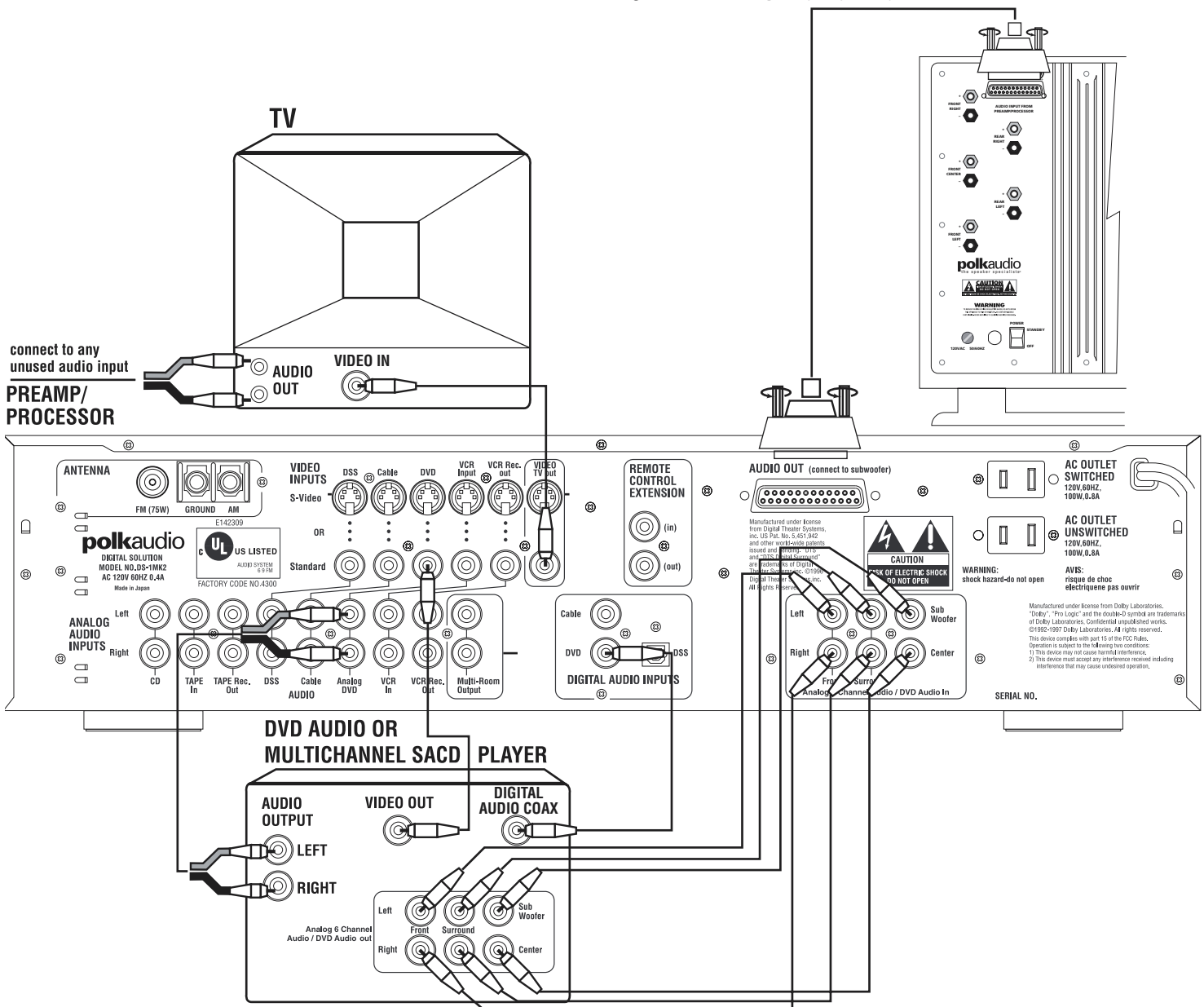

## Connecting the Speakers

We have supplied you with 5 sets of audiophile-grade speaker wire to connect your speakers. Each wire is color coded just to make it easy for you to see which wire is which at the amplifier side. There are three 20' wires and two 40' wires. In most set-ups the 20' wires are the proper length for the front and center speakers but you can use any wire on any channel. Use whatever length makes sense for your set up and speaker placement. If you want to trim the wires to the exact needed length, use a pair of wire cutters to cut the wire and strip a ½ inch of insulation from the cut end. Make sure you identify which conductor is + (red) and which is - (black) so that you can maintain correct polarity.

### Front L&R Speakers

Use one of the supplied speaker wires to connect the Left satellite speaker to the Left Front speaker output on the subwoofer amplifier. One conductor of the speaker wire is marked with a red band. Use that conductor to connect the red (+) terminal of the speaker to the red (+) Left Front speaker terminal on the subwoofer amplifier. Use the speaker wire conductor with a black band to connect the black (-) terminal of the satellite speaker to the black (-) terminal on the subwoofer amplifier. To get a secure connection, loosen the 5-way binding post thumb nuts far enough to slip the bare wire into the hole in the shaft. Tighten the thumb nut by hand or a 3/8" nut driver. DO NOT OVER TIGHTEN. Repeat for the Right Front channel speaker.

### Center Speaker

Follow the same procedure described above to connect the center speaker to the Center Speaker outputs on the subwoofer amplifier.

### Surround L&R Speakers

Follow the same procedure described above to connect the rear surround speakers to the Left Surround and Right Surround speaker outputs on the subwoofer amplifier.

**IMPORTANT NOTE:** Be careful to maintain correct polarity on all the speakers by always using the speaker wire with the red band for the red (+) terminals and the black marked wire for the black (-) terminals ON THE AMPLIFIER AND ALL THE SPEAKERS. Failure to maintain correct polarity will result in poor sound quality. Double check all connections before using the system.

## Connecting to AC Outlets

Once you are completely done connecting all your source components, TV and speakers, you can plug the system into household 110-120V, 60 Hz AC power outlets. Locate the Power switch on the back of the subwoofer and set it to the "Standby" position. A small pilot light on the bottom of the subwoofer will glow red indicating that the system amplifiers are plugged in and awaiting a turn-on "order" from the preamp/processor. When the preamp/processor is turned on, it will turn the amplifiers fully on and the pilot light will glow green. If you will be away from home for an extended period of time, turn the subwoofer power switch to "Off."

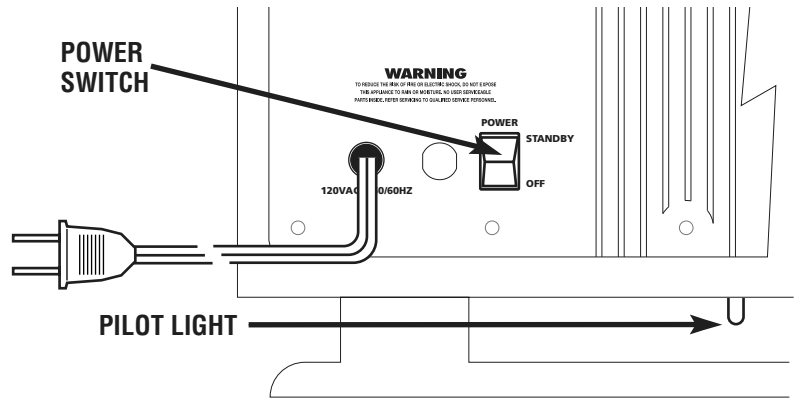

If the supplied speaker wire is not long enough, contact your Polk Audio retailer. Do not use lamp cord. Use high quality 16 gauge or thicker speaker wire.

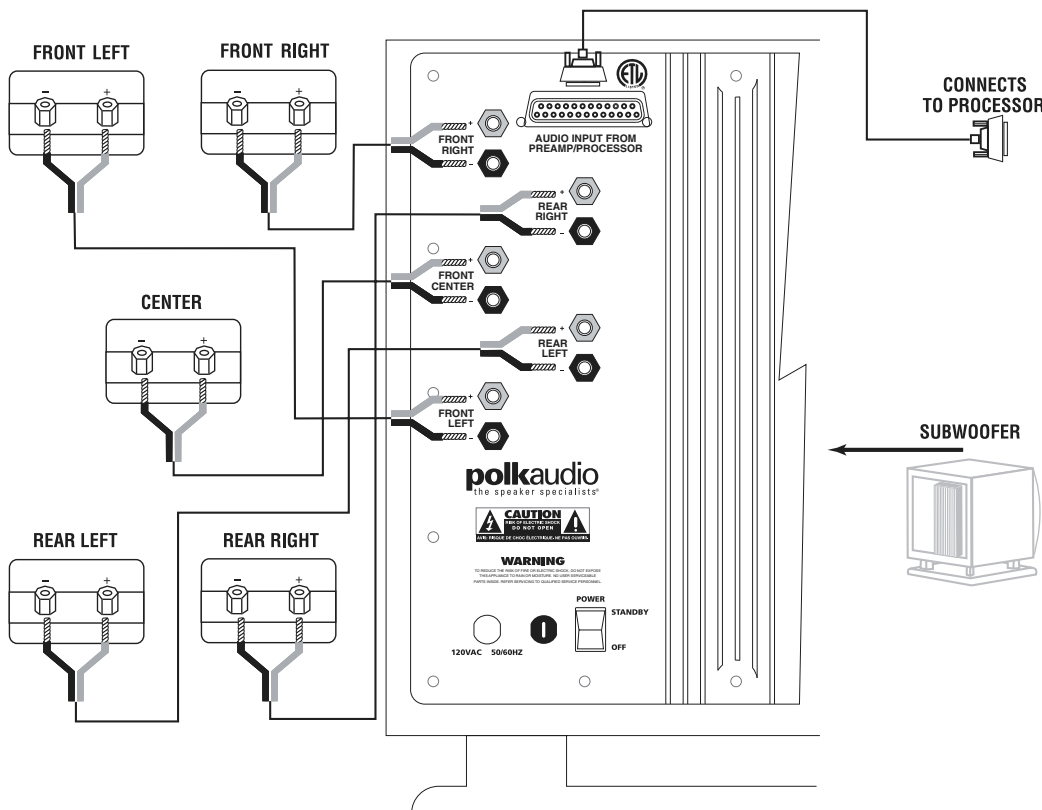

### Using 5-way binding posts



Loosen hex nut

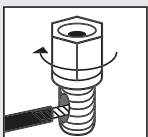

Insert speaker wire through hole

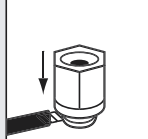

Tighten hex nut

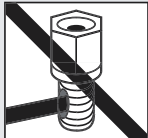

Do not insert insulated section of speaker wire

## SPEAKER PLACEMENT

### IMPORTANT NOTE:

When this manual refers to "Front Left", we mean the speaker on your left side as you face the front (TV) side of the room. When we refer to "Surround Left" we mean the speaker that is behind you and to your left as you face the front (TV) side of the room. For more detailed speaker placement information consult the manual in the speaker cartons or visit <http://www.polkaudio.com/home/faq/>.

### Center Channel Speaker

Place the center speaker as close to the TV as possible. The most popular placement is right on top of your TV set. It is also fine to place it below the TV or on the wall directly above the TV.

### Front Speakers

Place the front satellites about as far apart as you are sitting from them. Avoid placing them less than 2 feet from side walls.

### Surround Speakers

The best placement for surround channel speakers is high on the side walls, facing each other and slightly behind your listening position. If this placement is not possible, the speakers may be placed on the rear wall. In either case, mount the speakers two to four feet above a seated listener's head.

### Subwoofer

The subwoofer may be placed in an entertainment center, behind furniture or next to a sofa or chair. For best performance place it on the same side of the room as the front satellites. It should only be seated on the plinth as illustrated. NEVER LAY THE SUBWOOFER ON THE AMPLIFIER END - THIS WILL DAMAGE THE AMPLIFIER.

The Digital Solution subwoofer is magnetically shielded and may be placed close to a television set. However, if you see any color distortion in your TV, move the subwoofer away from the set.

If the audio input cable is not long enough, you may add a 4 meter (13') Monster Cable brand DB HT Audio Interconnect cable (or equivalent) to increase the length to 8 meters (26'). Contact your Polk dealer or call Polk Audio (800) 638-7276, ext. 324, Monday through Friday, Eastern Standard Time to order an extension cable.

### Wall Mounting Speakers

If you chose a Digital Solution system with wall-mount speakers, consult the owner's manual in the speaker shipping carton for detailed directions

### Floor Stands

Consult your Polk Audio retailer or visit <http://www.polkaudio/tran-guard.com> to see a selection of floor stands appropriate for your Polk speakers.

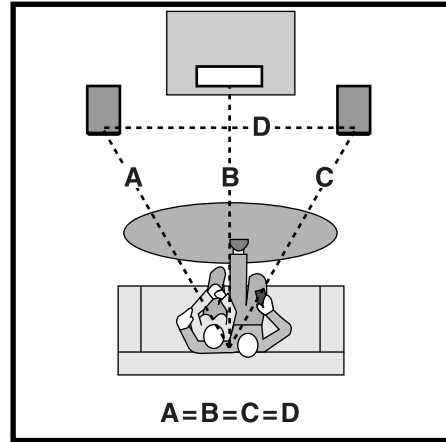

(Fig. 4)

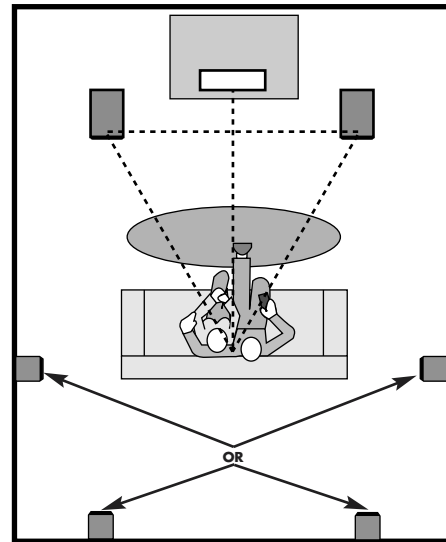

(Fig. 5)

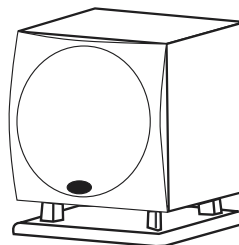

## High Performance Accessories for your Digital Solution

The days of plywood and cinderblock shelves and milk crate speaker stands are far behind you now. Your new Digital Solution System deserves the best in performance enhancing accessories. Your Polk Audio dealer has a full supply of high performance accessories like these for your home theater. Or, you can get the most from your home theater by ordering conveniently and securely through the Polk Audio Webstore. Just point your browser to <http://polkaudio.tranguard.com/>.

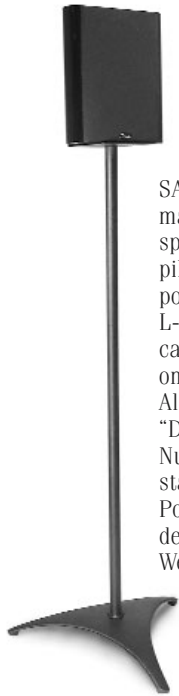

### ◀ Polk Audio SA-1 RM Speaker Stands

SA-1 Speaker Stands (shown) are custom made specifically for our smaller satellite speakers. The single black powder-finish pillar rises gracefully from the stable tripod base and terminates in a large metal L-bracket, to which the RM7200 speakers can be easily attached. SA-1 Stands are only available at the Polk Audio Webstore. Also available in the Polk Audio Webstore: "Designer Foundations" stands (with solid NuStone bases) and "Euro Foundations" stands by Sanus Systems, both perfect for Polk Audio RM Series speakers. (Stand designs subject to change. Check the Webstore for the latest Sanus designs.)



### Articulating Wall Brackets by OmniMount Systems ▶

Focus your acoustic energy with secure, patented, heavy-duty ball & socket brackets from OmniMount. Use the 25 Series to suspend your RM Series speakers from walls or ceilings with secure screw mounts and plates. OmniMount brackets come complete with all necessary mounting hardware including wall anchors. Quality made in the USA, and just a click away on the Polk Audio Webstore.



### AVIA Guide to Home Theater Calibration DVD

AVIA helps you set up and optimize your home theater right from your DVD player. AVIA covers it all: Speaker placement options, level settings, and extensive color calibrations for your TV. Get the best possible performance from your equipment. AVIA's calibration tests and patterns are simple to access from the DVD menus, and easy to perform with the included color filters. Get yours at the Polk Audio Webstore.



### ◀ Polk Audio DR-3 Unified Learning Remote

Tired of the clutter of remote controls on your coffee table? We are too. So we developed the DR-3 Unified Learning Remote Control. It has all the most-often-used controls of the Digital Solution system built right in, plus you can easily (and we do mean easily) program it to operate your TV, VCR, DVD player, etc. The DR-3 comes with the Polk Audio DP-1 CD/DVD/MP3 player, but if you didn't get a DP-1, you can get the DR-3 remote from your Polk dealer or from the Polk Audio Webstore.

### The MultiZone Solution—Atrium 45p Powered Speaker

The DS System's MultiZone function gives you control over powered speakers located in a remote setting. The Polk Audio Atrium 45p Powered Speakers work perfectly as remote speakers with your DS System's MultiZone function. Atrium 45p Powered Speakers are available ONLY at your authorized Polk Audio Dealer. *Not Available on the Polk web site.*



You'll find more high performance accessories at your authorized Polk Audio dealer. Or, log on to the Polk Audio Webstore <http://polkaudio.tranguard.com/> for a complete selection of competitively priced stands and AV furniture by Sanus Systems, articulating brackets by OmniMount Systems, and Polk-recommended AV tweaks including calibration DVDs and vibration & ground loop isolators.

Visit: <http://polkaudio.tranguard.com/>  
or call (800) 377-7655 ext. 807

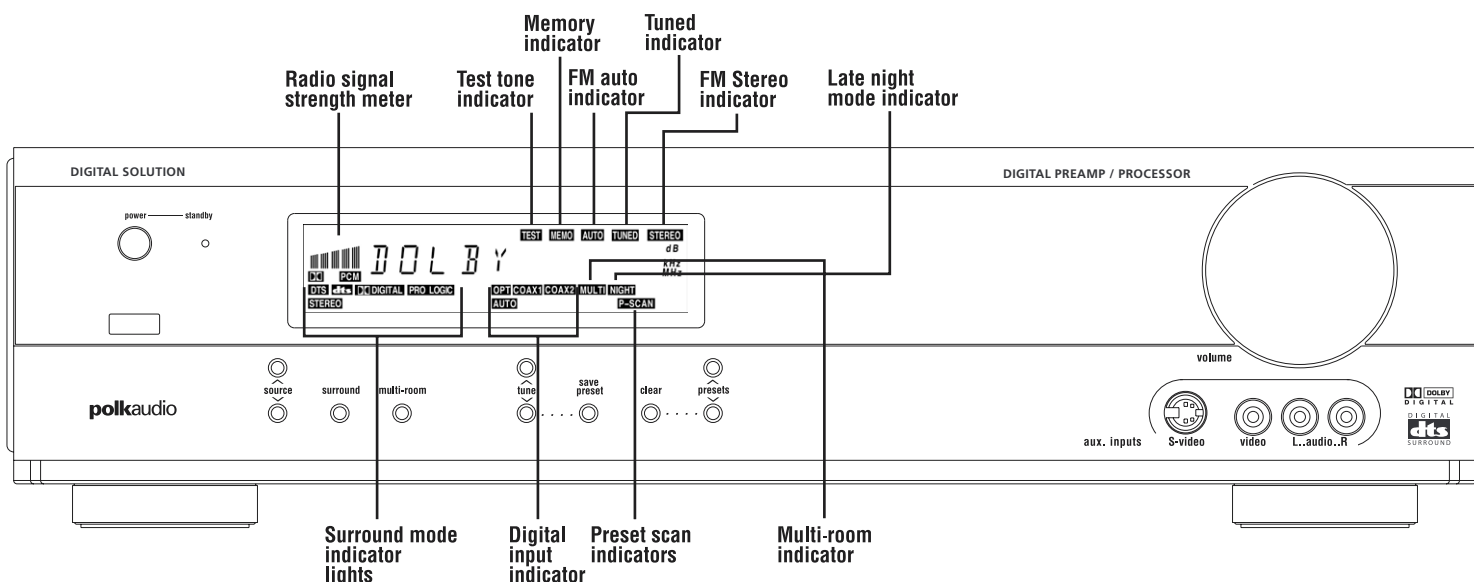
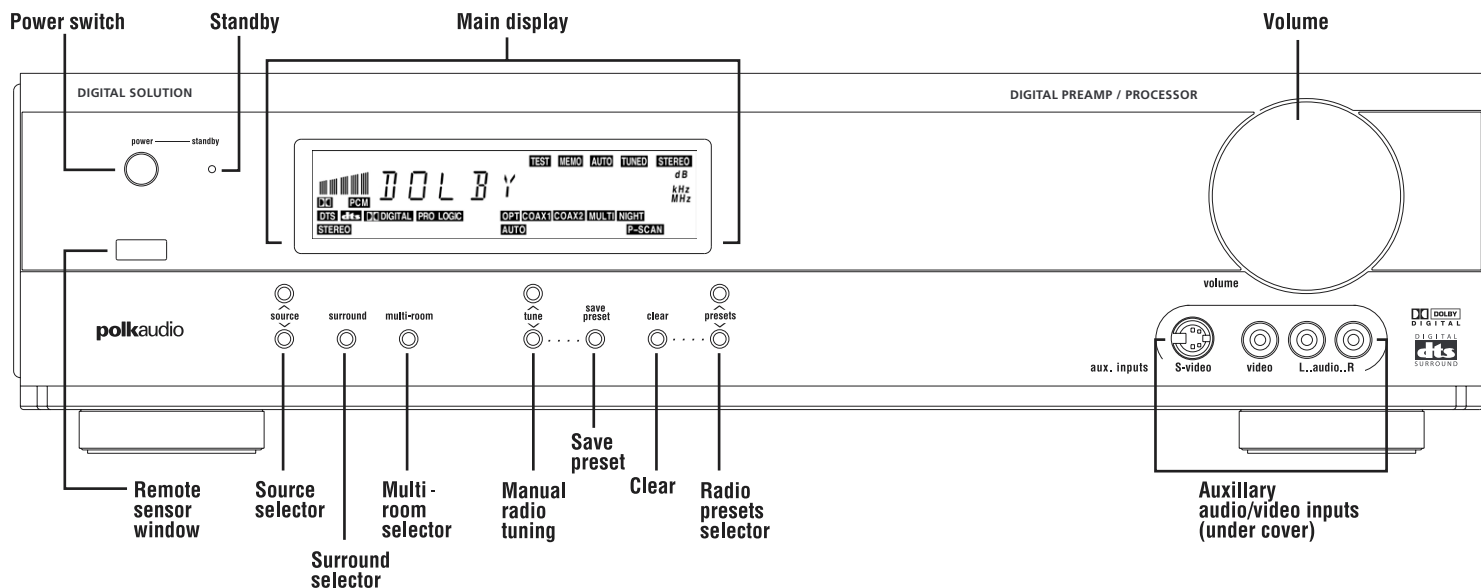

## PREAMP/PROCESSOR FRONT PANEL GUIDED TOUR

### Power Switch and Standby Indicator

When this switch is pressed once, the power turns ON and lights appear on the Main Display panel. When pressed again, the power turns OFF and the standby indicator light glows red. Make sure the Power switch on the back of the subwoofer enclosure is set to the "Standby" position. When you turn on the preamp/processor, the amplifiers in the subwoofer enclosure will also turn on and you will see a green glow on the base of the subwoofer. When the preamp/processor is turned off the amplifiers turn off and the light in the subwoofer base glows red.

### Main Display

Displays a variety of information depending on what action was most recently taken. Normally it indicates the current selected input (CD, DVD, etc.). It also displays the current selected surround mode (Stereo, Pro Logic, Dolby Digital, DTS) as well as volume, bass level and other information on a "flash" basis. See page 17 for what all those teeny little lights mean.

### Volume Control

Adjusts the overall sound level. Turning the control clockwise increases the sound level, turning it counter-clockwise decreases the volume level. When you use the Digital Solution System for the first time set the volume to -20dB (as indicated in the display window). This will be a comfortable listening level in most rooms. Adjust to taste.

### Remote Sensor Window

This window receives infrared signals from the remote control unit. Aim the remote control unit at this sensor window. Do not allow any solid object to block the path between the remote control and this window.

### Source ▲ ▼ Selector Buttons

These buttons are used to select the source of sound and video such as DVD, DSS, VCR and AUX. Video and audio are switched simultaneously on those inputs that have both video and audio input jacks. For example, when you select DVD, the picture and sound of the DVD player are automatically switched on together. The buttons toggle through the inputs in the following sequence



See page 23 for more information on using this feature.



#### **IMPORTANT NOTE:**

The FM radio, AM radio, CD, and Tape audio inputs do not have corresponding video inputs. When you select any of these sources, you will see a blank screen on your TV (if your TV is on).

#### **Surround Button**

This button switches between the various surround sound modes and 2-channel stereo (except when the 6 Channel Audio input is used).

**IMPORTANT NOTE:** The Dolby Digital (AC-3) and DTS modes can be selected only when either DSS Digital, cable Digital or DVD inputs are selected. If you have selected a digital source with a Dolby Digital or DTS soundtrack and you cannot get the 3/2.1 indicator on the display, the most likely causes are:

1. The DVD player is not set to send out a 5.1 channel Dolby Digital or DTS signal. In this case check the DVD player's operation manual.
2. The 5.1 soundtrack has not been selected on the DVD disc. In this case press the disc menu button on your DVD player to access the DVD disc's menu, and select either the Dolby Digital 5.1 or DTS 5.1 selections on the disc's set-up menu. Consult your DVD player's operation manual for more information.

3. The DVD disc does not have a 5.1 surround soundtrack. This is especially true of pre-1985 movies.

#### **Multi-Room Button**

Pressing this button switches the multi-room mode on and off. See page 25 for more information on using this feature.

#### **Tune ▲▼ Buttons**

When either the AM or FM sources are selected, these buttons allow you to manually tune in AM and FM radio stations. Pressing the ▲ button moves the tuner up the radio band. Pressing the ▼ button moves the tuner down the radio band. The tuner stops as soon as you release your finger from the button. See page 22 for more information on using this feature.

#### **Save Presets Button**

When you want to select a radio station as a preset station, manually tune to that station, press and hold the Save Presets button for 4 - 5 seconds. You will see the red **MEMO** light on the display flash. When the **MEMO** light stops flashing, the radio station has been saved and assigned the next available preset slot number. You may preset up to 50 radio stations. See page 23 for more information on using this feature.

#### **Clear Button**

When you want to clear a radio station from the list of presets, select that preset station, then press and hold the Clear button until CLEAR appears on the display. See page 23 for more information on using this feature.

#### **Presets ▲▼ Buttons**

These button select from the list of preset radio stations. Pushing the ▲ button moves from lower preset slots numbers to the higher preset slot numbers. Pushing the ▼ button moves down through the list of preset stations.

#### **Aux Inputs Jacks**

These auxiliary video/audio input jacks are revealed by removing the oval rubber cover. They accept the connection of a camcorder, portable VCR, or any other temporary source. To make proper connections, refer the owner's manual of the auxiliary component.

#### **Signal Strength Meter**

This meter shows the relative signal strength of a radio signal. For best reception, orient your antenna to get the maximum number of bars on this meter.

## **WHAT THOSE TEENY LITTLE LIGHTS MEAN**

#### **Test Tone Indicator** **TEST**

This light illuminates when the surround sound balance test tone is engaged. You should hear a "Ssshhhh" noise from one speaker when this is on. See page 20 for more information.

#### **Memo Indicator** **MEMO**

This light illuminates when saving preset radio stations. See page 23 for more information.

#### **Auto Indicator** **AUTO**

Shows that the tuner is prepared to receive a stereo FM broadcast.

#### **Tuned Indicator** **TUNED**

This lights when a radio station has been properly tuned in.

#### **FM Stereo Indicator** **STEREO**

Lights when a stereo FM broadcast is received.

#### **Surround Mode Indicators** **STEREO** **PRO LOGIC** **DIGITAL** **DTS** **dts**

Indicates whether the system is delivering Stereo, Dolby Pro Logic, Dolby Digital or DTS sound. See page 24 for more information.

#### **Digital Input Indicators** **OPT** **COAX1** **COAX2**

Indicates which digital audio input is selected and operating.

#### **Late Night Indicator** **NIGHT**

Indicates that the late night Dolby Digital compression circuit is engaged. See page 23 for more information on this function.

#### **Preset Scan Indicator** **P-SCAN**

Lights when the tuner is scanning through the radio station presets.

# REMOTE CONTROL OPERATION

## Loading Remote Control Batteries

1. Remove the back cover.
2. Insert two AA type batteries with correct (+) and (-) polarity.
3. Close the back cover until it clicks.

The batteries will last about 4 months with normal use. Change the batteries as soon as you notice that the range of the remote control has decreased.

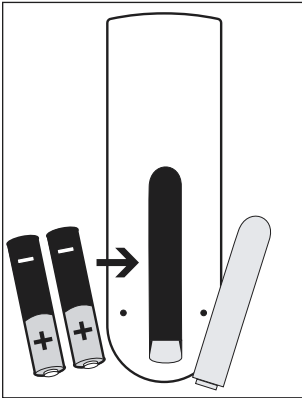

## Remote Control Range

The distance between the remote control transmitter and the preamp/processor should be 15 feet (5 meters) or less. If the transmitter is pointed to a direction other than the IR SENSOR or if there is an obstacle between them, the remote control may not work correctly.

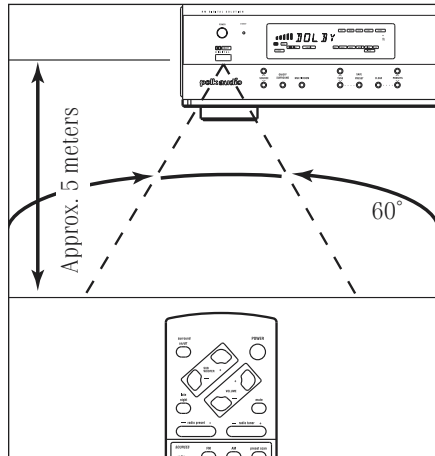

### B - Subwoofer level control

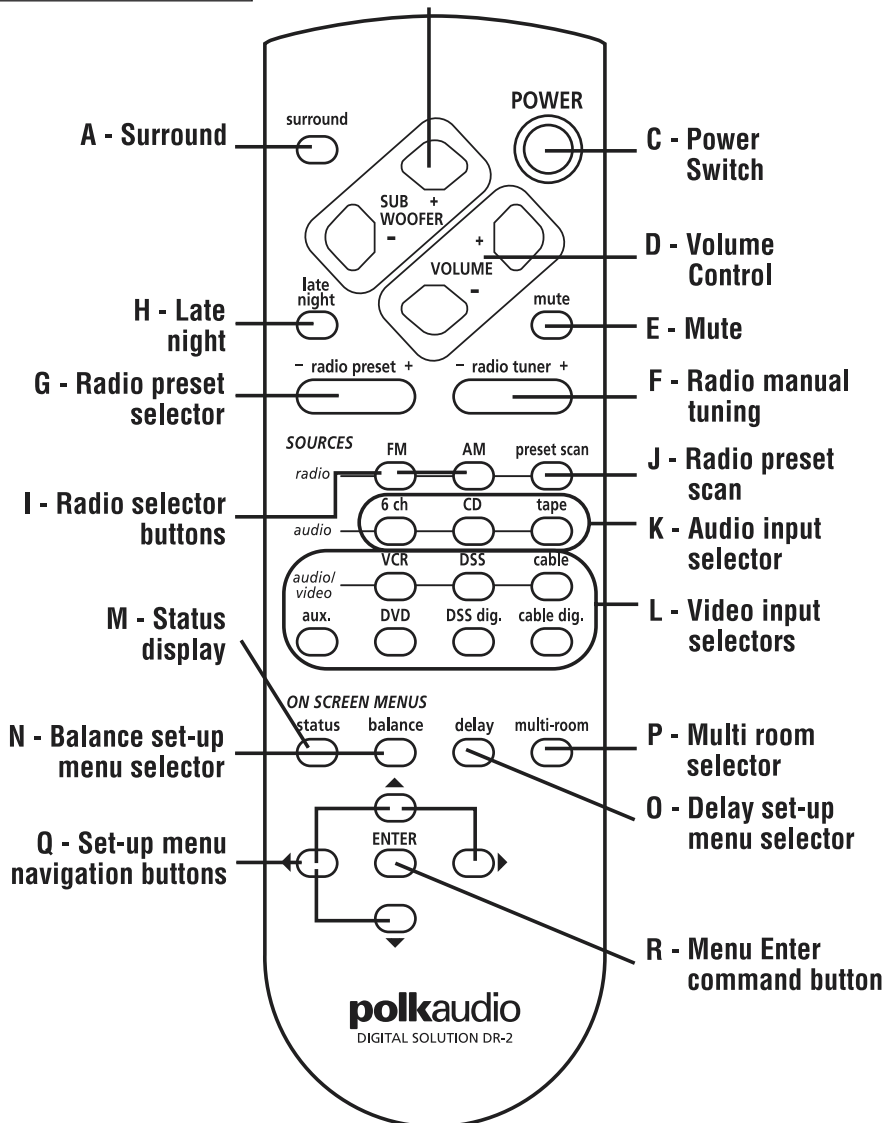

## REMOTE CONTROL GUIDED TOUR

The remote control is divided into three major sections. The top section contains the most often used controls, such as POWER, MUTE, SUBWOOFER volume and system VOLUME controls. The middle section has the source buttons where you select the source component you want to hear and see. The bottom set of buttons are set-up buttons that are rarely used. Most folks will use them once to set up the system and never touch them again. For that matter you could never touch them and you'll still get great sound from your Digital Solution system!

### A—Surround Button

This button switches between surround sound modes and 2 channel stereo (except when the 6 CHANNEL AUDIO input is selected).

### B—Subwoofer +/- Buttons

Push (+) to increase and (-) to decrease the bass volume. The Digital Solution “remembers” the bass level for stereo and surround modes. For example, if you are watching a DVD in the surround mode and you select a bass level of -7, then switch to listening to a CD in stereo and change the bass setting to -10, the system will return to a bass setting of -7 when you go back to the surround mode.

### C—Power Switch

When this switch is pressed once, the power turns ON and display appears on the display panel. When pressed again, the power turns OFF and the standby indicator light on the preamp/processor glows red. Make sure the Power switch on the back of the subwoofer enclosure is set to the “Standby” position. When you turn on the preamp/processor, the amplifier in the subwoofer enclosure will also turn on and you will see a green glow on the base of the subwoofer. When the preamp/processor is turned off the amplifiers turn off and the light in the subwoofer base glows red.

### D—Volume +/- Buttons

Push (+) to increase and (-) to decrease the overall volume of the system.

### E—Mute Button

Push this button to temporarily silence the sound. When mute is on, you will see MUTE ON appear on the preamp/processor display. Pressing the Mute button a second time or pressing either of the Volume buttons will release the Mute, sound will resume and the MUTE OFF light appears.

### F—Radio Tuner +/- Button

When either the AM or FM sources are selected, this button allows you to manually tune in AM and FM radio stations. Pressing the right (+) side of the rocker button moves the tuner up the radio band. Pressing the left (-) side of the rocker button moves the tuner down the radio band. If you hold your finger on the button for a few seconds, the tuner will “fast forward” through the frequencies. The tuner stops as soon as you push the button a second time. See page 22 for more information on using this feature.

### G—Radio Preset +/- Button

This button selects from the list of preset radio stations. Pushing the right (+) side of the rocker button moves from lower preset slot numbers to the higher preset slot numbers. Pushing the left (-) side of the rocker button moves down through the list of preset stations. See page 23 for more information on using this feature.

### H—Late Night Button

This button toggles between Late Night and Normal modes. In the Late Night mode, the dynamic range of the signal is reduced. That means that loud sounds are made less loud. This is a great feature to use anytime you want to watch action/adventure movies and avoid bothering others in the house. This feature only works with Dolby Digital sources. When you push this button, the word “NIGHT ON” appears in the main display window for a few seconds and the small **NIGHT** mode light in the lower right hand corner of the display illuminates. Push the button again and “NIGHT OFF” appears for a few seconds.

### I—FM and AM Buttons

Push the AM button to listen to AM band radio stations or push the FM button to listen to FM radio band radio stations.

### J—Preset Scan Button

Push this button when you want to scan through the radio stations you have preset. The tuner will play each preset station for a few seconds, then move on to the next preset station. The scanning stops as soon as you push the button again. **P-SCAN** will flash in the display window while this mode is in use.

### K—Audio Input Buttons

Push these buttons to listen to either CD, tape or other disc players.

### L—Video/Audio Input Buttons

Push the appropriate button to select an audio/video source. Both audio and video inputs will be selected at the same time.

### M—Status Button

Push this button to display the audio status of the preamp/processor on your TV screen for five (5) seconds. It will display the current source (DVD, FM, etc.), the mode (Dolby Digital, DTS, Pro Logic, 5 Ch Surround Stereo), multi-room status (off or the selected multi-room source), Subwoofer Level and Master Volume level.

### N—Balance Button

Push this button to display the Channel Balance Menu on your TV screen. See “SET UP AND CALIBRATION” on page 20.

### O—Delay Button

Push this button to display the Delay Menu on your TV screen. See “SET UP AND CALIBRATION” on page 20.

### P—Multi-Room Button

Push this button to display the Multi-room Menu on your TV screen. See “USING MULTI-ROOM” on page 25.

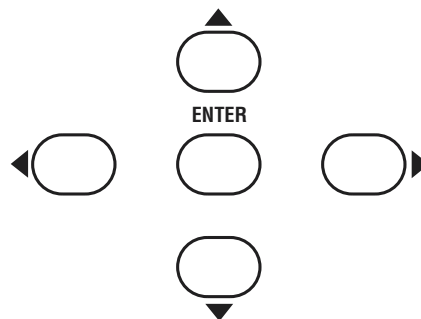

### Q—Cursor Buttons

These buttons allow you to change the position of the ► cursor and make selections on the on-screen menus. The ▲ and ▼ arrow buttons move the cursor through the menu selections and the ◀ and ▶ arrow buttons make selections such as “On” and “Off” and other menu choices.

### R—Enter (Command) Button

Push the ENTER button to exit Channel Balance and Delay menus.

### Attention Owners of Polk DP-1 DVD Player and/or DR-3 Universal Remote

See the owner's manuals supplied with those products for instructions on using those devices with the Digital Solution system.

## SET-UP AND CALIBRATION

After you have connected all speakers and source components you may start using the Digital Solution without any further set-up procedures and get excellent performance in most homes. One of the many benefits of the Polk Digital Solution system is that the electronics and speakers have been perfectly optimized for the highest Dolby Digital and DTS performance without the need for complicated set-up and calibration procedures. There are only two adjustments you may want to perform to optimize the system for your room and speaker placement. Those adjustments are "Channel Balance" and "Delay." The factory presets for these two optional adjustments were selected to provide high quality balanced sound in the vast majority of set-ups. If you are anxious to listen to your new system right now (we understand), skip this section and come back to it later.

### Setting Channel Balance

This procedure sets the relative volume of the 5 satellite speakers so that you hear equal sound from every speaker even if you are sitting closer to one speaker than the others. You may do these adjustments by ear or by using a Sound Pressure Level meter (available at RadioShack). Consult the meter's operating manual for its proper use.

1. Sit in your normal listening position
2. Turn on the TV that is connected to the video output of the Digital Solution Preamp/processor
3. Select a multi-channel source input such as DVD
4. Select Dolby Digital or Dolby Pro Logic processing by pressing the "Surround" button on the remote control or the Preamp/processor front panel.
5. Press the "Balance" button on the remote control. You should see this menu on your TV screen:

```
-CHANNEL BALANCE-
▶FRONT LEFT : 0dB
CENTER      : 0dB
FRONT RIGHT : 0dB
SURROUND R  : 0dB
SURROUND L  : 0dB

TEST TONE   : OFF
DEFAULTS    : ON
EXIT        : SAVE/NO SAVE
```

6. Use the up/down directional buttons on your remote control ▲▼ to move the arrow-shaped cursor ▶ to "TEST TONE"
7. Use the right directional button on the remote control ◀▶ to select "ON" next to test tone.

```
-CHANNEL BALANCE-
FRONT LEFT : 0db
CENTER     : 0db
FRONT RIGHT : 0db
SURROUND R : 0db
SURROUND L : 0db

▶TEST TONE : ON
DEFAULTS   : OFF
EXIT       : SAVE/NO SAVE
```

8. A "whooshing" noise should now be coming from the Front Left speaker.

#### IMPORTANT NOTE:

*If at any time during this procedure the test tone comes from the wrong speaker, you have made a speaker connection mistake. Push the "Balance" button on the remote to cancel this procedure. Re-read the "Speaker Connections" section of this manual on page 13 and correct the wiring error before returning to this procedure.*

9. Adjust the main volume control on the remote or front panel to a typical listening level. If you are using an SPL meter, set the volume to 70dB.

10. Use the ▲▼ directional buttons on the remote to move the arrow shaped cursor to "Center."
11. The whooshing sound should now come from the center speaker.
12. Use the left/right directional arrows on the remote control ◀▶ to raise or lower the volume of the Center speaker to match the volume of the Left Front speaker.
13. Repeat this procedure for all channels until all 5 speakers sound like they are playing at the same volume level. In most cases the range of needed adjustment should not be more than a few dB up or down.
14. Use the up/down directional buttons on the remote ▲▼ to move the arrow shaped cursor to "EXIT."
15. The "SAVE" should be highlighted. If it isn't, use the left directional arrow to highlight "SAVE."
16. Press the Enter button on the remote control to save and exit this menu. The Preamp/processor will now go back to normal operation.
17. If you feel like you have made errors and wish to cancel the adjustments you have just made, highlight "NO SAVE" and exit. The balance settings will return to where they were.
18. To return to the factory preset balance settings, move the cursor to "DEFAULTS", select "ON" and exit.

Once you have completed this procedure you can leave it alone. You may occasionally encounter a movie or recording that was produced in such a way that it doesn't sound channel balanced even though you are certain that your system is properly balanced. Don't sit there and suffer. Push the balance button to go to the Channel Balance menu and make whatever adjustment you feel will make that recording sound good to you. Remember to "Save" the new settings before exiting.

## SETTING CHANNEL DELAY

The time delay circuit ensures that the sounds from all the speakers arrive at your ears properly synchronized. This ensures that the surround sound effects are as natural and enveloping as the recording allows. The Digital Solution is preset to default values that will yield excellent sound quality in all but the most unusual room and speaker set up situations. If you want to be sure that your system is optimized for your set up, use the following procedures.

**IMPORTANT NOTE:** *You cannot set the channel delay function while the 6CH AUDIO input is selected.*

### Setting Dolby Digital and DTS Delay

The DIGITAL SOLUTION is factory preset to default values of Center = 3mS and Surround = 15mS in the Dolby Digital mode. These settings will give excellent performance in the vast majority of homes and set ups. To fine-tune these settings for your room, follow the procedure below.

1. Play a Dolby Digital or DTS source and push the DELAY button on the remote control. This menu will appear on your TV screen:

```
-CHANNEL DELAY-
▶CENTER    : 2mS
SURROUND   : 15mS
DEFAULTS   : ON
EXIT       : SAVE/NO SAVE
```

2. Measure the distance from your main listening position to the center speaker in feet (Fig.1)
3. Measure the distance from your main listening position to the front speakers in feet (Fig.1).
4. Subtract the center distance (B) from the front speaker distance (A). In the example in Figure 1 that would be  $20 - 18 = 2$
5. Use the ▲ up and ▼ down arrow keys on the remote to move the arrow shaped cursor on the menu to CENTER.
6. Use the ◀ left and ▶ right arrow keys to select the correct center delay time. For every 1 foot of difference, select 1 mS of center delay. The range of choices are 0,1,2,3,4 and 5 mS. In this example you would select 2mS.

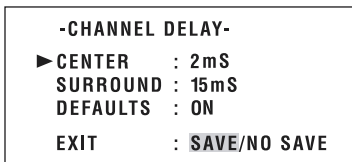

7. Measure the distance from your main listening position to the surround speakers in feet (Fig. 1). Subtract the surround distance ( C ) from the front distance (B). In the example in Fig.1 that would be  $20 - 10 = 10$ .
8. Use the chart to determine the correct surround delay. In this example, 10mS surround delay.

Front Minus Surround Distance (feet)	Dolby Digital Surround Delay Setting	Pro Logic Surround Delay Setting
1 - 3 feet	5ms	15mS
4 - 6 feet	5ms	20mS
7 - 11 feet	10ms	25Ms
12 feet or more	15ms	30mS

9. Use the down arrow key ▼ on the remote to move the arrow shaped cursor on the menu screen to SURROUND
10. Use the ◀ left and ▶ right arrow keys to select the correct surround delay time shown on the chart. In this example, select 10ms. The range of choices are 5, 10 and 15mS.

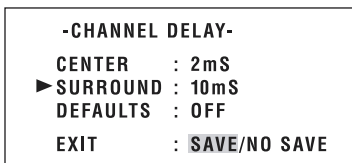

11. Use the down arrow key ▼ on the remote to move the arrow shaped cursor down to EXIT. Make sure SAVE is highlighted.
12. Push the ENTER button on the remote.

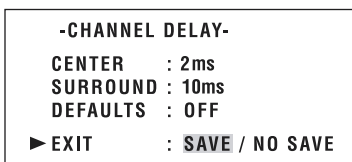

13. If at any time you wish to return to the preset factory defaults, return to this on-screen menu, select DEFAULTS ON, save and exit. The factory settings will be restored.

### Setting Dolby Pro Logic Delay

The channel delay function for Dolby Pro Logic exists for a somewhat different reason than for Dolby Digital. There is a different default surround delay value than that for Dolby Digital. Dolby Pro Logic does not require a center channel delay. The factory preset delay default values are Center = None and Surround = 30mS.

1. Play a Dolby Pro Logic source and press Surround until "Pro Logic" appears in the display window. Push the Delay button on the remote control, this menu will appear on your TV screen:

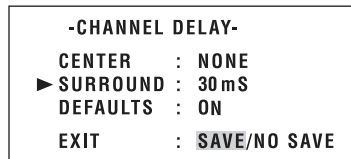

2. Measure the distance from your main listening position to the front speakers in feet (Fig. 1).
3. Measure the distance from your main listening position to the surround speakers in feet (Fig. 1).
4. Subtract the surround distance (C) from the front distance (A). In this example, it is 10.
5. Use the chart to find the proper surround delay time.
6. Use the down arrow key ▼ on the remote to move the arrow shaped cursor on the menu screen to SURROUND
7. Use the ◀ left and ▶ right arrow keys on the remote to select the correct surround delay time shown on the chart. In this example, select 25ms. The range of choices are 15, 20, 25 and 30mS.

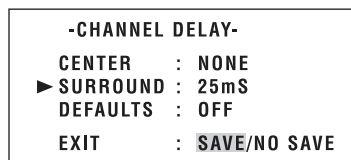

8. Use the down arrow key ▼ on the remote to move the arrow shaped cursor down to EXIT. Make sure SAVE is highlighted.
9. Push the ENTER button on the remote.

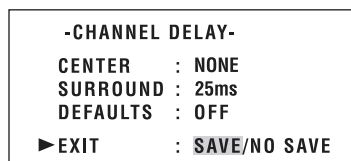

10. If at any time you wish to return to the preset factory defaults, return to this on-screen menu, select DEFAULTS ON, save and exit. The factory settings will be restored.

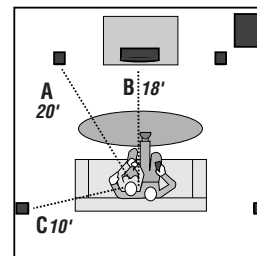

Figure 1

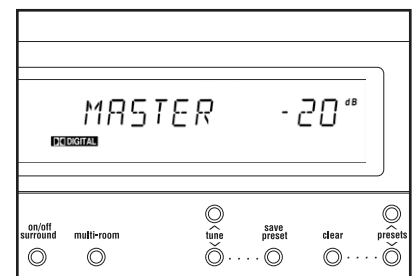
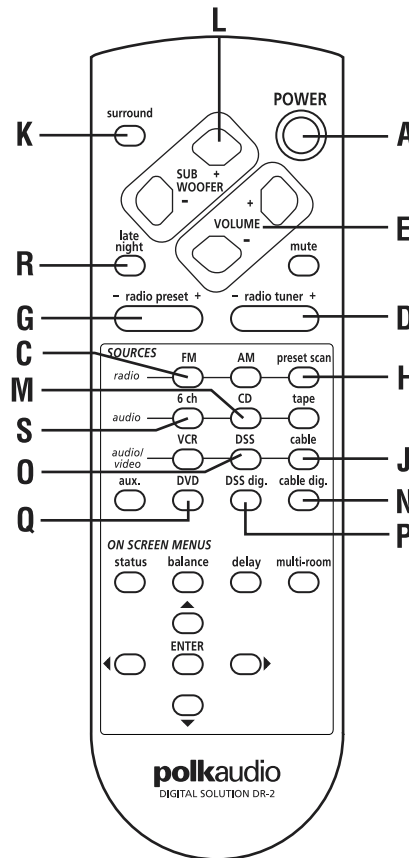
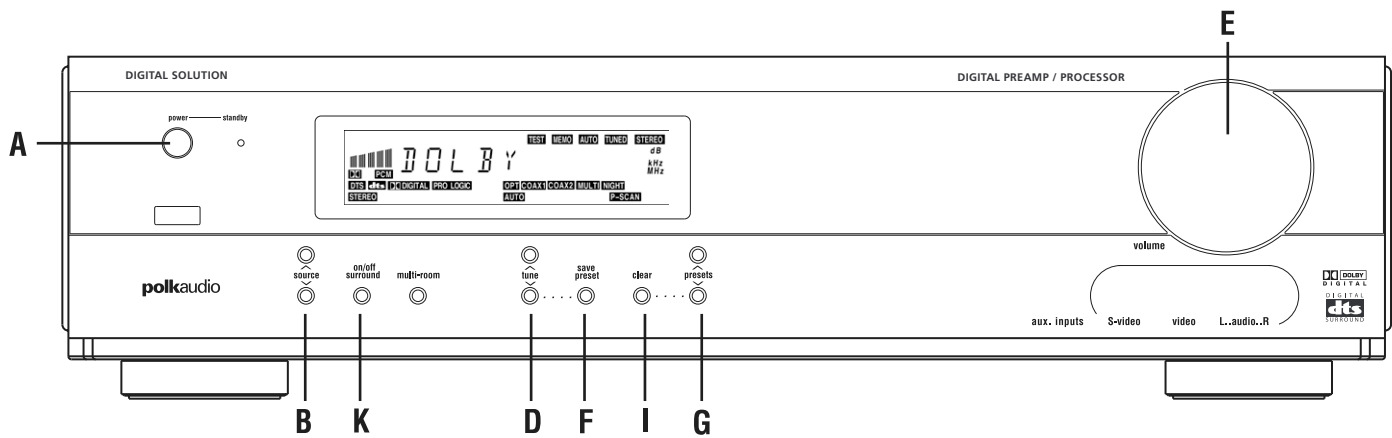

Figure 2

## HOW TO USE YOUR DIGITAL SOLUTION SYSTEM

### Listening to the Radio

1. Press the POWER switch (A) to turn on the power.
2. Press one of the SOURCE buttons (B) on the front panel or the AM or FM buttons on the remote (C) to select either the FM or AM band.
3. Press the TUNE UP and DOWN buttons (D) to tune in the desired station. Pressing once for less than a half-second changes the frequency by one half step. Press and hold the button and the tuner will scan through the radio frequencies very quickly. Release the button and the tuner will stop at the next radio station, at which point the TUNED and signal level indicators light up and the tuning process stops.
4. Adjust the volume with the VOLUME control (E). A volume setting of -20dB will be a comfortable listening level in most rooms (figure 2).
5. If you are listening to a stereo FM broadcast you may want to push the Surround (K) button on the remote until 5CH SURND appears in the

display window. You will now hear surround sound from all the speakers in the system.

### IMPORTANT NOTES ON FM RADIO RECEPTION:

*The supplied FM antenna will only allow the tuner to pick up strong local radio stations. If you want better reception of distant FM stations you will need a better FM antenna. Your Polk Audio dealer can recommend a high quality indoor or outdoor FM antenna. Be sure to get one with a 75-Ohm coaxial output. If you already have a TV roof antenna, you can use it for the FM tuner. Get a signal splitter from a radio/TV dealer or RadioShack store. It will allow you to use the same antenna for TV and FM radio reception.*

*If a radio station you select has a lot of background noise or otherwise sounds distorted, the tuner is not getting a strong enough signal. Look at the Signal Strength indicator in the upper left-hand corner of the display. If there are three bars or fewer lit, that means you need to point the antenna in a different direction. Watch the signal strength meter as you slowly rotate the antenna, noting which direction gives you the strongest reading on the meter. If you still don't get clear reception of the radio station, you either need a better antenna, or the broadcast station is too far away from your home for good reception.*

## Presetting Radio Station

You can preset up to 50 FM/AM stations in any order. Stations can be preset either manually (by you) or automatically (by the tuner).

### Auto Presetting

This function scans the frequencies in the selected band and automatically presets all stations that can be received.

1. Select the FM band (B)
2. Manually tune in the lowest receivable frequency (87.50 MHz) using the TUNE buttons on the front panel (D) or RADIO TUNER on the remote (D).
3. On the front panel press the SAVE PRESETS button (F) and the TUNE ▲ (D) button at the same time. The auto-preset function will start scanning up the dial, looking for receivable stations. **MEMO** will blink on the display.
4. When a receivable station is picked up, the tuner will stop scanning and will play the station for five seconds.
5. Operation stops automatically when all 50 preset memory positions are filled or when auto scanning attains the highest end of all bands.
6. To stop the auto preset function in mid-operation, press any one of the input buttons.

### Manual Presetting

Manually tune-in a desired station. Press the SAVE PRESETS (F) button on the front panel of the Preamp/Processor until the **MEMO** starts blinking in the display. The radio station will automatically be saved to the next available preset slot.

### Recalling a Preset Station

Each press of the ▲ or ▼ PRESETS buttons (G) on either the remote or DIGITAL SOLUTION front panel moves the tuner to the next or previous preset station. You can "fast forward" or "fast reverse" through the preset stations by holding down the ▲ or ▼ PRESETS buttons. The operation continues until the button is released.

### Preset Scan Tuning

1. Press the PRESET SCAN (H) button on the remote control. **P-SCAN** blinks on the display. (The preset station with the smallest preset number is recalled first. If no stations have been preset, CH"00" blinks in the display and the unit returns to the previous mode).
2. Preset stations are recalled in sequence (CH-1, CH-2, etc.) for 5 seconds each. Preset numbers that do not contain stations are skipped.
3. When the desired preset station is received, cancel the preset scan operation by pressing the PRESET SCAN (H) button again. The **P-SCAN** indicator will turn off.

### Clearing Preset Stations

You can remove preset stations from memory using the following procedure.

1. Recall the preset number to be cleared with the method described in "Recalling a Preset Station".
2. Press the CLEAR button (I) for more than 3 seconds. "CLEAR" appears on the display to indicate that the specified preset number has been cleared.
3. If desired you can clear all of the memory contents with a single operation, as follows: Press the SAVE PRESETS button (F), CLEAR button (I) and PRESETS ^ button (G) simultaneously for more than 3 seconds. CAUTION: The all memory clear operation clears all memory including the volume level and surround mode memory and turns the power OFF.

## Playing a DVD-Video (or other audio/video source)

1. Turn unit on by pressing POWER button (A).
2. Push the DVD input button (Q) on the remote or use the SOURCE

▲ ▼ buttons on the front panel (B) to toggle through the sources until the display reads "DVD."

3. Start the DVD player and select the audio track you wish to use. In most cases this will be either the Dolby Digital or DTS 5.1 surround track.
4. Select the desired surround mode by pushing the SURROUND button (K) on either the remote or preamp/processor front panel. The processor will detect whether a DTS or Dolby Digital bitstream is coming from the DVD player and will automatically switch to the appropriate mode.
5. Select the desired volume level with the VOLUME control (E). A volume setting of -20dB will be a comfortable listening level in most rooms (figure 2).
6. Adjust the bass to your liking with the SUBWOOFER control (L) on the remote. Enjoy!

## Playing a Multi-Channel SACD or DVD-Audio Disc

The procedure for playing a SACD or DVD-A disc (as opposed to a DVD-Video movie) is just like any other audio/video source except that you should select the 6 CH button (S) on the remote or use the SOURCE ▲ ▼ arrows (B) to toggle through the sources until the display reads "6CH AUDIO." If you are playing a Dolby Digital or DTS movie DVD (DVD-V format), select the DVD source as described above.

**IMPORTANT NOTE ON THE 6 CHANNEL INPUT AND SURROUND:** When you are listening to a high definition disc that is a 2 channel recording through the 6 CH input, you cannot select a surround mode (like 5 Channel Surround or Pro Logic) and get the benefits of SACD's or DVD-A's higher fidelity. If you really want to hear a 2 channel SACD or DVD-A disc in a surround mode, connect the player's L&R stereo analog outputs into an unused pair of stereo inputs of the DS preamp/processor and use the SURROUND button to select 5CH SURND. In this case you will be trading off basic audio fidelity for surround sound. Hey, we didn't build in crazy copy protection junk that results in all this foolish pain, so don't blame us. Go talk to your Congressman—literally.

## Playing a CD (or other stereo audio source)

1. Turn unit on by pressing POWER button (A).
2. Push the CD input button (M) on the remote or use the SOURCE ▲ ▼ arrows (B) on the front panel to toggle through the sources until the display reads "CD."
3. Select the Stereo, Dolby Pro Logic or 5 Channel Surround mode by pushing the SURROUND ON/OFF button (K) on either the remote or Preamp/processor front panel. Choose whatever mode sounds best to you.
4. Select the desired volume level with the VOLUME control (E). A volume setting of -20dB will be a comfortable listening level in most rooms (figure 2).
5. Adjust the bass to your liking with the SUBWOOFER control (L).
6. Enjoy!

## Playing a DSS Receiver

The procedure for playing a DSS receiver is just like any other audio/video source except that if your DSS receiver has a digital audio output, you must press the DSS DIGITAL button on the remote (P). If your DSS receiver only has analog audio outputs, press the DSS button on the remote (O).

## Late Night Listening

Dolby Digital sources like DVD-Video offer the advantage of greater dynamic range than analog sources. That means that the contrast is greater between the softest sounds and the loudest sounds on the recording. Wide dynamic range is a great benefit - except when you are watching a movie and others in the house are trying to sleep. In such circumstances, just push the LATE NIGHT button (R) on the Digital Solution remote and the dynamic range will be reduced so that you can turn up the volume loud enough to hear the dialog without having the peak sounds get too loud. Once again domestic harmony is restored thanks to Polk.

## ABOUT SURROUND SOUND

The Polk Digital Solution system offers seven modes of operation: Stereo, 5 Channel Surround, Dolby Pro Logic, 2 channel Dolby Digital, Dolby Digital 5.1 surround, DTS 5.1 surround, and pass-through of 5.1 channel high definition formats such as multi-channel Super Audio CD (SACD) and DVD-Audio. Here is a brief description of each mode and how to use it:

**Stereo** – Use this mode when you want to listen to only the front left and right speakers when playing FM stereo radio, CDs and other stereo sources. To select the stereo mode, push the SURROUND button (K) on either the remote or preamp/processor front panel until Stereo appears on the main display followed a few seconds later by the name of the source (such as DVD, CD, etc.). When using a digital source 2/0 will also appear on the display panel.



**5 Channel Surround** – This mode gives you a 5.1 channel surround sound effect from stereo two-channel source such as CD. All speakers in the system will play when this mode is engaged. To select this mode, push the SURROUND button (K) on either the remote or preamp/processor front panel until 5CH SURND appears on the main display followed a few seconds later by [SOURCE NAME]/5CH.

**Dolby Pro Logic** – This is the original surround format that provides 5 channel sound from specially encoded VHS tapes, TV broadcasts and 2 channel-only DVDs. Software sources with the Dolby Surround symbol or Dolby Surround icon will sound best with this mode engaged. To select this mode, push the SURROUND button (K) on either the remote or preamp/processor front panel until PRO LOGIC appears on the main display followed a few seconds later by 2/1.



**Dolby Digital 2.0** - Most DVDs have both 2 channel and 5.1 channel Dolby Digital soundtracks. But some DVDs (usually old movies) only have the 2 channel Dolby Digital soundtrack permitting only stereo or Dolby Pro Logic surround sound. When playing 2.0 DVDs, push the SURROUND button (K) on either the remote or preamp/processor front panel until PRO LOGIC appears on the main display followed a few seconds later by 2/1.

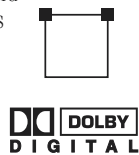

**Dolby Digital 5.1** - . This format is digital and can only be delivered via a digital source such as DVD, the latest generation of Cable or Digital Satellite Systems (DSS). It delivers six channels of information: Left and Right front, Center, Left and Right rear and a Low Frequency Effects channel. In many cases the DVD software default soundtrack is the 2 channel Dolby Digital soundtrack and you have to manually select the 5.1 channel soundtrack via the DVD's menu (see your DVD player's manual for instructions). If the Digital Solution processor receives a Dolby Digital 5.1 signal from a digital source, it will automatically switch to 3/2.1 mode. If it doesn't, push the SURROUND button (K) on either the remote or preamp/processor front panel until Dolby Dig appears on the main display followed a few seconds later by the source name (DVD, DSS etc.) and 3/2.1.

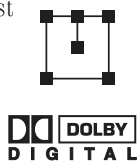

**DTS** - DTS is a similar but competitive 5.1 surround format to Dolby Digital 5.1. DTS is found on a small but increasing number of DVD titles. The Polk Digital Solution supports both Dolby Digital and DTS and will automatically switch between the two. If you do not get sound from all the speakers in the system when playing a DTS 5.1 disc, push the SURROUND button (K) on either the remote or preamp/processor front panel. DTS will appear on the main display, followed a few seconds later by the source name (DVD, DSS etc.) and 3/2.1

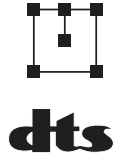

**SACD and DVD-Audio** – These emerging digital technologies deliver better-than-CD quality audio for music listening. You need special players to play SACD or DVD-A discs (both SACD and DVD-A players also play CDs). Some SACD and DVD-Audio music discs are 2 channel stereo but we expect that most will be multi-channel 5.1. The surround processor and digital-to-analog converter is built into the player itself, so the Digital Solution preamp/processor accepts a 5.1 channel SACD or DVD-A audio signal only through the 6 Channel Audio inputs. To play a multi-channel SACD or DVD-A disc, simply select the 6 CHANNEL AUDIO input (S) on the remote control or with the source ▲ ▼ buttons (B) on the preamp/processor. For the best possible fidelity, use this "6 Channel" input even if you know the DVD-A disc to be something other than a 5.1 channel surround mix.

*The Polk Digital Solution is manufactured under license from Dolby Laboratories. "Dolby," "Pro Logic," and the double-D symbol are trademarks of Dolby Laboratories.*

*The Polk Digital Solution is manufactured under license from Digital Theater Systems, Inc. US Pat. No. 5,451,942 and other world-wide patents issued and pending. "DTS" and "DTS Digital Surround" are trademarks of Digital Theater Systems, Inc. ©1996 Digital Theater Systems, Inc. All rights reserved.*



## USING MULTI-ROOM FEATURE

The Multi Room feature allows you to listen to an audio source that is connected to the Digital Solution system in another room of the house. For example, you can watch a movie in the living room while your children listen to the CD player in the family room. In order to use this feature, you will need a pair of powered speakers (such as the Polk Atrium 45p) or another pair of speakers with an integrated amplifier and two RCA type interconnect cables long enough to reach from room to room. Connect the system as shown in the illustration below. Follow the steps below to use the multi-room feature.

### Operating from the remote control:

1. Turn on the TV that is connected to the video output of the Digital Solution Preamp/processor
2. Push the MULTI ROOM button on the remote control. The menu shown below will appear on your TV screen.

```

-MULTI-ROOM SOURCE-
▶MULTI-ROOM : ON
SOURCE      : CD
VOLUME     : 80dB
EXIT       : SAVE/NO SAVE
    
```

3. Push the right arrow on the remote control to select MULTI ROOM:ON

```

-MULTI-ROOM SOURCE-
▶MULTI-ROOM : ON
SOURCE      : CD
VOLUME     : 80dB
EXIT       : SAVE/NO SAVE
    
```

4. Use the down arrow to go to SOURCE: , then toggle through the source choices by pushing the left or right ◀ ▶ arrows

```

-MULTI-ROOM SOURCE-
MULTI-ROOM : ON
▶SOURCE    : FM
VOLUME    : 80dB
EXIT      : SAVE/NO SAVE
    
```

5. Move the cursor down to volume and use the up and down arrows ▲ ▼ to select a volume level.

```

-MULTI-ROOM SOURCE-
MULTI-ROOM : ON
SOURCE     : CD
▶VOLUME   : 20dB
EXIT      : SAVE/NO SAVE
    
```

6. Move the cursor down to the EXIT line. Press the Enter button on the remote control to save and exit this menu. The Preamp/processor will now go back to normal operation.

### Operating from the Front Panel

1. Push the MULTI-ROOM button on the front panel of the preamp/processor
2. The red **MULTI** indicator will blink and the words "SEL SOURCE" will appear on the display.
3. Push either the ▲ or ▼ SOURCE button to select the source you would like to play in the remote room.
4. A few seconds after you select the source, the words "MULTI VOL" will appear in the display window. The red **MULTI** indicator continues to blink.
5. Turn the volume control to -15dB

#### IMPORTANT NOTE:

*For the sake of convenience, the remote room amplifier should have a volume control of its own. The goal of setting the volume on the Multi-Room menu is to supply the remote amp with enough gain (volume) to make the signal audible, but not so much to overload the input. Set the volume control of the remote integrated amplifier to about the 10:00 o'clock position. Raise the DIGITAL SOLUTION Multi Room volume until the sound in the remote room is moderately loud (in the range of -20dB to -5dB). That should give you a comfortable range of volume control on the remote amp.*

6. Wait about another 10 seconds, the **MULTI** light will stop flashing and the DIGITAL SOLUTION will return to normal operation.
7. When you push the MULTI ROOM button again, the Multi Room function turns off and stops sending sound to the remote room.
8. Any time you want sound in the remote room, just push the MULTI-ROOM button and the unit will recall the source and volume level that you selected the last time you used the multi-room function.
9. If you want to change the multi-room source or volume level, just repeat steps 2 through 6 or use the remote control as described above.

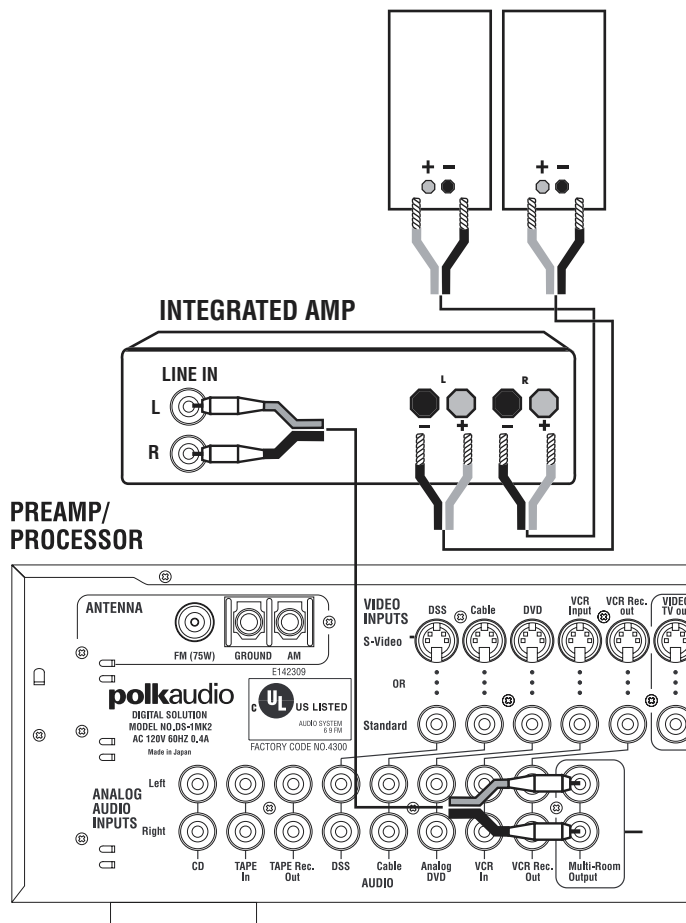

## TROUBLESHOOTING

If something doesn't seem to work right, please use the chart below before calling your dealer or Polk Audio. You will actually save time in the long run if you have already eliminated some of the possible reasons for the problem.

### If this happens:

No sound from any speaker with any source

### Try this:

Make sure the volume isn't turned down all the way. Try setting it to -20dB.

Make sure the subwoofer is plugged in to a live AC outlet and that the power switch on the back of the sub is set to "Standby."

Make sure the 4 meter cable that connects preamp/processor and subwoofer is firmly inserted and screwed in.

Make sure the MUTE light is not lit on the front panel display.

Check the small pilot light on the bottom of the subwoofer enclosure, just above the base. It should be glowing either red or green.

Try playing an FM radio station

Double check all speaker wire connections at the amplifier and the speakers to make sure they are secure.

Disconnect the silent speaker from its speaker wires and replace it with a working speaker from another channel.

Press the Surround button on either the remote control or front panel until either PRO LOGIC, 5CH SURND, DOLBY DIG or DTS appears in the display window. Note: a DVD-Audio disc that is recorded in 2 channel stereo will not play in a surround mode like Pro Logic or 5 Channel Surround while playing through the 6 CH AUDIO inputs. See page 24 for more information.

Check surround channel levels and make sure that they are not set too low. Reset to 0dB or higher (see page 20).

If you are listening to a TV or FM broadcast, it is possible that the broadcast is not in stereo. The surround processor must have at least a stereo signal to derive surround sound.

### Well then:

Still doesn't work?

Still doesn't work?

If the cable is loose, tighten it. Turn the system off and then back on again. Still doesn't work?

Push the MUTE button on the front panel or remote once to turn off the MUTE light and resume sound.

If it isn't glowing at all, disconnect the subwoofer AC cord from the wall socket and remove the fuse that is near the subwoofer's Power switch. If it is blown or if you are in doubt, replace it with an identical fuse. **DO NOT USE ANY VALUE FUSE OTHER THAN THAT INDICATED.** Still doesn't work?

If the radio plays but not any other source, double check all the connections for the other sources, make sure they are on and in the play mode. If the FM radio doesn't play, press the "SAVE PRESET," "CLEAR," and "PRESET UP" buttons all at the same time to preset the preamp processor. If that doesn't work, call your dealer or Polk Audio.

Still doesn't work?

If the "new" speaker doesn't play, the fault is in the either the connection, speaker wire, power amplifier or preamp/processor and NOT the speaker. Call your dealer or Polk Audio. If the "new" speaker does play, the fault lies with the original non-functioning speaker.

Still no surround channels?

Still no surround channels?

Try a source that you know for a fact is stereo or multi-channel. If that doesn't work, call your dealer or Polk Audio.

No sound from one speaker

No sound from the rear surround speakers

## TROUBLESHOOTING

*If something doesn't seem to work right, please use the chart below before calling your dealer or Polk Audio. You will actually save time in the long run if you have already eliminated some of the possible reasons for the problem.*

### If this happens:

The system will not go into Dolby Digital or DTS 5.1 surround sound with a DVD. Pro Logic appears in the display window.

The system will not play a DTS DVD.

Miscellaneous preamp/processor malfunctions

### Try this:

Make sure the DVD player is set up to deliver a 5.1 signal to the Digital Solution system. Check your DVD owner's manual to learn how to access the DVD player's menu. Select the digital output and 5.1 operation. Make sure the DVD player's digital output is connected to the DVD digital input on the Digital Solution.

The default soundtrack on many DVDs is 2 channel stereo. Make sure the DVD itself is set to 5.1. Push the Menu or Title button on the DVD player's remote control to access the menu of the DVD disc. Look in "Languages" or "Audio Set Up" to find and select Dolby Digital 5.1 sound.

Make sure you have made a secure digital connection between the digital output of the DVD player and the Digital DVD input on the Digital Solution preamp.

Some early DVD players are incapable of passing a DTS digital signal. If the DVD has a Dolby Digital 5.1 soundtrack, select that on the DVD's title menu. If the DVD has only a Dolby Digital 2.0 soundtrack, select that and use Dolby Pro Logic surround mode.

Re-set the preamp/processor. Press the "SAVE PRESET," "CLEAR," and "PRESET UP" buttons all at the same time to preset the preamp processor. If that doesn't work, call your dealer or Polk Audio.

### Well then:

Still no 5.1?

Can't find a 5.1 selection on the title menu? Some DVDs (particularly old movies) only have 2 channel soundtracks. Look carefully at the DVD box to see if it specifically says "5.1 Dolby Digital (or DTS) Soundtrack." If not, just enjoy the Pro Logic surround, because that's all there is on that disc. If you are sure it is a 5.1 disc and still no 5.1...

Still no 5.1? Call your Polk dealer or Polk Audio.

If you really want to hear DTS 5.1 soundtracks, get a new DVD player that is compatible with DTS.

## Interference

If this unit is placed very near a television, picture disturbance or noise may occur on the TV. In such a case, move the preamp/processor as far as possible from the television. If the problem persists, re-route the TV antenna cable so that it is as far as possible from the power cable and audio and video connection cables of the Digital Solution system. Since the phenomenon is most likely to occur when using a TV antenna with a 300-ohm feeder wire, we recommend using an outdoor antenna connected via a 75-ohm coaxial cable.

## Safe Limits of Operation

The Digital Solution system was made with the highest quality materials for years of trouble-free performance. However, damage to the system can occur if the system is played at excessive listening levels. When the sound becomes harsh or distorted, you have reached the safe limit of operation. Turn down the volume until the sound is clear and undistorted.

## Protection Circuits

The Digital solution amplifier features several circuits to protect the amplifier and speakers from damage from overheating, shorts, and other electrical faults. If these protection circuits are tripped, all channels will turn off, even if the fault occurs on only one channel. In such cases, turn off the preamp/processor, remove the fault (usually a short on one of the speaker wires where the + and - wires have touched each other) and turn the system back on again. In the case of overheating, allow the system to cool down for about 15 minutes and re-start the system. Overheating is usually a sign that the amplifier (in the subwoofer enclosure) does not have enough air circulation. Move the subwoofer to a less enclosed space.

## Maintaining the Appearance of Your System

The preamp/processor and speaker enclosures may be cleaned with a soft damp cloth or duster. Do not use harsh detergents and cleaning fluids for they can permanently damage the finish. Vacuum the speaker grilles to remove dust.

### Q. "Why does my system hum?" A. "It doesn't know the words."

This is another lame example of what passes for humor in the audio business. Here is the real answer.

In some installations you may hear a humming noise from the subwoofer. Most hum problems are caused by ground loops. That is, the electrical grounds of the components in your system are not at the same electrical potential. To help avoid hum problems, make sure that every component in the audio/video system is plugged in to the same electrical circuit (not necessarily the same outlet). A common ground loop source is cable TV. Disconnect the coaxial cable from your TV and/or VCR. If the hum goes away, the cable TV is the ground loop villain. In that case, you need a 75-ohm ground loop isolator. This device is about the size of a pen and is attached to your coaxial cable where it plugs into your VCR (or television). You can obtain this device from some audio dealers or direct from Polk Audio (800) 377-7655 or on line: <http://polkaudio.tranguard.com>.

Ground loops and hum can also be the result of faulty electrical wiring in your home. Consult a licensed electrician to evaluate and, if necessary, repair the AC wiring in your home. Light dimmers also tend to introduce noise into audio systems. Remove them.

If none of our suggestions work for you, call our customer service number shown below.

## Technical Assistance or Service

If, after following the hookup and use directions and consulting the troubleshooting chart on page 26, you still have trouble, please call our cheerful customer service representatives. They are happy to answer your questions and provide fast, friendly service. In North America call (800) 377-7655, Monday through Friday, 9:00 AM through 6:00 PM Eastern time. Or you can e-mail us at our Internet service address: [polkcs@polkaudio.com](mailto:polkcs@polkaudio.com).

## POLK AUDIO LIMITED WARRANTY

Polk Audio, Inc., warrants to the original purchaser only that the **Preamp/Processor and Amplifier** in this Polk Audio Loudspeaker Product (the "Product") will be free from defects in material and workmanship for a period of three (3) years from the date of original retail purchase from a Polk Audio Authorized Dealer. Polk Audio, Inc., further warrants to the original purchaser only that the **Loudspeaker(s)** in this Polk Audio Product (the "Product") will be free from defects in material and workmanship for a period of five (5) years from the date of original retail purchase from a Polk Audio Authorized Dealer. However, this Warranty will automatically terminate prior to the expiration if you sell or otherwise transfer the Product to any other party. The original retail purchaser shall hereinafter be referred to as "you." To allow Polk Audio to offer the best possible warranty service, please fill out the Product Registration Card(s) and send it to the Factory, at the address provided on the Product Cards(s) within ten (10) days of the date of purchase.

Defective Products must be shipped, together with proof of purchase, prepaid insured to the Polk Audio Authorized Dealer from whom you purchased the Product, or to the Factory at 2550 Britannia Boulevard, Suite D, San Diego, California 92154-7408. Products must be shipped in the original shipping container or its equivalent; in any case the risk of loss or damage in transit is to be borne by you. If upon examination at the Factory or Polk Audio Authorized Dealer it is determined that the unit was defective in materials or workmanship at any time during this Warranty period, Polk Audio or the Polk Audio Authorized Dealer will, at its option, repair or replace with new or reconditioned parts this Product at no additional charge, except as set forth below. All replaced parts and Products become the property of Polk Audio. Products replaced or repaired under this warranty will be returned to you, within a reasonable time, freight prepaid.

This warranty does not include service or parts to repair damage caused by accident, disaster, misuse, abuse, negligence, inadequate packing or shipping procedures, commercial use, voltage inputs in excess of the rated maximum of the unit, cosmetic appearance of cabinetry not directly attributable to defect in materials or workmanship, or service, repair, or modification of the Product which has not been authorized or approved by Polk Audio. This warranty shall terminate if the Serial number on the Product has been removed, tampered with or defaced.

This warranty is in lieu of all other expressed Warranties. If this Product is defective in materials or workmanship as warranted above, your sole remedy shall be repair or replacement as provided above. In no event will Polk Audio, Inc. be liable to you for any incidental or consequential damages arising out of the use or inability to use the Product, even if Polk Audio, Inc. or a Polk Audio Authorized Dealer has been advised of the possibility of such damages, or for any claim by any other party. Some states do not allow the exclusion or limitation of consequential damages, so the above limitation and exclusion may not apply to you.

All implied warranties on this Product are limited to the duration of this expressed Warranty. Some states do not allow limitation on how long an implied Warranty lasts, so the above limitations may not apply to you. This Warranty gives you specific legal rights, and you also may have other rights which vary from state to state.

This Warranty applies only to Products purchased in the United States of America, its possessions, and U.S. and NATO armed forces exchanges and audio clubs. The Warranty terms and conditions applicable to Products purchased in other countries are available from the Polk Audio Authorized Distributors in such countries.

*"Polk Audio," "The Speaker Specialists," and "Power Port"*  
*are trademarks of Britannia Investment Corporation used under license*  
*by Polk Audio Incorporated.*

## Digital Solution 7200 Specifications

### System

*Overall Frequency Response*

28Hz – 23kHz

*-3dB Frequency Response Limits*

32Hz – 20kHz

### Speaker Driver Complement

*Front & Surround Satellites*

Midrange 1 - 3¼" Diameter (8.3cm) Dynamic Balance, polymer composite with rubber surround, shielded

Tweeter 1 - ¾" Diameter (1.91cm) Dynamic Balance, metalized fabric dome, shielded

*Center*

Midrange 2 - 3¼" Diameter (8.3cm) Dynamic Balance, polymer composite with rubber surround, shielded

Tweeter 1 - ¾" Diameter (1.91cm) Dynamic Balance, metalized fabric dome, shielded

*Subwoofer*

Subwoofer 1 - 8" Diameter (20.32cm)

Mineral filled composite with rubber surround, shielded

### Speaker Dimensions

*Front and Surround Satellites*

8" H x 6¾" W x 4" D (20.32cm H x 17.14cm W x 10.16cm D)

*Center*

5⅜" H x 14" W x 4¼" D (13.65cm H x 35.56cm W x 11.91cm D)

*Subwoofer*

16½" H x 13½" W x 15½" D (41.91cm H x 34.29cm W x 39.37cm D)

Footprint Size 13½" W x 15¼" D (34.29cm W x 39.21cm D)

### Six Channel Power Amplifier

*System Continuous Power Output:*  
greater than 360 Watts into 4 Ohms.

*Dynamic Power Output*

500 Watts into 4 Ohms

*Bandwidth*

20Hz – 20kHz

*Total Harmonic Distortion*

0.05%

*Power Requirement*

AC 120V, 50/60Hz

### Preamp/Processor

*FM Tuner Section*

Usable Sensitivity	IHF 1.3 eV/13.5dBf
Signal to noise ratio	Mono/Stereo 76/68dB
Distortion	Mono/Stereo 0.2/0.5%
Stereo Separation	1 kHz 40dB
Alternate Channel Selectivity	± 400kHz 65dB
Image Rejection	98 MHz 50dB

*AM Tuner Section*

Usable Sensitivity:	Loop 500µV
Signal to noise ratio	50dB
Selectivity	± 20kHz 70dB
Image Rejection	98 MHz 50dB

*General*

Power Requirement	AC 120V 60Hz
Power Consumption (AC-3 RF)	26W
Dimensions (Max)	17¼"W x 4½"H x 14"D

# OVERALL HOOK UP

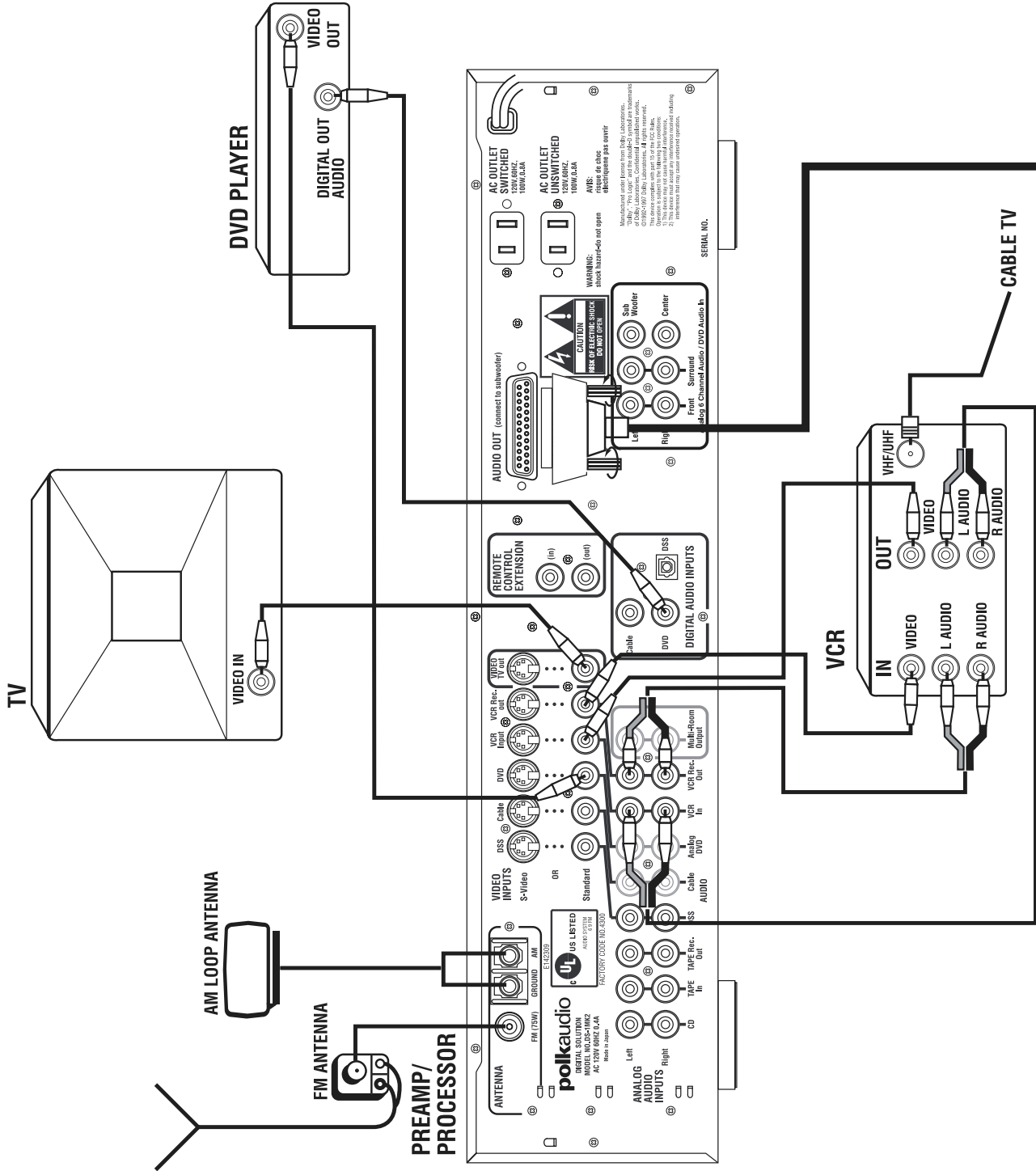



**polkaudio**  
the speaker specialists®

**5601 METRO DRIVE,  
BALTIMORE, MARYLAND 21215, USA,  
410-764-5275, FAX: 410-764-5266  
[www.polkaudio.com](http://www.polkaudio.com)**

**RM0856-1**



## Free Manuals Download Website

<http://myh66.com>

<http://usermanuals.us>

<http://www.somanuals.com>

<http://www.4manuals.cc>

<http://www.manual-lib.com>

<http://www.404manual.com>

<http://www.luxmanual.com>

<http://aubethermostatmanual.com>

Golf course search by state

<http://golfingnear.com>

Email search by domain

<http://emailbydomain.com>

Auto manuals search

<http://auto.somanuals.com>

TV manuals search

<http://tv.somanuals.com>