

polkaudio[®]

the speaker
specialists[®]

SurroundBAR[®] **3000**
Instant Home Theater[®]

ENGLISH



wireless[™] subwoofer



IMPORTANT SAFETY INSTRUCTIONS

This product was designed and manufactured to meet strict quality and safety standards. There are, however, some installation and operation precautions which you should be particularly aware of.

1. Read Instructions. All the safety and operating instructions should be read before the system is operated.
2. Retain Instructions. The safety and operating instructions should be retained for future reference.
3. Heed Warnings. All warnings on the appliances and in the operating instructions should be adhered to.
4. Follow Instructions. All operating and use instructions should be followed.
5. Cleaning. Unplug the appliance from wall outlet before cleaning. Do not use liquid cleaners or aerosol cleaners. Use a damp cloth for cleaning.
6. Attachments. Do not use attachments not recommended by the product manufacturer as they may cause hazards.
7. Water and Moisture. Do not use these appliances near water for example, near a bath tub, washbowl, kitchen sink, or laundry tub, in a wet basement, or near a swimming pool, and the like.
8. Accessories. Do not place these appliances on an unstable cart, stand, tripod, bracket, or table. The audio/video products may fall, causing serious injury to a child or adult, and serious damage to the products. Use only with a cart, stand, tripod, bracket, or table recommended by the manufacturer, or sold with the appliances. Any mounting of the appliances should follow the manufacturer's instructions, and should use mounting accessories recommended by the manufacturer.
9. Ventilation. Slots and openings in the cabinet are provided for ventilation and to ensure reliable operation of the appliances and to protect them from overheating, and these openings must not be blocked or covered. The openings should never be blocked by placing the products on a bed, sofa, rug, or other similar surface. This product should never be placed near or over a radiator or heat register. This product should not be placed in a built-in installation such as a bookcase or rack unless proper ventilation is provided or the manufacturer's instructions have been adhered to.
10. Power Sources. This product should be operated only from the type of power source indicated on the marking labels. If you are not sure of the type of power supply to your home, consult your appliance dealer or local power company.
11. Grounding or Polarization. This product is equipped with polarized alternating-current line plugs (plugs having one blade wider than the other). This plug will fit into the power outlet only one way. This is a safety feature. If you are unable to insert the plug fully into the outlet, try reversing the plug. If the plug should still fail to fit, contact your electrician to replace your obsolete outlet. Do not defeat the safety purpose of the polarized plug.
12. Power Cord Protection. Power-supply cord should be routed so that it is not likely to be walked on or pinched by items placed upon or against it, paying particular attention to cords at plugs, convenience receptacles, and the point where they exit from the appliances.
13. Lightning. For added protection for this audio/video product during a lightning storm, or when it is left unattended and unused for long periods of time, unplug it from the wall outlet and disconnect the antenna or cable system. This will prevent damage to the product due to lightning and power-line surges.
14. Power Lines. An outside antenna system should not be located in the vicinity of overhead power lines or other electric light or power circuits, or where it can fall into such power lines or circuits. When installing an outside antenna system, extreme care should be taken to keep from touching such power lines or circuits as contact with them might be fatal.
15. Overloading. Do not overload wall outlets and extension cords as this can result in a risk of fire or electric shock.
16. Object and Liquid Entry. Never push objects of any kind into this product through openings, as they may touch dangerous voltage points or short out parts that could result in a fire or electric shock. Never spill liquid of any kind on this audio/video product.
17. Servicing. Do not attempt to service this product yourself, as opening or removing covers may expose you to dangerous voltage or other hazards. Refer all servicing to qualified service personnel.
18. Damage Requiring Service. Unplug this product from wall outlets and refer servicing to qualified service personnel under the following conditions:
 - a. When the power supply cord or plug is damaged.
 - b. If liquid has been spilled, or objects have fallen into the product.
 - c. If the product has been exposed to rain or water.
 - d. If the product does not operate normally by following the operating instructions. Adjust only those controls that are covered by the operating

instructions, as an improper adjustment of other controls may result in damage and will often require extensive work by a qualified technician to restore the product to its normal operation.

- e. If the product has been dropped or the cabinet has been damaged.
 - f. When the product exhibits a distinct change in performance this indicates a need for service.
19. Replacement Parts. When replacement parts are required, be sure the service technician has used replacement parts specified by the manufacturer or that the parts have the same characteristics as the original part. Unauthorized substitutions may result in fire, electric shock or other hazards.



CAUTION: Danger of **EXPLOSION** if battery is incorrectly replaced. Replace only with the same or equivalent type. (CR2032)

WARNING: Do not expose batteries or battery pack to excessive heat such as sunshine, fire or the like.

20. Safety Check. Upon completion of any service or repairs to this product, ask the service technician to perform safety checks to determine that the products are in proper operating condition.
21. Carts and Stands. The appliances should be used only with a cart or stand that is recommended by the manufacturer. An appliance and cart combination should be moved with care. Quick stops, excessive force, and uneven surfaces may cause the appliance and cart combination to overturn. Use caution when moving the cart/apparatus combination to avoid injury from tip-over.
22. This product is not intended for use outdoors.



The **CAUTION** marks shown here are located on the back of your SurroundBar® Speaker System



CAUTION: To prevent electric shock, match wide blade of plug to wide slot, insert fully.



CAUTION: No naked flame sources, such as candles, should be placed on the apparatus.

This device complies with RSS-310 of Industry Canada. Operation is subject to the condition that this device does not cause harmful interference.

Class B Emissions Limits

This Class B digital apparatus meets all requirements of the Canadian Interference—Causing Equipment Regulations.

Operation

Operation is subject to the following two conditions:

- 1) This device may not cause interference, and
- 2) This device must accept any interference, including interference that may cause undesired operation of the device.

Product Disposal

Certain international, national and/or local laws and/or regulations may apply regarding the disposal of this product. For further detailed information, please contact the retailer where you purchased this product or the Polk Audio Importer/Distributor in your country. A listing of Polk Audio Importer/Distributors can be found on the Polk Audio website www.polkaudio.com or by contacting Polk Audio at: 5601 Metro Drive, Baltimore, Maryland 21215, USA. Phone: +1-410-358-3600 or 1-800-377-7655.



NOTE:

This equipment has been tested and found to comply with the limits for a Class B digital device, pursuant to part 15 of the FCC Rules. These limits are designed to provide reasonable protection against harmful interference in a residential installation. This equipment generates, uses and can radiate radio frequency energy, and, if not installed and used in accordance with the instructions, may cause harmful interference to radio communications. However, there is no guarantee that interference will not occur in a particular installation. If this equipment does cause harmful interference to radio or television reception, which can be determined by turning the equipment off and on, the user is encouraged to try to correct the interference by one or more of the following measures:

Reorient or relocate the receiving antenna.
Increase the separation between the equipment and receiver.
Connect the equipment into an outlet on a circuit different from that to which the receiver is connected.
Consult the dealer or an experienced radio/TV technician for help.

PLEASE TAKE INVENTORY

Please check to ensure you have everything in your Polk Audio® SurroundBar® 3000 Instant Home Theater® (IHT) carton. Inside, you should find:

- SurroundBar
- Subwoofer
- Subwoofer Power Cord
- 20V Power Supply
- 6' Digital (Optical) Cable
- 1/8" to 1/8" analog cable
- 1/8" to RCA adapter
- Quick Start Guide
- Remote Control Programming Guide
- Online Registration Card

Important Note: If anything is missing or damaged, or if your Polk Audio SurroundBar 3000 IHT fails to operate, please notify your dealer immediately. We recommend keeping your original carton and packing materials in case you need to ship the unit in the future.

ABOUT YOUR SURROUNDBAR 3000 IHT

Thank you for choosing the SurroundBar 3000 IHT from Polk Audio. You're about to discover how the legendary Polk Audio sound makes watching TV and movies so much more exciting. Using a single bar loudspeaker and a wireless subwoofer, the SurroundBar 3000 IHT produces a wide soundstage and rich, full sound. Polk Digital Logic® offers spectacular performance and convenience. And there's even more about the SurroundBar 3000 IHT you'll enjoy:

- No rear speakers, no rear wires.
- Compact design complements today's flat panel TVs.
- Easy to set up. Instant home theater in minutes.
- Upgrades any flat panel TV audio with a bigger, fuller sound.
- A complete home theater experience from a single bar loudspeaker and an unobtrusive wireless subwoofer.
- Wireless subwoofer can be placed anywhere in the room within 50' of the bar.
- 6' optical cable for the absolute easiest hookup from your TV to the bar.
- Built-in wall mount and included bump-on pads ensure a wide range of locating options.
- Provides upgraded audio for today's Blu-Ray discs.

INSIDE YOUR SURROUNDBAR 3000 IHT CARTON:



SurroundBar



Remote Control

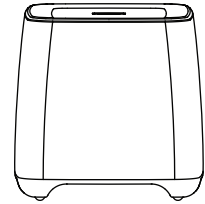

Wireless Subwoofer



6' Digital (Optical) Cable



1/8" to 1/8" Analog Cable

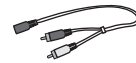

1/8" to RCA Adapter



Subwoofer Power Cord

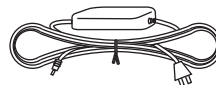

20V Power Supply



Quick Start Guide

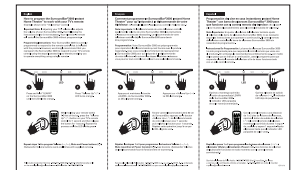

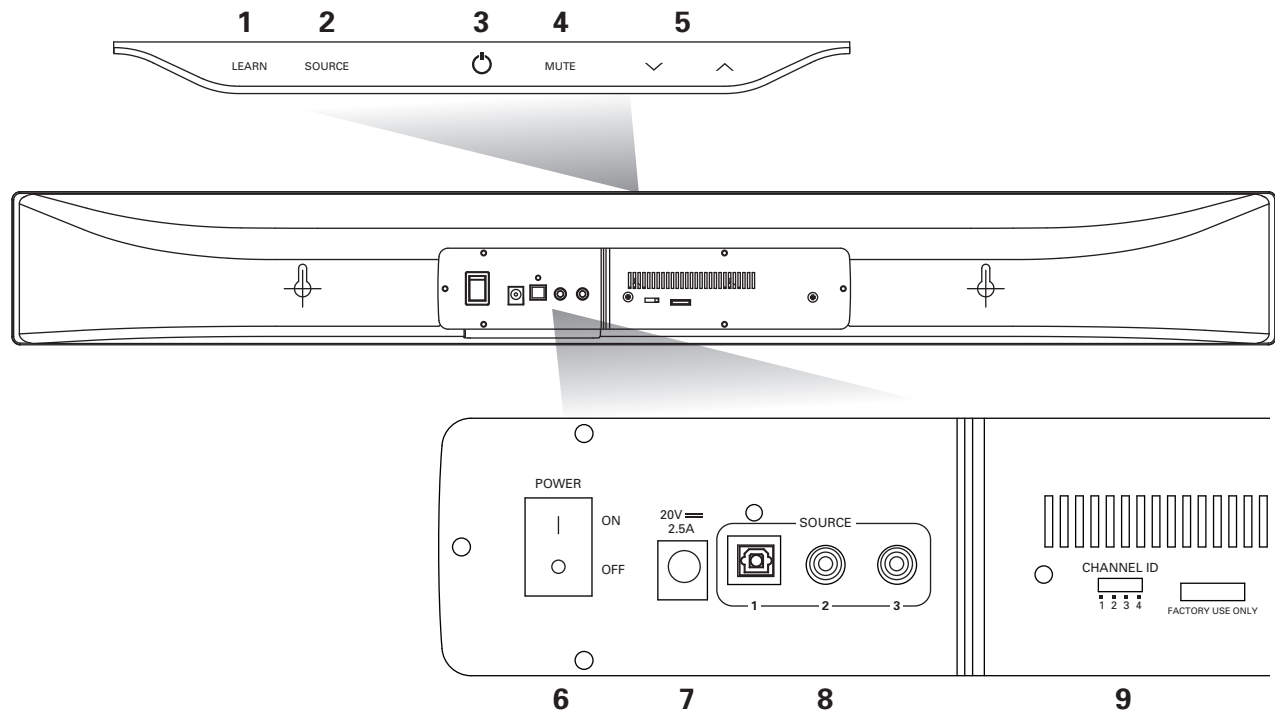

Remote Control Programming Guide



BAR CONTROLS

1. **Learn**—Puts the bar into “learning mode” so you can program it to respond to commands from your remote control.
2. **Source**—Changes which input source you are listening to.
3. **Power** ()—Turns on the bar or puts it in standby mode.

LED—A light that shines green, orange or red to indicate operating status.
4. **Mute**—Mutes the sound coming from the SurroundBar 3000 IHT.
5. **Volume Up and Down** ( / )—Adjusts the volume of the SurroundBar 3000 IHT.
6. **Power Switch**—Turns the bar on or off, but you can leave it on all the time.
7. **Power Connection**—The bar power supply connects here.
8. **Audio Inputs (Source 1, 2 or 3)**—Where you connect your TV (or other source) to the SurroundBar 3000. Use the 6' optical cable (Source 1) provided or analog L/R audio cable (Source 2 & 3) not included.
9. **Channel ID Switch**—Selects the “channel” for the wireless subwoofer signal. **Don't forget to select the same “channel” on the subwoofer.**

NOTE: You'll probably never need to adjust these switches. If you put more than one SurroundBar 3000 IHT system in your home, use different channel ID switch settings so the systems don't interfere with each other.

BAR LED

NORMAL MODE:

- Green Steady**—Power is on; all is well.
- Red Steady**—The bar is in standby mode.
- Green Two Blinks**—A remote control signal is received successfully.
- Green Slow Blinking**—System is muted.
- Green Fast Blinking** (After pressing volume up button)—You have reached the maximum volume.
- Green Fast Blinking** (At power up)—The bar and subwoofer have established a wireless connection.
- Orange Fast Blinking** (At power up)—The bar and subwoofer have failed to establish a wireless connection.

LEARNING MODE: (See page 8 for instructions.)

- Orange Blinking**—The bar is in learning mode.
- Orange Steady**—The bar is in learning mode and a bar button has been selected.
- Green Blinking**—The bar has successfully learned a remote control command.
- Red Blinking**—The bar has failed to learn a remote control command.
- Red and Orange Blinking**—Learned IR codes have been successfully erased.

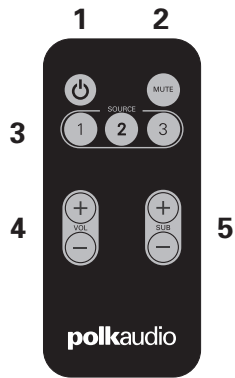

REMOTE CONTROL

1. **Power** (⏻)—Turns on the bar or puts it in standby mode.
2. **Mute**—Mutes the sound coming from the SurroundBar 3000 IHT.
3. **Source 1, 2 or 3**—Changes which input source you are listening to.
4. **Volume Up and Down (+ / -)**—Adjusts the volume of the SurroundBar 3000 IHT.
5. **SUB Volume Up and Down (+ / -)**—Adjusts the volume of the subwoofer.

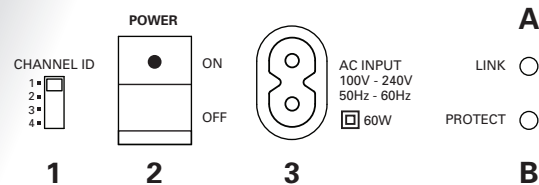
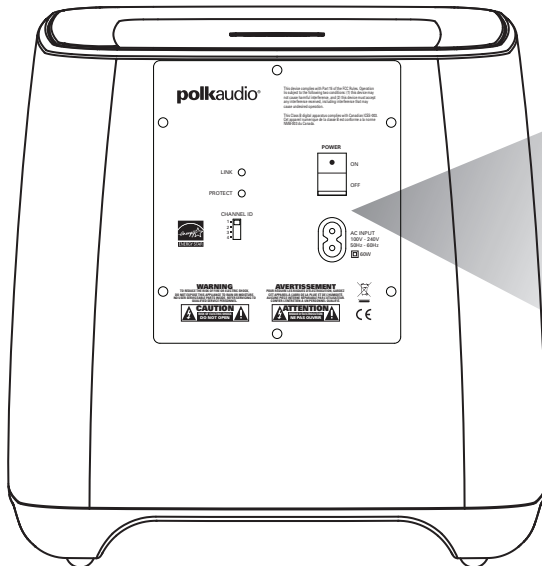

SUBWOOFER CONTROLS

1. **Channel ID Switch**—Selects the “channel” for the wireless subwoofer signal. **Don't forget to select the same “channel” on the bar.**
2. **Power Switch**—Turns the wireless subwoofer on and off, but you can leave it on all the time if you wish.
3. **Power Connection**—The subwoofer power cord connects here.

SUBWOOFER LEDS

- A. **Link**—LED shines green when the subwoofer is active and communicating with the bar.
- B. **Protect**—Shines red when the subwoofer is in protection.

Specifications

System Power	180 Watts
Dimensions	
SurroundBar	3 3/4" H x 31" W x 3" D (9.53cm x 78.74cm x 7.62cm)
Subwoofer	10" H x 10 1/4" W x 10 3/4" D (25.4cm x 26.04cm x 27.31cm)
Weight	
SurroundBar	4.3 lbs (1.95kg)
Subwoofer	7.8 lbs (3.5kg)
Power Rating	
SurroundBar	20 Vdc, 2.5 A
Subwoofer	100V - 240V, 50Hz - 60Hz, 1A
Model	SurroundBar 3000 Instant Home Theater

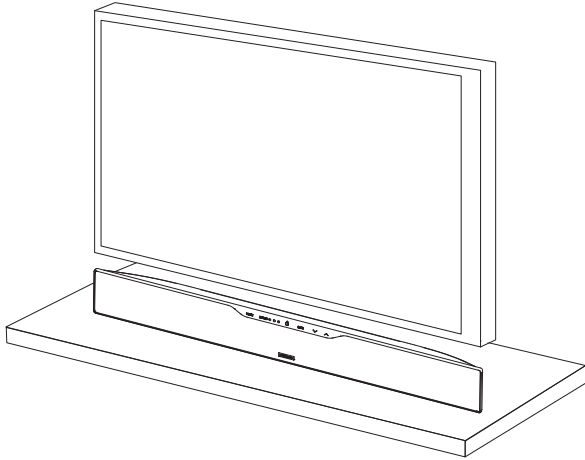

Shelf mounted bar sits in front of TV

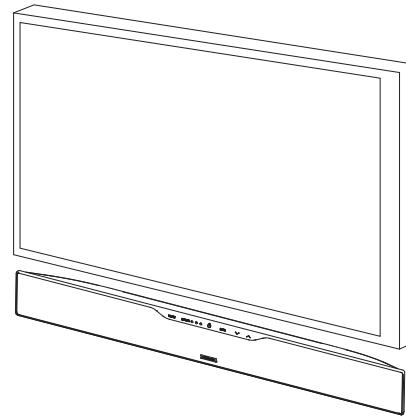

Wall mounted bar

WHERE TO LOCATE YOUR BAR FOR THE BEST SOUND

It's easy. The bar comes with rubber pads already attached, so it will sit securely on any flat surface. Just center the bar under your TV screen. If your TV is housed in a media center, you can place the bar above the TV.

If your TV is wall mounted, the bar can mount right beneath it. The bar has built-in keyhole slots that make it easy.

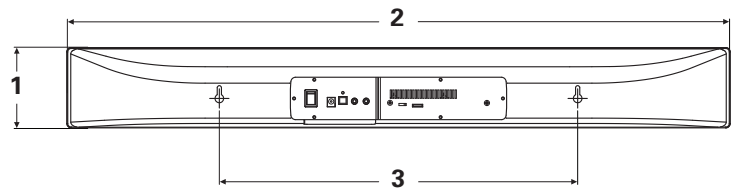

Overall Dimensions

1. 3 3/4" H (9.53cm)
2. 31" W (78.74cm)

Keyhole Slots

3. 16 3/4" W (42.55cm)

WHERE TO LOCATE YOUR SUBWOOFER FOR THE BEST SOUND

Your wireless subwoofer is really easy to place and can go just about anywhere in the room. Plus you don't have to worry about connecting wires, because the only wire you have to plug in is the power cord. And that's it.

Here's a little trick: If you place your subwoofer in a corner of your room, it will reinforce the subwoofer's output, making it sound louder.

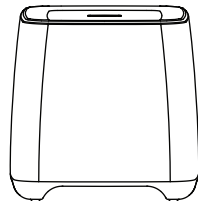

HOW TO CONNECT YOUR BAR

This is really easy, too. You probably have two sources for a signal: your TV or a cable/satellite TV box.

We recommend you use the optical output from your TV so you can enjoy the highest quality audio for TV and DVD's.

In the event that your TV does not have an optical output, you can use the optical output from your cable/satellite box and then connect your DVD player using one of the other SurroundBar 3000 inputs.

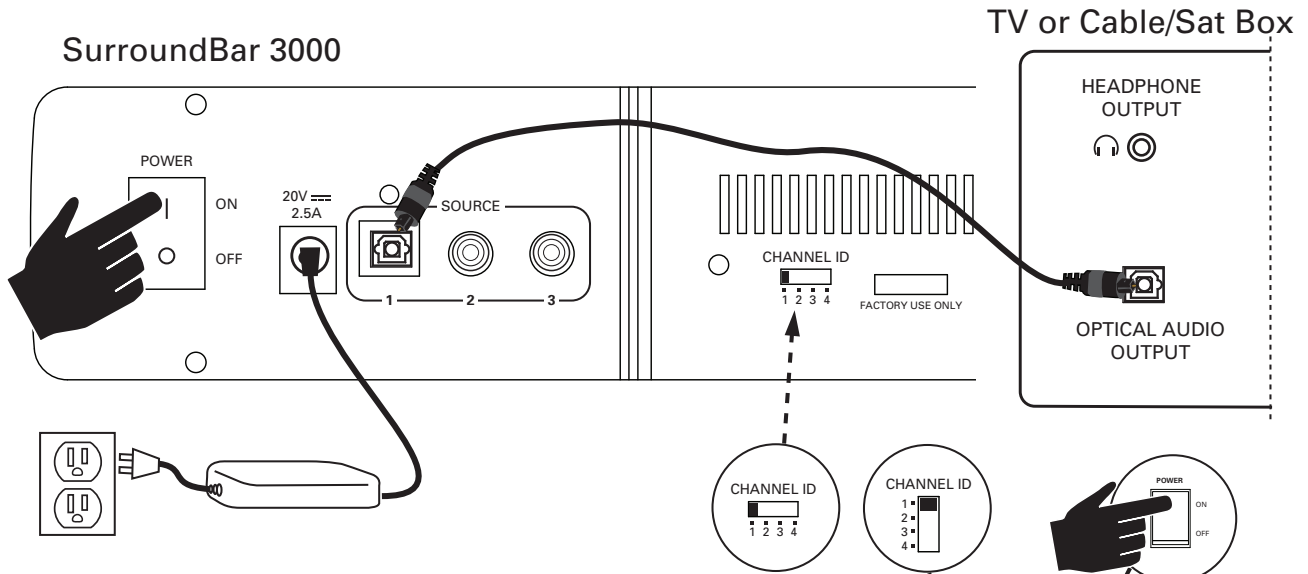

HOW TO CONNECT YOUR SUBWOOFER

Your subwoofer receives a wireless audio signal from the bar, so all you need to do is plug in the power cord. Make sure the sub's Channel ID switch is set to the same number as the bar's Channel ID switch. (Both Channel ID switches should be set to the same number out of the box.)

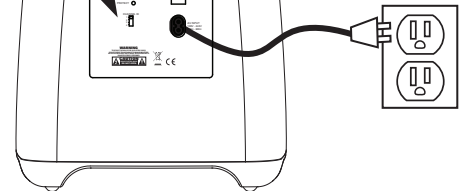

HOW TO OPTIMIZE THE SOUND WHEN TV SPEAKERS ARE ON

You should hear sound from the bar. If you don't, turn up the volume on the bar using its volume control buttons.

If your bar is connected to your TV, there's a very good chance your TV speakers are also playing. It's impossible to give specific instructions on how to turn off the speakers for every TV, but here's a way to do it that covers many of the TVs out there.

1. On your TV remote control, find a "menu" or "setup" button.
2. Press this button. You should see an on-screen menu.
3. Next, look for an option to control audio functions and select it.

The setting to turn off your TV's internal speakers should be here.

If you can't turn off your TV internal speakers, don't worry. Your SurroundBar 3000 IHT will make your TV sound much better. To enjoy the best performance from your bar, you'll want it to play louder than your TV. Use the following steps to adjust the volume balance between your TV and the bar:

1. If necessary, program your bar to respond to the volume up and down control commands of your TV remote. (See "HOW TO SETUP A REMOTE CONTROL FOR YOUR SURROUNDBAR 3000 IHT" on page 9.)
2. Turn your TV volume all the way down using the control buttons on your TV.
3. Then, using the volume control buttons on your bar, set the volume to a normal listening level (do not use the remote control).

After you make these adjustments, your SurroundBar 3000 IHT should always be louder than your TV speakers. Then use the TV remote control to adjust the volume as you normally do.

FINE TUNING YOUR SURROUNDBAR 3000 IHT

The next thing you'll want to do is adjust the subwoofer to blend with your bar. This will ensure the system produces the best sound.

To set the subwoofer's volume, play a variety of source material—some music, a movie sound track with great special effects, a movie chapter or a part of a concert in which people are speaking. Adjust the volume until what you hear sounds natural to you in your normal viewing location.

HOW TO SET UP A REMOTE CONTROL FOR YOUR SURROUNDBAR IHT

SMARTBAR™ PROGRAMMING NOTE:

For your SurroundBar to respond to your remote control, you **MUST FIRST** program the bar to respond to your television's original IR (Infra-Red) remote. **An RF (Radio Frequency) remote will not work.** Other remotes (cable, satellite) will work only **after** you have programmed the bar to respond to the TV's IR remote.

Programming Instructions: Your SurroundBar IHT is currently programmed to respond to the remote control that is included with the product. However, we strongly recommend programming the SurroundBar to also respond to your existing remote control using the steps illustrated below. This will enable you to operate all of your components using a single remote control. **While programming the SurroundBar, ignore anything that may be displayed on the TV screen.**

Example: To teach your bar the "Volume Up" command of your remote control:

1 The SurroundBar is turned on and the LED is solid green. And you have sound coming from the bar.

2 Press and hold "LEARN" for 2 seconds, or until LED blinks orange, then release the "LEARN" button.

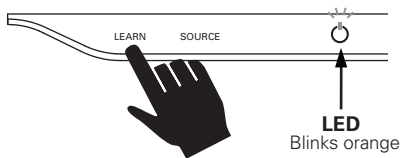

3 Press and release Volume Up "∧" LED turns solid orange.



4 Hold TV remote 1' - 2' from SurroundBar.

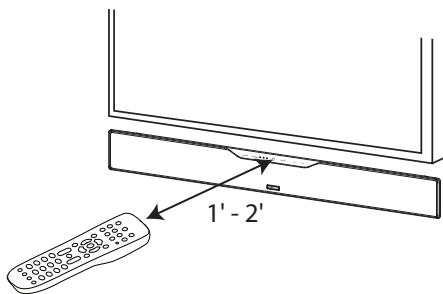

5 Tap "Volume Up" button on your TV's remote control 4 - 8 times, once per second. Tap, do not hold.

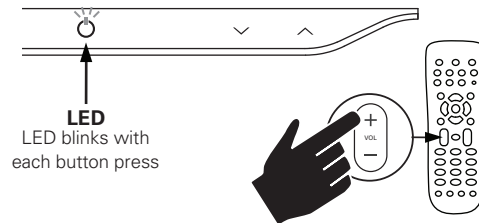

6 When the LED blinks green quickly for 3 seconds, the command has been learned. The LED will become solid green.

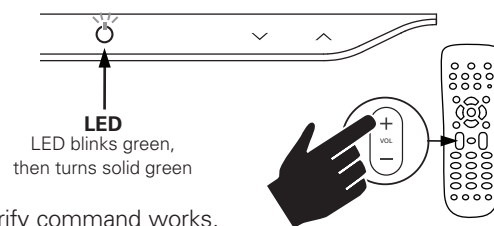

Verify command works.

Repeat steps 1-6 to program "Volume Down" (∨), Source, Mute and Power buttons (⏻).

Note: If your bar fails to learn certain IR remote codes, the power LED will blink red. Try erasing any previously programmed codes (see below) and carefully repeat steps 1-6 above.

Code Erasing Procedure: If you have programmed your SurroundBar IHT to respond to a remote control and you no longer want it to do so, erase the codes by pressing the LEARN key for about two seconds while the unit is in standby mode (power LED is red). You'll know that previously learned codes have been successfully erased when the power LED blinks orange twice.

Note: This procedure removes **ALL** of your bar's remote control programming. If you only need to change the programming for some of the bar buttons, follow the six steps in the sequence previously described to redo any previous programming.

The SurroundBar will continue to respond to the provided credit card remote control.

SUB VOLUME CONTROL ON THE BAR

While unit is on and LED is solid green.

1. Tap **LEARN** once, LED (⏻) turns orange.
2. To adjust sub volume, tap **up** (∧) or **down** (∨).
3. To return to master volume, tap **LEARN** again, LED (⏻) turns green.

NOTE: Bass can also be adjusted with included remote control.

TROUBLESHOOTING

The bar does not power on.

- Ensure you have plugged the power supply into a live wall outlet.
- Ensure that all components of the power supply are connected properly.
- Ensure the power supply is properly connected to the bar power input.
- Ensure the rear panel power switch is in the "on" position.

The subwoofer does not power on.

- Ensure the subwoofer is plugged into a live wall outlet.
- Ensure the rear panel power switch is in the "on" position.

No sound from the bar.

- Check that the TV or cable box is providing a signal.
- Check that the bar is receiving power and is turned on.
- Turn up the volume of the bar.
- Check the input cables to make sure they are connected securely.
- Turn up the volume of your television or cable box.
- Check mute status: Is the bar status light slowly blinking green? If so, press the Mute button on the bar.
- Check that the audio format of the input source is set to PCM 2-channel audio.

No sound from the subwoofer.

- See section "Subwoofer does not power on."
- Turn up the subwoofer volume control using the remote control.
- Is the bar status light blinking orange fast? If so, the bar and subwoofer have failed to establish a wireless connection. Turn off both the bar and subwoofer. Then turn them back on to re-establish communication.
- Ensure the channel ID switches on the bar and subwoofer are set to the same number.

The sound coming from the bar is distorted.

- Check the signal source to ensure the distortion is not coming from there.
- Audio processing (see FAQ's on page 10)—there maybe audio processing occurring prior to reaching the bar. Disable this processing.

Bass output is not loud enough.

- Turn up the subwoofer's volume control using the remote control.
- Place the subwoofer closer to a corner of the room.
- Move subwoofer closer to viewing location within the room.

The bar won't learn my remote control commands.

- Carefully follow the programming instructions on the previous page of this manual.
- Hold the remote steady and 1-2 feet from the front of the bar.
- Quickly "tap" the remote button 4 times.

Note: The bar learns almost all IR commands, but some IR protocols cannot be programmed.

The volume of my television speakers gets louder than my SurroundBar 3000 system over time.

- Turn off your TV speakers per the instructions on page 8 of this manual.
- When the remote control volume button is held down, your television may change volume levels faster than the bar. Use the buttons on the bar to adjust the volume of the bar to the correct balance with the TV speakers.

The subwoofer's output is intermittent, or sounds weak or is distorted.

- Is the bar status indicator blinking orange? If so, the bar and subwoofer have failed to establish a wireless connection. Turn off both the bar and subwoofer. Then turn them back on to re-establish communication.
- Try changing settings of the channel ID switches on both the bar and the subwoofer.
- The wireless subwoofer could be too far away from the bar to receive a sufficiently strong signal. Try moving the subwoofer closer.

FAQ'S (FREQUENTLY ASKED QUESTIONS)

My TV does not have an optical output.

How do I connect my audio?

You have several options for connecting your audio:

- Use the optical output of your source unit (cable/satellite box, DVD player, etc.) and connect directly to the SurroundBar 3000 using the supplied optical cable.
- Use the 1/8" (3.5mm) analog / headphone output of your TV (if available) and connect directly to the SurroundBar 3000 using the supplied 1/8" (3.5mm) to 1/8" (3.5mm) analog cable.
- Use the RCA audio outputs (white/red pair) on your TV (if available) and connect directly to the SurroundBar 3000 using the supplied 1/8" (3.5mm) to 1/8" (3.5mm) analog cable and 1/8" (3.5mm) to RCA adapter.

What if my provided optical cable is too short?

- We did our best to provide a cable of adequate length; however, there might be a few setup instances in which the cable may be too short. If that is your situation, your local electronics store will have cables that meet your required length.

Why am I not hearing any sound from my SurroundBar 3000 when using the provided (optical) cable?

- The SurroundBar 3000 is expecting the audio to be in 2-channel format. You may need to change your TV or cable/satellite box audio settings accordingly.

My audio sounds strange and distorted.

- Your SurroundBar 3000 requires a clean, unaltered stereo signal for proper audio performance. If the sound from your SurroundBar 3000 is strange or distorted, then check the audio menus of whatever source(s) are connected to your SurroundBar 3000 and make sure any audio processing is turned off.

Why can't I successfully program the SurroundBar 3000 to respond to my remote control?

- There are many remote control formats, and we have done our best to make the SurroundBar 3000 compatible with the most popular brands. However, there are likely some cases in which the bar will not be able to learn your remote codes. In this case, please use the remote control provided with the SurroundBar 3000 product or try a different universal remote control.

How do I control the SurroundBar 3000?

There are three ways to control your SurroundBar 3000:

- Use the touch-sensitive buttons on the front of the bar.
- Use the provided remote control.
- Program the SurroundBar 3000 to respond to your existing remote (see included instructions).

My SurroundBar 3000 was responding to commands, but now it isn't. What should I do?

- In this rare event, simply turn off the power (switch located on the back of the bar), wait a few seconds, and then turn the power back on. This should restore control.

How do I erase previously learned remote control commands?

- If you have programmed your SurroundBar 3000 to respond to a remote control and you no longer want it to do so, then you can erase the codes by pressing the LEARN key for about two seconds while the unit is in standby mode (power LED is red). The SurroundBar 3000 will continue to respond to the provided credit card remote control.

Can I adjust the subwoofer level control from the bar keypad if I cannot locate the provided remote control?

- Yes. You can control the subwoofer volume from the bar keypad by tapping the LEARN button prior to using the volume buttons. When you are done with the adjustment tap the LEARN button again.

To contact Customer Service:

- If you have a question or comment, please feel free to call us or email us. In North America and Canada, call Polk Audio Customer Service: 800-377-7655 (M-F 9-5:30 EST) or via email polkcs@polkaudio.com. Outside the US, call 410-358-3600.

A Note Regarding Wireless Performance:

Like all wireless devices, your SurroundBar 3000 IHT may be susceptible to RF interference from such sources as microwave ovens, WiFi computer systems, video game systems, cordless telephones, blue tooth systems, baby monitors and other devices. In particular, any devices operating in the 2.4GHz band may cause intermittent wireless connections between the SurroundBar 3000 speaker and the subwoofer. It is also possible that your SurroundBar 3000 IHT System may affect other wireless systems. For the most part, you can avoid wireless performance problems by physically separating these devices from your SurroundBar 3000 IHT System. Maintaining a distance of several feet or more between your SurroundBar 3000 IHT speaker and any wireless device should prevent any mutual interference effects. If you do notice any subwoofer signal dropouts take care to identify the root cause (most commonly having other wireless devices too close) and resolve accordingly. Any interference effects from a microwave oven will cease once the oven stops operating and may be resolved on a long-term basis by increasing the physical distance between your SurroundBar 3000 IHT System and the microwave oven.

WARNING: LISTEN CAREFULLY

Polk Audio loudspeakers and subwoofers are capable of playing at extremely high volume levels, which could cause serious or permanent hearing damage. Polk Audio, Inc. accepts no liability for hearing loss, bodily injury or property damage resulting from the misuse of its products.

- Keep these guidelines in mind and always use your own good judgment when controlling volume:
 - You should limit prolonged exposure to volumes that exceed 85 decibels(dB). Refer to the Occupational Health and Safety Administration (OSHA) guidelines at: www.osha.gov/dts/osta/otm/noise/standards_more.html.

Polk Audio is a DEI Holdings, Inc. Company. Polk Audio, Polk, The Speaker Specialists, SDA, Polk Digital Logic and SurroundBar are registered trademarks of Polk Audio, Inc.

Products that have earned the Energy Star® are designed to protect the environment through superior energy efficiency.

Manufactured under license from Dolby Laboratories. Dolby and the double-D symbol are registered trademarks of Dolby Laboratories.

LIMITED WARRANTY

Polk Audio, Inc., warrants to the original retail purchaser only. This warranty will terminate automatically prior to its stated expiration if the original retail purchaser sells or transfers the Product to any other party. Polk Audio, Inc., warrants, to the original retail purchaser only, that the LOUD-SPEAKER(S), PASSIVE CROSSOVER COMPONENT(S) and ENCLOSURE on this Polk Audio Loudspeaker Product will be free from defects in material and workmanship for a period of three (3) years from the date of original retail purchase from a Polk Audio Authorized Dealer. Furthermore, Polk Audio, Inc., warrants, to the original retail purchaser only, that any AMPLIFIER OR OTHER ELECTRONIC COMPONENT that may be included in this Polk Audio Loudspeaker Product will be free from defects in material and workmanship for a period of one (1) year from the date of original retail purchase from a Polk Audio Authorized Dealer. To allow Polk Audio to offer the best possible warranty service, please fill out the Product Registration Card(s) and send it to the Factory at the address provided on the Product Registration Card(s) within ten (10) days of the date of original purchase. Defective Products must be shipped, together with proof of purchase, prepaid insured to the Polk Audio Authorized Dealer from whom you purchased the Product, or to the Factory at 1 Viper Way, Vista, California 92081. Products must be shipped in the original shipping container or its equivalent; in any case the risk of loss or damage in transit is to be borne by you.

If upon examination at the Factory or Polk Audio Authorized Dealer it is determined that the unit was defective in materials or workmanship at any time during this Warranty period, Polk Audio or the Polk Audio Authorized Dealer will, at its option, repair or replace this Product at no additional charge, except as set forth below. All replaced parts and Products become the property of Polk Audio. Products replaced or repaired under this warranty will be returned to you, within a reasonable time, freight prepaid. This warranty does not include service or parts to repair damage caused by accident, disaster, misuse, abuse, negligence, inadequate packing or shipping procedures, commercial use, voltage inputs in excess of the rated maximum of the unit, cosmetic appearance of cabinetry not directly attributable to defect in materials or workmanship, or service, repair, or modification of the Product which has not been authorized or approved by Polk Audio. This warranty shall terminate if the serial number on the Product has been removed, tampered with or defaced.

This warranty is in lieu of all other expressed Warranties. If this Product is defective in materials or workmanship as warranted above, your sole remedy shall be repair or replacement as provided above. In no event will Polk Audio, Inc. be liable to you for any incidental or consequential damages arising out of the use or inability to use the Product, even if Polk Audio, Inc., or a Polk Audio Authorized Dealer, has been advised of the possibility of such damages, or for any claim by any other party. Some states do not allow the exclusion or limitation of consequential damages, so the above limitation and exclusion may not apply to you. All implied warranties on this Product are limited to the duration of this expressed Warranty. Some states do not allow limitation on how long an implied Warranty lasts, so the above limitations may not apply to you. This Warranty gives you specific legal rights, and you also may have other rights which vary from state to state.

This Warranty applies only to Products purchased in Canada, the United States of America, its possessions, and U.S. and NATO armed forces exchanges and audio clubs. The Warranty terms and conditions applicable to Products purchased in other countries are available from the Polk Audio Authorized Distributors in such countries.

CUSTOMER SERVICE

Thank you for your Polk Audio purchase. If you have a question or comment, please feel free to call us or email us. In North America and Canada, call Polk Audio Customer Service 800-377-7655 (M-F, 9-5:30 EST) or via email polkcs@polkaudio.com. Outside the US, call 410-358-3600.

GARANTIE LIMITÉE

La garantie de Polk Audio, Inc., n'est valide que pour l'acheteur au détail original. La garantie sera automatiquement annulée avant sa date d'expiration spécifiée si l'acheteur original vend ou transfère le produit à tout autre parti. Polk Audio, Inc., garantit—à l'acheteur au détail original seulement— que le ou les HAUT-PARLEUR(S), COMPOSANTE(S) DE FILTRE PASSIF et CAISSON(S) de ce produit Polk Audio seront exempts de tout défaut attribuable aux pièces d'origine et à la main d'oeuvre pour une période de Trois (3) ans à partir de la date de l'achat au détail original chez un revendeur agréé Polk Audio. En outre, Polk Audio, Inc., garantit—à l'acheteur au détail original seulement— que TOUT AMPLIFICATEUR OU TOUT AUTRE COMPOSANTE ÉLECTRONIQUE qui pourrait faire partie ce produit Polk Audio sera exempt de tout défaut attribuable aux pièces d'origine et à la main d'oeuvre pour une période de un (1) ans à partir de la date de l'achat au détail original chez un revendeur agréé Polk Audio. Pour permettre à Polk Audio de vous offrir le meilleur service de garantie possible, veuillez enregistrer votre nouveau produit en ligne à l'adresse web: www.polkaudio.com/registration ou contactez le Service à la Clientèle de Polk au 800-377-7655 aux États-Unis et au Canada (à l'extérieur des U. : 410-358-3600) dans les dix (10) jours suivant la date de l'achat original. Assurez-vous de conserver votre reçu d'achat original. Les produits défectueux doivent être expédiés, avec une preuve d'achat, francs de port et d'impôt assurés, au revendeur agréé Polk Audio de qui vous avez acheté le produit, ou à l'usine Polk Audio, à l'adresse: 1 Viper Way, Vista, California 92081. Les produits doivent être expédiés dans leur carton d'expédition original ou dans un contenant équivalent. En tout cas le propriétaire doit assumer tout risque de perte ou de dommage en transit.

Si, suite à l'examen du produit à l'usine Polk ou chez le marchand agréé Polk Audio, il est déterminé que la défectuosité est imputable aux matériaux d'origine ou à la main d'oeuvre au cours de la période de la garantie spécifiée, Polk Audio ou le revendeur Polk Audio, à sa guise, réparera ou remplacera le produit sans frais additionnels et selon les conditions décrites ci-dessous. Toute pièce ou produit remplacé devient la propriété de Polk Audio. Les produits réparés ou remplacés sous la garantie vous seront expédiés francs de port dans un délai raisonnable. Cette garantie n'inclut pas le service ou les pièces nécessaires à la réparation des dommages provoqués par accident, désastre, abus, négligence, mode d'expédition ou emballage inadéquat, utilisation commerciale, tensions supérieures au maximum prescrit pour l'unité, aspect visuel du meuble non directement attribuable à un défaut de pièces d'origine ou de main d'oeuvre, ou par le service, la réparation, ou toute modification du produit qui n'a pas été autorisé ou approuvé par Polk Audio.

Cette garantie sera annulée si le numéro de série sur le produit a été enlevé, altéré ou falsifié. Cette garantie prend préséance sur toutes autres garanties énoncées. Si la défectuosité de ce produit est imputable aux pièces d'origine ou à la main d'oeuvre selon les conditions de la garantie exprimées ci-dessus, votre seul recours sera la réparation ou le remplacement selon les conditions décrites ci-dessus. Dans aucun cas Polk Audio, Inc. pourra-t-elle être tenue responsable pour tout dommage accessoire ou indirect causé par l'utilisation ou par l'incapacité d'utilisation du produit, même si Polk Audio, Inc. ou un revendeur agréé Polk Audio, a été avisé de la possibilité de tel dommage, ou pour toute réclamation par tout autre parti. Certains états ne permettant pas l'exclusion ou la limitation des dommages indirects, les limitations et exclusions exprimées ci-dessus pourraient ne pas s'appliquer dans votre cas. Toutes les garanties tacites sur ce produit sont limitées à la durée de la garantie énoncée. Certains états ne permettant pas la limitation de la durée d'une garantie tacite, les limitations ci-dessus pourraient ne pas s'appliquer dans votre cas. Cette garantie vous accorde des droits légaux spécifiques; vous pourriez également avoir d'autres droits qui pourraient varier d'état en état.

Cette garantie s'applique seulement aux produits achetés au Canada, aux États-Unis d'Amérique et ses possessions, et dans les clubs audio et d'échange des forces armées des É.U. et de l'OTAN. Les modalités et les conditions de garantie applicables aux produits achetés dans d'autres pays sont disponibles chez les distributeurs agréés Polk Audio établis dans ces pays.

SERVICE À LA CLIENTÈLE

Polk Audio ou contactez le Service à la Clientèle de Polk Audio au 1-800-377-7655 (L-V, 9-17:30, HNE, Canada et É.-U. seulement). À l'extérieur des É.-U. et du Canada, composez le 410-358-3600. Vous pouvez aussi nous contacter par courriel à l'adresse: polkcs@polkaudio.com.

polkaudio® the speaker specialists®

5601 Metro Drive
Baltimore, MD 21215



HBP1925B

Free Manuals Download Website

<http://myh66.com>

<http://usermanuals.us>

<http://www.somanuals.com>

<http://www.4manuals.cc>

<http://www.manual-lib.com>

<http://www.404manual.com>

<http://www.luxmanual.com>

<http://aubethermostatmanual.com>

Golf course search by state

<http://golfingnear.com>

Email search by domain

<http://emailbydomain.com>

Auto manuals search

<http://auto.somanuals.com>

TV manuals search

<http://tv.somanuals.com>