

ENG

**Prestigio P400MW / P460MW**  
Colour Television  
Owner's Manual

Please read this manual carefully before operating your set. Retain it for future reference.

See the label attached on the back cover and quote this information to your dealer when you require service.

PRESTIGIO P400MW / P460MW

1

## Contents

<b>Installation</b> .....	<b>3</b>	<b>Sound adjustment</b> .....	<b>22</b>
<b>Remote control handset</b> .....	<b>4</b>	SSM (Sound Status Memory) .....	22
Controls .....	4	Balance .....	23
Battery installation .....	5	AVL (Auto Volume Leveler) .....	23
<b>Controls of Front panel</b> .....	<b>6</b>	SRS .....	24
<b>Connections of Back panel</b> .....	<b>7</b>	TV Speaker .....	24
<b>Connection to External equipment</b> .....	<b>8</b>	Stereo/Dual/NICAM reception .....	25
1 Connect to Aerial socket .....	8	<b>Time Menu</b> .....	<b>26</b>
2 Watching VCR .....	8	Clock .....	26
3 Watching Cable TV .....	9	On/Off Time .....	26
4 Watching external AV source .....	9	Auto sleep .....	27
5 Watching DVD .....	10	Sleep timer .....	27
6 Connecting HDMI (DTV) .....	10	<b>Setup Menu</b> .....	<b>28</b>
7 Connecting PC (DTV) .....	11	Front Light .....	28
8 Connecting Digital Audio .....	11	Child Lock .....	28
<b>Basic operation</b> .....	<b>12</b>	<b>Connection of PC</b> .....	<b>29</b>
1 On and Off .....	12	PC Setup .....	29
2 Programme selection .....	12	WXGA (or VGA (Only RGB mode)) .....	29
3 Volume adjustment .....	12	<b>PIP (Picture-in-Picture) Feature</b> .....	<b>30</b>
4 On screen language selection .....	12	Watching PIP .....	30
<b>On screen menus</b> .....	<b>13</b>	PIP Audio Output .....	30
Menu selection .....	13	Moving the PIP .....	30
<b>Setting up TV stations</b> .....	<b>14</b>	Swapping the PIP .....	31
Auto programme tuning .....	14	Selecting a Input Signal Source for the PIP .....	32
Manual programme tuning .....	15	Programme selection for sub picture .....	32
Programme edit .....	17	Programme scan .....	32
Calling the programme table .....	18	<b>Teletext (option)</b> .....	<b>33</b>
<b>Picture adjustment</b> .....	<b>19</b>	<b>External Control Device Setup</b> .....	<b>35</b>
CSM (Colour Status Memory) .....	19	<b>Displayable Monitor</b> .....	<b>43</b>
PSM (Picture Status Memory) .....	20	Specification .....	43
Manual Picture Control .....	20	<b>Troubleshooting</b> .....	<b>44</b>
Picture format .....	21	Check list .....	44

## Installation

### Power

This set operates on an AC mains supply, the voltage is as indicated on the label on the back cover. Never apply DC power to the set. In the event of thunderstorms or power-cuts, please pull out the aerial and mains plugs.

ENG

### Warning

To prevent fire or shock hazard, do not expose the set to rain or moisture. Do not rub or strike the Active Matrix LCD with anything hard as this may scratch, mar, or damage the Active Matrix LCD permanently.

### Service

Never remove the back cover of the set as this can expose you to very high voltage and other hazards. If the set does not operate properly, unplug it and call your dealer.

### Aerial

Connect the aerial cable to the socket marked +75 .on the back cover. For the best reception an outdoor aerial should be used.

### Location

Position your set so that no bright light or sunlight falls directly onto the screen. Care should be taken not to expose the set to any unnecessary vibration, moisture, dust or heat. Also ensure that the set is placed in a position to allow a free flow of air. Do not cover the ventilation openings on the back cover.

### Cleaning

Unplug the set before cleaning the face of the LCD Screen. Dust the set by wiping the screen and the cabinet with a soft, clean cloth. If the screen requires additional cleaning, use a clean, damp cloth. Do not use liquid cleaners or aerosol cleaners.



## Remote control handset

### Controls

ENG

Before you use the remote control handset, please install the batteries.

-All the functions can be controlled with the remote control handset.

-Some functions can also be adjusted with the buttons on the front panel of the set.

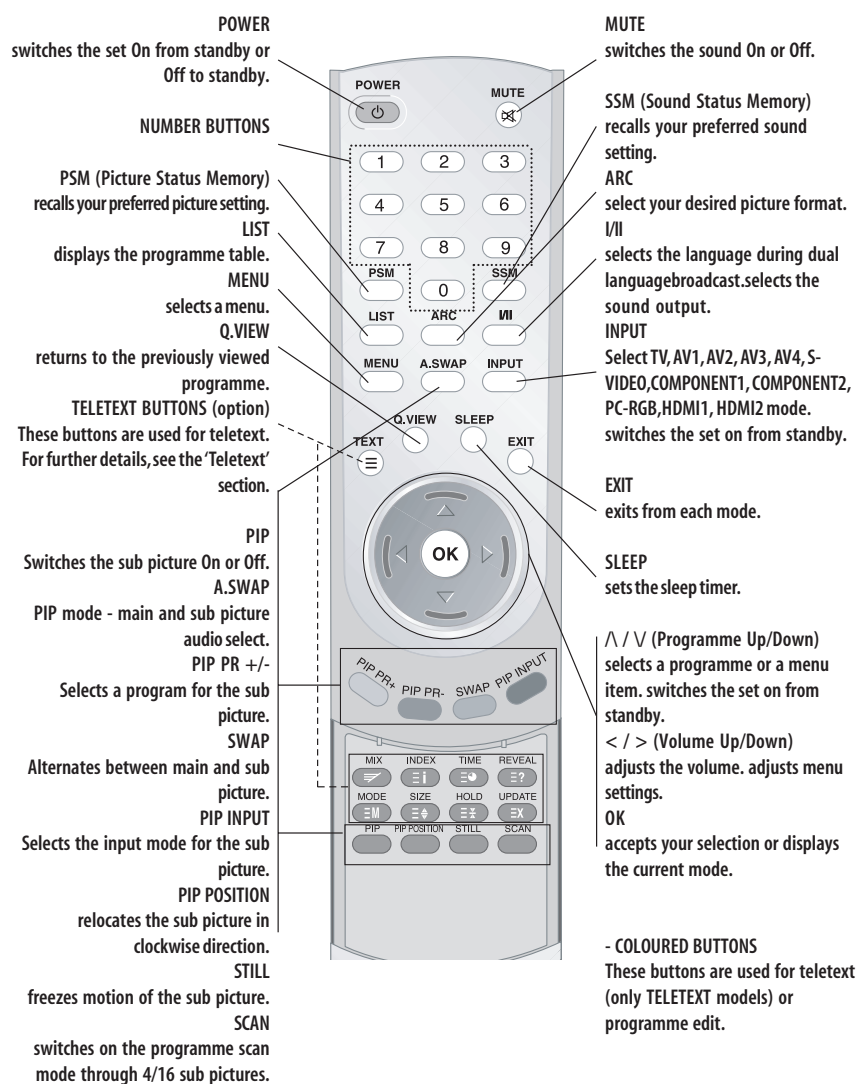

## Battery installation

-Your remote control handset is powered by two AAA type batteries.

- 1 To insert batteries, turn the remote control handset over and remove the battery cover.
- 2 Put the two batteries into the compartment observing battery polarity.
- 3 Replace the cover.

ENG

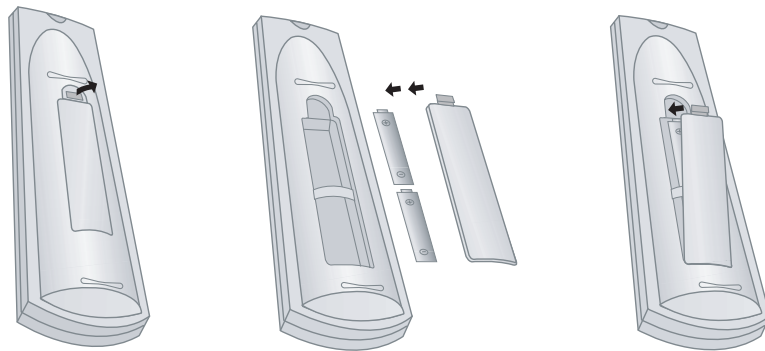

To avoid damage from possible battery leakage, remove the batteries if you do not plan to use the remote control handset for an extended period time. Do not use batteries of differing age or type. Always discard batteries safely.

## Controls of Front panel

- Shown is a simplified representation of the set.
- Here shown may be somewhat different from your set.
- This manual explains the features available on the P400MW / P460MW series.

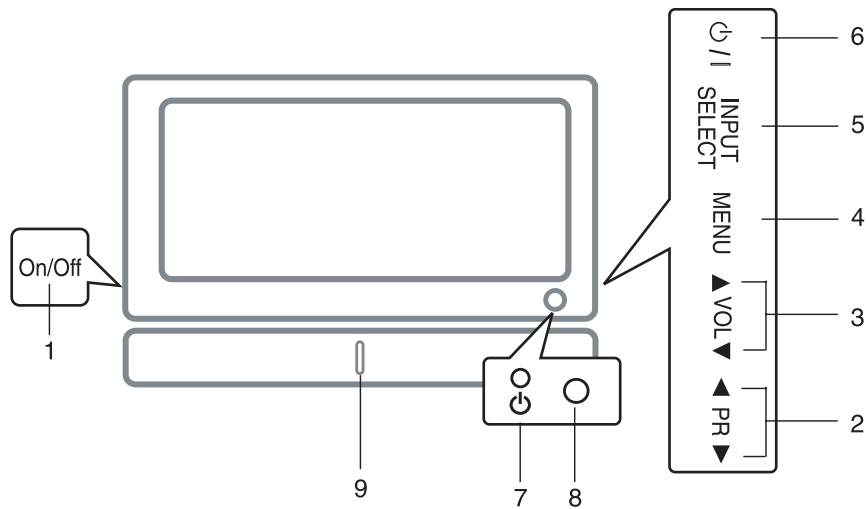

**1. MAIN POWER**  
switches the set On or Off.

**2.  $\wedge/\vee$  (Programme Up/Down)**  
selects a programme or a menu item.  
switches the set On from standby.

**3.  $</>$  (Volume Down/Up)**  
adjusts the volume.  
adjusts menu settings.

**4. MENU**  
selects a menu.

**5. INPUT SELECT**  
selects TV, AV1, AV2, AV3, AV4, S-VIDEO, COMPONENT1, COMPONENT2, PC-RGB, HDMI1, HDMI2 mode.

**6. POWER**  
switches the set On from standby or On to standby.

**7. POWER/STANDBY INDICATOR**  
illuminates red in standby mode.  
illuminates green when the set is switched On.

**8. REMOTE CONTROL SENSOR**

**9. Front Light LED**

## Connections of Back panel

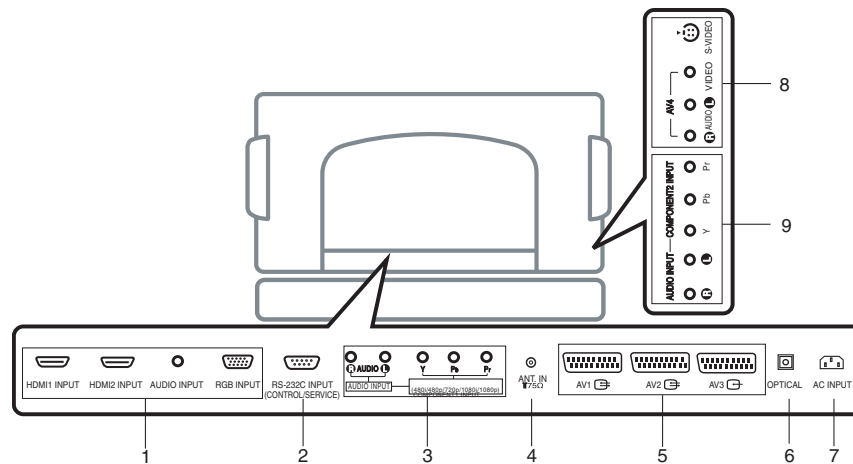

ENG

### 1. HDMI1 INPUT / HDMI2 INPUT / AUDIO INPUT / RGB INPUT SOCKETS

Connect the set output socket of the PERSONAL COMPUTER to this socket.

### 2. RS-232C INPUT (CONTROL/SERVICE) PORT

Connect to the RS-232C port on a PC.

### 3. AUDIO INPUT / COMPONENT1 INPUT (480i / 480p / 720p / 1080i / 1080p) SOCKETS

### 4. AERIAL SOCKET

### 5. EURO SCART SOCKET

connect the euro scart socket of the VCR to these sockets.

### 6. Digital Audio (OPTICAL)

Connect digital audio from various types of equipment.

**Note :** In standby mode, these ports will not work.

### 7. POWER CORD SOCKET

This set operates on an AC power. The voltage is indicated on the Specifications page. Never attempt to operate the set on DC power.

### 8. AUDIO / VIDEO INPUT (AV4, S-VIDEO)

Connect video out from an S-VIDEO VCR to the SVIDEO input.  
Connect the audio/video out sockets of the VCR to AV sockets of the set.

### 9. AUDIO INPUT / COMPONENT2 INPUT (480i / 480p / 720p / 1080i / 1080p) SOCKETS

## Connection to External equipment

-You can connect additional equipment, such as VCRs, camcorders etc. to your set. However please check with your manufacturers instruction books for specific information. Make sure all connections are made with both your set and additional appliance unplugged from the mains to avoid damaging your equipment. Here shown may be somewhat different from your set.

### 1 Connect to Aerial socket

Connect the RF out socket of the VCR to the aerial socket on the back of the set.

Connect the aerial cable to the RF aerial in socket of the VCR.  
Store the VCR channel on a desired programme number using the 'Manual programme tuning' section.  
Select the programme number where the VCR channel is stored.  
Press the PLAY button on the VCR.

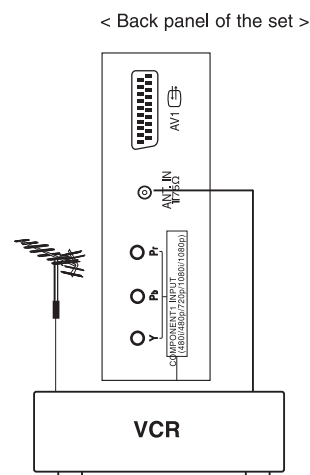

### 2 Watching VCR

- If you connect an S-VIDEO VCR to the S-VIDEO input, the picture quality is improved; compared to connecting a regular VCR to the Video input.

- To avoid picture noise (interference), leave an adequate distance between the VCR and set.

Use the INPUT SELECT button on the remote control to select AV1, AV2, AV3, AV4 or S-VIDEO.

(If connected to S-VIDEO, select the S-VIDEO external input source.)

Insert a video tape into the VCR and press the PLAY button on the VCR. (See VCR owner's manual)

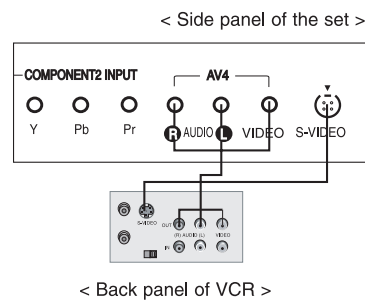



### 3 Watching Cable TV

- After subscribing for a local cable TV station and installing a converter you can watch cable TV.
- For further information of cable TV, contact the local cable TV station.

#### In using connection 1

Select programme number in programme switch of cable box.

Match the set programme with selected programme of cable box.

Select your desired programme with the remote control for cable box.

#### In using connection 2

Use the INPUT SELECT button on the remote control and select AV1, AV2, AV3, AV4 or S-VIDEO.

Tune to cable service provided channels using the cable box.

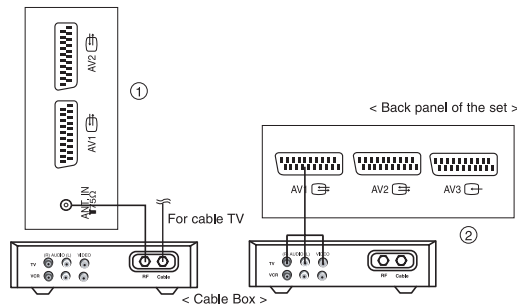

ENG

### 4 Watching external AV source

When connecting the set to an external source, match the colours of AUDIO/VIDEO input jacks on the set with the output jacks on the audio/video equipment: Video = yellow, Audio (Left) = white, Audio (Right) = red.

Use the INPUT SELECT button on the remote control to select AV1, AV2, AV3, AV4 or S-VIDEO.

Operate the corresponding external equipment. See external equipment operating guide.

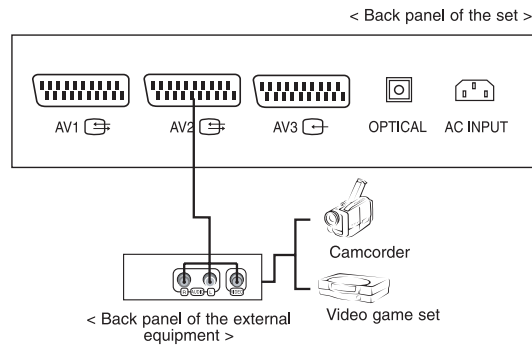

ENG

## 5 Watching DVD

### How to connect

Connect DVD video inputs to Y, PB, PR of COMPONENT (DVD INPUT) and audio inputs to Audio sockets of AUDIO INPUT.

### How to use

Turn on the DVD player, and insert a DVD.

Use INPUT SELECT button on the remote control to select COMPONENT1, COMPONENT2. Refer to the DVD play-er's manual for operating instructions.

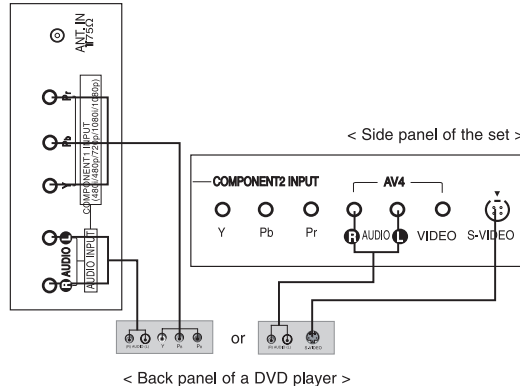

### • COMPONENT Input ports

You can get better picture quality if you connect DVD player with COMPONENT input ports as below.

COMPONENT ports of the set	Y	P <sub>B</sub>	P <sub>R</sub>
Video output ports of DVD player	Y	P <sub>b</sub>	P <sub>r</sub>
	Y	B-Y	R-Y
	Y	C <sub>b</sub>	C <sub>r</sub>
	Y	P <sub>B</sub>	P <sub>R</sub>

## 6 Connecting HDMI (DTV)

Connect the signal cable from the monitor output socket of the PERSONAL COMPUTER to the HDMI INPUT socket of the set.

Connect the audio cable from the PC to the AUDIO INPUT sockets of the set.

Press the INPUT SELECT button to select HDMI1, HDMI2.

Switch on the HDMI, and the HDMI screen appears on the set.

HDMI-DTV input signal : 480p-60Hz, 576p-50Hz, 720p-50Hz, 720p-60Hz, 1080i-50Hz, 1080i-60Hz, 1080p-50Hz, 1080p-60Hz.

HDMI Interface with HDCP Copy Protection enables all digital rendering of video without the losses.

This TV SET can receive the High-Definition Multimedia Interface(HDMI) or Input of Digital Visual Interface(DVI).

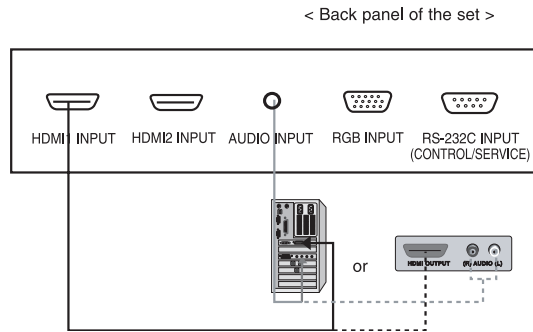

## 7 Connecting PC (DTV)

Connect the signal cable from the monitor output socket of the PERSONAL COMPUTER to the RGB INPUT socket of the set.

Connect the audio cable from the PC to the AUDIO INPUT sockets of the set.

Press the INPUT SELECT button to select PC-RGB.

Switch on the PC, and the PC screen appears on the set.

The set can be operated as the PC monitor.

RGB-DTV input signal : 480p-60Hz, 576p-50Hz, 720p-50Hz, 720p-60Hz, 1080i-50Hz, 1080i-60Hz, 1080p-50Hz, 1080p-60Hz.

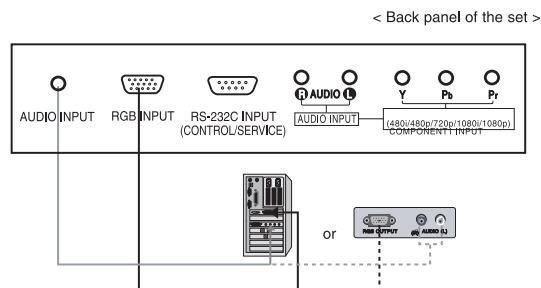

## 8 Connecting Digital Audio

-Send the set's audio to external audio equipment (stereo system) via the Digital Audio Output (Optical)

Caution : Do not look into the optical output port. Looking at the laser beam may damage your vision.

### How to connect

Connect one end of an optical cable to the TV Digital Audio (Optical) Output port.

Connect the other end of the optical cable to the digital audio (optical) input on the audio equipment.

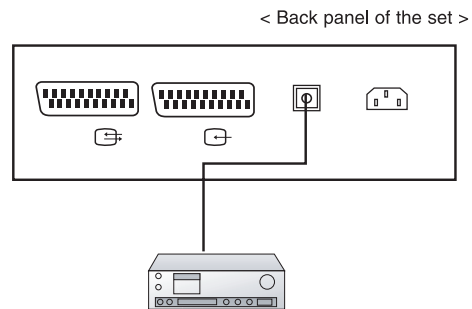

Note : Digital Audio Output works, when it's inputted HDMI signal to the set.

## Basic operation

### 1 On and Off

ENG

Press the main power button to switch the set on.

If the set is in standby mode, press the POWER,  $\wedge$ / $\vee$  buttons on the remote control handset to switch it on fully.

Press the POWER button on the remote control handset.

The set reverts to standby mode.

Press the main power button again to switch the set off.

### 2 Programme selection

You can select a programme number with the  $\wedge$ / $\vee$  or NUMBER buttons.

### 3 Volume adjustment

Press the  $</>$  button to adjust the volume.

If you want to switch the sound off, press the MUTE button. You can cancel it by pressing the MUTE,  $</>$ , SSM or I/II button.

### 4 On screen language selection

Press the MENU button and then use  $\wedge$ / $\vee$  button to select the SETUP menu.

Press the  $>$  button and then use  $\wedge$ / $\vee$  button to select Language.

Press the  $>$  button and then use  $\wedge$ / $\vee$  button to select your desired language. All the on screen displays will appear in the selected language.

Repeatedly press the MENU button to return to normal TV viewing.

## On screen menus

### Menu selection

-The dialogue between you and your set takes place on screen with an operator menu. The buttons required for the operating steps are also displayed.

ENG

- 1**  
Press the MENU button and then use  $\wedge$ / $\vee$  button to display each menu.
- 2**  
Press the  $>$  button and then use  $\wedge$ / $\vee$  button to select a menu item.
- 3**  
Press the  $>$  button to display the sub menu or the pull-down menu.
- 4**  
Change the setting of an item in the sub or pull-down menu with  $</>$  or  $\wedge$ / $\vee$ .  
You can move to the higher level menu with  $<$  button and to move to the lower level menu press the  $>$  button.

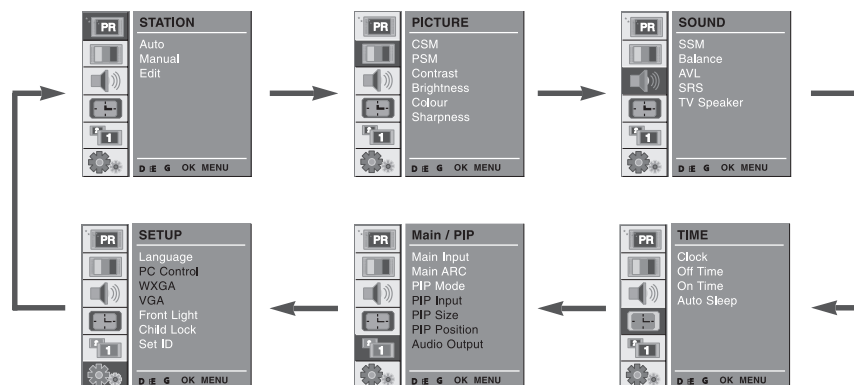

## Setting up TV stations

### Auto programme tuning

ENG

-Up to 100 TV stations can be stored by programme numbers (0 to 99). Once you have preset the stations, you will be able to use the  $\wedge$ / $\vee$  or NUMBER buttons to scan the stations you programmed. Stations can be tuned using automatic or manual modes.

-All stations that can be received are stored by this method. It is recommended that you use auto programme during installation of this set.

1

Press the MENU button and then use  $\wedge$ / $\vee$  button to select the STATION menu.

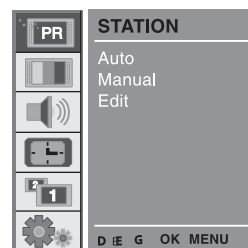

2

Press the > button and then use  $\wedge$ / $\vee$  button to select Auto.

Press the > button to display the Auto menu.

Press the > button. Select a TV system with the  $\langle$ / $\rangle$  button on the System pull-down menu;

L : SECAM L/L' (France)

BG : PAL B/G, SECAM B/G (Europe/  
East Europe)

I : PAL I (U.K./Ireland)

DK : PAL D/K, SECAM D/K (East Europe)

Press the  $\wedge$ / $\vee$  button to select Storage From.

Select the beginning programme number with the  $\langle$ / $\rangle$  button on the Storage From pull-down menu.

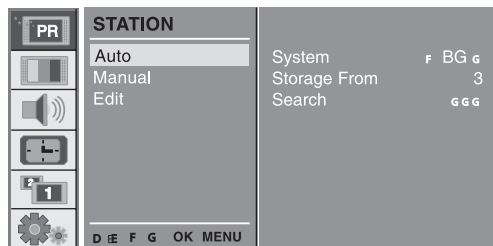

3

Press the  $\wedge$ / $\vee$  button to select Search.

Press the > button to begin auto programming. All receivable stations are stored. The station name is stored for stations which broadcast VPS (Video Programme Service), PDC (Programme Delivery Control) or TELE-TEXT data. If no station name can be assigned to a station, the channel number is assigned and stored as C (V/UHF 01-69) or S (Cable 01-47), followed by a number.

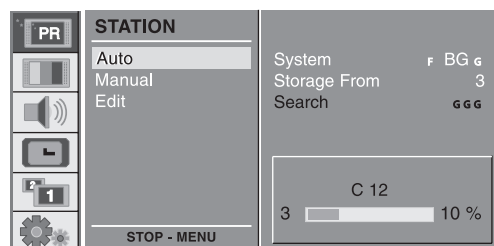

To stop auto programming, press the MENU button. When auto programming is completed, the Edit menu appears on the screen. See the 'Programme edit' section to edit the stored pro-gramme. Repeatedly press the MENU button to return to normal TV viewing.

## Manual programme tuning

-Manual programme lets you manually tune and arrange the stations in whatever order you desire. Also you can assign a station name with five characters to each programme number.

### 1

Press the MENU button and then use D / E button to select the STATION menu.



### 2

Press the > button and then use ^ / v button to select Manual.

Press the G button to display the Manual menu.  
Press the ^ / v button to select Storage.  
Press the < / > button to select the programme number.

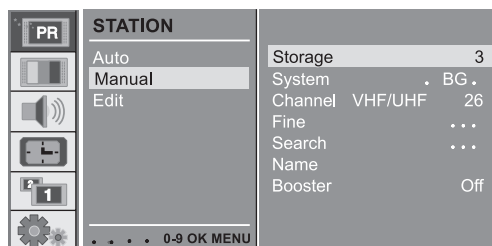

### 3

Press the ^ / v button to select System.  
Select a TV system with the < / > button on the System pull-down menu;

- L : SECAM L/L' (France)
- BG : PAL B/G, SECAM B/G (Europe/East Europe)
- I : PAL I (U.K./Ireland)
- DK : PAL D/K, SECAM D/K (East Europe)

Press the ^ / v button to select Channel.  
Press the < / > button to select V/UHF or Cable on the Channel pull-down menu.

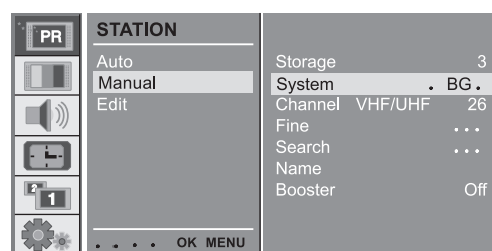

ENG

#### 4

Normally fine tuning is only necessary if reception is poor.

Press the  $\wedge/\vee$  button to select Fine.

Press the  $</>$  button to fine tune for the best picture and sound.

Press the  $\wedge/\vee$  button to select Search.

Press the  $</>$  button to commence searching on the Search pull-down menu. If a station is found the search will stop.

If this station is the one required, press the OK button to store it.

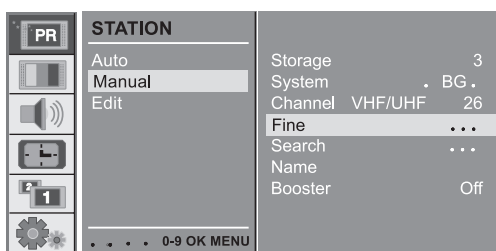

#### 5

Press the  $\wedge/\vee$  button to select Name.

Press the  $>$  button on the Name pull-down menu.

Press the  $\wedge$  button. You can use a blank, +, -, the numeric 0 to 9 and the alphabet A to Z.

With the  $\vee$  button you can select in the opposite direction.

Select the position by pressing the  $</>$  button and then take your choice of the second character, and so on.

Press the OK button.

In some models, Booster is an optional function. Only a set with Booster can perform this function.

If the reception is poor at the fringe area of TV signal, select Booster to On.

Press the  $\wedge/\vee$  button to select Booster.

Press the  $</>$  button to select On or Off.

Repeatedly press the MENU button to return to normal TV viewing.

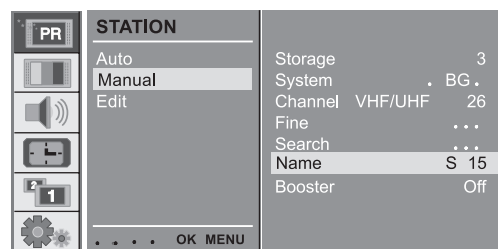



## Programme edit

-This function enables you to delete or skip the stored programmes. Also you can move some stations to other pro-gramme numbers or insert a blank station data into the selected programme number.

### 1

Press the MENU button and then use  $\wedge/\vee$  button to select the STATION menu.

Press the  $>$  button and then use  $\wedge/\vee$  button to select Edit.

Press the  $>$  button to display the Edit menu.



### 2 Deleting a programme

Select a programme to be deleted with the  $\wedge/\vee$  or  $</>$  button.

Press the RED button twice.

The selected programme is deleted, all the following programmes are shifted up one position.

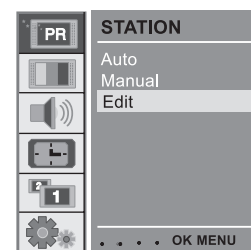

### 3 Copying a programme

Select a programme to be copied with the  $\wedge/\vee$  or  $</>$  button.

Press the GREEN button. All the following programmes are shifted down one position.

### 4 Moving a programme

Select a programme to be moved with the  $\wedge/\vee$  or  $</>$  button.

Press the YELLOW button.

Move the programme to the desired programme number with the  $\wedge/\vee$  or  $</>$  button.

Press the YELLOW button again to release this function.

0	C	04	5	----
1	S	03	6	----
2	S	04	7	----
3	C	06	8	----
4	C	33	9	----

● Delete	● Copy
● Move	● Skip

### 5 Skipping a programme number

Select a programme number to be skipped with the  $\wedge/\vee$  or  $</>$  button.

Press the BLUE button. The skipped programme turns to blue.

Press the BLUE button again to release the skipped programme.

When a programme number is skipped it means that you will be unable to select it using the  $\wedge/\vee$  button during normal TV viewing. If you want to select the skipped programme, directly enter the programme number with the NUMBER buttons or select it in the programme edit or table menu.

Repeatedly press the MENU button to return to normal TV viewing.

## Calling the programme table

-You can check the programmes stored in the memory by displaying the programme table.

ENG

### 1 Displaying programme table

Press the LIST button to display the Programme table menu. The programme table appears on the screen. One programme table contains ten programmes as below.

You may find some blue programmes. They have been set up to be skipped by auto programming or in the programme edit mode. Some programmes with the channel number shown in the programme table indicate there is no station name assigned.

### 2 Selecting a programme in the programme table

Select a programme with the  $\wedge/\vee$  or  $</>$  button. Then press the OK button. The set switches to the chosen programme number.

### 3 Paging through a programme table

There are 10 programme table pages which contain 100 programmes.

Pressing the  $\wedge/\vee$  or  $</>$  button repeatedly turns the pages.

Repeatedly press the MENU button to return to normal TV viewing.

## Picture adjustment

### CSM (Colour Status Memory)

To initialize values (reset to default settings), select the Normal option.

Press the MENU button and then  $\wedge / \vee$  button to select the PICTURE menu.

Press the  $\>$  button and then  $\wedge / \vee$  button to select CSM.

Press the  $\>$  button and then  $\wedge / \vee$  button to select the desired colour temperature.

Repeatedly press the MENU button to return to normal TV viewing.

You can adjust red, green, or blue to any colour temperature you prefer.

Press the MENU button and then use  $\wedge / \vee$  button to select the PICTURE menu.

Press the  $\>$  button and then use  $\wedge / \vee$  button to select CSM.

Press the  $\>$  button and then use  $\wedge / \vee$  button to select User.

Press the 8 button and then use  $\< / \>$  button to make appropriate adjustments.

Repeatedly press the MENU button to return to normal TV viewing.

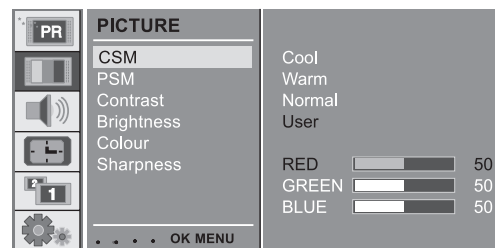
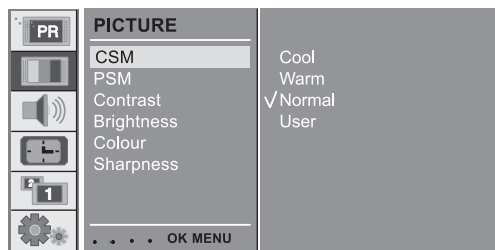
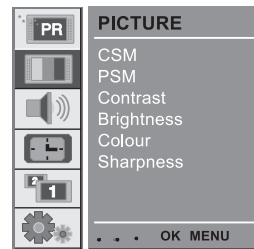

ENG

## 2 PSM (Picture Status Memory)

Press the MENU button and then use  $\wedge/\vee$  button to select the PICTURE menu.

Press the  $\gt$  button and then use  $\wedge/\vee$  button to select PSM. Press the  $\gt$  button and then use  $\wedge/\vee$  button to select a picture setting on the PSM pull-down menu.

Repeatedly press the MENU button to return to normal TV viewing.

You can also recall a desired picture (Dynamic, Standard, Mild, Game or User) with PSM button on the remote control. The picture Dynamic, Standard, Mild, Game are programmed for good picture reproduction at the factory and cannot be changed.

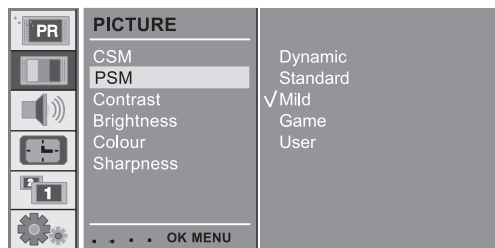
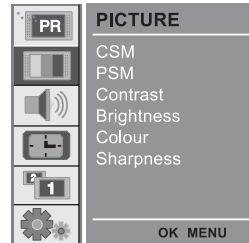

## Manual Picture Control

Press the MENU button and then use  $\wedge/\vee$  button to select the PICTURE menu.

Press the  $\gt$  button and then use  $\wedge/\vee$  button to select the desired picture option.

Press the  $\gt$  button and then use  $\lt/\gt$  button to make appropriate adjustments.

You can adjust picture contrast, brightness, colour, sharpness and tint (NTSC input only) to the levels you prefer.

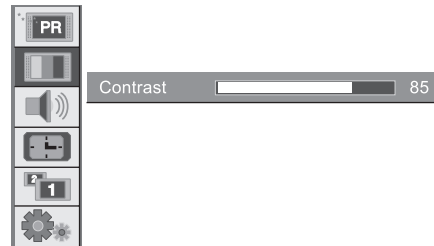

## Picture format

You can watch TV in various picture formats; 16:9, 14:9, 4:3, ZOOM1, ZOOM2, SPECTACLE, AUTO. Repeatedly press the ARC button to select your desired picture format.

1. Press the ARC button to select a desired picture format.

- Each press of ARC button changes the screen display as shown below.
- You can also select 16:9, 14:9, 4:3, ZOOM1, ZOOM2, SPECTACLE, AUTO in the PIP menu.
- You can only select 14:9, ZOOM1, ZOOM2, SPECTACLE, AUTO in TV, AV1, AV2, AV3, AV4, S-VIDEO, COMPONENT1 [480i], COMPONENT2 [480i] mode only.

ENG

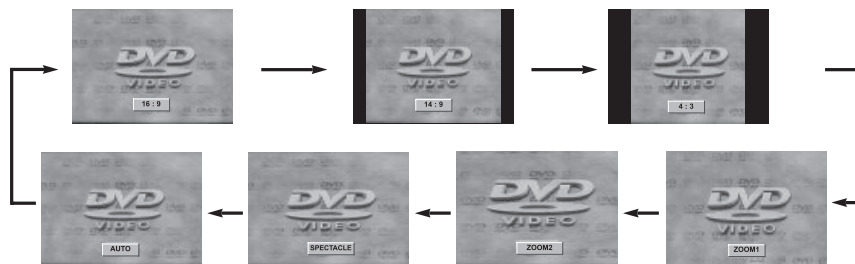

ENG

## Sound adjustment

### 1 SSM (Sound Status Memory)

Press the MENU button and then use  $\wedge$ / $\vee$  button to select the SOUND menu.

Press the  $\triangleright$  button and then use  $\wedge$ / $\vee$  button to select SSM.

Press the  $\triangleright$  button and then use  $\wedge$ / $\vee$  button to select a sound setting on the SSM pull-down menu.

Repeatedly press the MENU button to return to normal TV viewing.



### Sound Frequency Adjustment

a. Press the  $\triangleright$  button in User.

b. Select a sound band by pressing the  $\langle$ / $\triangleright$  button.

c. Make appropriate sound level with the  $\wedge$ / $\vee$  button.

d. Press the OK button to store it for the sound User.

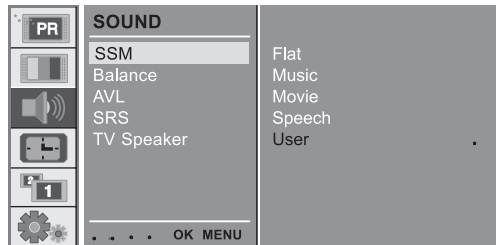

You can also recall a desired sound (Flat, Music, Movie, Speech or User) with SSM button on the remote control. The sound Flat, Music, Movie and Speech are programmed for good sound reproduction at the factory and cannot be changed.

When changing SSM option in SOUND menu, SRS is automatically changed to Off.



## 2 Balance

Press the MENU button and then use  $\wedge$ / $\vee$  button to select the SOUND menu.

Press the  $\gt$  button and then use  $\wedge$ / $\vee$  button to select the desired sound item.

Press the  $\gt$  button and then use  $\lt$ / $\gt$  button to make appropriate adjustments.

Repeatedly press the MENU button to return to normal TV viewing.

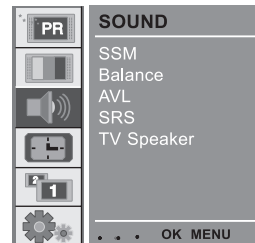

ENG

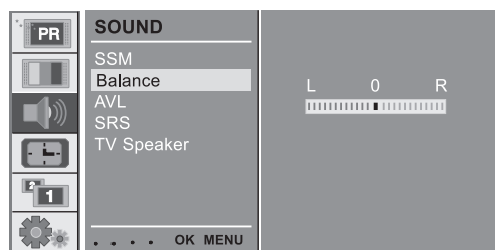

## 3 AVL (Auto Volume Leveler)

Press the MENU button and then use  $\wedge$ / $\vee$  button to select the SOUND menu.

Press the  $\gt$  button and then use  $\wedge$ / $\vee$  button to select AVL.

Press the  $\gt$  button and then use  $\wedge$ / $\vee$  button to select On or Off.

Repeatedly press the MENU button to return to normal TV viewing.

This feature maintains an equal volume level; even if you change channels.

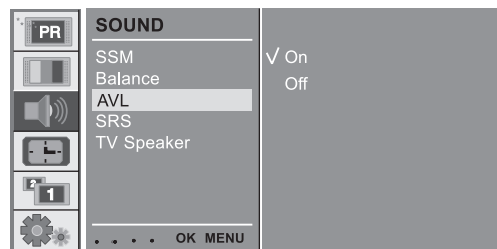

## 4 SRS

SRS is a trademark of SRS Labs, Inc.

-TruSurround XT technology is incorporated under license form SRS Labs, Inc.

-Manufactured under license form Dolby Laboratories.

Press the MENU button and then use  $\wedge$ / $\vee$  button to select the SOUND menu.

Press the  $\>$  button and then use  $\wedge$ / $\vee$  button to select SRS.

Press the  $\>$  button and then use  $\wedge$ / $\vee$  button to select Off, 3D Echo sound or XT TruSurround.

Repeatedly press the MENU button to return to normal TV viewing. When selecting Off option in SRS menu, SSM is automatically changed Flat.

When selecting 3D Echo sound or XT TruSurround option in SRS menu, SSM is automatically changed User.

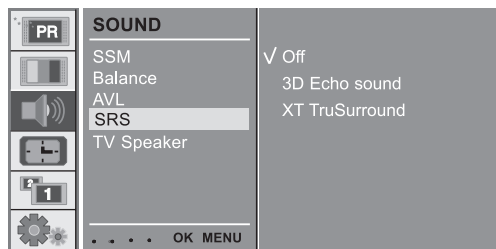
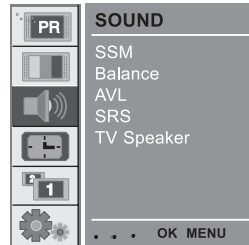

## 5 TV Speaker

-Turn TV speakers off if using external audio equipment.

Press the MENU button and then use  $\wedge$ / $\vee$  button to select the SOUND menu.

Press the  $\>$  button and then use  $\wedge$ / $\vee$  button to select TV Speaker.

Press the  $\>$  button and then use  $\wedge$ / $\vee$  button to select On or Off.

Repeatedly press the MENU button to return to normal TV viewing.

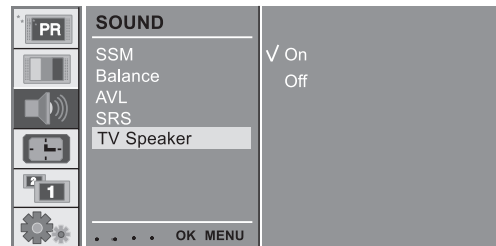



## 6 Stereo/Dual/NICAM reception

In AV mode, you can select output sound for the left and right loudspeakers. Repeatedly press the I/II button to select the sound output.

**L+R : Audio signal from audio L input is sent to left loud-speaker and audio signal from audio R input is sent to right loud-speaker.**

**L+L : Audio signal from audio L input is sent to left and right loudspeakers.**

**R+R : Audio signal from audio R input is sent to left and right loud-speakers.**

ENG

### Mono sound selection

In stereo reception if the stereo signal is weak, you can switch to mono by pressing the I/II button twice. In mono reception the depth of sound is improved. To switch back to stereo, press the I/II button twice again.

### Language selection for dual language broadcast

If a programme received in two languages (dual language), you can switch to DUAL I, DUAL II or DUAL I+II by pressing the I/II button repeatedly.

**DUAL I sends the primary broadcast language to the loudspeakers.**

**DUAL II sends the secondary broadcast language to the loudspeakers.**

**DUAL I+II sends a separate language to each loudspeaker.**

If your set is equipped with the receiver for NICAM reception, the high quality NICAM (Near Instantaneous Companding Audio Multiplex) digital sound can be received. Sound output can be selected according to the type of received broadcast as follows by pressing the I/II button repeatedly.

When NICAM mono is received, you can select NICAM MONO or FM MONO.

When NICAM stereo is received, you can select NICAM STEREO or FM MONO. If the stereo signal is weak, switch to FM mono.

When NICAM dual is received, you can select NICAM DUAL I, NICAM DUAL II or NICAM DUAL I+II or MONO. When FM mono is selected the display MONO appears on the screen.

## Time Menu

### 1 Clock

ENG

You must set the time correctly before using on/off time function.

Press the MENU button and then  $\wedge/\vee$  button to select the TIME menu.

Press the  $>$  button and then  $\wedge/\vee$  button to select Clock.

Press the  $>$  button and then  $\wedge/\vee$  button to adjust the hour / minute.

Repeatedly press the MENU button to return to normal TV viewing.

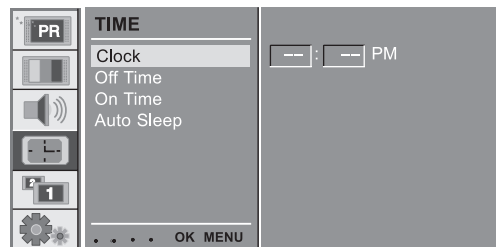

### 2 On/Off Time

The off timer automatically switches the set to standby at the preset time.

Press the MENU button and then  $\wedge/\vee$  button to select the TIME menu.

Press the  $>$  button and then  $\wedge/\vee$  button to select Off Time or On Time.

Press the  $>$  button and then  $\wedge/\vee$  button to select On.

To cancel Off/On Time function, press the  $\wedge/\vee$  button to select Off.

Press the  $>$  button and then  $\wedge/\vee$  button to adjust the hour / minute.

Only On time function; Press the  $>$  button and then  $\wedge/\vee$  button to adjust volume level and programme number.

Repeatedly press the MENU button to return to normal TV viewing.

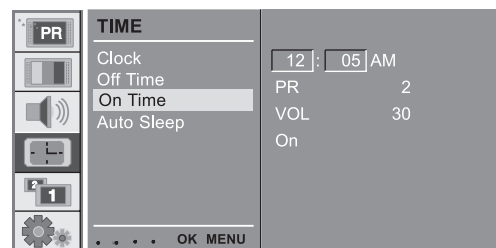

#### Note :

a. In the event of power

interruption (disconnection or power failure), the clock must be reset.

b. Two hours after the set is switched on by the on time function it will automatically switch back to standby mode unless a button has been pressed.

- c. Once the on or off time is set, these functions operate daily at the preset time.
- d. Off Timer function overrides On Timer function if they are set to the same time.
- e. The set must be in standby mode for the On Timer to work.

### 3 Auto sleep

If you select On on the Auto Sleep menu, the set will auto-matically switch itself to standby mode approximately ten minutes after a TV station stops broadcasting.

Press the MENU button and then  $\wedge / \vee$  button to select the TIME menu.

Press the  $>$  button and then  $\wedge / \vee$  button to select Auto Sleep.

Press the  $>$  button and then  $\wedge / \vee$  button to select On or Off.

Repeatedly press the MENU button to return to normal TV viewing.

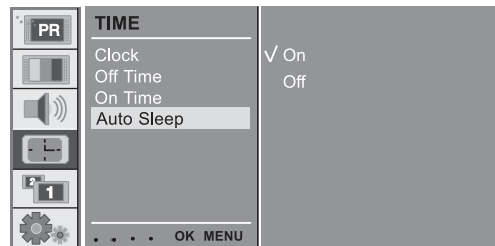

ENG

### 4 Sleep timer

You don't have to remember to switch the set off before you go to sleep. The sleep timer automatically switches the set to standby after the preset time has elapsed. Press the SLEEP button to select the number of minutes. The display '--- min' will appear on the screen, followed by 10, 20, 30, 60, 90, 120, 180 and 240. The timer begins to count down from the number of minutes selected.

Note :

- a. To view the remaining sleep time, press the SLEEP button once.
- b. To cancel the sleep time, repeatedly press the SLEEP button until the display '--- min' appears.
- c. When you switch the set off, the set releases the preset sleep time.

## Setup Menu

### 1 Front Light

ENG

You can switch Front Light LED on or off.

Press the MENU button and then  $\wedge$ / $\vee$  button to select the SETUP menu.

Press the  $\>$  button and then  $\wedge$ / $\vee$  button to select Front Light.

Press the  $\>$  button and then  $\wedge$ / $\vee$  button to select On or Off.

Repeatedly press the MENU button to return to normal TV viewing.

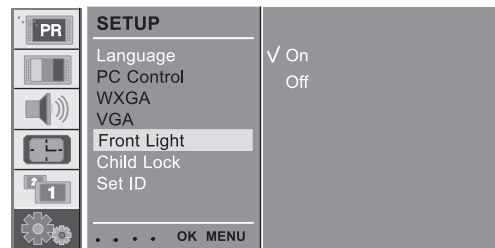

### 2 Child Lock

The TV can be set so that the remote control handset is needed to control it. This feature can be used to prevent unauthorized viewing.

Press the MENU button and then  $\wedge$ / $\vee$  button to select the SETUP menu.

Press the  $\>$  button and then  $\wedge$ / $\vee$  button to select Child Lock.

Press the  $\>$  button and then  $\wedge$ / $\vee$  button to select On or Off.

Repeatedly press the MENU button to return to normal TV viewing.

With the lock on, the display Child Lock appears on the screen if any button on the front panel is pressed while viewing the TV.

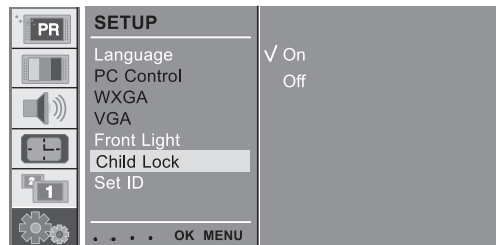

## Connection of PC

### PC Setup

You can adjust horizontal/vertical position, clock, phase, and auto-configure, reset as you prefer.

Press the MENU button and then  $\wedge$ / $\vee$  button to select the SETUP menu.

Press the  $>$  button and then  $\wedge$ / $\vee$  button to select the desired picture item.

Press the  $</>$  button to make appropriate adjustments.



ENG

### H-Position / V-Position

This function is to adjust picture to left/right and up/down as you prefer.

### Clock

This function is to minimize any vertical bars or stripes visible on the screen background. And the horizontal screen size will also change.

### Phase

This function allows you to remove any horizontal noise and clear or sharpen the image of characters.

### Auto-configure

This function is for the automatic adjustment of the screen position, clock and phase. The displayed image will disappear for a few seconds while the Auto-configuration is in progress.

### Reset

This function allows you to return to the good picture reproduction programmed at the factory and cannot be changed.

**Note :** Some signal from some graphics boards may not function properly. If the results are unsatisfactory, adjust your monitor's position, clock and phase manually.

Press the OK button to store it for the PC monitor picture.

Press the EXIT button to return to PC mode.

### WXGA (or VGA (Only RGB mode))

a: When the set is inputted WXGA signal, select the desired WXGA resolution.

b: When the set is inputted HDMI-480p signal in VGA mode, select 480p on the SETUP menu.

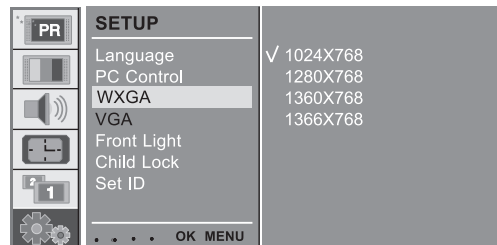

PRESTIGIO P400MW / P460MW

29

ENG

## PIP (Picture-in-Picture) Feature

-PIP lets you view 2 different inputs (sources) on your monitor screen at the same time. One source will be large, and the other source will show a smaller inset image.

### 1 Watching PIP

Press the PIP button to show the sub picture.

• Each press of PIP button changes the screen display as shown below.

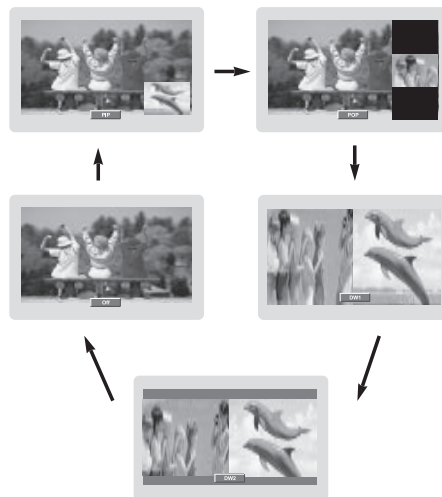

### 2 PIP Audio Output

PIP mode - main and sub picture audio select.

Press the MENU button and then  $\wedge$  /  $\vee$  button to select the PIP menu.

Press the  $\>$  button and then  $\wedge$  /  $\vee$  button to select Audio Output.

Press the  $\>$  button and then  $\wedge$  /  $\vee$  button to select Main or Sub.

Repeatedly press the MENU button to return to normal TV viewing.

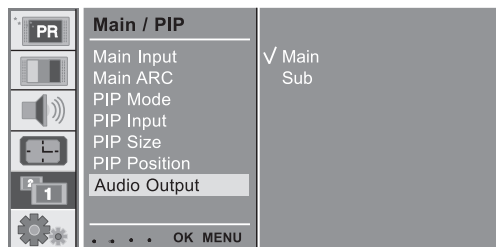

### 3 Moving the PIP

Press the PIP POSITION button.

Press the PIP POSITION button repeatedly until desired position is achieved. The sub pictures move clockwise.

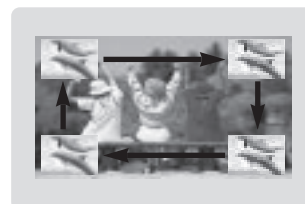

## 4 Swapping the PIP

Press the SWAP button to exchange the main and sub pictures.

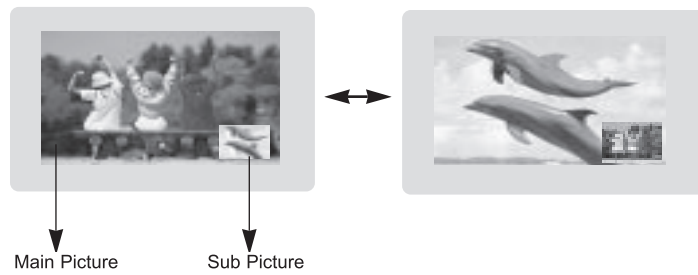

ENG

MAIN SUB	TV	AV1	AV2	AV3	AV4	S- VIDEO	COMP. 1	COMP. 2	PC- RGB	HDMI1	HDMI2
TV	X	O	O	O	O	O	O	O	O	O	O
AV1	O	X	O	O	O	O	O	O	O	O	O
AV2	O	O	X	O	O	O	O	O	O	O	O
AV3	O	O	O	X	O	O	O	O	O	O	O
AV4	O	O	O	O	X	O	O	O	O	O	O
S-VIDEO	O	O	O	O	O	X	O	O	O	O	O
COMP.1	X	X	X	X	X	X	X	X	X	X	X
COMP.2	X	X	X	X	X	X	X	X	X	X	X
PC-RGB	X	X	X	X	X	X	X	X	X	X	X
HDMI 1	X	X	X	X	X	X	X	X	X	X	X
HDMI 2	X	X	X	X	X	X	X	X	X	X	X

## 5 Selecting a Input Signal Source for the PIP

Use the PIP INPUT button to select the input source for the sub picture.



## 6 Programme selection for sub picture

Press the PIP PR +/- button. The selected programme number is displayed just below the programme number of main picture.

## 7 Programme scan

This function enables you to search all the stored stations on 4 or 16 sub pictures and see your favourite station by exchanging the main and sub pictures.

Press the SCAN button repeatedly to select POP4/POP16. The selected sub or main pictures search all the stored stations. Press the EXIT button to switch off sub or main pictures.





## Teletext (option)

Teletext (or TOP text) is an optional function, therefore only a set with the teletext system can receive the teletext broadcast. Teletext is a free service broadcast by most TV stations which gives up-to-the-minute information on news, weather, television programmes, share prices and many other topics.

The teletext decoder of this TV can support the SIMPLE, TOP and FASTEXT systems. SIMPLE (standard teletext) consists of a number of pages which are selected by directly entering the corresponding page number. TOP and FASTEXT are more modern methods allowing quick and easy selection of teletext information.

### Switch on/off

Press the TEXT button to switch to teletext. The initial page or last page appears on the screen. Two page numbers, TV station name, date and time are displayed on the screen headline. The first page number indicates your selection, while the second shows the current page displayed. Press the TEXT button to switch off teletext. The previous mode reappears.

### SIMPLE text

#### Page selection

1. Enter the desired page number as a three digit number with the NUMBER buttons. If during selection you press a wrong number, you must complete the three digit number and then re-enter the correct page number.
2. The  $\wedge$  /  $\vee$  button can be used to select the preceding or following page.

### Programming a colour button in LIST mode

If the TV is in SIMPLE text, TOP text or FASTEXT mode, press the button '—M' to switch to LIST mode.

Four teletext page numbers of your choice can be colour coded and easily selected by pressing the corresponding coloured button on the remote control handset.

1. Press a coloured button.
2. Using the NUMBER buttons, select the page you wish to programme.
3. Press the OK button. The selected page is stored as the selected page number, blinking once to confirm this. From now on, you can select this page with the same coloured button.
4. The three other coloured buttons are programmed in this way.

### TOP text (option)

The user guide displays four fields—red, green, yellow and blue at the bottom of the screen. The yellow field denotes the next group and the blue field indicates the next block.

### Block / group / page selection

1. With the blue button you can progress from block to block.
2. Use the yellow button to proceed to the next group with automatic overflow to the next block.
3. With the green button you can proceed to the next existing page with automatic overflow to the next group. Alternatively the  $\wedge$  button can be used.
4. The red button permits to return to previous selection. Alternatively the  $\vee$  button can be used.

## Direct page selection

Corresponding to the SIMPLE teletext mode, you can select a page by entering it as a three digit number using the NUMBER buttons in TOP mode.

## ENG FASTEXT

The teletext pages are colour coded along the bottom of the screen and are selected by pressing the correspond-ing coloured button.

## Page selection

1. Press the '---M' button to select the index page.
2. You can select the pages which are colour coded along the bottom line with the same coloured buttons.
3. Corresponding to the SIMPLE teletext mode, you can select a page by entering its three digit page number with the NUMBER buttons in FASTEXT mode.
4. The  $\wedge$  /  $\vee$  button can be used to select the preceding or following page.

## Special teletext functions

### REVEAL

Press this button to display concealed information, such as solutions of riddles or puzzles.  
Press this button again to remove the information from the display.

### SIZE

Selects double height text.  
Press this button to enlarge the top half of the page.  
Press this button again to enlarge the bottom half of the page.  
Press this button again to return to the normal display.

### UPDATE

Displays the TV picture on the screen while waiting for the new teletext page. The display '—X' will appear at the top left hand corner of the screen. When the updated page is available then display '—X' will change to the page number.  
Press this button to view the updated teletext page.

### HOLD

Stops the automatic page change which will occur if a tele-text page consists of 2 or more sub pages. The number of sub pages and the sub page displayed is, usually, shown on the screen below the time. When this button is pressed the stop symbol is displayed at the top left-hand corner of the screen and the automatic page change is inhibited. To continue press this button again.

### MIX

Displays the teletext pages superimposed on the TV picture.  
To switch the TV picture off press this button again.

## TIME

When viewing a TV programme, press this button to display the time at the top right hand corner of the screen. Press this button again to remove the display. In the tele-text mode, press this button to select a sub page number. The sub page number is displayed at the bottom of the screen. To hold or change the sub page, press the RED / GREEN, / \ / V or NUMBER buttons.

Press this button again to exit this function.

## External Control Device Setup

-Connect the RS-232C input jack to an external control device (such as a computer or an A/V control system) and control the set's functions externally.

### How to connect external control equipment

Connect the serial port of the control device to the RS-232C jack on the set.

RS-232C connection cables are not supplied with the Monitor.

The Monitor remote control and front panel controls (except main power) will not be functional if the set is controlled by a PC computer or other external device.

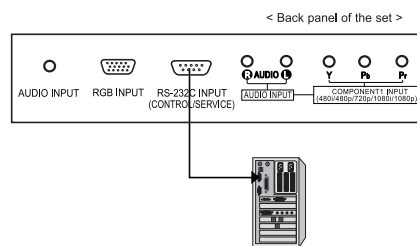

### Type of connector; D-Sub 9-pin male

No.	Pin name
1	No connection
2	RXD (Receive data)
3	TXD (Transmit data)
4	DTR (DTE side ready)
5	GND
6	DSR (DCE side ready)
7	RTS (Ready to send)
8	CTS (Clear to send)
9	No Connection

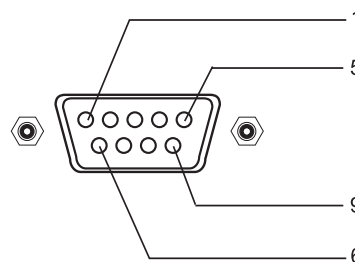

## Communication Parameters

- Baud rate : 4800bps (UART)
- Data length : 8bits
- Parity : None
- Stop bit : 1bit
- Communication code : HEX code

## Set ID

Press the MENU button and then  $\wedge$ / $\vee$  button to select the SETUP menu.

Press the  $\gt$  button and then  $\wedge$ / $\vee$  button to select Set ID.

Press the  $\gt$  button and then use  $\lt$ / $\gt$  button to adjust Set ID to choose the desired monitor ID number.

The adjustment range of Set ID is 1 ~ 99.

Use this function to specify a monitor ID number. Refer to 'Real Data Mapping 1'.

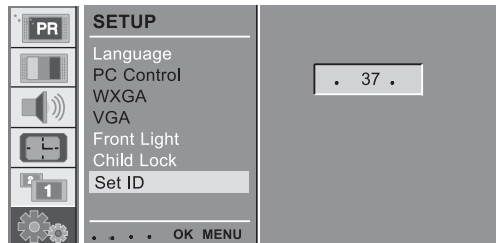

## Command Reference List

	COMMAND	DATA (Hexadecimal)
01. Power	0x01	0~1
02. Volume Mute	0x02	0~1
03. Screen Mute	0x03	0~1
04. Contrast	0x04	0~64
05. Brightness	0x05	0~64
06. Colour	0x06	0~64
07. Sharpnes	0x07	0~64
08. CSM	0x08	0~3
09. PSM	0x09	0~4
10. SSM	0x0A	0~4
11. Volume	0x0B	0~64
12. Balance	0x0C	0~64
13. AVL	0x0D	0~1
14. SRS	0x0E	0~2
15. TV Speaker	0x0F	0~1
16. PIP Mode	0x25	0~4
17. PIP Input	0x26	0~9
18. PIP Size	0x27	0~1
19. PIP Position	0x28	0~3
20. PIP Audio Output	0x29	0~1
21. Clock	0x2A	0~64
22. Phase	0x2B	0~64
23. Horizontal	0x2C	0~64
24. Vertical	0x2D	0~64
25. Auto	0x2E	0
26. Reset	0x2F	0
27. Main Input	0x30	0~9
28. Main ARC	0x31	0~6
29. Front Light	0x33	0~1
30. Child Lock	0x34	0~1
31. Language	0x35	0~A
32. Programme Number input	0x36	0~63
33. Programme Selection	0x37	0~1
34. Auto Sleep	0x38	0~1

## Transmission / Receiving Protocol

### Transmission

[F6][Command][SetID][Data][CS][6F]

\* [F6] : Start of Communication

\* [Command] : Command set

\* [Set ID] : You can adjust the set ID to choose desired monitor ID number in SETUP menu. See previous page. Adjustment range is 1~99.

\* [DATA] : To transmit command data. Transmit 'FF' data to read status of command.

\* [Cr] : Check Sum ASCII code '0x0D'

\* [6F] : End of Communication

### OK Acknowledgement

[F7][Command][SetID][Data][CS][7F]

\* **The Monitor transmits**

**ACK(acknowledgement) based on this format when receiving normal data. At this time, if the data is data read mode, it indicates present status data. If the data is data write mode, it returns the data of the PC computer.**

### Error Acknowledgment

[F7][Command][SetID][FF][CS][7F]

\* **The Monitor transmits**

**ACK(acknowledgement) based on this format when receiving abnormal data from non-viable function or communication errors.**

### 01. Power

:To control Power On/Off of the set

Transmission

[F6][01][SetID][Data][CS][6F]

Data 0 : Power Off 1 : Power On

OK Acknowledgement

[F7][01][SetID][Data][CS][7F]

:To show Power On/Off

Transmission

[F6][01][SetID][FF][CS][6F]

OK Acknowledgement

[F7][01][SetID][Data][CS][7F]Data 0 : Off 1 : On

\* In like manner, if other functions transmit 'FF' data based on this format, Acknowledgement data feed back presents status about each function.

### 02. Volume Mute

:To control volume mute On/Off of the set

Transmission

[F6][02][SetID][Data][CS][6F]

Data 0 : Volume Mute Off (Volume On)

1 : Volume Mute On (Volume Off)

OK Acknowledgement

[F7][02][SetID][Data][CS][7F]

### 03. Screen Mute

:To select screen mute On/Off

Transmission

[F6][03][SetID][Data][CS][6F]

Data 0 : Screen Mute Off (Picture On)

1 : Screen Mute On (Picture Off)

OK Acknowledgement

[F7][03][SetID][Data][CS][7F]

### 04. Contrast

:To adjust screen contrast. You can also adjust contrast in the PICTURE menu.

Transmission

[F6][04][SetID][Data][CS][6F]

Data Min : 0 ~ Max : 64

\* Refer to 'Real data mapping'.

OK Acknowledgement

[F7][04][SetID][Data][CS][7F]

ENG

**05. Brightness**

:To adjust screen brightness.You can also adjust brightness in the PICTURE menu.

Transmission  
[F6][05][SetID][Data][CS][6F]  
Data Min : 0 ~ Max : 64

\* Refer to 'Real data mapping1'.

OK Acknowledgement  
[F7][05][SetID][Data][CS][7F]

**06. Colour**

:To adjust screen colour.You can also adjust colour in the PICTURE menu.

Transmission  
[F6][06][SetID][Data][CS][6F]  
Data Min : 0 ~ Max : 64

\* Refer to 'Real data mapping1'.

OK Acknowledgement  
[F7][06][SetID][Data][CS][7F]

**07. Sharpness**

:To adjust screen sharpness.You can also adjust sharpness in the PICTURE menu.

Transmission  
[F6][07][SetID][Data][CS][6F]  
Data Min : 0 ~ Max : 64

\* Refer to 'Real data mapping1'.

OK Acknowledgement  
[F7][07][SetID][Data][CS][7F]

**08. CSM**

:To adjust colour temperature.You can also adjust CSM.In the PICTURE menu.

Transmission  
[F6][08][SetID][Data][CS][6F]  
Data 0 : Cool 1 : Normal  
2 : Warm 3 : User

OK Acknowledgement  
[F7][08][SetID][Data][CS][7F]

**09. PSM**

:To select picture mode.You can also adjust PSM. In the PICTURE menu.

Transmission  
[F6][09][SetID][Data][CS][6F]  
Data 0 : Dynamic 2 : Mild 5 : User

OK Acknowledgement  
[F7][09][SetID][Data][CS][7F]  
1 : Standard 3 : Game

**10. SSM**

:To select sound mode.You can also adjust SSM. In the SOUND menu.

Transmission  
[F6][0A][SetID][Data][CS][6F]  
Data 0 : Flat 1 : Music  
2 : Movie 3 : Speech  
5 : User

OK Acknowledgement  
[F7][0A][SetID][Data][CS][7F]

**11. Volume**

:To adjust volume.

Transmission  
[F6][0B][SetID][Data][CS][6F]  
Data Min : 0 ~ Max : 64  
\* Refer to 'Real data mapping1'.

OK Acknowledgement  
[F7][0B][SetID][Data][CS][7F]

**12. Balance**

:To adjust sound balance.You can also adjust Balance.In the SOUND menu.

Transmission  
[F6][0C][SetID][Data][CS][6F]  
Data Min : 0 ~ Max : 64

\* Refer to 'Real data mapping2'.

OK Acknowledgement  
[F7][0C][SetID][Data][CS][7F]

**13. AVL**

:To control AVL On/Off of the set.

Transmission  
[F6][0D][SetID][Data][CS][6F]  
Data 0 : Off 1 : On

\* Refer to 'Real data mapping1'.

OK Acknowledgement  
[F7][0D][SetID][Data][CS][7F]

**14. SRS**

:To select SRS mode.You can also adjust SRS.In the SOUND menu.

Transmission  
[F6][0E][SetID][Data][CS][6F]  
Data 0 : Off  
1 : 3D Echo sound  
2 : XT TruSurround

OK Acknowledgement  
[F7][0E][SetID][Data][CS][7F]

**15. TV Speaker**

:To control TV Speaker On/Off of the set.You can also adjust TV Speaker.In the SOUND menu.

Transmission  
[F6][0F][SetID][Data][CS][6F]

Data 0 : Off 1 : On

OK Acknowledgement  
[F7][0F][SetID][Data][CS][7F]

**16. PIP Mode**

:To select PIP mode.You can also adjust PIP Mode.In the PIP menu.

Transmission  
[F6][25][SetID][Data][CS][6F]  
Data 0 : Off 1 : PIP  
2 : POP 3 : DW1  
4 : DW2

\* Refer to 'Real data mapping1'.

OK Acknowledgement  
[F7][25][SetID][Data][CS][7F]

**17. PIP Input**

:To select PIP Input.You can also adjust PIP Input.In the PIP menu.

Transmission  
[F6][26][SetID][Data][CS][6F]

Data 0 : TV 1 : AV1  
2 : AV2 3 : AV3  
4 : AV4 5 : S-VIDEO  
6 : COMPONENT2 7 : COMPONENT1  
8 : HDMI1 9 : PC-RGB  
10 : HDMI2

OK Acknowledgement  
[F7][26][SetID][Data][CS][7F]

**18. PIP Size**

:To select PIP Size.You can also adjust PIP Size.In the PIP menu.

Transmission  
[F6][27][SetID][Data][CS][6F]  
Data 0 : Small 1 : Large

OK Acknowledgement  
[F7][27][SetID][Data][CS][7F]

### 19. PIP Position

:To select PIP Position. You can also adjust PIP Position. In the PIP menu.

Transmission  
[F6][28][SetID][Data][CS][6F]  
Data 0 : Right Bottom 1 : Left Bottom  
2 : Left Top 3 : Right Top

OK Acknowledgement  
[F7][28][SetID][Data][CS][7F]

### 20. PIP Audio Output

:To select PIP audio output. You can also adjust Audio Output. In the PIP menu.

Transmission  
[F6][29][SetID][Data][CS][6F]  
Data 0 : Main 1 : Sub

OK Acknowledgement  
[F7][29][SetID][Data][CS][7F]

### 21. Clock

:To adjust clock. You can also adjust Clock. In the PC Control of SETUP menu.

Transmission  
[F6][2A][SetID][Data][CS][6F]  
Data Min : 0 ~ Max : 64  
\* Refer to 'Real data mapping1'.

OK Acknowledgement  
[F7][2A][SetID][Data][CS][7F]

### 22. Phase

:To adjust phase. You can also adjust Phase. In the PC Control of SETUP menu.

Transmission  
[F6][2B][SetID][Data][CS][6F]  
Data Min : 0 ~ Max : 64  
\* Refer to 'Real data mapping1'.

OK Acknowledgement  
[F7][2B][SetID][Data][CS][7F]

### 23. Horizontal

:To adjust horizontal. You can also adjust H-Pos. In the PC Control of SETUP menu.

Transmission  
[F6][2C][SetID][Data][CS][6F]  
Data Min : 0 ~ Max : 64  
\* Refer to 'Real data mapping2'.

OK Acknowledgement  
[F7][2C][SetID][Data][CS][7F]

### 24. Vertical

:To adjust vertical. You can also adjust V-Pos. In the PC Control of SETUP menu.

Transmission  
[F6][2D][SetID][Data][CS][6F]  
Data Min : 0 ~ Max : 64

\* Refer to 'Real data mapping2'.

OK Acknowledgement  
[F7][2D][SetID][Data][CS][7F]

### 25. Auto

:To execute auto command. You can also execute Auto. In the PC Control of SETUP menu.

Transmission  
[F6][2E][SetID][Data][CS][6F]  
Data 0 : Execute

OK Acknowledgement  
[F7][2E][SetID][Data][CS][7F]



## 26. Reset

:To execute reset command.You can also execute Reset.In the PC Control of SETUP menu.

Transmission  
[F6][2F][SetD][Data][CS][6F]  
Data 0 : Execute

OK Acknowledgement  
[F7][2F][SetD][Data][CS][7F]

## 27. Main Input

:To select Input.You can also select Input.In the PIP menu.

Transmission  
[F6][30][SetD][Data][CS][6F]  
Data 0 : TV 1 : AV1  
2 : AV2 3 : AV3  
4 : AV4 5 : S-VIDEO  
6 : COMPONENT2 7 : COMPONENT1  
8 : HDMI1 9 : PC-RGB  
10 : HDMI2

OK Acknowledgement  
[F7][30][SetD][Data][CS][7F]

## 28. Main ARC

:To select ARC.You can also select ARC.In the PIP menu.

Transmission  
[F6][31][SetD][Data][CS][6F]  
Data 0 : Auto 1 : 16:9  
2 : 14:9 3 : 4:3  
4 : ZOOM1 5 : ZOOM2  
6 : SPECTACLE

OK Acknowledgement  
[F7][31][SetD][Data][CS][7F]

## 29. Front Light

: To control front light mode. You can also control Front Light. In the SETUP menu.

Transmission  
[F6][33][SetD][Data][CS][6F]  
Data 0 : Off 1 : On

OK Acknowledgement  
[F7][33][SetD][Data][CS][7F]

## 30. Child Lock

: To control child lock mode. You can also control Child Lock. In the SETUP menu.

Transmission  
[F6][34][SetD][Data][CS][6F]  
Data 0 : Off 1 : On

OK Acknowledgement  
[F7][34][SetD][Data][CS][7F]

## 31. Language

: To select language. You can also select Language. In the SETUP menu.

Transmission  
[F6][35][SetD][Data][CS][6F]  
Data 0 : English 1 : Deutsche  
2 : French 3 : Italian  
4 : Spanish 5 : Portuguese  
6 : Danish 7 : Swedish  
8 : Finnish 9 : Dutch  
A : Russian

OK Acknowledgement  
[F7][29][SetD][Data][CS][7F]

## 32. Programme Number input

:To select a programme.

Transmission  
[F6][36][SetD][Data][CS][6F]  
Data Min : 0 ~ Max : 63  
\* Refer to 'Real data mapping1'.

OK Acknowledgement  
[F7][36][SetD][Data][CS][7F]



### 33. Programme Selection

:To select a programme for the main picture.

ENG

Transmission  
 [F6][37][SetID][Data][CS][6F]  
 \* Real data mapping 1 \* Real data mapping 2  
 0 : step 0 0 : -50, Left 50  
 A F :: step 10 step 15 31: -1, 32: 0 33: 1, Left 1 Right 1  
 10 : step 16 64: +50, Right 50  
 64 : step 100  
 C8 : step 200  
 Data 0 : Pr Up 1 : Pr Down

OK Acknowledgement  
 [F7][37][SetID][Data][CS][7F]

### 34. Auto Sleep

:To control auto sleep On/Off of the set. You can also select Auto Sleep. In the TIME menu.

Transmission  
 [F6][38][SetID][Data][CS][6F]  
 Data 0 : Off 1 : On

OK Acknowledgement  
 [F7][38][SetID][Data][CS][7F]

* Real data mapping 1	
0	: step 0
⋮	
A	: step 10
⋮	
F	: step 15
⋮	
10	: step 16
⋮	
64	: step 100
⋮	
C8	: step 200

* Real data mapping 2	
0	: -50, Left 50
⋮	
31	: -1, Left 1
32	: 0
33	: 1, Right 1
⋮	
64	: +50, Right 50



## Displayable Monitor

### Specification

#### RGB Mode / HDMI Mode

ENG

MODE	Resolution	Horizontal Frequency (KHz)	Vertical Frequency (Hz)
DOS	640X350	31.5	70.0
	720X400	31.5	70.0
		37.9	85.0
VGA	640X480	31.5	60.0
		37.8	72.0
		37.5	75.0
		43.2	85.0
SVGA	800X600	35.1	56.0
		37.9	60.0
		48.0	72.0
		46.9	75.0
		53.7	85.0
XGA	1024X768	48.4	60.0
		56.4	70.0
		60.0	75.0
		60.0	85.0
SXGA	1280X1024	63.9	60.0
		75.0	70.0
		79.9	75.0
		91.1	85.0
WXGA	1280X768	47.7	60.0
		60.1	75.0
		68.5	85.0
	1360X768	49.0	60.0
	1366X768	49.0	60.0
UXGA	1600X1200	75.0	60.0

**Note:**

- a. If the set is cold, there may be a small "flicker" when the set is switched on. This is normal, there is nothing wrong with the set.
- b. If possible, use the VESA 1,024x768@60Hz video mode to obtain the best image quality for your LCD monitor. If used to PC vertical frequency 85Hz, some noise can be seen when PIP is on. In this case, set the PC vertical frequency to 60Hz. The set has been pre-adjusted to the mode VESA 1,024x768@60Hz.
- c. Some dot defects may appear on the screen, like Red, Green or Blue spots. However, this will have no impact or effect on the monitor performance.
- d. Do not press the LCD screen with your finger for a long time as this may produce some temporary distortion effects on the screen.
- e. When the PC screen appears on the set, a message may appear on the screen, and the message will differ according to the Window system version (Win98, 2000). If a message appears click "Next" until the message finishes.
- f. If the message "Out Of Range" appears on the screen, adjust the PC as in the 'Displayable Monitor Specification' section.
- g. Supportable resolution may vary as per graphic card.

(Synchronization input form : separate)



## Free Manuals Download Website

<http://myh66.com>

<http://usermanuals.us>

<http://www.somanuals.com>

<http://www.4manuals.cc>

<http://www.manual-lib.com>

<http://www.404manual.com>

<http://www.luxmanual.com>

<http://aubethermostatmanual.com>

Golf course search by state

<http://golfingnear.com>

Email search by domain

<http://emailbydomain.com>

Auto manuals search

<http://auto.somanuals.com>

TV manuals search

<http://tv.somanuals.com>