

Palmcorder® Camcorder **Quasar**

VHS-C

Camcorder Operating Instructions

Model No. **VM-D52**



Please read these instructions carefully before attempting to operate this product.
Please save this manual.

Guía para rápida consulta en español está incluida.

For assistance, please call : 1-800-211-PANA(7262) or send e-mail to : consumerproducts@panasonic.com

LSQT0527A

Download from www.Somanuals.com. All Manuals Search And Download.

Getting Started

Basic Operation

Special Features

For Your Information

Things You Should Know

Thank you for choosing Panasonic!

You have purchased one of the most sophisticated and reliable products on the market today. Used properly, it will bring you years of enjoyment. Please take time to fill in the information to the right.

The serial number is on the tag located on the rear side of your Camcorder. Be sure to **retain this manual** as your convenient Camcorder information source.

Date of Purchase

Dealer Purchased From

Dealer Address

Dealer Phone No.

Model No.

Serial No.

Unpack your Camcorder

These accessories are provided in order to set up or use your Camcorder.

1 pc. AC Adaptor
(PV-A20) with DC Power
Cable (page 9)

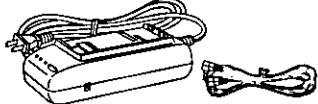

1 pc. Audio/Video Cable
(LSJA0390) (pages 20, 21)



1 pc. Battery Pack
(PV-BP15) (pages 8, 9)



1 pc. Shoulder Strap
(LSFC0012) (page 11)



1 pc. CR2025 Clock
Battery (VSBW0004)
(installed in Camcorder)
(page 32)



1 pc. Lens Cap (LSYK0818)
with Lens Cap Strap
(LSGQ0049) (page 11)



Battery Charging Confirmation Marker



Use this marker as a reminder to yourself when the battery is fully charged or in need of a charge. This marker performs no function and is for your reference only.

Things You Should Know

Safety Precautions

WARNING : TO PREVENT FIRE OR SHOCK HAZARD, DO NOT EXPOSE THIS EQUIPMENT TO RAIN OR MOISTURE.

Your Compact VHS Camcorder is designed to record and play back in Standard Play (SP) and Super Long Play (SLP) modes. You can also play a Compact VHS Camcorder recording on your VHS VCR using the supplied VHS PlayPak.

This Camcorder is equipped with the **HQ** System to provide excellent video pictures, and is compatible with standard VHS equipment.

It is recommended that only cassette tapes that have been tested and inspected for use in VCR machines with the **VHS-C** and/or **VHS** mark be used.

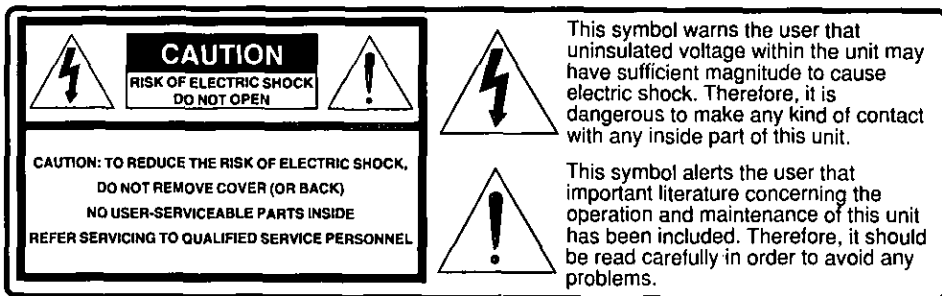

The above markings are located on the appliance's bottom cover.

FCC Warning: Any unauthorized changes or modifications to this equipment would void the user's authority to operate.

This device complies with Part 15 of the FCC Rules. Operation is subject to the following two conditions: (1) This device may not cause harmful interference, and (2) this device must accept any interference received, including interference that may cause undesired operation.

Note: This equipment has been tested and found to comply with Part 15 of the FCC Rules. These limits are designed to provide reasonable protection against harmful interference when operated in a residential environment.

If this equipment does cause interference to radio or television reception, which can be determined by turning the equipment off and on, use the equipment in another location and/or utilize an electrical outlet different from that used by the receiver.

If necessary, consult the dealer or an experienced radio/TV technician for help. You may find the booklet, 'Something About Interference' available from FCC local regional offices helpful.

Important Safeguards

- 1. Read Instructions** – All the safety and operating instructions should be read before the unit is operated.
- 2. Retain Instructions** – The safety and operating instructions should be retained for future reference.
- 3. Heed Warnings** – All warnings on the unit and in the operating instructions should be adhered to.
- 4. Follow Instructions** – All operating and maintenance instructions should be followed.
- 5. Cleaning** – Unplug this video unit from the wall outlet before cleaning. Do not use liquid or aerosol cleaners. Use a dry cloth for cleaning.
- 6. Attachments** – Do not use attachments not recommended by the video product manufacturer as they may be hazardous.
- 7. Water and Moisture** – Do not use this video unit near water – for example near a bath tub, wash bowl, kitchen sink, or laundry tub, in a wet basement, or near a swimming pool, and the like.
- 8. Accessories** – Do not place this video unit on an unstable cart, stand, tripod, bracket, or table. The video unit may fall, causing serious injury to a child or adult, and serious damage to the unit. Use only with a cart, stand, tripod, bracket, or table recommended by the manufacturer, or sold with the video unit. Any mounting of the unit should follow the manufacturer's instructions and should use a mounting accessory recommended by the manufacturer. An appliance and cart combination should be moved with care. Quick stops, excessive force, and uneven surfaces may cause the appliance and cart combination to overturn.
- 9. Ventilation** – Slots and openings in the cabinet are provided for ventilation and to ensure reliable operation of the video unit and to protect it from overheating. These openings must not be blocked or covered. Never place the video unit on a bed, sofa, rug, or other similar surface, or near or over a radiator or heat register. This video unit should not be placed in a built-in installation such as a bookcase or rack unless proper ventilation is provided or the manufacturer's instructions have been adhered to.
- 10. Power Sources** – This video unit should be operated only from the type of power source indicated on the marking label. If you are not sure of the type of power supply to your home, consult your appliance dealer or local power company. For video units intended to be operated from battery power, or other sources, refer to the operating instructions.



- 11. Grounding or Polarization** – This video unit may be equipped with either a polarized 2-wire AC (Alternating Current) line plug (a plug having one blade wider than the other) or 3-wire grounding type plug, a plug having a third (grounding) pin.

The 2-wire polarized plug will fit into the power outlet only one way. This is a safety feature. If you are unable to insert the plug fully into the outlet, try reversing the plug. If the plug still fails to fit, contact your electrician to replace your obsolete outlet.

Do not defeat the safety purpose of the polarized plug.

The 3-wire grounding type plug will fit into a grounding type power outlet. This is a safety feature. If you are unable to insert the plug into the outlet, contact your electrician to replace your obsolete outlet. Do not defeat the safety purpose of the grounding type plug.

- 12. Power-Cord Protection** – Power-supply cords should be routed so that they are not likely to be walked on or pinched by items placed upon or against them. Paying particular attention to cords of plugs, convenience receptacles, and the point where they exit from the unit.
- 13. Outdoor Antenna Grounding** – If an outside antenna or cable system is connected to the video unit, be sure the antenna or cable system is grounded so as to provide some protection against voltage surges and built-up static charges. Part 1 of the Canadian Electrical Code, in USA Section 810 of the National Electrical Code, provides information with respect to proper grounding of the mast and supporting structure, grounding of the lead-in wire to an antenna discharge unit, size of grounding conductors, location of antenna discharge unit, connection to grounding electrodes, and requirements for the grounding electrode.

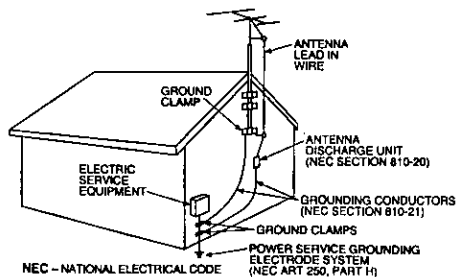

- 14. Lightning** – For added protection of this video unit receiver during a lightning storm, or when it is left unattended and unused for long periods of time, unplug it from the wall outlet and disconnect the antenna or cable system. This will prevent damage to the video unit due to lightning and power-line surges.

Important Safeguards

15. **Power Lines** – An outside antenna system should not be located in the vicinity of overhead power lines or other electric light or power circuits, or where it can fall into such power lines or circuits. When installing an outside antenna system, extreme care should be taken to keep from touching such power lines or circuits as contact with them might be fatal.
16. **Overloading** – Do not overload wall outlets and extension cords as this can result in a risk of fire or electric shock.
17. **Objects and Liquids** – Never push objects of any kind into this video unit through openings as they may touch dangerous voltage points or short out parts that could result in a fire or electric shock. Never spill liquid of any kind onto the video unit.
18. **Servicing** – Do not attempt to service this video unit yourself as opening or removing covers may expose you to dangerous voltage or other hazards. Refer all servicing to qualified service personnel.
19. **Damage Requiring Service** – Unplug this video unit from the wall outlet and refer servicing to qualified service personnel under the following conditions:
 - a. When the power-supply cord or plug is damaged.
 - b. If any liquid has been spilled into, or objects have fallen onto, the video unit.
 - c. If the video unit has been exposed to rain or water.
 - d. If the video unit does not operate normally by following the operating instructions. Adjust only those controls that are covered by the operating instructions, as an improper adjustment of other controls may result in damage and will often require extensive work by a qualified technician to restore the video unit to its normal operation.
 - e. If the video unit has been dropped or the cabinet has been damaged.
 - f. When the video unit exhibits a distinct change in performance – this indicates a need for service.
20. **Replacement Parts** – When replacement parts are required, be sure the service technician has used replacement parts specified by the manufacturer or have the same characteristics as the original part. Unauthorized substitutions may result in fire, electric shock or other hazards.
21. **Safety Check** – Upon completion of any service or repairs to this video unit, ask the service technician to perform safety checks to determine that the video unit is in safe operating order.

Precautions

USE & LOCATION

- **TO AVOID SHOCK HAZARD ...** Your Camcorder and power supply should not be exposed to rain or moisture. Do not connect the power supply or operate your Camcorder if it gets wet. Your Camcorder has been designed for outdoor use, however it is not designed to sustain direct exposure to water, rain, sleet, snow, sand, dust, or a direct splashing from a pool or even a cup of coffee. This action could permanently damage the internal parts of your Camcorder. Do not attempt to disassemble this unit. There are no user serviceable parts inside. Unplug your Camcorder from the power supply before cleaning.
- **DO NOT AIM YOUR CAMCORDER AT THE SUN OR OTHER BRIGHT OBJECTS.**
- **DO NOT LEAVE THE CAMCORDER WITH THE EVF AIMED DIRECTLY AT THE SUN AS THIS MAY CAUSE DAMAGE TO THE INTERNAL PARTS OF THE EVF.**
- **DO NOT EXPOSE YOUR CAMCORDER TO EXTENDED HIGH TEMPERATURE ...** Such as, in direct sunlight, inside a closed car, next to a heater, etc... This action could permanently damage the internal parts of your Camcorder.
- **AVOID SUDDEN CHANGES IN TEMPERATURE ...** If the unit is suddenly moved from a cold place to a warm place, moisture may form on the tape and inside the unit.
- **DO NOT LEAVE YOUR CAMCORDER OR THE POWER SUPPLY TURNED ON WHEN NOT IN USE.**
- **STORAGE OF YOUR CAMCORDER ...** Store and handle your Camcorder in a manner that will not subject it to unnecessary movement (avoid shaking and striking). Your Camcorder contains a sensitive pick-up device which could be damaged by improper handling or storage.

CARE

- **TO CLEAN YOUR CAMCORDER ...** Do not use strong or abrasive detergents when cleaning your Camcorder body.
- **TO PROTECT THE LENS ...** Do not touch the surface of the lens with your hand. Use a commercial camcorder lens solution and lens paper when cleaning the lens. Improper cleaning can scratch the lens coating.
- **TO PROTECT THE FINISH OF YOUR CAMCORDER ...** Before handling your Camcorder, make sure your hands and face are free from any chemical products, such as suntan lotion, as it may damage the finish.

Table of Contents

Getting Started

Things You Should Know	2~3
Important Safeguards	4~5
Precautions	5
Quick Operation Guide	7
Supplying Power (Battery Charge/Use/Refresh/Care, AC Adaptor, Car Battery Cord)	8~9
Cassette Information	10
Before Using (Remove the Sensor tag, Using the Shoulder and Hand Straps, Lens Cap)	11
Using MENU Mode	12
Setting the Clock (Time Zone, Auto Daylight Saving Time)	13~14
Built-in Auto Light (Using the Light, Replacing the Bulb)	15

Basic Operation

Camera Recording (Basic, Stand-by, Programmed Recording)	16~18
Playing Back Recordings (Basic Playback, Visual Search, Still Picture, Tracking, TV/VCR Playback)	19~20
Copying your Tapes (dubbing)	21

Special Features

Four-Speed Power Zoom	22
Backlight	22
Focus (Auto/Manual Focus)	23
High Speed Shutter (Auto/Manual Shutter)	24
Auto Fade	25
Color Digital Fade	26
Digital Zoom	27
Digital Electronic Image Stabilization (E.I.S.)	27
MotionSensor	28

For Your Information

Electronic Viewfinder Indications	29~30
Operation Notes (Cleaning EVF)	31
Notice	31
Replacing Clock Battery	32
Palmcorder Accessory System	33
Palmcorder Accessory Order Form	34
Specifications	35
Request for Service Notice	35
Before Requesting Service (Video Head Cleaning)	36
Limited Warranty	37
Servicenter List	38
Spanish Quick Use Guide/Guía Para Uso Rápido	39
Index	40

Quick Operation Guide

Charging the Battery Pack

Charge Battery Pack fully before operation (page 8).

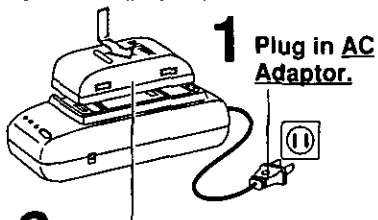

1 Plug in **AC Adaptor**.

2 Insert **Battery**. **CHARGE** Lamp flashes, then stays lit when charging is complete.

Insert Cassette

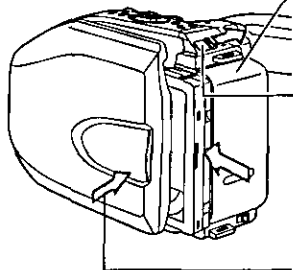

1 Attach fully charged **Battery** (page 8).

2 Slide **TAPE EJECT** to open door.

3 Insert **cassette** (page 10).

4 Press here to close door.

Camera Recording

See page 16.

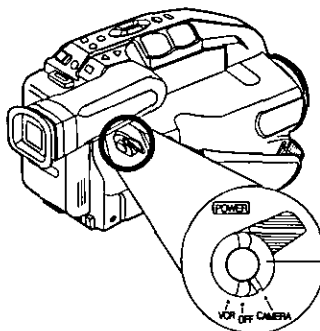

1 Set **POWER** to **CAMERA**.

2 Press **RECORD/PAUSE** to start recording. Press **RECORD/PAUSE** again to pause recording.

Playback using the EVF

See page 19.

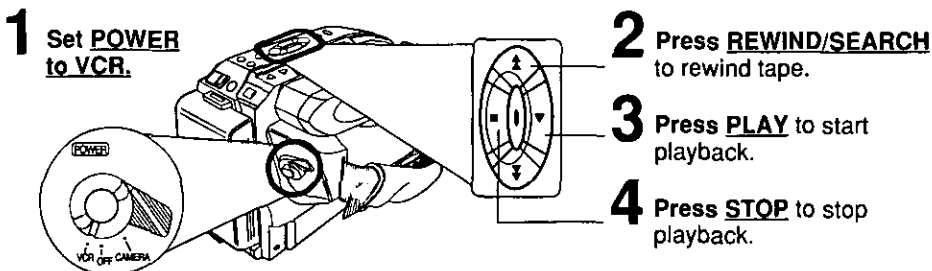

1 Set **POWER** to **VCR**.

2 Press **REWIND/SEARCH** to rewind tape.

3 Press **PLAY** to start playback.

4 Press **STOP** to stop playback.

Supplying Power

Charging the Battery Pack

Charge Battery Pack fully before use.

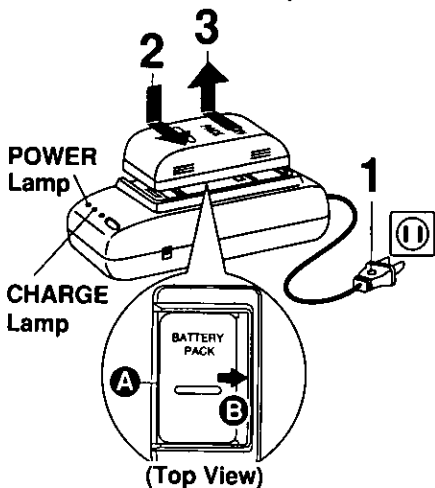

1 Plug in **AC Adaptor**.
POWER Lamp lights.

2 Insert **Battery**.
A Align left side of Battery with left edge of AC Adaptor.
B Press Battery down and slide in direction of arrow.

The CHARGE Lamp flashes, then stays lit when charging is complete.

3 Remove **Battery**.
Slide Battery to the left and lift off.

Note:

- Charging takes about 1 hour.
- While the DC Power Cable (supplied) is connected to the AC Adaptor, the Battery cannot be charged.
- After charging 5 times, use Battery Refresh feature as explained below.
- Battery life gradually decreases after repeated use and recharging. If operation time becomes very short even after a sufficient charge, discard Battery properly (page 9).

Using the Battery Pack

A fully charged Battery provides a maximum of about 1 hour 10 minutes of continuous use. Actual time may vary due to operating conditions. Using the Built-in Light decreases operating time.

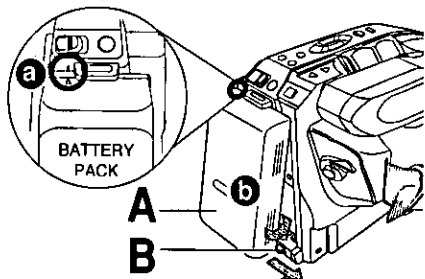

A Attach **Battery**.
a Insert top of Battery into top of mounting surface.
b Press and snap into place.

B Remove **Battery**.
Slide **BATTERY RELEASE** and remove Battery.

Battery Refresh

This feature completely discharges Battery before recharging begins. Use after every 5 charges for optimum Battery performance.

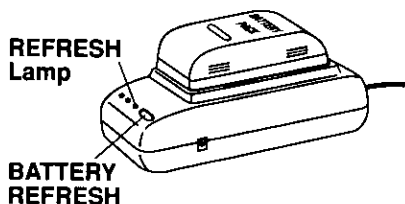

To use battery refresh, insert Battery on AC Adaptor (see steps 1-2 above), then press **BATTERY REFRESH**.

The REFRESH Lamp lights, then goes out when discharge is complete. Battery charging will then start automatically.

If **BATTERY REFRESH** is pressed by mistake, remove Battery from AC Adaptor and reinsert it for normal charging.

Note:

- Charging takes about 5 hours when Battery Refresh is used.
- Battery will not operate in extremely high temperatures.

Battery Care

Caution:

- Charge only with specified charger.
- Battery can be charged within a temperature range of 10 °C (50 °F) and 35 °C (95 °F).
- Battery is normally warm after charging or just after use.
- Do not use an insufficiently charged or worn-out Battery.

Safety precautions:

- Do not get Battery near, or dispose of in, fire.
- Do not directly connect (short circuit) the positive (+) and negative (-) terminals.
- Never attempt to disassemble or reassemble Battery.

To avoid Battery damage:

- Do not drop or jar Battery.
- Use Battery with specified units only.
- If Battery is used in extremely high temperatures, a safety device will automatically prevent operation.

To prolong Battery life:

- While not in use, remove Battery from the Camcorder and AC Adaptor, and store in a cool, dark, dry place.
- Keep Battery terminals clean.

AC Adaptor

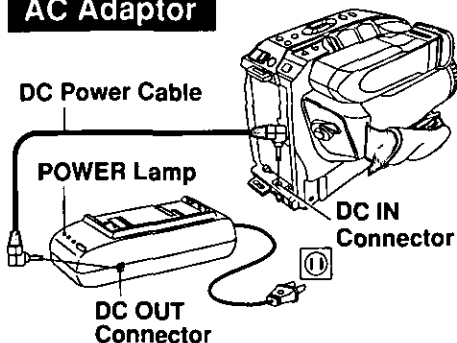

- 1 Connect **AC Adaptor DC OUT** to **Camcorder DC IN** with supplied DC Power Cable.
- 2 Plug in AC Adaptor. POWER Lamp lights.

Note:

- While the DC Power Cable (supplied) is connected to the AC Adaptor, the Battery cannot be charged.
- When not in use, unplug AC Adaptor from AC outlet. (Adaptor uses 1.2 W of electricity while plugged in.)

CAUTION:

This unit will operate on 110/120/220/240 V AC 50/60 Hz. An AC plug adaptor may be required for voltages other than 120 V AC. Please contact either a local or foreign electrical parts distributor for assistance in selecting an alternate AC plug. We recommend using the accessory power plug adaptor (VJSS0070) in an area which has special AC outlets.

Car Battery Cord (Optional)

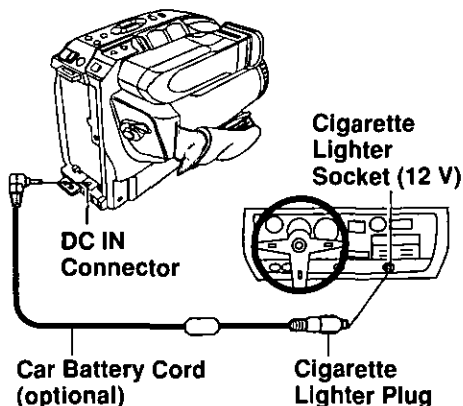

- 1 Connect **PV-C16 Car Battery Cord** (optional) to **Camcorder DC IN**.
- 2

(A) Start engine first.

(B) Plug Car Battery Cord into Cigarette lighter socket.

- If Car Battery cord fuse needs replacing, use exact current rating (in amps).

Note:

- This cord only works in vehicles equipped with **DC 12 V (negative ground)** battery. Check with your car/truck dealer. Use only specified car battery cord.
- To avoid blowing the car battery cord fuse, do step 2 in the proper order.
- Running vehicles must be well ventilated.
- When not in use, disconnect cigarette lighter plug.
- For personal safety the driver of the vehicle should not attempt to operate the camcorder while driving.

Cassette Information

Cassette Insertion/Removal

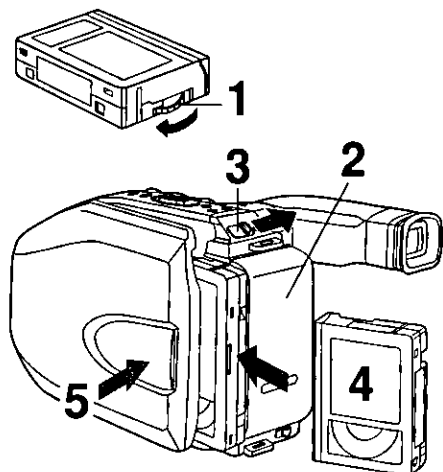

- 1 Turn **Tape Wheel** in direction of arrow until there is no slack.
- 2 Attach **Battery** (page 8).
- 3 Slide **TAPE EJECT** to open door.
- 4 Insert **cassette** as shown.
- 5 Press here to close door.

• To remove the cassette, slide the **TAPE EJECT** switch.

Record/Playback Time

Use tapes with the **VHS** mark in this unit.

Tape Speed Selector Position	Cassette type		
	TC-20	TC-30	TC-40
SP (Standard Play)	20 minutes	30 minutes	40 minutes
SLP (Super Long Play)	1 hour	1 hour 30 minutes	2 hours

• SLP playback may contain more picture noise.

Erase Protection Tab

Protects tapes from being accidentally erased.

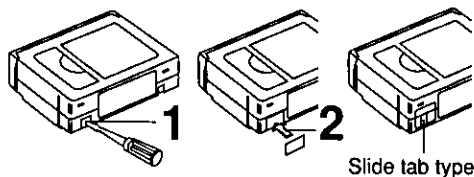

- 1 To prevent accidental erasing, **break off tab** with screwdriver.
(Or, slide tab open.)
- 2 To record again, **cover hole** with adhesive tape.
(Or, slide tab closed.)

How to remove the Sensor tag

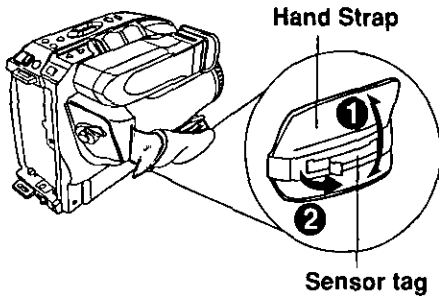

- 1 Open the Hand Strap as illustrated at left.
- 2 Remove the Sensor tag. Then, replace the Hand Strap.

Attaching Shoulder Strap

Remove Battery Pack before completing the following steps:

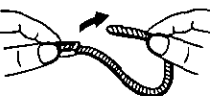
- 1 Undo strap ends from buckles. 
- 2 Thread strap ends through Strap Rings on Camcorder.

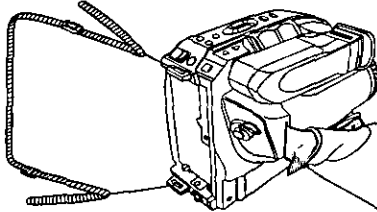

- 3 Re-insert the strap ends into buckles. 
min. 25.4 mm (1 inch)

Adjust the Length of the Shoulder Strap

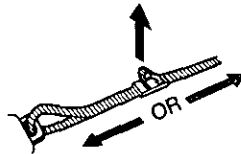

Pull a loop of strap from buckle, then pull strap tight to shorten or lengthen.

Hand Strap

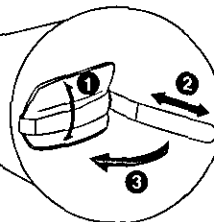

Adjust Hand Strap length to fit your hand as shown.

Lens Cap



Attaching the Lens Cap Strap:
Thread the Strap through the Lens Cap attachment ring as illustrated at left.

Attaching the Lens Cap Cord to the Hand Strap:
Remove the Hand Strap from the front clasp and thread the Strap through the loop in the Lens Cap Cord. Reattach the Hand Strap.

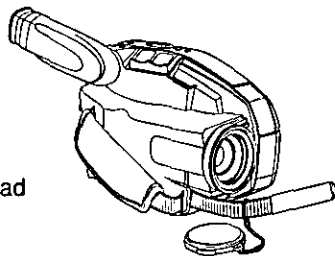

Using MENU Mode

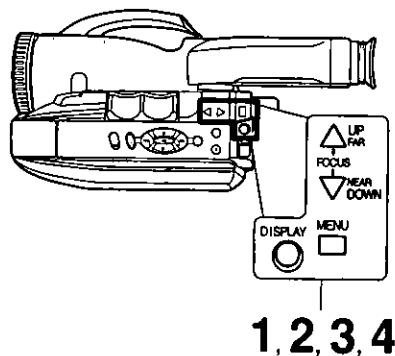

Before you begin...

- Connect Camcorder to power source.
- Set **POWER** to **CAMERA** or **VCR**.

- 1 Press **MENU** for MENU mode.
The **CAMERA** or **VCR MENU** screen (see below left) appears when Menu mode is entered.
- 2 Press **UP** or **DOWN** to highlight the desired menu item.
- 3 Press **DISPLAY** to set selection.
- 4 Press **MENU** to exit.

Note:

- The Menu mode is canceled if **UP/DOWN**, **DISPLAY**, or **MENU** are not pressed within 5 minutes when Self Demo mode is off.
- The Menu mode is canceled if **UP/DOWN**, **DISPLAY**, or **MENU** are not pressed within 30 seconds when Self Demo mode is on.

MENU Mode (CAMERA) Screen

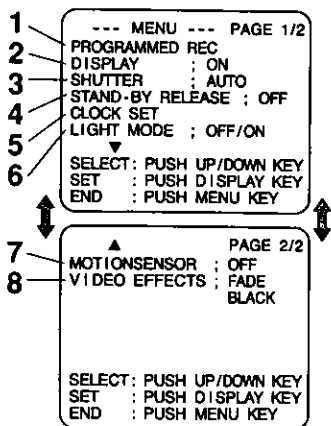

- 1 **PROGRAMMED REC** (page 18).
Camcorder starts and stops recording at a preset time.
- 2 **DISPLAY** (page 29).
ON : On-screen Display (OSD) screens are displayed.
- 3 **SHUTTER** (page 24).
Select desired shutter speed.
- 4 **STAND-BY RELEASE** (page 17).
ON : Enables quick resumption of recording from Stand-by mode.
- 5 **CLOCK SET** (pages 13, 14).
Select to set clock.
- 6 **LIGHT MODE** (page 15).
ON/OFF : Light can be set ON or OFF.
ON/OFF/AUTO : Light can be set ON, OFF, or AUTO.
- 7 **MOTIONSENSOR** (page 28).
ON : Enables MotionSensor recording.
- 8 **VIDEO EFFECTS** (pages 25~26).
AUTO FADE : BLACK or WHITE
DIGITAL FADE : TYPE → 7 types
COLOR → 8 colors

MENU Mode (VCR) Screen

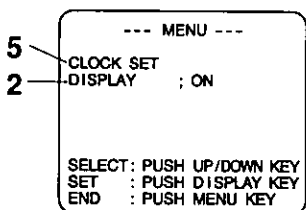

Setting the Clock

Set the following items in order: Time Zone, Daylight Saving Time, Date, and Time.

Before you begin...

- Connect Camcorder to power source.
- Set POWER to CAMERA or VCR.

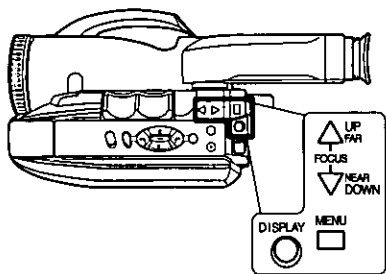

1, 2, 3, 4

- 1 Press **MENU** for MENU mode.
Press **UP** or **DOWN** to select **CLOCK SET**.

```
--- MENU --- PAGE 1/2
PROGRAMMED REC
DISPLAY      : ON
SHUTTER     : AUTO
STAND-BY RELEASE : OFF
CLOCK SET
LIGHT MODE  : OFF/ON
↓
SELECT: PUSH UP/DOWN KEY
SET    : PUSH DISPLAY KEY
END    : PUSH MENU KEY
```

[CAMERA MODE]

```
--- MENU ---
CLOCK SET
DISPLAY    : ON
SELECT: PUSH UP/DOWN KEY
SET       : PUSH DISPLAY KEY
END       : PUSH MENU KEY
```

[VCR MODE]

- 2 Press **DISPLAY** for **CLOCK SET** menu.
Press **UP** or **DOWN** to select **TIME ZONE**, **DST**, or **DATE/TIME**.

```
--- CLOCK SET ---
TIME ZONE : EASTERN
D.S.T.     : AUTO
DATE/TIME  : 12:00:00AM
            JAN 1 2002
SELECT: PUSH UP/DOWN KEY
SET    : PUSH DISPLAY KEY
END    : PUSH MENU KEY
```

- 3 Press **DISPLAY** for menu of item selected in step 2.

To change the setting:

TIME ZONE → Go to step 3a on page 14.

D.S.T. → Go to step 3b on page 14.

DATE/TIME → Go to step 3c on page 14.

- 4 Press **MENU** twice to exit.

(continued on next page)

Setting the Clock

3a Setting the Time Zone

The Camcorder is preset to Eastern time.

[Time Zone chart]

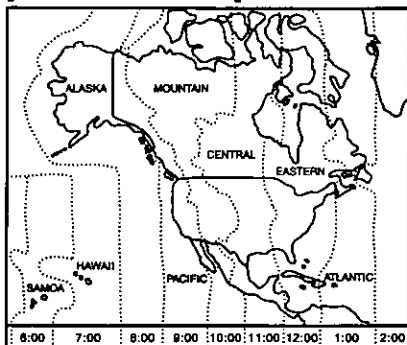

Press **UP** or **DOWN** to select local time zone.

Press **DISPLAY** to confirm entry.

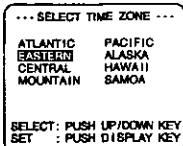

- When traveling, repeat this operation and select one of the 8 listed time zones to set the clock to local time.

Note :

- Clock may lose or gain up to 2 minutes per month.
- When traveling outside the listed time zones, set clock to local time manually.
- To adjust or set clock, see "Setting Date and Time" bottom of page.

3b Auto Daylight Saving Time

Clock will auto-adjust to daylight saving time (DST).

DST: AUTO

Spring (First Sunday in April) : ahead one hour.

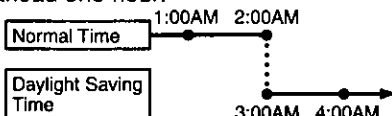

Autumn (Last Sunday in October) : back one hour.

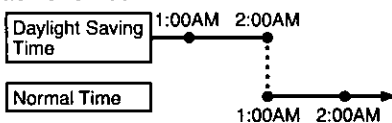

The Camcorder is preset to DST: **AUTO**. If DST is not observed in your area, set to **OFF** by doing the following.

Press **UP** or **DOWN** to select OFF or AUTO.

Press **DISPLAY** to confirm entry.

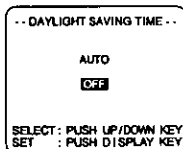

Note:

- Auto DST does not function if time zone is set to Hawaii or Samoa (see "Setting the Time Zone" above).

3c Setting Date and Time

Date and time including leap year are calculated up to DEC 31, 2099.

EXAMPLE :

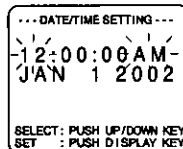
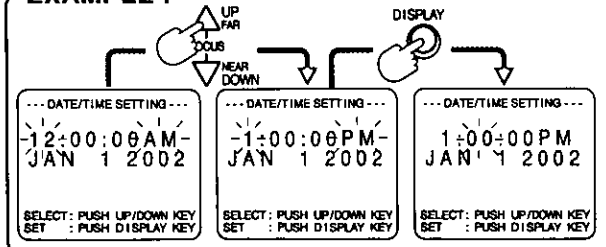

Press or hold down **UP** or **DOWN** to select hour, then press **DISPLAY** to fix.

Repeat for minute, month, day, and year.

Clock starts when year is entered and **DISPLAY** is pressed.

Built-in Auto Light

Using the Light

For recording in dim lighting.

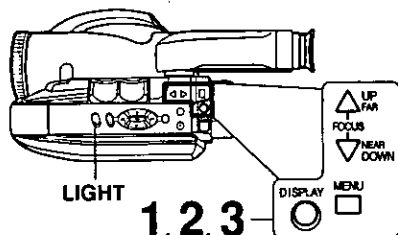

CAUTION:
Light becomes hot.
Never cover Light while on.

Note:

- Using Light reduces battery operating time.
- Provide proper ventilation when using Light extensively in a hot environment.
- Using Light when the Camcorder is powered by a car battery may shorten bulb life.
- Set Light to OFF when not in use.

Replacing the Bulb

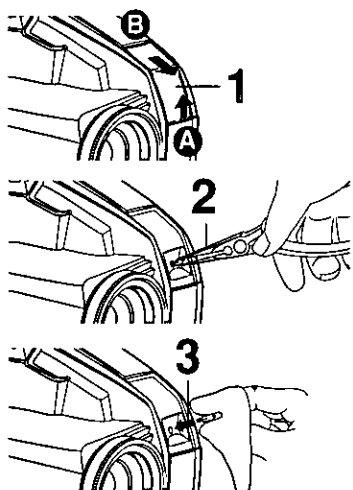

DANGER:

Use only replacement bulb (PART NO. VLLW0015) supplied by Panasonic to reduce risk of fire.
Handle new bulb with cloth or tissue as skin oils will decrease bulb life.
Remove lens cover and allow bulb to cool before replacing to avoid possible burn hazard.

Before you begin...

- Connect Camcorder to power source.
- Set POWER to CAMERA.

1 Press **MENU** for MENU mode. Press **UP** or **DOWN** to select **LIGHT MODE**.

2 Press **DISPLAY** to set OFF/ON or OFF/ON/AUTO. Press **MENU** to exit.

3 Press **LIGHT** repeatedly for Light ON, OFF, or AUTO.
• In AUTO, light turns itself on/off according to lighting conditions.

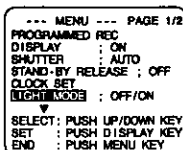

EVF Indications

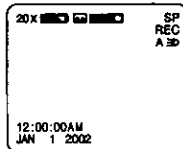

⇒D : Light is on.

A ⇒D : Light mode is auto.

Before you begin...

- Order Part No. VLLW0015 for replacement bulb.
- Set POWER to OFF.

1 Slightly raise portion **A** of lens cover to unhook, and slide portion **B** forward to remove.

2 Using Tweezers or needle-nose pliers, carefully remove bulb.
• Take unit to service center if you need assistance.

3 Replace bulb using a clean cloth or tissue. (Do not touch with fingers.)

4 Replace lens cover.

Note:

- Handle bulb gently. Excessive force may cause bulb to crack.

Camera Recording

Recording via EVF

View recording scene on EVF (Electronic Viewer Finder).

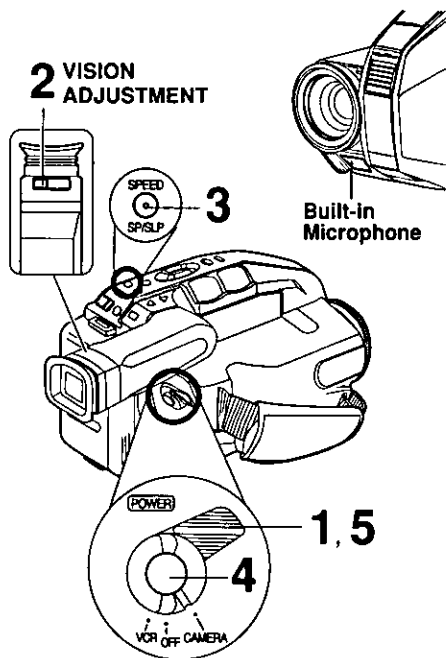

Before you begin...

- Connect Camcorder to power source.
- Insert cassette with record tab (page 10).

- 1** Set **POWER** to **CAMERA**.
- Be sure **POWER** is fully turned to **CAMERA** position.
 - **EVF** turns on/off by the **POWER** switch.

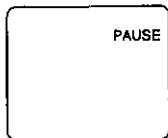

EVF Indication
(Record/Pause mode)

- 2** Look into **EVF** and adjust **VISION ADJUSTMENT** to your eyesight.

- 3** Hold down **TAPE SPEED** for about 1 second to change tape speed to **SP/SLP** (page 10).

- 4** Press **RECORD/PAUSE** to start or pause recording.

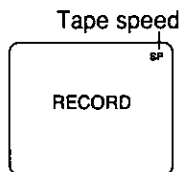

EVF Indication
(Record mode)

- 5** Set **POWER** to **OFF** when finished.

- To remove the cassette, slide the **TAPE EJECT** switch (page 10).

Note:

- When Camcorder is aimed at excessively bright objects, or bright lights, a vertical bar may appear in the picture. This is normal for the CCD pick-up. Try to avoid this when possible.

Before you begin...

- Connect Camcorder to power source.
- Insert cassette with record tab (page 10).

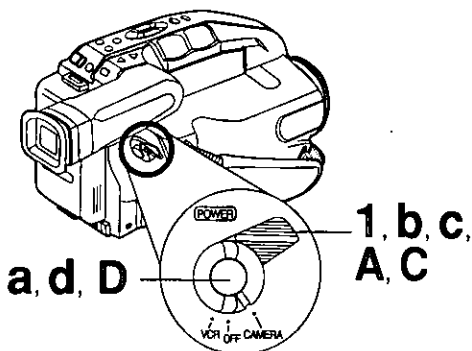
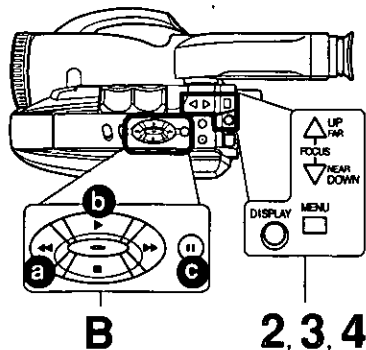

Stand-by Quick Release

If left in RECORD/PAUSE mode for 5 minutes, Camcorder switches to Stand-by mode to conserve battery. When set to ON, Stand-by Quick Release lets you resume recording by pressing **RECORD/PAUSE** two times. Stand-by Quick Release is set to OFF at the factory.

1 Set **POWER** to **CAMERA**.

2 Press **MENU** for MENU mode.

Press **UP** or **DOWN** to select **STANDBY RELEASE**.

3 Press **DISPLAY** to select ON/OFF.

ON : From Stand-by mode, press **RECORD/PAUSE** two times to resume recording.

OFF : From Stand-by mode, set **POWER** to **OFF**, then to **CAMERA**. Press **RECORD/PAUSE** to record.

4 Press **MENU** to exit.

---	MENU	---	PAGE 1/2
PROGRAMMED REC	:	ON	
DISPLAY	:	AUTO	
SHUTTER	:	OFF	
STANDBY RELEASE	:	OFF	
CLOCK SET	:		
LIGHT MODE	:	OFF/ON	
SELECT:	PUSH UP/DOWN KEY		
SET	:	PUSH DISPLAY KEY	
END	:	PUSH MENU KEY	

Manual Easy Editing

For proper continuity when taping from Stop mode or after attaching a new Battery.

A Set **POWER** to **VCR**.

B **a** Press **REWIND/SEARCH** to rewind a few seconds of tape.

b Press **PLAY** to review recording.

c Press **STILL** where you want to continue recording.

C Set **POWER** to **CAMERA**.

D Press **RECORD/PAUSE** to resume recording.

Easy Edit Stand-by

For a smooth transition between scenes if recording is stopped, and then started within 24 hours.

a Press **RECORD/PAUSE** to stop recording.

b Set **POWER** to **OFF** and leave cassette in Camcorder.

C To resume recording, set **POWER** to **CAMERA**.

d Press **RECORD/PAUSE** to resume recording.

Note:

- Use Manual Easy Edit (left) if more than 24 hours before recording is resumed.

Camera Recording

Programmed Recording

Set a recording start and stop time. Or, set a 5 or 10 second interval recording to be done each minute.

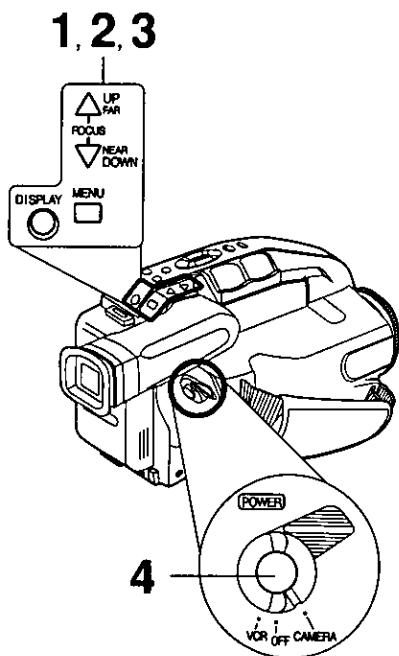

REC TIME : _____

→ 10MIN. → 20MIN. → 30MIN. →
INTERVAL*2 ← INTERVAL*1 ← TO TAPE ←
10SEC/MIN. ← 5SEC/MIN. ← END

*1 Record 5 seconds each minute.

*2 Record 10 seconds each minute.

Before you begin...

- Connect Camcorder to power source.
Use AC Adaptor for longer recordings.
- Insert cassette with record tab (page 10).
- Set **POWER** to **CAMERA**.

1 Press **MENU** for MENU mode. Press **UP** or **DOWN** to select **PROGRAMMED REC.**

```
--- MENU --- PAGE 1/2
PROGRAMMED REC
DISPLAY : ON
SHUTTER : AUTO
STAND-BY RELEASE : OFF
CLOCK SET
LIGHT MODE : OFF/ON
↓
SELECT : PUSH UP/DOWN KEY
SET : PUSH DISPLAY KEY
END : PUSH MENU KEY
```

2 Press **DISPLAY**.
(Current time is displayed.)
Each additional press of **DISPLAY** increases start time by 30 minutes.

```
START : 10:20PM
REC TIME : 10MIN.

SELECT : PUSH UP/DOWN KEY
SET : PUSH DISPLAY KEY
START : PUSH RECORD KEY
CANCEL : PUSH MENU KEY

10:20:00PM
```

3 Press **DOWN** to select **REC TIME**. Press **DISPLAY** repeatedly to select one of the options shown at left.

```
START : 10:20PM
REC TIME : 10MIN.

SELECT : PUSH UP/DOWN KEY
SET : PUSH DISPLAY KEY
START : PUSH RECORD KEY
CANCEL : PUSH MENU KEY

10:20:00PM
```

To cancel the setup, press **MENU** twice.

4 Press **RECORD/PAUSE** to place Camcorder in stand-by mode.

```
STAND-BY
START : 10:20PM
REC TIME : 10MIN.

10:20:00PM
JUN 1 2002
```

Recording will be done as scheduled.

Note:

- Start time may not be set over 24 hours from current time.
- Camcorder shuts off at tape end, or 12 hours after Interval Recording starts.
- To cancel, set **POWER** to **OFF**.

Playing Back Recordings

Before you begin...

- Connect Camcorder to power source.
- Insert recorded tape.

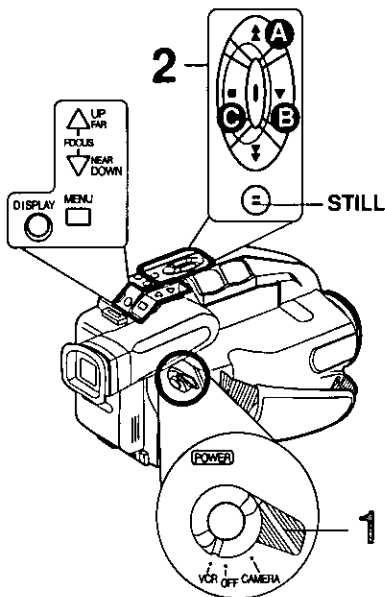

Playback on EVF

1 Set **POWER** to **VCR**.

- If tape has no record tab, auto playback begins.
- EVF turns on/off by the POWER switch.

2 Playback function buttons.

- A** **REW** : Rewind tape.
- B** **PLAY** : Play tape.
- C** **STOP** : Stop tape.

Tracking Control

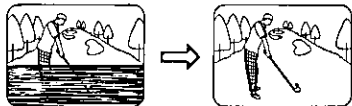

Auto Tracking

Continuously analyzes each recording for optimum picture quality.

Manual Tracking

Some recordings require manual adjustment to reduce noise.

Press **UP** or **DOWN** until Playback picture clears up.

Press **DISPLAY** to return to Auto Tracking.

Special Effects

Quick Visual Search

Search Speed

- SP (Standard Play) : 3 times normal.
- SLP (Super Long Play) : 9 times normal.

During playback, press:

- **FF** : fast forward search
- **REW** : rewind search
Press again or press **PLAY** for normal play.

Still Picture

Press **STILL** to freeze picture.

Press again for normal play.

This feature works best in SLP mode (page 10).

Note:

- During search, horizontal noise bars will appear. Audio is muted.
- To protect video heads and tape, operating modes will revert as follows after 5 minutes:
Still → Stand-by
Stand-by → Power off (when Battery Pack is used).
- Tape auto-rewinds if played or fast forwarded to end.

Playing Back Recordings

TV Playback or Viewing

Connect Camcorder to a TV to view playback or recordings in progress.

Connections

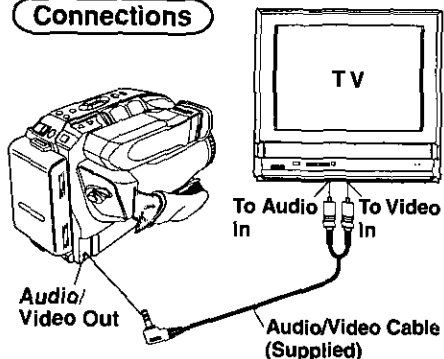

Before you begin...

- Connect Camcorder to power source.
- Make all TV-Camcorder connections.

- 1** Set **POWER** to:
VCR → view playback.
CAMERA → view picture as it is recorded.
- 2** Turn TV **ON** and set to **LINE INPUT**. See TV owner's manual.
- 3** Begin playback or recording.

VCR Playback using PlayPak (Optional)

Load Battery in PlayPak

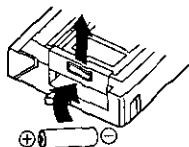

Remove Battery lid and insert AA battery.

- Do not reverse polarity.
- Replace battery when tape loading/unloading takes longer than usual.

Insert VHS[®] Cassette in PlayPak

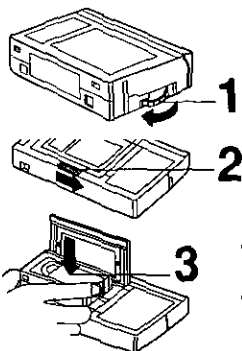

1 Turn **VHS** cassette **Tape Wheel** in direction of arrow to take up any slack.

2 Slide **RELEASE** to open cassette lid.

3 Insert the **VHS** cassette with the window up and on the left, then snap lid shut.

- Do not obstruct cassette reel while loading.
- Allow PlayPak Load Detector to fully retract before using in VHS VCR.

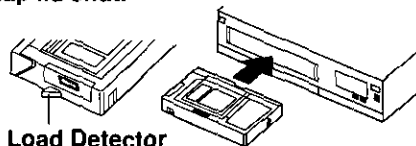

Remove VHS[®] Cassette

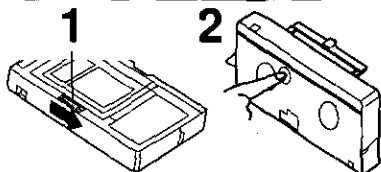

1 Slide **RELEASE** and wait for lid to open.

2 Push cassette out through hole in bottom of PlayPak with your finger.

Copying your Tapes (dubbing)

Connections

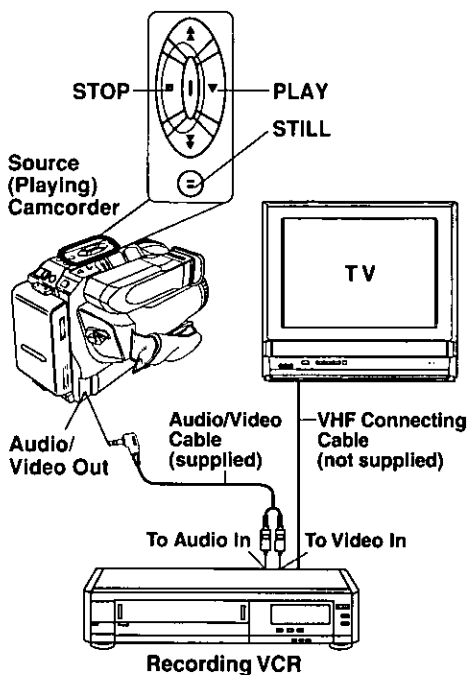

Before you begin...

- Make Camcorder-VCR connections (see left).
- Turn both units on.
- Set VCR input signal to LINE.
Please see VCR owner's manual.
- Set Camcorder POWER to VCR.

- 1** Insert a pre-recorded tape into Camcorder and a blank tape with record tab into VCR.
- 2** Press PLAY on Camcorder, then press STILL at starting point.
- 3** Press REC, then STILL/PAUSE on VCR.
- 4** Press STILL on Camcorder and STILL/PAUSE on VCR to start copying.
- 5** Press STOP on both units to stop copying.

Note:

- Camcorder will only playback tapes recorded in SP or SLP mode.
- Dubbing may reduce picture quality.

CAUTION:

Unauthorized exchanging and/or copying of copyrighted recordings may be copyright infringement.

Monitor with your TV

- Turn TV on and tune to VCR channel (CH3 or CH4).
- Set TV/VCR Selector on VCR to VCR.

Four-Speed Power Zoom

Zoom in (close up) and out (wide angle) in one of four speeds ranging from slow (16 seconds) to fast (2 seconds).

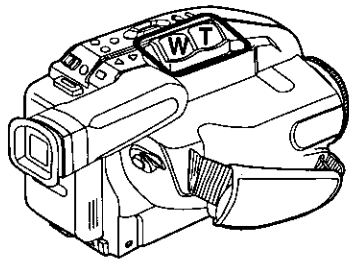

Before you begin...

- Connect Camcorder to power source.
- Set POWER to CAMERA.

Zoom In ("T")

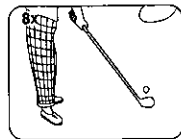

Zoom Out ("W")

• Zoom slowly:

Lightly press "T" (telephoto) or "W" (wide angle) POWER ZOOM button.

• Zoom quickly:

Apply more pressure to the button.

Backlight

Use when subject is darker than surroundings, in shadowed area, or in front of the light source.

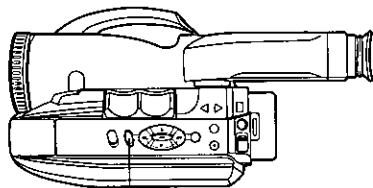

B.LIGHT

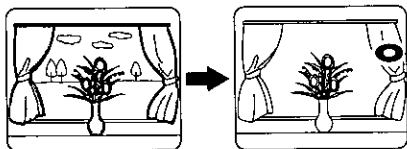

Press B.LIGHT.

Before you begin...

- Connect Camcorder to power source.
- Set POWER to CAMERA.

Press **B.LIGHT** while recording to select the level of backlight compensation.

In normal lighting, press **B.LIGHT** repeatedly until no indicator is displayed.

EVF Indications

→ Normal (No Indication)

● First press (Low)

○ Second press (Medium)

○ Third press (High)

○ Fourth press

Before you begin...

- Connect Camcorder to power source.
- Set POWER to CAMERA.

Auto Focus

Camcorder automatically focuses on subject even during zooming.

Auto Focus is on when "MF" is not displayed in EVF.

Press **M.FOCUS** to remove "MF" in EVF if necessary.

Manual Focus

Use Manual Focus (MF) when :

- recording through glass.
- lighting is poor.
- subject is far away with objects in foreground.
- subject has distinct horizontal lines.
- subject is not centered in EVF.
- subject has a shiny surface.
- subject is slanted.
- subject is bright and flat, like a white wall.
- subject has fast motion, like a golf swing.

EVF Indication

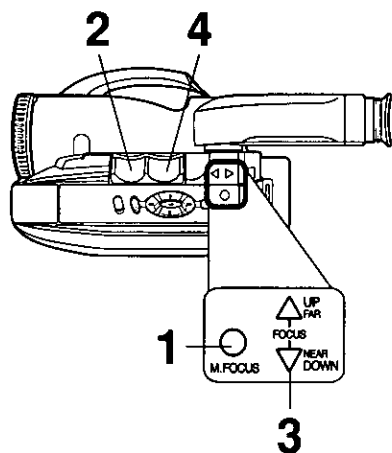
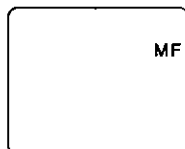

1 Press **M.FOCUS** so "MF" (Manual Focus) appears in EVF.

2 Hold down **"T" (telephoto)** on POWER ZOOM to maximum zoom in.

3 Press **UP (FAR)** or **DOWN (NEAR)** until subject is in focus.
• Back away from subject if necessary.

4 Hold down **"W" (wide angle)** on POWER ZOOM as desired.

• **Refocus as needed** when aiming at new scenes.

Macro Focus (close-ups)

Auto Focus functions up to 12.7 mm (1/2 inch) from subject.

Hold down **"W"** on POWER ZOOM to maximum wide angle.

Bring Camcorder up close to the subject.

High Speed Shutter

Improves Still or Slow Motion playback picture of high speed subjects (e.g. a tennis stroke), when viewed on Camcorder or 3 or 4 head VCR.

Before you begin...

- Connect Camcorder to power source.
- Insert cassette with record tab (page 10).
- Set POWER to CAMERA.

Auto Shutter

In AUTO mode (no indication in EVF), shutter speed is auto-adjusted from 1/60 to 1/350 according to subject brightness.

- AUTO mode is selected each time POWER is set to CAMERA.

Manual Selection

The faster the shutter speed, the more light is needed for proper picture and color quality. High Speed Shutter indication flashes if light is inadequate. Provide additional light.

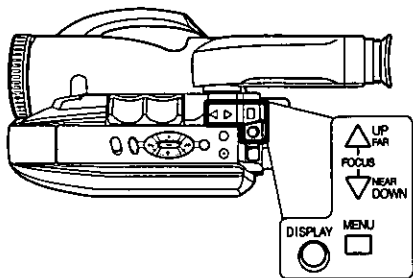

1, 2, 3

- 1 Press **MENU** for MENU mode.
Press **UP** or **DOWN** to select **SHUTTER**.

- 2 Press **DISPLAY** repeatedly to select shutter speed.

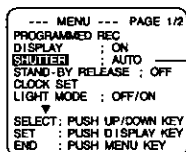

→ AUTO → 1/60 → 1/100 → 1/250 → 1/500
← 1/10000 ← 1/4000 ← 1/2000 ← 1/1000 ←

- 3 Press **MENU** to exit.

Note:

- Shutter speed cannot be set to 1/60 if Digital E.I.S. feature is set to ON.
- Provide additional halogen or tungsten light for use indoors or in poor light. Fluorescent light degrades picture.
- Auto Focus may not function properly if high speed shutter is used in inadequate light.
- Setting reverts to AUTO each time POWER is set to CAMERA.

Auto Fade

An interesting way to open and close scenes.

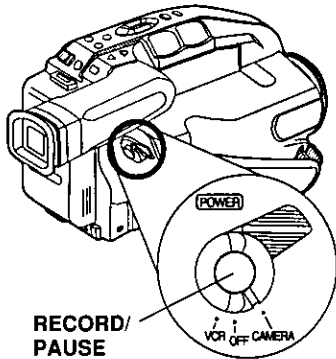
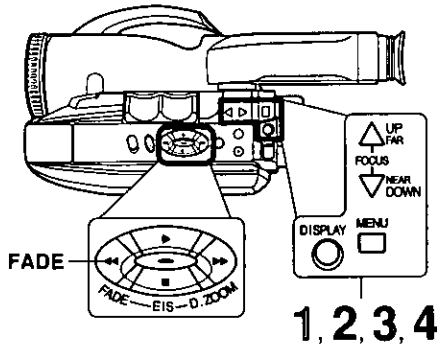

Before you begin...

- Connect Camcorder to power source.
- Set POWER to CAMERA.

1 Press **MENU** for MENU mode.
Press **UP** or **DOWN** to select **VIDEO EFFECTS**.

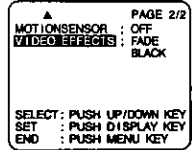

2 Press **DISPLAY** for VIDEO EFFECTS menu. Press **UP** or **DOWN** to select **AUTOFADE**.

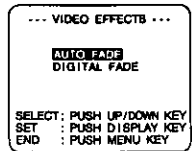

3 Press **DISPLAY** for AUTO FADE ; COLOR menu.
Press **UP** or **DOWN** to select BLACK or WHITE.

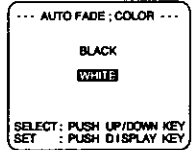

4 Press **DISPLAY** to confirm entry.
Press **MENU** to exit.

Fade In:

In **RECORD/PAUSE** mode, press **FADE** so "FADE" flashes in EVF.

Press **RECORD/PAUSE**.

Recording starts as picture and sound gradually fade in.

Fade Out:

While recording, press **FADE** so "FADE" flashes in EVF.

Press **RECORD/PAUSE**.

Picture and sound gradually fade out, and recording is paused.

If **FADE** is pressed accidentally, press again so "FADE" disappears in EVF.

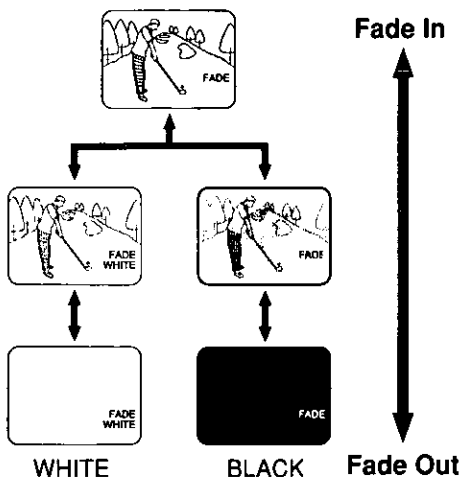

Color Digital Fade

Choose from 7 fade effects in 8 different colors.

Before you begin...

- Connect Camcorder to power source.
- Set POWER to CAMERA.

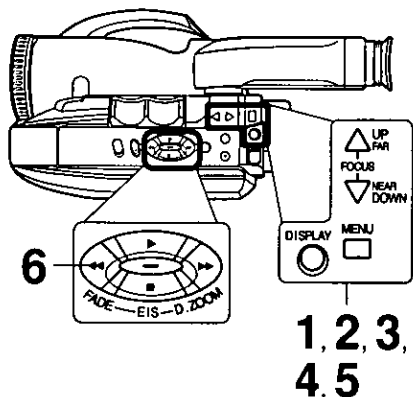

- 1** Press **MENU** for MENU mode.
Press **UP** or **DOWN** to select **VIDEO EFFECTS**.

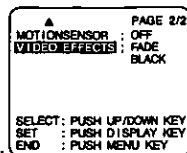

- 2** Press **DISPLAY** for VIDEO EFFECTS menu.
Press **DOWN** to select **DIGITAL FADE**.

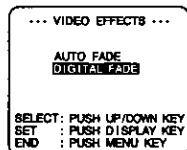

- 3** Press **DISPLAY** for DIGITAL FADE menu.
Press **UP** or **DOWN** to select **TYPE**.
Press **DISPLAY** for TYPE menu.
Press **UP** or **DOWN** to select from 7 different types of fades.
• A preview of each fade type is displayed as it is selected.

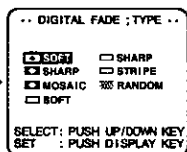
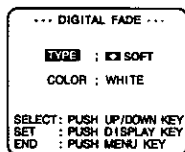

- 4** Press **DISPLAY** for DIGITAL FADE menu.
Press **DOWN** to select **COLOR**.
Press **DISPLAY** for COLOR menu.
Press **UP** or **DOWN** to select from 8 colors.
• A preview of each color is displayed as it is selected.

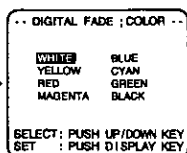
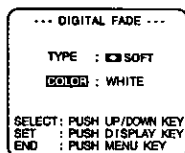

- 5** Press **DISPLAY** to confirm entry.
Press **MENU** twice to exit.

- 6** Press **FADE** for about 2 seconds to fade out during recording (selected fade type flashes). Press **FADE** again to fade in.

EVF Indications

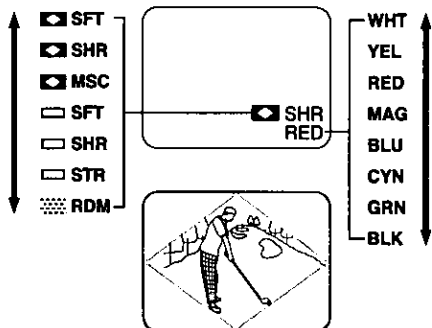

- For more effects, stop fade in or fade out at any time (except RANDOM mode) by pressing **FADE**. Then, press **FADE** to resume fade.

Note:

- Audio is not affected by fade.
- To cancel Digital Fade, do steps 1, 2, and 5. In step 2, select AUTO FADE.

Power Zoom magnification is digitally increased.

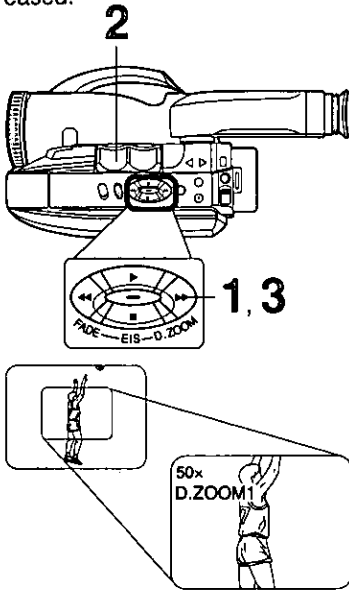

Before you begin...

- Connect Camcorder to power source.
- Set POWER to CAMERA.

1 Press D. ZOOM.
 once → D.ZOOM 1 (150x maximum)
 twice → D.ZOOM 2 (700x maximum)
 The Higher digital magnification levels may cause picture distortion.

2 Hold down "T" on POWER ZOOM.
 Digital Zoom starts when normal zoom reaches maximum (20x).
 • Zoom level appears in EVF.
 • POWER ZOOM switch controls digital zoom level.
 • Normal zoom resumes when level falls to 20x.

3 Press D. ZOOM to turn off Digital Zoom so no indication appears.

Digital Electronic Image Stabilization (E.I.S.)

Helps stabilize picture when recording in unstable situations.

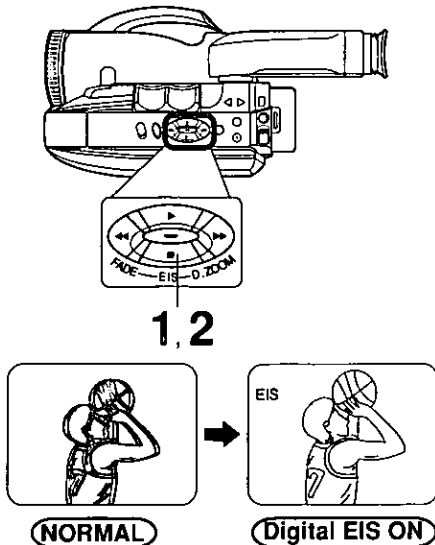

Before you begin...

- Connect Camcorder to power source.
- Set POWER to CAMERA.

1 Press EIS to display "EIS" in the EVF.
 • Image becomes slightly enlarged and shutter speed auto-adjusts from 1/80 to 1/350 according to brightness.
 • Use High Speed Shutter (page 24) if needed. Shutter speed setting remains after EIS is canceled.

2 Press EIS again to cancel when not in use.

E.I.S. may not function during...

- extreme Camcorder movement.
- recording of subjects with distinct horizontal or vertical stripes.
- low light situations (EIS indicator flashes).
- intense fluorescent lighting situations.
- recording of very fast motion.

MotionSensor

Recording starts automatically if motion is detected.

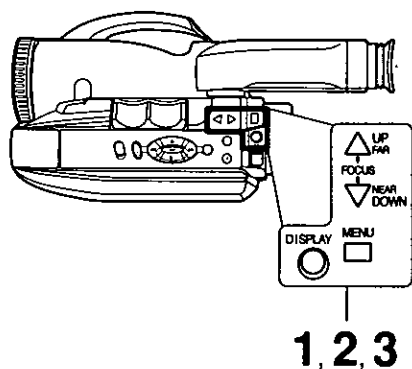

Before you begin...

- Connect Camcorder to power source. Use AC Adaptor for longer recordings.
- Insert cassette with record tab (page 10).
- Set POWER to CAMERA.
- Securely position and aim Camcorder.

- 1 Press **MENU** for MENU mode. Press **UP** or **DOWN** to select **MOTIONSENSOR**.

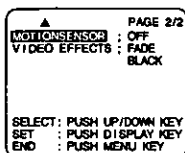

- 2 Press **DISPLAY** to select ON.

- 3 Press **MENU** for MotionSensor stand-by mode. (If cassette is not inserted, " " will flash.)

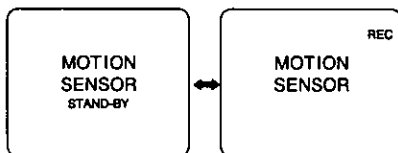

MotionSensor may mistakenly start when:

- background is plain, like a white wall, or has distinct vertical, horizontal, or slanted stripes, like a venetian blind.
- brightness suddenly changes.

MotionSensor may not start when:

- motion is very slow or fast.
- moving object is very small.
- motion occurs only in 1 corner of viewing area.
- in poor lighting (in this case, MOTIONSENSOR flashes).
- background is plain, like a white wall, or has distinct horizontal or vertical stripes.

- Recording will start about 3 seconds after motion is detected.
- Date and time are recorded if displayed in EVF (page 14).
- Recording stops about 30 seconds after motion ceases.

To cancel MotionSensor Mode, set **POWER to OFF**.

Note:

- MotionSensor recording starts if Camcorder is bumped or repositioned.
- This feature is not available during normal recording.
- While in MotionSensor stand-by, the following functions are not available: Record/Pause, Stand-by mode, Digital E.I.S., Video Effects (Auto/Digital Fade).

Electronic Viewfinder Indications

Tape remaining and battery charge level can be displayed.

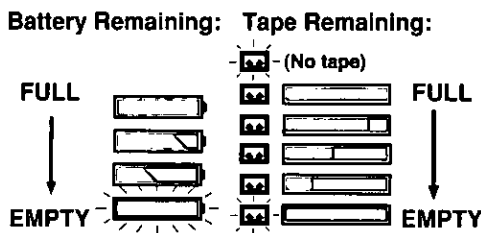
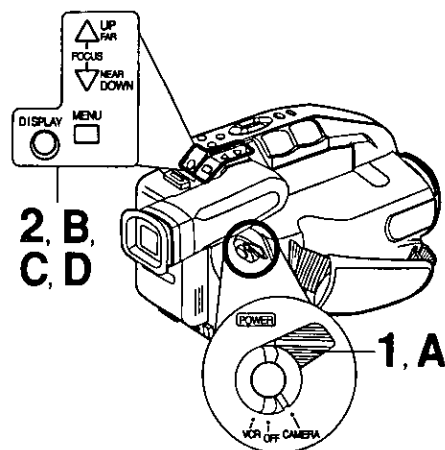

Before you begin...

- Connect Camcorder to power source.

- 1 Set **POWER** to **CAMERA**.
- 2 Press **DISPLAY** repeatedly to select the following displays.

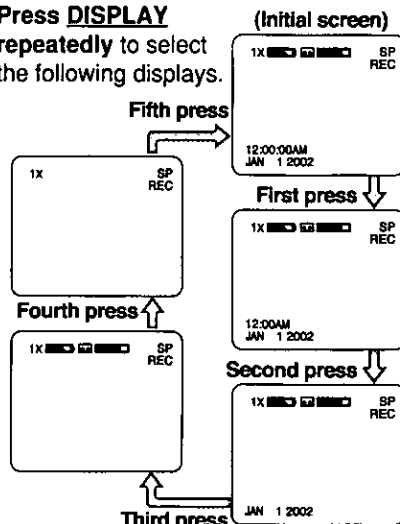

- Tape remaining indicator operates a few seconds after tape starts moving.

Recording the Date and Time

- Do steps 1 and 2 above to select time/date, date only, or no display.
- Start a recording (page 16).
 - Only the Date and/or Time are recorded.

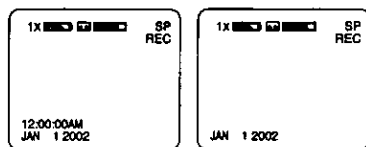

Display-Off Mode

- Set **POWER** to **CAMERA** or **VCR**.
- Press **MENU** for MENU mode.
Press **UP** or **DOWN** to select **DISPLAY**.
- Press **DISPLAY** to select OFF.
Press **MENU** to exit.
- Press **DISPLAY** repeatedly to remove time/date.

--- MENU --- PAGE 1/2
PROGRAMMED REC
DISPLAY : ON
SHUTTER : AUTO
STAND-BY RELEASE : OFF
CLOCK SET
LIGHT MODE : OFF/ON
SELECT: PUSH UP/DOWN KEY
SET : PUSH DISPLAY KEY
END : PUSH MENU KEY

[CAMERA MODE]

--- MENU ---
CLOCK SET
DISPLAY : ON
SELECT: PUSH UP/DOWN KEY
SET : PUSH DISPLAY KEY
END : PUSH MENU KEY

[VCR MODE]

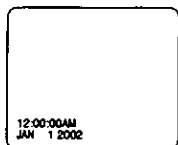



Indications are restored the next time Camcorder is turned on.

Electronic Viewfinder Indications

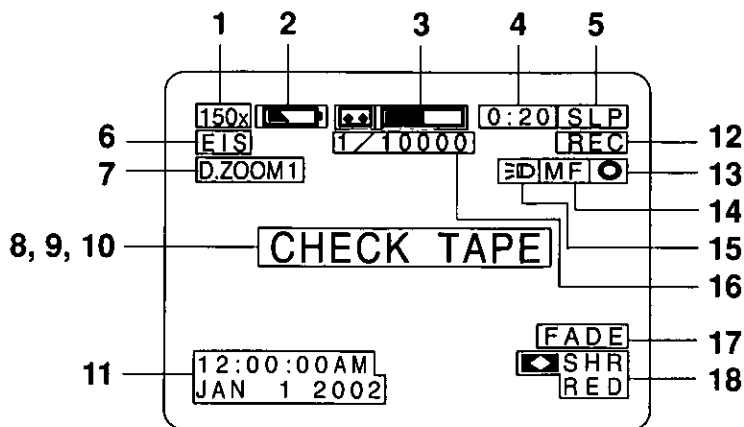
CAMERA/VCR mode



- 1 **Zoom Magnification level** (pages 22, 27).
- 2 **Battery Remaining**  (page 29).
"WARNING LOW BATTERY" appears and Camcorder shuts off after 15 seconds.
- 3 **Tape Remaining** (page 29).
" flashes and "TAPE END" appears for 5 seconds when:
• End of tape is reached.
" flashes for 1 minute and "CHECK TAPE" appears for 5 seconds when:
• RECORD/PAUSE is pressed with no cassette, or cassette has no record tab in Camera (RECORD) mode.
• PLAY, FF or REW is pressed with no cassette inserted in VCR mode.
- 4 **10-Second Reminder**
Each time a recording is started, a 10 second incremental display (up to 59:50) lets you monitor how long one scene is recorded.
0:00 0:10 0:20 59:50
↑
(return to 0:00 and continue)
- 5 **TAPE SPEED** (pages 10, 16).
(SP=standard play,
SLP=super long play).
- 6 **Digital E.I.S.** (page 27).
- 7 **Digital Zoom** (page 27).
- 8 **VCR-MODE**
"VCR-MODE" appears for 1 minute when POWER is set to VCR or if RECORD/PAUSE is pressed in VCR mode.
- 9 **DEW**
If moisture condensation occurs in unit, "WARNING DEW DETECTED" appears, and Camcorder will shut off in 15 seconds. Wait until "WARNING" no longer indicates when Camcorder is turned on to use.
- 10 **MotionSensor** (page 28).
- 11 **Date and Time** (pages 13, 14).
- 12 **Operating Mode**
 - REC (record) • PAUSE
 - FF (fast forward) • PLAY
 - REW (rewind)
- 13 **Backlight** (page 22).
- 14 **Manual Focus** (page 23).
- 15 **Light ON/OFF/AUTO** (page 15).
- 16 **High Speed Shutter** (page 24).
- 17 **Fade** (page 25).
- 18 **Color Digital Fade** (page 26).

Operation Notes

Cleaning EVF (Electronic Viewer Finder)

To Remove

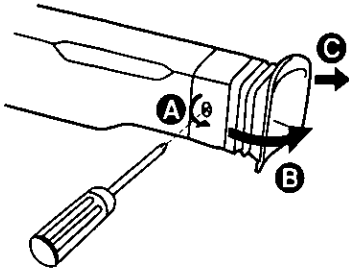

- 1**
 - A** Remove the screw with a Phillips screwdriver.
Turn counterclockwise.
 - B** Turn the EVF Eyepiece.
 - C** Pull the EVF Eyepiece.
- 2** Remove any lint or dust particles with a soft clean cloth being careful not to scratch the glass surfaces.
- 3** Replace the EVF Eyepiece and the screw.

Notice

This product utilizes both a Cathode Ray Tube (CRT) and other components that contain lead. Disposal of these materials may be regulated in your community due to environmental considerations. For disposal or recycling information please contact your local authorities, or the Electronics Industries Alliance: <<http://www.eiae.org>>

ATTENTION :



A nickel cadmium battery that is recyclable powers the product you have purchased. At the end of its useful life, under various state and local laws, it is illegal to dispose of this battery into your municipal waste stream. Please call 1-800-8-BATTERY for information on how to recycle this battery.

For Your Information

Replacing Clock Battery

The clock battery is pre-installed. Follow the steps below if replacement becomes necessary.

WARNING:

Replace battery with Panasonic PART NO. VSBW0004 (CR2025) only. Use of another battery may present a risk of fire or explosion.

Caution: Battery may explode if mistreated. Dispose of used battery promptly. Keep away from children. Do not recharge, disassemble or dispose of in fire.

Clock Battery

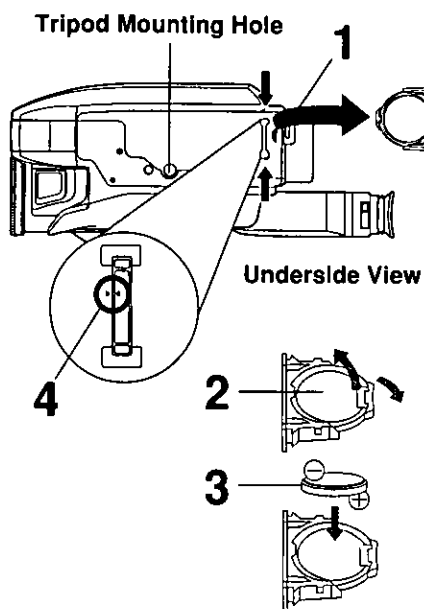

- 1** While pinching the 2 tabs, pull Battery Tray out.
- 2** Bend middle tab out and remove Battery.
- 3** Snap new Battery (⊕ mark down) into Battery Tray.
 - Do not reverse the polarity.
- 4** Insert Battery Tray so the triangle marks meet.







Note:

- Keep Battery out of children's reach. Swallowing it may be harmful.
- Improper installation, discharge, or missing battery causes "CLOCK BATTERY" to appear when DISPLAY is pressed.
- Battery life is approximately 5 years.

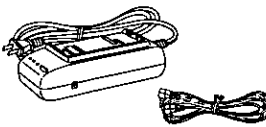
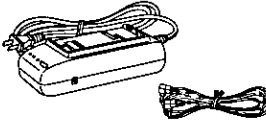
Palmcorder Accessory System

To order instructions, see the Accessory Order Form page.

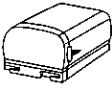
• The listed standard battery use times are based on continuous recording using this Palmcorder.

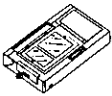
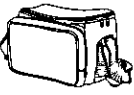
Accessory #	Figure	Description	Price
PV-A19		AC Adaptor with DC Power Cable (Charging of the Nickel Cadmium Battery or Nickel Metal Hydride Battery)	Call For Pricing
PV-A20		AC Adaptor with DC Power Cable (Charging of the Nickel Cadmium Battery or Nickel Metal Hydride Battery)	Call For Pricing
HHR-V60A/1B		Up to 6 hr Battery Pack (Rechargeable Nickel Metal Hydride Battery)	\$119.95
HHR-V40A/1B		Up to 4 hr Battery Pack (Rechargeable Nickel Metal Hydride Battery)	\$69.95
HHR-V20A/1B		Up to 2 hr Battery Pack (Rechargeable Nickel Metal Hydride Battery)	\$59.95
PV-AA6		"AA" Battery Case	\$20.00
PV-C16		Car Battery Cord	\$70.00
PV-P1		VHS PlayPak	\$39.95
PV-H18A		Soft Sided	\$49.95

Note:

• Prices subject to change without notice.

For Your Information

Palmcorder Accessory Order Form

Please photocopy this form when placing an order.

1. Palmcorder Model # _____

2. Items Ordered

Accessory #	Description	Price Each	Quantity	Total Price
Subtotal				
Your State & Local Sales Tax				
Shipping & Handling				6.95
Total Enclosed				

3. Method of payment (check one)

- Check or Money Order enclosed (NO C.O.D.SHIPMENTS)
- VISA Credit Card # _____
- MasterCard Expiration Date _____
- Discover Customer Signature _____

Make Check or Money Order to: PANASONIC ACCESSORIES

(Please do not send cash)

4. Shipping information (UPS delivery requires complete street address)

Ship To:

Mr.

Mrs.

Ms.

First

Last

Phone #:

Day ()

Street Address

Night ()

City

State

Zip

TO OBTAIN ANY OF OUR PALMCORDER ACCESSORIES YOU CAN DO ANY OF THE FOLLOWING:

VISIT YOUR LOCAL PANASONIC DEALER

OR

CALL PANASONIC'S ACCESSORY ORDER LINE AT 1-800-332-5368

[6 AM-5 PM M-F, 6 AM-10:30 AM SAT, PACIFIC TIME]

OR

MAIL THIS ORDER TO: PANASONIC SERVICES COMPANY ACCESSORY
ORDER OFFICE

20421 84th Avenue South Kent, WA. 98032

Specifications

Power Source:	Compact VHS Camcorder: DC 6 V AC Adaptor: 110/120/220/240 V AC, 50/60 Hz Battery: Nickel-Cadmium Type DC 6 V
Power Consumption:	Compact VHS Camcorder: 6V DC 6.0 W (Max. 9 W) AC Adaptor: 19 W 1.2 W (when not in use.)
Video Signal:	EIA Standard (525 lines, 60 fields) NTSC color signal
Video Recording System:	2 rotary heads plus flying erase head. Helical scanning system
Audio:	1 track
Pick-Up System:	Sequential color difference field reverse system
Pick-Up Device:	One integral color filter Charge Coupled Device (CCD)
Lens:	20:1 zoom lens, F1:1.6 with auto iris control Focal length: 3.6 mm - 72.0 mm 4 speed power zoom function
Viewfinder:	10.2 mm (0.4 inch) Electronic Viewfinder
Minimum Illumination Required:	0.8 lx (F1:1.6) 0.08 footcandles 7 lx (F1:1.6) 0.7 footcandles (EIA Standard)
Operating Temperature:	0 °C~40 °C (32 °F~104 °F)
Operating Humidity:	10 %~75 %
Weight:	Compact VHS Camcorder: 0.87 kg 1.92 lbs. AC Adaptor: 0.3 kg 0.66 lbs.
Dimensions:	Compact VHS Camcorder: 101 (W) × 125 (H) × 190.5 (D) mm 4 (W) × 4-15/16 (H) × 7-1/2 (D) inch AC Adaptor: 68 (W) × 41 (H) × 140 (D) mm 2-11/16 (W) × 1-5/8 (H) × 5-1/2 (D) inch

Weight and dimensions shown are approximate.
Designs and specifications are subject to change without notice.

Request for Service Notice

Please photocopy this form when making a request for service notice.

Request for Service Notice:

- In the unlikely event this product needs service.
- Please include your **proof of purchase**.
(Failure to do so will delay your repair.)
 - To further speed your repair please provide an explanation of what is wrong with the unit and any symptom it is exhibiting.

Mail this completed form and your Proof of Purchase along with your unit to:
Panasonic Services Company
1705 N. Randall Road
Elgin, IL. 60123-7847
Attn: Camcorder Repair

Before Requesting Service

If a problem arises, you may be able to correct it yourself.

See Symptom and Correction list below.

Symptom	Correction
No picture in EVF ...	<ul style="list-style-type: none">• Connect Power Source. (pp. 8, 9)• Set POWER to VCR or CAMERA. (pp. 16, 19)• Check for Dew Indication. (p. 30)• Use fully charged Battery. (p. 8)• Firmly connect all needed cables. (p. 9)
Video cassette cannot be inserted ...	<ul style="list-style-type: none">• Connect Power Source. (pp. 8, 9)• Insert cassette, window side facing out. (p. 10)
Video cassette cannot be removed ...	<ul style="list-style-type: none">• Connect Power Source. (pp. 8, 9)
Operation buttons do not work ...	<ul style="list-style-type: none">• Check for Dew Indication. (p. 30)
Recording cannot be done ...	<ul style="list-style-type: none">• Make sure record tab is intact. (p. 10)• Check Battery Indicator. (p. 29)• Check for Dew Indication. (p. 30)
Auto Focus does not operate ...	<ul style="list-style-type: none">• Set FOCUS to AUTO. (p. 23)• Set POWER to CAMERA. (p. 16)
Sound from microphone can't be monitored ...	<ul style="list-style-type: none">• Set unit to REC or Record/Pause mode.
Camera picture is too dark ...	<ul style="list-style-type: none">• Set HIGH SPEED SHUTTER to AUTO. (p. 24)
No playback picture, or the playback picture is noisy or contains streaks ...	<ul style="list-style-type: none">• Press UP/DOWN button during playback (Tracking Control). (p.19)
Top of playback picture waves back and forth excessively ...	<ul style="list-style-type: none">• A playback signal is not as stable as an off the air TV signal, so the top of your TV screen may appear bent or unstable during playback. This is called, "Horizontal AFC time constant change." To correct, slowly turn the TV horizontal hold control. If your TV does not have this control, or adjusting it does not help, contact your TV service center. (Some nominal service charges may be required.)

Video Head Cleaning



Clogged Video Head

While head cleaning is normally not needed, playing old or damaged tapes may clog the heads. When playback picture resembles example at the left, head cleaning is required.

Ideally, head cleaning should be performed by a qualified service technician. When this is not possible, purchase a head cleaning cassette. Be sure to follow cleaning cassette instructions exactly and only use when symptoms occur.

Panasonic Consumer Electronics Company,
Division of Matsushita Electric Corporation
of America, One Panasonic Way
Secaucus, New Jersey 07094

Panasonic Sales Company,
Division of Matsushita Electric of Puerto Rico, Inc.
AVE. 65 de Infantería, Km. 9.5 San Gabriel
Industrial Park, Carolina, Puerto Rico 00985

PANASONIC/QUASAR Video Products Limited Warranty

Panasonic Consumer Electronics Company or Panasonic Sales Company (collectively referred to as "the Warrantor") will repair or replace this product with new or refurbished parts or equivalent product, free of charge, in the USA or Puerto Rico, in the event of a defect in materials or workmanship as follows (all time periods commence from the date of the original purchase):

PRODUCT	PARTS	LABOR	SERVICE	CONTACT NUMBER
CAMCORDER	ONE (1) YEAR, EXCEPT CCD IMAGE SENSOR CCD IMAGE SENSOR - SIX (6) MONTHS	NINETY (90) DAYS	Carry-In or Mail-In	1-800-211-PANA(7262)
		NINETY (90) DAYS		
DVD/VCR DECK	ONE (1) YEAR	NINETY (90) DAYS	Carry-In or Mail-In	1-800-211-PANA(7262)
DIGITAL STILL CAMERA	ONE (1) YEAR, EXCEPT CCD IMAGE SENSOR CCD IMAGE SENSOR - SIX (6) MONTHS	NINETY (90) DAYS	Carry-In or Mail-In	1-800-272-7033
		NINETY (90) DAYS		
A/V MIXER	ONE (1) YEAR	NINETY (90) DAYS	Carry-In or Mail-In	1-800-211-PANA(7262)
TV/VCR, TV/DVD TV/DVD/VCR COMBINATION	ONE (1) YEAR, EXCEPT CRT CRT - TWO (2) YEARS	NINETY (90) DAYS CRT - NINETY (90) DAYS	Carry-In: 21" CRT and Smaller	1-800-211-PANA(7262)
			In-Home or Carry-In: 22" CRT and Larger	
TV/HDR COMBINATION	ONE (1) YEAR, EXCEPT CRT CRT - TWO (2) YEARS	NINETY (90) DAYS CRT - NINETY (90) DAYS	In-Home or Carry-In	1-888-843-9788

Batteries (if included) - New rechargeable batteries in exchange for defective rechargeable batteries for ten (10) days. Non-rechargeable batteries are not warranted.

Tape (if included) - New video cassette tape in exchange for a defective video cassette tape for five (5) days.

Memory cards (if included) - Exchange defective item for new one for ninety (90) days.

In-home, carry-in or mail-in service, as applicable, in the USA can be obtained during the warranty period by contacting a Panasonic Services Company (PASC) Factory Servicenter listed in the Servicenter Directory. Or call toll free contact number listed above, to locate an authorized PASC Servicenter. Carry-in or mail-in service in Puerto Rico can be obtained during the warranty period by calling the Panasonic Sales Company telephone number listed in the Servicenter Directory.

This warranty is extended only to the original purchaser. A purchase receipt or other proof of the date of the original purchase is required before warranty service is rendered.

This warranty only covers failures due to defects in materials and workmanship, which occur during normal use and does not cover normal maintenance, including, but not limited to, video and audio head cleaning. The warranty does not cover damage which occurs in shipment, or failures which are caused by products not supplied by the warrantor, or failures which result from accident, misuse, abuse, neglect, mishandling, misapplication, alteration, modification, faulty installation, set-up adjustments, improper antenna, inadequate signal pickup, maladjustment of consumer controls, improper operation, power line surge, improper voltage supply, lightning damage, commercial use such as hotel, office, restaurant, or other business or rental use of the product, or service by anyone other than a PASC Factory Servicenter or a PASC authorized Servicenter, or damage that is attributable to acts of God.

LIMITS AND EXCLUSIONS

There are no express warranties except as listed above.

THE WARRANTOR SHALL NOT BE LIABLE FOR INCIDENTAL OR CONSEQUENTIAL DAMAGES (INCLUDING, WITHOUT LIMITATION, DAMAGE TO RECORDING MEDIA) RESULTING FROM THE USE OF THIS PRODUCTS, OR ARISING OUT OF ANY BREACH OF THE WARRANTY. ALL EXPRESS AND IMPLIED WARRANTIES, INCLUDING THE WARRANTIES OF MERCHANTABILITY AND FITNESS FOR PARTICULAR PURPOSE, ARE LIMITED TO THE APPLICABLE WARRANTY PERIOD SET FORTH ABOVE.

Some states do not allow the exclusion or limitation of incidental or consequential damages, or limitations on how long an implied warranty lasts, so the above exclusions or limitations may not apply to you.

This warranty gives you specific legal rights and you may also have other rights, which vary, from state to state. If a problem with this product develops during or after the warranty period, you may contact your dealer or Servicenter. If the problem is not handled to your satisfaction, then write to the Consumer Affairs Department at the Panasonic Consumer Electronics Company address above.

SERVICE CALLS WHICH DO NOT INVOLVE DEFECTIVE MATERIALS OR WORKMANSHIP AS DETERMINED BY THE WARRANTOR, IN ITS SOLE DISCRETION, ARE NOT COVERED.

COSTS OF SUCH SERVICE CALLS ARE THE RESPONSIBILITY OF THE PURCHASER.

warvid 02/ 12/ 2001

Servicenter List

For Product Information, Operating Assistance, Literature Request, Dealer Locations, and all Customer Service inquiries please contact:
1-800-211-PANA (7262), Monday-Friday 9 am-9 pm; Saturday-Sunday 9 am-7 pm, EST.
or send e-mail to : consumerproducts@panasonic.com

Web Site: <http://www.panasonic.com>

You can purchase parts, accessories or locate your nearest servicenter by visiting our Web Site.

Accessory Purchases:

1-800-332-5368 (Customer Orders Only)

Panasonic Services Company 20421 84th Avenue South, Kent, WA 98032

(6 am to 5 pm Monday - Friday; 6 am to 10:30 am Saturday; PST)

(Visa, MasterCard, Discover Card, American Express, Check)

Factory Servicenters Locations

CALIFORNIA

6550 Katella Avenue
Cypress, CA 90630

800 Dubuque Avenue
S. San Francisco,
CA 94080

3878 Ruffin Road
Suite A
San Diego, CA 92123

FLORIDA

3700 North 29th Avenue
Suite 102
Hollywood, FL 33020

GEORGIA

8655 Roswell Road
Suite 100
Atlanta, GA 30350

ILLINOIS

1709 North Randall Road
Elgin, IL 60123

MASSACHUSETTS

60 Glacier Drive
Suite G
Westwood, MA 02090

MINNESOTA

7850-12th Avenue South
Airport Business Center
Bloomington, MN 55425

OHIO

2236 Waycross Road
Civic Center Plaza
Forest Park, OH 45240

PENNSYLVANIA

2221 Cabot Blvd. West
Suite B
Langhorne, PA 19047

TEXAS

13615 Welch Road
Suite 101
Farmers Branch,
TX 75244

WASHINGTON

20425-84th Avenue
South
Kent, WA 98032

HAWAII

99-859 Iwaiwa Street
Aiea, Hawaii 96701
Phone (808) 488-1996
Fax (808) 486-4369

Service in Puerto Rico

Matsushita Electric of Puerto Rico, Inc. Panasonic Sales Company/ Factory Servicenter:
Ave. 65 de Infantería. Km. 9.5, San Gabriel Industrial Park, Carolina. Puerto Rico 00985
Phone (787) 750-4300 Fax (787) 768-2910

As of Sep. 2001

Spanish Quick Use Guide/Guía Para Uso Rápido

Antes de comenzar...

- Inserte un casete con lengüeta para prevención del grabado.

Cargue la batería

Cargue completamente la batería antes de usarla.

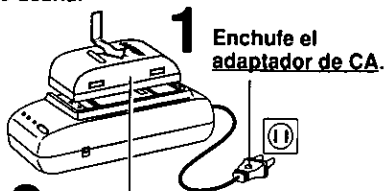

1 Enchufe el adaptador de CA.

2 Instale la batería. El indicador de carga (CHARGE) parpadea, luego queda encendido si ha terminado la carga. Desmonte la batería.

Inserte el casete

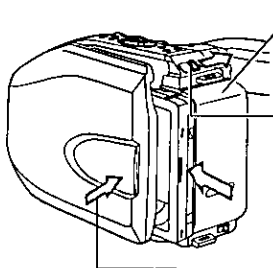

1 Coloque la batería cargada.

2 Deslice **TAPE EJECT** para abrir la compuerta.

3 Inserte el casete.

4 Presione aquí para cerrar la compuerta.

Grabación con la videocámara

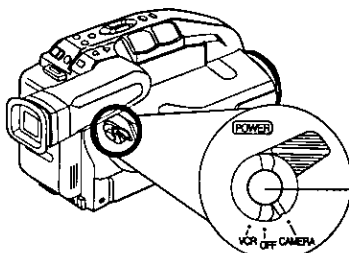

1 Ajuste **POWER** a **CAMERA**.

2 Presione **RECORD/PAUSE** para comenzar la grabación. Presione **RECORD/PAUSE** otra vez para hacer una pausa en la grabación.

Reproduzca usando el EVF

1 Ajuste **POWER** a **VCR**.

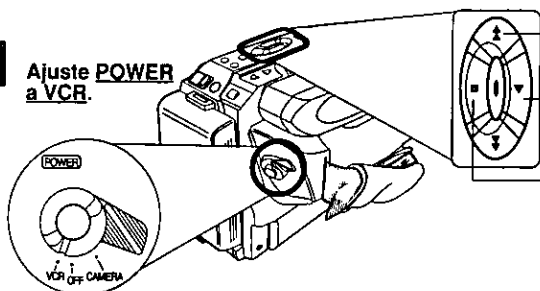

2 Presione **REWIND/SEARCH** para rebobinar la cinta.

3 Presione **PLAY** para comenzar la reproducción.

4 Presione **STOP** para finalizar la reproducción.

Reproducción con efectos especiales

Para localizar rápidamente una escena específica

- Oprimir el botón de localización (SEARCH).

Para congelar una imagen

- Oprimir el botón de pausa/imagen fija (PAUSE/STILL).
- Oprimir nuevamente el botón cuando se desea continuar reproduciendo.

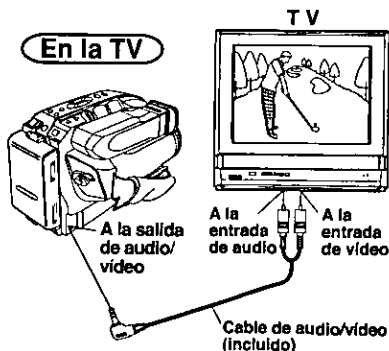

For Your Information

Index

- A**
AC Adaptor 9
Accessories (Optional) ... 33
Accessories (Supplied) 2
Audio/Video Cable ... 20, 21
Audio/Video Out 20, 21
Auto Daylight Saving Time
..... 14
- B**
Backlight 22
Battery Pack 8, 9
BATTERY RELEASE
Button 8
Before Requesting Service
..... 36
B.LIGHT Button 22
Built-in Microphone 16
- C**
Camera Recording ... 16~18
Car Battery Cord 9
Cassette Information 10
Charging Battery 8
Cleaning EVF 31
Clock Battery 32
Clock Set 13, 14
Copying your Tapes 21
- D**
DC IN 9
DC Power Cable 9
Digital E.I.S. 27
Digital Zoom 27
DISPLAY Button . 12, 19, 29
Display-off Mode 29
D.ZOOM Button 27
- E**
EIS Button 27
Electronic Viewfinder
Indications 29, 30
- F**
Fade 25, 26
FADE Button 25, 26
FAST FORWARD/
SEARCH Button 19
Focus 23
- H**
Hand Strap 11
High Speed Shutter 24
- L**
Lens Cap 11
Light 15
LIGHT Switch 15
Limited Warranty 37
- M**
MENU Button 12
MENU Mode 12
M.FOCUS Button 23
MotionSensor 28
- P**
PLAY Button 19
Playback 19, 20
PlayPak (Optional) 20
Power Supply 8, 9
POWER Switch 7, 16, 19
POWER ZOOM Button
..... 22, 23, 27
Programmed Recording . 18
- Q**
Quick Operation Guide 7
- R**
RECORD/PAUSE Button 16
Record/Playback Time ... 10
Replacing Clock Battery . 32
Request for Service Notice
..... 35
REWIND/SEARCH Button
..... 19
- S**
Safety Precautions 3
Servicenter List 38
Shoulder Strap 11
Special Effects 19
Specifications 35
STILL Button 19
Still Picture 19
STOP Button 19
- T**
Tab 10
TAPE EJECT Switch 10, 16
TAPE SPEED Button 16
Tracking Control 19
Tripod Mounting Hole 32
- U**
UP (FAR) / DOWN (NEAR)
Button 12, 19, 23
- V**
VHF Connecting Cable .. 21
Video Cassettes (tapes) . 10
Video Head Cleaning 36
Viewing (TV/VCR) 20
VISION ADJUSTMENT .. 16
- Z**
Zoom 22, 27

Panasonic Consumer Electronics Company,
Division of Matsushita Electric Corporation of America
One Panasonic Way Secaucus, New Jersey 07094



Printed in Indonesia
LSQT0527A
S0102-0

Free Manuals Download Website

<http://myh66.com>

<http://usermanuals.us>

<http://www.somanuals.com>

<http://www.4manuals.cc>

<http://www.manual-lib.com>

<http://www.404manual.com>

<http://www.luxmanual.com>

<http://aubethermostatmanual.com>

Golf course search by state

<http://golfingnear.com>

Email search by domain

<http://emailbydomain.com>

Auto manuals search

<http://auto.somanuals.com>

TV manuals search

<http://tv.somanuals.com>