

SEARS OWNER'S MANUAL

Kenmore Automatic Air Conditioner

Read this book! It will tell you how to use and care for your air conditioner as well as how to get the most efficient cooling.

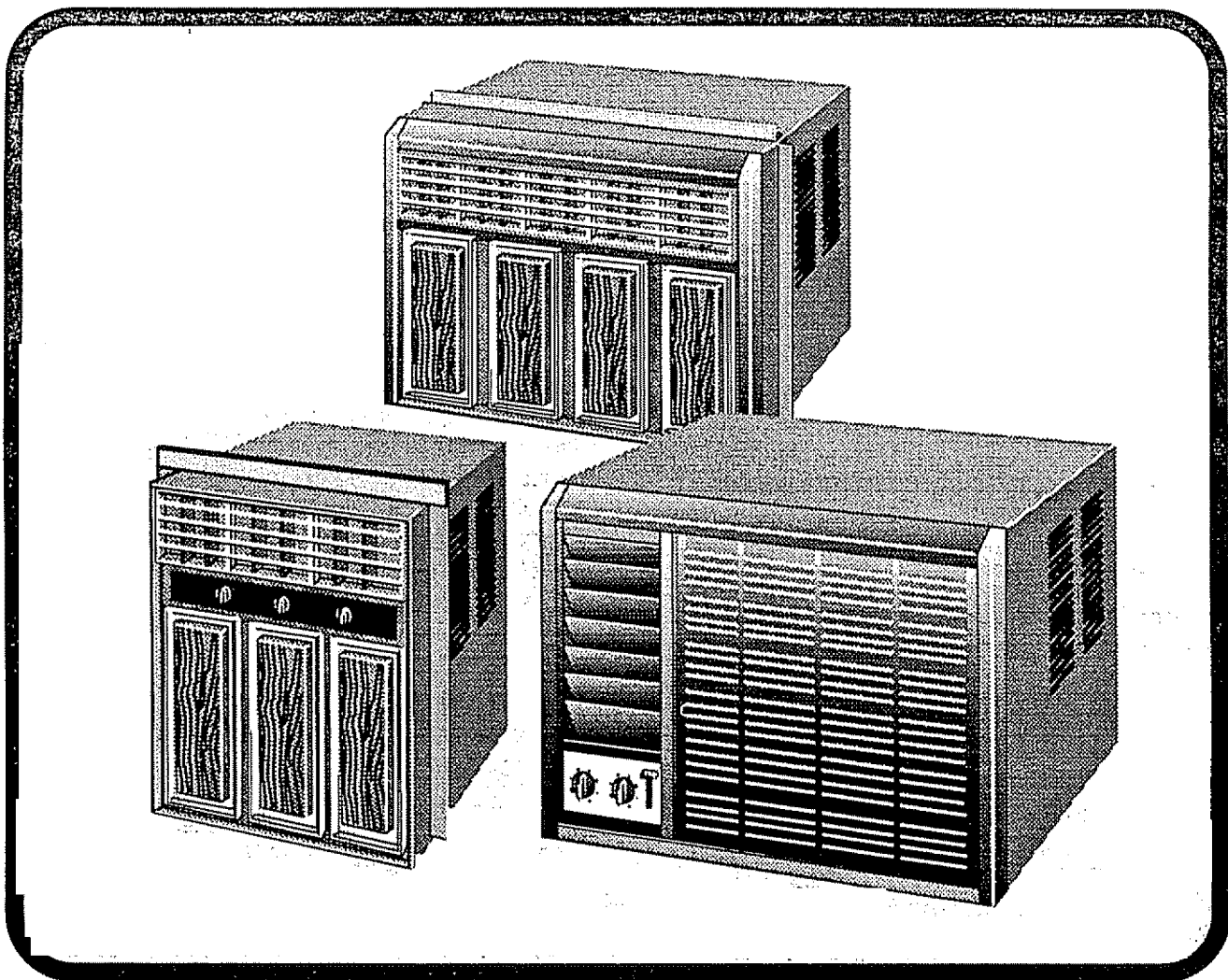

Model Number

Serial Number

P/N 93SR-D02

Table of Contents

Cautions	Page 2
Important Installation Instructions	Page 3
Installing Front to Unit	Page 4
How to Adjust Vent Control	Page 5
How to Adjust Temperature Control	Page 5
How to Use Filter Monitor	Page 5
Operation of Fan Speed Control	Page 5
Air Direction	Page 6
Cleaning and Replacing Your Air Filter	Page 7
How to Lower Your Cooling costs	Page 7
Avoid Service Checklist	Page 8-10
Routine Annual Maintenance	Page 11
Oiling of the Fan Motor	Page 11
Accessories	Page 12
Note Pages	Page 13-15
Warranty	Page 16
"We Service What We Sell"	Page 16

CAUTIONS

There are only a few cautions, but they are quite important.

1. If you turn your air conditioner off, *wait at least 3 minutes* before turning it back on to avoid possible blown fuses.

2. Do not run air conditioner with outside protective cover in place, to avoid mechanical damage within the air conditioner.

3. Do not use air conditioner near flammable liquids, such as gasoline.

4. When handling air conditioner, be careful to avoid cuts from sharp metal fins on front and rear coils.

5. Do not alter or change the plug on the power cord. Changes would make it unsafe, could cause serious damage to the air conditioner, and may void the warranty.

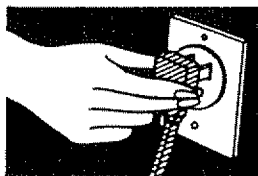

6. If you plan to install the air conditioner yourself at any time, see the Installation Instructions and Electrical Requirements. Be sure to read local codes.

7. Do not try to use this air conditioner on direct current (DC). Make sure the outlet is wired to 60-Hertz alternating current of voltage called for in the Electrical Requirements in "Things You Ought to Know."

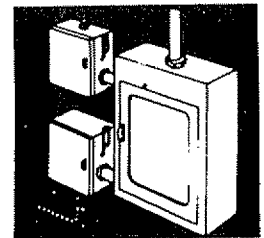

8. Use only time-delay fuses or circuit breakers of the size shown in the Electrical Requirements Sheet.

9. Do not use an extension cord or power cord plug adapter.

IMPORTANT INSTALLATION INSTRUCTIONS

MANUAL VERTICAL LOUVER ADJUSTMENT

Complete this adjustment
before installing front panel

1. Adjust the vertical louvers to the straight position by using the handle.
2. The control panel and knobs are packed separately. To install them, refer to installing "Front to Unit" in this manual.

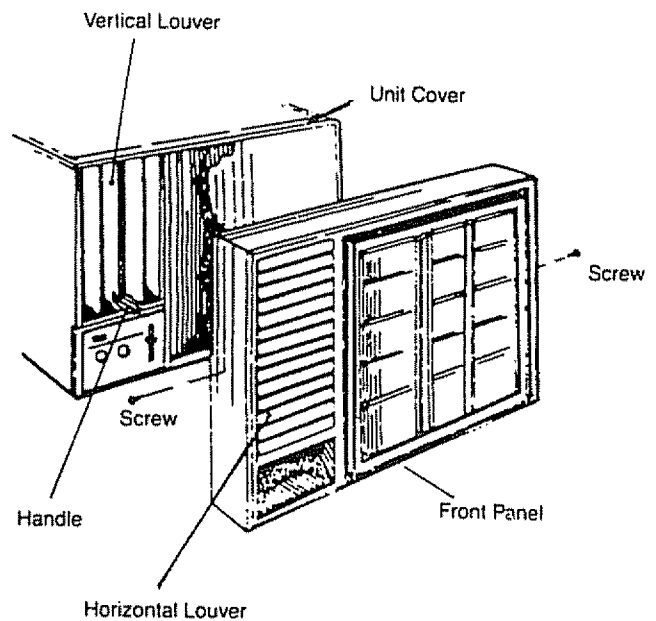

Front Installation

Install the front panel with filter as follows:

1. Adjust the horizontal louvers to the straight position. Hold the front straight until the vertical louver handle lines up between the bottom horizontal louver and the discharge opening.
2. Press the front straight onto the cabinet until the holes in the flange of the plastic front line up with the screw holes in the metal cabinet. Fasten the front in place with the two screws provided.

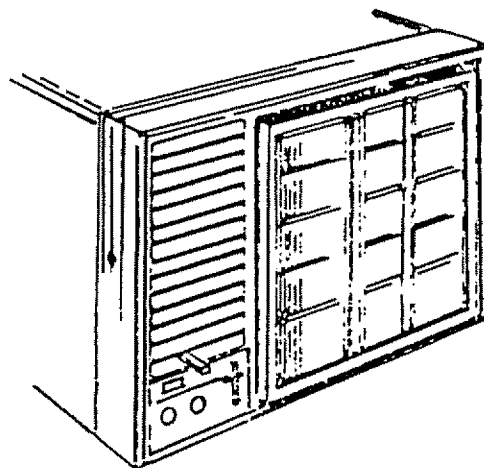

INSTALLING FRONT TO UNIT

Step 1: Install dial plate and buttons or knobs:

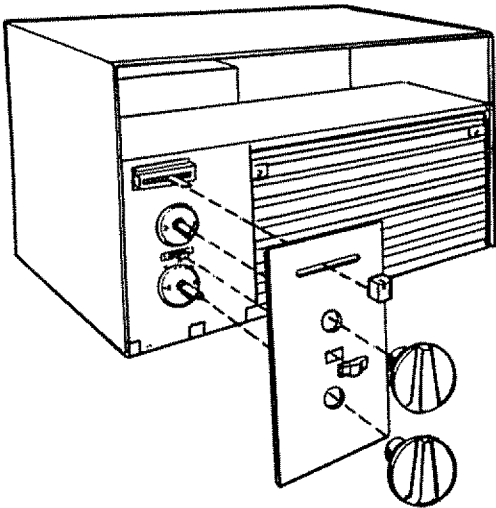

If dial plate has clear protective film, peel off carefully (do not scratch surface).

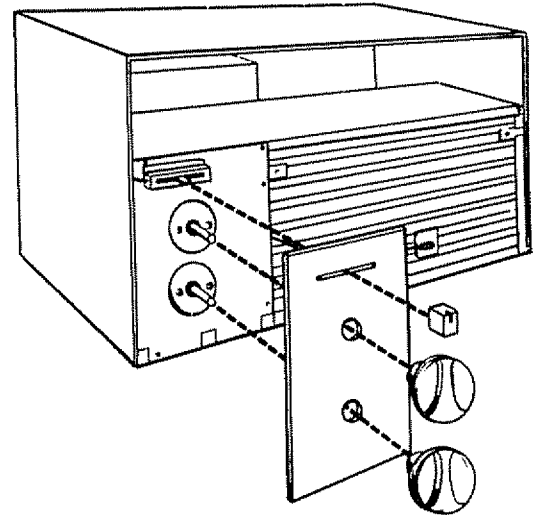

Step 2: Install front as shown:
Holding front in position
over shell as each screw
is driven.

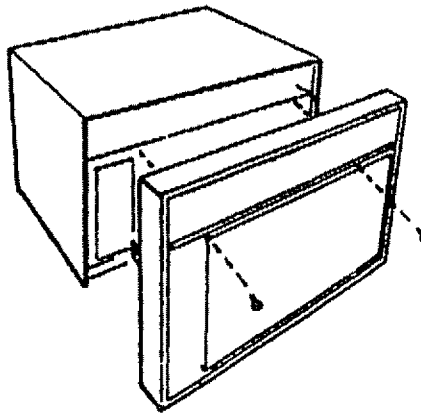

NOTE: To clean filter, remove front by reversing step 2.
Remove filter by grasping at the sides, push down and pull
out. When reinstalling be sure that the notch is at the top left
corner. Reinstall front using step 2.

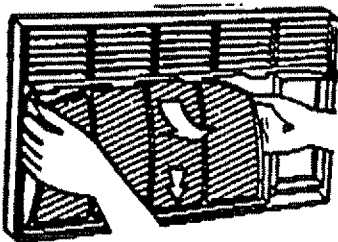

TOP LEFT

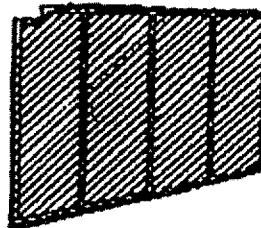

FILTER FROM THE BACK

STARTING AND USING YOUR NEW AIR CONDITIONER

First make sure the 'FAN CONTROL' is set on 'OFF' and then plug the air conditioner in. The power cord receptacle must match the type shown in the Electrical Requirements Sheet.

VENT CONTROL

The 'VENT CONTROL' on your new Kenmore Air Conditioner operates two different functions. When the arrow points toward 'CLOSE,' the air conditioner is working its regular operation of moving and cooling room air. When the arrow is turned toward the word 'OPEN,' the air conditioner is removing stale air from the room. Air exhaust can be increased by moving the air louvers to a more closed position. To use these functions with the least cooling, set 'TEMP. CONTROL' to '1.'

'TEMP. CONTROL'

The 'TEMP. CONTROL' sets the degree of room coolness. The higher the number the cooler the temperature. Numbers '1' through '4' will help conserve energy. For maximum cooling turn the indicator to the highest number.

FILTER MONITOR (on some models)

To Check Filter Monitor:

1. Set fan control in CONSTANT FAN 'HI' position.
2. If filter needs cleaning, a RED INDICATOR will appear in the filter monitor window. A clean filter will help reduce operating costs and increase cooling efficiency.

FAN CONTROL

This one knob (A) turns air conditioner off. (B) adjusts fan

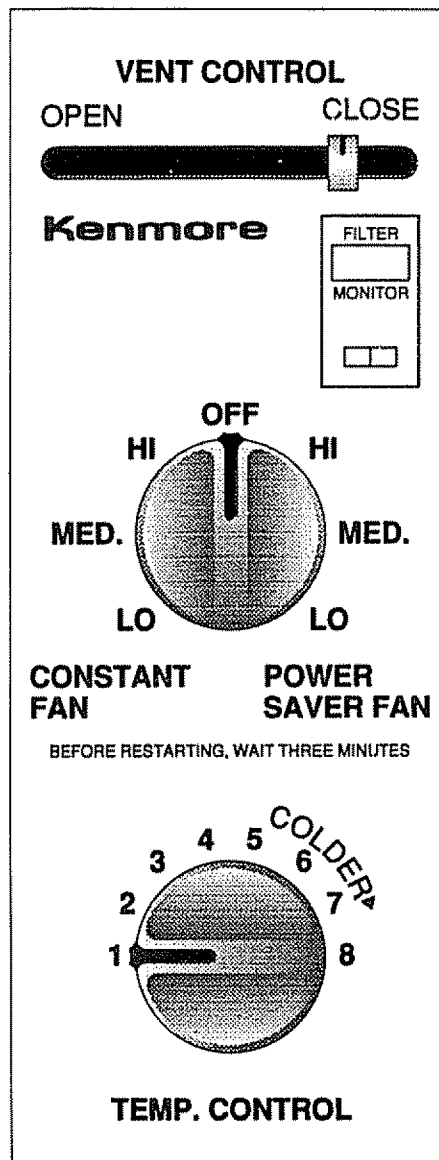

speeds. (C) sets POWER SAVER FAN (on some models) or CONSTANT FAN.

OFF - The entire air conditioner is off.

POWER SAVER FAN FEATURE (on some models) is indicated by gold lettering on the 'HI,' 'MED' and 'LO' speeds. The air conditioner (compressor fan) will not run unless the 'TEMP. CONTROL' is set colder than room temperature. (See temperature instructions). When control is set colder than the room temperature, the air conditioner will begin to circulate the air in the room. Cooling will begin in about 3 minutes. The air conditioner turns off when the room gets cool. 'HI' is for fast cool, 'MED' for normal, and 'LO' for quiet cool. The 'POWER SAVER FAN' settings can save energy. The fan will turn on only when the fan is cooling.

CONSTANT FAN

Hi - Low and on some models Med. speed.

The air conditioner fan runs all the time, circulating room air. Cooling starts only if the air is warm and stops if it gets cool (See temperature instructions). This setting gives the most even room temperatures. 'HI' is for fast cool, 'MED' for normal cool - 'LO' for quiet cool.

Side Air Dial Plate Controls

Follow the directions above for control use.

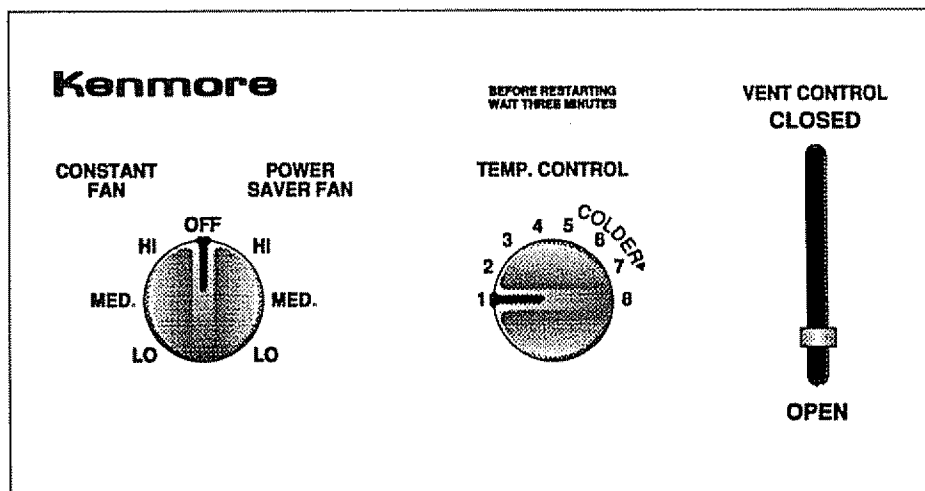

AIR DIRECTION

The air direction can be adjusted up, down, left or right. The outside tabs adjust the air up or down. The center levers direct the air left or right.



SUPER THRUST AIR CONTROL

For the most thrust, fully close the right bank (with outside tab). Set desired fan speed.

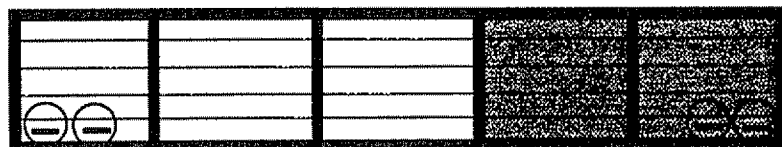

Air Directional Louvers

6-way Louvers

The 6-way louvers permit upward or straight out air flow and air flow direction from side to side. This type of louver is found only on the side air discharge models. The side to side adjustment of air flow direction is achieved by moving the handle to either the left or right.

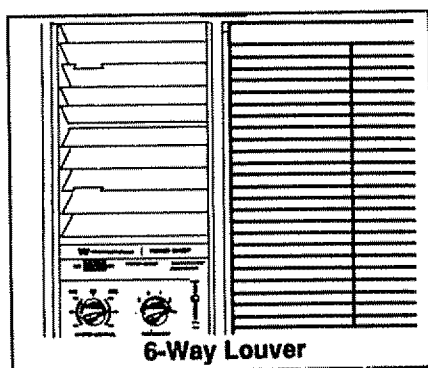

CLEANING AND REPLACING THE AIR FILTER

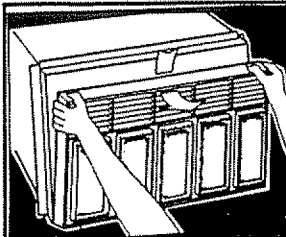

1. To remove front, remove one screw from each side of unit. Pull front off of unit.

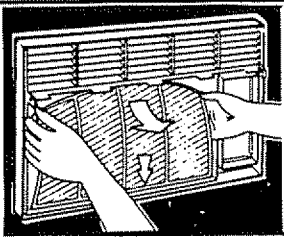

2. To remove filter, grasp each side at the middle, push down on filter and pull out until free.

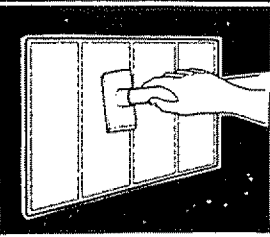

3. To clean filter, simply vacuum or wash in warm, sudsy water. Rinse and dry. New filters are available from your nearest Sears store.

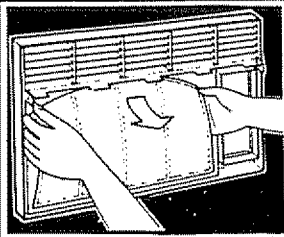

4. To replace filter, grasp each side at the middle, insert bottom of filter first. Push down and flex filter out at the middle. Push filter in at top until it stops. When installed, filter remains in bowed position.

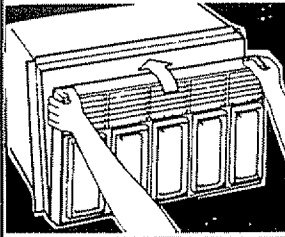

5. To replace front, hold front in position on unit and replace one screw on each side.

HOW TO LOWER YOUR COOLING COSTS

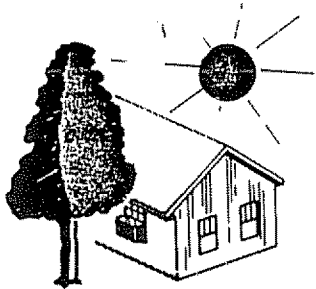

1. If possible install the air conditioner on the shady side of the house.

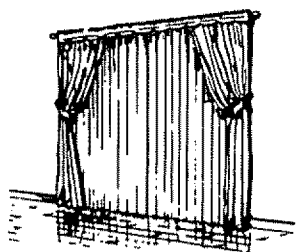

2. Close drapes and shades on all other windows to keep direct sunlight out.

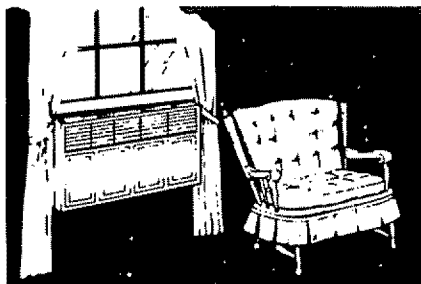

3. See that draperies or furniture do not block the air flow.

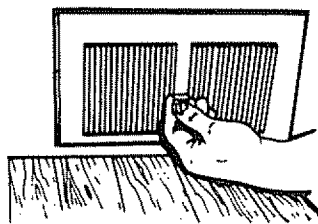

4. Keep heat inlets closed so cooled air won't escape.

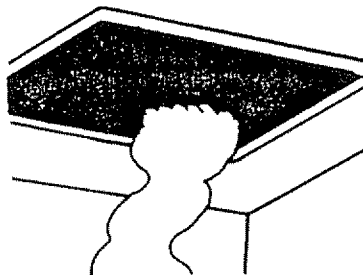

5. A vent fan in areas where cooking, laundry or bathing is done can be used to pull out the extra heat and moisture near its source.

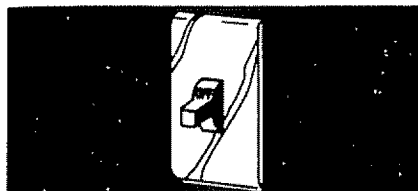

6. Check to make sure lights, televisions, radios, and appliances are turned off when not needed. Try not to use heat-producing appliances during the hottest part of the day.

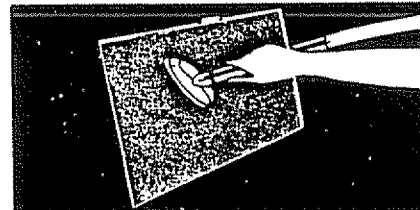

7. Check often to be sure filter is clean.

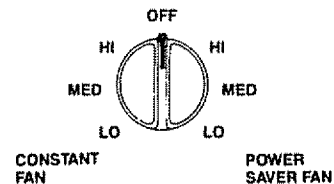

8. If you'll be away for a long time, turn the air conditioner FAN CONTROL to the "OFF" position. The air conditioner will not come on if room temperature gets hot.

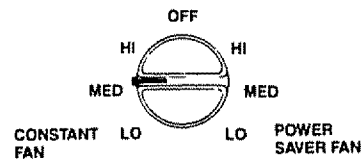

9. If you'll be away a short time use the gold POWER SAVER FAN settings. The fan will run only when needed.

AVOID SERVICE CHECKLIST

Before calling for service, review this list. It may save you both time and expense. This list includes common problems that are not the result of defective workmanship or materials in this appliance.

OCCURRENCE	POSSIBLE CAUSE	SOLUTION
Air conditioner will not operate.	Wall plug disconnected.	Push plug firmly into wall outlet.
	House fuse blown or circuit breaker tripped.	Replace fuse with time delay type or reset circuit breaker.
	Thermostat set too warm for cooling or too cool for heating.	Adjust thermostat to higher number for cooling, lower number for heating.
Air from unit does not feel cold enough on Cool setting.	Selector switch in FAN position.	Turn switch clockwise to COOL position.
	Thermostat set too warm (lower number).	Turn thermostat clockwise to colder setting (higher number).
	Thermostat temperature below 70°F (20°C).	Cooling may not occur until temperature at thermostat rises above 70°F (20°C).
	Temperature sensing tube touching cold coil, located behind air filter (some models only).	Straighten tube so it does not touch coil.
Air conditioner cooling, but room is too warm-ice forming on cooling coil behind decorative front.	Outdoor temperature below 70°F (20°C).	To defrost the coil,, set thermostat to a warmer position.
	Dirty air filter-air restricted.	Clean filter.
	Thermostat set too cold for "night-time" cooling.	To defrost the coil, set thermostat to a normal position.
Air conditioner cooling but room too warm-NO ice forming on cooling coil behind decorative front.	Dirty air filter-air restricted.	Clean air filter. Refer to "Care and Cleaning " section.
	Thermostat set too warm (lower number).	Turn thermostat clockwise to colder temperature.
	Selector switch set on LOW COOL.	Turn switch to HIGH COOL position for maximum cooling.
	Vent control (some models) set at OPEN position.	Turn control to CLOSED position for maximum cooling.
	Air directional louvers positioned improperly.	Position louvers for better air distribution.

AVOID SERVICE CHECKLIST (continued)

OCCURRENCE	POSSIBLE CAUSE	SOLUTION
Air conditioner cooling but room too warm-NO ice forming on cooling coil behind decorative front. (continued)	Front of unit is blocked by drapes, blinds, furniture, etc. Restricts air distribution.	Clear blockage in front of unit.
	Doors, windows, registers, etc. open -cold air escapes; hot air enters.	Close doors, windows, registers, etc.
	Unit recently turned on in hot room.	Allow additional time to remove "stored heat" from walls, ceiling, floor and furniture.
	Insufficient cooling capacity.	Reconfirm the required cooling capacity with your dealer.
Air conditioner turns on and off rapidly.	Dirty air filter-air restricted.	Clean air filter.
	Outside temperature extremely hot.	Set fan on high speed to bring air past cooling coils more frequently.
Noise when air conditioner operates on cooling.	Air sound.	Air sound is normal. If too loud, turn selector switch to lower fan setting.
	Sound of fan hitting water-moisture removal system.	This is normal when humidity is high. Close doors, windows, registers, etc.
	Window vibration. Poor installation.	Refer to installation instructions-check with installer.
Water dripping INSIDE when air conditioner is cooling.	Improper installation.	Tilt air conditioner slightly to the outside to allow water drainage. Refer to installation instructions-check with installer.
Water dripping OUTSIDE when air conditioner is cooling.	Unit removing large quantity of moisture from humid room.	This is normal during excessively humid days.
Air from unit does not feel warm enough on Heat setting (some models only).	Selector switch in FAN or COOL position.	Turn switch counterclockwise to HEAT position.
	Thermostat set too cool (higher number).	Turn thermostat counterclockwise to warmer setting (lower number).
	Room temperature is warm enough.	Heating will not occur until temperature at the thermostat is lower.

AVOID SERVICE CHECKLIST (continued)

OCCURRENCE	POSSIBLE CAUSE	SOLUTION
Air conditioner heating but room too cool (some models only).	Dirty air filter-air restricted.	Clean air filter.
	Thermostat set too cool (higher number).	Turn thermostat counterclockwise to warmer setting (lower number).
	Exhaust vent control set at OPEN/EXHAUST position.	Set control to CLOSED position for maximum heating.
	Air directional louvers positioned improperly.	Position louvers for better air distribution.
	Front of unit is blocked by drapes, blinds, furniture, etc. - restricts air distribution.	Clear blockage in front of unit.
	Doors, windows, registers, etc. open-hot air escapes; cold air enters.	Close doors, windows, registers, etc.
	Unit recently turned on in cool room.	Allow additional time to heat walls, ceiling, floor and furniture.
	Insufficient heating capacity for area to be heated.	Reconfirm the required heating capacity with your dealer.

ROUTINE ANNUAL MAINTENANCE TO INSURE LONG LIFE

CLEANING THE CABINET FRONT

Remove front. Wash with warm, mild sudsy water. Rinse and dry with a soft cloth. Never use solvents, cleaning fluids, abrasive cleaners or strong detergents. If the package tape leaves gum, remove with cloth dipped in rubbing alcohol.

REPAIRING PAINT DAMAGE

Inspect weather exposed parts (cabinet shell, mounting hardware (if used), etc.) once or twice a year, especially in areas near oceans or where rust is a problem. If needed, touch up with a good grade of exterior paint.

CLEANING THE INSIDE OF YOUR AIR CONDITIONER

DANGER - SHOCK OR INJURY HAZARD - before performing any service unplug power cord from outlet.

CAUTION: No liquid should get into the motor, electrical control box or compressor electrical terminals.

1. To clean the inside of your air conditioner:
 - A) Remove front panel.
 - B) With help and using proper lifting methods to avoid personal injury, remove chassis from cabinet shell.*

HANDLE NOTE: If your air conditioner has a chassis handle, it is NOT intended for lifting the unit. It is for sliding the chassis WITHIN the cabinet shell only (to aid in cleaning maintenance, etc.).

*When moving the air conditioner from cabinet shell or window there may be water inside the base that may spill on the floor.

2. Be careful to avoid cuts from sharp metal fins on the front and rear coils.
3. Liquid should not get into electrical parts; wrap the fan motor, electrical control box and electrical terminals in plastic. This will keep water or other liquid from getting inside where it could damage the insulation and cause serious trouble.
4. Clean and hose out the base, coils, and water pans. Clean at least once a year or more often, if the coils and pans collect dirt, sand, leaves, algae or insects. Also clean if you detect an odor from the air conditioner.

5. After cleaning, remove plastic protection. Wait 24 hours before starting the unit again. This allows time for all areas to dry out.

NOTE: Water from rainfall or from normal use does not harm these components since the water is not as forcefully driven into parts as a stream of water from a garden hose.

6. While the cabinet is removed, this is a good time to oil the fan motor (see instructions below)

After servicing, reverse the above procedure to reinstall the air conditioner.

OILING OF THE FAN MOTOR

DANGER - SHOCK OR INJURY HAZARD - before performing any service unplug the power cord from the outlet.

1. To oil fan motor:
 - A) Remove front panel.
 - B) Slide chassis partway out of the cabinet shell to expose fan motor oil plugs (be careful not to slide chassis out too far). If your air conditioner is not equipped with a slide-out chassis, remove the cabinet.
2. Oil the fan motor per instructions on the motor. To add oil, pull out the oil plug at each end of the motor. An easy to use one-ounce capsule of oil (Part Number 1 0943) is available through your nearest Sears Service Center. Replace oil hole plugs after oiling.

After servicing, reverse the above procedure to reinstall the air conditioner.

HEAVY-DUTY COVER

If you decide to leave your air conditioner installed over the winter months, a Sears Heavy-Duty Cover will help protect your unit and reduce drafts. The cover protects against cold drafts through your air conditioner's air passages and will protect your air conditioner cabinet against: Snow · Rain · Sleet · Rust · Dust.

The Sears Heavy-Duty Cover is easy to install. It is equipped with cords to hold securely throughout winter months. It is made of vinyl coated, durable fabric. The cover is water proof, tear resistant and lightweight for easy storage. It is easily cleaned with soap and water.

WINDOW AIR CONDITIONER COVERS

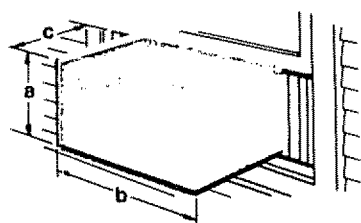

Measure Your
Air Conditioner Cabinet

STOCK #	Description		
	Fits any window unit with these Cabinet Dimensions		
	Height (a)	Width (b)	Outside Ext. (c)
92060	Up to 13"	Up to 20"	Up to 14-3/4"
92020	Up to 19"	Up to 27"	Up to 27"
92040	Up to 19"	Up to 28"	Up to 30"

AIR FILTER

A good clean filter is important for the most cooling with lowest energy consumption. Filters can be cleaned lightly with a vacuum or washed in soap and water. We suggest that they be replaced about once a year.

CUT TO FIT

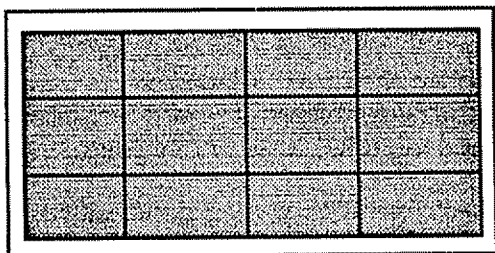

RIGID FRAME FILTERS FOR SEARS DELUXE MODEL AIR CONDITIONERS

Stock #	Description
91551	Rigid plastic frame filter for 5,000 to 9,900 BTUH models
91561	Rigid plastic framed filter for 10,000 to 15,000 BTUH models
91581	Rigid plastic framed filter for 15,100 to 32,000 BTUH models
9186	Foam Filter cut to size - no rigid frame (Fits non-deluxe Sears models)

KIT PARTS

Parts Installation Kits are not included with your air conditioner. They have been made available only as an aid to help you install the air conditioner where special needs may require them. Kits available (not applicable to all models) are an Outside Support Kit, an Outside Sill Bracket Kit, and a Wide Window Kit. Further details and ordering instructions are contained in the Repair Parts List sheet.

KEEP THIS MANUAL FOR READY REFERENCE NOW AND LATER.

NOTES

NOTES

NOTES



Kenmore Automatic Air Conditioner

FULL ONE YEAR WARRANTY ON AIR CONDITIONER

For one year from date of purchase, when this air conditioner is operated and maintained for normal room cooling according to owner's instructions attached to or furnished with the product, Sears will repair this Air Conditioner free of charge, if defective in material or workmanship.

FULL FIVE YEAR WARRANTY ON SEALED REFRIGERATION SYSTEM

For five years from the date of purchase, when this air conditioner is operated and maintained for normal room cooling according to owner's instructions attached to or furnished with the product, Sears will repair the sealed system (consisting of refrigerant, connecting tubing and compressor motor) free of charge, if defective in material or workmanship.

WARRANTY SERVICE IS AVAILABLE BY CONTACTING THE NEAREST SEARS SERVICE CENTER THROUGHOUT THE UNITED STATES.

This warranty gives you specific legal rights, and you may also have other rights which vary from state to state.

Sears, Roebuck and Co. - Dept. 698/731A, Sears Tower - Chicago, IL 60684

"WE SERVICE WHAT WE SELL"

"We Service What We Sell" is our assurance to you that you can depend on Sears for service, and Sears service is nationwide.

Your Kenmore has added value when you consider that Sears has a service unit near you, staffed by Sears trained technicians...professional technicians specifically trained on Sears Appliances, having the parts, tools, and equipment to ensure that we meet our pledge to you... "We Service What We Sell."

To further add to the value of your air conditioner, buy a Sears maintenance agreement.

Sears air conditioners are designed, made and tested for years of dependable operation. Yet any modern appliance may require service from time to time. The Sears Warranty plus the Sears maintenance agreement provides protection from unexpected repair bills.

Free Manuals Download Website

<http://myh66.com>

<http://usermanuals.us>

<http://www.somanuals.com>

<http://www.4manuals.cc>

<http://www.manual-lib.com>

<http://www.404manual.com>

<http://www.luxmanual.com>

<http://aubethermostatmanual.com>

Golf course search by state

<http://golfingnear.com>

Email search by domain

<http://emailbydomain.com>

Auto manuals search

<http://auto.somanuals.com>

TV manuals search

<http://tv.somanuals.com>