

SEARS Kenmore

CONTENTS

SAFETY

1-3

USE AND CARE

Your Range and Its Features	4
Oven Ignition	7
Oven Vent	4, 7
Oven Control	7, 16
Clock and Timer	5
Cooktop Control	6
Oven Cooking	7, 8
Broiling	9

CLEANING

The Continuous-Cleaning Oven	10
Cleaning Tips	11
Removable Range Parts	12-15

SERVICE

What to Do Before Calling for Service	16, 17
Thermostat Adjustments	17

WARRANTY

MODEL 911.36320 90

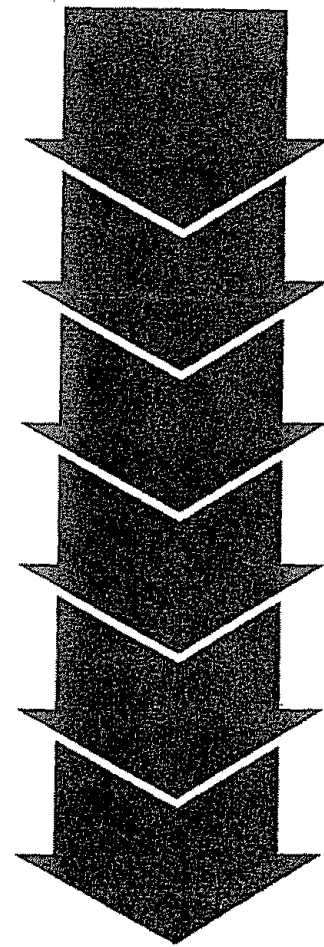

USE • CARE • SAFETY MANUAL

MNM225(SR10053)

IMPORTANT IMPORTANT IMPORTANT IMPORTANT IMPORTANT IMPORTANT IMPORTANT IMPORTANT IMPORTANT

IMPORTANT INSTRUCTIONS FOR YOUR SAFETY

SAVE THESE INSTRUCTIONS

Read all instructions before using this appliance. When using electrical appliances, basic safety precautions should be followed, including the following:

WARNING: If the information in this manual is not followed exactly, a fire or explosion may result causing property damage, personal injury or death.

— Do not store or use gasoline or other flammable vapors and liquids in the vicinity of this or any other appliance.

— WHAT TO DO IF YOU SMELL GAS

- Do not try to light any appliance!
- Do not touch any electrical switch; Do not use any phone in your building!
- Immediately call your gas supplier from a neighbor's phone. Follow the gas supplier's instructions!
- If you cannot reach your gas supplier, call the fire department.

— Installation and service must be performed by a qualified installer, service agency or the gas supplier.



WARNING:

L. P. Burner Adjustments

The adjustments in the Installation Instructions must be made before you try to use your range.

If you are using Liquefied Petroleum Gas (bottled gas) all L. P. adjustments in the Installation Instructions must be made before use.

If your range is not properly adjusted, flames may be too high, or the range may use too much fuel, release toxic fumes or cook poorly.

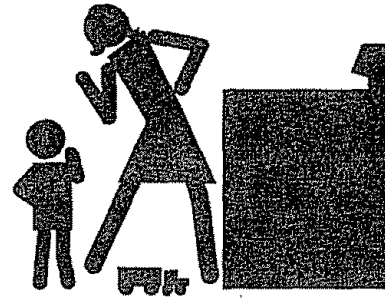

Teach children not to play with control knobs or any other part of the range.

Never leave children alone or unattended where a range is in use.

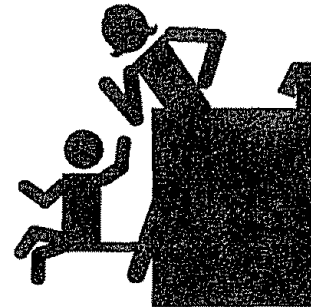

Never let anyone climb, sit or stand on an open oven door or any part of the range.

WARNING:

To prevent accidental tipping of the range from abnormal usage, including excess loading of the oven door, attach it to the wall or floor by installing the anti-tip device supplied. If the range is moved for cleaning, servicing or any reason, be sure anti-tip device is re-engaged properly when the range is replaced. Failure to take this precaution could result in tipping of the range and cause injury.

IMPORTANT IMPORTANT IMPORTANT IMPORTANT IMPORTANT IMPORTANT IMPORTANT IMPORTANT IMPORTANT

To insure safety for yourself and your home, please read your Owner's Manual carefully. Keep it handy for quick easy reference. Pay close attention to the safety sections of your manual. You can recognize the safety sections by looking for the  symbol or the word "Safety".

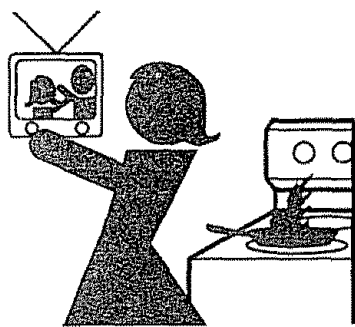

Never leave cooktop elements/burners unwatched at high heat settings. Boilovers cause smoking and greasy spillovers could catch fire.



Never use a towel or other bulky cloth as a potholder. Such cloths could catch fire.

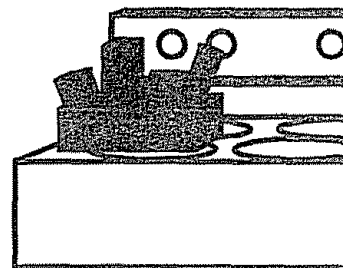

Always keep the range area clear and free from things that will burn.

CAUTION:

Never store things in an oven or near cooktop elements/burners. These things may catch fire and plastic items could melt.



Never use your range for warming or heating a room. You could be burned or seriously injured. Such misuse could also cause damage to the range.

Never leave the oven door open when you are not watching the range.

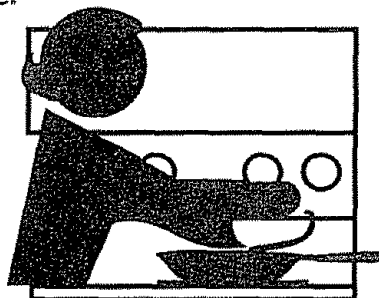

Never wear loose clothing when using your range. Such clothing could catch fire.



Never let pot handles stick out over the front of the range. Turn handles in so that they cannot be bumped into. Keep the handles away from other hot surface elements/burners.

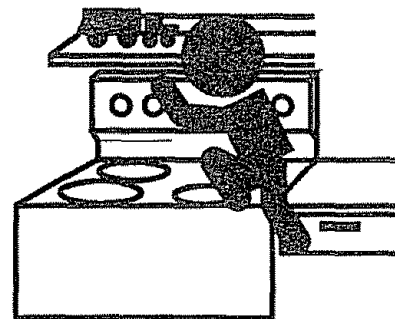

Never store things children might want above a range.

CAUTION:

Do Not store items of interest to children above a range or on the backguard of a range.

Children climbing on a range to reach such items could be seriously injured.

IMPORTANT SAFETY INSTRUCTIONS

Keep this book for later use.

Be sure your oven is installed and grounded properly by a qualified technician.

Always keep the oven area clear and free from things that will burn, gasoline and other flammable vapors and liquids.

After broiling, always take the broiler pan out of the oven and clean it. Leftover grease in the broiler pan can catch on fire next time you use the pan.

Always use dry potholders when removing pans from the oven. Moist or damp potholders can cause steam burns.

Always use care when opening oven door. Let hot air and steam out before moving food.

Always follow cleaning instructions in this book.

Teach children not to play with oven controls or any other part of the oven.

Be sure the oven is securely installed to a cabinet that is firmly attached to the house structure. Weight on the oven door could potentially cause the oven to tip and result in injury. Never allow anyone to climb, sit, stand, or hang on the oven door.

Always keep the oven clean. Food and grease are easy to ignite. Clean the oven regularly.

Always keep combustible wall coverings, curtains or drapes a safe distance away from your oven.

Always keep dish towels, dish cloths, potholders and other linens a safe distance away from your oven. Never store such items in your oven.

Always keep wooden utensils, plastic utensils or canned food a safe distance away from your oven.

Place oven racks in desired position while oven is cool. If rack must be moved while oven is hot, do not let potholder contact burner in oven.

Always keep the appliance area clear and free from things that will burn, gasoline and other flammable vapors and liquids.

Never try to repair or replace any part of the oven unless instructions are given in this book. All other work should be done by a qualified technician.

Never heat unopened food containers. Pressure buildup may make container burst and cause injury.

Never leave jars or cans of fat or drippings near the oven.

Never let grease build up on your oven. You can keep grease fires from starting if you clean up grease and spills after each oven use.

Never use aluminum foil to line oven bottoms. Improper use of foil could start a fire and cause incomplete combustion.

Never block the flow of combustion and ventilation air through oven vents.

Never try to move a pan of hot fat, especially a deep fat fryer. Wait until the fat has cooled.

Never leave children alone or unattended where a oven is in use.

Never wear loose fitting or hanging clothes when using your oven. Such clothes could catch fire and cause serious injury.

Never use a towel or other bulky cloth as a potholder. Such cloths could catch fire on a burner.

Never store things in an oven.

DO NOT USE OVEN CLEANERS — No commercial oven cleaner or oven liner protective coating of any kind should be used in or around the continuous-cleaning oven finish. See cleaning instructions.

Be sure everyone in your home knows what to do in case of fire!!

Never use water on a grease fire—it will only spread the flames.

OVEN FIRE

Do not try to move the pan.

1. Close oven door and turn controls off.
2. If fire continues, throw baking soda on the fire or use a dry chemical foam or halon type extinguisher.

IMPORTANT SAFETY NOTICE

The California Safe Drinking Water and Toxic Enforcement Act requires the Governor of California to publish a list of substances known to the state to cause cancer, birth defects, or other reproductive harm and requires businesses to warn customers of potential exposure to such substances. Gas appliances can cause minor exposure to four of these substances, namely benzene,

carbon monoxide, formaldehyde and soot, caused primarily by the incomplete combustion of natural gas or L.P. fuels. Properly adjusted ranges, indicated by a bluish rather than a yellow flame, will minimize incomplete combustion. Exposure to these substances can be minimized further by venting with an open window or using a ventilation fan or hood.

YOUR RANGE

NOTE: The model and serial number of your range can be found on a tag behind the broiler drawer on the left side of the range front frame. To locate tag, open the broiler drawer.

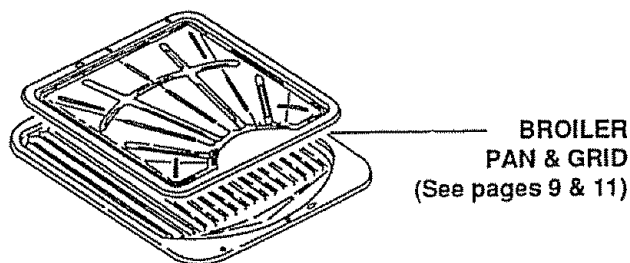
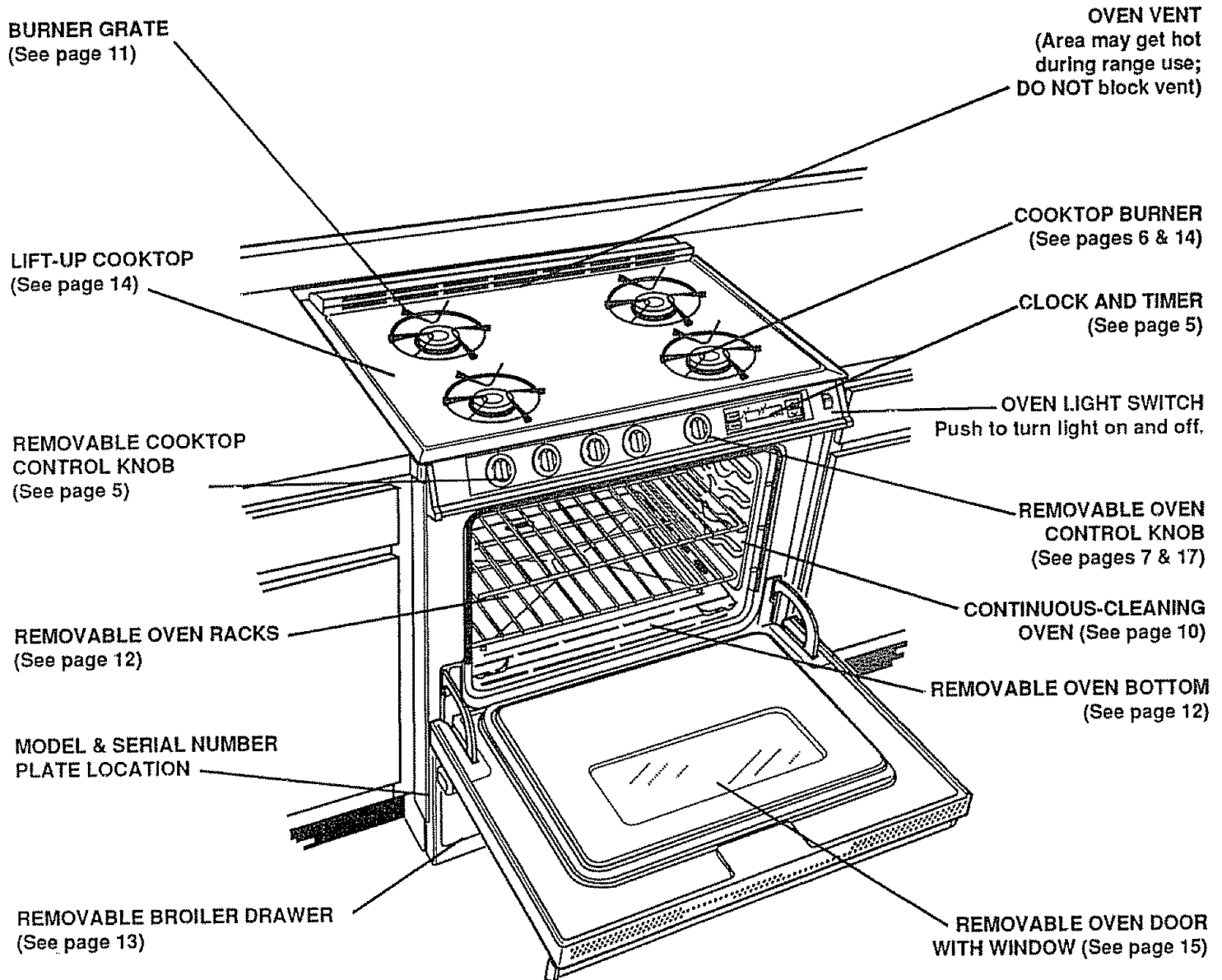

CLOCK AND TIMER

The CLOCK and TIMER are operated by four touchpads.

The CLOCK and TIMER do not control the oven.

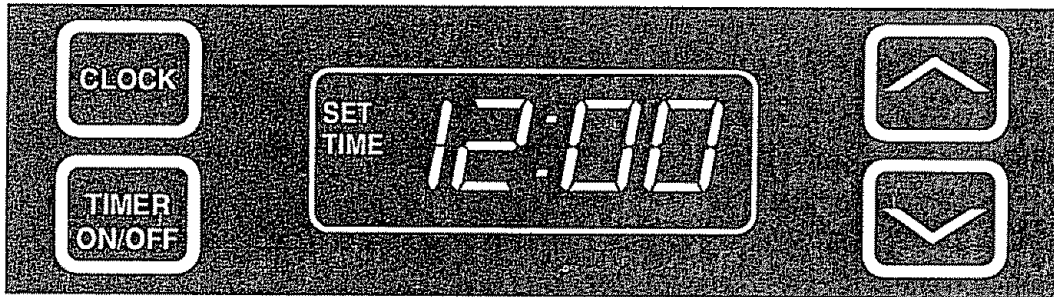

TO SET THE TIME OF DAY CLOCK

1. Press **CLOCK**.
"12:00" stops flashing and "SET TIME" flashes.
2. Use the **UP** or **DOWN** touch pad to set the correct time of day.
3. The clock will start keeping time and the words "SET TIME" will disappear within the next 60 seconds.

TO RESET THE TIME

To reset the TIME use the **UP** or **DOWN** touch pad. "SET TIME" will flash and you can change the time. The TIME will count down from the new time you select and "SET TIME" will disappear in about 4 seconds.

END-OF-CYCLE TONE

The **END-OF-CYCLE** tone will sound when the **TIMER** countdown is complete. The display will show ".00" and you will hear a series of beeps. Press **TIMER ON/OFF** or **CLOCK** to stop the tone.

TO SET THE TIMER

The **TIMER** displays hours and minutes. The maximum setting is 9 hours and 45 minutes on the **TIMER**. Seconds will be displayed during the countdown of the last minute only. The **TIMER** will beep when one minute remains in the countdown. Seconds will be displayed during the last minute countdown.

1. Press **TIMER ON/OFF**. "00" appears and "SET TIMER" flashes.
2. Select the desired time using the **UP** or **DOWN** touch pad. The **TIMER** will begin to count down and "SET TIMER" will disappear about 4 seconds after you select the time. If you do not wish to wait 4 seconds press **TIMER** and the countdown will begin immediately.

TO CANCEL THE TIMER

If you wish to cancel the **TIMER** while it is counting down press **TIMER ON/OFF**. The word "TIME" will disappear from the display and the display will return to the time of day.

If you wish to cancel the **TIMER** while "SET TIMER" is flashing in the display, press **TIMER ON/OFF** twice.

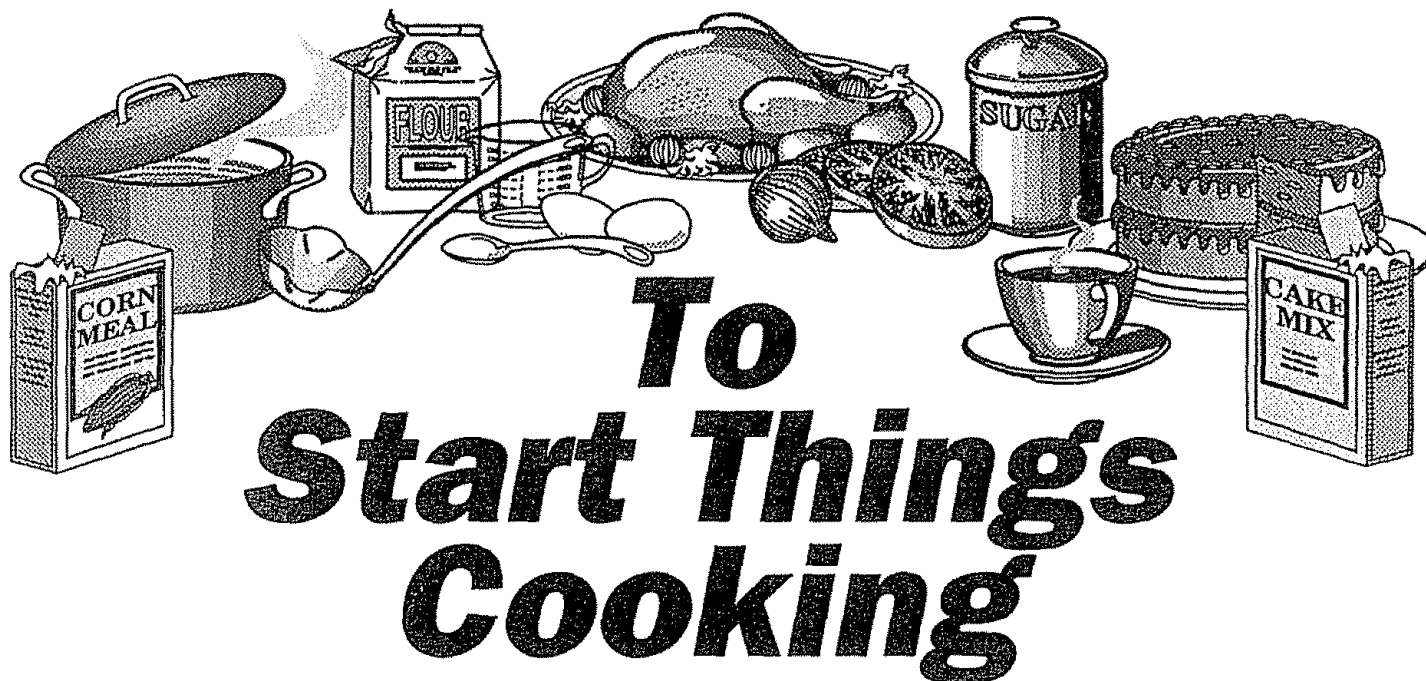

To Start Things Cooking

COOKTOP

TO OPERATE CONTROLS—The sign near each cooktop control knob shows which burner is turned on by that knob.

1. Push to turn knob left to LITE.
2. After the burner lights, turn knob to desired flame setting.

IMPORTANT: Do not leave the knob on LITE after the burner lights, or life of the spark igniter may be shortened.



As a safety precaution you should set controls so flame heats pan bottom only and does not lick pan sides. Flames licking pan sides are unsafe and waste heat.

If a cooktop burner fails to light within five seconds, turn the knob to OFF and wait one minute before trying again. If the burner still will not light, check the service section in this manual.

Watch foods when heating them quickly on HI. As soon as the food reaches cooking temperature, turn down the heat to the lowest setting that will keep it cooking.

High flame may be used to boil large quantities quickly. It is also used to start food cooking quickly in large pans.

Medium flame may be used for even browning with little spattering. It is also used to maintain a boil with large quantities of food.

Low flame may be used for melting or warming food. It is also best for cooking small quantities of food.

WOK COOKING

We recommend that you use only a flat-bottomed wok. flat-bottomed woks are available at your local retail store.

Do not use woks which have support rings. Use of these types of woks, with or without the ring in place, can be dangerous. Placing the ring over the burner grate may damage the burner grate and burner head. Also, placing the ring over the burner grate may cause the burner to work improperly resulting in carbon monoxide levels above allowable current standards. This could be dangerous to your health. See the Safety Section of this manual. Do not try to use such woks without the ring. You could be seriously burned if the wok tipped over.

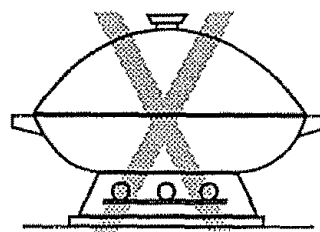
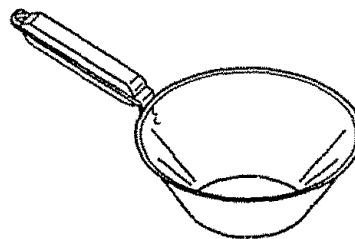

OVEN

To use your Oven or Broiler:

1. Push in and turn to set the OVEN CONTROL to desired temperature or to BROIL. When broiling, be sure to set the knob to the mark in the BROIL section of the knob.
2. When finished, turn OVEN CONTROL to OFF.

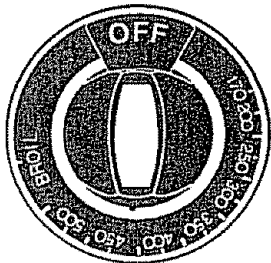

OVEN CONTROL

BURNER IGNITION

COOKTOP SPARK IGNITION— When you turn the cooktop knob to LITE, the spark igniter makes a series of electric sparks (ticking sound) which light the burner.

During a power failure the burners will not light automatically. In an emergency, a cooktop burner may be lit with a match by following the steps in the next column.



Lighting gas burners with a match is dangerous. You should match light the cooktop burners only in emergency.

1. Light a match and hold the flame near the burner you want to light. Wooden matches work best.
2. Push in and turn the control knob slowly. Be sure you are turning the correct knob for the burner you are lighting.

NOTE: If the burner does not light within five seconds, turn the knob off and wait one minute before trying again.

OVEN SPARK IGNITION— When you turn the Oven Control on, the oven spark igniter makes a series of electric sparks (ticking sound) which light the pilot light. About 1 minute after the pilot light is lit, the burner will light.

During a power failure the oven burner will not light automatically.



Do not try to manually light oven burners with spark ignition. Doing so could severely injure you.

Be sure that cooktop and oven burners are adjusted properly. See the Installation Instructions packed with your range for information. See the cleaning section for information of cleaning cooktop burners.

A clean, properly adjusted burner will light faster, use less gas and give better cooking results.

OVEN VENT

When the oven is on, heated air moves through a vent behind the cooktop. On the cooktop, this hot air may make pot handles hot or melt plastic items left too near the vent.

The vent is necessary for proper air circulation in the oven and good baking results. Do not block this vent. Doing so may cause cooking failure, fire or damage to the range.

OVEN VENT

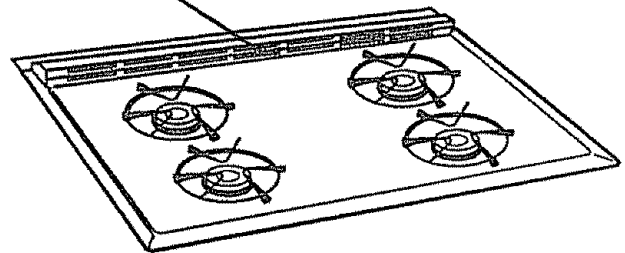

MOISTURE

As your oven heats up, the temperature change of the air in the oven may cause water droplets to form on the door or door glass. To prevent this, open the oven door for the first minute of oven heat up to let the moist air out.

OVEN COOKING

- When cooking a food for the first time in your new oven, use time given on recipes as a guide.

Your new oven has been set correctly at the factory and is more apt to be accurate than the oven it replaced.

After you have used your oven for awhile, if you feel your oven should be hotter or cooler, you can adjust it yourself. See THERMOSTAT ADJUSTMENTS in this manual.

- Always follow recipe carefully.
- Measure ingredients properly.
- Use proper pan placement.
- Place pans on the oven racks with 1" to 1 1/2" of air space on all sides of each pan. Avoid overcrowding the oven.
- Pans too close to each other, to oven walls or to the oven bottom, block the free movement of air. Improper air movement causes uneven browning and cooking.



2 cake layers

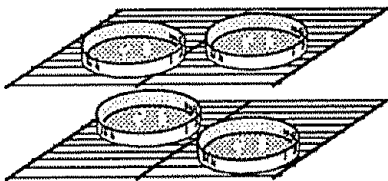

4 cake layers

- When baking several items stagger pans so that no pan is directly above another.
- Let the oven preheat thoroughly before cooking baked products. Allow 10 minutes for preheating.
- Opening the door too often to check food during baking will allow heat loss and may cause poor baking results.

- Cakes, cookies, muffins, and quick breads should be baked in shiny pans — to reflect the heat — because they should have a light golden crust. Yeast breads and pie crusts should be baked in glass or dull (non-shiny) pans — to absorb the heat — because they should have a brown, crisp crust.
- Be sure the underside of the pan is shiny, too. Darkened undersides will absorb the heat and may cause over browning on the bottom of your food.

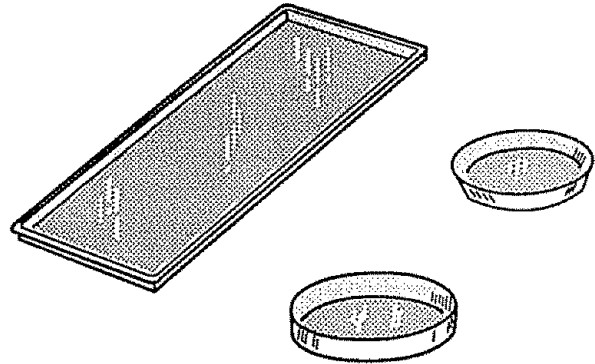

- Oven temperatures should be reduced 25 degrees below recommended temperatures if exterior of pan is predarkened, darkened by age or oven proof glass.
- There may be some odor when the oven is first used. This is caused by the heating of new parts and insulation.
- Do not cover an entire oven rack with foil. The foil can block normal heat flow and cause poor baking results. Do not place any foil directly on the oven bottom. Foil used on the oven bottom may damage the oven surface; therefore, it should not be used.
- Cookies should be baked on flat cookie sheets without sides to allow the air to circulate properly.
- When recipes require preheating, have food nearby before you open the oven door. If the oven door is allowed to remain open for more than a brief time, the preheat temperature will be lost.

BROILING

- Broiling is cooking by direct heat from the broil burner. Tender cuts of meat or marinated meat should be selected for broiling. For best results steaks and chops should be at least 3/4" thick.
- After placing food on the broiler pan, put the pan on the rack in the lower broiler compartment. The recommended rack position and cooking time can be found in the chart at right.
- The closer the food is to the broil burner, the faster the meat browns on the outside, yet stays red to pink in the center. Moving the meat farther away from the burner lets the meat cook to the center while browning outside. Side one should be cooked 1 - 2 minutes longer than side two.



Your oven and broiler doors should be completely closed while broiling.

- Use only the broiler pan and grid that came with your range for broiling. They are designed for proper drainage of fat and liquids and help prevent spatter, smoke or fire.
- **Do not preheat when broiling.** Preheating may cause the thermostat to cycle the broil burner off and on. For even broiling on both sides, start the food on a cold pan.
- Trim the outer layer of fat from steaks and chops. Slit the fatty edges to keep the meat from curling.
- For maximum juiciness, salt the first side just before turning the meat. Salt the second side just before serving.
- Brush chicken and fish with butter several times as they broil. When broiling fish, grease the grid to prevent sticking and broil with skin side down. It is not necessary to turn fish.
- Never leave a soiled broiler pan in the range. Grease in the pan may smoke or burn the next time the oven is used.
- Be sure you know the correct procedure for putting out a grease fire. See the section on safety.



Do not cover the entire broiler grid with foil. Poor drainage of hot fat may cause a broiler fire.

If a fire starts, close the oven door and turn controls off. If fire continues, throw baking soda on the fire. Do not put water on the fire.

POSITIONING BROILER PAN

After placing food on the broiler pan, slide the pan into the proper rack position in the lower broiling compartment.

Be sure the sump (grease well) in the pan is to the front of the range.

Food	Rack Position 3 = Highest 1 = Lowest	Total Time (minutes)
Steak – 1" Thick		
Rare	3	10-12
Medium	3	14-16
Well Done	2	20-22
Ground Beef Patties		
Medium	3	11-13
Well Done	3	13-15
Lamb Chops – 1" Thick	2	16-20
Pork Chops – 1" Thick	2	20-25
Pork Shoulder Steaks	2	15-20
Ham Slice – 1/2" Thick	3	14-16
Fish (Fillets)	2	10-15
Chicken (Halves)	1	40-60
Frankfurters	2	10-15
Bacon	2	5-7
Open-face Sandwiches	2	6-10

This chart is a general guide. The size, weight, thickness, and starting temperature of the food as well as your own personal preference will affect the cooking time. Times in the chart are based on the food being at refrigerator temperature.

CONTINUOUS-CLEANING OVEN FINISH (some models)

The rough surfaces in your oven have a continuous-cleaning finish. Spatters spread and fill the pores of this special finish and then gradually burn away at medium to high temperatures.

Heavy spillovers or boilovers need a little help from you:

- Use clear water and a detergent or a cleanser such as Fantastik®, Liquid Ajax®, Top Job®, Liquid Lysol® or Mr. Clean®, mixed in water, and a soft cloth or nylon brush to clean any heavy spillovers.
- Do not use paper towels or sponges because particles of these materials will rub off and clog the pores of the oven finish.
- Crusty and varnish-like stains clog the pores in the finish and must be removed or broken up before cleaning takes place. They can be loosened by gently tapping the stain with a wooden or plastic utensil.
- After cleaning the oven surface, rinse it well using three tablespoons of vinegar mixed with a quart of cold water. Blot up excess liquid.
- Never scrape or use abrasive materials such as scouring powders, commercial oven cleaners or steel scouring pads for cleaning up spillovers. These materials will scratch and damage the finish.

The remaining soil will gradually burn off with normal oven use.

The oven will appear presentably clean, but some spatters may be present.

The higher the oven temperature, the faster the cleaning action. Cleaning time depends on type and amount of soil, oven temperature and length of oven use.

If stubborn stains remain after normal oven use, you can operate the oven empty at 400°F for additional continuous cleaning action.

Some foods may leave a discoloration even when the surface is clean.

The continuous-cleaning process is illustrated below:

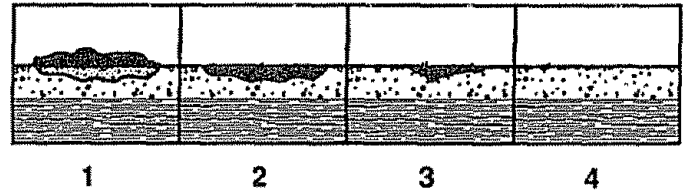

1. A spillover has formed a mound of soil.
2. The spillover has been wiped up.
3. Amount of soil remaining after four hours of oven use at 400°F.
4. After eight hours of oven use at 400°F, the soil is removed.

You can protect the oven bottom from spillovers by using a piece of foil under your utensil. Cut the foil slightly larger than the pan and turn up the edges. Use two oven racks and put the foil on the lower rack below the pan. **Do not use foil on the same rack as the pan. This will reflect heat away.**



Do not cover an entire oven rack with foil. The foil can block normal heat flow and cause poor baking results. Do not place any foil on the oven bottom. Foil used on the oven bottom may damage the oven surface; therefore, it should not be used.

Avoid spilling salt on the continuous-cleaning finish. Salt may become trapped in the pores and may cause rusting.

Never use oven cleaner on the continuous-cleaning finish. Such cleaners will damage the finish.

PORCELAIN REMOVABLE OVEN BOTTOM

Remove the porcelain oven bottom from the oven for cleaning. It can be cleaned with abrasive cleaners, soap-filled pads or oven cleaner. See next page for instructions.

CLEANING TIPS

Refer also to next page when cleaning your range.

Warm water, a mild detergent and a soft cloth are safe to use on all cleanable parts of your range. Do not use metal scouring pads, except where recommended.

Cooktop finishes will be either porcelain enamel or brushed chrome. Porcelain enamel looks like a painted surface. Brushed chrome has a metallic appearance.

PART	CLEANING MATERIALS	REMARKS
Control panel and knobs	Detergent, warm water, soft cloth	Do not use abrasive cleaners. Knobs pull off for easier cleaning.
Porcelain enameled cooktop, chrome drip bowls (some models), burner grates	Detergent, warm water, plastic or nylon scouring pad	Clean after each spillover. Rub chrome bowls (some models) gently with scouring pad. Soak stubborn soil. Bowls can be removed during burner use to keep clean and to avoid discoloration caused by excessive heat. Clean acid spills quickly.
Cooktop burners	Detergent, warm water, plastic or nylon scouring pad or boil in Dip-it® solution to remove stubborn soil	Do not use all-purpose cleaners, ammonia, powder cleansers or oven cleaners. Such products can scratch or discolor the burners. To use Dip-it® solution, remove burners and boil for 20 minutes in 2 tbsp. Dip-it® granules per quart of water. Boil with burner head down. Rinse thoroughly, drain and completely dry burners in a 200°F oven for 1/2 hour. After cleaning or a spillover, light the burners and make sure that no ports are clogged (see next page).
Porcelain enamel oven finish, broiler compartment	Detergent, warm water, scouring pad or soap-filled steel wool pad or oven cleaner	When using oven cleaner, follow manufacturer's instructions. Oven bottom can be removed for easier cleaning. Rinse thoroughly after cleaning.
Oven racks	Detergent, warm water, scouring pad or soap-filled steel wool pad	Remove from oven to clean. Rinse thoroughly.
Broiler pan and grid	Detergent, water, soap-filled scouring pad, commercial oven cleaner (pan only)	Remove soiled pan from oven to cool. Drain fat or drippings. Fill pan with warm water. Sprinkle grid with detergent and cover with damp cloth or paper towels. Let pan and grid soak for a few minutes. Rinse or scour as needed. Dry well. Grid and pan may be washed in a dishwasher.
Burner box bottom (area under cooktop)	Detergent, warm water	Clean after each spillover with detergent and warm water. Dry well.
Porcelain oven bottom	Soap and water, a mild abrasive cleaner, soap-filled scouring pad or commercial oven cleaner	Spillovers of hot fruit fillings or foods with acidic content (such as tomatoes, milk, vinegar or lemon juice) may cause pitting to the porcelain enamel surface. Allow oven to cool. Remove oven bottom for cleaning.

REMOVABLE OVEN RACKS

Be careful not to scratch the oven finish when installing or removing oven racks.

To install:

1. Set the raised back edge of the rack on a pair of rack guides.
2. Push the rack in until you reach the bump in the rack guide, then lift the front of the rack a bit and push the rack all the way in.

To remove:

1. Pull the oven rack out, then up.

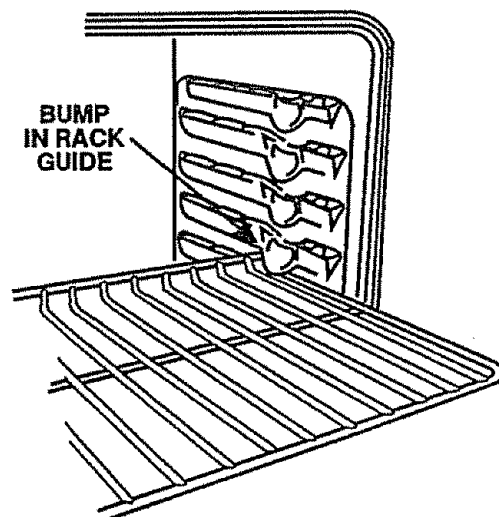

REMOVABLE OVEN BOTTOM

The oven bottom in your range can be removed for easier cleaning.

Be careful not to scratch the oven finish when removing or replacing the oven bottom.

To remove:

1. Grasp oven bottom at finger slots on each side.
2. Lift the front edge of the oven bottom enough to raise the tabs from the slots in the front frame.
3. Push the oven bottom back about 1/4" to release the flange from the front frame, then pull out.

To replace:

1. Slide the oven bottom into the oven so the back tabs fit into the slots in the oven back.
2. Grasp at finger slots and push the oven bottom back and then down to hook the flange under the front frame.
3. Fit the front tabs into the slots in the front frame.

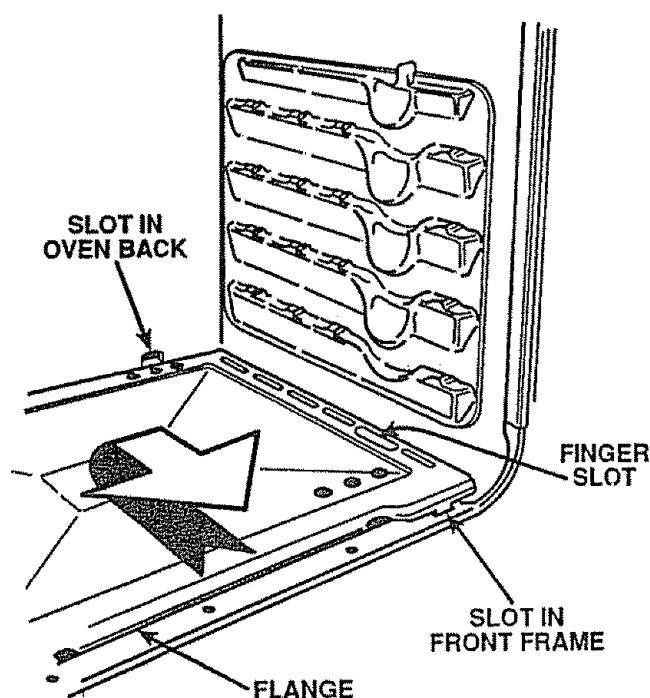

REMOVABLE OVEN DOOR

To remove:

1. Open the door to the stop position (see illustration). STOP (BROIL) POSITION
2. Grasp the door at each side and lift up and off the hinges.

NOTE: When the door is removed and hinge arms are at stop position, do not bump or try to move the hinge arms. The hinges could snap back causing an injury to the hands or damage to the porcelain on the front of the range. Cover the hinges with toweling or empty towel rolls while working in the oven area.

To replace:

1. Hold the door over the hinges with the slots at the bottom edge of the door lined up with the hinges. The hinge arms must still be in the stop position.
2. Slide the door down onto the hinges as far as it will go and close the door.

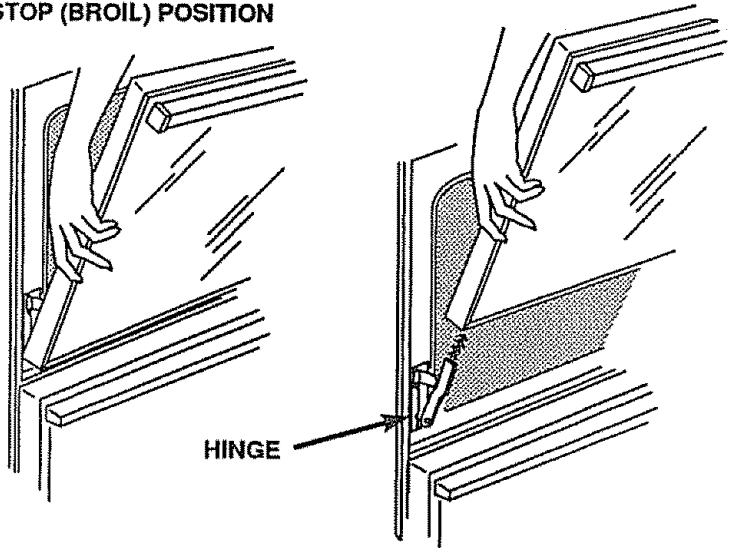

REPLACING THE OVEN LIGHTS

Do not touch hot oven bulb. Do not touch bulb with wet hands. Never wipe oven light area with wet cloth.

Never touch the electrically live metal collar on the bulb when replacing it.

Electrical power must be shut off if you have to replace a broken bulb.

Replace the bulb with a 40 watt appliance bulb. An appliance bulb is smaller than a standard 40 watt household bulb and is made to withstand high oven temperatures and have a much longer bulb life.

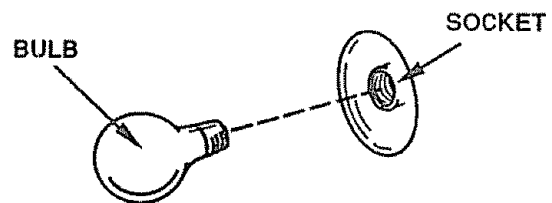



BEFORE CALLING FOR SERVICE

Save time and money — Check this list before you call for service.

To eliminate unnecessary service calls, first, read all the instructions in this manual carefully. Then, if you have a problem, always check this list of common problems and possible solutions before you call for service.

If you do have a problem you cannot fix yourself, call your nearest Sears Store or Service Center for help. When calling, have this manual, the Repair Parts List, model number and purchase date handy.

PROBLEM	POSSIBLE CAUSE	DON'T CALL FOR SERVICE UNTIL YOU CHECK
<ul style="list-style-type: none"> Range does not work; totally inoperative 	<ul style="list-style-type: none"> No power to range 	<ul style="list-style-type: none"> Check power cord to be sure it is plugged in.
<ul style="list-style-type: none"> Cooktop burners and oven burners do not work <div data-bbox="153 793 564 919" style="border: 1px solid black; padding: 5px;">  <p>Oven burners can not be lit during a power failure.</p> </div>	<ul style="list-style-type: none"> Range not properly grounded or polarized; This can affect spark ignition Controls not set correctly Gas not turned on <div data-bbox="598 793 1011 993" style="border: 1px solid black; padding: 5px;">  <p>Warning: Lighting gas burners with a match is dangerous. You should match light the cooktop burners only in emergency.</p> </div>	<ul style="list-style-type: none"> Check installation section in this manual. Check operating instructions in this manual. To check if the gas is turned on, light the cooktop burners with a match by following the steps in the ignition section of this manual. If the burners do not light, check the shut-off valve in the lower compartment (see installation section) and the main gas shut-off valve to be sure they are in the open position.
<ul style="list-style-type: none"> Ticking sound of spark igniter persists after burner lights 	<ul style="list-style-type: none"> Spark igniter not de-activated 	<ul style="list-style-type: none"> Turn burner off and relight. Some ticking is normal. If ticking is excessive, call for service.
<ul style="list-style-type: none"> Cooktop burner does not work; oven OK 	<ul style="list-style-type: none"> Soil clogging holes (ports) in burner or burner not assembled properly Improper operation of control 	<ul style="list-style-type: none"> See the removable cooktop burner section and the cleaning tips in this manual. Be sure to push knob in while turning.
<ul style="list-style-type: none"> Foods do not bake properly 	<ul style="list-style-type: none"> Oven not preheated long enough Improper rack or pan placement Oven vent blocked or covered Improper use of foil Improper temperature setting for utensil used Recipe not followed Improper thermostat calibration Range and oven rack not level Using improper cookware 	<ul style="list-style-type: none"> Be sure to preheat: <ul style="list-style-type: none"> for 10 minutes. Maintain uniform air space around pans and utensils; see oven cooking section. Be sure oven vent (in panel behind cooktop) is not blocked. Foil use not recommended. Reduce temperature 25 degrees for glass or dull/darkened pans. Is recipe tested and reliable? Check oven temperature adjustment procedures (next page). Check Installation Instructions for leveling instructions. See oven cooking section.

BEFORE CALLING FOR SERVICE

PROBLEM	POSSIBLE CAUSE	DON'T CALL FOR SERVICE UNTIL YOU CHECK
<ul style="list-style-type: none"> Foods do not broil properly 	<ul style="list-style-type: none"> Improper rack position Oven preheated Improper utensil used Improper broiling time Oven door open 	<ul style="list-style-type: none"> Check broil pan placement; see Broiling section. Do not preheat when broiling. Use broiler pan and grid supplied with range. Check broiling chart in broiling section. Close door.
<ul style="list-style-type: none"> Oven smokes 	<ul style="list-style-type: none"> Dirty oven Broiler pan full of grease left in oven 	<ul style="list-style-type: none"> Check for heavy spillover. Clean pan and grid after each use. Be sure that sump grease well is to the front of the range when broiling.
<ul style="list-style-type: none"> Oven light or work light does not work (if equipped) 	<ul style="list-style-type: none"> Light switch in off position Light bulb burned out 	<ul style="list-style-type: none"> Check switch setting. Check or replace light bulb; see cleaning and care instructions.
<ul style="list-style-type: none"> Continuous-Cleaning oven finish looks soiled 	<ul style="list-style-type: none"> Heavy spillovers were not wiped up promptly 	<ul style="list-style-type: none"> See Continuous-Cleaning Oven information in cleaning and care section. The continuous-cleaning oven finish will not keep your oven spotless; only presentably clean.

THERMOSTAT ADJUSTMENTS

The temperature in your new oven has been set correctly at the factory, so be sure to follow the recipe temperatures and times the first few times you bake in your new oven.

If you think the oven should be hotter or cooler, you can adjust it yourself. To decide how much to change the temperature, set the oven temperature 25°F higher or lower than the temperature in your recipe, then bake. The results of this "test" should give you an idea of how much the temperature should be changed.

- Use a screwdriver to loosen the two screws about 1 turn each.
- Hold the knob handle (A on illustration) while turning the knob skirt (B on illustration) in the desired direction. As you turn, you should be able to hear clicks and feel notches or teeth. Each click or notch is 10°. You can turn up to 5 clicks or notches in either direction.
- When you reach the desired adjustment, retighten both screws.

To Adjust Knob:

- Turn OVEN CONTROL knob to OFF and remove the knob by pulling straight off.
- Look at the back of the knob. The arrow pointing to the center of the upper screw indicates the original factory setting. The knob can be adjusted up to 50°F hotter or 50°F cooler, in 10° increments.

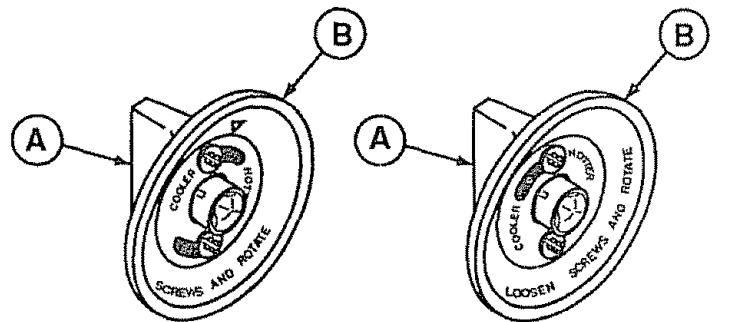

MAKES OVEN COOLER
(Screw Moved Toward Cooler)

MAKES OVEN HOTTER
(Screw Moved Toward Hotter)

NOTES

KENMORE GAS RANGE WARRANTY

Dear Customer:

Our constant efforts are directed toward making sure your new Kenmore Range will arrive at your home in perfect condition and will give you proper performance. As part of these efforts, we feel it is our responsibility to provide you with this warranty for your range.

FULL ONE YEAR WARRANTY ON THE FUNCTIONING OF ALL PARTS EXCEPT GLASS PARTS

If, within one year from the date of installation, any part, other than a glass part, fails to function properly due to a defect in material or workmanship, Sears will repair or replace it, free of charge.

FULL 30-DAY WARRANTY ON GLASS PARTS AND FINISH OF PORCELAIN ENAMEL, PAINTED OR BRIGHT METAL FINISHED PARTS

If, within 30 days from the date of installation, any glass part or the finish on any porcelain enamel, painted or bright metal part is defective in material or workmanship, Sears will replace the part, free of charge.

FULL 90-DAY WARRANTY ON MECHANICAL ADJUSTMENTS

For 90 days from the date of installation, Sears will provide, free of charge, any mechanical adjustments necessary for proper operation of the range, except for normal maintenance.

If the range is subjected to other than private family use, the above warranty coverage is effective for only 90 days.

WARRANTY SERVICE IS AVAILABLE BY CONTACTING THE NEAREST SEARS SERVICE CENTER/DEPARTMENT IN THE UNITED STATES

This warranty applies only while this product is in use in the United States. This warranty gives you specific legal rights, and you may also have other rights which vary from state to state.

SEARS, ROEBUCK and CO.
 Dept. 731 CR-W
 Sears Tower
 Chicago, IL 60684

WE SERVICE WHAT WE SELL

"We Service What We Sell" is our assurance to you that you can depend on Sears for service because Sears service is nationwide.

Your Kenmore Range has added value when you consider that Sears has a service unit near you staffed by Sears trained technicians. . . professional technicians specifically trained on Sears appliances, having the parts, tools and equipment to ensure that we meet our pledge to you — "We Service What We Sell!"

TO FURTHER ADD TO THE VALUE OF YOUR RANGE, BUY A SEARS MAINTENANCE AGREEMENT.

Kenmore Ranges are designed, manufactured and tested for years of dependable operation. Yet, any modern appliance may require service from time to time. The Sears warranty plus the Sears Maintenance Agreement provides protection from unexpected repair bills and assures you of enjoying maximum range efficiency.

Here's a comparative warranty and Maintenance Agreement chart showing you the benefits of a Sears Range Maintenance Agreement.

Years of Ownership Coverage		1st Year	2nd Year	3rd Year
1	Replacement of Defective Parts other than Porcelain or Glass	W	MA	MA
2	Mechanical Adjustment	90 DAYS W	MA	MA
3	Porcelain and Glass Parts	30 DAYS W	MA	MA
4	Annual Preventive Maintenance Check at your request	MA	MA	MA

W - Warranty MA - Maintenance Agreement

CONTACT YOUR SEARS SALESPERSON OR LOCAL SEARS SERVICE CENTER TODAY AND PURCHASE A SEARS MAINTENANCE AGREEMENT.

Kenmore® America's Best Selling Appliance Brand
 Sold by **SEARS, ROEBUCK AND CO., Chicago, IL 60684**

Free Manuals Download Website

<http://myh66.com>

<http://usermanuals.us>

<http://www.somanuals.com>

<http://www.4manuals.cc>

<http://www.manual-lib.com>

<http://www.404manual.com>

<http://www.luxmanual.com>

<http://aubethermostatmanual.com>

Golf course search by state

<http://golfingnear.com>

Email search by domain

<http://emailbydomain.com>

Auto manuals search

<http://auto.somanuals.com>

TV manuals search

<http://tv.somanuals.com>