

SENCO®

FramePro® 502

Operating Instructions
Instrucciones de Operacion
Mode d'Emploi



*Senco Products Inc.
8485 Broadwell Road
Cincinnati, Ohio 45244*

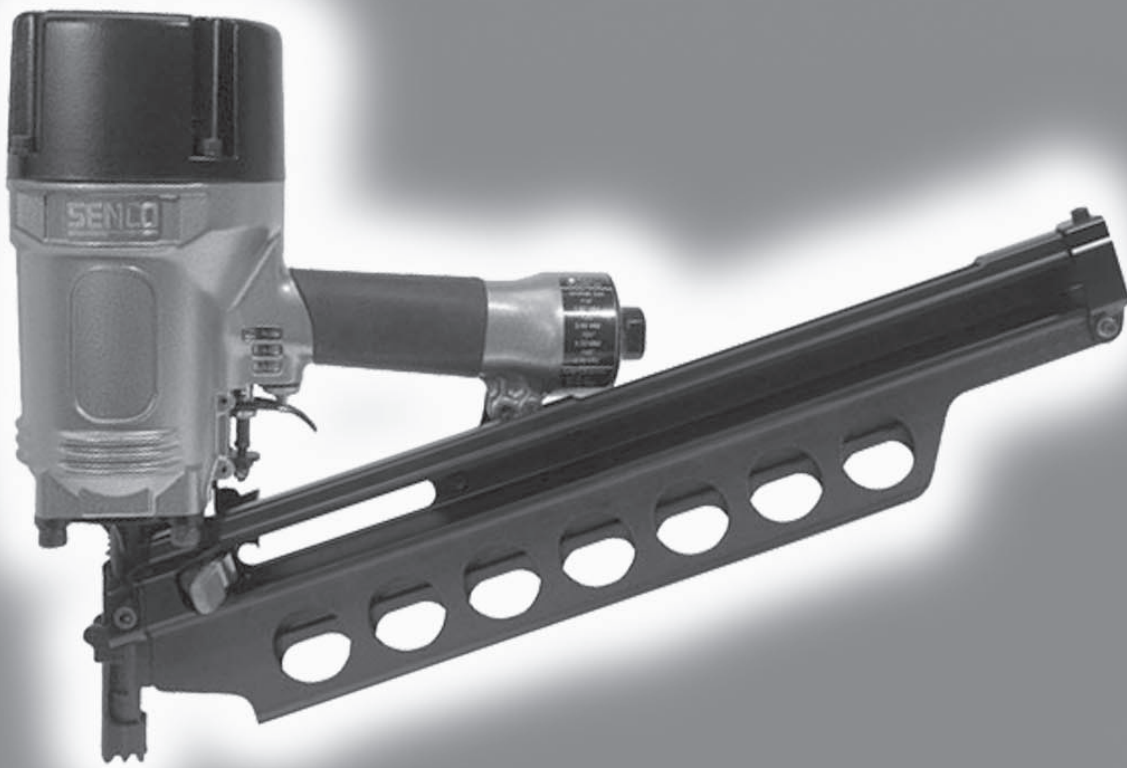

Questions? Comments?

*call SENCOS toll-free Action-line: 1-800-543-4596
or e-mail: toolprof@senco.com www.senco.com*



Warnings for the safe use of this tool are included in this manual.
Los avisos para el uso seguro de esta herramienta están incluidos
en este manual.

Les consignes pour l'utilisation en toute sécurité de cet outil se
trouvent dans ce manuel.

© 2007 by Senco Products, Inc.

NFD84D Issued January 25, 2007

English	Español	Français
---------	---------	----------

TABLE OF CONTENTS	TABLA DE MATERIAS	TABLE DES MATIERÈS	
Tool Use	2	Utilisation de l'outil	2
Maintenance	4	Entretien	4
Troubleshooting	5	Dépannage	5
Specifications	6	Spécifications	6
Options	7	Options	7
Accessories	8	Accessoires	8
	Opciones		7
	Accesorios		8

EMPLOYER'S RESPONSIBILITIES	RESPONSABILIDADES DEL EMPLEADOR	RESPONSABILITÉS DE L'EMPLOYEUR
Employer must enforce compliance with the safety warnings and all other instructions which accompany this tool as shipped from the manufacturer.	El empleador debe hacer cumplir las advertencias de seguridad y todas las otras instrucciones que acompañan a esta herramienta como se la despacha desde el fabricante.	L'employeur doit faire appliquer les consignes de sécurité et toutes les autres instructions qui accompagnent cet outil tel qu'il est livré par son constructeur.
Keep this manual available for use by all people assigned to the use of this tool.	Mantenga este manual disponible para que lo usen todas las personas destinadas a hacer uso de esta herramienta.	Ayez ce manuel à la disposition de toutes les personnes chargées d'utiliser cet outil.
For personal safety and proper operation of this tool, read and understand all of these instructions carefully.	Por razones de seguridad personal y la adecuada operación de esta herramienta, lea y comprenda todas estas instrucciones cuidadosamente.	Pour assurer la sécurité personnelle et le bon emploi de cet outil, lisez et assimilez soigneusement toutes ces instructions.

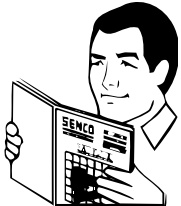
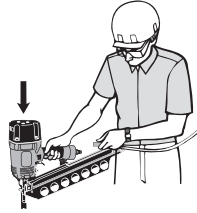
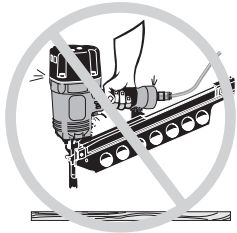
Tool Use	Uso de la Herramienta	Utilisation de l'Outil
English	Español	Français
 <ul style="list-style-type: none"> ● Read and understand "SAFETY INSTRUCTIONS" manual shipped with this tool before using tool. 	<ul style="list-style-type: none"> ● Antes de usar la herramienta lea y comprenda el manual "INSTRUCCIONES DE SEGURIDAD" despachado con ella. 	<ul style="list-style-type: none"> ● Lisez et assimilez le manuel "INSTRUCTIONS DE SÉCURITÉ" livré avec cet outil avant de l'utiliser.
 <ul style="list-style-type: none"> ● Keep tool pointed away from yourself and others and connect air to tool. 	<ul style="list-style-type: none"> ● Mantenga la herramienta apuntando en dirección opuesta de usted y de otros y conecte el aire a la manguera. 	<ul style="list-style-type: none"> ● Maintenez l'outil pointé à l'écart d'autres personnes et de vous-même et raccordez l'air à l'outil.
 <ul style="list-style-type: none"> ● Never use a tool that leaks air or needs repair. 	<ul style="list-style-type: none"> ● Nunca use una herramienta que tenga escapes de aire o que necesite ser reparada. 	<ul style="list-style-type: none"> ● N'utilisez jamais un outil qui a des fuites d'air ou qui a besoin d'être réparé.

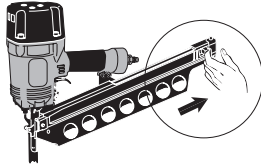
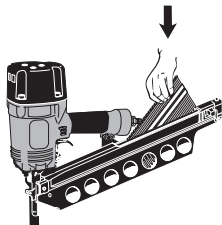
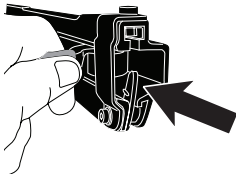
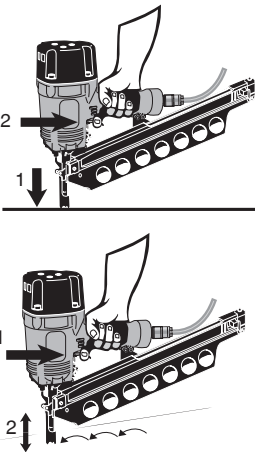
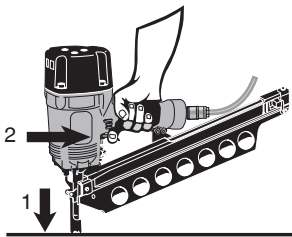
Tool Use	Uso de la Herramienta	Utilisation de l'Outil
English	Español	Français
 <ul style="list-style-type: none"> ● To Load: Pull feeder shoe back into "locked" position. 	<ul style="list-style-type: none"> ● Para cargar: Tire del alimentador hacia atrás hasta la posición "cerrada" ("locked"). 	<ul style="list-style-type: none"> ● Pour charger : Tirez le poussoir en arrière dans la position "verrouillée" ("locked").
 <ul style="list-style-type: none"> ● Insert the nail strip into the top of the magazine. A maximum of two strips can be loaded. 	<ul style="list-style-type: none"> ● Inserte las ristas de clavos una tras otra desde la parte superior del cargador. Usted podrá insertar dos ristas de clavos a la vez. 	<ul style="list-style-type: none"> ● Mettre les recharges de clous une par dans le magasin. Il est possible de mettre deux recharges à la fois.
 <ul style="list-style-type: none"> ● While holding the Feeder Shoe, press the locking lever then slide the Feeder Shoe forward. 	<ul style="list-style-type: none"> ● Sujete el transportador con firmeza y oprima el seguro del transportador. Deslice el transportador hacia adelante hasta que haga contacto con los clavos 	<ul style="list-style-type: none"> ● Appuyer sur le levier d'arrêt et glisser l'alimenteur de clous vers l'avant jusqu'à ce qu'il touche la recharge de clous.
 <ul style="list-style-type: none"> ● With a Contact Actuation (Dual-Action) trigger, nails can be driven two ways: a) Position workpiece contact (safety element) against work surface and pull trigger... "Trigger Fire." b) To drive a nail, pull trigger and push workpiece contact against work surface. Each time the workpiece contact is pushed against the work surface a nail will be driven. This "bottom-fire" mode of operation is preferred when high production, rapid fastener placement is desired. 	<ul style="list-style-type: none"> ● Las herramientas con gatillo de acción doble pueden ser disparadas de dos maneras: a) Oprima el seguro contra la superficie de trabajo y apriete el gatillo...Disparo de gatillo. b) Para impulsar un clavo, oprima el disparador y deprima el elemento de seguridad contra la superficie de trabajo. Cada vez que deprima el elemento de seguridad contra la superficie de trabajo, impulsará un clavo. Este modo de operación de "disparo inferior" o "por rebote" es el preferido cuando se desea alta productividad y rápida colocación del clavo. 	<ul style="list-style-type: none"> ● Les appareils équipés de déclenchement "au touché / par gâchette" peuvent être utilisés de 2 façons différentes : a) Déclenchement par "gâchette" : Appliquer le palpeur de sécurité de l'appareil à l'endroit désiré et activer la gâchette. b) Pour planter un clou, tirez sur la détente et poussez l'élément de sécurité contre la surface de travail. Chaque fois que l'élément de sécurité est poussé contre la surface de travail un clou est planté. Le mode de fonctionnement en "tir continu" est préférable si vous désirez placer des attaches rapidement avec forte productivité.
 <ul style="list-style-type: none"> ● With a Single Sequential (Restrictive) trigger, nails can only be driven one way. 1) First depress workpiece contact (safety element) against work surface 2) then pull trigger. This feature is helpful when precise fastener placement is required. ● Read the "Customer Satisfaction and Safety Reminder" (CSSR) in the tool and fastener boxes for safety information regarding the Dual Action and Restrictive triggers. Under certain conditions, the Restrictive trigger may reduce the possibility of injury to you or to others working with you. 	<ul style="list-style-type: none"> ● Las herramientas con "Gatillo Restringido" solamente se pueden disparar con el gatillo. 1) Primero presione el elemento de seguridad contra la superficie de trabajo y 2) después apriete el gatillo. Esta característica es útil cuando se requiere precisión en la colocación de los sujetadores. ● Lea el "Recordatorio de Seguridad y Satisfacción del Cliente" (CSSR) en las cajas de sujetadores y de las herramientas para información sobre seguridad de los Gatillos Restringido y de Acción Dual. Bajo ciertas condiciones, el Gatillo Restringido puede reducir la posibilidad de heridas a su persona o a otros que trabajen con usted. 	<ul style="list-style-type: none"> ● Avec une gâchette "restrictive", les clous ne peuvent être tirés que dans une seule direction. 1) Appuyer d'abord le palpeur de sécurité sur la surface de travail, 2) puis tirer sur la gâchette. Cette fonction est utile pour un placement précis de projectiles. ● Lire le "Rapport de Sécurité et Satisfaction du Client" (CSSR) dans les boîtes à outils et fixations pour les informations de sécurité concernant les Détonateurs à Double Action et à Restriction. Dans certaines circonstances, la Détente à Restriction peut réduire la possibilité de se blesser ou de blesser d'autres personnes.

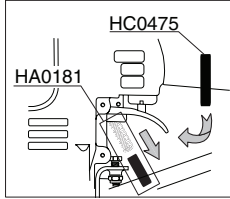
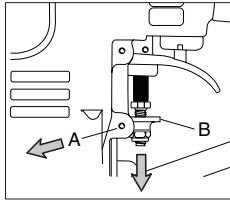

Tool Use	Uso de la Herramienta	Utilisation de l'Outil
English	Español	Français
<ul style="list-style-type: none"> To install the Contact-Actuation Trigger parts: <ol style="list-style-type: none"> 1) Remove Pin "A" 2) Move Part "B" down 3) Remove Sequential Trigger parts (Pin and Spring) HA0181 4) Install Contact-Actuation Pin HC0475 5) Raise part "B" and replace pin "A" <p>Reverse the procedure to re-install the Sequential Trigger parts.</p>	<ul style="list-style-type: none"> Para instalar las piezas del Gatillo de Actuación por Contacto <ol style="list-style-type: none"> 1) Remueva el Pasador "A" 2) Mueva hacia abajo la Pieza "B" 3) Remueva las piezas del Gatillo Secuencial (Pasador y Resorte) HA0181 4) Instale el Pasador de Actuación por Contacto HC0475 5. Suba la pieza "B" y coloque nuevamente el pasador "A" <p>Invierta el procedimiento para re-instalar las piezas del Gatillo Secuencial</p>	<ul style="list-style-type: none"> Pour installer les pièces de contact/déclenchement de la détente : <ol style="list-style-type: none"> 1) Enlevez la goupille A 2) Abaissez la pièce B 3) Enlevez les pièces de détente séquentielle (goupille et ressort) HA0181 4) Installez la goupille de contact/déclenchement HC0475 5) Relevez la pièce B et remettez la goupille A <p>Inversez cette procédure pour remettre en place les pièces de détente séquentielle.</p>

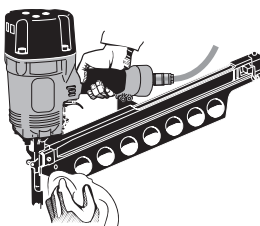
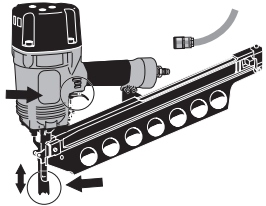
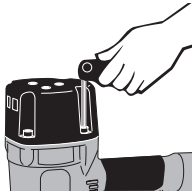
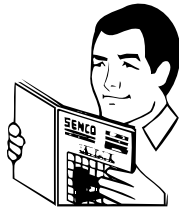

Maintenance	Mantenimiento	Entretien
English	Español	Français
<ul style="list-style-type: none"> Read and understand "SAFETY INSTRUCTIONS" manual shipped with this tool before using tool. 	<ul style="list-style-type: none"> Antes de usar la herramienta lea y comprenda el manual "INSTRUCCIONES DE SEGURIDAD" despachado con ella. 	<ul style="list-style-type: none"> Lisez et assimilez le manuel "INSTRUCTIONS DE SÉCURITÉ" livré avec cet outil avant de l'utiliser.
<ul style="list-style-type: none"> All screws should be kept tight. Loose screws result in unsafe operation and parts breakage. 	<ul style="list-style-type: none"> Todos los tornillos tienen que mantenerse apretados. Los tornillos sueltos pueden producir una operación no segura y quebraduras de partes. 	<ul style="list-style-type: none"> Toutes les vis doivent être maintenues serrées à fond. Les vis desserrées entraînent un manque de sûreté du fonctionnement et la rupture de pièces.
<ul style="list-style-type: none"> With tool disconnected, make daily inspection to assure free movement of workpiece contact and trigger. Do not use tool if workpiece contact or trigger sticks or binds. 	<ul style="list-style-type: none"> Con la herramienta desconectada, haga inspecciones diarias para asegurar el movimiento libre del seguro y del gatillo. No use la herramienta si el seguro o el gatillo se atoran. 	<ul style="list-style-type: none"> L'outil étant séparé de l'alimentation en air, effectuez une inspection journalière pour assurer le libre mouvement du palpeur de sécurité et de la détente. N'utilisez pas l'outil si le palpeur de sécurité ou la détente colle ou se coince.
<ul style="list-style-type: none"> Squirt Senco pneumatic oil (5 to 10 drops) into the air inlet twice daily (depending on frequency of tool use). Other oils may damage O-rings and other tool parts. 	<ul style="list-style-type: none"> Aplique aceite neumático SENCO en la entrada de aire dos veces al día (dependiendo en la frecuencia de uso 5 A 10 Gotas). Otros aceites pueden dañar los anillos en "O" y otras piezas de la herramienta. 	<ul style="list-style-type: none"> Avec une burette, placez 5 à 10 gouttes d'huile pneumatique dans l'arrivée d'air deux fois par jour (dépend de l'intensité de l'utilisation de l'appareil). D'autres huiles pourraient endommager les joints toriques et d'autres pièces de l'outil.
<ul style="list-style-type: none"> Wipe tool clean daily and inspect for wear. Use non-flammable cleaning solutions only if necessary-DO NOT SOAK. Caution: Such solutions may damage O-rings and other tool parts. 	<ul style="list-style-type: none"> Solamente si es necesario use soluciones para limpieza no inflamables -NO LA REMOJE. Precaución: Tales soluciones pueden dañar los empaques y otras partes de la herramienta. 	<ul style="list-style-type: none"> Nettoyez l'outil chaque jour à l'aide d'un chiffon et inspectez-le pour déceler une éventuelle usure. Utilisez uniquement des solvants non inflammables en cas de nécessité-NE LE FAITES PAS TREMPER ! Attention : De tels produits peuvent endommager les joints et autres pièces de l'appareil.

Troubleshooting	Identificación de Fallas	Dépannage
English	Español	Français
<p>WARNING Repairs other than those described here should be performed only by trained, qualified personnel. Contact SENCO for information at 1-800-543-4596.</p> <ul style="list-style-type: none"> ● Read and understand "SAFETY INSTRUCTIONS" manual shipped with this tool before using tool. 	<p>ALERTA Las reparaciones, fuera de aquellas descritas aquí, deben de ser llevadas a cabo solamente por personal entrenado y calificado. Póngase en contacto con SENCO para información 1-800-543-4596.</p> <ul style="list-style-type: none"> ● Antes de usar la herramienta lea y comprenda el manual "INSTRUCCIONES DE SEGURIDAD" despachado con ella. 	<p>AVERTISSEMENT Les réparations autres que celles décrites ici doivent être réalisées uniquement par du personnel qualifié ayant reçu la formation appropriée. Pour toute information, prenez contact avec SENCO par téléphone en appelant Le Distributeur agréé.</p> <ul style="list-style-type: none"> ● Lisez et assimilez le manuel "INSTRUCTIONS DE SÉCURITÉ" livré avec cet outil avant de l'utiliser.
<p>SYMPTOM Air leak near top of tool / Sluggish operation</p> <p>SOLUTION Verify air supply / tighten screws.</p>	<p>SÍNTOMA El aire se escapa cerca de la parte superior de la herramienta / Operación lenta.</p> <p>SOLUCIÓN Apriete los tornillos / Verifique el suministro de aire.</p>	<p>SYMPTÔME Fuite d'air près du sommet de l'outil / fonctionnement lent.</p> <p>SOLUTION Serrez les vis à fond / vérifiez l'alimentation en air.</p>
<p>SYMPTOM Air leak near bottom of tool / Poor return.</p> <p>SOLUTION Clean tool / tighten screws.</p>	<p>SÍNTOMA El aire se fuga cerca de la parte inferior de la herramienta / Mal retorno.</p> <p>SOLUCIÓN Apriete los tornillos / Limpié la herramienta.</p>	<p>SYMPTÔME Fuite d'air près de la base de l'outil / retour inadéquat.</p> <p>SOLUTION Serrez les vis à fond / nettoyez l'outil.</p>
<p>SYMPTOM Other problems.</p> <p>SOLUTION Contact SENCO.</p>	<p>SÍNTOMA Otros problemas.</p> <p>SOLUCIÓN Póngase en contacto con SENCO.</p>	<p>SYMPTÔME Autres problèmes.</p> <p>SOLUTION Prenez contact avec SENCO.</p>

Code	A	
	inches	mm
GD21	2	50
GD24	2 ³ / ₈	60
GD25	2 ¹ / ₂	50
GL21	2	57
GL24	2 ³ / ₈	60
HD27	3	65
HD28	3 ³ / ₈	75
HL27	3	75
KD25	2 ¹ / ₂	50
KD27	3	65
KD28	3 ¹ / ₄	83
KD29	3 ¹ / ₂	90
MD23	2 ¹ / ₄	57
MD27	3	65

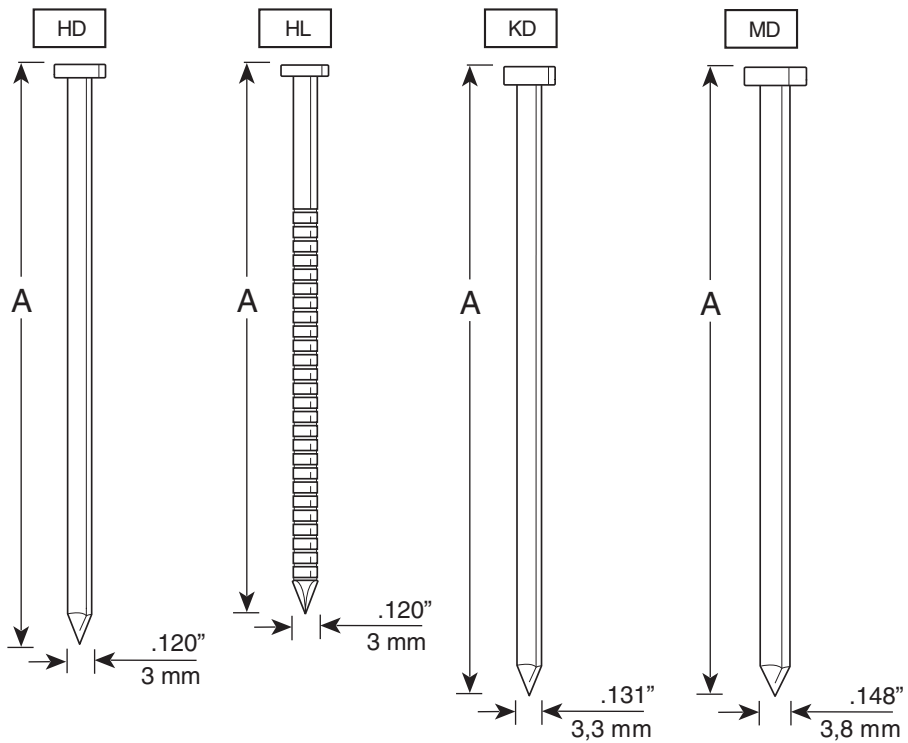
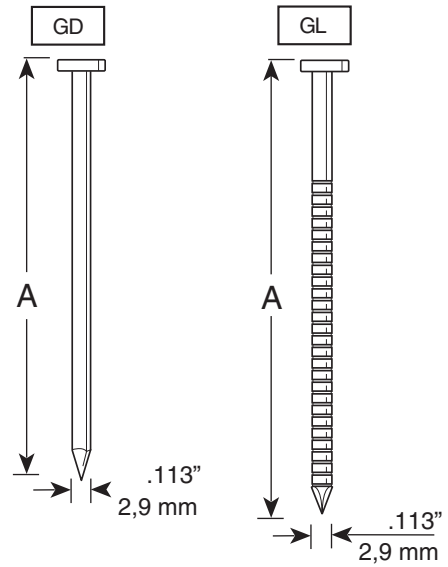

Specifications**Especificaciones****Specifications****English****Español****Français****TECHNICAL SPECIFICATIONS**

Minimum to maximum operating pressure	70–120 psi	4.76–8.3 bar
Air Consumption (60 cycles per minute)	4.98 scfm	141 liter
Air Inlet	$\frac{3}{8}$ in. NPT	$\frac{3}{8}$ in. NPT
Weight	8.6 lbs.	3.9 kg
Fastener Capacity (two strips of 28 + 5)	61	61
Tool size: Height	13.25 in.	337 mm
Tool size: Length	20.25 in.	514 mm
Tool size: Width: Main Body	4.25 in.	108 mm

ESPECIFICACIONES TECNICAS

Presión de operación mínima y máxima	70–120 psi	4.76–8.3 bar
Consumo de aire (60 ciclos por minuto)	4.98 scfm	141 liter
Entrada de aire	$\frac{3}{8}$ in. NPT	$\frac{3}{8}$ in. NPT
Peso	8.6 lbs.	3.9 kg
Capacidad de grapas por cargador	61	61
Tamaño de la herramienta: Altura	13.25 in.	337 mm
Tamaño de la herramienta: Longitud	20.25 in.	514 mm
Tamaño de la herramienta: Ancho (Cuerpo)	4.25 in.	108 mm

SPECIFICATIONS TECHNIQUES

Pression de travail min. et max.	70–120 psi	4.76–8.3 bar
Consommation d'air (60 cycles par minute)	4.98 scfm	141 liter
Admission d'air	$\frac{3}{8}$ in. NPT	$\frac{3}{8}$ in. NPT
Poids	8.6 lbs.	3.9 kg
Capacité de projectiles par magasin	61	61
Dimensions de l'outil: hauteur	13.25 in.	337 mm
Dimensions de l'outil: longueur	20.25 in.	514 mm
Dimensions de l'outil: largeur: corps de l'appareil)	4.25 in.	108 mm

Options**Opciones****Options****English****Español****Français**

● **RESTRICTIVE TRIGGER**— This feature is helpful when precise fastener placement is required.

● **GATILLO RESTRINGIDO**— Esta característica sirve de ayuda cuando se requiere una colocación del sujetador precisa.

● **DECLÉNCHEMENT PAR GACHETTE**— Cette caractéristique s'avère utile quand un placement de projectiles précis s'impose.

Accessories	Accesorios	Accessoires
English	Español	Français
<p>SENCO offers a full line of accessories for your SENCO tools, including:</p> <ul style="list-style-type: none"> ● Air Compressors ● Hose ● Couplers ● Fittings ● Safety Glasses ● Pressure Gauges ● Lubricants ● Regulators ● Filters <p>For more information or a complete illustrated catalogue of SENCO accessories, ask your representative for #MK336.</p>	<p>SENCO ofrece una línea completa de Accesorios para sus herramientas SENCO, incluyendo:</p> <ul style="list-style-type: none"> ● Compresores de Aire ● Manguera ● Conectores Rápidos ● Conectores ● Anteojos De Seguridad ● Manómetros ● Lubricantes ● Reguladores ● Filtros <p>Para mas informacion ó un pour recevoir un catalogo completo ilustrado de los Accesorios SENCO, pregunte a su representante para el numero #MK336.</p>	<p>SENCO offre une gamme étendue d'accessoires pour vos outils SENCO y compris :</p> <ul style="list-style-type: none"> ● Compresseurs ● Tuyauterie flexible ● Raccords ● Lunettes de sécurité ● Manomètres ● Lubrifiants ● Régulateurs ● Filtres <p>Pour plus d'informations ou pour recevoir un catalogue détaillé des accessoires proposés par SENCO, prenez contact avec votre représentant SENCO (référence catalogue : #MK336.).</p>

SENCO TOOL & PARTS WARRANTY

This tool has been designed and constructed using the highest standards of material and workmanship.

TOOL AND PARTS WARRANTY:

The length of this guarantee is **one year** from date of purchase by the **original retail purchaser**. During this period, Senco Products, Inc., will repair or replace at Senco's option, any original part or parts for the original retail purchaser. This will be done free of charge, provided the parts are determined defective in materials or workmanship upon examination by a Senco Authorized Warranty Service Center (exception: rubber o-rings and seals, driver blades). Any replacement part provided will carry a warranty for the balance of the period of warranty applicable to the part it replaces.

This warranty will be honored, only if:

- A) Clean, dry, regulated compressed air has been used, at air pressure not exceeding the maximum indicated on the tool casting;
- B) No evidence of abuse, or failure to follow recommended operational maintenance, or modification of the tool is present (read Operator Manual for use and maintenance instructions);
- C) When repair or replacement of parts or tools is necessary, the original retail purchaser returns the complete tool or part, with transportation prepaid, to the nearest Senco Authorized Warranty Service Center, with purchase receipt or other positive proof that the part or tool is within the warranty period.

THIS WARRANTY IS THE ONLY WARRANTY ON THIS TOOL, AND ALL OTHER WARRANTIES, WHETHER ORAL, WRITTEN, EXPRESS, OR IMPLIED, INCLUDING, BUT NOT LIMITED TO, THE IMPLIED WARRANTY OF MERCHANTABILITY OR PARTICULAR PURPOSE, ARE EXCLUDED. BUYER'S OR USER'S REMEDIES ARE SOLELY AND EXCLUSIVELY AS STATED ABOVE. Senco PRODUCTS, INC. SHALL IN NO EVENT BE LIABLE FOR INCIDENTAL, CONSEQUENTIAL, INDIRECT, OR SPECIAL DAMAGES. IN NO EVENT, WHETHER AS A RESULT OF A BREACH OF CONTRACT, WARRANTY, TORT (INCLUDING NEGLIGENCE) OR OTHERWISE, SHALL Senco'S LIABILITY EXCEED THE PRICE OF THE TOOL WHICH HAS GIVEN RISE TO THE CLAIM OR LIABILITY. ANY LIABILITY CONNECTED WITH THE USE OF THIS TOOL SHALL TERMINATE UPON THE EXPIRATION OF THE WARRANTY PERIOD SPECIFIED ABOVE.

Replacement of Tool Due to Natural Disaster

Senco will also replace any tool destroyed by an Act of God such as flood, earthquake, hurricane or other disaster resulting only from the forces of nature. Such a claim will be honored provided that such original retail purchaser had previously submitted a completed warranty registration card, and then submits proof of ownership and an acceptable statement describing such Act of God documented by an insurance carrier, police department, or other official governmental source. To obtain instructions for filing a claim call 1-800-543-4596.

**SENCO PRODUCTS, INC.
CINCINNATI, OHIO 45244-1611 USA**

Free Manuals Download Website

<http://myh66.com>

<http://usermanuals.us>

<http://www.somanuals.com>

<http://www.4manuals.cc>

<http://www.manual-lib.com>

<http://www.404manual.com>

<http://www.luxmanual.com>

<http://aubethermostatmanual.com>

Golf course search by state

<http://golfingnear.com>

Email search by domain

<http://emailbydomain.com>

Auto manuals search

<http://auto.somanuals.com>

TV manuals search

<http://tv.somanuals.com>