



# HEAVY STAPLERS

Operating Instructions  
Instrucciones de Operacion  
Mode d'Emploi



**SC1**

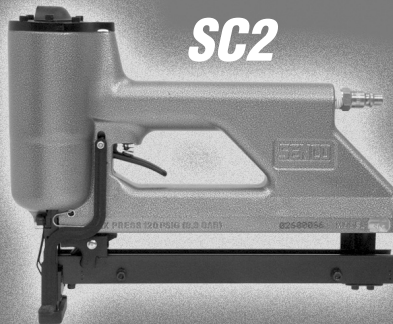

**SC2**

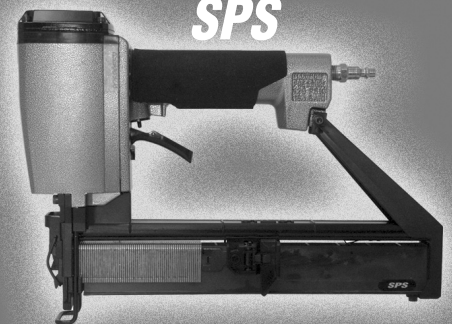

**SPS**



**SNS40/  
SNS45XP**



**SNS41/  
SNS44XP**



**SNS50/  
SQS55**



**PW150 / PW150R  
PW200**



**M2/M3/MW**

Questions? Comments?  
call SENC0's toll-free Action-line: 1-800-543-4596  
or e-mail: [toolprof@senco.com](mailto:toolprof@senco.com) Visit our Website [www.senco.com](http://www.senco.com)



Senco Products, Inc.  
8485 Broadwell Road  
Cincinnati, Ohio 45244

© 2000, 2004 by Senco Products, Inc.



Warnings for the safe use of this tool are included in this manual.  
Los avisos para el uso seguro de esta herramienta están incluidos en este manual.  
Les consignes pour l'utilisation en toute sécurité de cet outil se trouvent dans ce manuel.

HVST060 Revised March 15, 2004  
(Replaces 7/28/03)

English	Español	Français
---------	---------	----------

TABLE OF CONTENTS	TABLA DE MATERIAS	TABLE DES MATIÈRES
Tool Use	1	1
Maintenance	8	8
Troubleshooting	9	9
Accessories	9	9
Specifications	10	10
Options	13	13

EMPLOYER'S RESPONSIBILITIES	RESPONSABILIDADES DEL EMPLEADOR	RESPONSABILITÉS DE L'EMPLOYEUR
Employer must enforce compliance with the safety warnings and all other instructions which accompany this tool as shipped from the manufacturer.	El empleador debe hacer cumplir las advertencias de seguridad y todas las otras instrucciones que acompañan a esta herramienta como se la despacha desde el fabricante.	L'employeur doit faire appliquer les consignes de sécurité et toutes les autres instructions qui accompagnent cet outil tel qu'il est livré par son constructeur.
Keep this manual available for use by all people assigned to the use of this tool.	Mantenga este manual disponible para que lo usen todas las personas destinadas a hacer uso de esta herramienta.	Ayez ce manuel à la disposition de toutes les personnes chargées d'utiliser cet outil.
For personal safety and proper operation of this tool, read and understand all of these instructions carefully.	Por razones de seguridad personal y la adecuada operación de esta herramienta, lea y comprenda todas estas instrucciones cuidadosamente.	Pour assurer la sécurité personnelle et le bon emploi de cet outil, lisez et assimilez soigneusement toutes ces instructions.

Tool Use	Uso de la Herramienta	Utilisation de l'Outil
English	Español	Français

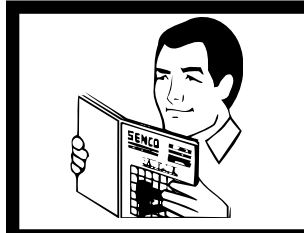

● Read and understand "SAFETY INSTRUCTIONS" manual shipped with this tool before using tool.

● Antes de usar la herramienta lea y comprenda el manual "INSTRUCCIONES DE SEGURIDAD" despachado con ella.

● Lisez et assimilez le manuel "INSTRUCTIONS DE SÉCURITÉ" livré avec cet outil avant de l'utiliser.

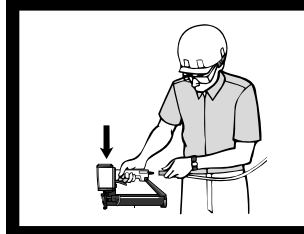

● Keep tool pointed away from yourself and others and connect air to tool.

● Mantenga la herramienta apuntando en dirección opuesta de usted y de otros y conecte el aire a la manguera.

● Maintenez l'outil pointé à l'écart d'autres personnes et de vous-même et raccordez l'air à l'outil.

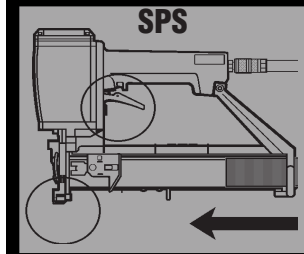

● To Load: Insert strip of staples into rear of magazine. Use only genuine SENCO fasteners. Do not load with safety element or trigger depressed.

● Para cargar: Inserte la tira de grapas en la parte de atrás del área de almacenamiento. Use solamente sujetadores SENCO auténticos. No cargue con el disparo o la seguridad oprimidos.

● Pour charger : Introduisez une bande de agrafes dans la partie arrière du magasin. Utilisez uniquement les véritables agrafes SENCO. Veillez à ne pas appuyer sur le palpeur de sécurité ou sur la détente quand vous chargez.

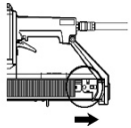
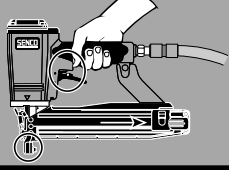
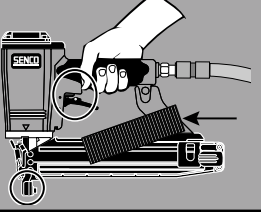
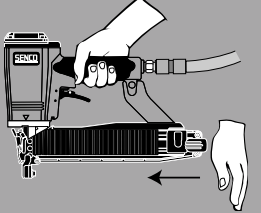
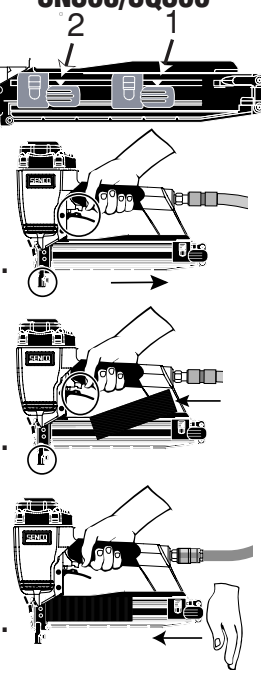
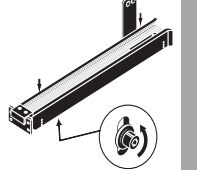
	Tool Use	Uso de la Herramienta	Utilisation de l'Outil
	English	Espanol	Francais
<p><b>SPS</b></p> 	<ul style="list-style-type: none"> <li>● Pull feeder shoe back.</li> </ul>	<ul style="list-style-type: none"> <li>● Tire la zapata del alimentador.</li> </ul>	<ul style="list-style-type: none"> <li>● Tirez le poussoir en arrière.</li> </ul>
<p><b>SNS40/45XP/PW150/PW150R/PW200</b></p> 	<ul style="list-style-type: none"> <li>● To Load: Pull feeder shoe back into "locked" position.</li> </ul>	<ul style="list-style-type: none"> <li>● Para cargar: Tire del alimentador hacia atrás hasta la posición "cerrada" ("locked").</li> </ul>	<ul style="list-style-type: none"> <li>● Pour charger : Tirez le poussoir en arrière dans la position "verrouillée" ("locked").</li> </ul>
	<ul style="list-style-type: none"> <li>● Lay strip of staples onto rail. Use only genuine Senco fasteners. Do not load with safety element or trigger depressed.</li> </ul>	<ul style="list-style-type: none"> <li>● Ponga la tira sobre la guía. Use solamente sujetadores Senco auténticos. No cargue con el disparo o la seguridad oprimidos.</li> </ul>	<ul style="list-style-type: none"> <li>● Mettez une bande de agrafes sur la traverse. Utilisez uniquement les véritables agrafes Senco. Veillez à ne pas appuyer sur le palpeur de sécurité ou sur la détente quand vous chargez.</li> </ul>
	<ul style="list-style-type: none"> <li>● Tap feeder shoe and allow to slide forward.</li> </ul> <p><b>PW150/PW150R/PW200/SNS41/SNS44XP</b></p> <ul style="list-style-type: none"> <li>● Depress feeder shoe lock button and allow to slide forward.</li> </ul>	<ul style="list-style-type: none"> <li>● Empuje el alimentador hacia abajo y deslícelo hacia adelante.</li> </ul> <p><b>PW150/PW150R/PW200/SNS41/SNS44XP</b></p> <ul style="list-style-type: none"> <li>● Presione el botón de la cerradura del zapato del alimentador y permita para resbalar adelante.</li> </ul>	<ul style="list-style-type: none"> <li>● Poussez vers le bas le sabot du charger et faites-le glisser en avant.</li> </ul> <p><b>PW150/PW150R/PW200/SNS41/SNS44XP</b></p> <ul style="list-style-type: none"> <li>● Enfoncez le bouton de serrure de chaussure de conducteur et laissez glisser en avant.</li> </ul>
<p><b>SNS50/SQS55</b></p> 	<ul style="list-style-type: none"> <li>● To Load: When the feeder shoe aligns with the reload indicator, additional fasteners (1 or 2 strips) can be loaded.</li> </ul> <ol style="list-style-type: none"> <li>1. Pull feeder shoe back into "locked" position.</li> <li>2. Lay strip of staples onto rail. Use only genuine Senco fasteners. Do not load with safety element or trigger depressed.</li> <li>3. Tap feeder shoe and allow to slide forward.</li> </ol>	<ul style="list-style-type: none"> <li>● Para cargar: Cuando el alimentador se alinea con el indicador de recarga, sujetadores adicionales (1 o 2 tiras) pueden cargarse.</li> </ul> <ol style="list-style-type: none"> <li>1. Tire del alimentador hacia atrás hasta la posición "cerrada" ("locked").</li> <li>2. Ponga la tira sobre la guía. Use solamente sujetadores Senco auténticos. No cargue con el disparo o la seguridad oprimidos.</li> <li>3. Empuje el alimentador hacia abajo y deslícelo hacia adelante.</li> </ol>	<ul style="list-style-type: none"> <li>● Pour charger : Quand le pousse agrafes est aligné avec l'indicateur de rechargement, des agrafes supplémentaires peuvent être ajoutées. ( 1 ou 2 bandes)</li> </ul> <ol style="list-style-type: none"> <li>1. Tirez le poussoir en arrière dans la position "verrouillée" ("locked").</li> <li>2. Mettez une bande de agrafes sur la traverse. Utilisez uniquement les véritables agrafes Senco. Veillez à ne pas appuyer sur le palpeur de sécurité ou sur la détente quand vous chargez.</li> <li>3. Poussez vers le bas le sabot du charger et faites-le glisser en avant.</li> </ol>
<p><b>SC2</b></p> 	<ul style="list-style-type: none"> <li>● Adjust the magazine height before loading fasteners. Remove the two screws on bottom of the magazine.</li> </ul>	<ul style="list-style-type: none"> <li>● Ajuste la altura del cargador antes de cargarla con sujetadores. Quite los dos tornillos en el fondo del compartimento.</li> </ul>	<ul style="list-style-type: none"> <li>● Si nécessaire, régler le magasin avant chargement des projectiles. Enlevez les deux vis sur le fond du magasin.</li> </ul>

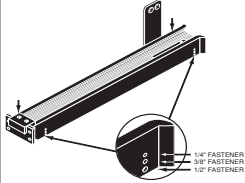
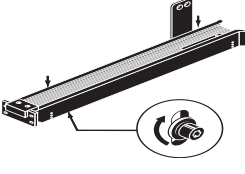
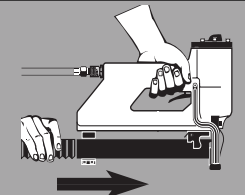
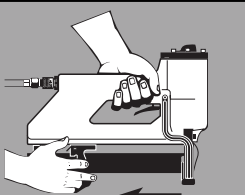
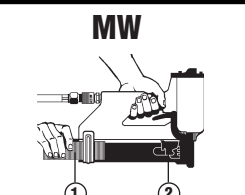
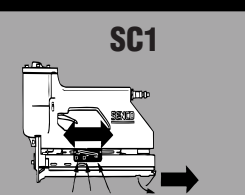
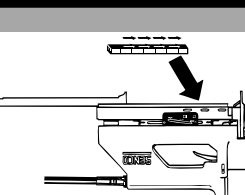
	Tool Use	Uso de la Herramienta	Utilisation de l'Outil
	English	Espanol	Francais
<p><b>SC2</b></p> 	<ul style="list-style-type: none"> <li>● Pull adjustment rail out of the back of the magazine. Choose the appropriate grooves on the inside of the magazine that match the height of the fasteners. Slide the adjustment rail into the chosen set of grooves. Push the adjustment rail all the way forward to the guidebody.</li> </ul>	<ul style="list-style-type: none"> <li>● Saque del carril del ajuste la parte posteriora del compartimiento. Elija los surcos apropiados en el interior del compartimiento que emparejan la altura de los sujetadores. Resbale el carril del ajuste dentro del sistema elegido de surcos. Empuje el carril del ajuste toda la manera adelante al guidebody.</li> </ul>	<ul style="list-style-type: none"> <li>● Tirez le rail d'ajustement hors du dos du magasin. Choisissez les cannelures appropriées sur l'intérieur du magasin qui assortissent la taille des attaches. Glissez le rail d'ajustement dans l'ensemble choisi de cannelures. Poussez le rail d'ajustement toute la manière en avant au guidebody.</li> </ul>
	<ul style="list-style-type: none"> <li>● Replace and tighten the two screws on the bottom of the magazine.</li> </ul>	<ul style="list-style-type: none"> <li>● Sustituya y apriete los dos tornillos en el fondo del compartimiento.</li> </ul>	<ul style="list-style-type: none"> <li>● Remplacez et serrez les deux vis sur le fond du magasin.</li> </ul>
	<ul style="list-style-type: none"> <li>● Insert fasteners into rear of magazine. Do not load with safety element or trigger depressed.</li> </ul>	<ul style="list-style-type: none"> <li>● Inserte los sujetadores dentro del cargador por la parte trasera. No cargue con el seguro o disparador presionados (activados).</li> </ul>	<ul style="list-style-type: none"> <li>● Introduite les projectiles pas l'arrière du magasin. Ne pas activer la sécurité ou la gâchette lors du chargement de l'appareil.</li> </ul>
	<ul style="list-style-type: none"> <li>● Pull feeder shoe back.</li> </ul>	<ul style="list-style-type: none"> <li>● Tire la zapata del alimentador.</li> </ul>	<ul style="list-style-type: none"> <li>● Tirez le poussoir en arrière.</li> </ul>
<p><b>MW</b></p> 	<ul style="list-style-type: none"> <li>● Insert strip of staples into rear of magazine. Use only genuine SENCO fasteners. Do not load with safety element or trigger depressed. Pull feeder shoe back.</li> </ul>	<ul style="list-style-type: none"> <li>● Inserte la tira de grapas en la parte de atrás del área de almacenamiento. Use solamente sujetadores SENCO auténticos. No cargue con el disparo o la seguridad oprimidos. Tire la zapata del alimentador.</li> </ul>	<ul style="list-style-type: none"> <li>● Introduisez une bande de agrafes dans la partie arrière du magasin. Utilisez uniquement les véritables agrafes SENCO. Veillez à ne pas appuyer sur le palpeur de sécurité ou sur la détente quand vous chargez. Tirez le poussoir en arrière.</li> </ul>
<p><b>SC1</b></p>  <p>Y09 Y07 Y05</p>	<ul style="list-style-type: none"> <li>● To Load: Slide adjuster to correct fastener length. Pull latch and slide magazine rail to rear.</li> </ul>	<ul style="list-style-type: none"> <li>● Para cargar: Deslice el ajustador al largo correcto del clavo o de la grapa. Tire del pestillo y deslice el riel del cargador hacia atrás.</li> </ul>	<ul style="list-style-type: none"> <li>● Pour charger : Faire coulisser l'élément ajusteur de façon à obtenir la longueur voulue de l'agrafe. Tirer le loquet et faire coulisser le magasin vers l'arrière.</li> </ul>
	<ul style="list-style-type: none"> <li>● Place strip of fasteners into magazine with printed side facing out and arrows pointed toward front of tool. Slide magazine rail closed.</li> </ul>	<ul style="list-style-type: none"> <li>● Coloque una tira de clavos o grapas en el cargador con el lado impreso hacia afuera y las flechas apuntando hacia la parte delantera de la herramienta. Deslice el riel del cargador para cerrarlo.</li> </ul>	<ul style="list-style-type: none"> <li>● Placer la bande d'agrafes dans le magasin avec le côté imprimé vers l'extérieur et les flèches pointées vers l'avant. Fermer le magasin d'agrafes en le faisant coulisser.</li> </ul>

**Tool Use**

**Uso de la Herramienta**

**Utilisation de l'Outil**

**English**

**Espanol**

**Francais**

**SNS40/41/44XP/45XP/50/**

**SQS55**

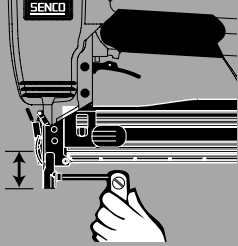

● This tool is equipped with a depth control safety element. To adjust the depth of the staple being driven, loosen the screw and slide the lower safety element up or down and lock in place by tightening the screw. Be sure the safety element moves freely after adjustment. A malfunctioning safety element can cause a fastener to be discharged accidentally.

● Esta herramienta esta equipada con un elemento de seguro para control de profundidad. Para ajustar la profundidad del engrapado. Afloje el tornillo y deslice el elemento de seguridad hacia arriba o abajo a la posición deseada y apriete el tornillo. Asegúrese que elemento de seguro tenga movimiento libre después de ajustarse. Un elemento de seguro en mal estado puede causar que un sujetador sea descargado accidentalmente.

● Cet appareil est équipé d'un réglage de profondeur d'agrafage. Pour effectuer le réglage de la pénétration de l'agrafe, desserrer la vis et faire glisser vers le haut ou vers le bas la partie inférieure du palpeur de sécurité. Le bloquer ensuite en position par l'intermédiaire de la vis. Assurez-vous après cette opération que l'élément de sécurité peut coulisser librement.

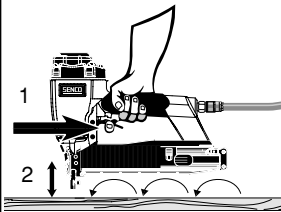
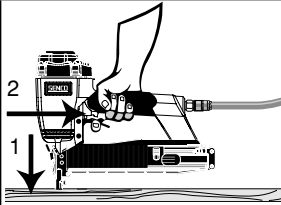

● With a "Dual-Action" trigger, nails can be driven two ways:  
a) Position safety element against work surface and pull trigger... "Trigger Fire."  
b) To drive a nail, pull trigger and push safety element against work surface. Each time the safety element is pushed against the work surface a nail will be driven. This "bottom-fire" mode of operation is preferred when high production, rapid fastener placement is desired.

● Las herramientas con gatillo de acción doble pueden ser disparadas de dos maneras:  
a) Oprima el seguro contra la superficie de trabajo y apriete el gatillo...Disparo de gatillo.  
b) Para impulsar un clavo, oprima el disparador y deprima el elemento de seguridad contra la superficie de trabajo. Cada vez que deprima el elemento de seguridad contra la superficie de trabajo, impulsará un clavo. Este modo de operación de "disparo inferior" o "por rebote" es el preferido cuando se desea alta productividad y rápida colocación del clavo.

● Les appareils équipés de déclenchement "au touché / par gâchette" peuvent être utilisés de 2 façons différentes :  
a) Déclenchement par "gâchette" : Appliquer le palpeur de sécurité de l'appareil à l'endroit désiré et activer la gâchette.  
b) Pour planter un clou, tirez sur la détente et poussez l'élément de sécurité contre la surface de travail. Chaque fois que l'élément de sécurité est poussé contre la surface de travail un clou est planté. Le mode de fonctionnement en "tir continu" est préférable si vous désirez placer des attaches rapidement avec forte productivité.

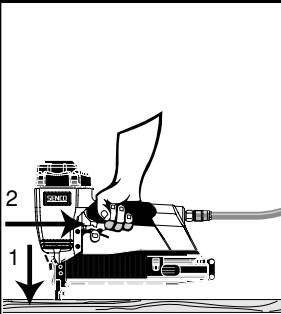

● With a "Restrictive" trigger, nails can only be driven one way. First depress safety element against work surface then pull trigger. This feature is helpful when precise fastener placement is required. Read the "Customer Satisfaction and Safety Reminder" (CSSR) in the tool and fastener boxes for safety information regarding the Dual Action and Restrictive triggers. Under certain conditions, the Restrictive trigger may reduce the possibility of injury to you or to others working with you.

● Las herramientas con "Gatillo Restringido" solamente se pueden disparar con el gatillo. Primero apriete el elemento de seguridad contra la superficie de trabajo y después tire del gatillo. Ésta característica es útil cuando se requiere precisión en la colocación de los sujetadores. Lea el "Recordatorio de Seguridad y Satisfacción del Cliente" (CSSR) en las cajas de sujetadores y de las herramientas para información sobre seguridad de los Gatillos Restringido y de Acción Dual. Bajo ciertas condiciones, el Gatillo Restringido puede reducir la posibilidad de heridas a su persona o a otros que trabajen con usted.

● Avec une gachette "restrictive", les clous ne peuvent être tirés que dans une seule direction. Appuyer d'abord le palpeur de sécurité sur la surface de travail, puis tirer sur la gachette. Cette fonction est utile pour un placement précis de projectiles. Lire le "Rappel de Sécurité et Satisfaction du Client" (CSSR) dans les boîtes à outils et fixations pour les informations de sécurité concernant les Détonés à Double Action et à Restriction. Dans certaines circonstances, la Détoné à Restriction peut réduire la possibilité de se blesser ou de blesser d'autres personnes.

**SNS41/44XP/45XP/50/**

**SQS55**

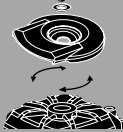

● The deflector can be rotated to change the direction of the exhaust air. Disconnect air supply, loosen cap screw with a socket head cap screw wrench, and then rotate deflector to desired location. Tighten cap screw.

● El deflector puede rotarse para cambiar la dirección del aire expedito por el mofle. Desconecte el aire, afloje los tornillos de la tapa y porte el deflector a la posición deseada. Apriete los tornillos de la tapa.

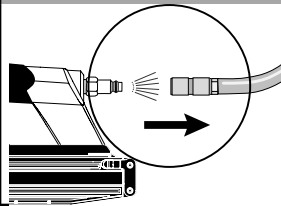

● Le déflecteur peut être orienté différemment pour changer la direction de l'échappement d'air. Déconnecter l'appareil de la source d'air comprimé, dévisser la vis de maintien du déflecteur et faire pivoter celui-ci jusqu'à la position voulue. Resserer la vis de maintien.



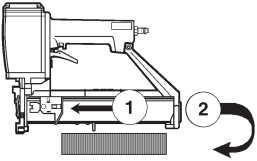
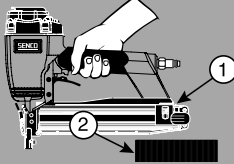
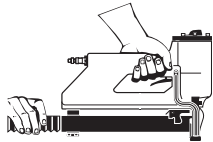

● Should a staple jam occur, disconnect air supply.

● Si se produce un atascamiento de las sujetadores, desconecte el suministro de aire.

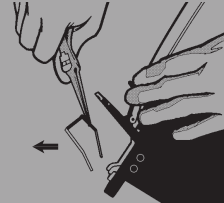
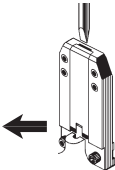
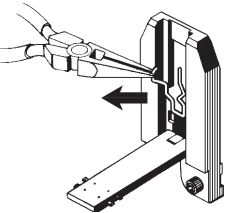
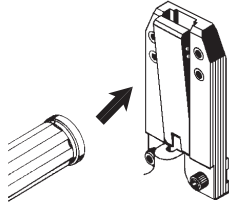
● Si un engrayage se produit, coupez l'arrivée d'air.

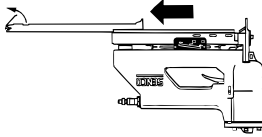
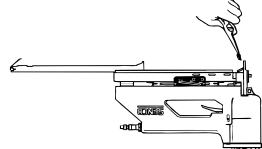
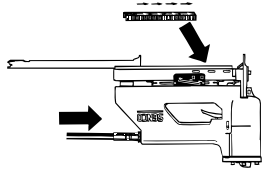
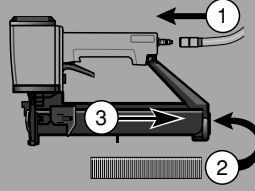
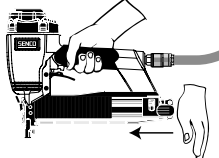
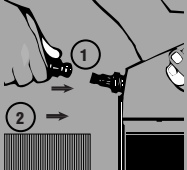
	Tool Use	Uso de la Herramienta	Utilisation de l'Outil
	English	Espanol	Francais
<p><b>SPS</b></p>  <p>SNS40/41/44XP/45XP/50/SQS55/ PW150/PW150R/PW200</p> 	<ul style="list-style-type: none"> <li>● Depress feeder clip ends on both sides of feeder shoe and slide forward over the staple strip. Remove staples.</li> <li>● Pull feeder shoe back into "locked" position and remove staples. Tap feeder shoe and allow to slide forward.</li> </ul> <p><b>PW150/PW150R/PW200/ SNS41/SNS44XP</b></p> <ul style="list-style-type: none"> <li>● Depress feeder shoe lock button and allow to slide forward.</li> </ul>	<ul style="list-style-type: none"> <li>● Oprima ambos lados del alimentador y deslícelo hacia adelante. Remueva las grapas.</li> <li>● Tire del alimentador hacia atrás a la posición "cerrada (locked)" y remueva las grapas. Empuje el alimentador hacia abajo y deslícelo hacia adelante.</li> </ul> <p><b>PW150/PW150R/PW200/ SNS41/SNS44XP</b></p> <ul style="list-style-type: none"> <li>● Presione el botón de la cerradura del zapato del alimentador y permita para resbalar adelante.</li> </ul>	<ul style="list-style-type: none"> <li>● Appuyer sur les deux côtés et faites-le glisser vers l'avant. Retirez les projectiles.</li> <li>● Tirez en arrière le sabot du chargeur dans la position de "verrouillage" et enlevez les projectiles. Poussez vers le bas le sabot du chargeur et faites-le glisser en avant.</li> </ul> <p><b>PW150/PW150R/PW200/ SNS41/SNS44XP</b></p> <ul style="list-style-type: none"> <li>● Enfoncez le bouton de serrure de chaussure de conducteur et laissez glisser en avant.</li> </ul>
<p><b>SC2/MW</b></p> 	<ul style="list-style-type: none"> <li>● Remove fasteners from the tool.</li> </ul>	<ul style="list-style-type: none"> <li>● Retire los sujetadores de la herramienta.</li> </ul>	<ul style="list-style-type: none"> <li>● Videz le magasin de l'outil.</li> </ul>
<p>SNS40/41/44XP/45XP/50/SQS55/ PW150/PW150R/PW200</p> 	<ul style="list-style-type: none"> <li>● Release E-Z Clear latch and open door.</li> </ul>	<ul style="list-style-type: none"> <li>● Suelte el pestillo de alivio fácil (E-Z) y abra la puerta.</li> </ul>	<ul style="list-style-type: none"> <li>● Relâchez le loquet transparent "E-Z" et ouvrez le volet de front.</li> </ul>
	<ul style="list-style-type: none"> <li>● Remove jammed fastener. Close door and latch.</li> </ul>	<ul style="list-style-type: none"> <li>● Remueva el sujetador atascado. Cierre la puerta con pestillo.</li> </ul>	<ul style="list-style-type: none"> <li>● Enlevez le projectile coincé. Fermez le volet de front et le loquet.</li> </ul>
<p><b>SC2/MW/PW</b></p> 	<ul style="list-style-type: none"> <li>● Insert the tip of a screwdriver into the driver track. Tap the handle straight down to open door. Do not twist or turn screwdriver.</li> </ul>	<ul style="list-style-type: none"> <li>● Introduzca la punta de un de sarmador en la abertura del cuerpo guía. Golpee el mango rectamente para abrir la puerta. No palanquee ni de vuelta al desarmador.</li> </ul>	<ul style="list-style-type: none"> <li>● Insérez la pointe d'un tourne-vis dans l'ouverture du guide ; Enfoncez la pointe du tourne-vis jusqu' à ouverture de la porte. Ne pas faire pivoter la pointe du tourne-vis.</li> </ul>
	<ul style="list-style-type: none"> <li>● Remove jammed fastener.</li> </ul>	<ul style="list-style-type: none"> <li>● Remueva el sujetador atascado.</li> </ul>	<ul style="list-style-type: none"> <li>● Retirez le projectile coincé.</li> </ul>
	<ul style="list-style-type: none"> <li>● Close door with a sharp tap from the screwdriver handle.</li> </ul>	<ul style="list-style-type: none"> <li>● Cierre la puertecilla con un golpe fuerte del mango del desarmador.</li> </ul>	<ul style="list-style-type: none"> <li>● Refermez la porte en tapant avec la un poignée du tourne-vis.</li> </ul>

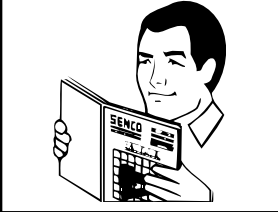
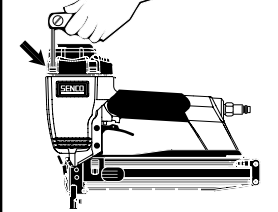
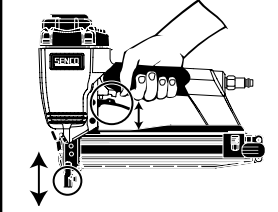
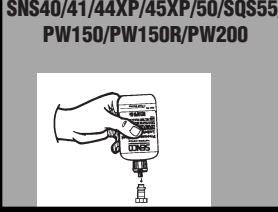
	<b>Tool Use</b>	<b>Uso de la Herramienta</b>	<b>Utilisation de l'Outil</b>
	<b>English</b>	<b>Espanol</b>	<b>Francais</b>
<p><b>SC1</b></p>   	<ul style="list-style-type: none"> <li>● Pull latch and slide magazine rail open.</li> </ul>	<ul style="list-style-type: none"> <li>● Tire del pestillo y abra el riel del cargador deslizándolo.</li> </ul>	<ul style="list-style-type: none"> <li>● Tirer le loquet et faire coulisser le magasin.</li> </ul>
	<ul style="list-style-type: none"> <li>● Remove jammed fastener.</li> </ul>	<ul style="list-style-type: none"> <li>● Remueva la grapa atascado.</li> </ul>	<ul style="list-style-type: none"> <li>● Enlevez le projectile coincé.</li> </ul>
	<ul style="list-style-type: none"> <li>● Connect air supply and replace fasteners.</li> </ul>	<ul style="list-style-type: none"> <li>● Conecte la línea de aire y reemplace las grapas.</li> </ul>	<ul style="list-style-type: none"> <li>● Reconnectez la conduite d'air comprimé et rechargez le magasin.</li> </ul>
<p><b>SPS</b></p> 	<ul style="list-style-type: none"> <li>● Connect air supply and replace fasteners. Pull feeder shoe back.</li> </ul>	<ul style="list-style-type: none"> <li>● Conecte la línea de aire y reemplace los sujetadores. Tire de la zapata del alimentador hacia atrás.</li> </ul>	<ul style="list-style-type: none"> <li>● Reconnectez la conduit d'air comprimé et rechargez le magasin. Tirez le poussoir en arrière.</li> </ul>
	<p><b>SNS40/41/44XP/45XP/50/SQS55/PW150/PW150R/PW200</b></p> 	<ul style="list-style-type: none"> <li>● Connect air supply and replace fasteners. Tap feeder shoe and allow to slide forward.</li> </ul> <p><b>PW150/PW150R/PW200</b></p> <ul style="list-style-type: none"> <li>● Depress feeder shoe lock button and allow to slide forward.</li> </ul>	<ul style="list-style-type: none"> <li>● Conecte la línea de aire y reemplace los sujetadores. Empuje el alimentador hacia abajo y deslícelo hacia adelante.</li> </ul> <p><b>PW150/PW150R/PW200</b></p> <ul style="list-style-type: none"> <li>● Presione el botón de la cerradura del zapato del alimentador y permita para resbalar adelante.</li> </ul>
<p><b>SC2/MW</b></p> 	<ul style="list-style-type: none"> <li>● Connect air supply and replace fasteners.</li> </ul>	<ul style="list-style-type: none"> <li>● Conecte la línea de aire y reemplace los sujetadores.</li> </ul>	<ul style="list-style-type: none"> <li>● Reconnectez la conduite d'air comprimé et rechargez le magasin.</li> </ul>

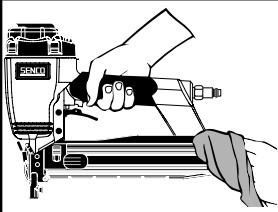
	Maintenance	Mantenimiento	Entretien
	English	Espanol	Francais
	<ul style="list-style-type: none"> <li>● Read and understand "SAFETY INSTRUCTIONS" manual shipped with this tool before using tool.</li> </ul>	<ul style="list-style-type: none"> <li>● Antes de usar la herramienta lea y comprenda el manual "INSTRUCCIONES DE SEGURIDAD" despachado con ella.</li> </ul>	<ul style="list-style-type: none"> <li>● Lisez et assimilez le manuel "INSTRUCTIONS DE SÉCURITÉ" livré avec cet outil avant de l'utiliser.</li> </ul>
	<ul style="list-style-type: none"> <li>● All screws should be kept tight. Loose screws result in unsafe operation and parts breakage.</li> </ul>	<ul style="list-style-type: none"> <li>● Todos los tornillos tienen que mantenerse apretados. Los tornillos sueltos pueden producir una operación no segura y quebraduras de partes.</li> </ul>	<ul style="list-style-type: none"> <li>● L'outil étant séparé de l'alimentation en air, effectuez une inspection journalière pour assurer le libre mouvement du palpeur de sécurité et de la détente. N'utilisez pas l'outil si le palpeur de sécurité ou la détente colle ou se coince.</li> </ul>
	<ul style="list-style-type: none"> <li>● With tool disconnected, make daily inspection to assure free movement of safety element and trigger. Do not use tool if safety element or trigger sticks or binds.</li> </ul>	<ul style="list-style-type: none"> <li>● Con la herramienta desconectada, haga inspecciones diarias para asegurar el movimiento libre del seguro y del gatillo. No use la herramienta si el seguro o el gatillo se atoran.</li> </ul>	<ul style="list-style-type: none"> <li>● Toutes les vis doivent être maintenues serrées à fond. Les vis desserrées entraînent un manque de sûreté du fonctionnement et la rupture de pièces.</li> </ul>
<p>SNS40/41/44XP/45XP/50/SQS55/PW150/PW150R/PW200</p> 	<ul style="list-style-type: none"> <li>● Squirt Senco pneumatic oil (5 to 10 drops) into the air inlet twice daily. (Depending on frequency of tool use.) Other oils may damage O-rings and other tool parts.</li> </ul>	<ul style="list-style-type: none"> <li>● Aplique aceite neumático Senco en la entrada de aire dos veces al día. (Dependiendo en la frecuencia de uso 5 A 10 Gotas.) Otros aceites pueden dañar los anillos en "O" y otras piezas de la herramienta.</li> </ul>	<ul style="list-style-type: none"> <li>● Avec une burette, placer 5 à 10 gouttes d'huile pneumatique dans l'arrivée d'air deux fois par jour. (Dépend de l'intensité de l'utilisation de l'appareil.) D'autres huiles pourraient endommager les joints toriques et d'autres pièces de l'outil.</li> </ul>
<p>SNS40/SPS</p> 	<ul style="list-style-type: none"> <li>● Routine lubrication is not necessary. Do not oil.</li> </ul>	<ul style="list-style-type: none"> <li>● La lubricación de rutina no es necesaria. No aceite.</li> </ul>	<ul style="list-style-type: none"> <li>● La lubrication de routine n'est pas nécessaire. N'huilez pas.</li> </ul>
	<ul style="list-style-type: none"> <li>● Wipe tool clean daily and inspect for wear. Use non-flammable cleaning solutions only if necessary – DO NOT SOAK. CAUTION: Such solutions may damage O-rings and other tool parts.</li> </ul>	<ul style="list-style-type: none"> <li>● Solamente si es necesario use soluciones para limpieza no inflamables –NO LA REMOJE. Precaución: Tales soluciones pueden dañar los empaques y otras partes de la herramienta.</li> </ul>	<ul style="list-style-type: none"> <li>● Nettoyez l'outil chaque jour à l'aide d'un chiffon et inspectez-le pour déceler une éventuelle usure. Utilisez uniquement des solvants non inflammables en cas de nécessité – NE LE FAITES PAS TREMPER! Attention : De tels produits peuvent endommager les joints et d'autres pièces de l'appareil.</li> </ul>



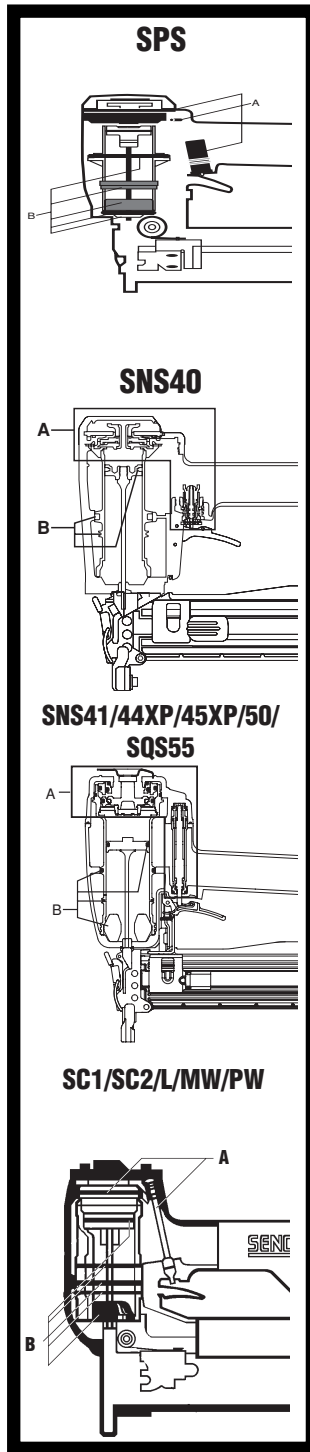

Troubleshooting	Identificación de Fallas	Dépannage
English	Espanol	Francais
<p><b>WARNING</b> Repairs other than those described here should be performed only by trained, qualified personnel. Contact Senco for information at 1-800-543-4596.</p> <p>● Read and understand "SAFETY INSTRUCTIONS" manual shipped with this tool before using tool.</p>	<p><b>ALERTA</b> Las reparaciones, fuera de aquellas descritas aquí, deben de ser llevadas a cabo solamente por personal entrenado y calificado. Póngase en contacto con Senco para información 1-800-543-4596.</p> <p>● Antes de usar la herramienta lea y comprenda el manual "INSTRUCCIONES DE SEGURIDAD" despachado con ella.</p>	<p><b>AVERTISSEMENT</b> Les réparations autres que celles décrites ici doivent être réalisées uniquement par du personnel qualifié ayant reçu la formation appropriée. Pour toute information, prenez contact avec Senco par téléphone en appelant Le Distributeur agréé.</p> <p>● Lisez et assimilez le manuel "INSTRUCTIONS DE SÉCURITÉ" livré avec cet outil avant de l'utiliser.</p>

<p><b>SYMPTOM</b> Air leak near top of tool / Sluggish operation</p> <p><b>SOLUTION</b> Verify air supply / tighten screws or install Parts Kit A.</p>	<p><b>SÍNTOMA</b> El aire se escapa cerca de la parte superior de la herramienta / Operación lenta.</p> <p><b>SOLUCIÓN</b> Apriete los tornillos / Verifique el suministro de aire o instale el Juego de Partes A (Parts Kit A).</p>	<p><b>SYMPTÔME</b> Fuite d'air près du sommet de l'outil / fonctionnement lent.</p> <p><b>SOLUTION</b> Serrez les vis à fond / vérifiez l'alimentation en air ou remplacez les pièces portant la lettre "A".</p>
--	--	--

<p><b>SYMPTOM</b> Air leak near bottom of tool / Poor return.</p> <p><b>SOLUTION</b> Clean tool / tighten screws or install Parts Kit B.</p>	<p><b>SÍNTOMA</b> El aire se fuga cerca de la parte inferior de la herramienta / Mal retorno.</p> <p><b>SOLUCIÓN</b> Apriete los tornillos / Limpié la herramienta o instale el Juego de Partes B (Parts Kit B).</p>	<p><b>SYMPTÔME</b> Fuite d'air près de la base de l'outil / retour inadéquat.</p> <p><b>SOLUTION</b> Serrez les vis à fond / nettoyez l'outil ou remplacez les pièces portant la lettre "B".</p>
--	--	--

<p><b>SYMPTOM</b> Other problems.</p> <p><b>SOLUTION</b> Contact Senco.</p>	<p><b>SÍNTOMA</b> Otros problemas.</p> <p><b>SOLUCIÓN</b> Póngase en contacto con Senco.</p>	<p><b>SYMPTÔME</b> Autres problèmes.</p> <p><b>SOLUTION</b> Prenez contact avec Senco.</p>
---	--	--

Accessories	Accesorios	Accessoires
English	Espanol	Francais
<p>Senco offers a full line of accessories for your Senco tools, including:</p> <ul style="list-style-type: none"> <li>● Air Compressors</li> <li>● Hose</li> <li>● Couplers</li> <li>● Fittings</li> <li>● Safety Glasses</li> <li>● Pressure Gauges</li> <li>● Lubricants</li> <li>● Regulators</li> <li>● Filters</li> </ul> <p>For more information or a complete illustrated catalogue of Senco accessories, ask your representative for #MK336.</p>	<p>Senco ofrece una línea completa de Accesorios para sus herramientas Senco, incluyendo:</p> <ul style="list-style-type: none"> <li>● Compresores de Aire</li> <li>● Manguera</li> <li>● Conectores Rápidos</li> <li>● Conectores</li> <li>● Anteojos De Seguridad</li> <li>● Manómetros</li> <li>● Lubricantes</li> <li>● Reguladores</li> <li>● Filtros</li> </ul> <p>Para mas informacion ó un pour recevoir un catalogo completo ilustrado de los Accesorios Senco, pregunte a su representante pour el numero MK336.</p>	<p>Senco offre une gamme étendue d'accessoires pour vos outils Senco y compris :</p> <ul style="list-style-type: none"> <li>● Compresseurs</li> <li>● Tuyauterie flexible</li> <li>● Raccords</li> <li>● Lunettes de sécurité</li> <li>● Manomètres</li> <li>● Lubrifiants</li> <li>● Régulateurs</li> <li>● Filtres</li> </ul> <p>Pour plus d'informations ou pour recevoir un catalogue détaillé des accessoires proposés par Senco, prenez contact avec votre représentant Senco (référence catalogue : #MK336).</p>

**SPS/PW/MW  
PW150/PW150R  
PW200**

Specifications		Especificaciones		Specifications	
English		Espanol		Francais	

Code	A	
	inches	mm
P08	1/2	13
P10	5/8	16
P11	3/4	20
P12	7/8	22
P13	1	25
P15	1 1/4	32
P17	1 1/2	38
P19	1 3/4	44
P21	2	50

**SNS40/41/44XP/45XP**

Specifications		Especificaciones		Specifications	
English		Espanol		Francais	

Code	A	
	inches	mm
N13	1	25
N14	1 1/8	29
N15	1 1/4	32
N16	1 3/8	35
N17	1 1/2	38
N18	1 5/8	41
N19	1 3/4	44
N21*	2	50

\*SOFTWOOD APPLICATIONS ONLY  
\*SOLO PARA APLICACIONES EN MADERA BLANDA  
\*UNIQUEMENT DANS DU BOIS TENDRE

**SNS50/M2**

Specifications		Especificaciones		Specifications	
English		Espanol		Francais	

Code	A	
	inches	mm
N15	1 1/4	32
N16	1 3/8	35
N17	1 1/2	38
N18	1 5/8	41
N19	1 3/4	44
N21	2	50

**SQS55/M3**

Specifications		Especificaciones	Specifications
English		Espanol	Francais
Code	A		
	inches	mm	
Q15	1 1/4	32	
Q17	1 1/2	38	
Q19	1 3/4	44	
Q21	2	50	
Q23	2 1/4	57	
Q25	2 1/2	65	

**SC2**

Specifications		Especificaciones	Specifications	
English		Espanol	Francais	
Fastener	A			
	X04			1/4 (6.4)
	X06			3/8 (9.5)
	X08			1/2 (12.7)

**SC1**

Specifications		Especificaciones	Specifications	
English		Espanol	Francais	
Fastener	Senclamp			
	Y05			5/16
	Y07			7/16
	Y09			9/16
		Crown: 7/16 (11.1) Thickness: .020 Gauge: 25		

English TECHNICAL SPECIFICATIONS	SPS		SNS40		SNS45XP		SNS50		SNS44XP	
Minimum to maximum operating pressure	70–120 psi	4,8–8,3 bar	80–120 psi	5,5–8,3 bar	80–120 psi	5,5–8,3 bar	80–120 psi	5,5–8,3 bar	80–120 psi	5,5–8,3 bar
Air Consumption (60 cycles per minute)	2.16 scfm	61,2 liter	4.32 scfm	123 liter	5.52 scfm	156 liter	6.54 scfm	185 liter	6.31 scfm	178 liter
Air Inlet	1/4 in. NPT	1/4 in. NPT	1/4 in. NPT	1/4 in. NPT	3/8 in. NPT	3/8 in. NPT	3/8 in. NPT	3/8 in. NPT	3/8 in. NPT	3/8 in. NPT
Maximum Speed (cycles per second)	5	5	14	14	15	15	15	15	12	12
Weight	5.3 lbs.	2,4 kg	4.15 lbs.	1,9 kg	5.1 lbs.	2,3 kg	5.9 lbs.	2,7 kg	4.5 lbs.	2,0 kg
Staple Capacity	140	140	160	160	160	160	160	160	160	160
Tool size: Height	9 7/8 in.	251 mm	9 7/8 in.	251 mm	11 in.	279 mm	12 in.	305 mm	11 in.	279 mm
Tool size: Length	13 1/2 in.	343 mm	14 in.	356 mm	14 in.	356 mm	14 3/8 in.	365 mm	15 in.	381 mm
Tool size: Width: Main Body	3 1/16 in.	78 mm	3 in.	76 mm	3 1/2 in.	90 mm	3 5/8 in.	92 mm	3 1/4 in.	82 mm
Tool size: Width: Rear Bracket	3 1/2 in.	89 mm	–	–	–	–	–	–	–	–
	SQS55		SC2		PW200		PW150/PW150R		SNS41	
Minimum to maximum operating pressure	80–120 psi	5,5–8,3 bar	80–110 psi	5,5–7,5 bar	70–120 psi	4,8–8,3 bar	70–120 psi	4,8–8,3 bar	80–120 psi	5,5–8,3 bar
Air Consumption (60 cycles per minute)	6.54 scfm	185 liter	3.71 scfm	105,1 liter	2.16 scfm	61,2 liter	2.16 scfm	61,2 liter	5.4 scfm	153 liter
Air Inlet	3/8 in. NPT	3/8 in. NPT	3/8 in. NPT	3/8 in. NPT	3/8 in. NPT	3/8 in. NPT	3/8 in. NPT	3/8 in. NPT	3/8 in. NPT	3/8 in. NPT
Maximum Speed (cycles per second)	–	–	–	–	12	12	12	12	12	12
Weight	15	15	6.9 lbs.	3,1 kg	5.3 lbs.	2,4 kg	5.3 lbs.	2,4 kg	4.6 lbs.	2,1 kg
Staple Capacity	5.9 lbs.	2,7 kg	80	80	160	160	160	160	160	160
Tool size: Height	130	130	9 7/16 in.	240 mm	9 3/8 in.	238 mm	9 3/8 in.	238 mm	10 3/4 in.	273 mm
Tool size: Length	12 in.	305 mm	12 1/2 in.	318 mm	14 1/4 in.	362 mm	14 1/4 in.	362 mm	15 in.	381 mm
Tool size: Width: Main Body	14 3/8 in.	365 mm	3 3/16 in.	81 mm	3 in.	78 mm	3 in.	76 mm	3 3/8 in.	86 mm
Tool size: Width: Rear Bracket	3 5/8 in.	92 mm	–	–	–	–	–	–	–	–

Espanol ESPECIFICACIONES TECNICAS	SPS		SNS40		SNS45XP		SNS50		SNS44XP	
Presión de operación mínima y máxima	70–120 psi	4,8–8,3 bar	80–120 psi	5,5–8,3 bar	80–120 psi	5,5–8,3 bar	80–120 psi	5,5–8,3 bar	80–120 psi	5,5–8,3 bar
Consumo de aire (60 ciclos por minuto)	2.16 scfm	61.2 liter	4.32 scfm	123 liter	5.52 scfm	156 liter	6.54 scfm	185 liter	6.31 scfm	178 liter
Entrada de aire	1/4 in. NPT	1/4 in. NPT	1/4 in. NPT	1/4 in. NPT	3/8 in. NPT	3/8 in. NPT	3/8 in. NPT	3/8 in. NPT	3/8 in. NPT	3/8 in. NPT
Velocidad máxima (ciclos por segundo)	5	5	14	14	15	15	15	15	12	12
Peso	5.3 lbs.	2,4 kg	4.15 lbs.	1,9 kg	5.1 lbs.	2,3 kg	5.9 lbs.	2,7 kg	4.5 lbs.	2,0 kg
Capacidad de grapas por cargador	140	140	160	160	160	160	160	160	160	160
Tamaño de la herramienta: Altura	9 7/8 in.	251 mm	9 7/8 in.	251 mm	11 in.	279 mm	12 in.	305 mm	11 in.	279 mm
Tamaño de la herramienta: Longitud	13 1/2 in.	343 mm	14 in.	356 mm	14 in.	356 mm	14 3/8 in.	365 mm	15 in.	381 mm
Tamaño de la herramienta: Ancho (Cuerpo)	3 1/16 in.	78 mm	3 in.	76 mm	3 1/2 in.	90 mm	3 5/8 in.	92 mm	3 1/4 in.	82 mm
Tamaño de la herramienta: Ancho (Brazo)	3 1/2 in.	89 mm	–	–	–	–	–	–	–	–
	SQS55		SC2		PW200		PW150/PW150R		SNS41	
Presión de operación mínima y máxima	80–120 psi	5,5–8,3 bar	80–110 psi	5,5–7,5 bar	70–120 psi	4,8–8,3 bar	70–120 psi	4,8–8,3 bar	80–120 psi	5,5–8,3 bar
Consumo de aire (60 ciclos por minuto)	6.54 scfm	185 liter	3.71 scfm	105,1 liter	2.16 scfm	61,2 liter	2.16 scfm	61,2 liter	5.4 scfm	153 liter
Entrada de aire	3/8 in. NPT	3/8 in. NPT	3/8 in. NPT	3/8 in. NPT	3/8 in. NPT	3/8 in. NPT	3/8 in. NPT	3/8 in. NPT	3/8 in. NPT	3/8 in. NPT
Velocidad máxima (ciclos por segundo)	15	15	–	–	12	12	12	12	12	12
Peso	5.9 lbs.	2,7 kg	6,9 lbs.	3,1 kg	5.3 lbs.	2,4 kg	5.3 lbs.	2,4 kg	4.6 lbs.	2,1 kg
Capacidad de grapas por cargador	130	130	80	80	160	160	160	160	160	160
Tamaño de la herramienta: Altura	12 in.	305 mm	9 7/16 in.	240 mm	9 3/8 in.	238 mm	9 3/8 in.	238 mm	10 3/4 in.	273 mm
Tamaño de la herramienta: Longitud	14 3/8 in.	365 mm	12 1/2 in.	318 mm	14 1/4 in.	362 mm	14 1/4 in.	362 mm	15 in.	381 mm
Tamaño de la herramienta: Ancho (Cuerpo)	3 5/8 in.	92 mm	3 3/16 in.	81 mm	3 in.	78 mm	3 in.	76 mm	3 3/8 in.	86 mm
Tamaño de la herramienta: Ancho (Brazo)	–	–	–	–	–	–	–	–	–	–

Francais SPECIFICATIONS TECHNIQUES	SPS		SNS40		SNS45XP		SNS50		SNS44XP	
Pression de travail min. et max.	4,8–8,3 bar		5,5–8,3 bar		5,5–8,3 bar		5,5–8,3 bar		5,5–8,3 bar	
Consommation d'air (60 cycles par minute)	61.2 liter		123 liter		156 liter		185 liter		178 liter	
Prise d'air	1/4 in. NPT		1/4 in. NPT		3/8 in. NPT		3/8 in. NPT		3/8 in. NPT	
Vitesse maximum (cycles par seconde)	5		14		15		15		12	
Poids	2,4 kg		1,9 kg		2,3 kg		2,7 kg		2,0 kg	
Capacité de agrafes par magasin	140		160		160		160		160	
Dimensions de l'outil: hauteur	251 mm		251 mm		279 mm		305 mm		279 mm	
Dimensions de l'outil: longueur	343 mm		356 mm		356 mm		365 mm		381 mm	
Dimensions de l'outil: largeur: corps de l'appareil	78 mm		76 mm		90 mm		92 mm		82 mm	
Dimensions de l'outil: largeur: console du magasin	89 mm		–		–		–		–	
	SQS55		SC2		PW200		PW150/PW150R		SNS41	
Pression de travail min. et max.	5,5–8,3 bar		5,5–7,5 bar		4,8–8,3 bar		4,8–8,3 bar		5,5–8,3 bar	
Consommation d'air (60 cycles par minute)	185 liter		105,1 liter		61,2 liter		61,2 liter		153 liter	
Prise d'air	3/8 in. NPT		3/8 in. NPT		3/8 in. NPT		3/8 in. NPT		3/8 in. NPT	
Vitesse maximum (cycles par seconde)	15		–		12		12		12	
Poids	2,7 kg		3,1 kg		2,4 kg		2,4 kg		2,1 kg	
Capacité de agrafes par magasin	130		80		160		160		160	
Dimensions de l'outil: hauteur	305 mm		240 mm		238 mm		238 mm		273 mm	
Dimensions de l'outil: longueur	365 mm		318 mm		362 mm		362 mm		381 mm	
Dimensions de l'outil: largeur: corps de l'appareil	92 mm		81 mm		78 mm		76 mm		86 mm	
Dimensions de l'outil: largeur: console du magasin	–		–		–		–		–	

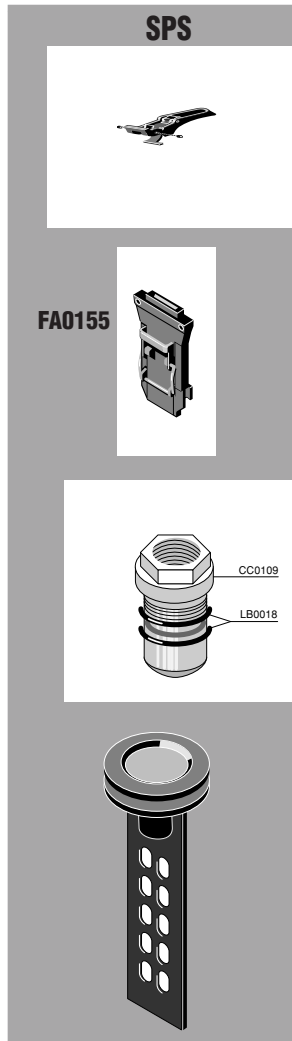

Options		Opciones		Options	
English		Español		Français	
<ul style="list-style-type: none"> <li>● <b>RESTRICTIVE TRIGGER</b>—This feature is helpful when precise fastener placement is required.</li> </ul>		<ul style="list-style-type: none"> <li>● <b>DISPARO RESTRINGIDO</b>—Esta característica sirve de ayuda cuando se requiere una colocación del sujetador precisa.</li> </ul>		<ul style="list-style-type: none"> <li>● <b>DÉTENTE RESTRICTIVE</b>—Cette caractéristique s'avère utile quand un placement de projectiles précis s'impose.</li> </ul>	
<ul style="list-style-type: none"> <li>● <b>3/4" Guide Body Assy.</b>—This assembly can be used to allow any SPS model to drive short length fasteners only, from 1/2" to 3/4" (P08–P11).</li> </ul>		<ul style="list-style-type: none"> <li>● <b>Conjunto del Cuerpo Guía 3/4"</b>—Esta conjunto puede ser usado para permitir a cualquier modelo SPS lanzar grapas cortas solamente, desde 1/2" hasta 3/4" (P08–P11).</li> </ul>		<ul style="list-style-type: none"> <li>● <b>Ensemble Front 3/4"</b>—Peut être utilisé pour permettre à l'appareil SPS de passer des agrafes courtes uniquement d' 1/2" à 3/4" (P08–P11).</li> </ul>	
<ul style="list-style-type: none"> <li>● <b>Remote Fire Fitting</b>—For use in remote activation of the tool. Requires <b>Normally Open (N.O.)</b> valve to actuate (not included). <b>Warning: Use only Normally Open valve for safe operation.</b></li> </ul>		<ul style="list-style-type: none"> <li>● <b>Accesorio de Disparo Remoto</b>—Para uso en la activación remota de la herramienta. Requiere la válvula <b>Normalmente Abierta (N.O.)</b> para la activación (no va incluida). <b>Aviso: Use solamente la válvula Normalmente Abierta para una operación segura.</b></li> </ul>		<ul style="list-style-type: none"> <li>● <b>Adaptation pour utilisation à distance</b> —Pour utilisation dans le but d'activer l'outil à distance. L'actionnement exige un soupape <b>Normalement Ouverte (N.O.)</b> (Celle-ci n'est pas incluse). <b>Avertissement : Pour un fonctionnement en tout sécurité, utilisez uniquement une soupape Normalement Ouverte.</b></li> </ul>	
<ul style="list-style-type: none"> <li>● <b>PISTON/DRIVER ASSEMBLY Note:</b> 1/8" comes standard with tool.</li> </ul>		<ul style="list-style-type: none"> <li>● <b>ASAMBLE DE PISTON Y PERCUSOR</b>—Nota: 1/8" viene estandard con la herramienta. 3,18 mm viene estandard con la herramienta.</li> </ul>		<ul style="list-style-type: none"> <li>● <b>PISTON/COUTEAU D'ASSEMBLÉE</b>—Note : La dimension de 3,18 mm est standard avec l'outil.</li> </ul>	
Crown Corona Rückenbreite Couronne	Wire Size Dimensiones del alambre Drahtmaß Section de Fil	Staple Code Código de la Grapa Klammertyp Code d'Agrafe	Countersink Depth Profundidad del Hundimiento Versenktiefe Profondeur de Fraisure	Part Number Numero de Parta Teilenummer Numéro de Pièce	
1"	16 GAUGE .062" x .055" 1,57 mm x 1,3 mm	<b>P</b>	0"    0 mm	EA0107	
25,4 mm			1/16"    1,6 mm	EA0106	

Options		Opciones		Options	
English		Español		Français	
<p style="text-align: center;"><b>SNS40/SNS41/ SNS44XP/SNS45XP SNS50/SQS55/MW/ PW/PW150/PW150R/ PW200</b></p>		<ul style="list-style-type: none"> <li>● <b>RESTRICTIVE TRIGGER</b>— This feature is helpful when precise fastener placement is required.</li> </ul>		<ul style="list-style-type: none"> <li>● <b>GATILLO RESTRINGIDO</b>— Esta característica sirve de ayuda cuando se requiere una colocación del sujetador precisa.</li> </ul>	
				<ul style="list-style-type: none"> <li>● <b>DECLÈNCHEMENT PAR GACHETTE</b>— Cette caractéristique s'avère utile quand un placement de projectiles précis s'impose.</li> </ul>	





## **SENCO TOOL & PARTS WARRANTY**

**This tool has been designed and constructed using the highest standards of material and workmanship.**

### **TOOL AND PARTS WARRANTY:**

The length of this guarantee is one year from date of purchase by the original retail purchaser. During this period, Senco Products, Inc., will repair or replace at Senco's option, any original part or parts for the original retail purchaser. This will be done free of charge, provided the parts are determined defective in materials or workmanship upon examination by a Senco Authorized Warranty Service Center (exception: rubber o-rings and seals, driver blades). Any replacement part provided will carry a warranty for the balance of the period of warranty applicable to the part it replaces.

**This warranty will be honored, only if:**

- A) Clean, dry, regulated compressed air has been used, at air pressure not exceeding the maximum indicated on the tool casting;**
- B) No evidence of abuse, or failure to follow recommended operational maintenance, or modification of the tool is present (read Operator Manual for use and maintenance instructions);**
- C) When repair or replacement of parts or tools is necessary, the original retail purchaser returns the complete tool or part, with transportation prepaid, to the nearest Senco Authorized Warranty Service Center, with purchase receipt or other positive proof that the part or tool is within the warranty period.**

**THIS WARRANTY IS THE ONLY WARRANTY ON THIS TOOL, AND ALL OTHER WARRANTIES, WHETHER ORAL, WRITTEN, EXPRESS, OR IMPLIED, INCLUDING, BUT NOT LIMITED TO, THE IMPLIED WARRANTY OF MERCHANTABILITY OR FITNESS FOR A PARTICULAR PURPOSE, ARE EXCLUDED. BUYER'S OR USER'S REMEDIES ARE SOLELY AND EXCLUSIVELY AS STATED ABOVE. Senco PRODUCTS, INC. SHALL IN NO EVENT BE LIABLE FOR INCIDENTAL, CONSEQUENTIAL, INDIRECT, OR SPECIAL DAMAGES. IN NO EVENT, WHETHER AS A RESULT OF A BREACH OF CONTRACT, WARRANTY, TORT (INCLUDING NEGLIGENCE) OR OTHERWISE, SHALL Senco'S LIABILITY EXCEED THE PRICE OF THE TOOL WHICH HAS GIVEN RISE TO THE CLAIM OR LIABILITY. ANY LIABILITY CONNECTED WITH THE USE OF THIS TOOL SHALL TERMINATE UPON THE EXPIRATION OF THE WARRANTY PERIOD SPECIFIED ABOVE.**

### **Replacement of Tool Due to Natural Disaster**

**Senco will also replace any tool destroyed by an Act of God such as flood, earthquake, hurricane or other disaster resulting only from the forces of nature. Such a claim will be honored provided that such original retail purchaser had previously submitted a completed warranty registration card, and then submits proof of ownership and an acceptable statement describing such Act of God documented by an insurance carrier, police department, or other official governmental source. To obtain instructions for filing a claim call 1-800-543-4596.**

**SENCO PRODUCTS, INC.  
CINCINNATI, OHIO 45244-1611 USA**



## Free Manuals Download Website

<http://myh66.com>

<http://usermanuals.us>

<http://www.somanuals.com>

<http://www.4manuals.cc>

<http://www.manual-lib.com>

<http://www.404manual.com>

<http://www.luxmanual.com>

<http://aubethermostatmanual.com>

Golf course search by state

<http://golfingnear.com>

Email search by domain

<http://emailbydomain.com>

Auto manuals search

<http://auto.somanuals.com>

TV manuals search

<http://tv.somanuals.com>