

# SENCO®

Senco Products Inc.  
8485 Broadwell Road  
Cincinnati, Ohio 45244



## WC150XP / WC150RXP / WC200XP STAPLERS

Operating Instructions  
Instrucciones de Operacion  
Mode d'Emploi



Please visit [www.senco.com](http://www.senco.com) or call 1-800-543-4596 (North & South America Only) for updated product and parts information.  
Por favor visite [www.senco.com](http://www.senco.com) o llame 1-800-543-4596 (Norte y Sur América solamente) para actualizada del producto y en la parte de información.  
S'il vous plaît visitez [www.senco.com](http://www.senco.com) ou appelez 1-800-543-4596 (Amérique du Nord et l'Amérique du Sud seulement) pour la plus récente information sur le produit.



Warnings for the safe use of this tool are included in this manual.  
Los avisos para el uso seguro de esta herramienta están incluidos en este manual.  
Les consignes pour l'utilisation en toute sécurité de cet outil se trouvent dans ce manuel.

© 2008 by Senco Products, Inc.

NFD84W4X4Y January 6, 2009

English	Español	Français
---------	---------	----------

TABLE OF CONTENTS	TABLA DE MATERIAS	TABLE DES MATIÈRES
-------------------	-------------------	--------------------

Tool Use	2	Utilisation de l'outil	2
Maintenance	6	Entretien	6
Troubleshooting	7	Dépannage	7
Accessories	7	Accessoires	7
Options	8	Options	8
Specifications	8	Spécifications	8
	8	Opciones	8
	8	Especificaciones	8

EMPLOYER'S RESPONSIBILITIES	RESPONSABILIDADES DEL EMPLEADOR	RESPONSABILITÉS DE L'EMPLOYEUR
-----------------------------	---------------------------------	--------------------------------

Employer must enforce compliance with the safety warnings and all other instructions which accompany this tool as shipped from the manufacturer.	El empleador debe hacer cumplir las advertencias de seguridad y todas las otras instrucciones que acompañan a esta herramienta como se la despacha desde el fabricante.	L'employeur doit faire appliquer les consignes de sécurité et toutes les autres instructions qui accompagnent cet outil tel qu'il est livré par son constructeur.
Keep this manual available for use by all people assigned to the use of this tool.	Mantenga este manual disponible para que lo usen todas las personas destinadas a hacer uso de esta herramienta.	Ayez ce manuel à la disposition de toutes les personnes chargées d'utiliser cet outil.
For personal safety and proper operation of this tool, read and understand all of these instructions carefully.	Por razones de seguridad personal y la adecuada operación de esta herramienta, lea y comprenda todas estas instrucciones cuidadosamente.	Pour assurer la sécurité personnelle et le bon emploi de cet outil, lisez et assimilez soigneusement toutes ces instructions.

Tool Use	Uso de la Herramienta	Utilisation de l'Outil
English	Español	Français

<ul style="list-style-type: none"> <li>Read and understand "SAFETY INSTRUCTIONS" manual shipped with this tool before using tool.</li> </ul>	<ul style="list-style-type: none"> <li>Antes de usar la herramienta lea y comprenda el manual "INSTRUCCIONES DE SEGURIDAD" despachado con ella.</li> </ul>	<ul style="list-style-type: none"> <li>Lisez et assimilez le manuel "INSTRUCTIONS DE SÉCURITÉ" livré avec cet outil avant de l'utiliser.</li> </ul>
<ul style="list-style-type: none"> <li>To prevent eye injuries, always wear OSHA-required "Z87.1" safety glasses with permanently attached, rigid, hard plastic side shields. These safety glasses must have "Z87.1" printed or stamped on them. Be sure everyone in your work area is wearing the same type of safety glasses.</li> </ul>	<ul style="list-style-type: none"> <li>Para prevenir lesiones en los ojos, use siempre los anteojos de seguridad "Z87.1" requeridos por OSHA con escudos laterales rígidos de plástico duro y adheridos permanentemente. Estos anteojos de seguridad deben tener "Z87.1" marcado o impreso en ellos. Asegúrese que toda persona dentro de su área de trabajo use el mismo tipo de anteojos</li> </ul>	<ul style="list-style-type: none"> <li>Afin de protéger vos yeux contre les blessures, portez toujours des lunettes de sécurité OSHA "Z87.1" avec caches latéraux en plastique rigide. La mention "Z87.1" doit être imprimée ou poinçonnée sur ces lunettes de sécurité. Assurez-vous que toute personne se trouvant près du secteur de travail porte des lunettes de sûreté.</li> </ul>

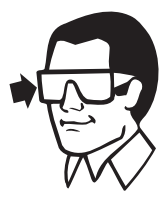
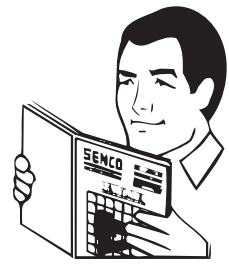

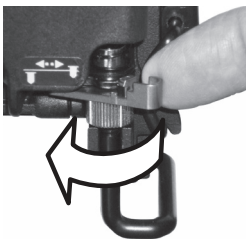
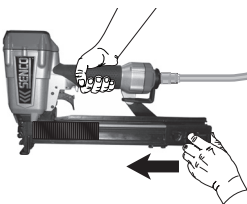
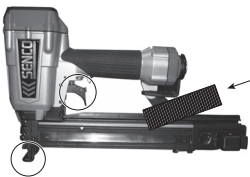
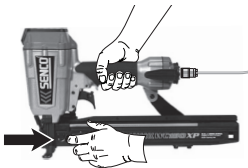

Tool Use		Uso de la Herramienta	Utilisation de l'Outil
English	Español	Français	
<ul style="list-style-type: none"> <li>● Keep tool pointed away from yourself and others and connect air to tool.</li> </ul>	<ul style="list-style-type: none"> <li>● Mantenga la herramienta apuntando en dirección opuesta de usted y de otros y conecte el aire a la manguera.</li> </ul>	<ul style="list-style-type: none"> <li>● Maintenez l'outil pointé à l'écart d'autres personnes et de vous-même et raccordez l'air à l'outil.</li> </ul>	
<ul style="list-style-type: none"> <li>● Never use a tool that leaks air or needs repair.</li> </ul>	<ul style="list-style-type: none"> <li>● Nunca use una herramienta que tenga escapes de aire o que necesite ser reparada.</li> </ul>	<ul style="list-style-type: none"> <li>● N'utilisez jamais un outil qui a des fuites d'air ou qui a besoin d'être réparé.</li> </ul>	
<ul style="list-style-type: none"> <li>● <b>To Load:</b> Pull feeder shoe back into "locked" position.</li> </ul>	<ul style="list-style-type: none"> <li>● <b>Para cargar:</b> Tire del alimentador hacia atrás hasta la posición "cerrada" ("locked").</li> </ul>	<ul style="list-style-type: none"> <li>● <b>Pour charger :</b> Tirez le sabot de chargeur en arrière dans la position "verrouillée" ("locked").</li> </ul>	
<ul style="list-style-type: none"> <li>● Lay strip of staples onto rail. Do not load with workpiece contact (safety element) or trigger depressed.</li> </ul>	<ul style="list-style-type: none"> <li>● Ponga la tira sobre la guía. No cargue con el disparo o la seguridad oprimidos.</li> </ul>	<ul style="list-style-type: none"> <li>● Mettez une bande d'agrafes sur le rail. Ne chargez pas avec le contact établi sur la pièce (élément de sécurité) ou la gâchette enfoncée.</li> </ul>	
<ul style="list-style-type: none"> <li>● Depress feeder shoe lock button and allow to slide forward.</li> </ul>	<ul style="list-style-type: none"> <li>● Presione el botón de la cerradura del zapato del alimentador y permita para resbalar adelante.</li> </ul>	<ul style="list-style-type: none"> <li>● Enfoncez le bouton de verrouillage de semelle de chargeur et laissez-le glisser en avant.</li> </ul>	
<ul style="list-style-type: none"> <li>● To adjust safety depth, rotate locking arm as shown to release lock.</li> </ul>	<ul style="list-style-type: none"> <li>● Para ajustar la profundidad del engrapado, abrir el pestillo.</li> </ul>	<ul style="list-style-type: none"> <li>● Pour effectuer la réglage de la pénétration de l'agrafe, ouvrez le loquet.</li> </ul>	

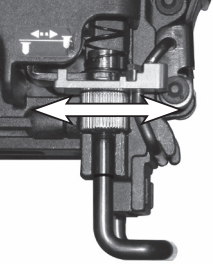
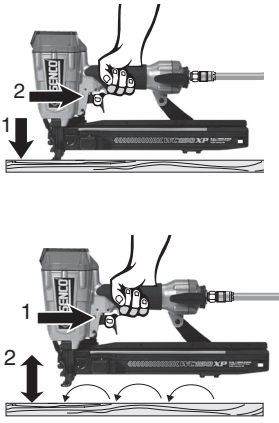
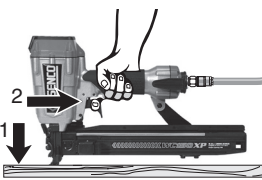
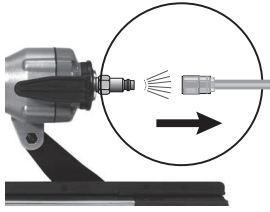
Tool Use	Uso de la Herramienta	Utilisation de l'Outil
English	Español	Français
 <ul style="list-style-type: none"> <li>Using the thumb or index finger, rotate wheel (located on side of guide body) to adjust the workpiece contact (safety element) to achieve desired depth.</li> </ul> <p>Press locking arm back into the locked position.</p>	<ul style="list-style-type: none"> <li>Usando el dedo pulgar o el dedo índice, rote la manivela (localizada a un lado de la placa de nariz) para ajustar el seguro a la profundidad deseada.</li> </ul> <p>Cierre pestillo.</p>	<ul style="list-style-type: none"> <li>A l'aide du pouce ou de l'index, faire tourner la molette (située sur le cote du front) pour ajuster la position du palpeur de sécurité.</li> </ul> <p>Fermer la serrure.</p>
 <ul style="list-style-type: none"> <li>With a "Sequential" (Dual-Action) trigger, staples can be driven two ways:             <ol style="list-style-type: none"> <li>Position workpiece contact (safety element) against work surface and pull trigger... "Sequential" operation.</li> <li>To drive a staple, pull trigger and push workpiece contact (safety element) against work surface. Each time the workpiece contact (safety element) is pushed against the work surface a staple will be driven. This "Contact Actuation" (bottom-fire) mode of operation is preferred when high production, rapid fastener placement is desired.</li> </ol> </li> </ul>	<ul style="list-style-type: none"> <li>Las herramientas con gatillo de accion doble pueden ser disparadas de dos maneras:             <ol style="list-style-type: none"> <li>Oprima el seguro contra la superficie de trabajo y apriete el gatillo...Disparo de gatillo.</li> <li>Para impulsar un clavo, oprima el disparador y deprima el elemento de seguridad contra la superficie de trabajo. Cada vez que deprima el elemento de seguridad contra la superficie de trabajo, impulsará un clavo. Este modo de operaci3n de "disparo inferior" o "por rebote" es el preferido cuando se desea alta productividad y r3pida colocaci3n del clavo.</li> </ol> </li> </ul>	<ul style="list-style-type: none"> <li>Les appareils 3quip3s de d3clenchement "au touch3 / par g3chette" peuvent 3tre utilis3s de 2 fa3ons diff3rentes :             <ol style="list-style-type: none"> <li>D3clenchement par "g3chette" : Appliquer le palpeur de s3curit3 de l'appareil 3 l'endroit d3sir3 et activer la g3chette.</li> <li>Pour planter un clou, tirez sur la d3tente et poussez l'3l3ment de s3curit3 contre la surface de travail. Chaque fois que l'3l3ment de s3curit3 est pouss3 contre la surface de travail un clou est plant3. Le mode de fonctionnement en "tir continu" est pr3f3rable si vous d3sirez placer des attaches rapidement avec forte productivit3.</li> </ol> </li> </ul>
 <ul style="list-style-type: none"> <li>With a "Sequential (Restrictive)" trigger, staples can only be driven one way. First depress workpiece contact (safety element) against work surface then pull trigger. This feature is helpful when precise fastener placement is required. Read the "Customer Satisfaction and Safety Reminder" (CSSR) in the tool and fastener boxes for safety information regarding the Contact-Actuation and Sequential triggers. Under certain conditions, the Sequential (restrictive) trigger may reduce the possibility of injury to you or to others working with you.</li> </ul>	<ul style="list-style-type: none"> <li>Las herramientas con "Gatillo Restringido" solamente se pueden disparar con el gatillo. Primero apriete el elemento de seguridad contra la superficie de trabajo y despu3s tire del gatillo. 3sta caracter3stica es 3til cuando se requiere precisi3n en la colocaci3n de los sujetadores. Lea el "Recordatorio de Seguridad y Satisfacci3n del Cliente" (CSSR) en las cajas de sujetadores y de las herramientas para informaci3n sobre seguridad de los Gatillos Restringido y de Acci3n Dual. Bajo ciertas condiciones, el Gatillo Restringido puede reducir la posibilidad de heridas a su persona o a otros que trabajen con usted.</li> </ul>	<ul style="list-style-type: none"> <li>Avec une gachette "restrictive", les clous ne peuvent 3tre tir3s que dans une seule direction. Appuyer d'abord le palpeur de s3curit3 sur la surface de travail, puis tirer sur la gachette. Cette fonction est utile pour un placement pr3cis de projectiles. Lire le "Rappel de S3curit3 et Satisfaction du Client" (CSSR) dans les boites 3 outils et fixations pour les informations de s3curit3 concernant les D3tentes 3 Double Action et 3 Restriction. Dans certaines circonstances, la D3tente 3 Restriction peut r3duire la possibilit3 de se blesser ou de blesser d'autres personnes.</li> </ul>
 <ul style="list-style-type: none"> <li>Should a staple jam occur, disconnect air supply.</li> </ul>	<ul style="list-style-type: none"> <li>Si se produce un atascamiento de las sujetadores, desconecte el suministro de aire.</li> </ul>	<ul style="list-style-type: none"> <li>Si un enrayage se produit, coupez l'arriv3e d'air.</li> </ul>

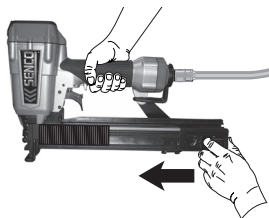
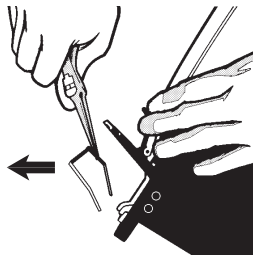
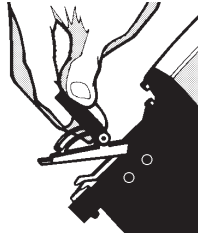
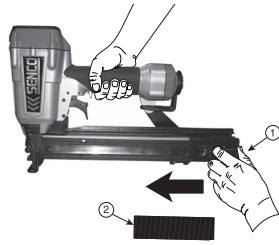

Tool Use	Uso de la Herramienta	Utilisation de l'Outil
English	Español	Français
<ul style="list-style-type: none"> <li>● Pull feeder shoe back into "locked" position and remove staples.</li> </ul>	<ul style="list-style-type: none"> <li>● Tire del alimentador hacia atrás a la posición "cerrada (locked)" y remueva las grapas.</li> </ul>	<ul style="list-style-type: none"> <li>● Tirez en arrière le sabot du chargeur dans la position de "verrouillage" et enlevez les projectiles.</li> </ul>
<ul style="list-style-type: none"> <li>● Release E-Z Clear latch and open door.</li> </ul>	<ul style="list-style-type: none"> <li>● Suelte el pestillo de alivio fácil (E-Z) y abra la puerta.</li> </ul>	<ul style="list-style-type: none"> <li>● Relâchez le loquet transparent "E-Z" et ouvrez le volet de front.</li> </ul>
<ul style="list-style-type: none"> <li>● Remove jammed fastener. Close door and latch.</li> </ul>	<ul style="list-style-type: none"> <li>● Remueva el sujetador atascado. Cierre la puerta con pestillo.</li> </ul>	<ul style="list-style-type: none"> <li>● Enlevez le projectile coincé. Fermez le volet de front et le loquet.</li> </ul>
<ul style="list-style-type: none"> <li>● Connect air supply and replace fasteners. Depress feeder shoe lock button and allow to slide forward.</li> </ul>	<ul style="list-style-type: none"> <li>● Conecte la línea de aire y reemplace los sujetadores. Presione el botón de la cerradura del zapato del alimentador y permita para resbalar adelante.</li> </ul>	<ul style="list-style-type: none"> <li>● Reconnectez la conduit d'air comprimé et rechargez le magasin. Enfoncez le bouton de serrure de chaussure de conducteur et laissez glisser en avant.</li> </ul>

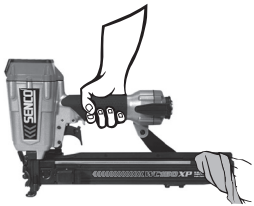
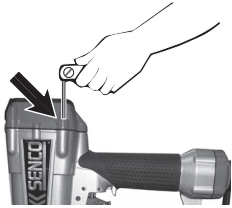
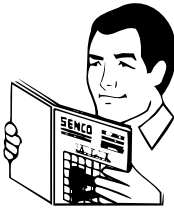

Maintenance English	Mantenimiento Español	Entretien Français
<ul style="list-style-type: none"> <li>● Read and understand "SAFETY INSTRUCTIONS" manual shipped with this tool before using tool.</li> </ul>	<ul style="list-style-type: none"> <li>● Antes de usar la herramienta lea y comprenda el manual "INSTRUCCIONES DE SEGURIDAD" despachado con ella.</li> </ul>	<ul style="list-style-type: none"> <li>● Lisez et assimilez le manuel "INSTRUCTIONS DE SÉCURITÉ" livré avec cet outil avant de l'utiliser.</li> </ul>
<ul style="list-style-type: none"> <li>● All screws should be kept tight. Loose screws result in unsafe operation and parts breakage.</li> </ul>	<ul style="list-style-type: none"> <li>● Todos los tornillos tienen que mantenerse apretados. Los tornillos sueltos pueden producir una operación no segura y quebraduras de partes.</li> </ul>	<ul style="list-style-type: none"> <li>● L'outil étant séparé de l'alimentation en air, effectuez une inspection journalière pour assurer le libre mouvement du palpeur de sécurité et de la détente. N'utilisez pas l'outil si le palpeur de sécurité ou la détente colle ou se coince.</li> </ul>
<ul style="list-style-type: none"> <li>● With tool disconnected, make daily inspection to assure free movement of workpiece contact (safety element) and trigger. Do not use tool if workpiece contact (safety element) or trigger sticks or binds.</li> </ul>	<ul style="list-style-type: none"> <li>● Con la herramienta desconectada, haga inspecciones diarias para asegurar el movimiento libre del seguro y del gatillo. No use la herramienta si el seguro o el gatillo se atorán.</li> </ul>	<ul style="list-style-type: none"> <li>● Toutes les vis doivent être maintenues serrées à fond. Les vis desserrées entraînent un manque de sûreté du fonctionnement et la rupture de pièces.</li> </ul>
<ul style="list-style-type: none"> <li>● Squirt Senco pneumatic oil (5 to 10 drops) into the air inlet twice daily. (Depending on frequency of tool use.) Other oils may damage O-rings and other tool parts.</li> </ul>	<ul style="list-style-type: none"> <li>● Aplique aceite neumático Senco en la entrada de aire dos veces al día. (Dependiendo en la frecuencia de uso 5 A 10 Gotas.) Otros aceites pueden dañar los anillos en "O" y otras piezas de la herramienta.</li> </ul>	<ul style="list-style-type: none"> <li>● Avec une burette, placer 5 à 10 gouttes d'huile pneumatique dans l'arrivée d'air deux fois par jour. (Dépend de l'intensité de l'utilisation de l'appareil.) D'autres huiles pourraient endommager les joints toriques et d'autres pièces de l'outil.</li> </ul>
<ul style="list-style-type: none"> <li>● Wipe tool clean daily and inspect for wear. Use non-flammable cleaning solutions only if necessary – DO NOT SOAK. CAUTION: Such solutions may damage O-rings and other tool parts.</li> </ul>	<ul style="list-style-type: none"> <li>● Solamente si es necesario use soluciones para limpieza no inflamables -NO LA REMOJE. Precaución: Tales soluciones pueden dañar los empaques y otras partes de la herramienta.</li> </ul>	<ul style="list-style-type: none"> <li>● Nettoyez l'outil chaque jour à l'aide d'un chiffon et inspectez-le pour déceler une éventuelle usure. Utilisez uniquement des solvants non inflammables en cas de nécessité – NE LE FAITES PAS TREMPER! Attention : De tels produits peuvent endommager les joints et d'autres pièces de l'appareil.</li> </ul>

Troubleshooting	Identificación de Fallas	Dépannage
English	Español	Français
<p><b>WARNING</b> Repairs other than those described here should be performed only by trained, qualified personnel. Contact SENCO for information at 1-800-543-4596.</p> <p>● Read and understand "SAFETY INSTRUCTIONS" manual shipped with this tool before using tool.</p>	<p><b>ALERTA</b> Las reparaciones, fuera de aquellas descritas aquí, deben de ser llevadas a cabo solamente por personal entrenado y calificado. Póngase en contacto con SENCO para información 1-800-543-4596.</p> <p>● Antes de usar la herramienta lea y comprenda el manual "INSTRUCCIONES DE SEGURIDAD" despachado con ella.</p>	<p><b>AVERTISSEMENT</b> Les réparations autres que celles décrites ici doivent être réalisées uniquement par du personnel qualifié ayant reçu la formation appropriée. Pour toute information, prenez contact avec SENCO par téléphone en appelant Le Distributeur agréé.</p> <p>● Lisez et assimilez le manuel "INSTRUCTIONS DE SÉCURITÉ" livré avec cet outil avant de l'utiliser.</p>
<p><b>SYMPTOM</b> Air leak near top of tool / Sluggish operation</p> <p><b>SOLUTION</b> Verify air supply / tighten screws or install Parts Kit A.</p>	<p><b>SÍNTOMA</b> El aire se escapa cerca de la parte superior de la herramienta / Operación lenta.</p> <p><b>SOLUCIÓN</b> Apriete los tornillos / Verifique el suministro de aire o instale el Juego de Partes A (Parts Kit A).</p>	<p><b>SYMPTÔME</b> Fuite d'air près du sommet de l'outil / fonctionnement lent.</p> <p><b>SOLUTION</b> Serrez les vis à fond / vérifiez l'alimentation en air ou remplacez les pièces portant la lettre "A".</p>
<p><b>SYMPTOM</b> Air leak near bottom of tool / Poor return.</p> <p><b>SOLUTION</b> Clean tool / tighten screws or install Parts Kit B.</p>	<p><b>SÍNTOMA</b> El aire se fuga cerca de la parte inferior de la herramienta / Mal retorno.</p> <p><b>SOLUCIÓN</b> Apriete los tornillos / Limpié la herramienta o instale el Juego de Partes B (Parts Kit B).</p>	<p><b>SYMPTÔME</b> Fuite d'air près de la base de l'outil / retour inadéquat.</p> <p><b>SOLUTION</b> Serrez les vis à fond / nettoyez l'outil ou remplacez les pièces portant la lettre "B"</p>
<p><b>SYMPTOM</b> Other problems.</p> <p><b>SOLUTION</b> Contact SENCO.</p>	<p><b>SÍNTOMA</b> Otros problemas.</p> <p><b>SOLUCIÓN</b> Póngase en contacto con SENCO.</p>	<p><b>SYMPTÔME</b> Autres problèmes.</p> <p><b>SOLUTION</b> Prenez contact avec SENCO.</p>

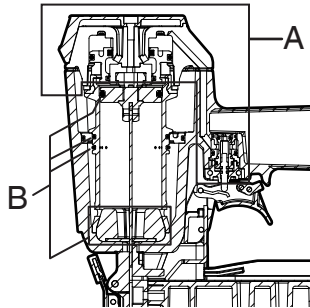

A = YK0783 Parts Kit  
B = YK0784 Parts Kit

Accessories	Accesorios	Accessoires
English	Español	Français
<p>SENCO offers a full line of accessories for your SENCO tools, including:</p> <ul style="list-style-type: none"> <li>● Air Compressors</li> <li>● Hose</li> <li>● Couplers</li> <li>● Fittings</li> <li>● Safety Glasses</li> <li>● Pressure Gauges</li> <li>● Lubricants</li> <li>● Regulators</li> <li>● Filters</li> </ul> <p>For more information or a complete illustrated catalogue of SENCO accessories, ask your representative for #MK336.</p>	<p>SENCO ofrece una línea completa de Accesorios para sus herramientas SENCO, incluyendo:</p> <ul style="list-style-type: none"> <li>● Compresores de Aire</li> <li>● Manguera</li> <li>● Conectores Rápidos</li> <li>● Conectores</li> <li>● Anteojos De Seguridad</li> <li>● Manómetros</li> <li>● Lubricantes</li> <li>● Reguladores</li> <li>● Filtros</li> </ul> <p>Para mas informacion ó un pur recibir un catalogo completo ilustrado de los Accesorios SENCO, pregunte a su representante para el numero MK336.</p>	<p>SENCO offre une gamme étendue d'accessoires pour vos outils SENCO y compris :</p> <ul style="list-style-type: none"> <li>● Compresseurs</li> <li>● Tuyauterie flexible</li> <li>● Raccords</li> <li>● Lunettes de sécurité</li> <li>● Manomètres</li> <li>● Lubrifiants</li> <li>● Régulateurs</li> <li>● Filtres</li> </ul> <p>Pour plus d'informations ou pour recevoir un catalogue détaillé des accessoires proposés par SENCO, prenez contact avec votre représentant SENCO (référence catalogue : #MK336).</p>

Options	Opciones	Options
English	Español	Français
<p>● <b>RESTRICTIVE TRIGGER</b>— This feature is helpful when precise fastener placement is required.</p>	<p>● <b>GATILLO RESTRINGIDO</b>— Esta característica sirve de ayuda cuando se requiere una colocación del sujetador precisa.</p>	<p>● <b>DECLÉNCHEMENT PAR GACHETTE</b>— Cette caractéristique s'avère utile quand un placement de projectiles précis s'impose.</p>

Specifications	Especificaciones	Specifications																				
English	Español	Français																				
<table border="1"> <thead> <tr> <th colspan="2">A</th> </tr> <tr> <th>inches</th> <th>mm</th> </tr> </thead> <tbody> <tr> <td><math>\frac{5}{8}</math></td> <td>16</td> </tr> <tr> <td><math>\frac{3}{4}</math></td> <td>20</td> </tr> <tr> <td>* <math>\frac{7}{8}</math></td> <td>22</td> </tr> <tr> <td>* 1</td> <td>25</td> </tr> <tr> <td>* <math>1 \frac{1}{4}</math></td> <td>32</td> </tr> <tr> <td>* <math>1 \frac{1}{2}</math></td> <td>38</td> </tr> <tr> <td>* <math>1 \frac{3}{4}</math></td> <td>45</td> </tr> <tr> <td>* 2</td> <td>50</td> </tr> </tbody> </table> <p>WC150XP WC150RXP WC200XP</p>	A		inches	mm	$\frac{5}{8}$	16	$\frac{3}{4}$	20	* $\frac{7}{8}$	22	* 1	25	* $1 \frac{1}{4}$	32	* $1 \frac{1}{2}$	38	* $1 \frac{3}{4}$	45	* 2	50		
A																						
inches	mm																					
$\frac{5}{8}$	16																					
$\frac{3}{4}$	20																					
* $\frac{7}{8}$	22																					
* 1	25																					
* $1 \frac{1}{4}$	32																					
* $1 \frac{1}{2}$	38																					
* $1 \frac{3}{4}$	45																					
* 2	50																					



English TECHNICAL SPECIFICATIONS	<b>WC150XP</b>		<b>WC150RXP</b>		<b>WC200XP</b>	
Minimum to maximum operating pressure	70–120 psi	4,8–8,3 bar	70–120 psi	4,8–8,3 bar	70–120 psi	4,8–8,3 bar
Air Consumption (60 cycles per minute)	3.18 scfm	90 liter	3.18 scfm	90 liter	3.45 scfm	97 liter
Air Inlet	$\frac{3}{8}$ in. NPT	$\frac{3}{8}$ in. NPT	$\frac{3}{8}$ in. NPT	$\frac{3}{8}$ in. NPT	$\frac{3}{8}$ in. NPT	$\frac{3}{8}$ in. NPT
Maximum Speed (cycles per second)	10	10	10	10	10	10
Weight	5 lbs.	2,3 kg	5.5 lbs.	2,5 kg	5.3 lbs.	2,4 kg
Staple Capacity	160	160	160	160	160	160
Tool size: Height	8 $\frac{7}{8}$ in.	225 mm	8 $\frac{7}{8}$ in.	225 mm	10 in.	254 mm
Tool size: Length	15 $\frac{1}{4}$ in.	387 mm	15 $\frac{1}{4}$ in.	387 mm	15 $\frac{1}{4}$ in.	387 mm
Tool size: Width: Main Body	3 $\frac{1}{2}$ in.	89 mm	4 in.	102 mm	3 $\frac{1}{2}$ in.	89 mm

Español ESPECIFICACIONES TÉCNICAS	<b>WC150XP</b>		<b>WC150RXP</b>		<b>WC200XP</b>	
Presión de operación mínima y máxima	70–120 psi	4,8–8,3 bar	70–120 psi	4,8–8,3 bar	70–120 psi	4,8–8,3 bar
Consumo de aire (60 ciclos por minuto)	3.18 scfm	90 liter	3.18 scfm	90 liter	3.45 scfm	97 liter
Entrada de aire	$\frac{3}{8}$ in. NPT	$\frac{3}{8}$ in. NPT	$\frac{3}{8}$ in. NPT	$\frac{3}{8}$ in. NPT	$\frac{3}{8}$ in. NPT	$\frac{3}{8}$ in. NPT
Velocidad máxima (ciclos por segundo)	5	5	5	5	10	10
Peso	5 lbs.	2,3 kg	5.5 lbs.	2,5 kg	5.3 lbs.	2,4 kg
Capacidad de grapas por cargador	70	70	70	70	160	160
Tamaño de la herramienta: Altura	8 $\frac{7}{8}$ in.	225 mm	8 $\frac{7}{8}$ in.	225 mm	10 in.	254 mm
Tamaño de la herramienta: Longitud	15 $\frac{1}{4}$ in.	387 mm	15 $\frac{1}{4}$ in.	387 mm	15 $\frac{1}{4}$ in.	387 mm
Tamaño de la herramienta: Ancho (Cuerpo)	3 $\frac{1}{2}$ in.	89 mm	4 in.	102 mm	3 $\frac{1}{2}$ in.	89 mm

Français SPECIFICATIONS TECHNIQUES	<b>WC150XP</b>		<b>WC150RXP</b>		<b>WC200XP</b>	
Pression de travail min. et max.	70–120 psi	4,8–8,3 bar	70–120 psi	4,8–8,3 bar	70–120 psi	4,8–8,3 bar
Consommation d'air (60 cycles par minute)	3.18 scfm	90 liter	3.18 scfm	90 liter	3.45 scfm	97 liter
Prise d'air	$\frac{3}{8}$ in. NPT	$\frac{3}{8}$ in. NPT	$\frac{3}{8}$ in. NPT	$\frac{3}{8}$ in. NPT	$\frac{3}{8}$ in. NPT	$\frac{3}{8}$ in. NPT
Vitesse maximum (cycles par seconde)	5	5	5	5	10	10
Poids	5 lbs.	2,3 kg	5.5 lbs.	2,5 kg	5.3 lbs.	2,4 kg
Capacité de agrafes par magasin	70	70	70	70	160	160
Dimensions de l'outil: hauteur	8 $\frac{7}{8}$ in.	225 mm	8 $\frac{7}{8}$ in.	225 mm	10 in.	254 mm
Dimensions de l'outil: longueur	15 $\frac{1}{4}$ in.	387 mm	15 $\frac{1}{4}$ in.	387 mm	15 $\frac{1}{4}$ in.	387 mm
Dimensions de l'outil: largeur: corps de l'appareil	3 $\frac{1}{2}$ in.	89 mm	4 in.	102 mm	3 $\frac{1}{2}$ in.	89 mm

## Limited Warranty SENCO® Pneumatic, DuraSpin®, Cordless Tools & Compressors

Senco Products, Inc. ("SENCO") designs and constructs its products using the highest standards of material and workmanship. SENCO warrants to the original retail purchaser that the following products will be free from defects in material or workmanship for the warranty period specified below:

SENCO® XP Series-Red Cap	SENCO PRO Series	SENCO Compressors	SENCO PC1194 Flooring Jack
Five years	One year	One year	One year
SENCO® XP Series-Black Cap	SENCO DuraSpin®	SENCO Cordless	Hand Nailers
Two Years	One year	Two years	One Year
SENCO FP502	SENCO Reconditioned Products	Gas Cordless	
Two Years	One Year	Two Years	

During the warranty period (which begins on the purchase date), SENCO will repair or replace, at SENCO's option and expense, any product or part that is defective in materials or workmanship after examination by a SENCO Authorized Warranty Service Center, subject to the exceptions, exclusions and limitations described below. Any replacement product or part will carry a warranty for the balance of the warranty period applicable to the replaced product or part. A DATED SALES RECEIPT OR PROOF OF PURCHASE FROM THE ORIGINAL RETAIL PURCHASER IS REQUIRED TO MAKE A WARRANTY CLAIM. Product registration can be accomplished through on-line Product Registration at [www.senco.com](http://www.senco.com) or by completing and returning the postage paid product registration form included with your Operator's manual/parts chart information, found inside the product carton. To make a warranty claim, you must return the product, with proper receipt/proof of purchase and return transportation charges prepaid, to a SENCO Authorized Warranty Service Center. A list of SENCO Authorized Warranty Service Centers can be found at [www.senco.com](http://www.senco.com) or by calling 1-800-543-4596 toll free. SENCO will perform its obligations under this warranty, within a reasonable time after approval of the warranty claim.

### Wheelbarrow Compressors:

- Subject to the exceptions, exclusions and limitations described below, SENCO warrants that the compressor pump will be free from defects in materials and workmanship for two years after the purchase date.
- Defective parts of the compressor pump not subject to normal wear and tear will be repaired or replaced, at SENCO's option, during the two year warranty period. If SENCO determines that repair or replacement is not feasible, SENCO will refund the purchase price less reasonable depreciation based on actual use.

### SENCO Cordless:

- Subject to the exceptions, exclusions and limitations described below, SENCO warrants that the SENCO Cordless tool will be free from defects in materials and workmanship for two years after the purchase date.
- Subject to the exceptions, exclusions and limitations described below, SENCO warrants that the batteries and chargers used with SENCO Cordless tools will be free from defects in material and workmanship for one year after the purchase date.

### WARRANTY EXCLUSIONS

The following warranty exclusions apply:

- Normal wear parts are not covered under this warranty. Normal wear parts include, for example, isolators, drive belts, air filters, rubber o-rings, seals, driver blades, piston stops, piston/driver assembly, and fuel stems.
- This warranty does not cover parts damaged due to normal wear, misapplication, misuse, accidents, operation at other than recommended speeds or voltage (electric units only), improper storage, or damage resulting during shipping.
- Products used in production/industrial applications as defined by SENCO are excluded from this warranty.
- Labor charges or loss or damage resulting from improper operation, maintenance or repairs are not covered by this warranty.
- SENCO does not warrant the Wheelbarrow Compressor Engine/Motor, but the Compressor Engine/Motor may be covered under a warranty offered by its manufacturer.

### GENERAL WARRANTY CONDITIONS

This warranty will be honored, only if:

- Clean, dry, regulated compressed air has been used, at air pressure not exceeding the maximum indicated on the tool casting;
- No evidence of abuse, abnormal conditions, accident, neglect, misuse or improper modifications or storage of the product; and
- No Deviation from operating instructions, specifications, and maintenance schedules exists (read Operator Manual for use, specifications, and maintenance instructions).

THIS WARRANTY IS THE ONLY WARRANTY ON THE PRODUCT, AND SENCO DISCLAIMS ALL OTHER WARRANTIES. ANY IMPLIED WARRANTIES WILL BE LIMITED IN DURATION TO THE APPLICABLE WARRANTY PERIOD SPECIFIED ABOVE. SOME STATES DO NOT ALLOW LIMITATIONS ON HOW LONG AN IMPLIED WARRANTY LASTS, SO THE ABOVE LIMITATION MAY NOT APPLY TO YOU. YOUR REMEDIES ARE SOLELY AND EXCLUSIVELY AS STATED ABOVE. SENCO SHALL IN NO EVENT BE LIABLE FOR INCIDENTAL, CONSEQUENTIAL, INDIRECT, OR SPECIAL DAMAGES. SOME STATES DO NOT ALLOW THE EXCLUSION OR LIMITATION OF INCIDENTAL OR CONSEQUENTIAL DAMAGES, SO THE ABOVE LIMITATION OR EXCLUSION MAY NOT APPLY TO YOU. IN NO EVENT, WHETHER AS A RESULT OF A BREACH OF CONTRACT, WARRANTY, TORT (INCLUDING NEGLIGENCE) OR OTHERWISE, SHALL SENCO'S LIABILITY EXCEED THE PRICE OF THE PRODUCT WHICH HAS GIVEN RISE TO THE CLAIM OR LIABILITY. ANY LIABILITY CONNECTED WITH THE USE OF THIS PRODUCT SHALL TERMINATE UPON THE EXPIRATION OF THE WARRANTY PERIOD SPECIFIED ABOVE. NO EMPLOYEE OR REPRESENTATIVE OF SENCO OR ANY DISTRIBUTOR OR DEALER IS AUTHORIZED TO MAKE ANY CHANGE OR MODIFICATION TO THIS WARRANTY.

This warranty gives you specific legal rights, and you may also have other rights which vary from state to state.

### REPLACEMENT OF TOOL DUE TO NATURAL DISASTER

SENCO will replace any tool destroyed by an Act of God such as flood, earthquake, hurricane or other disaster resulting only from the forces of nature. Such a claim will be honored provided that such original retail purchaser had previously submitted a completed warranty registration card for the tool, and then submits proof of ownership and an acceptable statement describing such Act of God documented by an insurance carrier, police department, or other official governmental source. To obtain instructions for filing a claim call 1-800-543-4596.

### CUSTOMER SATISFACTION

One hundred percent customer satisfaction is our #1 goal. If for any reason the product does not perform to the original purchaser's satisfaction, it can be returned to the place of purchase **within thirty days** with dated sales receipt for a full refund of the purchase price.





## Free Manuals Download Website

<http://myh66.com>

<http://usermanuals.us>

<http://www.somanuals.com>

<http://www.4manuals.cc>

<http://www.manual-lib.com>

<http://www.404manual.com>

<http://www.luxmanual.com>

<http://aubethermostatmanual.com>

Golf course search by state

<http://golfingnear.com>

Email search by domain

<http://emailbydomain.com>

Auto manuals search

<http://auto.somanuals.com>

TV manuals search

<http://tv.somanuals.com>