



Digital Wireless System
RS 180

Instruction manual

Contents

Important safety information	2
The RS 180 digital RF headphone system	4
Delivery includes	5
Product overview	6
Overview of the HDR 180 headphones	6
Overview of the TR 180 transmitter	7
Overview of the indicators and acoustic signals	8
Overview of the connection stages	10
Putting the RS 180 into operation	11
Setting up the transmitter	11
Connecting the transmitter to a sound source	12
Connecting the transmitter to the mains	16
Inserting and changing the rechargeable batteries	17
Charging the headphones' rechargeable batteries	18
Adjusting the headband of the headphones	18
Using the RS 180	19
Switching the transmitter on and off	19
Switching the headphones on and off	21
Adjusting the volume on the headphones	22
Muting the headphones	22
Adjusting the sound of the RS 180 to your needs	23
Associating the headphones to the transmitter	25
Listening with several headphones simultaneously	28
Cleaning the RS 180	29
If a problem occurs	30
Accessories and spare parts	32
Specifications	33
Manufacturer declarations	34

Important safety information

- Please read this instruction manual carefully and completely before using the product.
- Make this instruction manual easily accessible to all users at all times. Always include this instruction manual when passing the product on to third parties.
- Do not use the product in situations which require special attention (e.g. in traffic or when performing skilled jobs).
- Always keep the product dry and do not expose it to extreme temperatures (normal operating temperatures: 0 °C/32 °F to 40 °C/104 °F).
- Use the product with care and store it in a clean, dust-free environment.
- Switch the headphones off after use to conserve battery power. Remove the batteries if the product will not be used for extended periods of time.
- The headphones contain magnets that generate a magnetic field which could cause interference with cardiac pacemakers and implanted defibrillators. Keep the headphones at least 1.2" (3 cm) from cardiac pacemakers or implanted defibrillators.
- Please protect your hearing from high volume levels. Sennheiser headphones also sound exceptionally good at low volumes.
- Only use the Sennheiser supplied power supply units.
- To reduce the risk of fire or electric shock, do not use the product near water and do not expose it to rain or moisture.
- Unplug the power supply unit from the wall socket
 - to completely disconnect the product from the mains
 - during lightning storms or
 - when unused for long periods of time.
- Only operate the power supply unit from the type of power source specified in the chapter "Specifications" (see page 33).
- Ensure that the power supply unit is
 - in a safe operating condition and easily accessible,
 - properly plugged into the wall socket,
 - only operated within the permissible temperature range,
 - not covered or exposed to direct sunlight for longer periods of time in order to prevent heat accumulation (see "Specifications" on page 33).
- Do not operate the product near any heat sources.
- Only use attachments/accessories specified by Sennheiser (see "Accessories and spare parts" on page 32).

Replacement parts

When replacement parts are required, be sure the service technician uses replacement parts specified by Sennheiser or those having the same characteristics as the original part. Unauthorized substitutions may result in fire, electric shock, or other hazards.

Intended use

Intended use of the product includes

- having read this instruction manual, especially the chapter “Important safety instructions” on page 2,
- using the product within the operating conditions and limitations described in this instruction manual.

“Improper use” means using the product other than as described in this instruction manual, or under operating conditions which differ from those described herein.















Safety instructions for the NiMH rechargeable batteries

If abused or misused, the rechargeable batteries may leak. In extreme cases, they may even present



- a heat hazard,
- a fire hazard,
- an explosion hazard,
- a smoke or gas hazard.

Please understand that Sennheiser does not accept liability for damage arising from abuse or misuse.

	Keep away from children.		Only use rechargeable batteries recommended by Sennheiser.
	Observe correct polarity.		Do not short-circuit.
	Do not expose to moisture.		Switch rechargeable battery-powered products off after use.
	Do not pack charged batteries loose – danger of shorting out/fire hazard.		When not using rechargeable batteries for extended periods of time, charge them regularly (about every 3 months).
	Only charge rechargeable batteries at ambient temperatures between 10 °C/50 °F and 40 °C/104 °F.		Do not heat above 70 °C/158 °F, e.g. do not expose to sunlight or throw into a fire.
	Do not mutilate or dismantle.		Do not continue to use defective rechargeable batteries.
	Immediately remove rechargeable batteries from obviously defective devices.		Dispose of rechargeable batteries at special collection points or return it to your specialist dealer.

The RS 180 digital RF headphone system

The RS 180 is an RF stereo hi-fi headphone system with comprehensive technical features. Its transparent and balanced sound image with excellent bass response makes this system an ideal choice for hi-fi, home cinema and TV use.

The rechargeable batteries can conveniently be recharged while in the headphones. Enjoy total freedom of sound, stylish design and maximum comfort.

Additional features of the RS 180 headphone system

- Transmits uncompressed audio over a robust 2.4 GHz digital link, enabling you to enjoy your music without the hassles of cables.
- Dynamic transducer systems with powerful neodymium magnets deliver clear and detailed audio reproduction.
- Kleer's uncompressed digital wireless transmission delivers CD-quality sound.
- No set-up required – just plug and play. Simply connect the transmitter to your personal audio/video player, put on the headphones and turn it on!
- TR 180 transmitter with multi-receiver capability, enabling up to 4 people to listen to the same sound source.

Kleer™ wireless transmission technology



The RS 180 headphone system features the digital wireless audio transmission technology from Kleer. The Kleer company has developed an RF-based wireless transmission standard (of the same name) that offers lossless audio transmission in CD-quality while consuming minimal power.

Delivery includes

- 1 HDR 180 headphones
- 1 TR 180 transmitter
- 1 power supply unit with country adapters
- 1 stereo audio cable with 3.5 mm jack plugs
- 1 adapter 3.5 mm jack socket to 1/4" (6.3 mm) jack plug
- 1 adapter 3.5 mm jack socket to 2 RCA plugs
- 2 AAA size NiMH rechargeable batteries, 1.2 V
- 1 cable dresser
- 1 cable binder
- 1 quick guide incl. CD ROM with detailed instruction manual (PDF file)
- 1 safety guide

Product overview

Overview of the HDR 180 headphones





- ① Headband
- ② Charging contacts
- ③ Ear pads
- ④ Battery compartments
- ⑤ VOLUME + button
- ⑥ Multi-function button 
- ⑦ VOLUME - button
- ⑧ BALANCE L button
- ⑨ BALANCE R button
- ⑩ Multi-function LED

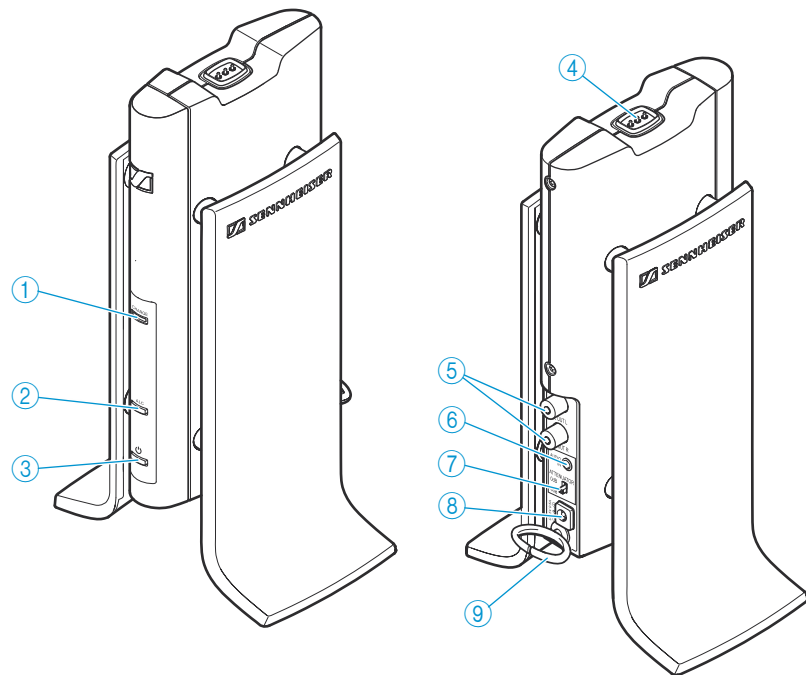

With the multi-function button  ⑥, you can switch the headphones on/to standby mode, set the headphones to multi-user operation, mute the headphones and associate the headphones

Overview of the TR 180 transmitter





- ① CHARGE LED, orange
- ② ALC button, backlit in green
- ③ Multi-function button , backlit in green
- ④ Charging contacts for charging the headphones
- ⑤ RCA output (LINE OUT R, LINE OUT L)
- ⑥ Audio input (AUDIO IN)
- ⑦ ATTENUATOR switch
- ⑧ Socket for power supply unit (DC 5V 0.5A)
- ⑨ Cable dresser





With the multi-function button  ③, you can switch the transmitter on/to standby mode, set the transmitter to multi-user operation and associate the transmitter.

Overview of the indicators and acoustic signals

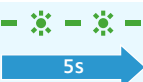



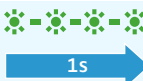
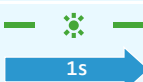

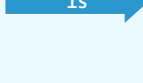



Meaning of the pictograms for the different LEDs

Status	Meaning
	The LED is lit.
	The LED flashes once per second.
	The LED flashes twice every 5 seconds.

Indicators on the headphones

Indicator	Status	Meaning
Multi-function LED ¹⁰		The rechargeable batteries are almost flat.
		The headphones are in enrollment mode (searching for a transmitter to pair with).
		The headphones are in association mode (exchanging device information with the transmitter).
		The headphones receive an audio signal.

Indicators on the transmitter

Indicator	Status	Meaning
CHARGE LED ①		The rechargeable batteries are being charged.
	off	The rechargeable batteries are fully charged.
ALC button ②		Automatic level control is activated.
Multi-function button  ③	off	The transmitter is in standby mode.
	 —  — 1s →	The transmitter is in enrollment mode (searching for headphones to pair with).
	—  —  — 1s →	The transmitter is in association mode (exchanging device information with the headphones).
	—  — 5s →	The transmitter is in single-user operation.
	—  —  — 5s →	The transmitter is in multi-user operation.

Acoustic signal of the headphones

1 short beep	Meaning
	The minimum volume is reached.
	The maximum volume is reached.
	The minimum balance is reached.
	The maximum balance is reached.

Overview of the connection stages

Connection establishment

Enrollment mode

When you switch the headphones and the transmitter on, the headphones search for a suitable transmitter.

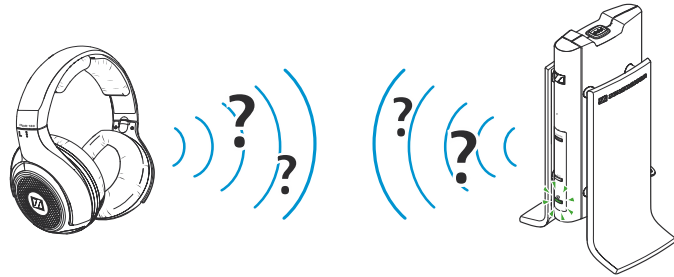
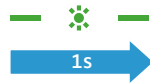

Pairing

The headphones and the transmitter have recognized each other and the headphones are paired with the transmitter.

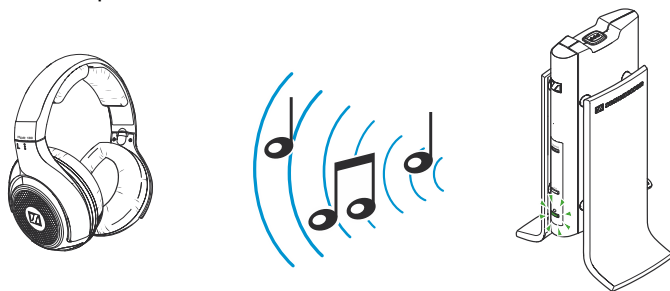
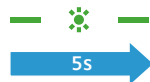

Single-user and multi-user operation

Single-user operation

You can listen to your sound source via one pair of headphones. By default, the transmitter is set to single-user operation (see page 25).

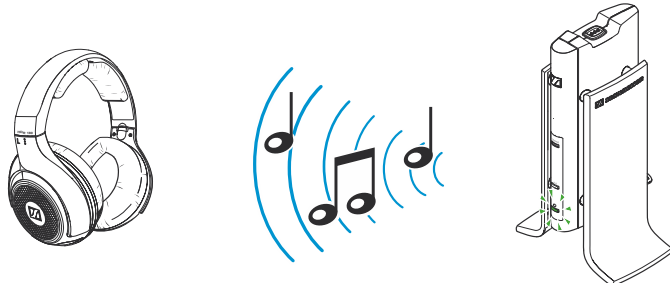
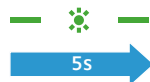

Multi-user operation

In order to be able to listen to your sound source with several headphones simultaneously, you have to set your transmitter to multi-user operation (see page 28).

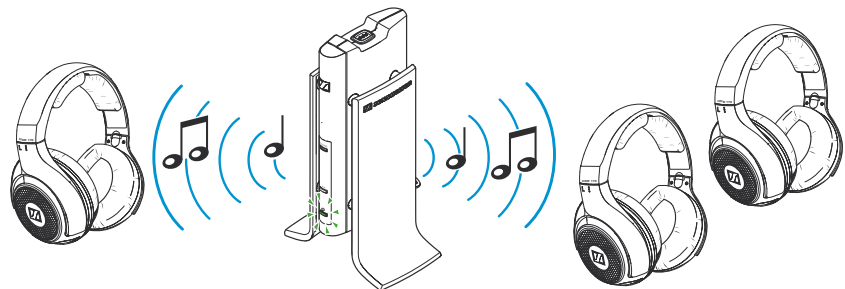

Putting the RS 180 into operation

Setting up the transmitter

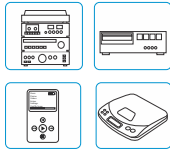

- ▶ Choose a suitable place near your sound source (e.g. TV, stereo or home cinema system).
- ▶ Do not place the transmitter close to metal objects such as shelf bars, reinforced concrete walls, etc. as this can decrease the transmitter's range.

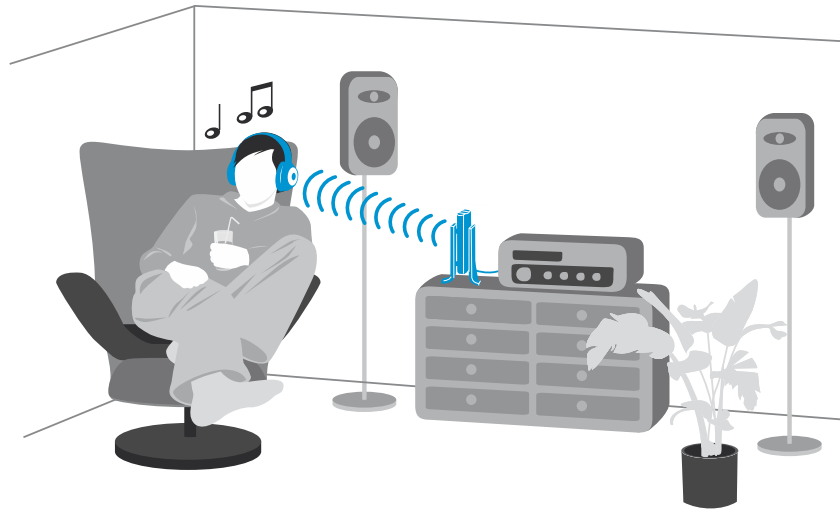

It is not necessary that the transmitter and headphones are in the same room, so you can move around freely in the home or outside in the garden.

Cable dresser

- ▶ Snap the cable dresser ⑨ into the opening at the rear of the transmitter.
- ▶ Dress the cables through the small slit of the cable dresser ⑨. The cable dresser prevents the cables from slipping out of the sockets or being kinked.

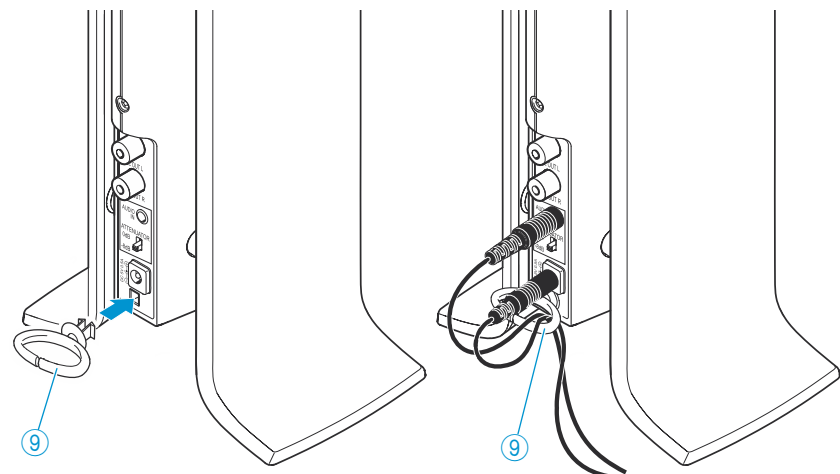

- ▶ Use the cable binder to conceal the cables.

Connecting the transmitter to a sound source

You can connect the TR 180 transmitter to different sound sources, such as a TV, a DVD player or a stereo system.

- ▶ Switch your sound source off before connecting the transmitter.

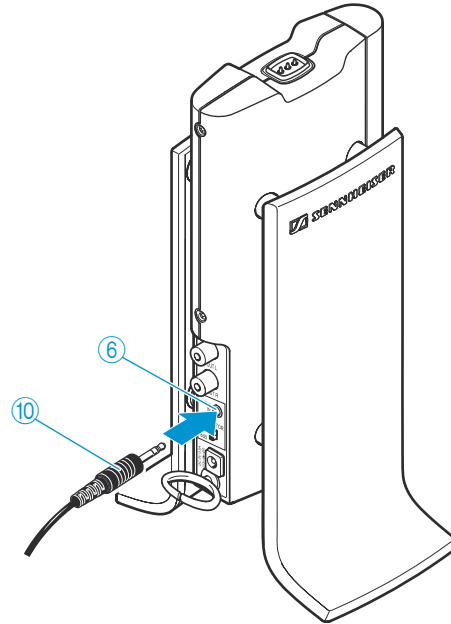

- ▶ Connect the audio cable ⑩ to the audio input ⑥ of the transmitter.
- ▶ Check the connection possibility of your sound source.

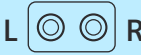
Chapter	Connection possibility	Type of socket
A		Headphone socket
B		RCA sockets (output)

- ▶ Follow the instructions in the corresponding chapter in order to connect your transmitter to the sound source.

A Connecting the transmitter to a headphone socket

Depending on your sound source, you have to change the setting of the **ATTENUATOR** switch ⑦ in order to optimally adjust the signal of the sound source.

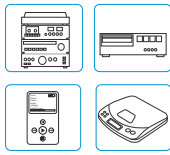

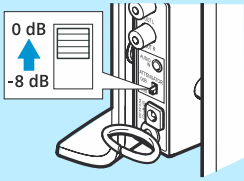
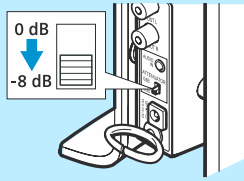
Portable sound source (MP3 player, mobile telephone)	Stationary sound source (hi-fi system, amplifier)
▶ Set the ATTENUATOR switch ⑦ to "0 dB".	▶ Set the ATTENUATOR switch ⑦ to "-8 dB".
	

- ▶ Adjust the volume of the headphone socket on your sound source to a medium level. This improves the quality of wireless sound transmission. If necessary, check the settings of your sound source.
- ▶ Connect the audio cable ⑩ to the headphone socket of your sound source.

If the plug on the audio cable ⑩ is too small for your headphone socket, plug the adapter to 1/4" (6.3 mm) jack plug ⑪ onto the audio cable.

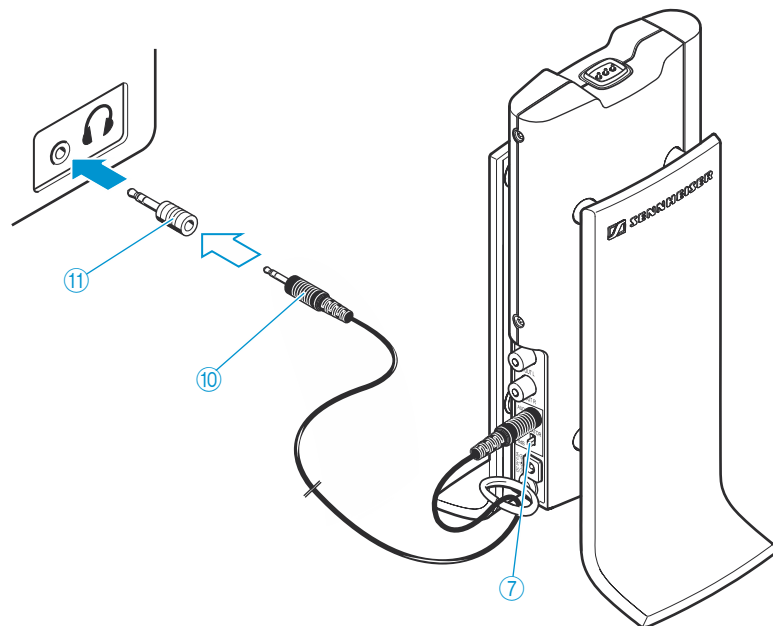

B Connecting the transmitter to RCA sockets (output)

WARNING Danger of hearing damage due to high volumes!



You can suffer hearing damage if you are using other Klear compatible headphones without integrated volume control, such as the Sennheiser MX W1, with the TR 180 transmitter:

- ▶ In this case, do not connect the transmitter to the RCA sockets (output) of your sound source, but to the headphone socket of your sound source.
- ▶ Before putting the headphones on, set the volume on the sound source to a low level.

Depending on your sound source, you have to change the setting of the **ATTENUATOR** switch ⑦ in order to optimally adjust the signal of the sound source.

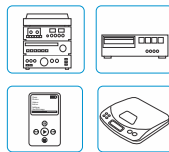

Portable sound source (MP3 player, mobile telephone)	Stationary sound source (hi-fi system, amplifier)
▶ Set the ATTENUATOR switch ⑦ to "0 dB".	▶ Set the ATTENUATOR switch ⑦ to "-8 dB".

- ▶ Plug the adapter for RCA sockets ⑫ onto the audio cable ⑩.
- ▶ Connect the red connector of the adapter ⑫ to the red socket **R** of your sound source.
- ▶ Connect the white connector of the adapter ⑫ to the white or black socket **L** of your sound source.

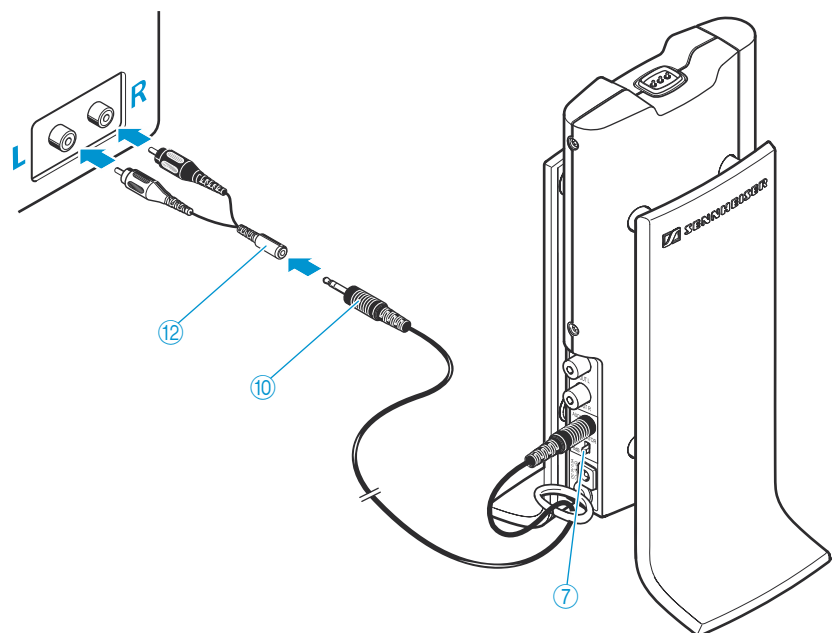

i If your sound source has several RCA sockets, use the RCA outputs (usually "Audio Out").

Integrating the transmitter into an existing connection between devices

To integrate the transmitter into an existing connection between your sound source and an additional device (e.g. an amplifier):

- ▶ Check if the RCA cable of the additional device is connected to an input (see the instruction manual of the device).
- ▶ Connect the RCA cable of the additional device to the RCA output ⑤ of the transmitter.

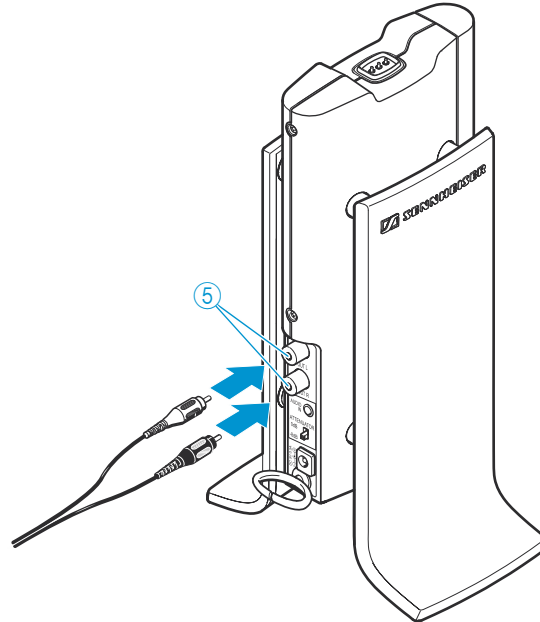

The transmitter must remain connected to the mains. Otherwise, the connection between your sound source and the additional device will be interrupted.

Connecting the transmitter to the mains

- ▶ Select the suitable country adapter **14** for your wall socket.
- ▶ Slide the country adapter **14** onto the power supply unit **13** until it locks into place.

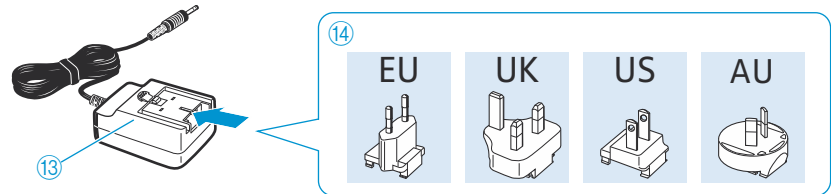

- ▶ Connect the connector **15** of the power supply unit to the socket **8**.

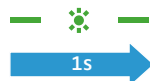
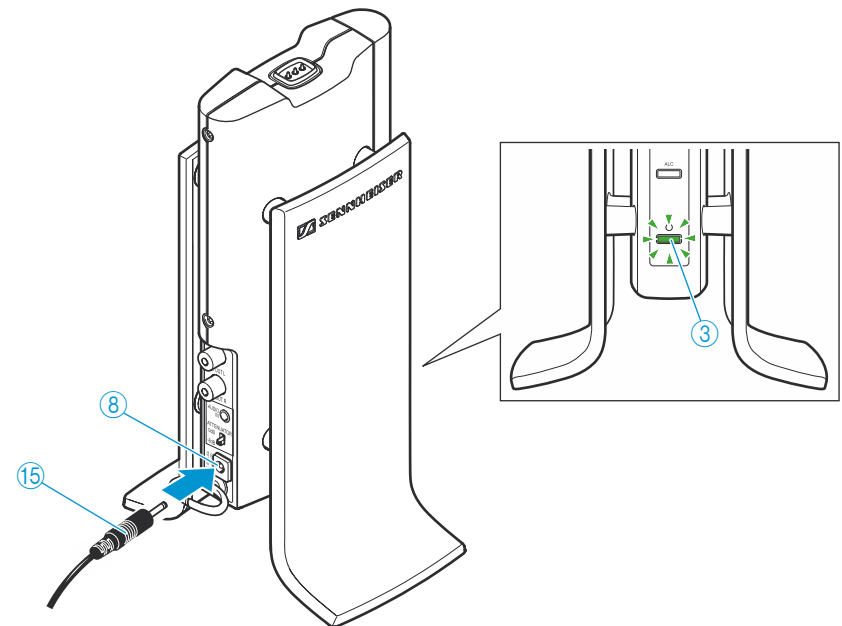

- ▶ Plug the power supply unit **13** into a wall socket. The transmitter switches on. The multi-function button **3** flashes green after 9 seconds. The transmitter is in enrollment mode.

Inserting and changing the rechargeable batteries



For powering the headphones, you can use:

- standard batteries (AAA size, 1.5 V)
- NiMH rechargeable batteries (AAA size, 1.2 V, 600 mAh)

If you are using standard batteries, the headphones must **not** be placed on the headphone holder/charger of the transmitter.

- ▶ Remove the ear pads **3** from both ear cups by turning the ear pads in the direction of the arrow until you overcome a slight resistance.
- ▶ Lift the ear pads **3** off the ear cups.

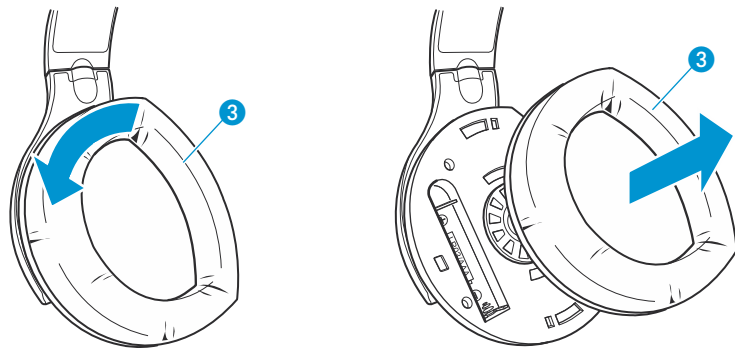

- ▶ Remove the depleted rechargeable batteries (where applies).
- ▶ Insert the rechargeable batteries. Observe correct polarity when inserting the batteries.

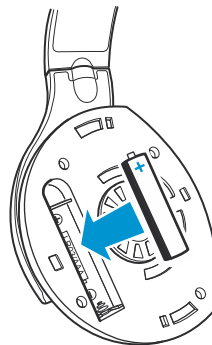

- ▶ Secure the ear pads **3** to the ear cups.

Charging the headphones' rechargeable batteries

CAUTION Danger of damage to the headphones!

If standard batteries are inserted into the headphones and you place the headphones on the headphone holder/charger of the transmitter, the batteries can leak and damage your headphones.

- ▶ Only place the headphones on the headphone holder/charger of the transmitter, if rechargeable batteries are inserted.



Charge the rechargeable batteries for at least 16 hours prior to first time use. Subsequent charging time is about half of the previous operating time. The operating time is up to 24 hours.

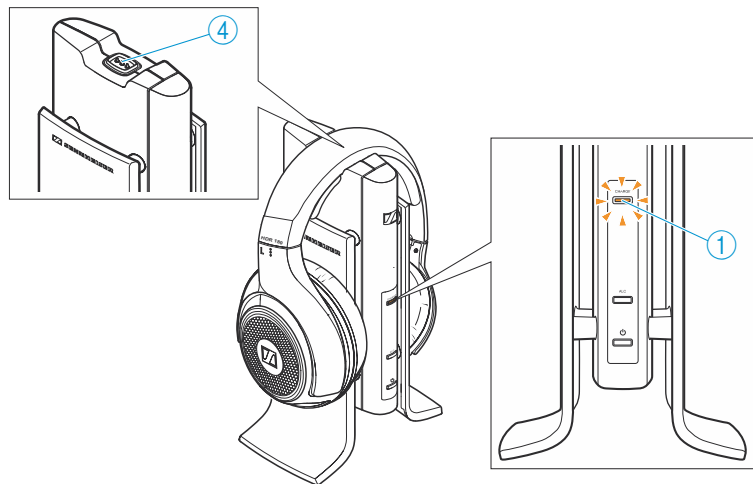

- ▶ Place the headphones on the headphone holder/charger of the transmitter. Make sure that the headphones make good contact with the charging contacts ④. The rechargeable batteries are being charged. The CHARGE LED ① lights up orange.

When the rechargeable batteries are fully charged, the CHARGE LED ① goes off.



Always store the headphones on the headphone holder/charger to ensure that they are fully charged when they are needed.

Adjusting the headband of the headphones

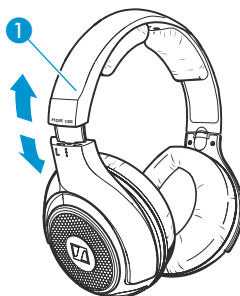

For good sound quality and best possible comfort, the headband has to be adjusted to properly fit your head. To do so, adjust the headband ① via its snap-in locking mechanism:

- ▶ Wear the headphones so that the headband ① runs over the top of your head.
- ▶ Adjust the length of the headband so that
 - your ears are completely inside the earpads,
 - you feel even, gentle pressure around your ears,
 - a snug fit of the headband ① on the head is ensured.

Using the RS 180



To switch the product on and to listen to your sound source, proceed as follows:

Sequence of steps	Page
1. Make sure that the rechargeable batteries are charged.	17
2. Switch your sound source on.	–
3. Switch your transmitter on.	19
4. Switch your headphones on.	21
5. Adjust the desired volume.	22

Switching the transmitter on and off

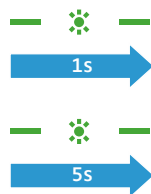
Switching the transmitter on



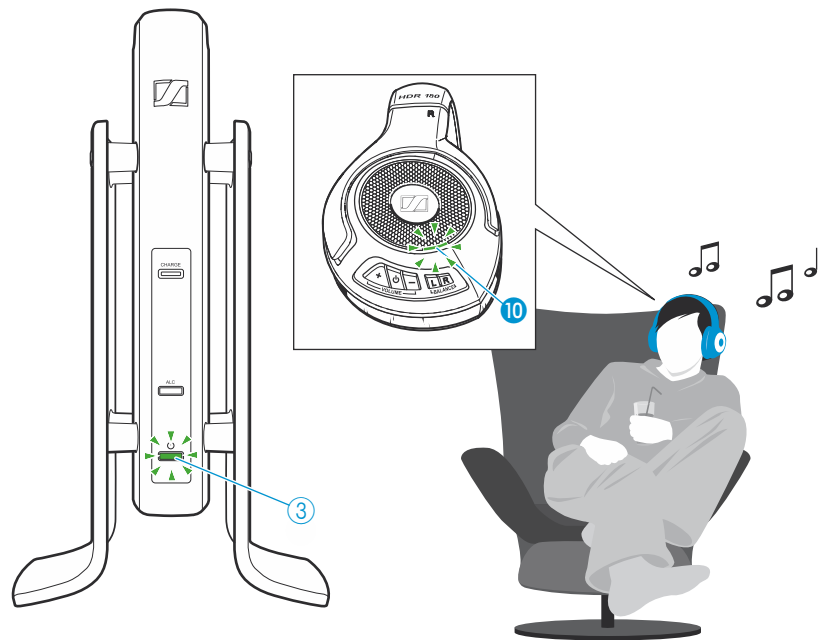

- ▶ Press the multi-function button  ③ for approx. 1 second. The transmitter switches on. The multi-function button  ③ flashes green, indicating that the transmitter is in enrollment mode.

Once the transmitter has found suitable headphones, it pairs with the headphones and transmits an audio signal. The multi-function LED ⑩ of the headphones and the multi-function button  ③ of the transmitter flash slowly.



Switching the transmitter off

- ▶ Press the multi-function button  ③ for approx. 1 second. The multi-function button  ③ goes off. The transmitter is in standby mode.

To disconnect the transmitter from the mains:

- ▶ Pull out the mains plug from the wall socket. Please note that In this case, the headphones' rechargeable batteries will not be recharged.



If the headphones are outside the transmission range or switched off for more than 5 minutes, the transmitter automatically switches to standby mode. The multi-function button  ③ goes off. In standby mode, the transmitter's power consumption is very low so that it can remain connected to the mains.

Switching the headphones on and off

WARNING Danger due to high volumes!





Listening at high volume levels for long periods can lead to permanent hearing defects.

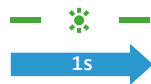

- ▶ Before putting the headphones on, set the volume to a low level.
- ▶ Do not continuously expose yourself to high volumes.

Switching the headphones on



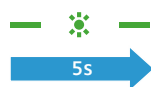

- ▶ Press the multi-function button  6 for approx. 1 second. The headphones switch on. The multi-function LED  flashes green, indicating that the headphones are in enrollment mode.

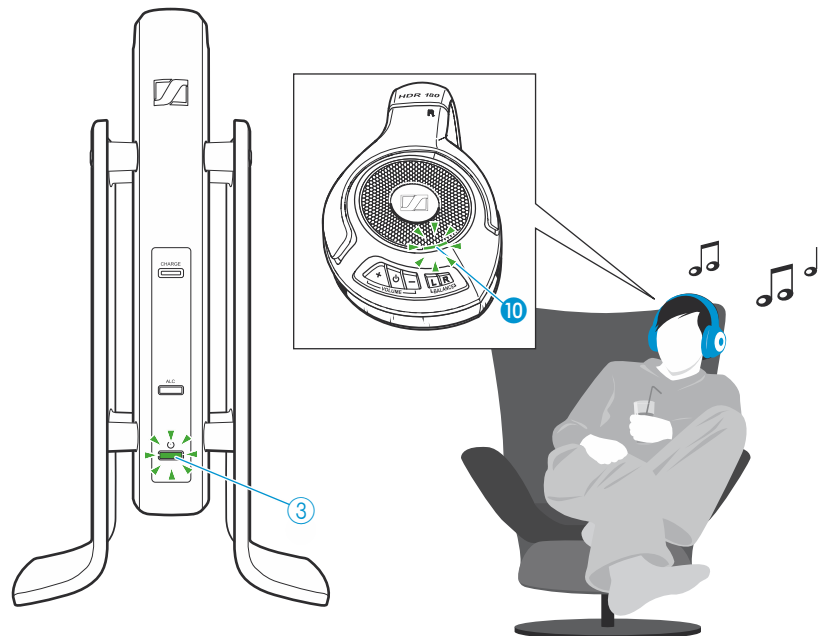

Once the headphones have found a suitable transmitter, the transmitter pairs with the headphones and transmits an audio signal. The multi-function LED  of the headphones and the multi-function button  3 of the transmitter flash slowly.



Switching the headphones off

- ▶ Press the multi-function button  6 for approx. 1 second. The multi-function LED  goes off. The headphones are in standby mode.



If there is no signal from the transmitter for more than 5 minutes, the headphones automatically switch to standby mode.

Adjusting the volume on the headphones

- ▶ Press the **VOLUME –** button **7** or the **VOLUME +** button **5** repeatedly until the volume is adjusted to a comfortable and undistorted level.

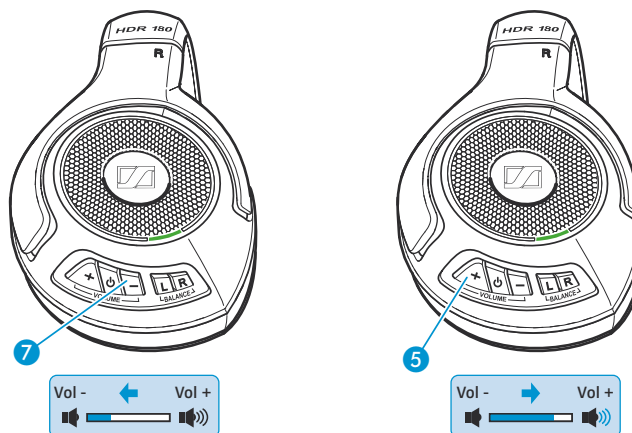

Muting the headphones

- ▶ Briefly press the multi-function button **6** to mute the headphones or to cancel the muting.



Adjusting the sound of the RS 180 to your needs

Adjusting the balance

The balance buttons allow for left/right volume adjustment. Adjust the balance so that you hear equally well with both ears.

To adjust the volume for your left (L) or right (R) ear:

- ▶ Press the **BALANCE L** button **8** or the **BALANCE R** button **9**.

To adjust the same volume for both ears:

- ▶ Simultaneously press the **BALANCE L** button **8** and the **BALANCE R** button **9**.



Enhancing the speech intelligibility

The speech intelligibility can be enhanced by activating a dynamic compression system ([Automatic Level Control](#)).

When activated, the automatic level control evens out volume differences, i.e. it reproduces soft passages louder and decreases loud sounds. This seems to put the speech in the foreground, making it easier to understand.

To activate the automatic level control:

- ▶ Press the [ALC](#) button ② on the transmitter.
The [ALC](#) button ② is backlit in green.

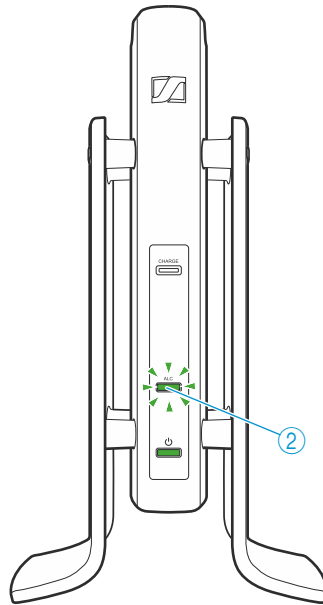

Associating the headphones to the transmitter



The RS 180 system features the digital wireless audio transmission technology from Klear. You can also associate other Klear compatible headphones (e.g. the Sennheiser MX W1) to the transmitter. For more information, refer to the chapter "Associating other Klear compatible headphones to the transmitter" on page 27 or to the instruction manual of the corresponding product.

The headphones and the transmitter are already associated upon delivery. You only have to associate the headphones to the transmitter

- if you want to use another pair of Klear compatible headphones or
- if the transmission between the headphones and the transmitter is disturbed by interferences in the vicinity.

If you want to use several headphones, refer to the chapter "Associating several headphones to the transmitter" on page 27.



Associating the HDR 180 headphones to the transmitter

When associating the headphones to the transmitter, the distance between the transmitter and the headphones should not exceed 1 m.

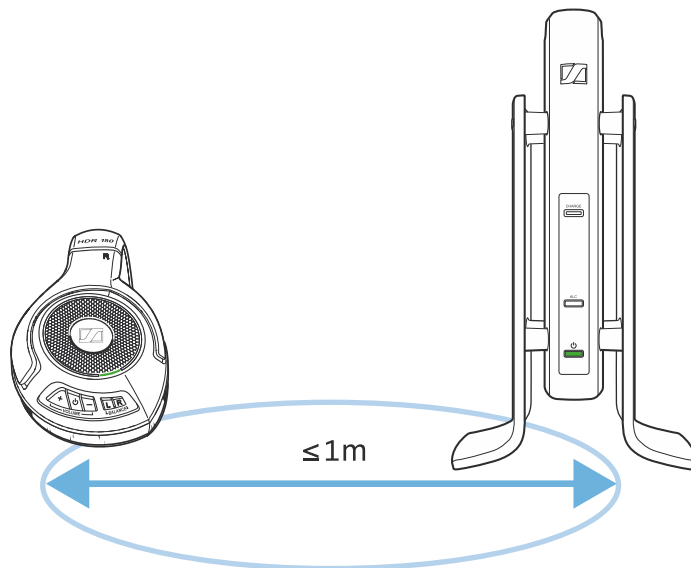

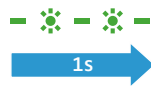
- ▶ Make sure that the transmitter and the headphones are in standby mode (see page 20 and 21).



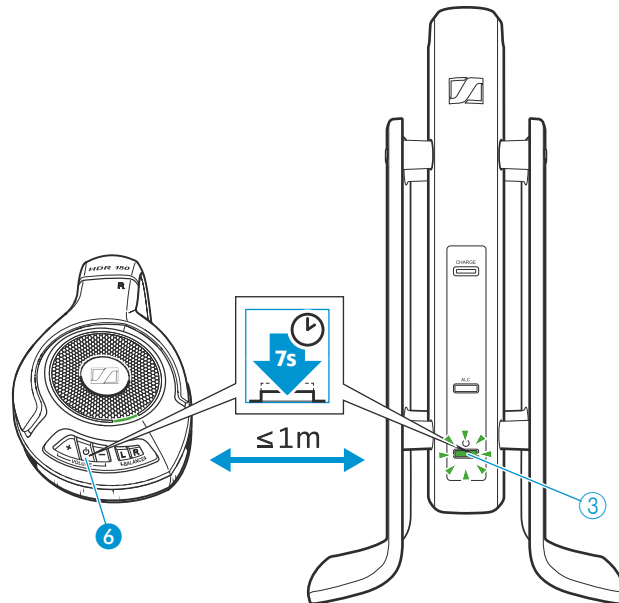

- ▶ Simultaneously press the multi-function button  ③ of the transmitter and the multi-function button  ⑥ of the headphones for 7 seconds.
The multi-function button  ③ of the transmitter flashes green.



- ▶ After approx. 30 seconds, the headphones are paired with the transmitter and you can hear your sound source via the headphones. The multi-function LED  ⑩ of the headphones and the multi-function button  ③ of the transmitter flash green.

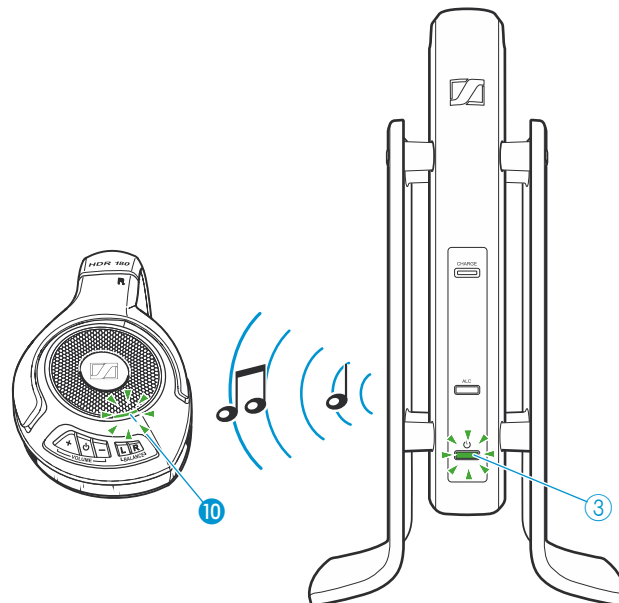



Associating other Klear compatible headphones to the transmitter

The following describes how to associate the Sennheiser MX W1 earphones to the TR 180 transmitter.

For information on how to associate other Klear compatible headphones to the transmitter, refer to the instruction manual of the corresponding product.

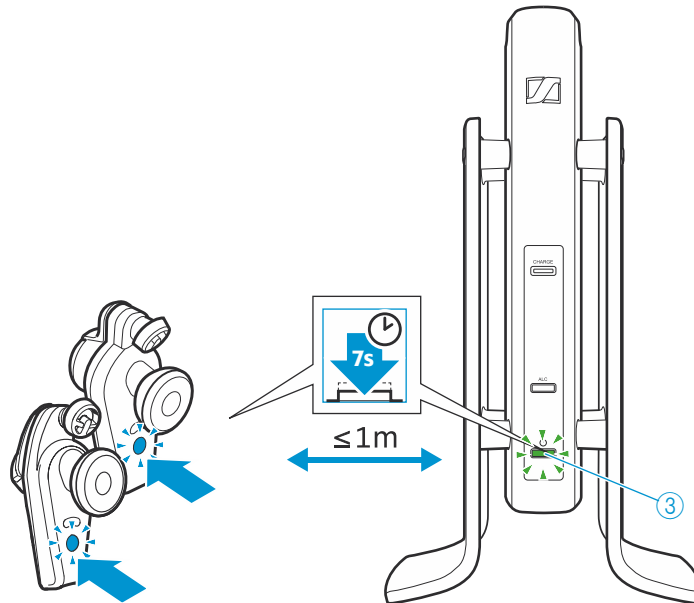
- ▶ Press the **operation/pairing** button on both MX W1 earphones for 7 seconds.
- ▶ Press the multi-function button  ③ of the transmitter for 7 seconds.



After approx. 30 seconds, the MX W1 earphones are paired with the transmitter and you can hear your sound source via the earphones. The multi-function button  ③ of the transmitter flashes green.

Associating several headphones to the transmitter

In order to be able to use several headphones simultaneously, you first have to associate your additional headphones to the transmitter.

- ▶ Follow the steps in the previous chapter "Associating the headphones to the transmitter".
You can then only use the last headphones paired to listen to your sound source (single-user operation).



To listen to your sound source with up to 4 headphones simultaneously:

- ▶ Set your transmitter to multi-user operation as described in the next chapter.

Listening with several headphones simultaneously

By default, the transmitter is set to single-user operation. In order to be able to listen to your sound source with several headphones simultaneously, you have to set your transmitter to multi-user operation.

The settings for the left/right volume adjustment is applied to the additional headphones. The volume of the each pair of headphones can be adjusted individually.

- ▶ Make sure that all headphones are paired to the transmitter (see previous chapter).
- ▶ Switch all headphones on (see page 21).
- ▶ Then switch the transmitter on (see page 19).
- ▶ Briefly press the multi-function button  ③ of the transmitter. The multi-function LEDs  ⑩ of the headphones flash green. You can now listen to your sound source with several headphones simultaneously.

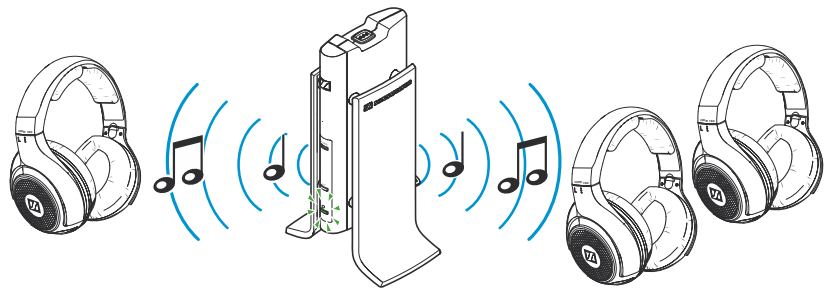

When pressing the transmitter's multi-function button  ③ in multi-user operation, the transmitter switches to single-user operation. You can still listen to your sound source with the last headphones paired, the other headphones are disconnected from the transmitter.

Cleaning the RS 180

CAUTION Liquids can damage the electronics of the product!

Liquids entering the housing of the product can cause a short-circuit and damage the electronics.

- ▶ Keep all liquids far away from the product.
 - ▶ Do not use any cleansing agents or solvents.
-

- ▶ Before cleaning, switch the product off and disconnect the transmitter from the mains.
- ▶ Only use a dry and soft cloth to clean the product.

Replacing the ear pads

For reasons of hygiene, you should replace the earpads from time to time. Spare earpads are available from your Sennheiser dealer (see "Accessoires and spare parts" on page 32).

- ▶ Remove the ear pads 3 from the ear cups by turning the ear pads in the direction of the arrow until you overcome a slight resistance.
- ▶ Lift the ear pads 3 off the ear cups.

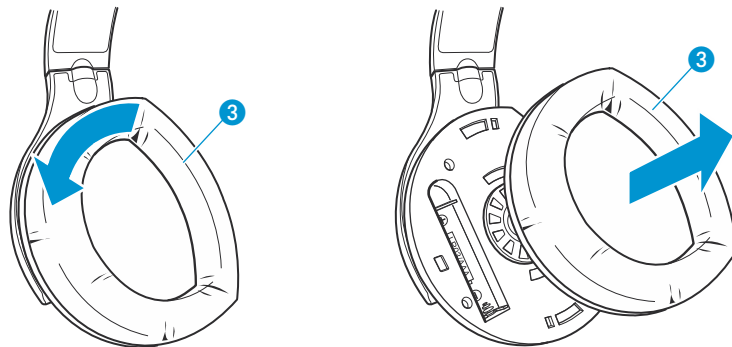

- ▶ Secure the new ear pads to the ear cups.

If a problem occurs ...

Sound problems

Problem	Possible cause	Possible solutions	Page
No sound	Transmitter is/headphones are switched off	Switch the transmitter/headphones on	19/21
	Headphones are muted	Cancel the muting	22
	Jack plug is not properly connected	Check the plug connection	12
	Sound source is switched off	Switch the sound source on	–
	Audio cable is defective	Replace the cable	–
	Transmission between transmitter and headphones is disturbed by interferences (including ESD) in the vicinity	Associate the headphones with the transmitter again	25
		Disconnect the transmitter from the mains and reconnect it again	16
		Remove the rechargeable batteries from the headphones and reinsert them again	17
Headphones are not correctly associated with the transmitter (e.g. additional headphones)	Associate the headphones with the transmitter	25	
Occasional sound dropouts	Headphones are out of range	Reduce the distance between headphones and transmitter	11
	Signal is shielded	Remove obstacles between transmitter and headphones	11
	Interfering devices in the vicinity	Change your position	11
Sound is too low	Volume of the sound source is adjusted too low	Increase the volume of the sound source	–
	Signal of the sound source is too weak	Set the ATTENUATOR switch ⑦ to "0 dB"	13
	Headphone volume is adjusted too low	Increase the volume by pressing the VOLUME + button ⑤	22
Sound only on one ear	Audio cable is defective	Replace the audio cable	–
	Audio cable is not properly connected	Check the plug connection	12

Problem	Possible cause	Possible solutions	Page
Sound is distorted	Signal of the sound source is distorted	Reduce the volume of the sound source	–
		Reduce the volume by pressing the VOLUME – button 7 on the headphones	22
	Signal of the sound source is too strong	Set the ATTENUATOR switch 7 to “–8 dB”	14

Other problems

Problem	Possible cause	Possible solution	Page
The transmitter cannot be switched on	No mains connection	Check the connection of the power supply unit to the transmitter and to the mains	16
Headphones cannot be switched on	Rechargeable batteries are flat	Recharge the rechargeable batteries	18
	Rechargeable batteries are inserted the wrong way round.	Remove the rechargeable batteries from the headphones and reinsert them again. Observe correct polarity	17
Headphones cannot be recharged	Headphones do not make contact to the charging contacts	Ensure that the headphones are properly seated on the charging contacts	18
		Clean the charging contacts	29
Operating time decreases	Rechargeable batteries are exhausted	Replace the rechargeable batteries	17

If a problem occurs that is not listed in the above table or if the problem cannot be solved with the proposed solutions, please contact your local Sennheiser partner for assistance.

To find a Sennheiser partner in your country, search at www.sennheiser.com.

Accessories and spare parts

Only use original Sennheiser accessories and spare parts, otherwise the product quality can be impaired or the product can be damaged.

Cat. No.	Accessory/spare part
504252	HDR 180 headphones
534480	Power supply unit with country adapters
534486	Stereo audio cable with two 3.5 mm jack plugs (2 m)
534479	DC cable (4.0 mm DC jack socket to 2 x 4.0 mm DC plug)
093778	Adapter (3.5 mm jack socket to ¼" (6.3 mm) jack plug)
514267	Adapter (3.5 mm jack socket to 2 RCA plugs)
534470	1 pair of ear pads (closed type)

Specifications

RS 180 system

Modulation	MSK digital
Carrier frequencies	2.4 – 2.48 GHz
Range	approx. 100 m in the open area
Ambient temperature	32 °F to 104 °F (0 °C to 40 °C)

TR 180 transmitter

Audio connection	3.5 mm stereo jack socket
Power consumption (standby mode)	< 0.5 W
Power supply	5 V $\overline{\text{DC}}$, 500 mA
Transmission power	< 10 mW
Weight	approx. 341 g
Dimensions	12.5 cm x 10 cm x 23 cm

HDR 180 headphones

Transducer principle	circumaural, open
Max. SPL	106 dB (SPL)
THD	< 0.5 % at 1 kHz, 100 dB SPL
Frequency response	18 Hz – 21,000 Hz
Charging time of rechargeable batteries	approx. 16 hours
Power supply	2 AAA size NiMH rechargeable batteries, 1.2 V, 600 mAh
Operating time	approx. 24 hours
Weight (w/o rechargeable batteries)	approx. 209 g

SSA-4P 5050F power supply unit

Rated input	100 – 240 V \sim , 0.2 A, 50 – 60 Hz
Rated output	5 V $\overline{\text{DC}}$, 500 mA
Operating temperature range	32 °F to 104 °F (0 °C to 40 °C)

Manufacturer declarations

Warranty

Sennheiser GmbH & Co. KG gives a warranty of 24 months on this product. For the current warranty conditions, please visit our website at www.sennheiser.com or contact your Sennheiser partner.

In compliance with the following requirements

- RoHS Directive (2002/95/EC)
- WEEE Directive (2002/96/EC)
- Battery Directive (2006/66/EC)

CE Declaration of Conformity

- R&TTE Directive (1999/5/EC)
- EMC Directive (2004/108/EC)
- Low Voltage Directive (2006/95/EC)

The declaration is available at www.sennheiser.com.

Before putting the product into operation, please observe the respective country-specific regulations!

Rechargeable batteries



The supplied rechargeable batteries can be recycled.

Please dispose of them as special waste or return them to your specialist dealer. In order to protect the environment, only dispose of exhausted batteries.

WEEE Declaration



Your Sennheiser product was developed and manufactured with high-quality materials and components which can be recycled and/or reused. This symbol indicates that electrical and electronic equipment must be disposed of separately from normal waste at the end of its operational lifetime.

Please dispose of this product by taking it to your local collection point or recycling centre for such equipment. This will help to protect the environment in which we all live.

Statements regarding FCC and Industry Canada

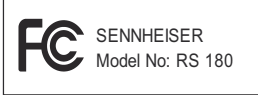
<p>FCC Declaration of Conformity (DoC)</p>	
	
<p>We,</p>	<p>Sennheiser Electronic Corporation Strat. Marketing • Stefanie Reichert One Enterprise Drive • Old Lyme • CT 06371 • USA Tel: +1 (860) 434 9190, ext. 144 Fax: +1 (860) 434 1759</p>
<p>declare the above device comply with the requirements of Federal Communications Commission.</p>	
<p>This device complies with Part 15 of the FCC rules. Operation is subjected to the following two conditions:</p>	
<p>1) This device may not cause harmful interference, and 2) This device must accept any interference received, including interference that may cause undesired operation.</p>	
<p>Responsible Party: John Falcone</p>	

This device complies with Part 15 of the FCC Rules and with RSS-210 of Industry Canada. Operation is subject to the following two conditions: (1) this device may not cause harmful interference, and (2) this device must accept any interference received, including interference that may cause undesired operation.

This equipment has been tested and found to comply with the limits for a Class B digital device, pursuant to Part 15 of the FCC Rules. These limits are designed to provide reasonable protection against harmful interference in a residential installation. This equipment generates, uses and can radiate radio frequency energy and, if not installed and used in accordance with the instructions, may cause harmful interference to radio communications. However, there is no guarantee that interference will not occur in a particular installation. If this equipment does cause harmful interference to radio or television reception, which can be determined by turning the equipment off and on, the user is encouraged to try to correct the interference by one or more of the following measures:

- Reorient or relocate the receiving antenna.
- Increase the separation between the equipment and receiver.
- Connect the equipment into an outlet on a circuit different from that to which the receiver is connected.
- Consult the dealer or an experienced radio/TV technician for help.





This class B digital apparatus complies with the Canadian ICES-003.

Changes or modifications made to this equipment not expressly approved by Sennheiser electronic Corp. may void the FCC authorization to operate this equipment.

RF Radiation Exposure Information

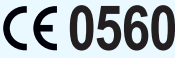
Since the radiated output power of this device is far below the FCC radio frequency exposure limits, it is not subjected to routine RF exposure evaluation as per Section 2.1093 of the FCC rules.

In compliance with:

USA	FCC ID: DMOTR180 FCC ID: DMOHDR180	
Canada	IC: 2099A-TR180 IC: 2099A-HDR180	
Europe		 
Australia/ New Zealand		
Singapore	Complies with IDA Standards DB100582	

Trademarks



The Kleer logo is a trademark of Kleer Inc.

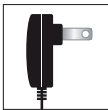

Powered by an
ENERGY STAR®
qualified adapter
for a better
environment

About ENERGY STAR

ENERGY STAR is a joint program of the U.S. Environmental Protection Agency and the U.S. Department of Energy helping us all save money and protect the environment.



Sennheiser electronic GmbH & Co. KG
Am Labor 1, 30900 Wedemark, Germany
www.sennheiser.com

Publ. 08/09
A01

Free Manuals Download Website

<http://myh66.com>

<http://usermanuals.us>

<http://www.somanuals.com>

<http://www.4manuals.cc>

<http://www.manual-lib.com>

<http://www.404manual.com>

<http://www.luxmanual.com>

<http://aubethermostatmanual.com>

Golf course search by state

<http://golfingnear.com>

Email search by domain

<http://emailbydomain.com>

Auto manuals search

<http://auto.somanuals.com>

TV manuals search

<http://tv.somanuals.com>