

Rinnai

Installation and User Manual

Infinity 24e

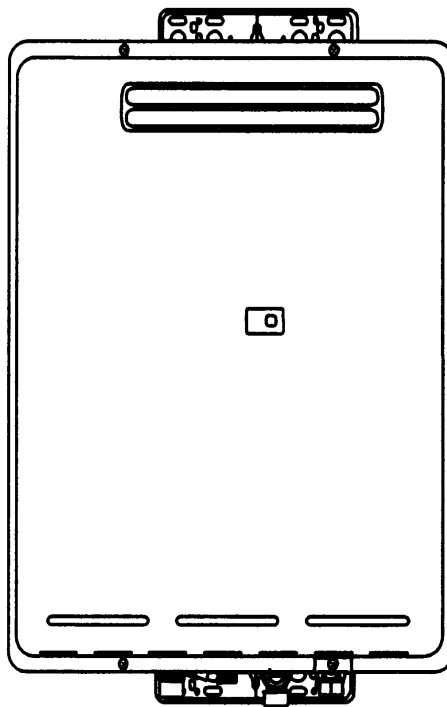

Continuous Flow Water Heater

Important.

Read these instructions carefully before attempting installation or use of this appliance. All work must be carried out by competent persons.

RINNAI UK WARRANTY

As the purchaser of this high quality Rinnai Water Heater you are provided with the following conditional guarantee.

	Heat Exchanger		All Other Parts	
	Parts	Labour	Parts	Labour
Standard Use	3 Years	1 Year	3 Years	1 Year
24e				
Commercial Use	1 Year	1 Year	1 Year	1 Year
24e				

Definition of Standard Use.

The warranty period allocated under Standard Use is based on Domestic and Light Commercial hot water usage. Rinnai Standard Use warranty periods apply only where Rinnai water heaters are installed in domestic and light commercial situations at operating temperatures below 65°C and do not include installations incorporating storage cylinders or building flow and return systems.

The warranty shall apply to any Rinnai water heater from the Infinity range used in this way.

Definition of Commercial Use.

The warranty period allocated under Commercial Use are for Infinity water heaters installed at premises such as commercial and industrial buildings, cafes, caravan parks, and sporting complexes. Commercial Use warranty applies to:

- Water heaters supplying a central shower block
- Water heaters supplying kitchens used for the bulk preparation of food.
- Water heaters set to 65°C or higher.
- Water heaters used in commercial or industrial processes.
- Any application that uses Rinnai water heaters in conjunction with storage tanks
- Any application that uses Rinnai water heaters in conjunction with a flow / return system.
- Water heaters installed as components of centralised bulk hot water systems.

Rinnai Infinity units used in Commercial Situations are only subject to a 1 year warranty across the board. Commercial situations should be supplied by the Rinnai HD range.

No Rinnai warranty will cover faults arising from improper installation or gas supply, water contaminants beyond defined limits, environmental factors, plumbing fittings, or other outside influences of which Rinnai is not responsible. Service calls for these issues will be chargeable.

Description	pH	Total Dissolved Solids (TDS)	Total Hardness	Chlorides	Magnesium	Calcium	Sodium	Iron
Maximum Recommended Levels	6.5 - 9.0	600 mg/litre	200 mg/litre	300 mg/litre	10 mg/litre	20 mg/litre	150 mg/litre	1 mg/litre

CONTENTS

Rinnai UK Warranty.....	2
Unpacking Rinnai Water Heater.....	4
Installation Instructions.....	5
Flue Requirements.....	8
Dimensions.....	9
Technical Details.....	10
Features and Benefits.....	11
Important Information.....	12
Operation without Remotes.....	14
Temperature Controls.....	15
Testing.....	25
Gas Pressure Setting.....	26
Dip Switch Setting.....	28
Error Messages.....	30
Restarting the Rinnai Water Heater.....	32
Wiring Diagram.....	33
Diagnostic Points.....	34
Specification.....	35
Service Contact.....	36
Commissioning Check List.....	36

UNPACKING RINNAI WATER HEATER

- After unpacking the appliance check for damage, if the heater is damaged contact your supplier immediately. Do not install a damaged appliance before checking with your supplier.
- One remote control and heater accessories pack are inside the carton.
- Check that the appliance supplied is the correct gas type for the installation. Refer to the data plate located on the left-hand side of the appliance.
- Remove the heater and the accessories from the carton, and check that all the parts are included . The remote control cable is provided with spade connectors.

Remote Control Parts

Quantity	Diagram	Description
1		Temperature controller MC-91-1A
1		Cable clamp
1		Cable Clamp
5		Spade connectors
1		Control cable 20 metres
1		Clamp screw

Unit Mounting Fasteners

Quantity	Diagram	Description
5		Screw
5		Screw

INSTALLATION INSTRUCTIONS

IMPORTANT INFORMATION

1. **Gas safety (Installation & Use) regulations 1998** are the 'Rules in force'. In your own interest and that of safety, it is law that all gas appliances are installed by competent persons in accordance with the above regulations. Failure to install appliances correctly could lead to prosecution. Other persons should NOT attempt to install this equipment.
2. Unpack the appliance and check it carefully. If it appears to have any defects or damage DO NOT INSTALL, contact your supplier.
3. This appliance is for normal hot water supply only and should not be used as pool or spa water heater.
4. The heater must be installed in the vertical position with the gas and water connections on the underside pointing vertically downward.
5. Installation must be carried out in accordance with the current issue of the following:

Building regulations issued by the Department of the Environment and Building Standards (Scotland) Regulations.

I.E.E. Wiring regulations for electrical installations.

Gas safety (Installation and Use) Regulations current issue.

BS 5546

BS 5440

BS 6891

BS 5482

BS 6700

Local byelaws

Water regulations

Health and safety at work etc. Act 1974

Such other specifications and regulations that may supersede or complement the above documents.

Please be sure that you are fully aware of your obligations and responsibilities under these regulations.

INSTALLATION INSTRUCTIONS - POSITIONING

General Installation Information.

External Installations.

The Rinnai Infinity 24e is for external mounting only.

The unit is classed as a Category A3 flueless appliance as described by CEN CR1749. Although BS 5440 does not relate directly to heaters in this category the rules must be followed when positioning the appliance, especially with regard to other appliances, openings, and boundaries. Figure C.1 from BS5440-1:2000 is provided for your guidance.

The appliance must be mounted on a vertical wall or structure with the water and the gas connections on the underside pointing towards the ground.

THIS APPLIANCE MUST NOT BE USED AS A DOMESTIC SPA OR SWIMMING POOL HEATER.

Appliance Location.

The appliance should be placed as close as practicable to the most frequently used hot water outlet point or points to minimise the delay time for hot water delivery. For installations where the distance between the unit and hot water outlet points is considerable, the appliance can also be fitted in a 'flow and return system' which minimises the waiting time for hot water delivery. Alternatively, multiple appliances can be strategically placed to service outlet points with minimal delay time. Contact Rinnai for further information.

Location of the appliance flue terminal must be in accordance with the clearances shown on page 8. Ensure that the flue terminal and hot water outlet connection cannot be touched by children. The appliance must be clear of obstructions and shrubbery.

The wall or structure on which it is mounted must be capable of supporting the weight of the appliance (18 kg) and associated pipework. Ensure that suitable screws or bolts are used to secure the water heater to the wall. Bracket and fixing hole locations are shown on page 9. The top bracket has a keyhole slot so that the appliance can be hung on one screw, and then the other fixings can be added to secure the unit.

The appliance must be in an accessible location. Sufficient clearances shall allow access to, and removal of, all serviceable components. The appliance should not be mounted higher than 3.5 metres from the ground or floor level unless the customer can arrange permanent and safe access or can arrange another means of access, for example, by means of scissor or boom lifts.

Multiple heater installations can be installed with the heaters manifolded together.

The heater draws combustion air through the casing for the external model.

Heater guards and pipe cover boxes for security and safety are available from Rinnai.

INSTALLATION INSTRUCTIONS - CONNECTIONS

Water Supply.

Where the water supply pressure exceeds 12 bar, an approved pressure reducing device is required at the inlet of the appliance. To achieve the rated flow a minimum water supply pressure of 1.4 bar is required at the appliance inlet. The unit will operate at lower supply pressures but the rated flow will not be achieved. Contact Rinnai for 'gravity fed' or 'low pressure' hot water installations.

Water pipe sizing and layout should be designed correctly to ensure the given water flows from the Rinnai Infinity are available. All hot water pipework should be insulated to optimise maximum performance and energy efficiency.

Water Connection.

Connect the hot and cold water supply pipes. An approved isolation valve and strainer **MUST** be installed in the cold water inlet pipe. An approved isolation valve should be installed in the hot water outlet pipe. There must be a union or release fitting on the heater side of the isolation valves. A non return valve is not required unless dictated by local regulations. A pressure relief valve should be installed in the pipework to discharge safely into a suitable drain when the system has a flow and return, or tank.

Positions of the cold water inlet, hot water outlet and gas connections are shown on page 9. All connections are $\frac{3}{4}$ inch BSP. This is **NOT** an indication of the pipe sizes required.

If the heater is in a hard water area a suitable water conditioning device should be installed to prevent the build up of limescale within the heat exchanger. Heat exchangers damaged by scaling are not covered by the manufacturers guarantee. Guidelines are given below. If the local water exceeds these values the heater must be protected.

Description	pH	Total Dissolved Solids (TDS)	Total Hardness	Chlorides	Magnesium	Calcium	Sodium	Iron
Maximum Recommended Levels	6.5 - 9.0	600 mg/litre	200 mg/litre	300 mg/litre	10 mg/litre	20 mg/litre	150 mg/litre	1 mg/litre

Gas Connection

Check pipe sizing required for the heater input. The heat input for the Infinity 24e is 52 kW. Refer to BS6891 (Natural Gas) and BS5482 (Propane) for guidance on correct pipe sizing calculation.

Check that the size of the gas meter and pipework will be sufficient for all appliances on the main. Sufficient gas must be available at the appliance if correct operation is to be expected. An approved gas isolation valve must be fitted at the gas inlet. A union or release fitting should be installed after the isolation valve.

Electrical Connection.

The appliance must be earthed. The appliance is suitable for 230VAC – 50hz mains only and all wiring must be carried out to the I.E.E regulations latest edition. The heater electrical supply must be provided with a fused (3A) local isolator with a contact separation of 3mm minimum on all poles for servicing. Observe polarity and ensure that wiring is correctly restrained.

FLUE REQUIREMENTS - POSITIONING

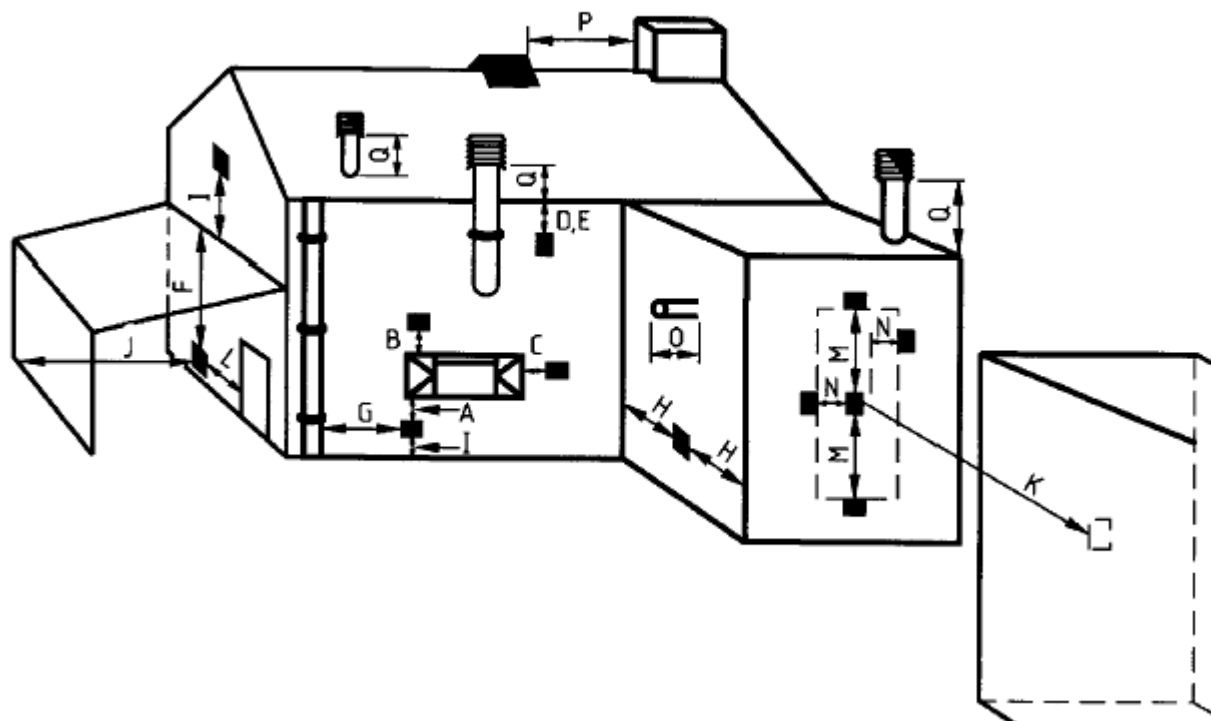

Dimension	Terminal Position	Distance
A	Directly below an opening, air brick, opening windows, etc.	300mm
B	Above an opening, air brick , opening window, etc.	300mm
C	Horizontally to an opening, air brick , opening window, etc.	300mm
D	Below gutters, soil pipes or drain pipes.	75mm
E	Below eaves.	200mm
F	Below balconies or car port roof.	200mm
G	From a vertical drain pipe or soil pipe.	150mm
H	From an internal or external corner.	200mm
I	Above ground, roof or balcony level.	300mm
J	From a surface facing the terminal.	600mm
K	From a terminal facing a terminal	1200mm
L	From an opening in a car port. (e.g. door, window) into a dwelling	1200mm
M	Vertically from a terminal on the same wall.	1500mm
N	Horizontally from a terminal on the same wall.	300mm
O	From the wall on which the terminal is mounted	N/A
P	From a vertical structure on the roof.	N/A
Q	Above an intersection with roof.	N/A

DIMENSIONS

	A
Gas	41
Cold Water	51
Hot Water	42
Power	27

Note: All dimensions are in mm.

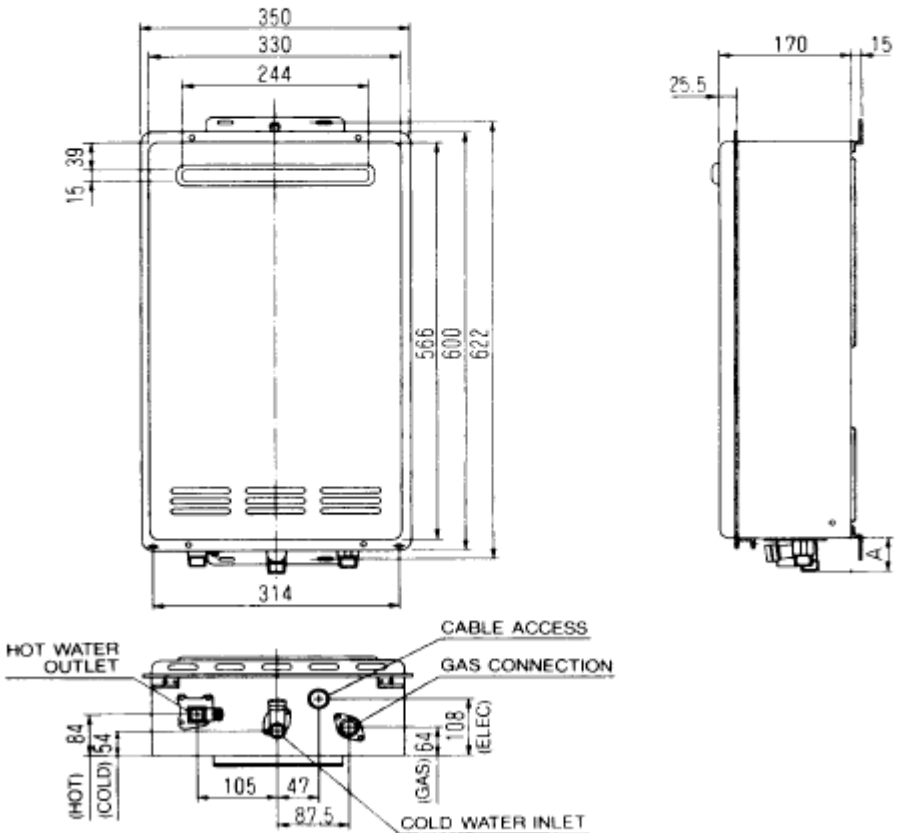

TECHNICAL DETAILS

Infinity Model	Infinity 24e		Units
Installation	External		
Nat Gas Press Low	0.8		mbar
Nat Gas Press High	9.0		mbar
LPG Press Low	1.7		mbar
LPG Press High	22.6		mbar
Height	600		mm
Width	350		mm
Depth	170		mm
Weight	18		kg
Flue System	Forced Exhaust		
Temp. Range Controllers	37 - 75		deg C
Temp. Range without Controllers	37,40,43,50,55*,65,75		deg C
Ignition	Direct Electronic Ignition		
Gas Consumption Low			
Nat Gas	5.8		kW
LPG	5.8		kW
Gas consumption High			
Nat Gas	52		kW
LPG	52		kW
Max Flow raised 33C	18		L/min
Min Operation Flow	2.7**		L/min
Water Pressure Nom.	1.4 - 10		bar
Power Supply	230 V / 50 Hz		
Elec. Consumption Standby (with 1 remote connected)	6		Watts
Elec. Consumption Run	55		Watts
Elec. Consumption Anti-frost Heaters On	100		Watts

* Factory Setting

**Minimum operation flow based on temperature setpoint and inlet conditions.

FEATURES AND BENEFITS

Congratulations on purchasing the Technologically Advanced, Temperature Controlled, Rinnai Hot Water System.

- The Rinnai **Infinity 24e NEVER RUNS OUT** of hot water. As long as electricity, water, and gas supplies are connected, hot water is available when hot water taps are open.
- Built into the main micro-processor is the facility to **LIMIT THE MAXIMUM TEMPERATURE** of the hot water supplied. The water temperature may be limited to various maximum temperatures. This is particularly useful when the hot water unit is installed where young children or the infirm may be using the hot water. The Infinity 24e is delivered with a preset temperature of 55°C. If required, the temperature limits can be changed by an authorised person. For further information, please contact Rinnai.
- The Rinnai Infinity external unit is a powered flue appliance. This makes it **COMPACT**, saving both floor and wall space.
- The temperature of outgoing hot water is **CONSTANTLY MONITORED** by a **BUILT-IN SENSOR**. If the temperature of the outgoing hot water rises to more than 3°C above the selected temperature the burner is shut OFF and only turned ON again when the temperature falls to below the selected temperature.
- The burner lights automatically when the hot water tap is opened, and distinguishes when the tap is closed. **IGNITION IS ELECTRONIC**, so there is no pilot light. When the hot water tap is off, no gas is used.
- Up to three temperature controllers can be mounted remotely from the heater. This offers the following additional features:
 - Localised temperature setting.
 - Diagnostic message.
- 'Deluxe' Temperature Controllers are an optional extra. These provide functions including Bath Fill, Voice Prompt, and Clock Setting.
- Temperatures selected at the controllers are retained in the **SYSTEM MEMORY**.
- Operating **NOISE LEVEL IS VERY LOW**.
- **ERROR MESSAGES ARE DISPLAYED** on the Temperature Controllers, assisting with service.
- **FROST PROTECTION** device built in as standard.

IMPORTANT INFORMATION

Excessively hot water is dangerous, especially for young children and the infirm. The water heater allows you to control the temperature of your hot water to safe levels.



Water temperature over 50°C can cause severe burns instantly or even death from scalding.

Children, disabled and the elderly are at the highest risk of being scalded by excessively hot water.

Always test the temperature of the water before bathing or showering.

Burns from hot water taps can result in very severe injuries to young children.

Hot water at 65°C can severely burn a child in less than half a second. At 50°C it takes five minutes.

Burns can occur when children are exposed directly to hot water or when they are placed into a bath which is too hot.

DO

Do stay with children whenever they are in the bathroom.

Do take them out of the bathroom if you need to answer the phone or door.

Do test the temperature of the water with your elbow before placing your child in the bath.

Do make sure that the tap is turned off tightly.

Do consider setting your Rinnai Infinity 16e at a maximum temperature of 50°C.

Do install a child proof tap cover

OR,

Do install a child resistant tap.

DO NOT

Do not leave a toddler in the care of another small child. The older child may not have safely set the temperature.

- **Consider child—resistant taps or inexpensive tap covers,** both of which prevent a child's hand from turning on the tap.
- **Consider reducing the temperature of the water supplied to the hot tap to 50°C.**

This approach can be extremely valuable because it requires a one time action for a long term reduction in risks of scalds.

This type of automatic protection is important during times when a parent or carer has been distracted.

IMPORTANT INFORMATION

Always check water temperature before use.

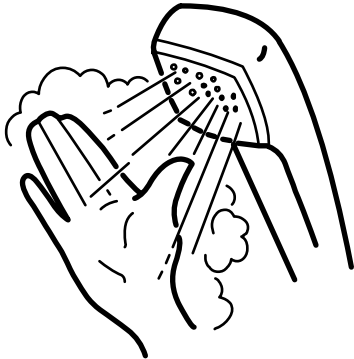

Refer to warning about hot water on page 12 for important safety information.

Hot water may go out without warning at low water flows.

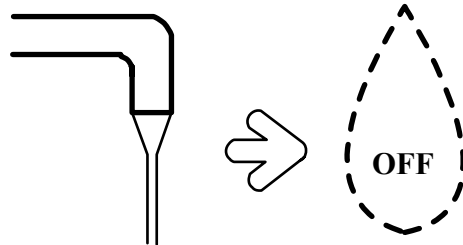

The **Infinity 24e** controls the water temperature automatically. For high temperatures it may reduce the flow. The water from the hot tap may be reduced after the temperature shown on the remote control is raised. The water flow may also vary with the temperature of the incoming water supply.

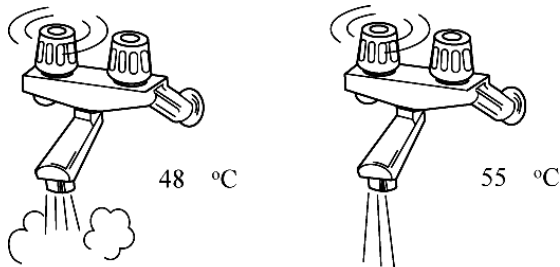

If freezing temperatures are expected, turn off the water and gas, and drain the water heater.

1. Water Off
2. Gas Off
3. Drain Water

If the power is left on the Automatic Frost Protection will prevent the unit from Freezing. Frost protection is standard on the external units.

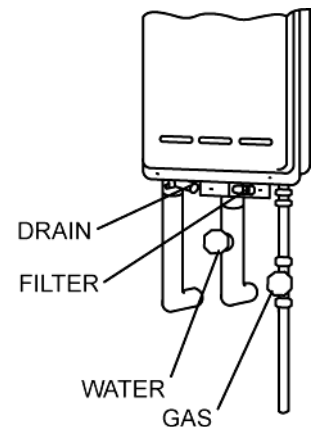

Keep flammable materials, trees, shrubs, chemicals etc. away from the heater.



Do not touch the unit cover or the flue outlet. Do not insert objects into the flue outlet.

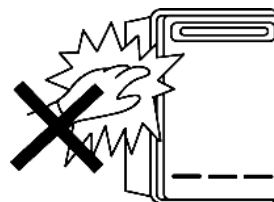

On cold days steam may be discharged from the flue outlet. This is normal, do not be alarmed. It does not indicate a fault.

OPERATION WITHOUT REMOTES

Rinnai Infinity products have no pilot light and when installed without Temperature Controllers, the appliance will operate automatically as soon as a hot water tap is opened.

The burner ignites with electronic ignition and the flame extinguishes as soon as water flowing through the appliance stops.

Turn On by opening the hot water tap

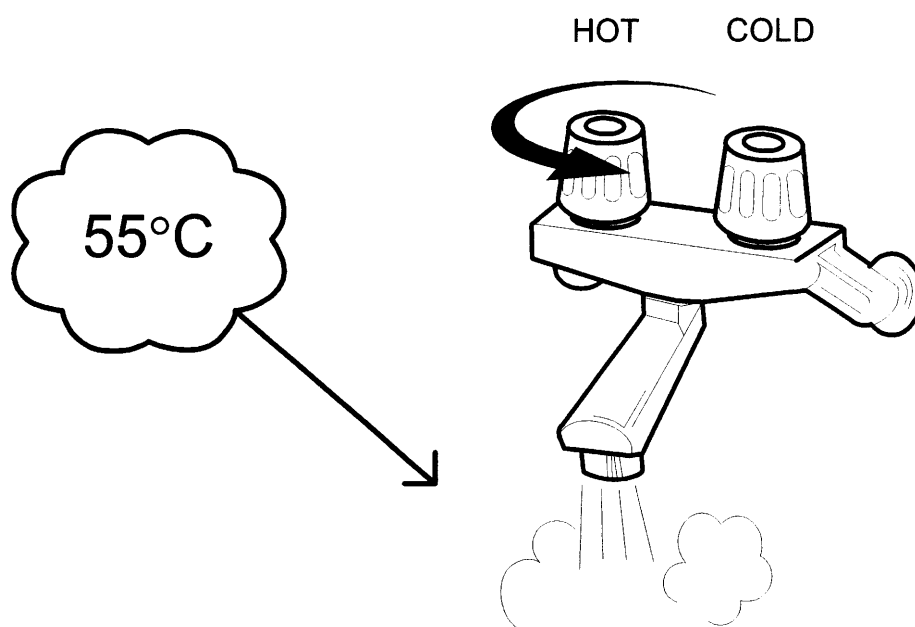

Rinnai Infinity water heaters without controllers are factory pre-set to a temperature limit of 55°C. Other limits, lower or higher, are available on request for the Infinity range. Temperature controllers are available that allow precise digital temperature control. Higher temperatures may be necessary for circulation loop systems.

Controllers can be easily added at any time after installation.

TEMPERATURE CONTROLS - GENERAL

When deciding on the best position for the temperature controls, the following points should be taken into account.

- Fit the controls out of reach of children (suggested height from the floor 1.5m.)
- Avoid positions where the controllers will become hot. Do not fit them near stoves or ovens, or above radiators or heaters.
- If possible, avoid exposure to direct sunlight or positions where bright lights will make the digital display difficult to read.
- Position away from areas where the controller will be prone to splashing by cooking products such as oils and fats.
- The temperature controllers are water resistant, however they should be positioned away from areas where direct or persistent splashing could occur.
- Refer to the I.E.E electrical wiring regulations current edition for location requirements in shower and bath areas.
- The cables to the temperature controller carry only 12VDC (extra low voltage.)
- When using more than one temperature controller the signal cable should be run in parallel. That is, from controller to controller to heater, or from each controller to the heater. Do not wire the controllers in series.

The installation in every application will vary, therefore the temperature controller cable has been provided so that you may cut the length accordingly and fit the spade connectors, ensuring a good connection.

Cables are simply 'piggy-backed' at the water heater or at the primary temperature controller. Polarity is not important when connecting the cables, either colour wire can be connected to either terminal at both the heater or primary temperature controller. If more cable is needed any cable with similar specification to the cable supplied with the controller can be used. Maximum length is 50 metres.

TEMPERATURE CONTROLS - INSTALLATION

Universal Temperature Controller MC-91-1A

1. Determine the most suitable position for the temperature controller.
2. Drill 3 holes in the wall as shown in fig. 1, one for the cable and two for the securing screws. Ensure holes are drilled deep enough. Fit wall plugs if needed. (ensure controller is level.)
3. Run the cable provided through the hole in the wall ensuring that the end fitted with the connector is nearest the controller. (fig. 2.)
4. Remove the face plate from the controller using a flat screwdriver. Take care not to damage the cover (fig. 3.)
5. Connect the cable to the temperature controller.
6. Fix the controller to the wall and fasten with the phillips head screws supplied as shown in (fig. 4.)
7. Remove the protective plastic film from the controller face as shown in fig. 4.
8. Replace the face plate.

Outline of Remote Control

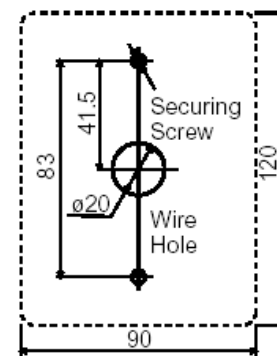

fig.1

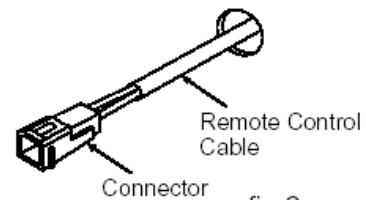

fig.2

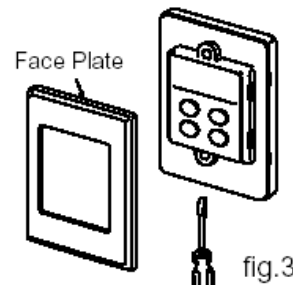

fig.3

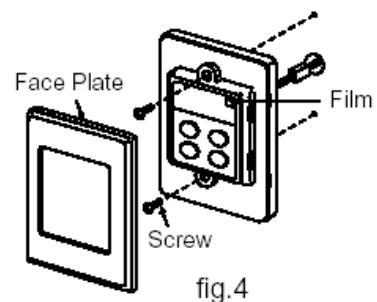

fig.4

TEMPERATURE CONTROLS - INSTALLATION

Connecting One or Two Controllers

1. Isolate the power supply.
2. Remove the front cover from the Appliance (4 screws) fig. 1.
3. Thread the cable through the cable access hole at the base of the appliance.
4. Connect the spade connectors to the terminals marked "Remote Control" on the printed circuit board (fig.2). Polarity is not important. Either wire colour can be connected to either terminal.
5. Replace cover of the Appliance. Ensure that the special earth screw is placed at the bottom right hand corner for earthing purposes.

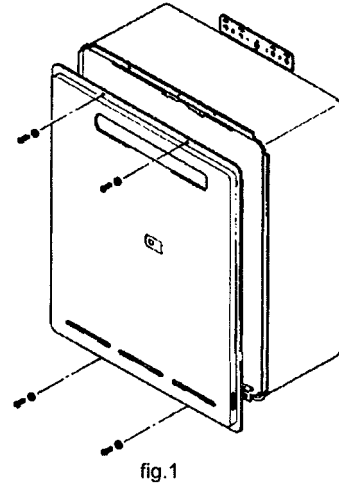

fig.1

Connecting Three Controllers

1. Isolate the power supply.
2. Remove the front cover from the Appliance (4 screws) fig.1.
3. Thread the cables through the cable access hole at the base of the appliance.
4. Cut the spade connectors from two controller cables (4 connectors should be cut off) and discard. Connect the wires and terminate into two new spade connectors as shown in fig. 3.
5. Thread the 3 cables through the cable access hole at the base of the appliance. Connect the 4 spade connectors to the terminals marked "Remote Control" on the printed circuit board (fig.2). Polarity is not important. Either wire colour can be connected to either terminal.
6. Replace cover of the Appliance. Ensure that the special earth screw is placed at the bottom right hand corner for earthing purposes.

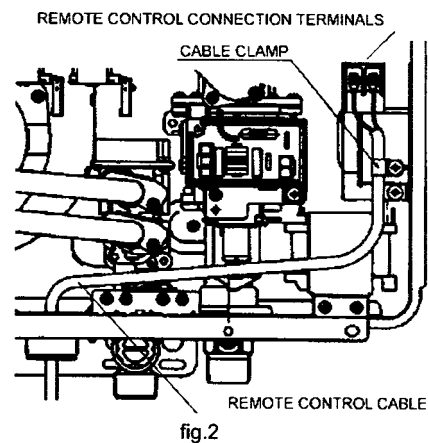

fig.2

Connecting Four Controllers

1. Isolate the power supply.
2. Remove the front cover from the Appliance (4 screws) fig.1.
3. Cut the spade connectors from all four controller cables to be connected to the appliance (8 connectors should be cut off) and discard. Connect the wires from two remotes and terminate into two new spade connectors as shown in fig. 3.
4. Repeat for remaining two remotes.
5. Thread the 4 cables through the cable access hole at the base of the appliance. Connect the 4 spade connectors to the terminals marked "Remote Control" on the printed circuit board (fig.2). Polarity is not important. Either wire colour can be connected to either terminal.
5. Replace cover of the Appliance. Ensure that the special earth screw is placed at the bottom right hand corner for earthing purposes.

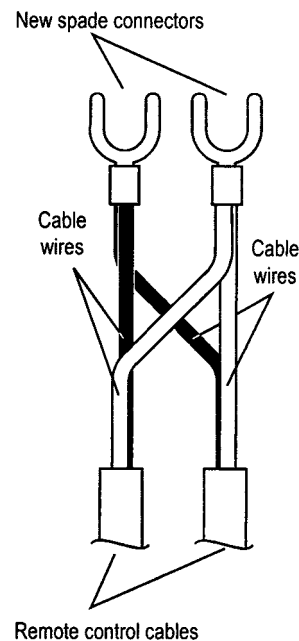

fig. 3

TEMPERATURE CONTROLS

The purpose of a Temperature Controller is to enable the user to have complete control over the hot water supply. Used correctly, the hot water unit will supply hot water at the temperature selected, even when the water flow is varied, or when more than one tap is used. Adjustments to the operation of your hot water unit can be made with any of the Temperature Controllers. Each Temperature Controller can be individually programmed.

Up to four Universal and Deluxe Temperature Controllers can be fitted with the Infinity 24e. Universal Controllers allow temperature selection only and come as standard with the water heaters. Deluxe Temperature Controllers are an optional extra. These controllers have temperature selection, bath fill, voice recognition, and time clock functions. When more than one Universal Controller is used one may be set as the Master Controller to allow higher temperatures.

Various water temperatures (°C) can be selected as follows:

Universal Controller:

37, 38, 39, 40, 41, 42, 43, 44, 45, 46, 48, 50°C

Master Universal Controller:

37, 38, 39, 40, 41, 42, 43, 44, 45, 46, 48, 50, 55, 60, 65°C

Deluxe Bathroom Controller:

Hot Water Delivery: 37, 38, 39, 40, 41, 42, 43, 44, 45, 46, 48, 50°C

Bath fill Delivery: 37, 38, 39, 40, 41, 42, 43, 44, 45, 46, 47, 48°C

Deluxe Kitchen Controller:

37, 38, 39, 40, 41, 42, 43, 44, 45, 46, 48, 50, 55, 60, 65°C

If a temperature 43°C or higher is selected on any controller and this temperature is then decreased to below 43°C and increased again whilst the water is running, the maximum selectable temperature will become 43°C. This provides additional safety for the consumer.

Suggested temperatures are:

Kitchen 50°C - 65°C*; Shower 39°C - 43°C; Bath fill 39°C - 45°C

** This temperature may not be available on all installations.*

These temperatures are suggested starting points for selection. You may find higher or lower temperatures are more comfortable. Maintaining lower temperatures helps to save energy. To obtain water temperatures lower than 37°C simply add cold water.

Up to four controllers can be used for one Infinity 24e. When multiple temperature controllers are used they allow the temperature to be set from various locations by pushing the transfer button which gives that controller priority over the system. The temperature selected by the controller with priority will be available to all outlets.

TEMPERATURE CONTROLS - OPERATING

Remote temperature controllers are a feature that provides control over the water temperature. Rinnai Infinity water heaters can be operated with 1, 2, 3, 4 or no temperature controllers. The Universal controller MC-91-1A comes as standard with all Infinity water heaters.

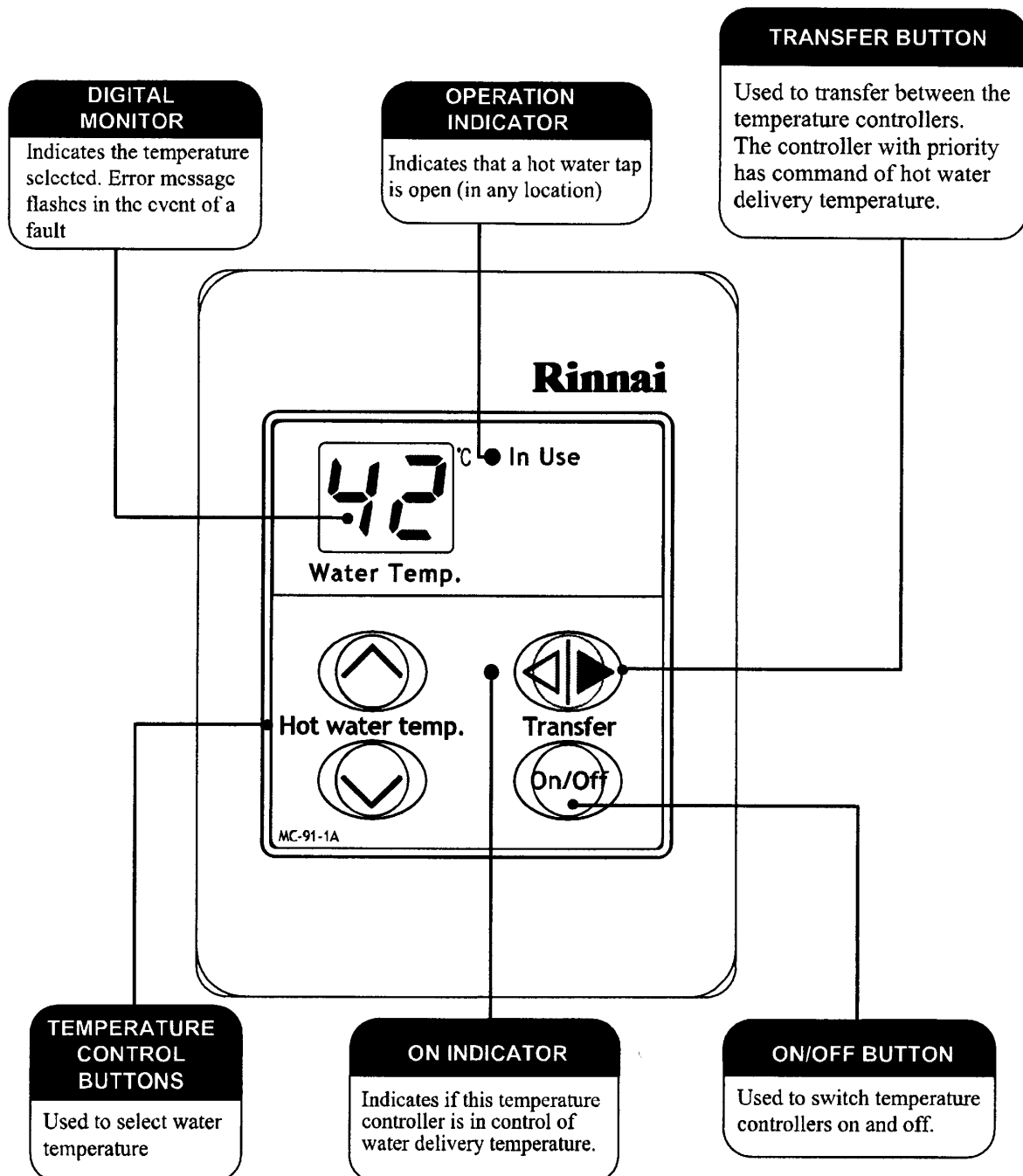

NOTE:

Each time a button is pressed, a BEEP will sound.

The BEEP sound can be muted by depressing the Temperature Controller Up and Down buttons simultaneously for more than 3 seconds.

This can be done for each Temperature Controller.

To return to original settings, repeat this step.

TEMPERATURE CONTROLS - OPERATING

Using 1 Universal Temperature Controller.

Press the **On/Off** button on the temperature controller.

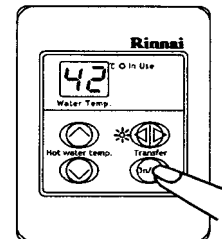

The ON indicator will glow on the Temperature Controller. This indicates that the heater is ready to supply hot water when a tap is opened.

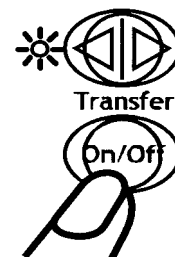

Adjusting Temperature

Simply press the Hot Water Temperature Up or Down arrow button until the desired temperature is displayed on the digital display.

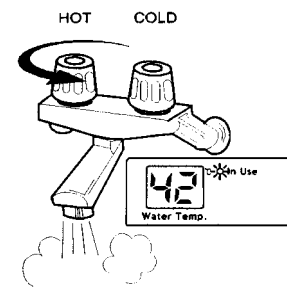

To operate the heater, simply turn any hot water tap on. This will automatically light the burner providing hot water. The red **In Use** indicator will glow on the temperature controller.

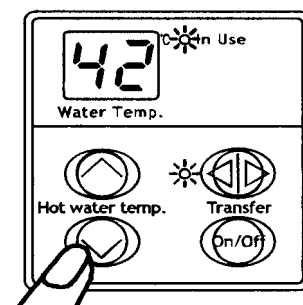

Caution: Always check water temperature before use.

Note: With the hot water tap open and a temperature of 43°C or higher selected, if the temperature is decreased below 43°C, and then raised again the maximum available temperature will be 43°C. For safety reasons temperature 'priority' cannot be transferred between controllers when a hot water tap is open.

TEMPERATURE CONTROLS - OPERATING

Using 2 or more Universal Temperature Controllers.

Switching the system ON.

The hot water system and all controllers can be switched ON and OFF from any controller by pressing the **On/Off** button as shown. When the system is turned ON the water temperature display will be lit.

During normal operation the system is left ON. Do not push the **On/Off** button when water is running.

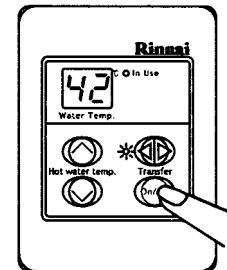

Using hot water.

Ensure the system is switched **On** by verifying the temperature display is lit. Ensure the controller has priority by verifying the **Transfer** LED indicator is lit. If it is not then press the **Transfer** button once. This gives the local controller priority of temperature over the system.

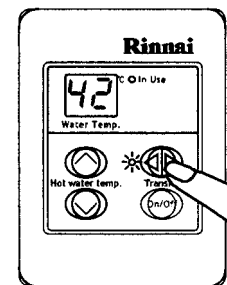

Select the desired temperature using the **Hot water temp.** buttons. The selected temperature will be displayed on all controller displays. This is the water temperature which will be supplied from the heater.

Bathroom temperatures should be no more than 50°C.

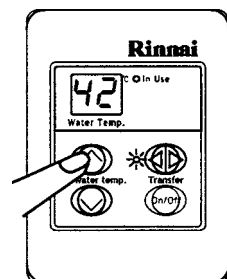

Open the hot water tap. The appliance will be activated and the **In Use** indicator will be lit.

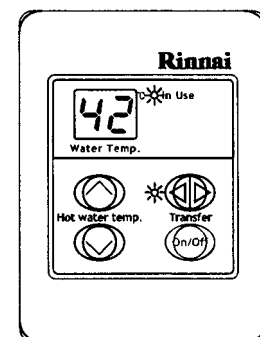

TEMPERATURE CONTROLS - OPERATING

Using 4 Universal Temperature Controllers.

You will need to activate the fourth controller.

STEP 1: On the Master controller press and hold the **Transfer** and **On/Off** buttons simultaneously (see fig 2.) until a “beep” is heard (approx. 5 seconds)

STEP 2: Check that the display on all Four controllers is lit and displaying a temperature when switched on. If any ONE of the controllers displays two dashes (see fig 1.) in the display repeat STEP 1.

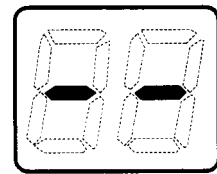

Fig 1.

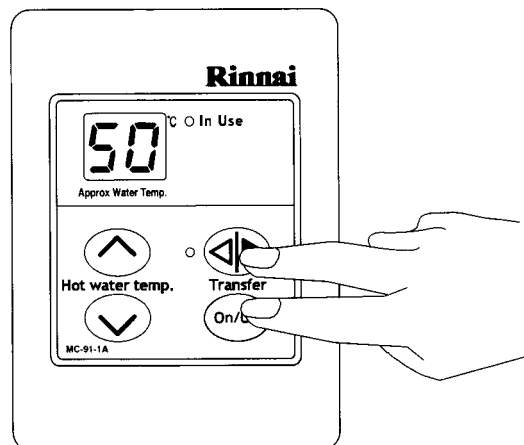

Fig 2.

Note:

If the master controller is replaced, repeat STEP 1 above for the new controller.

TEMPERATURE CONTROLS - OPERATING

Using High Temperature Display Controllers.

You will need to program the Master controller if you want to display and use temperatures over 50°C. Programming only needs to be done on Master universal controllers; other universal controllers will not allow this, and Deluxe Kitchen Controllers are supplied already programmed to allow high temperatures. Temperatures in bathrooms should never exceed 50°C.

STEP 1: On the Master controller only press and hold the **Transfer** and **On/Off** buttons simultaneously (see fig 2.) until a “beep” is heard (approx. 5 seconds)

STEP 2: When the Primary controller is switched on it should be possible to select temperatures higher than 50°C. If not repeat STEP 1.

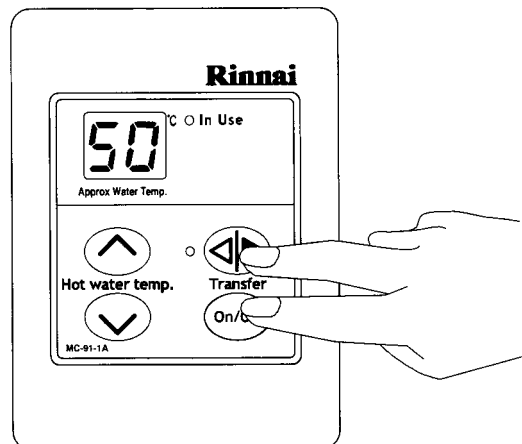

Fig 2.

Note:

If the master controller is replaced, repeat STEP 1 above for the new controller.

TEMPERATURE CONTROLS - OPERATING

To turn off your hot water system.

During normal operation the system is left on.

To turn the system off simply press the **On/Off** button on any temperature controller (where fitted). This will shut the water heater down completely including the temperature controller digital display.

The on indicator will go out.

If hot water taps are opened when the Rinnai Infinity is off, cold water will flow from the taps.

If the system is to be left off over the winter be sure to drain it down if there is a possibility of freezing temperatures.

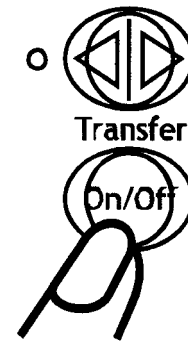

Additional safety features.

Whilst the hot water tap is open, the following safety features apply:

- Temperature selection cannot be transferred.
- If a temperature of 43°C or higher selected, and the temperature is decreased to below 43°C, and then raised again the maximum available temperature will be 43°C.
- Other controllers are unable to change the delivery temperature of the water.

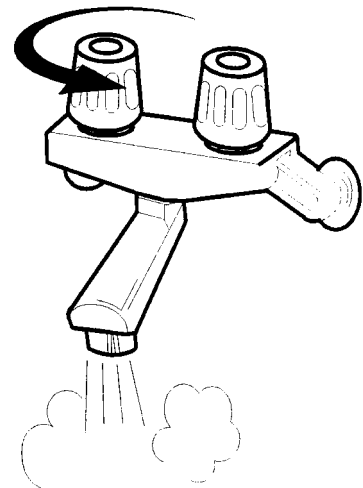

Note

The temperature of the outgoing water is constantly monitored by a built in sensor. If the temperature of the outgoing hot water rises to more than 3°C above the selected temperature shown on the digital display, or the preset limit if controllers are not fitted, the burner will automatically go out. The red operation indicator will also go out. The burner will ignite again once the outgoing hot water temperature falls to that shown on the digital display (or the pre-set limit of the Rinnai Infinity heater).

TEMPERATURE CONTROLS - INFORMATION

Do not push the On/Off button on the Master controller after transferring priority of temperature selection to a Secondary controller as the system will shut down.

Do Not Turn OFF
the Master
Controller

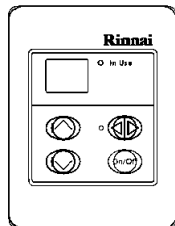

Temperature priority can not be switched to another controller when the water is flowing through the water heater.

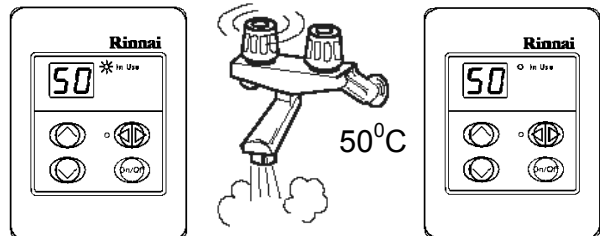

Controller 1
in use

Controller 2
cannot take
priority

If a temperature higher than 50°C has been selected on the **Master** controller and priority of temperature selection is transferred to another controller (or it is turned off), then back again (or turned on again), the temperature on the **Master** controller will automatically drop to 50°C. If the set point is less than 50°C it will not alter. This is a safety feature.

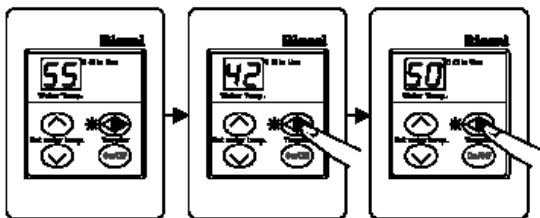

Master
Controller

Another
Controller

Master
Controller

Do not clean the remote control with solvents or detergents. Use only a soft damp cloth.

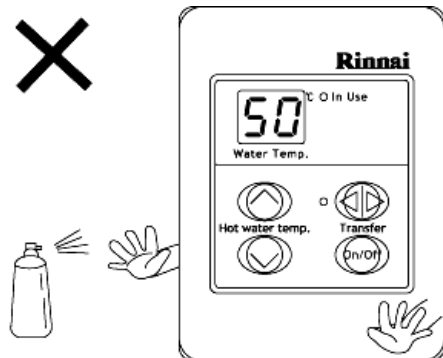

Depending on the weather conditions and the length of the pipe between the heater and the tap in use, there may be a variation between the temperature displayed at the controller and the temperature at the tap.

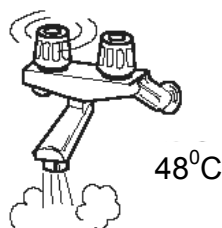
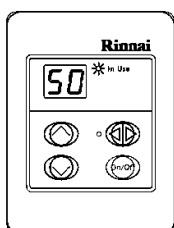

If a temperature higher than 42°C has been selected on the **Universal** controller and priority of temperature selection is transferred to another controller (or controller is turned OFF), then back again (or turned ON again), the temperature will automatically drop to 42°C. If the set point is less than 42°C it will not alter. This is a safety feature.

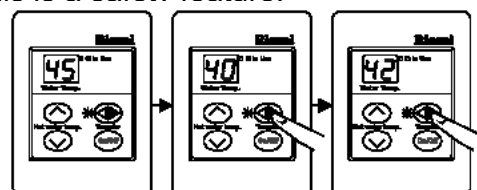

Universal
Controller

Another
Controller

Universal
Controller

TESTING



1. Purge gas, hot water and cold water supply lines before making the final connection of the water heater. Swarf in either the gas or water supplies may cause damage.
2. Turn on gas and cold water supplies.
3. Test for water leaks and gas escapes near the unit.
4. Isolate gas and electric supply. Remove test point screw located on the inlet gas valve connection inside the heater and attach pressure gauge.
5. Turn the power on at the switch and turn on gas. **Warning:** There are 230V AC live supplies inside the heater.
6. If remote controllers are fitted, turn the controller on, select the maximum delivery temperature and open ALL available hot water outlets. If remote controllers are not fitted, simply open all available hot water outlets. (CAUTION: Ensure building occupants do not have access to hot water outlets during this procedure).
7. The gas pressure check must be carried out with all other appliances on the same main operating at maximum capacity to ensure that there is sufficient gas pressure.
8. With all other appliances operating the pressure at the test point on the inlet to the gas valve should read **20 mbar** for Natural Gas. For LPG (Propane) the pressure should be **37 mbar**. If the pressure is lower, the gas supply is inadequate and the water heater will not operate to specification. Check gas meter, regulator and pipework for correct operation/sizing and rectify as required. Note that the gas regulator on the appliance is electronically controlled and factory pre-set. Under normal circumstances it does not need adjustment during installation.
9. Close hot water outlets.
10. Inspect and clean the strainer and the filter located on the cold water inlet pipe. This procedure may need to be repeated to ensure the strainer remains clear.
11. If temperature controllers are fitted, it is necessary to test their operation through the complete range of functions.
12. Confirm the hot water delivery temperature using a thermometer. If controllers are fitted, compare the measured value to the set point.
13. After testing is completed, explain to the user the functions and operation of the water heater and temperature controllers.

GAS PRESSURE SETTING

The working gas pressure on the water heater is electronically controlled and factory set. Under normal circumstances it **does not** require adjustment during installation. Perform this procedure only if the unit is not operating correctly and **all** other possible causes for incorrect operation have been eliminated. **Contact Rinnai UK before attempting to alter the gas pressure. Failure to do so could void the warranty.**

1. Turn 'OFF' the gas supply.
2. Turn 'OFF' 230V power supply.
3. Remove the front cover from the appliance.
4. Check gas type switch no.1 of SW1 (fig. 1) is in the correct position for the type of gas (Nat. or LPG) you are using. (SW1 is top set of switches.)
5. Attach pressure gauge to burner test point. (fig. 2)

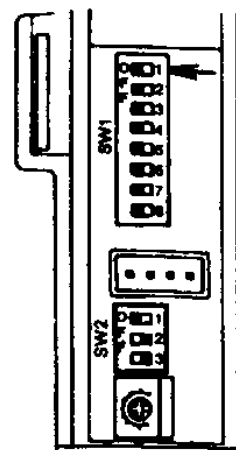

(fig 1)

off	on	SW1		off	on	SW1	
		1	-Nat. Gas			1	-LPG
		2				2	
		3				3	
		4				4	
		5				5	
		6				6	
		7				7	
		8				8	

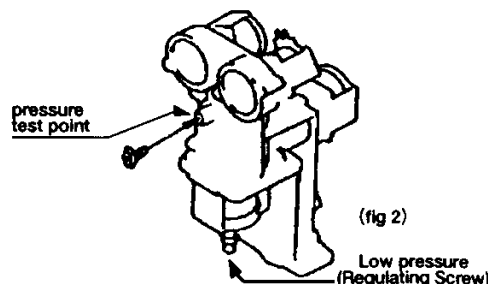

(fig 2)

6. Turn 'ON' the gas supply.
7. Turn 'ON' 230V power supply.
8. If remote controllers are fitted, turn the unit 'ON' at the master controller, select the maximum delivery temperature and open a hot water tap fully. **(CAUTION: Ensure building occupants do not have access to hot water outlets during this procedure.)**
9. Set the appliance to 'Forced Low' combustion by setting No. 2 dipswitch of the bottom set of dip switches (SW2) to 'ON'. (fig 3)
10. Check the burner test point operating pressure.

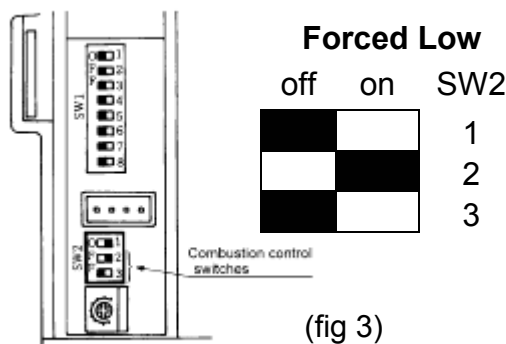

(fig 3)

LEGEND:
Black Section indicates position of dip switch.

OFF	ON	OFF	ON
OFF	ON	OFF	ON

GAS PRESSURE SETTING

11. Remove rubber access plug and adjust the regulator screw on the modulating valve (fig. 4 and 4a) as required to the pressure below.

N.G	0.8 mbar
Propane	1.7 mbar

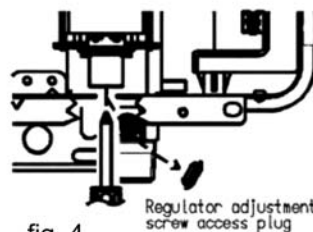
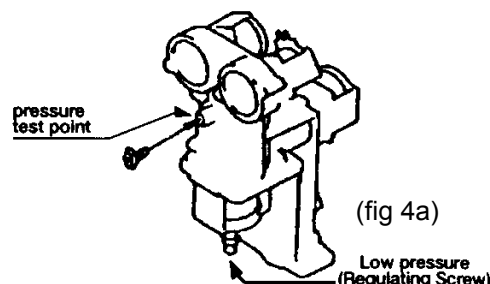

fig. 4

12. Lock the regulating screw on the modulating valve.

13. Set the appliance to 'Forced High' combustion by setting both no. 2 and no. 3 dipswitches of the bottom set of switches (SW2) to 'ON'. (fig.5) Ensure maximum water flow.



14. Check the burner test point pressure.

15. Adjust the high pressure potentiometer on the Printed Circuit Board below SW2 (fig. 6) to the pressure shown below. The potentiometer is very sensitive, turn no more than a few degrees at a time; then let the pressure settle down before turning it more.

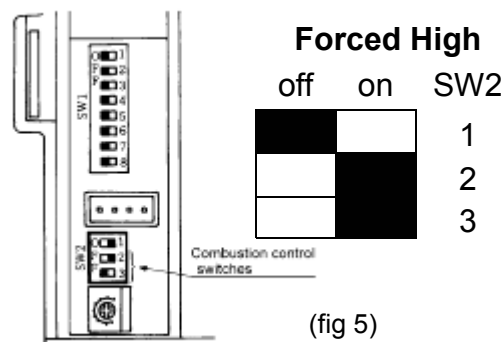

N.G	9.0 mbar
Propane	22.6 mbar

16. **IMPORTANT:** Set dip switch no. 2 and no. 3 on the bottom set of switches (SW2) to 'OFF' to return the appliance to 'Normal' combustion. (fig. 7)

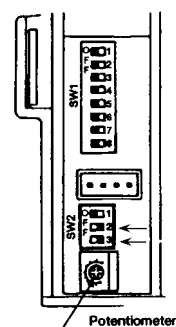

(fig 6)

17. Close hot water tap.

18. Turn OFF the gas supply and 230V power supply.

19. Remove pressure gauge, and replace sealing screw.

20. Turn 'ON' the gas supply and 230V power supply.

21. Operate unit and check for gas leaks at test point.

22. Replace the front cover of the appliance.

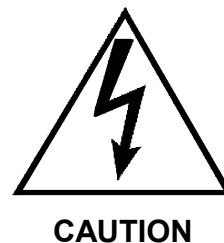
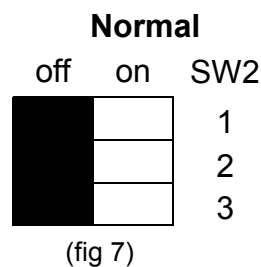

DIP SWITCH SETTING

Dip Switch Positions Explained

OFF ON SW1

<input type="checkbox"/>	<input type="checkbox"/>	1	- Gas Type
<input type="checkbox"/>	<input type="checkbox"/>	2	- Computer Programming
<input type="checkbox"/>	<input type="checkbox"/>	3	- Computer Programming
<input type="checkbox"/>	<input type="checkbox"/>	4	- Temperature
<input type="checkbox"/>	<input type="checkbox"/>	5	- Temperature
<input type="checkbox"/>	<input type="checkbox"/>	6	- Temperature
<input type="checkbox"/>	<input type="checkbox"/>	7	Temperature
<input type="checkbox"/>	<input type="checkbox"/>	8	Temperature

LEGEND:

Black Section indicates position of dip switch.



OFF



ON

OFF ON SW2

<input type="checkbox"/>	<input type="checkbox"/>	1	- Computer Programming
<input type="checkbox"/>	<input type="checkbox"/>	2	- Combustion
<input type="checkbox"/>	<input type="checkbox"/>	3	- Combustion

Dip Switches Explained

GAS TYPE

LPG

OFF ON SW1

<input checked="" type="checkbox"/>	<input type="checkbox"/>	1	off
<input type="checkbox"/>	<input type="checkbox"/>	2	
<input type="checkbox"/>	<input type="checkbox"/>	3	
<input type="checkbox"/>	<input type="checkbox"/>	4	
<input type="checkbox"/>	<input type="checkbox"/>	5	
<input type="checkbox"/>	<input type="checkbox"/>	6	
<input type="checkbox"/>	<input type="checkbox"/>	7	
<input type="checkbox"/>	<input type="checkbox"/>	8	

NAT GAS

OFF ON SW1

<input type="checkbox"/>	<input checked="" type="checkbox"/>	1	on
<input type="checkbox"/>	<input type="checkbox"/>	2	
<input type="checkbox"/>	<input type="checkbox"/>	3	
<input type="checkbox"/>	<input type="checkbox"/>	4	
<input type="checkbox"/>	<input type="checkbox"/>	5	
<input type="checkbox"/>	<input type="checkbox"/>	6	
<input type="checkbox"/>	<input type="checkbox"/>	7	
<input type="checkbox"/>	<input type="checkbox"/>	8	

COMBUSTION

NORMAL

OFF ON SW2

<input type="checkbox"/>	<input type="checkbox"/>	1	
<input checked="" type="checkbox"/>	<input type="checkbox"/>	2	off
<input checked="" type="checkbox"/>	<input type="checkbox"/>	3	off

FORCED LOW

OFF ON SW2

<input type="checkbox"/>	<input type="checkbox"/>	1	
<input type="checkbox"/>	<input checked="" type="checkbox"/>	2	on
<input checked="" type="checkbox"/>	<input type="checkbox"/>	3	off

FORCED HIGH

OFF ON SW2

<input type="checkbox"/>	<input type="checkbox"/>	1	
<input type="checkbox"/>	<input checked="" type="checkbox"/>	2	on
<input type="checkbox"/>	<input checked="" type="checkbox"/>	3	on

COMPUTER PROGRAMMING

OFF ON SW2

<input checked="" type="checkbox"/>	<input type="checkbox"/>	1	- Switch is always in the OFF position for the Infinity 24e
<input type="checkbox"/>	<input type="checkbox"/>	2	
<input type="checkbox"/>	<input type="checkbox"/>	3	

DIP SWITCH SETTING

Temperatures - Remotes Connected

off on SWI

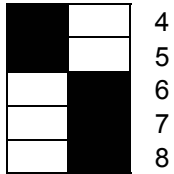

40 deg C

off on SWI

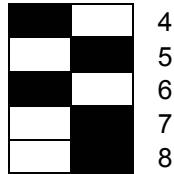

43 deg C

off on SWI

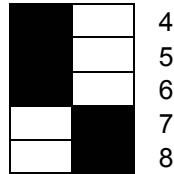

50 deg C

off on SWI

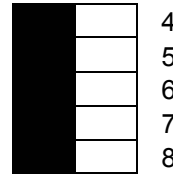

55 deg C

off on SWI

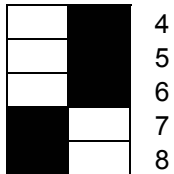

60 deg C

off on SWI

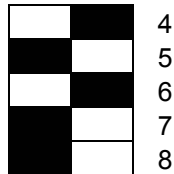

65 deg C

off on SWI

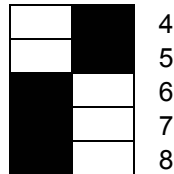

75 deg C

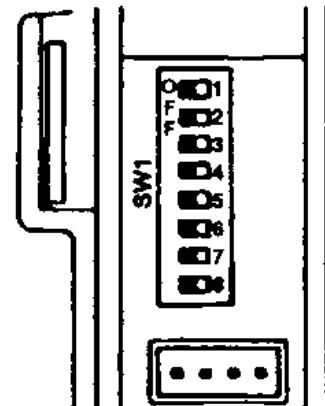

Temperatures - Remotes Not Connected

off on SWI

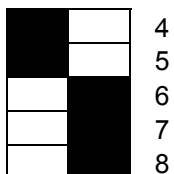

40 deg C

off on SWI

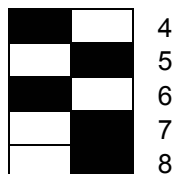

43 deg C

off on SWI

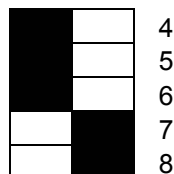

50 deg C

off on SWI

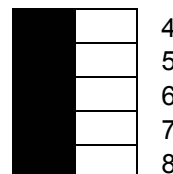

55 deg C

off on SWI

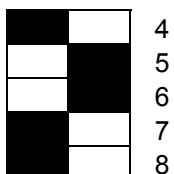

60 deg C

off on SWI

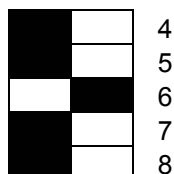

65 deg C

off on SWI

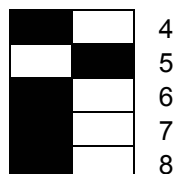

75 deg C

off on SWI

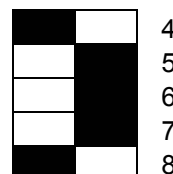

85 deg C

ERROR MESSAGES

Rinnai water heaters have the ability to check their own operation continuously. If a fault occurs, an error code will flash on the Digital Display if you have temperature controllers installed. This assists with diagnosing the fault, and may enable you to overcome a problem without a service call. Please quote the code displayed when enquiring about service. Error codes flash.

Code Displayed	Fault	Remedy
-	Noticeable reduction in water flow	Inlet water filter needs to be cleaned.
10	Not enough combustion air	Check for physical blockages around air intake or exhaust. Check combustion fan.
11	No Ignition / Gas supply	Check gas valves, gas supply and sparker unit.
12	Flame failure / Low Gas flow	Check gas valves and gas supply. Check flame rod. Check exhaust is clear. Check remote control.
14	Remaining flame safety device	Service Call
16	Over temperature warning	Service Call
32	Outgoing water temperature sensor faulty	Service Call
33	Heat Exchanger Thermistor Error	Service Call
52	Gas modulating valve faulty	Service Call
61	Combustion fan failure	Service Call
65	Water Flow Control Device	Service Call
71	Micro-processor failure	Service Call
72	Flame rod circuit error	Service Call
90	Fan Failure	Service Call

* In all cases, you may be able to clear the Error code by turning the hot water tap OFF, then ON again. If this does not clear the error, try pushing the On/Off button OFF then ON again. If the Error Code still remains contact Rinnai or your nearest service agent for advice.

** Faults caused by insufficient gas/water supply or gas/water quality and installation errors are not covered by the manufacturer's guarantee.

ERROR MESSAGES

Troubleshooting without controllers

If you have not installed temperature controllers and experience the following symptoms, please carry out the suggestions below. If symptoms continue, please contact Rinnai for advice.

Fault	Remedy
Heater does not attempt to start at all.	Check the power is on at the heater. Check the cold water valve supplying the heater is open.
Heater starts then shuts down immediately.	Check the power is on. Check the gas valve at the heater and at the gas meter is fully open. Open the hot water tap fully.
Heater starts then the water goes cold.	Check the power is on. Open your hot water tap further or try another hot outlet.

NOTE: Faults caused by insufficient gas/water supply or gas/water quality and installation errors are not covered by the manufacturer's guarantee.

Installations with circulation pumps

With temperature controller fitted.

If you have an installation using a secondary circulation pump this must be switched off so that there is no flow through the heater when starting or after a power failure. If the pump is running the unit will not operate (no display on the controller). Isolate pump then start heater before restarting pump. This is a safety feature.

The pump should also be fitted with a thermostat to prevent the return temperature reaching the heater set point temperature.

Without temperature controller fitted.

The heater should automatically reset and provide water at the temperature set by the internal limit switches.

RESTARTING THE RINNAI WATER HEATER

Following a power cut the heaters should be restarted in this manner.

Standard system.

Single or multiple water heaters without remote controllers.

The heaters will automatically reset without any user involvement.

Single or multiple water heaters with remote controllers.

The heaters will be required to be switched on using the ON/OFF button on a remote controller. Ensure that all taps/water outlets are closed and no water is flowing through heaters.

Hot water system incorporating secondary recirculation pump.

Single or multiple water heaters without remote controllers.

The heater(s) will automatically reset without any user involvement.

Single or multiple water heater(s) with remote controller(s).

To reset the heaters follow the steps.

1. Turn off all hot water taps.
2. Turn off supply to secondary circulating pump or alternatively, if heater and pump are fed from the same electrical supply, isolate pump flow.
3. Turn on heater at remote control.
4. Select required temperature.
5. Switch on supply to secondary circulating pump or open valve on pump flow.

The heater will now be ready to supply water at the set temperature.

If following the above procedure does not reset the heater switch it on and off at its main supply, and then go through these steps again. If heater is still not working call your local service agent or Rinnai for assistance.

WIRING DIAGRAM

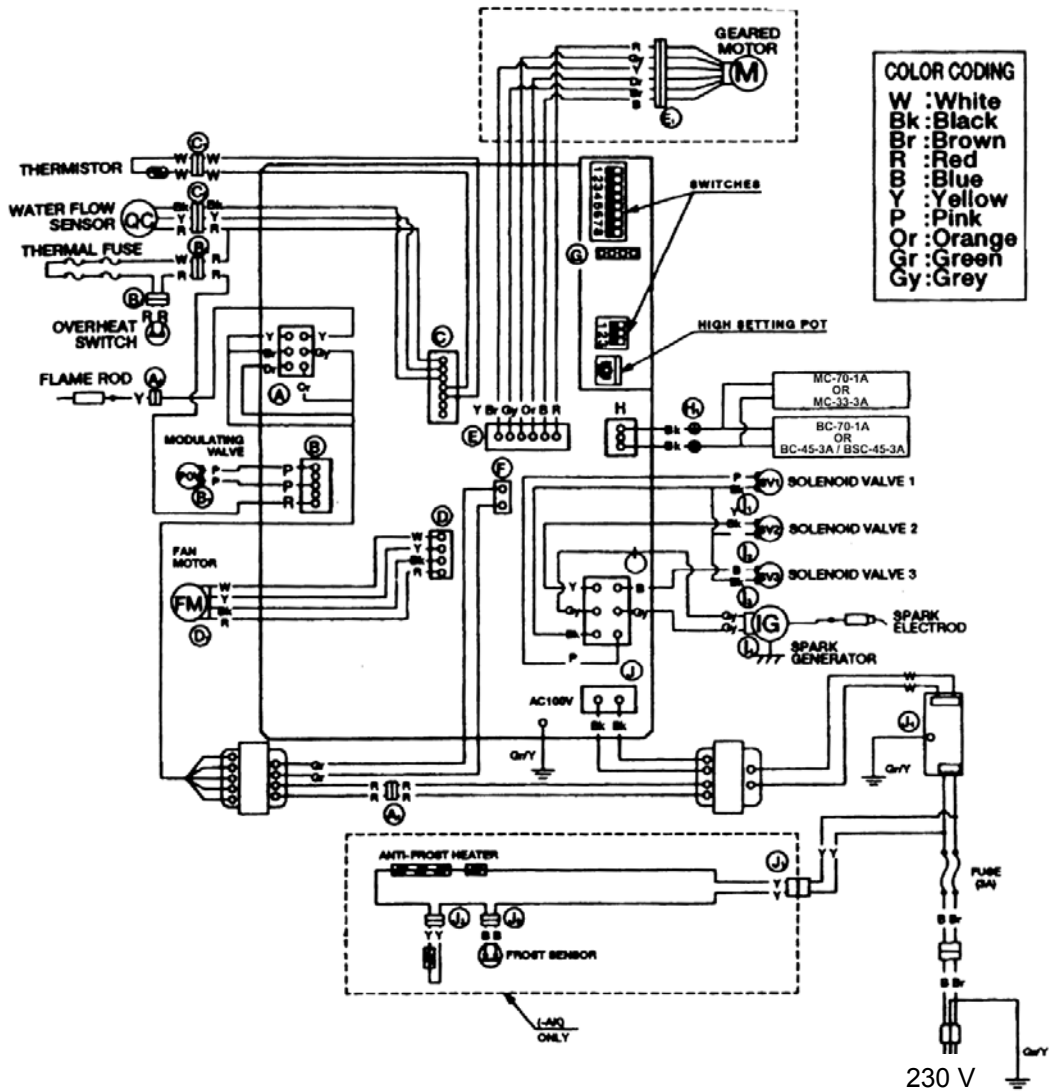

DIAGNOSTIC POINTS

Diagnostic Points- To be read in conjunction with the wiring diagram.

FLOW CHART NO.	COMPONENT	MEASUREMENT POINT		NORMAL VALUE
		CN	WIRE COLOUR	
①	SURGE PROTECTOR	J ₄	B-Br	AC207~264V
②	REMOTE CONTROL	H ₁	Bk-Bk	DC10~13V
③	WATER FLOW SENSOR	C ₂	R-Bk	DC11~13V
			Y-Bk	DC2~10V
④	FAN MOTOR	D	W-Bk	DC2~9V
		G	CHECK TERMINAL	60~350Hz
⑤	FLAME ROD	A ₂	Y-EARTH	AC100~160V ABOVE DC1 μ A
⑥	THERMISTOR	C ₁	W-W	15°C 11.4~14.0k Ω 30°C 6.4~7.8k Ω 45°C 3.6~4.5k Ω 60°C 2.2~2.7k Ω 105°C 0.6~0.8k Ω
⑦	THERMAL FUSE	B ₂	W-R	BELOW 1 Ω
⑧	OVERHEAT SWITCH	B ₃	R-R	BELOW 1 Ω
⑨	SPARK GENERATOR	I ₄	Gy-Gy	AC90~110V
⑩	SOLENOID VALVE 1	I ₁	P-Bk	DC80~100V 0.9~1.3k Ω
⑪	SOLENOID VALVE 2	I ₂	Y-Bk	DC80~100V 1.3~1.9k Ω
⑫	MODULATING VALVE	B ₁	P-P	DC0.5~25V 60~100 Ω
⑬	SOLENOID VALVE 3	I ₃	B-Bk	DC80~100V 1.3~1.9k Ω
⑭	GEARED MOTOR	E ₁	R-B	DC11~13V
			Or-Gy	

TRANSFORMER VOLTAGES AND RESISTANCE

CN	WIRE COLOUR	NORMAL VALUE
A ₁	R-R	AC90~110V 15~21 Ω
F	Gr-Gr	AC16~20V 6~10 Ω
A	Or-Or	AC13~30V 1.4~1.8 Ω
A	Br-Gy	AC30~50V 6~10 Ω
A	Y-Gy	AC180~220V 0.4~0.6k Ω

SPECIFICATION

Model	Infinity 24e
Installation	External location only
Fuel	Natural Gas or LPG *
Control	Modulating
Input	5.8 to 52 kW
Exhaust type	Forced Draught Direct Exhaust
Ignition	Electronic
Burner	Stainless steel
Weight	18kg
Water flow rate	2.4** to 24L/min
Minimum operating water pressure	1.4 Bar

Connections

Gas	3/4BSP
Water Inlet	3/4BSP
Water outlet	3/4BSP
Electrical Supply	230V AC 50Hz 1ph

* Separate models available for Natural gas or LPG fuel.

** Minimum flow rate based on temperature setpoint and inlet conditions.

Rinnai are continually updating and improving products and reserve the right to alter model specifications without prior notice.

NOTES

SERVICE CONTACT

Rinnai UK LTD.

9 Christleton Court
Manor Park
Runcorn
Cheshire
WA7 1ST

Tel. 01928 531870

Fax. 01928 531880

E-mail. info@rinnaiuk.com

Web. www.rinnaiuk.com

COMMISSIONING CHECK LIST

For full details - Refer to Installation Instructions

Attention Installer - have you checked:

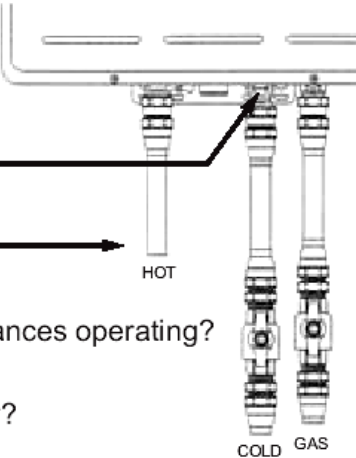
- Gas supply pipe is purged of foreign matter before connection.
- For Hot and Cold cross connections i.e. Capped breaches/shower mixers, taps closed and reversed 'Flick Mixer' connections?
- That isolating valves are not connected directly to the appliance and there is means of disconnection after the isolating valve?
- Have you cleaned cold water inlet filter? 
- That plumbing connections are correct?
- Is appliance inlet gas pressure correct with all appliances operating?
- Do the Master Controllers (if fitted) operate correctly?
- Have you checked water temperature at all outlets?
- Have you shown the customer how to operate the Temperature Controllers? (If fitted)
- Have you explained to the customer the minimum flow rate required to operate the unit?
- Have you explained to the Customer the Benefits of Controllers (If not fitted) and that they can be added later?

Free Manuals Download Website

<http://myh66.com>

<http://usermanuals.us>

<http://www.somanuals.com>

<http://www.4manuals.cc>

<http://www.manual-lib.com>

<http://www.404manual.com>

<http://www.luxmanual.com>

<http://aubethermostatmanual.com>

Golf course search by state

<http://golfingnear.com>

Email search by domain

<http://emailbydomain.com>

Auto manuals search

<http://auto.somanuals.com>

TV manuals search

<http://tv.somanuals.com>