

ROPER[®] Microwave Hood Combination

PRODUCT MODEL NUMBERS

MHE14X

Electrical: A 120-volt, 60-Hz, AC-only, 15- or 20-amp. electrical supply located in the upper cabinet as close as possible to the microwave oven hood. A time-delay fuse or circuit breaker and separate circuit is recommended.

OVERALL DIMENSIONS

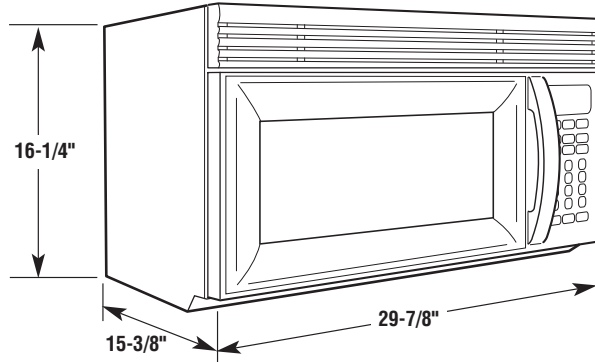

CABINET OPENING DIMENSIONS

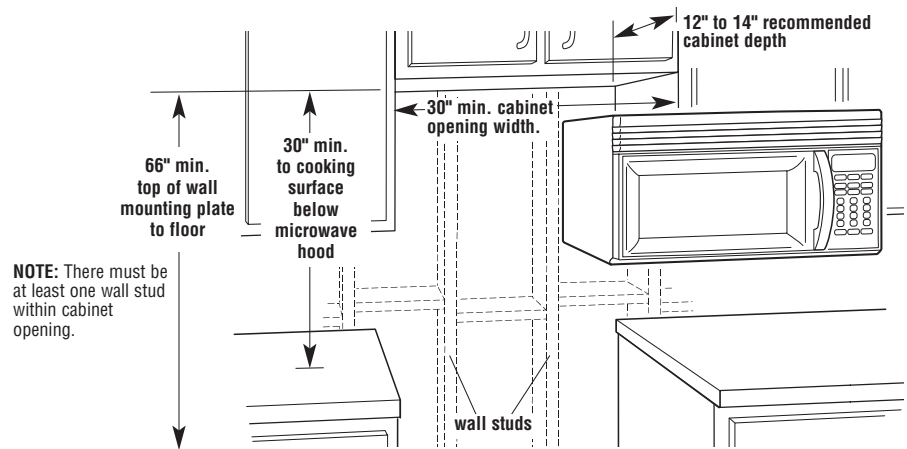

VENTING REQUIREMENTS

Roof venting

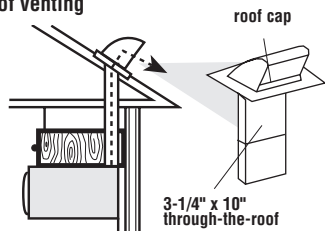

Wall venting

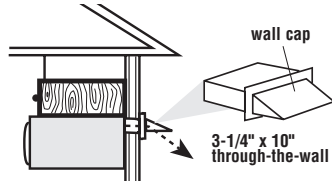

Recommended standard fittings

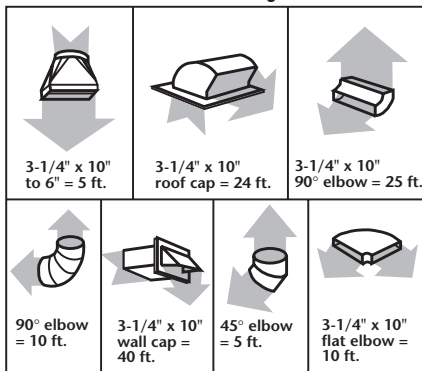

If the existing vent is round, a rectangular-to-round adapter must be used and a rectangular 3" extension vent between the damper assembly and the adapter must be installed to prevent sticking of the exhaust damper.

For wall or roof venting methods:

If the wall exhaust method is chosen, be sure that there is proper clearance within the wall for the exhaust vent.

Wall and roof caps must have back-draft damper.

We recommend:

- ✓ using rigid metal vent.
- ✓ that length of vent and number of elbows should be kept to a minimum to provide efficient performance.
- ✓ that size of vent should be uniform.
- ✓ using duct tape to seal all joints in the vent system.
- ✓ using caulking compound to seal exterior wall or roof opening around cap.
- ✓ two elbows should not be installed together.

We do NOT recommend:

- ✓ flexible metal vent.

NOTE: If flexible metal vent must be used, calculate each foot of flexible metal vent as two feet of rigid metal vent. Flexible metal elbows count twice as much as standard elbows.

Recommended vent length

Use 3-1/4" x 10" or 6" vent. The total length of the vent system including straight vent, elbow, transitions, wall or roof caps must not exceed the equivalent of 140 feet of 3-1/4" x 10" rectangular or 6" diameter round vent. For best performance, use no more than three 90° elbows. To calculate the length of system you need, add the equivalent feet for each vent piece used in the system. See examples below.

3-1/4" x 10" vent system

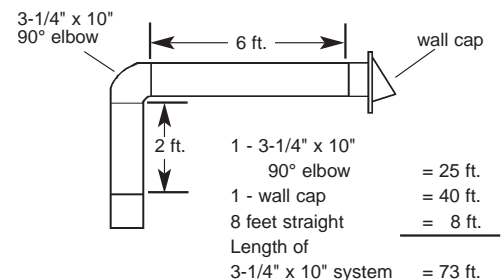

6" vent system

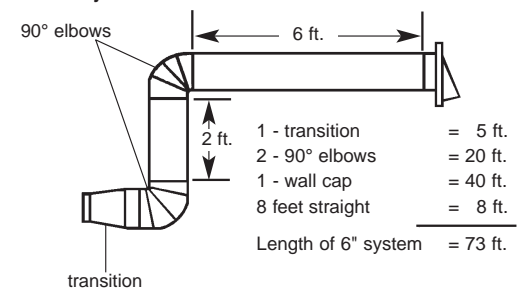

Free Manuals Download Website

<http://myh66.com>

<http://usermanuals.us>

<http://www.somanuals.com>

<http://www.4manuals.cc>

<http://www.manual-lib.com>

<http://www.404manual.com>

<http://www.luxmanual.com>

<http://aubethermostatmanual.com>

Golf course search by state

<http://golfingnear.com>

Email search by domain

<http://emailbydomain.com>

Auto manuals search

<http://auto.somanuals.com>

TV manuals search

<http://tv.somanuals.com>