

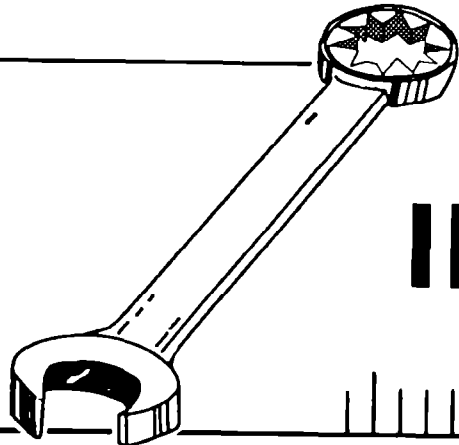

OWNER'S MANUAL

ELECTRIC DROP-IN

model D975



INSTALLATION

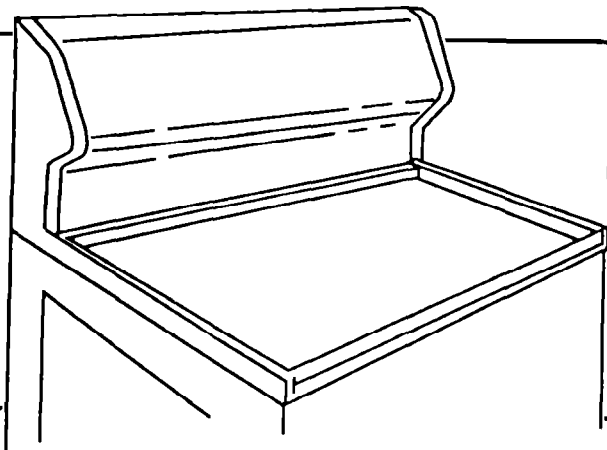

CARE & USE RECIPES

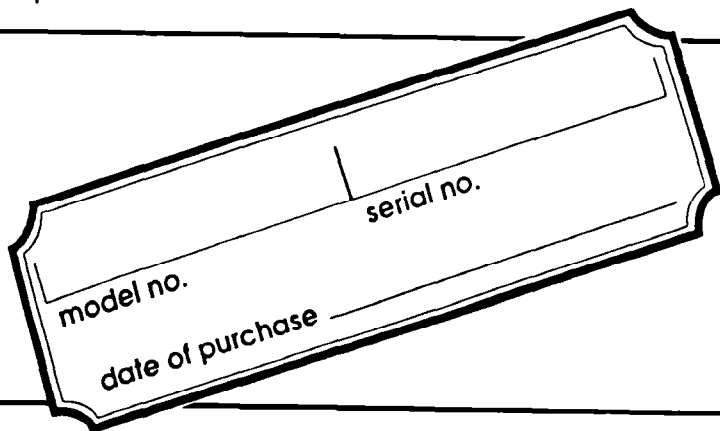

SERVICE

**THIS PAGE
INTENTIONALLY LEFT BLANK**

CONTENTS

INSTALLATION

USE AND CARE

- Important Instructions for Your Safety
- Your Oven and Its Features
- The Electronic Oven Control
- Oven Cooking
- Broiling
- Favorite American Recipes
- The Self-Clean Cycle
- Cleaning Tips
- Removable Range Parts

SERVICE

- Replacing Oven Light Bulbs
- What to Do before Calling for Service
- Adjusting Oven Temperature

WARRANTY

INSTALLATION

IMPORTANT: Save these instructions for the local electrical inspector's use.

TOOL LIST

Hand or electric drill
 Hand or saber saw
 Pencil
 Ruler or tape measure
 Straight edge
 1/8" drill bit

ADDITIONAL MATERIALS

This range is designed to hang from the counter top. It does not rest on the floor.

If counter top is less than 1-1/2" thick, reinforcing braces must be installed under the countertop, on each side. See figure below.

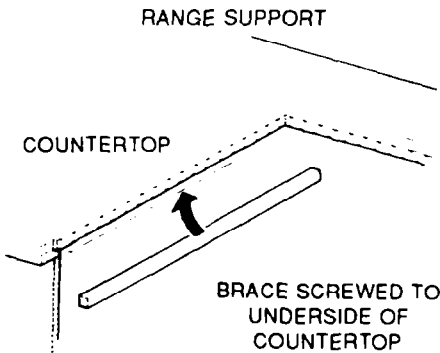

LOCATION

- Put the range near a work surface for convenience.
- The cooktop should be easy to reach and lighted with natural light during the day.
- To eliminate the risk of burns or fire by reaching over heated surface units, cabinet storage space located above the surface units should be avoided. If cabinet storage space is to be provided, the risk can be reduced by installing a range hood that projects horizontally a minimum of 5 in. beyond the bottom of the cabinets.
- See Figures 1 and 2 for all rough-in and spacing dimensions. These dimensions must be met for safe use of your range.
- A wiring junction box must be installed in an adjoining cabinet or under the floor. The junction box must be located where it will allow considerable slack in the 4 ft. long range conduit, so that the range can be pulled forward for servicing if necessary. See next page for more information.

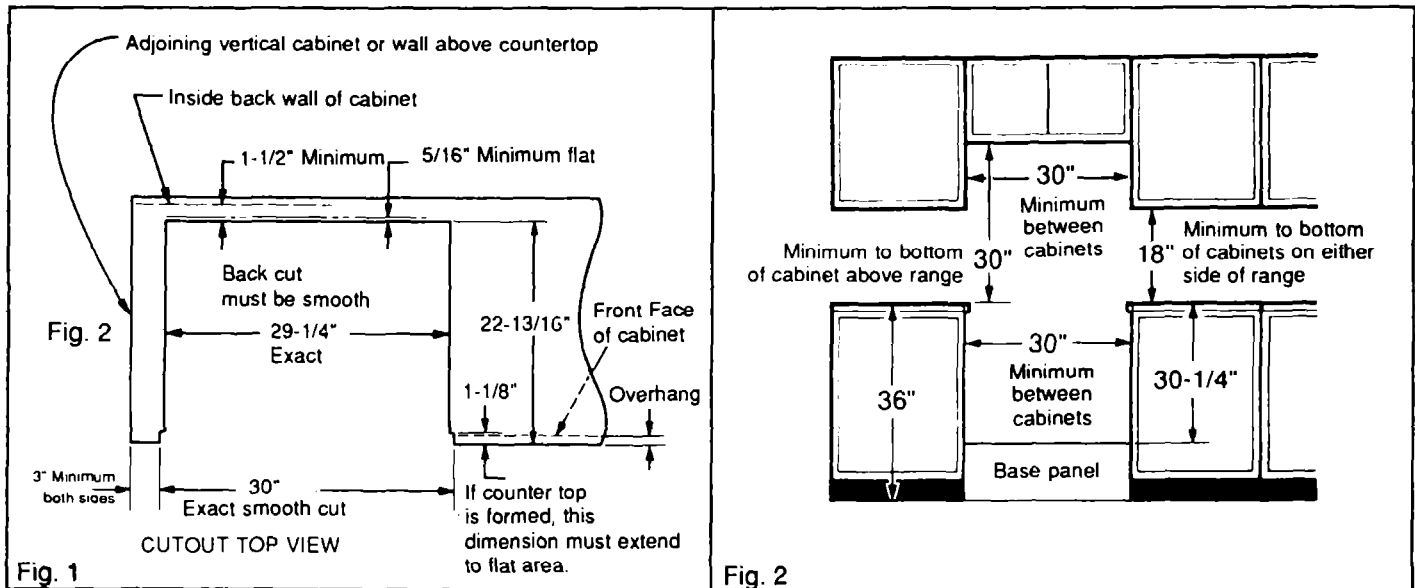

ELECTRICAL REQUIREMENTS

We recommend you have the electrical wiring and hookup of your range done by a qualified electrician. After installation, have the electrician show you where your main range disconnect is located.

Check with your local utilities for electrical codes which apply in your area. Failure to wire you range according to governing codes could result in a hazardous condition. If there are no local codes, you range must be wired and fused to meet the requirements of the National Electrical Code, ANSI/NFPA No. 70-1987. You can get a copy by writing:

National Fire Protection Association
Batterymarch Park
Quincy, MA 02269

You must use a three-wire, single-phase A.C. 208Y/120 Volt or 120/240 Volt, 60 Hertz electrical system. If you connect to aluminum wiring, properly installed connections approved for use with aluminum wiring must be used.

In the absence of local codes, we recommend that a minimum wire size of No. 8 copper wire and a 40 amp fuse or circuit breaker be used, on both 208Y/120 Volt and 120/240 Volt systems.

PREPARE THE COUNTER

1. Install base cabinets 30" apart, and be sure they are plumb and level before attaching the countertop.
2. Lay out the cutout opening on the countertop per Fig. 1. (Countertop cutout shown in Fig. 1. assumes a standard installation in a 25" deep counter with a standard 1-1/4" overhang.) If the overhang is less than 1-1/4", the range front side trims and control panel end caps will extend into the 30" cutout. If the overhang is greater than 1-1/4", a gap between the cabinet face and the range front side trims will exist. A moulding may be fitted to provide a more custom appearance. Before cutting, check for dimension marked min. (Fig. 1). If these dimensions are not met, the product can be moved forward on the countertop until minimum dimensions are met. (Decrease the cutout dimensions 22-13/16" & 1-1/8" by the amount of the forward movement.) This will make the end caps extend forward in front of the countertop and may create a gap between the range front trims and the cabinet face. If this occurs, fit moulding as above. If it is not flat at the back of the notch, the raised area must be filed or cut away to fit.
3. Make cutout. If the countertop is not 1-1/2" thick, install reinforcing braces under the countertop as shown on page 1.
4. Install the wiring junction box in an adjoining cabinet or under the floor. Cut 1-1/2" dia. hole to bring the electrical cable from the range to the junction box. The junction box must be located so that there will be enough slack in the connected cable to allow the range to be pulled forward several inches for service if necessary.

MAKE ELECTRICAL CONNECTION

1. De-energize range branch circuit.
2. With range in front of opening, push flexible electrical cable through hole in floor or adjacent base cabinet and attach it to the junction box. Do not shorten this cable. The flexible cable connector must be securely attached to the junction box and the flexible cable must be securely attached to the connector. If the flexible cable will not fit within the connector, do not install the range until a connector of the proper size is obtained. When connecting to a 3-conductor branch circuit, if local codes permit, connect the white and bare ground connector leads of the range to the branch circuit neutral (white or gray in color), the range red lead to the branch circuit red lead and the range black lead to the branch circuit black lead in accordance with local codes.

Special Grounding Instructions

- When connecting to a 4-conductor branch circuit.
 - When installing range in a mobile home.
 - When local codes do not permit grounding through neutral.
1. Attach the appliance grounding lead (green or bare copper) to the residence grounding conductor (green or bare) in accordance with local codes. If the residence grounding conductor is aluminum, see "WARNING" note below.
 2. Connect the range neutral (white) lead to the branch circuit neutral (white or gray) in accordance with local codes.
 3. Connect the range red lead to the branch circuit red lead and the range black lead to the branch circuit black lead in accordance with local codes. If the residence red and black leads are aluminum conductors, see "WARNING" note below.

NOTE TO ELECTRICIAN: The three power leads supplied with this appliance are U.L. recognized for connection to larger gauge household wiring. The insulation of these three leads is rated at temperatures much higher than the temperature rating of household wiring. The current carrying capacity of a conductor is governed by the temperature rating of the insulation around the wire rather than the wire gauge alone.

WARNING: IMPROPER CONNECTION OF ALUMINUM HOUSE WIRING TO THESE COPPER LEADS CAN RESULT IN A SERIOUS PROBLEM. USE ONLY CONNECTORS DESIGNED FOR JOINING COPPER TO ALUMINUM AND FOLLOW THE MANUFACTURER'S RECOMMENDED PROCEDURE CLOSELY.

INSTALL RANGE

BE SURE RANGE BRANCH CIRCUIT IS DE-ENERGIZED.

1. Remove Oven Door

- Open the door to the stop position (see illustration).
- Grasp the door at each side and lift up and off the hinges.

NOTE: When the door is removed and hinge arms are at stop position, do not bump or try to move the hinge arms. The hinges could snap back causing injury to the hands or damage to the porcelain on the front of the range. Cover the hinges with toweling or empty towel rolls while working in the oven area.

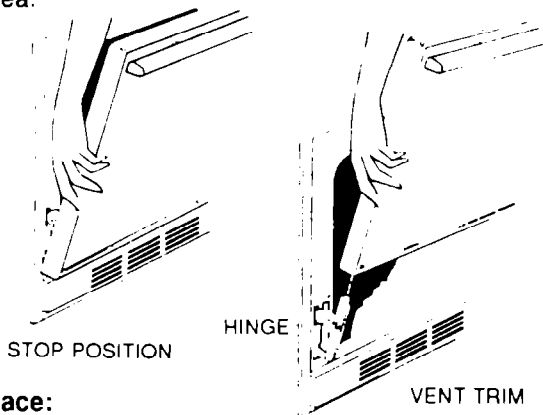

To replace:

- Hold the door over the hinges with the slots at the bottom edge of the door lined up with the hinges. The hinge arms must still be in the stop position.
- Slide the door down onto the hinges as far as it will go and close the door.

2. Position range in opening.

- Raise lift-up cooktop and support it with cooktop support rod.
- Drill 1/8" diameter pilot holes into countertop using holes in upper side panels. Attach range to countertop (Fig. 4) with screws provided in literature package.

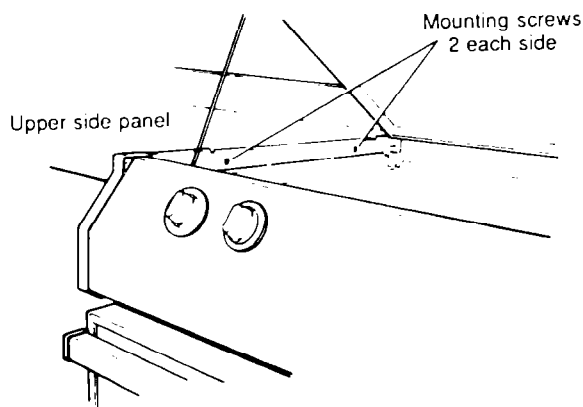

IMPORTANT SAFETY WARNING

Be sure to attach range to counter and be sure counter top is securely attached to the cabinets or wall.

Failure to do so could permit the range to tip, causing injury.

IMPORTANT INSTRUCTIONS FOR YOUR SAFETY

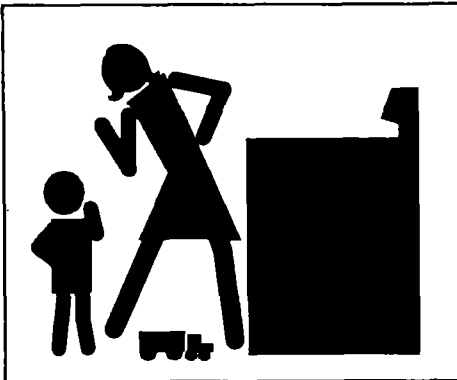

Teach children not to play with range knobs or any other part of the range.
Never leave children alone or unattended where a range is in use.

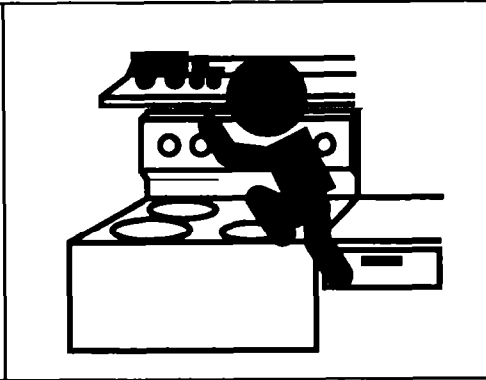

CAUTION! Never store things children might want above a range.
Never let anyone climb, sit or stand on the open door or any other part of the range. Their weight may make the range tip over.



Never leave the oven door open when you are not watching the range.
Never let children sit or stand on the open oven door.

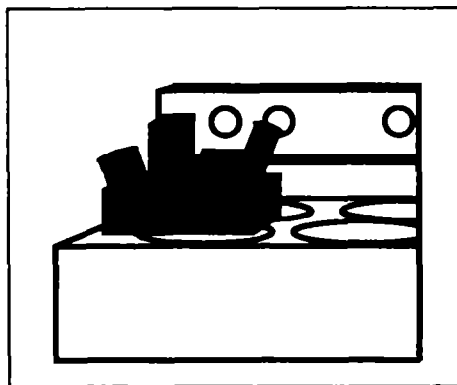

Always keep the range area clear and free from things that will burn.
Never store things in an oven or near cooktop elements/burners. These things may catch fire and plastic items could melt.

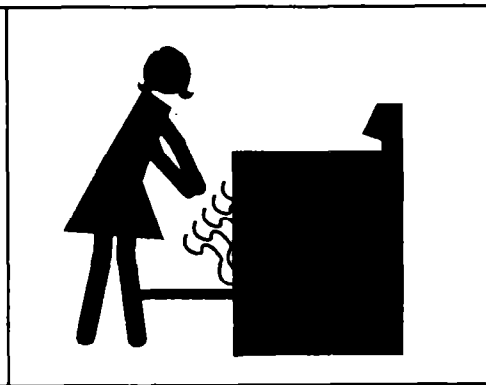

Never use your range for warming or heating a room. Such use could be dangerous and hurt range parts.



Never let pot handles stick out over the front of the range. Turn handles in so that they cannot be bumped into. Keep the handles away from other hot surface elements/burners.

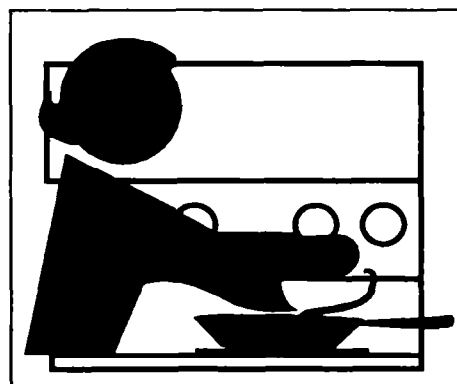

Never wear loose clothing when using your range. Such clothing could catch fire.

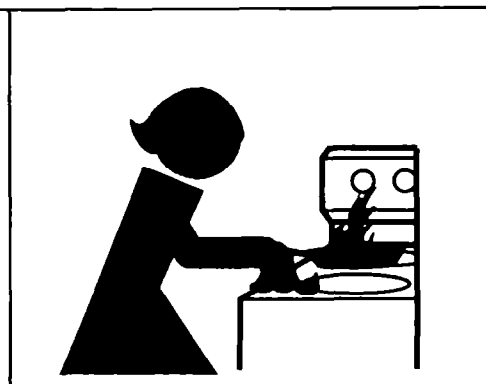

Never use a towel or other bulky cloth as a pot holder. Such cloths could catch fire on a hot element/burner.

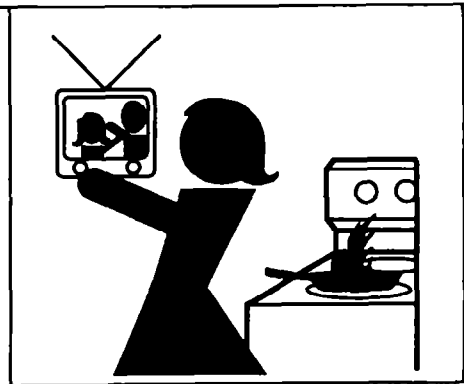

Never leave cooktop elements/burners unattended at high heat settings. Boilovers cause smoking and greasy spillovers could catch fire.

IMPORTANT SAFETY INSTRUCTIONS

Keep this book for later use.

Be sure your range is installed and grounded properly.

Choose pots and pans with flat bottoms, large enough to cover the entire cooktop element. This will cut down the risk of setting pot holders or clothing on fire with an uncovered element and waste less energy.

Always use care when touching cooktop elements, areas near cooktop elements, oven heating elements or inside the oven. Heating elements could be hot enough to burn you even if they are dark in color. The oven vent duct and oven door may also become hot during range use.

Only some kinds of glass or ceramic pans can be used for cooktop cooking. Be sure that the pan you use will not break when heated on the cooktop elements.

Always change oven rack positions while oven is cool.

After broiling, always take the broiler pan out of the range and clean it. Leftover grease in the broiler pan can catch on fire next time you use the pan.

Always use dry pot holders when removing pans from the oven or cooktop. Moist or damp pot holders can cause steam burns.

Always use care when opening oven door. Let hot air and steam out before moving food.

Always follow cleaning instructions in this book.

Always remove the broiler pan and other utensils from the oven before a self-clean cycle.

Never try to repair or replace any part of the range unless instructions are given in this book. All other work should be done by a skilled technician.

Never heat unopened food containers. Pressure build up may make container burst and cause injury.

Never leave jars or cans of fat or drippings on or near the range. Never let grease build up on your range. You can keep grease fires from starting if you clean up grease and spills after each range use.

Never use aluminum foil to line drip bowls or oven bottoms. Improper use of foil could start a fire.

Never block free airflow through the oven vent.

Never try to move a pan of hot fat, especially a deep fat fryer. Wait until the fat has cooled.

Never put removable heating elements in water.

Never use the cooktop without reflector pans or drip bowls being in place. If these pans or bowls are not there during cooking, wiring or other range parts may be damaged.

Never rub, move or damage the door gasket on self-cleaning ranges. The gasket is essential for a good seal. Only clean the gasket by soaking it with hydrogen peroxide, as described in the self-clean section of the manual.

Never touch surface units, heating elements, or interior surfaces of the oven. They may be hot even though they appear dark in color.

FIRE!

Read and understand this information NOW!

Should you ever need it, you will not have time for reading.

Never use water on a grease fire - it will only spread the flames.

COOKTOP GREASE FIRE

Never pick up a flaming pan...Instead:

1. Turn off the element.
2. Smother the fire with a tightly fitting pan lid, baking soda or an extinguisher.

OVEN FIRE

1. Close oven door and turn controls off.
2. If fire continues, throw baking soda on the fire.

Your Range

IMPORTANT: The model and serial number of your range can be found on a tag located below the lift-up cooktop, at the rear.

Copy the numbers into the box on the cover of this manual.

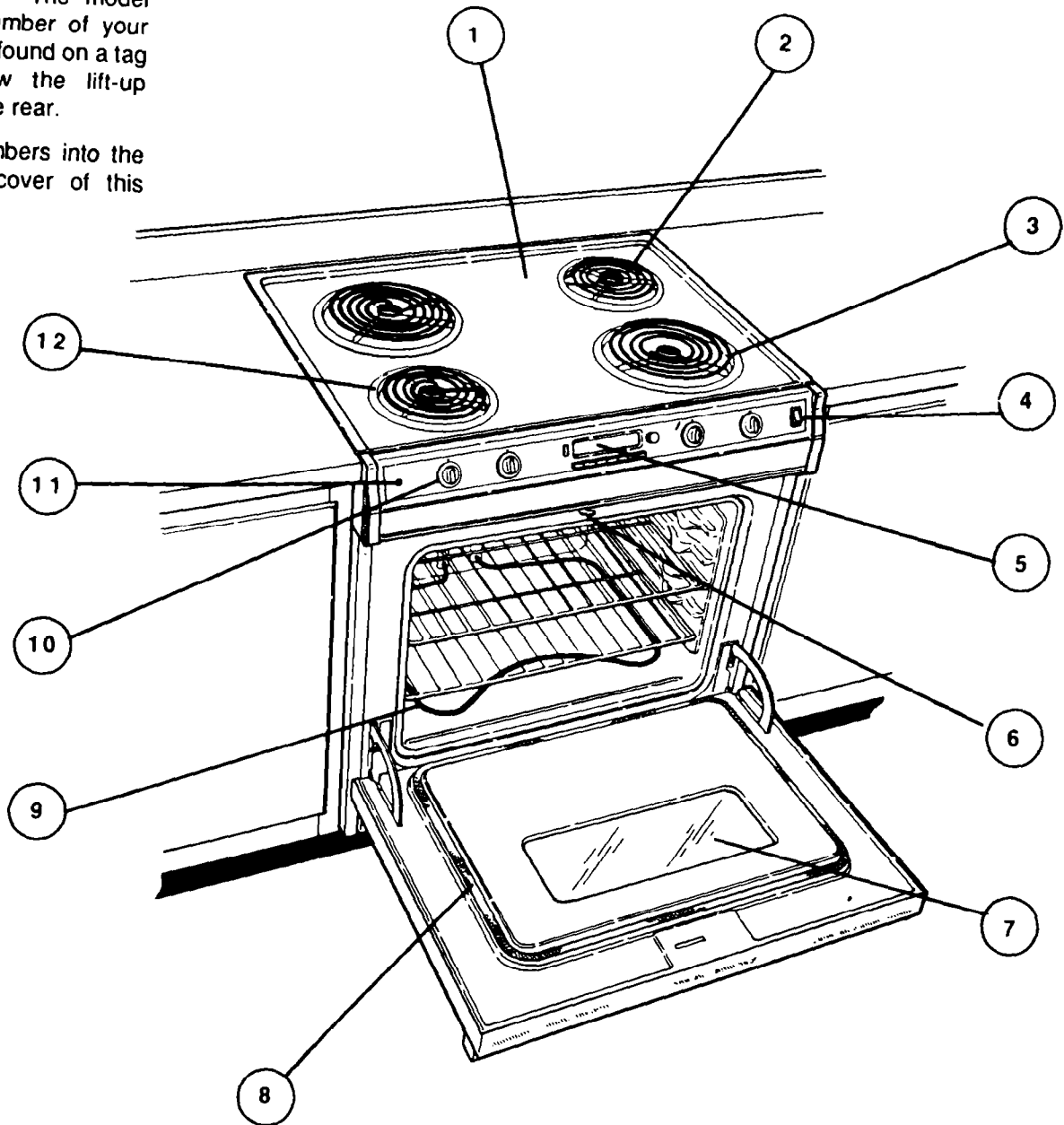

1. Lift-Up Cooktop
2. Oven Vent (below right rear element; area may get hot during oven use; DO NOT block vent)
3. Removable Cooktop Elements
4. Oven Light Switch
5. Electronic Range Control (see next page)
6. Oven Door Latch (locks door during self-clean cycle; see self-clean section for more information)
7. Removable Oven Door
8. Oven Door Gasket
9. Oven Bake Element
10. Cooktop Control
11. Cooktop Indicator Light (glows when any cooktop element is on)
12. Removable Chrome Reflector Bowls

The Electronic Range Control (ERC)

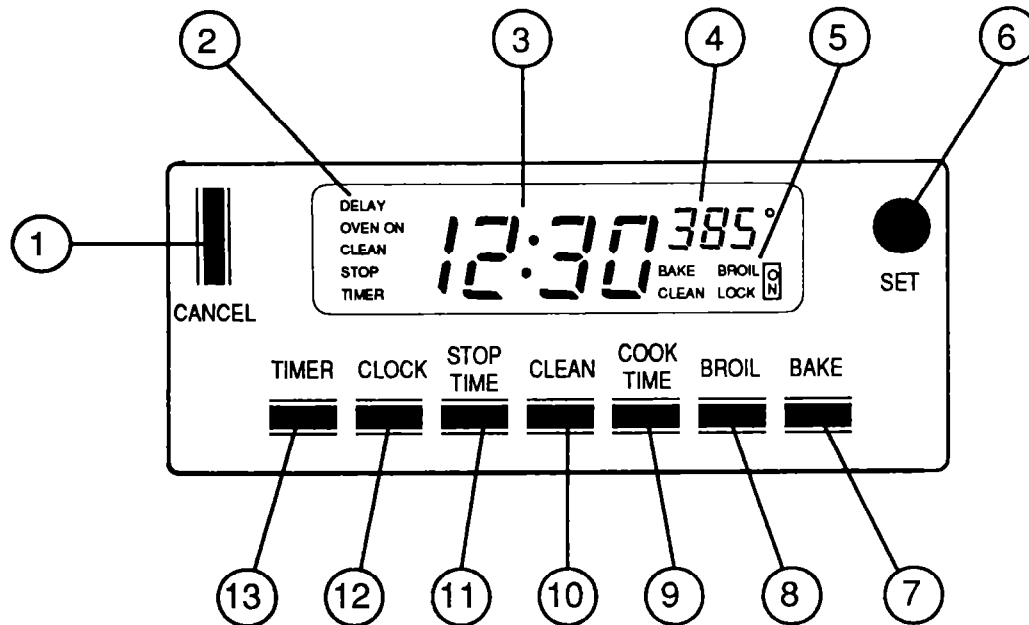

1. **OVEN CANCEL BUTTON** - Cancels everything except the clock and timer. Push this button to turn the oven off or to clear everything if you've made a mistake in programming.
2. **DISPLAY INDICATORS** - Light up to tell you what is being shown in the TIME DISPLAY WINDOW.
3. **TIME DISPLAY WINDOW** - Shows the time of day or the times you set for the timer or automatic oven operation.
4. **OVEN TEMPERATURE AND BROIL DISPLAY WINDOW** - Shows the oven temperature or broil setting you have selected.
5. **FUNCTION INDICATORS** - Light up to show whether oven is baking, broiling or self-cleaning.
6. **SET KNOB** - Turn to set times and temperatures after pushing a function button.
7. **BAKE** - Push before setting bake temperature.
8. **BROIL** - Push before selecting BROIL setting.
9. **COOK TIME** - Push before setting length of cook time for automatic oven operations.
10. **CLEAN** - Push to use self-clean cycle.
11. **STOP TIME** - Push before selecting the time when you want the oven to turn off for automatic oven operations.
12. **CLOCK** - Push before setting clock or to bring time of day into the TIME DISPLAY WINDOW.
13. **TIMER** - Push before setting amount of time.

7-13 FUNCTION BUTTONS

7. **BAKE** - Push before setting bake temperature.
8. **BROIL** - Push before selecting BROIL setting.

TO SET THE CLOCK

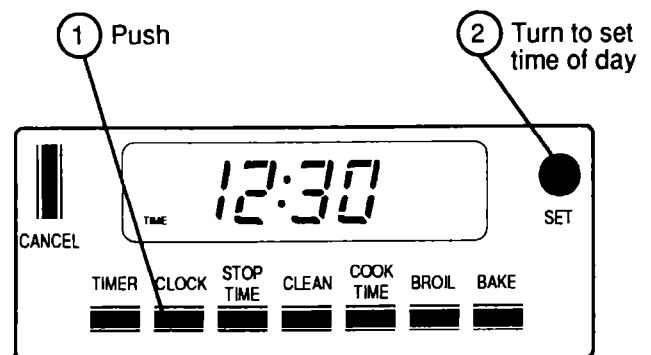



To start things cooking

Cooktop Cooking

The sign near each cooktop control knob shows which element is turned on by that knob.

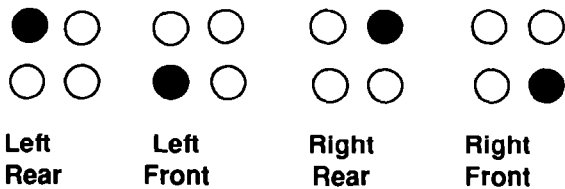

To operate cooktop controls:

1. Push to turn.
2. Set on or between marks for desired heat.

An indicator light will glow when any cooktop element is on.

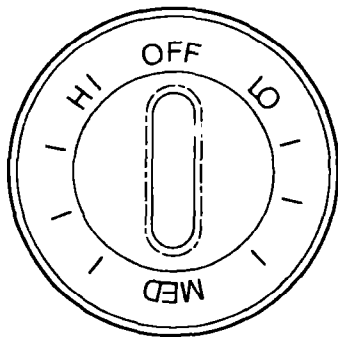

COOKTOP CONTROL

For best cooking results and energy efficient operation, you should use pans that:

- A. Have flat bottoms and straight sides.
- B. Have light handles that do not tilt pans.
- C. Are about the same size as the element.

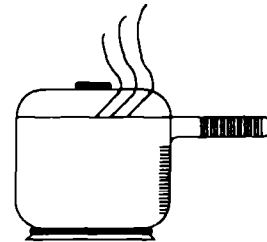

When the oven is on, heated air moves through a vent under the right rear cooktop element. This hot air may make pot handles hot or melt plastic items left too near the vent. The vent is necessary for proper oven performance. Do not block it.



Never line the bowls below cooktop elements with aluminum foil. Foil can block normal heat flow, and damage the range. This is especially true if foil blocks the oven vent tube under the right rear cooktop element.

TO BAKE OR ROAST

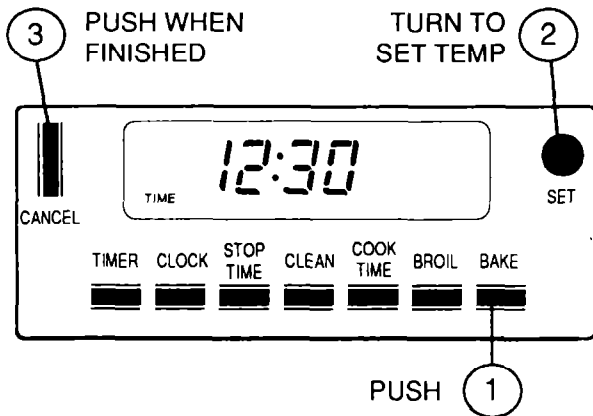

The red display will show the oven temperature as it rises (in 5° steps).

A tone will sound when the oven is ready.

DELAYED BAKE CYCLE

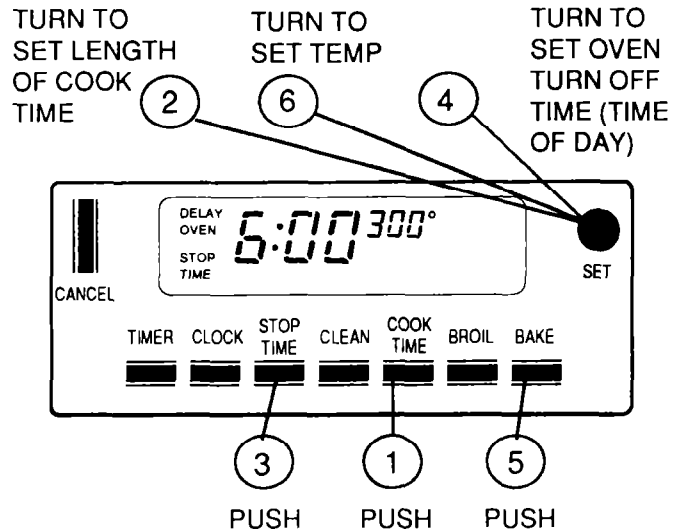

When cook time has ended, a tone will sound and the oven will turn off.

AUTOMATIC OVEN OFF

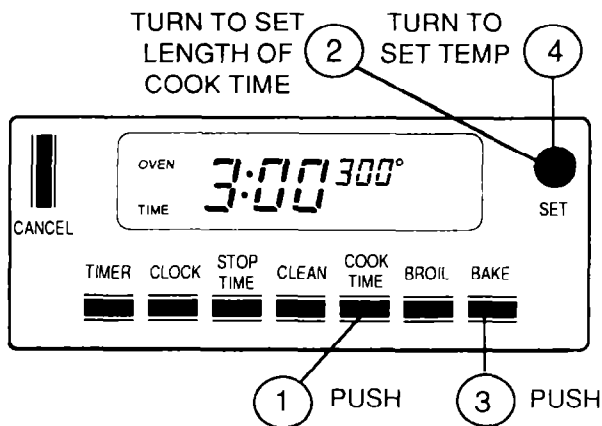

The ERC will calculate when to turn the oven off. When the stop time is reached, a tone will sound and the oven will turn off.

TO USE THE TIMER

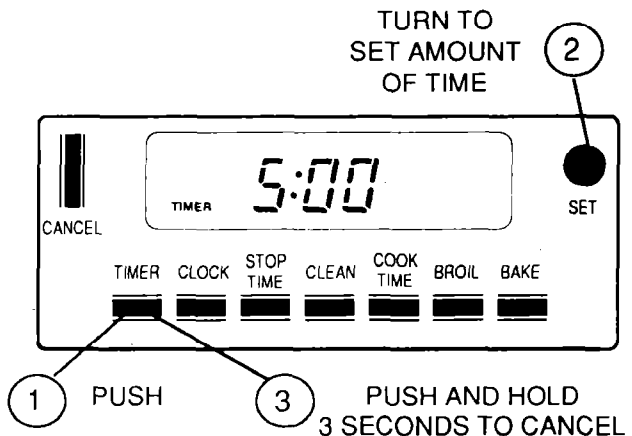

A tone will sound when time is up.

NOTE: The timer is a reminder only and will not operate the oven.

INCOMPLETE OR INCORRECT SETTINGS

1. Attention Tone will sound if oven has only been partially programmed. For example, if you have selected a cook time but no temperature, you will hear the Attention Tone until you select a temperature or push CANCEL.
2. Function Error Tone will sound if there is a problem with one of the range functions. Cancel the tone by pushing the CANCEL button. If the tone starts again, call for service.

RECALLING FUNCTIONS

You may recall any set function by pushing the button of that function.

CANCELLING TONES

If you prefer that your range not have a tone whenever you push a button, you can eliminate those tones by pushing and holding the CANCEL button until you hear a beep. Repeat to activate tones again.

PREHEATING FOR AUTOMATIC OVEN OPERATIONS

Cook times programmed for automatic oven operations start counting down when the oven first comes on, not when it has reached the set temperatures. It takes 10 to 15 minutes to reach the set temperature, thus additional cook time may be necessary.

Broiling

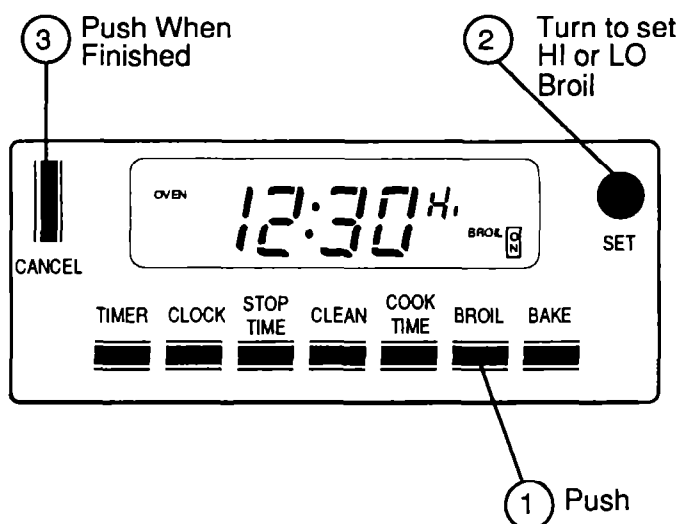

Most foods can be broiled at the HI Broil Setting. Select the LO Broil setting to avoid excessive browning or drying of foods that should be cooked to the well-done stage (such as thick pork chops or poultry).

BROILING TIPS

- **Your oven door should be open to the broil stop position while broiling.** If the door is closed, the food will roast and not broil.
- Use only the broiler pan and grid that came with your range for broiling. They are designed for proper drainage of fat and liquids and help prevent spatter, smoke or fire.
- **Do not preheat when broiling.** For even broiling on both sides, start the food on a cold pan.
- When broiling frozen meat, use one rack position lower than recommended and up to 1 1/2 times the suggested broiling time.
- Trim the outer layer of fat from steaks and chops. Slit the fatty edges to keep the meat from curling.
- For maximum juiciness, salt the first side just before turning the meat. Salt the second side just before serving.
- Brush chicken and fish with butter several times as they broil. When broiling fish, grease the grid to keep it from sticking and broil with skin side down. It is not necessary to turn fish.
- **Never leave a soiled broiler pan in the range.** Grease in the pan may smoke or burn the next time the oven is use.
- **Be sure you know the correct procedure for putting out a grease fire.** See the section on safety.



Do not cover the entire broiler grid with foil. Poor drainage of hot fat may cause a broiler fire.

If a fire starts, close the oven door and turn controls off. If fire continues, throw baking soda on the fire. Do not put water on the fire.

POSITIONING BROILER PAN

Broiling is cooking by direct heat from the broil element. Tender cuts of meat or marinated meat should be selected for broiling. For best results steaks should be at least 3/4" thick.

After placing food on the broiler pan, put the pan on an oven rack in the proper position. The recommended rack position and cooking time can be found in the chart below

The closer the food is to the broil element, the faster the meat browns on the outside, yet stays red to pink in the center. Moving the meat farther away from the element lets the meat cook to the center while browning outside. Side one should be cooked 1 - 2 minutes longer than side two.

Food	Rack Position 4 = Highest 1 = Lowest	Total Time (minutes)
Steak – 1" Thick		
Rare	4	9-11
Medium	3	13-15
Well Done	3	21-23
Ground Beef Patties		
Medium-1" Thick	3	16-18
Medium-1/2" Thick	4	7-9
Lamb Chops – 1" Thick	3	18-21
Pork Chops – 1" Thick	3	27-29
Pork Chops 1/2" Thick	3	16-18
Ham Slice – 1/2" Thick	3	11-12
Fish (Fillets)	3	11-13
Chicken (Pieces)	2	45-55
Frankfurters	3	8-11
Bacon	3	9-11

This chart is a general guide. The size, weight, thickness, and starting temperature of the food as well as your own personal preference will affect the cooking time. Times in the chart are based on the food being at refrigerator temperature.

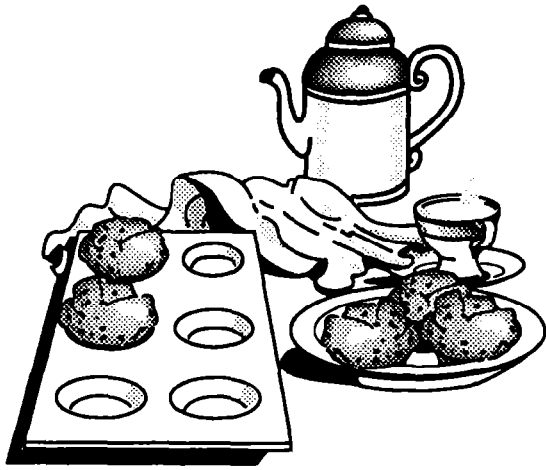

- Let the oven preheat thoroughly before cooking baked products. Allow 10 - 15 minutes preheat time.
- Avoid opening the door too often to check the food during baking as heat will be lost. This may result in poor baking results.
- Cakes, cookies, muffins, and quick breads should be baked in shiny pans — to reflect the heat — because they should have a light golden crust. Yeast breads and pie crusts should be baked in glass or dull (non-shiny) pans — to absorb the heat — because they should have a brown, crisp crust.

Oven Cooking

- Always follow recipe carefully.
- Measure ingredients properly.
- Use proper pan placement.
- Place pans on the oven racks with 1-1/2 - 2" of air space on all sides of each pan. Avoid overcrowding the oven.
- Pans too close to each other, to oven walls or to the oven bottom, block the free movement of air. Improper air movement causes uneven browning and cooking.

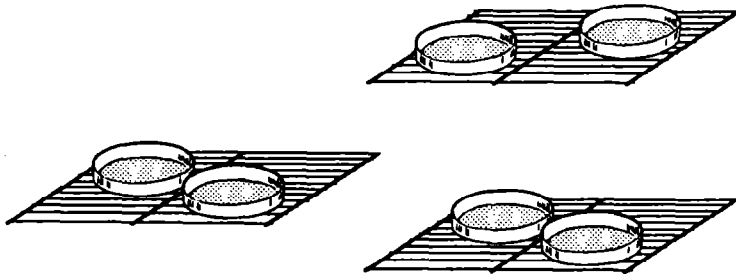
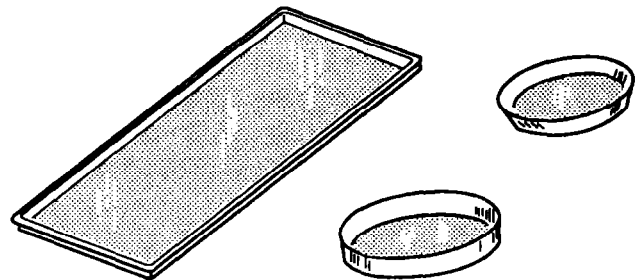

2 cake layers

4 cake layers

- Oven temperatures should be reduced 25 degrees below recommended temperatures if you use dark pans or oven proof glass.
- There may be some odor when the oven is first used. This is caused by the heating of new parts and insulation.
- Do not cover the oven bottom or an entire oven rack with foil. The foil can block normal heat flow, cause cooking failures, and damage the oven interior.

- Most baking should be done on the second shelf position from the bottom. When baking several items, use two shelves placed on the second and fourth rack positions from the bottom of the oven. Stagger pans so that no pan is directly above another. Bake angel food cakes on the first shelf position from the bottom of the oven.

Favorite American Recipes

A Collection from Around the Country

LAZY-DAY COFFEE CAKE

3/4 cup margarine, softened
1 cup sugar
2 eggs
1 cup sour cream
2 cups all-purpose flour
1 teaspoon baking powder
1 teaspoon soda
1/2 teaspoon salt
1 teaspoon nutmeg
3/4 cup light brown sugar
1/2 cup chopped pecans
1 teaspoon cinnamon



Cream margarine and sugar until light and fluffy. Add eggs and sour cream; mix well. Combine flour, baking powder, soda, salt and nutmeg. Add to batter and mix well. Pour batter into greased and floured 13" x 9" x 2" baking pan.

Combine brown sugar, pecans and cinnamon; mix well. Sprinkle one half of this mixture over cake batter; swirl mixture through batter. Sprinkle remaining one half mixture evenly over cake batter.

Cover and chill overnight. Uncover and bake in preheated 350° F oven for 35 to 45 minutes or until cake tests done with toothpick.

BROCCOLI CASSEROLE



2 - 10 oz. pkg. frozen chopped broccoli
1 cup mayonnaise
1 cup sharp cheddar cheese, grated
2 eggs, beaten slightly
1 can cream of mushroom soup
2 tablespoons chopped onion
1 cup cheese cracker crumbs

Preheat oven to 375°F. Cook broccoli according to package directions; drain. Mix with other ingredients. Pour into greased two (2) quart casserole. Sprinkle with cheese cracker crumbs. Bake at 375°F for 20-25 minutes.

SOUTHERN BRUNSWICK STEW

A delicious quick-to-make hearty stew that will feed a crowd or feed the family. Refrigerate or freeze the remainder for another day.

1 - 10 oz. can barbecue beef
1 - 10 oz. can barbecue pork
1 - 24 oz. can Brunswick stew
1 - 5 oz. can boneless chicken
1 - 12 oz. can vacuum packed corn niblets
1 - 16 oz. can baby lima beans, drained
2 - 16 oz. cans stewed tomatoes
1 - 14½ oz. can sliced okra, drained

Drain okra and lima beans. Add to all other ingredients in 4 quart pan. Heat on medium to serving temperature.

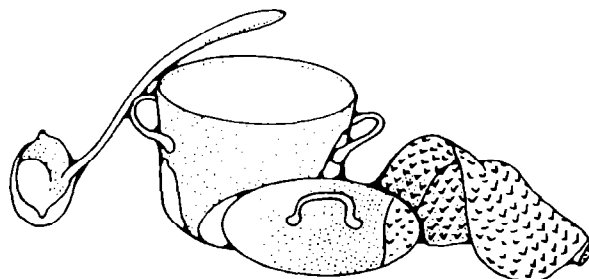

TWO CORN CASSEROLE

1/2 cup margarine
3/4 cup chopped green pepper
1/3 cup chopped onion
3 eggs, well beaten
17 oz. can cream style corn
17 oz. can whole kernel corn with liquid
8 1/2 oz. pkg. corn muffin mix
1 cup cheddar cheese, shredded

Preheat oven to 350°F. Sauté green peppers and onion in margarine; combine with remaining ingredients except cheese. Pour into greased two (2) quart casserole; sprinkle with cheese and bake 45-55 minutes in 350°F oven. Let stand 5 minutes before serving.

Courtesy: Illinois Cooperative Extension Homemakers

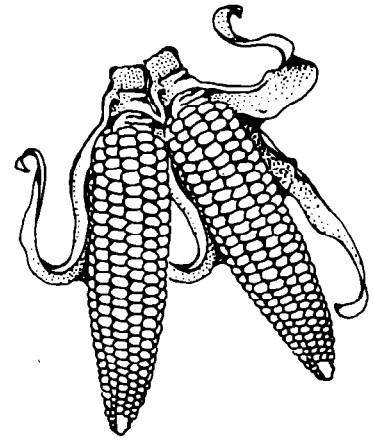

FUDGE PIE

2 - 1 oz. squares semi-sweet chocolate
1 stick margarine
1 cup sugar
1/4 cup flour
2 eggs
1 tsp. vanilla
Dash salt
1/2 cup chopped pecans
Frozen 9" pie shell

Preheat oven to 350°F. Melt chocolate and margarine. Add other ingredients to melted mixture. Pour into unbaked pie shell and bake 35-40 minutes or until pie appears set. Serve warm with ice cream or whipped cream.

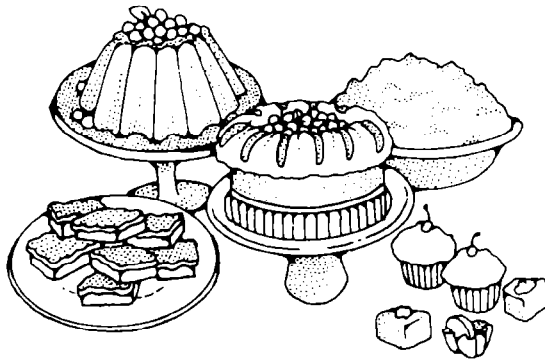

APPLE DESSERT

1 - 20 oz. can apple pie filling
1/2 cup sugar
1 - 9 oz. box white cake mix (1 layer size)
1 stick margarine, melted
1/2 cup chopped pecans

Preheat oven to 350°F. Place in layers in greased 9" or 10" square baking dish: apples, sugar, dry cake mix. Pour melted margarine over top of cake mix. Bake at 350°F for 35 minutes. Sprinkle with pecans. Continue baking 15 minutes. Serve warm.

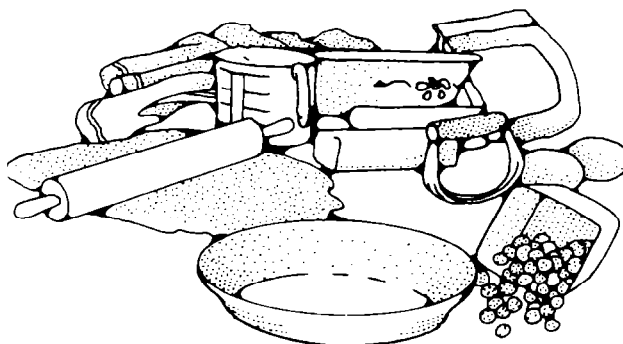
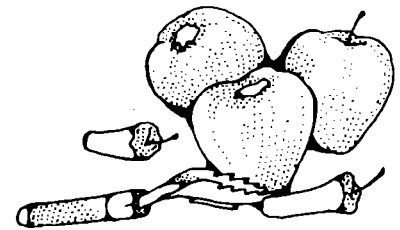

GLORIFIED CORN BREAD

1 cup self-rising corn meal
1/2 cup sour cream
1 cup cream style corn
1/2 cup cooking oil
2 eggs

Preheat oven to 425°F. Place approximately 2 tablespoons cooking oil in 10" oven proof skillet or 8" or 9" square baking pan. Place pan in hot oven until oil is hot. Tilt pan to coat bottom evenly. Mix all ingredients. Pour mixture into hot greased pan. Bake 20-25 minutes or until golden brown.

The Self-Clean Cycle

BEFORE A CLEAN CYCLE

1. Remove the broil pan and grid, oven racks, all utensils and any foil that may be in the oven. Do not try to clean utensils or any other objects in the oven during a self-clean cycle. If oven racks are left in the range during a clean cycle, they will darken, lose their luster and become hard to slide. If you choose to leave the racks in the oven, you can polish the edges of the racks with steel wool and apply a small amount of vegetable oil to the rack edges after the self-clean cycle. This will make the racks easier to slide.
2. Soil on the oven front frame, under the front edge of the cooktop, the door liner outside the door seal and the front edge of the oven cavity (about 1" into the oven) will not be cleaned during a clean cycle (see illustration below). Clean these areas by hand before starting a clean cycle. Use hot water with a soap-filled steel wool pad, then rinse well.

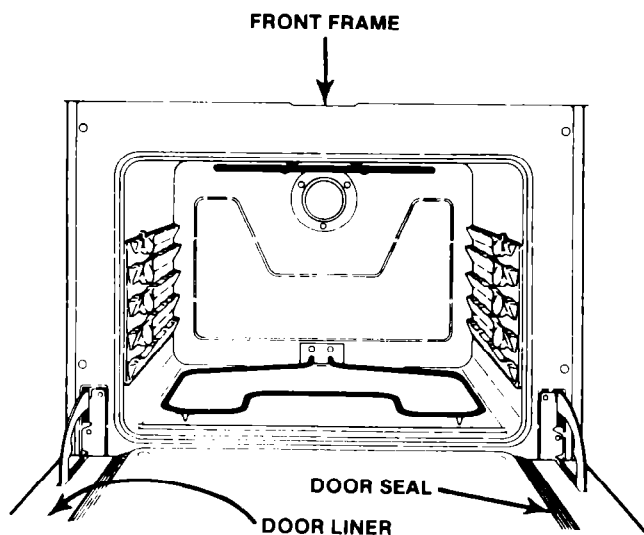

3. Wipe up heavy spillovers on the oven bottom. Too much soil may cause smoking during the clean cycle.

4. Clean the door seal by using a clean sponge to soak the soiled area with hydrogen peroxide. Repeated soaking may be needed depending on the amount of soil. Frequent cleaning will help prevent excessive soil build up. Do not rub the door seal. The fiberglass material of the seal has an extremely low resistance to abrasion. An intact and well fitting oven door seal is essential for energy efficient oven operation and good baking results. If you notice the seal becoming worn, frayed or damaged in any way or if it has become displaced on the door, you should replace the seal.

AFTER A CLEAN CYCLE

After a clean cycle, you may notice some white ash in the oven. Just wipe it up with a damp cloth.

If white spots remain, remove them with a soap-filled steel wool pad. Be sure to rinse thoroughly with a vinegar and water mixture. These deposits are usually a salt residue that cannot be removed by the clean cycle.

If the oven is not clean after one clean cycle, the cycle may be repeated.

PORCELAIN ENAMELED BOWLS (some models)

Some ranges have grey porcelain enameled cooktop element bowls. The bowls can be cleaned in the oven during the self-clean cycle. Place them on the oven racks.

Do not put the chrome trim rings in the oven. Doing so will discolor and warp them.

IMPORTANT SAFETY INFORMATION

Do not use oven cleaner. Listen for fan. A fan noise should be heard sometime during the clean cycle. If not, call the serviceman before self-cleaning again. If the self-cleaning mode malfunctions, turn off and disconnect the power supply. Have serviced by a qualified technician.

TO SET SELF-CLEAN CYCLE (some models)

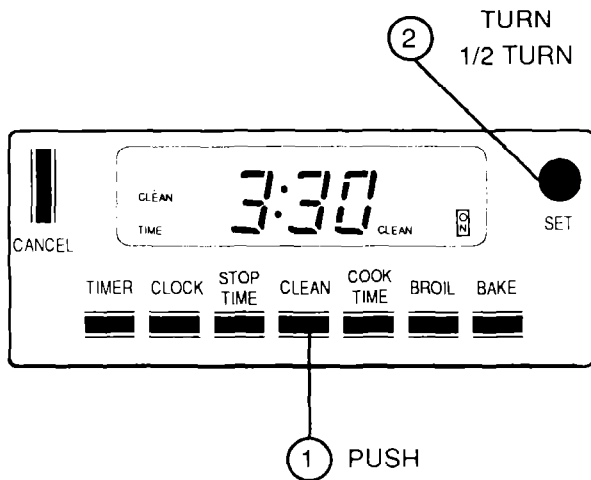

Be sure oven door is closed.

The door locks automatically after the controls are set.

The self-clean cycle lasts 3-1/2 hours.

When the oven reaches locking temperature the word **LOCK** will be shown in the ERC display.

You can push **STOP TIME** BUTTON to find out when the cycle will end. Push **CLEAN** BUTTON to return to count down.

WHEN A CLEAN CYCLE IS FINISHED

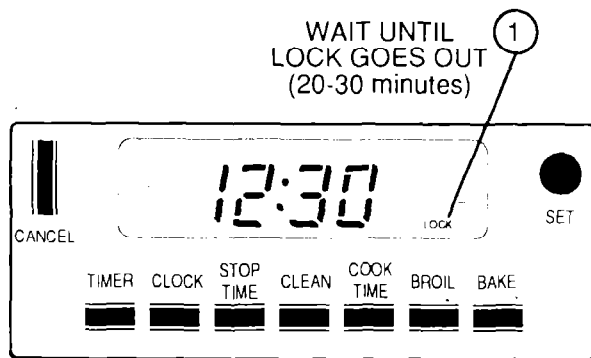

After a clean cycle, the oven door cannot be opened unless the word **LOCK** is off in the ERC display and the oven has cooled. If you cannot open the door immediately after the word **LOCK** goes off, wait about one minute and try again.

TO INTERRUPT A CLEAN CYCLE

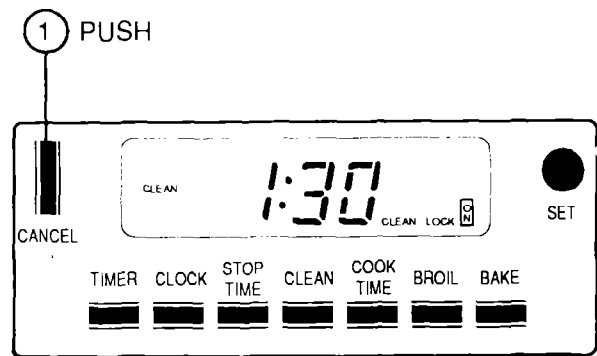

Then follow instructions under **WHEN A CLEAN CYCLE IS FINISHED**.

TO SET DELAY SELF-CLEAN CYCLE

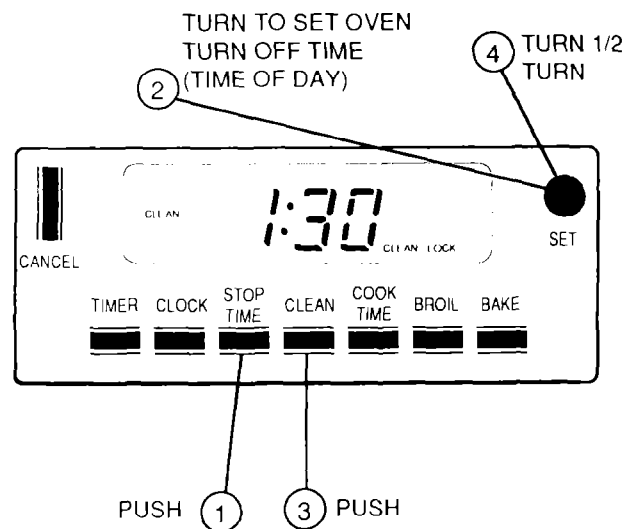

STOP TIME must be more than 3-1/2 hours later than current time of day.

You can press and hold **CLEAN** button to find out when clean cycle will start.

INCOMPLETE SETTINGS

Attention Tone will sound if **CLEAN** button is pushed and **SET** knob is not turned.

Display will show "door" if the oven door is not fully closed. Close the door and the cycle will resume.

Cleaning Tips

On the following pages, all removable parts on your range are shown. Refer to those pages when cleaning your range.

Warm, water, a mild detergent and a soft cloth are safe to use on all cleanable parts of your range. All-purpose cleaners, such as Fantastik®, can also be used.

Do not use metal scouring pads, except where recommended.

Range cooktop finishes will be either porcelain enamel or brushed chrome. Porcelain enamel looks like a painted surface. Brushed chrome has a metallic appearance.

PART	CLEANING MATERIALS	REMARKS
Control panel knobs	Detergent, warm water, soft cloth	Do not use abrasive cleaners. Knobs pull off for easier cleaning.
Porcelain enameled cooktop, chrome reflector bowls	Detergent, warm water, plastic or nylon scouring pad	Clean after each spillover. Rub chrome bowls gently with scouring pad. Soak stubborn soil.
Brushed chrome cooktop (some models)	Detergent, warm water, soft cloth or a chrome cleaner or Cooktop Cleaning Creme	Do not scour chrome tops. Stubborn stains may be removed by using Espree Magwheel Cleaner® or Turtle Wax Polishing Compound®. To remove finger prints on brushed chrome, apply a little baby oil with a paper towel. Rub in the direction of the brush marks. Armor All Protectant® can also be used (after cleaning). Be sure to clean spills of acidic foods quickly. Vinegar spills can permanently stain chrome.
	If cleaning methods described above prove ineffective, baked-on food residue or stains on chrome cooktops can be removed by using pad type oven cleaners. Use extreme caution . Oven cleaners are caustic and will damage painted or aluminum surfaces, such as range sides, backguard or control panels. Do not use spray type oven cleaners. Overspray will damage nearby painted surfaces and heating elements. Use several layers of newspaper and masking tape to cover surfaces such as the backguard, control panel, range sides, countertops, etc. Remove cooktop elements (except solid disk elements), burner bowls, grates, etc. Apply the pad type oven cleaner evenly to the entire top surface. The entire top must be cleaned to keep the finish consistent in color. Use extreme caution to prevent the oven cleaner from coming in contact with any other surface. Let the cleaner remain on the top for 20-30 minutes. Rinse the top well to remove every trace of oven cleaner. Dry the top and apply Armor All Protectant® to protect the finish.	
Glass	Glass cleaner and paper towels	Remove stubborn soil with paste of baking soda and water. Do not use abrasive cleaners. Rinse thoroughly.
Self-cleaning oven finish	Detergent, warm water, scouring pad or soap-filled steel wool pad or oven cleaner	Rinse thoroughly after cleaning. Cleaning inside the oven need only be done as an optional touchup between self-clean cycles. See the self-cleaning oven section of this manual for more information.
Oven door gasket	Hydrogen peroxide	Soak with hydrogen peroxide, using a sponge. Frequent soaking helps prevent soil build-up. Do not rub. See self-cleaning section for more information.
Broil pan and grid	Detergent and water, scouring pad	Do not leave in oven to cool. If you clean immediately, the soil will steam loose while you are eating. Remove pan from oven and empty drippings. Sprinkle pan with detergent. Cover with a wet paper towel and soak. Later, wash in sink or dishwasher.
Porcelain enameled bowls (some models)		Can be cleaned in the oven during the clean cycle. Place them on the oven racks. Do not put the chrome trim rings in the oven.

REMOVABLE KNOBS

All control knobs may be removed for easy cleaning by pulling the knob straight off the stem. Be sure that the knob is in the OFF position before removal.

Hint: Slip a thin cloth (such as a handkerchief) or a piece of string under and around the knob edge and pull up.

Caution: Read these instructions carefully before replacing the knobs. Replacing the knobs improperly will damage the knobs and the spring clip on the stems. If this happens, the knobs will fit loosely.

To replace the knob:

1. The knob stem has a groove in each side. The groove on one side has a spring clip. The other groove is clear (see illustration).
2. Check the inside of the knob and find the molded rib.
3. Replace the knob by fitting the molded rib inside the knob into the clear groove on the stem.

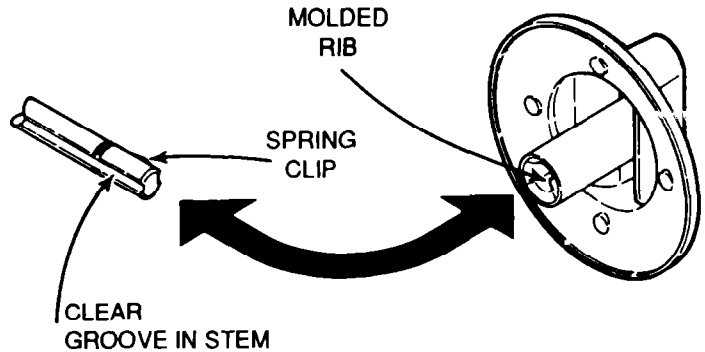

REMOVABLE COOKTOP UNITS

The cooktop elements can be unplugged and the bowls removed for cleaning.

Be sure all cooktop unit control knobs are turned off and elements are cool before you remove or replace a cooktop unit.

To remove:

1. Grasp element, tilt it upward slightly to clear the bowl, then pull away from the receptacle. The element will not sit level when replaced if it is forced too far upward when removed.
2. For models with porcelain enameled reflector bowls, remove the chrome trim ring. See the Self-Cleaning Section about information on cleaning porcelain enameled reflector bowls in self clean cycle.
3. Lift out the bowl.

Do not put the element into water. It cleans itself when heated during normal use.

To replace:

1. Replace the bowl. Be sure the receptacle is showing in the bowl opening.
2. For models with porcelain enameled reflector bowls, replace chrome trim ring.
3. Slide the plug of the element firmly into the receptacle and lower the element into place.

IMPORTANT: Never operate a cooktop element without the bowl in place. This can cause scorching of the cooktop, burning of wiring insulation and loss of energy.

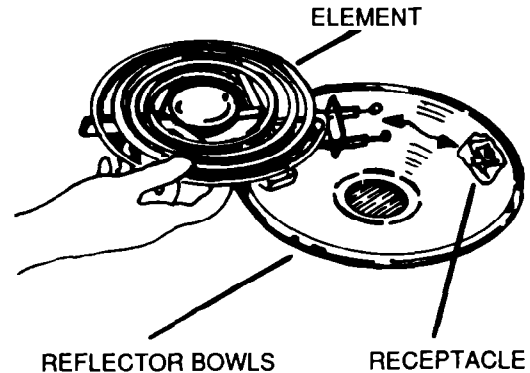

LIFT-UP COOKTOP

The cooktop can be raised so the area underneath can be cleaned.

Raise the front of the cooktop until the support rods snap into position to hold the cooktop.

To lower cooktop, push in on the front of the supports while lowering top.

Porcelain enamel can chip. Handle porcelain enameled cooktops carefully.

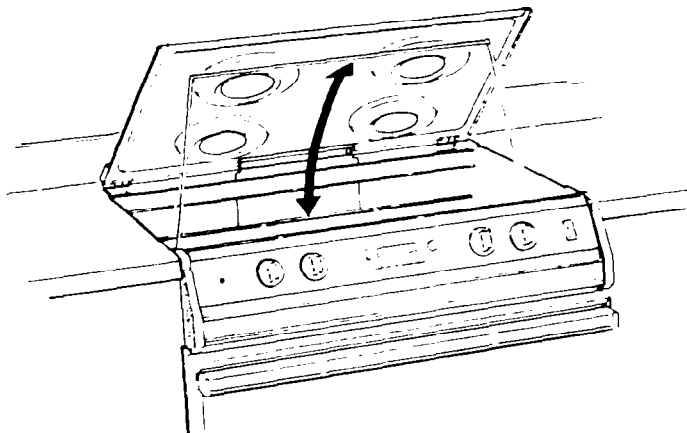

REMOVABLE OVEN RACKS

Be careful not to scratch the oven finish when installing or removing oven racks.

To install:

1. Set the raised back edge of the rack on a pair of rack guides.
2. Push the rack in until you reach the bump in the rack guide, then lift the front of the rack a bit and push the rack all the way in.

To remove:

1. Pull the oven rack out, then up.

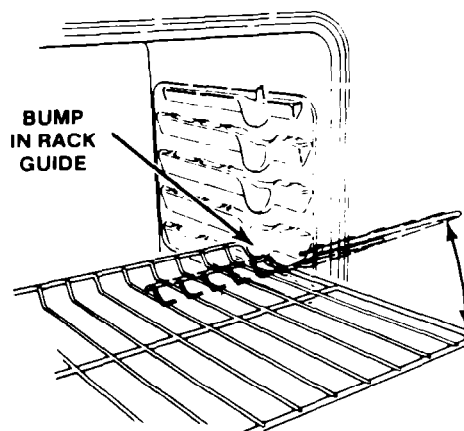

REMOVABLE OVEN DOOR

To remove:

1. Open the door to the broil stop position (see illustration).
2. Grasp the door at each side and lift up and off the hinges.

NOTE: When the door is removed and hinge arms are at stop position, do not bump or try to move the hinge arms. The hinges could snap back causing an injury to the hands or damage to the porcelain on the front of the oven. Cover the hinges with toweling or empty towel rolls while working in the oven area.

To replace:

1. Hold the door over the hinges with the slots at the bottom edge of the door lined up with the hinges. **The hinge arms must still be in the stop position.**
2. Slide the door down onto the hinges as far as it will go and close the door.

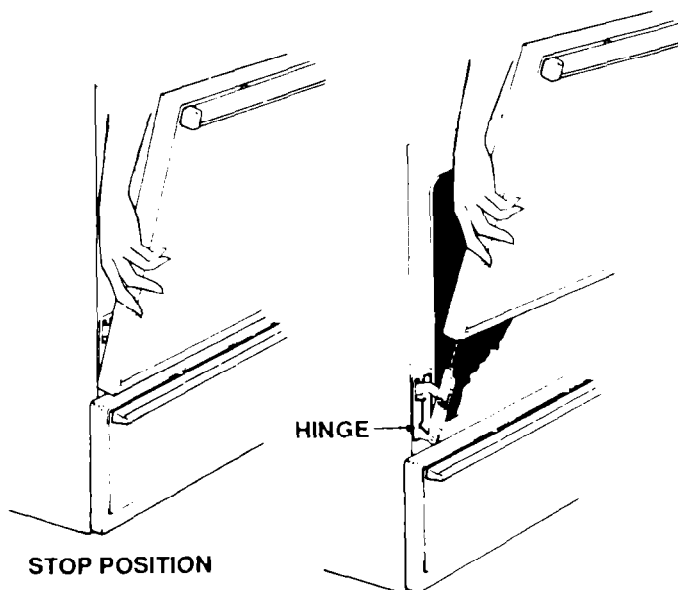

REPLACING THE OVEN LIGHT (self-cleaning models)

Do not touch hot oven bulb. Do not touch oven bulb with wet hands. Do not wipe oven light area with wet cloth. Unplug or disconnect the electrical supply to range before removing.

Never touch the electrically live collar on the bulb when replacing it.

Electrical power must be shut off if you have to replace a broken bulb.

1. Remove the three screws and lift off the glass retainer, glass cover and gasket.
2. Replace the bulb with a 40 watt appliance bulb. An appliance bulb is smaller than a standard 40 watt household bulb.
3. Replace the gasket, glass cover and glass retainer. Tighten screws securely.

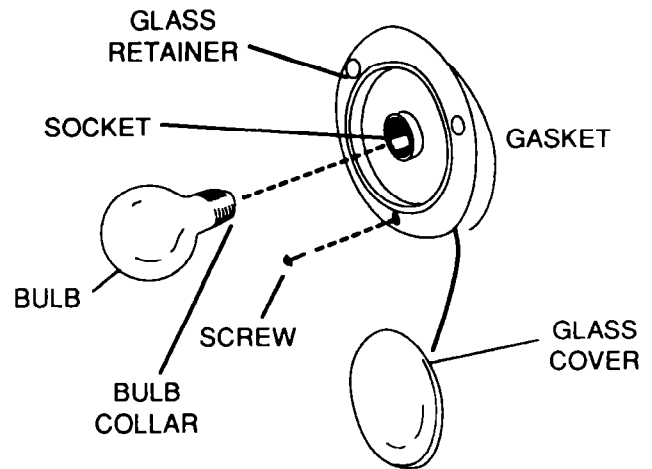

Before Calling for Service

Save time and money — Check this list before you call for service.

To eliminate unnecessary service calls, first, read all the instructions in this manual carefully. Then, if you have a problem, always check this list of common problems and possible solutions before you call for service.

If you do have a problem you cannot fix yourself, call your nearest Store or Service Center for help. When calling, have this manual handy with the model number, serial number and purchase date filled in on the space on the front cover.

PROBLEM	POSSIBLE CAUSE	DON'T CALL FOR SERVICE UNTIL YOU CHECK
<ul style="list-style-type: none"> Range does not work; totally inoperative 	<ul style="list-style-type: none"> No power to range 	<ul style="list-style-type: none"> Check household circuit breaker or fuse. Check cord (if equipped) to be sure it is plugged in.
<ul style="list-style-type: none"> Oven does not heat; cooktop elements OK 	<ul style="list-style-type: none"> Clock set incorrectly (if equipped) Oven controls set incorrectly Door latch in incorrect position (self-clean models with manual door locks only) 	<ul style="list-style-type: none"> Check clock instructions. Check oven control. Check self-clean instructions.
<ul style="list-style-type: none"> Cooktop does not work; oven OK 	<ul style="list-style-type: none"> Element (s) unplugged Improper operation of control 	<ul style="list-style-type: none"> Check element connections by removing and re-plugging element(s) firmly. Be sure knob is pushed in while turning.
<ul style="list-style-type: none"> Foods do not bake properly 	<ul style="list-style-type: none"> Oven not preheated long enough Improper rack or pan placement Oven vent blocked or covered Improper use of foil Improper temperature setting for utensil used Recipe not followed Range and oven rack not level Using improper cookware 	<ul style="list-style-type: none"> Be sure to pre-heat: 10 minutes below 350° 15 minutes above 350° Maintain uniform air space around pans and utensils; see cooking hints section. Reflector bowl must have hole in center over oven vent. Foil use not recommended. Reduce temperature 25° for glass or dull/darkened pans. Is recipe tested and reliable? Check the installation section for leveling instructions. See cooking hints.
<ul style="list-style-type: none"> Oven temperature seems inaccurate 	<ul style="list-style-type: none"> Thermostat calibration 	<ul style="list-style-type: none"> See adjustments described following this section.

Before Calling for Service

PROBLEM	POSSIBLE CAUSE	DON'T CALL FOR SERVICE UNTIL YOU CHECK
<ul style="list-style-type: none"> • Foods do not broil properly 	<ul style="list-style-type: none"> • Improper rack position • Oven preheated • Improper utensil used • Oven door closed during broil 	<ul style="list-style-type: none"> • Check broil pan placement. See broiling section. • Do not preheat when broiling. • Use broiler pan and grid supplied with range. • Open door to broil stop position; see removable oven door section.
<ul style="list-style-type: none"> • Oven smokes 	<ul style="list-style-type: none"> • Improper broiling time • Dirty oven • Broiler pan containing grease left in oven 	<ul style="list-style-type: none"> • Check broiling chart in broiling section. • Check for heavy spillover • Clean pan and grid after each use.
<ul style="list-style-type: none"> • Oven or work light does not work (if equipped) 	<ul style="list-style-type: none"> • Light switch in off position • Light bulb or fluorescent light starter burned out 	<ul style="list-style-type: none"> • Check switch setting; see operating instructions. • Check or replace light bulb; see use and care instructions
<ul style="list-style-type: none"> • Oven does not clean or poor cleaning results (self-clean models only) 	<ul style="list-style-type: none"> • Controls not set properly • Clean cycle interrupted too soon • Oven too dirty 	<ul style="list-style-type: none"> • Check self clean instructions. • Heavily soiled ovens require a 3-1/2 hour clean cycle • Heavy spillovers should be removed before setting clean cycle. Repeat clean cycle.
<ul style="list-style-type: none"> • Oven door will not unlock (self-clean models only) 	<ul style="list-style-type: none"> • Clean cycle not complete 	<ul style="list-style-type: none"> • Oven must cool below lock temperature (approximately 30 minutes after clean cycle is complete).
<ul style="list-style-type: none"> • Tone does not sound 	<ul style="list-style-type: none"> • Tone has been eliminated by pushing and holding CANCEL button 	<ul style="list-style-type: none"> • Push and hold CANCEL button to activate tone.
<ul style="list-style-type: none"> • Heavily soiled or stained chrome cooktop cannot be satisfactorily cleaned. 	<ul style="list-style-type: none"> • Spills were not wiped up promptly 	<ul style="list-style-type: none"> • See the instructions, under Cleaning Tips, for cleaning chrome cooktops with oven cleaner. This procedure requires extreme caution. Read instructions carefully.

**THIS PAGE
INTENTIONALLY LEFT BLANK**

LIMITED WARRANTY

This Roper appliance is warranted by Whirlpool corporation to be free from defect in material and workmanship to the original domestic purchaser. Any parts which we find to be defective will be repaired or replaced at our option subject to the following limitations:

ROPER APPLIANCES

1. Repair or replace during the first thirty (30) days from the date of purchase any finishes (porcelain, enamel or other) and glass parts which we find to be defective.
2. Repair or replace during the first (1st) year from date of purchase any other part except for the finish, which we find to be defective.
3. Repair or replace during the first five (5) years from date of purchase any magnetron (on those units so equipped) which we find to be defective. Labor on any magnetron under warranty is limited to the first (1st) year from date of purchase.
4. During the second (2nd) through fifth (5th) years from the date of original purchase on any product so equipped, any part of the refrigerating system (compressor, evaporator, condenser, drier or connecting tubing) found defective in material or workmanship will be supplied. Labor on the refrigerating system under this warranty is limited to the first (1st) year from the date of original purchase.
5. Replacement parts furnished under the terms of this warranty are warranted only for the unexpired portion of the original warranty period and transportation charges relative to obtaining parts involved is the responsibility of the original consumer purchaser.
6. This warranty applies only to products properly installed, adjusted and operated in accordance with instructions found in the product literature. This warranty does not apply to any product which has been subjected to alteration, misuse, improper installation or delivery damage. Nor does it apply to costs for any service requested for demonstration or to confirm proper operation of appliance.
7. Any repair made under the terms of this warranty must be performed by a servicer authorized by Whirlpool Corporation to service Roper brand appliances.

SHOULD YOU HAVE ANY QUESTIONS CONCERNING THIS WARRANTY, PLEASE CONTACT:

Customer Relations Dept.
ROPER Brand Appliances
2000 M 63 North
Benton Harbor, MI 49022

Call toll Free 1-(800) 44-ROPER
1-(800) 447-6737
Between 8:00 a.m. - 4:30 p.m.
Monday thru Friday, Eastern Time

If you write or call, please furnish complete model and serial number of appliance and date of purchase.

Under no circumstances shall Whirlpool Corporation be liable under this warranty for any loss of any incidental or consequential damages and all IMPLIED WARRANTIES ARE LIMITED TO THE SAME TIME PERIODS STATED HEREIN FOR ROPER EXPRESS WARRANTIES. Some states do not allow the exclusion or limitation of consequential damages or limitations of how long an implied warranty may last, so the above limitations or exclusions may not apply to you. This warranty gives you specific legal rights, and you may have other rights which may vary from state to state.

THIS IS A LIMITED WARRANTY WITHIN THE MEANING OF THAT TERM AS DEFINED IN THE MAGNUSON-MOSS ACT OF 1975.

If you need service for your Roper brand appliance:

- Contact your selling dealer for the authorized servicer in your area.

-OR-

- Phone 1-(800)44-ROPER [1-(800)447-6737] between 8:00-4:30 Eastern Time - Monday thru Friday.

SHT004
342102

Products of Whirlpool Corporation
Benton Harbor, MI 49022

Free Manuals Download Website

<http://myh66.com>

<http://usermanuals.us>

<http://www.somanuals.com>

<http://www.4manuals.cc>

<http://www.manual-lib.com>

<http://www.404manual.com>

<http://www.luxmanual.com>

<http://aubethermostatmanual.com>

Golf course search by state

<http://golfingnear.com>

Email search by domain

<http://emailbydomain.com>

Auto manuals search

<http://auto.somanuals.com>

TV manuals search

<http://tv.somanuals.com>